



# DAEWOO

## DVD-VIDEO PLAYER

Owner's Manual

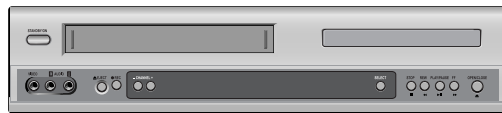
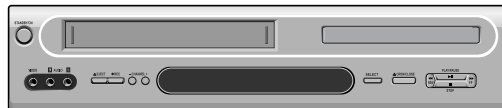

Model : DV6T834N [Hi-Fi]  
DV6T834B [Hi-Fi]  
DV6T844N [Hi-Fi]  
DV6T844B [Hi-Fi]  
DV6T534N [MONO]  
DV6T534B [MONO]  
DV6T544N [MONO]  
DV6T544B [MONO]

- ◆ In the initial settings, exclusive channel for DVD/Video is set to CH 3. Set the TV channel to CH3 before using it.
- ◆ Region code of DVD/Video player for home is 1 or ALL. In inserting a disc with other region code, it does not operate. Please only use a disc with region code 1 or ALL.
- ◆  is a 'Prohibition' mark. If this mark is displayed in operating the product, please wait for a while, then use it. If " Prohibition" mark continues to be displayed in pressing a button after that, it means the button does not function in the currently played disc.
- ◆ Press a product button on the remote control then use the product.
  - DVD operation : [DVD] button
  - Video operation : [VCR] button



P/N : 97P95600N0-78

# Important Safeguards

	<b>CAUTION</b> RISK OF ELECTRIC SHOCK DO NOT OPEN	
<b>CAUTION:</b> TO REDUCE THE RISK OF ELECTRIC SHOCK, DO NOT REMOVE COVER (OR BACK). NO USER-SERVICEABLE PARTS INSIDE. REFER SERVICING TO QUALIFIED SERVICE PERSONNEL.		



The lightning flash with arrowhead symbol, within an equilateral triangle, is intended to alert the user to the presence of uninsulated "dangerous voltage" within the product's enclosure that may be of sufficient magnitude to constitute a risk of electric shock.



The exclamation point within an equilateral triangle is intended to alert the user to the presence of important operating and servicing instructions in the literature accompanying the appliance.

**WARNING :** TO REDUCE THE RISK OF FIRE OR ELECTRIC SHOCK, DO NOT EXPOSE THIS APPLIANCE TO RAIN OR MOISTURE.

**CAUTION :** TO PREVENT ELECTRIC SHOCK, MATCH WIDE BLADE OF PLUG TO WIDE SLOT, FULLY INSERT.

## IMPORTANT FOR LASER PRODUCTS

- **LASER :** This Digital Video Disc Player employs a Laser System. To ensure proper use of this product please read this owner's manual carefully and retain for future reference. Should the unit require maintenance, contact an authorized service location - see service procedure.  
Use of control adjustments or the performance of procedures other than those specified may result in hazardous radiation exposure.  
To prevent direct exposure to the laser beam, do not try to open the enclosure. Visible laser radiation when open and interlocks defeated.  
**DO NOT STARE INTO THE BEAM.**
- **DANGER :** Visible laser radiation when open and interlock failed or defeated. Avoid direct exposure to beam.
- **CAUTION :** Do not open the top cover. There are no user serviceable parts inside the Unit; leave all servicing to qualified service personnel.

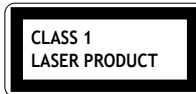

**FCC NOTICE:** This equipment has been tested and found to comply with the limits for a Class B digital device, pursuant to part 15 of the FCC Rule. These limits are designed to provide reasonable protection against harmful interference in a residential installation. This equipment generates, uses and can radiate radio frequency energy and if not installed and used in accordance with the instructions, may cause harmful interference to radio communications. However, there is no guarantee that interference will not occur in a particular installation. If this equipment does cause harmful interference to radio or television reception; which can be determined by turning the equipment off and on, the user is encouraged to try to correct the interference by one or more of the following measures:

- Reorient or relocate the receiving antenna.
- Increase the separation between the equipment and receiver.
- Connect the equipment to an outlet on a circuit different from that to which the receiver is connected.
- Consult the dealer or an experience radio/TV technical for help.

This device complies with part 15 of the FCC Rules. Operation is subject to the following two conditions: (1) This device may not cause harmful interference, and (2) This device must accept any interference received, including interference that may cause undesired operation.

**CAUTION:** Any changes or modification in construction of this device which are not expressly approved by the party responsible for compliance could void the user's authority to operate the equipment.

## Important Safeguards

## Important Safeguards

This set has been designed and manufactured to assure personal safety. Improper use can result in electric shock or fire hazard. The safeguards incorporated in this unit will protect you if you observe the following procedures for installation, use and servicing. This unit is fully transistorized and does not contain any parts that can be repaired by the user.

### 1 Read Instructions

All the safety and operating instructions should be read before the unit is operated.

### 2 Retain Instructions

The safety and operating instructions should be retained for future reference.

### 3 Heed Warnings

All warnings on the unit and in the operating instructions should be adhered to.

### 4 FOLLOW INSTRUCTIONS

All operating and use instructions should be followed.

### 5 Cleaning

Unplug this unit from the wall outlet before cleaning. Do not use liquid cleaners or aerosol cleaners. Use a damp cloth for cleaning.

### 6 Attachments

Do not use attachments unless recommended by the unit's manufacturer as they may cause hazards.

### 7 Water and Moisture

Do not use this unit near water- for example, near a bath tub, wash bowl, kitchen sink or laundry tub, in a wet basement, or near a swimming pool and the like. Caution : Maintain electrical safety. Powerline operated equipment or accessories connected to this unit should bear the UL listing mark or CSA certification mark on the accessory itself and should not be modified so as to defeat the safety features. This will help avoid any potential hazard from electrical shock or fire. If in doubt, contact qualified service personnel.

### 8 Accessories

Do not place this unit on an unstable cart, stand, tripod, bracket, or table. The unit may fall, causing serious injury to a child or adult as well as serious damage to the unit. Use this unit only with a cart, stand, tripod, bracket, or table recommended by the manufacturer.

8A A unit and cart combination should be moved with care. Quick stops, excessive force, and uneven surfaces may cause the unit and cart combination to overturn.

PORTABLE CART WARNING  
(symbol provided by RETAC)



### 9 Ventilation

Slots and openings in the case are provided for ventilation to ensure reliable operation of the unit and to protect it from overheating. These openings must not be blocked or covered. These openings must not be blocked by placing the unit on a bed, sofa, rug, or other similar surface. This unit should never be placed near or over a radiator or heat radiator. This unit should not be placed in a built-in installation such as a bookcase or rack unless proper ventilation is provided or the manufacturer's instructions have been adhered to.

### 10 Power Sources

This unit should be operated only from the type of power source indicated on the marking label. If you are not sure of the type of power supply to your home, consult your dealer or local power company. For units intended to operate from battery power, or other sources, refer to the operating instructions.

### 11 grounding or Polarization

This unit is equipped with a polarized alternating-current line plug (a plug having one blade wider than the other). This plug will fit into the power outlet only one way. This is a safety feature. If you are unable to insert the plug fully into the outlet, try reversing the plug. If the plug still fails to fit, contact your electrician to replace your obsolete outlet. To prevent electric shock, do not use this polarized plug with an extension cord, receptacle, or other outlet unless the blades can be fully inserted without blade exposure. If you need an extension cord, use a polarized cord.

### 12 Power-Cord Protection

Power-supply cords should be routed so that they are not likely to be walked on or pinched by items placed upon or against them, paying particular attention to cords at plugs, convenience receptacles, and the point where they exit from the unit.

#### Note to CATV system installer

This reminder is provided to call the CATV system installer's attention to Section 820-40 of the NEC which provides guidelines for proper grounding and, in particular, specifies that the cable ground shall be connected to the grounding system of the building, as close to the point of cable entry as practical.

### 13 Outdoor Antenna Grounding

If an outside antenna or cable system is connected to the product, be sure the antenna or cable system is grounded so as to provide some protection against voltage surges and built-up static charges. Section 810 of the National Electrical Code, ANSI/NFPA No. 70-1984 (Section 54 of Canadian Electrical Code, Part 1) provides

information with respect to proper grounding of the mast and supporting structure, grounding of the lead-in wire to an antenna-discharge unit, connection to grounding electrodes, and requirements for the grounding electrode. See example as shown.

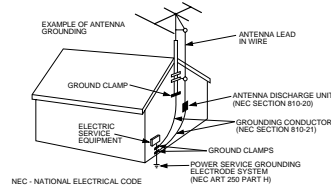

### 14 Power Lines

An outside antenna system should not be located in the vicinity of overhead power lines, other electric light or power circuits, or where it can fall into such power lines or circuits. When installing an outside antenna system, extreme care should be taken to keep from touching or approaching such power lines or circuits as contact with them might be fatal. Installing an outdoor antenna can be hazardous and should be left to a professional antenna installer.

### 15 Lightning

For added protection for this unit during a lightning storm, or when it is left unattended and unused for long periods of time, unplug it from the wall outlet and disconnect the antenna or cable system. This will prevent damage to the unit due to lightning and power line surges.

### 16 DISC TRAY

Keep your fingers well clear of the disc as it is closing. It may cause serious personal injury.

### 17 Overloading

Do not overload wall outlets of extension cords as this can result in a risk of fire or electric shock.

### 18 Object and Liquid Entry

Never push objects of any kind into this unit through openings as they may touch dangerous voltage points or "short-out" parts that could result in a fire or electric shock. Never spill liquid of any kind on the unit.

### 19 BURDEN

Do not place a heavy object on or step on the product. The object may fall, causing serious personal injury and serious damage to the product.

### 20 DISC

Do not use a cracked, deformed or repaired disc. These discs are easily broken and may cause serious personal injury and product malfunction.

### 21 Servicing

Do not attempt to service this unit yourself as opening or removing covers may expose you to dangerous voltage or other hazards. Refer all servicing to qualified service personnel.

### 22 Damage Requiring Service

Unplug this unit from the wall outlet and refer servicing to qualified service personnel under the following conditions.

- A. When the power-supply cord or plug is damaged.
- B. If liquid has been spilled, or objects have fallen into the unit.
- C. If the unit has been exposed to rain or water.
- D. If the unit does not operate normally by following the operating instructions. Adjust only those controls that are covered by the operating instructions. Improper adjustment of other controls may result in damage and will often require extensive work by a qualified technician to restore the unit to its normal operation.
- E. If the unit has been dropped or the cabinet has been damaged.
- F. When the unit exhibits a distinct change in performance-this indicates a need for service.

### 23 Replacement Parts

When replacement parts are required, have the service technician verify that the replacements he uses have the same safety characteristics as the original parts. Use of replacements specified by the unit manufacturer can prevent fire, electric shock, or other hazards.

### 24 Safety Check

Upon completion of any service or repairs to this unit, ask the service technician to perform safety checks recommended by the manufacturer to determine that the unit is in safe operating condition.

### 25 Wall or Ceiling Mounting

The product should be mounted to a wall or ceiling only as recommended by the manufacturer.

### 26 Heat

The product should be situated away from heat sources such as radiators, heat registers, stoves, or other products (including amplifiers) that produce heat.

# Advantages of This Product Are .....

- DVD, VCD, CD, CD-R(MP3), CD-RW, VHS playback function
- Watching DVD for recording broadcast
- Integrated remote control (VCR, DVD)
- VISS function
- Multiplex sound playback/record
- High Sound Quality of 6 head Hi-Fi (Hi-Fi Model only)
- One Touch timer Recording (OTR)
- MP3 file playback function (CD-R disc having records of MP3 files)
- GUI (Graphical User Interface) OSD (On Screen Display)  
By using the [DISPLAY] button on the remote control, information on the DVD/VCD/CD player and disc, can be displayed on the TV screen.
- Screensaver function (DVD)
- 3D sound (3D sound effect using 2 speakers)
- High bit / high sampling with 27MHz / 10bit video encoder  
This unit has 27MHz / 10bit capability, that enables the faithful reproduction of fine images.
- High bit / high sampling with 96KHz / 24bit audio D/A converter  
With this 96KHz / 24bit linear Pulse Code Modulated signals, which constitute the highest specifications in the DVD standards, you can enjoy faithfully reproduced sound in all of its various modes. To support 96KHz sampling / 24bit sound, the shaping noise of this multi-level digital sigma type of D/A converter is kept flat up to 44KHz, thus preventing the important audio signals from being affected.
- Coaxial digital output (PCM, Dolby Digital, dts)  
You can enjoy high-level digital audio by connecting with amp embedded with Dolby Digital / dts decoder.
- Built-in Dolby Digital decoder (DVD)
- Analog audio 2-channels output for DOWNMIX (x1)
- Composite video out (x1)
- Slow Forward / Reverse (DVD) playback
- Fast Forward / Reverse playback
- Search of title, chapter, and time in DVD disc,

- and search of track and time in VCD and CD
- Various TV aspect (DVD)  
4:3 for Pan and Scan, 4:3 for Letter Box, and 16:9 for Wide
- Repeat playback (title and chapter for DVD, track and disc for VCD/CD)
- Repeat a defined period from A to B (DVD)
- Selective Play (DVD/VCD/CD)  
You can select and play the desired title / chapter of DVD and track of Video CD/CD in STOP mode.
- Various languages OSD (On Screen Display) function (DVD)  
You can select and display OSD among various languages. (English, French, Spanish)
- Parental Lock function (DVD)  
This function can prevent playback of software that may be unsuitable for children.
- Multi Audio function (DVD)  
The audio soundtrack can be heard in up to 8 languages. In the case of SVCD or CVD, it depends on the disc. (The number of audio languages depends on the software.)
- Multi Subtitle function (DVD)  
The subtitle can be seen in up to 32 languages. In the case of SVCD or CVD, it depends on the disc. (The number of subtitle languages depends on the software.)
- Multi Angle function (DVD)  
This function allows you to choose the viewing angle of scenes which were shot from a number of different angles. (The number of angles depends on the software.)
- Screen zoom function (DVD/VCD)

# Read Carefully before Using

Cautions in use of DVD-Video player are described below. Please read carefully before using a DVD-Video player.

## Installation place and handling \_\_\_\_\_

- When you place this player near other devices, they may affect poorly together.
- When you place DVD-Video player and TV in the upper and lower sides, it may cause flickering of pictures or failure (tape is not ejected).
- When you place this player near strong magnetic materials, it may affect image or voice poorly or damage recording.
- Do not spill volatile liquids like insect spray over the player. Do not leave rubber or plastic products in contact with the player for a long time. They will cause deterioration or paint peel-off.

## Not in use \_\_\_\_\_

- When the unit is not in use, be sure to remove the disc or tape and turn off the power.
- If you do not use the unit for a long period, remove batteries in remote control to prevent leakage.
- In case you don't use the unit for a long time, the unit may not function properly in the future. Turn on and use the player occasionally.

## Moving \_\_\_\_\_

- Repack the unit as it was originally packed at the factory. Alternatively, pack this product with towel not to be damaged.
- Eject any videotape.

## Cleaning \_\_\_\_\_

- Dust off dirt in cabinet or control panel part smoothly with a soft cloth.
- For heavy dirt, soak the cloth in a weak detergent solution, wring it well and wipe. Use a dry cloth to wipe it out.
- Follow instructions in using chemical cleaners.
- Do not use any type of solvent such as gasoline or benzene, as they may cause deterioration or paint peel-off.

## Checking \_\_\_\_\_

- Video is a high precision device. To obtain a clear screen, we recommend regular inspection and maintenance every 1,000 hours of use by technical engineers.
- For checking, contact your dealer or your nearest service center.

## Checking and Replacement of Antenna \_\_\_\_\_

- Antenna is subject to change in its direction or damage by wind and rain. For clean screen, contact and consult your nearest service center about checking and replacement.

## In recording important screen \_\_\_\_\_

- Be sure to record the screen and check whether recording is performed properly. We beg you to understand compensation of recording if recording is not performed by badness of used tape or video.

## Copyright \_\_\_\_\_

- Do not use your recordings without permission of a copyrighter except personal usage.

## Tape and Disc Handling \_\_\_\_\_

- Do not use any tape and disc below. Damage of video head or cut/coiling of tape may cause failure.
  - Tape with mold
  - Tape or disc stained with juice or attachments
  - Tape having breakage connection
  - Disassembled tape
  - Disc with severe scratch
- Moisture condensation may occur in tape. Moisture condensation damages the tape. Please use the tape after the moisture condensation is disappeared.
- After use, store tape vertically in a case to prevent loose.
- Do not store the following places.
  - High temperature and humidity
  - Subject generation of mold
  - Subject to direct sunlight
  - Much dirt or dust
  - Near strong magnetic materials such as speaker

## ◆ Instructions in using remote control

- Operate remote control within 7m from the unit.
- Do not press 2(two) buttons at the same time.
- Do not light up sending part of remote control.
- Do not keep in the place with much dust and humidity.

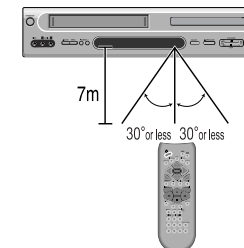

# Contents

## Product Information

Important Safeguards .....	1
Advantages of This Product Are .....	4
Read Carefully before Using .....	5
Contents .....	6
Identification of Controls .....	7
Remote Control .....	10

## Installation

Connecting with TV .....	11
Connecting with Cable Box .....	12
Connecting with Other Video Equipment .....	13
Connecting with an Analog Audio .....	14
Connecting with a Dolby Digital decoder or DTS decoder .....	15

## Basic Operation

Output Select .....	16
Clock Set .....	17
DVD Playback .....	18
VCR Playback .....	19

## VCR Operation

Memorizing TV Channels .....	20
Recording .....	22
Timer Recordings .....	24
Watching and Recording Cable TV .....	27
Using advanced features .....	28
Hi-Fi Stereo Playback ( <i>Hi-Fi Model only</i> ) .....	31

## DVD Operation

Playing a desired scene.....	32
Confirming the current PLAY mode on screen ..	35
AUDIO language, SUBTITLE language and 3D AUDIO .....	36
ZOOM, Multi Angle and Digest play.....	37
About MP3 discs .....	38
Displaying menus in a disc.....	39

## Setup

LANGUAGE Setup .....	39
VIDEO Setup .....	40
AUDIO Setup .....	40
Others Setup .....	41

## The others

About DVD .....	42
Basic information about VCR and Videotape....	44
Before doubting about troubles (DVD) .....	45
Before doubting about troubles (VCR).....	46
Specifications .....	48
Warranty .....	

# Identification of Controls

## Front panel

✓ DV6T834N, DV6T834B, DV6T534N, DV6T534B

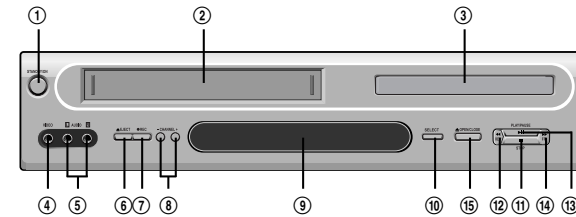

✓ DV6T844N, DV6T844B, DV6T544N, DV6T544B

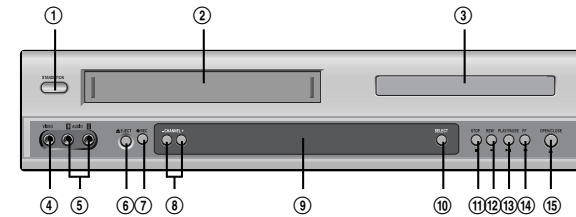

### ① Power (STANDBY/ON) button

Use to power the device on/off if AC power supply is connected.

### ② Place to insert videotape

### ③ Disc tray

### ④ Video input jack

### ⑤ Audio input jack

### ⑥ Eject button

### ⑦ Record button

### ⑧ Channel Up/Down button

### ⑨ Operation Display Window

Display operation of device. For more information, see "Operation Display Window" in the next page.

### ⑩ Select button

Use to change DVD mode to VCR mode, and vice versa.

### ⑪ Stop button

Use to stop playing.

### ⑫ Rewind button

Use to rewind currently being played videotape or disc; or to playback back rapidly.

### ⑬ Playback/PAUSE button

Playback videotape or disc. Press this button to pause a screen.

### ⑭ Fast Forward button

Use to wind currently being played videotape or disc; or to playback rapidly.

### ⑮ Open/Close Tray button

## Operation Display Window



- VCR** VCR Operation
- REC** REC and TIMER REC display
  - REC** Recording, **TIMER REC** TIMER Recording,
  - T** To be Timer-recorded,
  - C** To be Timer-recorded state ERROR (No Tape or Tape without tab)
- AM** AM
- dts** dts Disc Indicator
- T** Track
- C** Chapter This is displayed in DVD disc.
- Time, Counter and Current Operation**
  - OPEN** Tray is opened
  - CLOSE** Tray is closed
  - LOAD** Disc is loaded
  - NODISC** There is no disc in tray
  - ERRDISC** Disc has some error
  - MENU** Menu screen is displayed
  - SETUP** Setup menu is displayed
  - ON** Power is ON
  - OFF** Power is OFF
- 3D** 3D Sound Indicator
- DVD** DVD Disc Operation

## Rear Panel

✓ DV6T834N, DV6T834B, DV6T844N, DV6T844B [Hi-Fi]

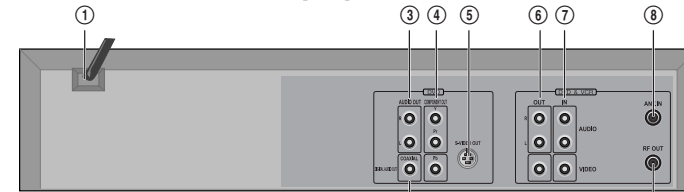

✓ DV6T534N, DV6T544N, DV6T534B, DV6T544B [MONO]

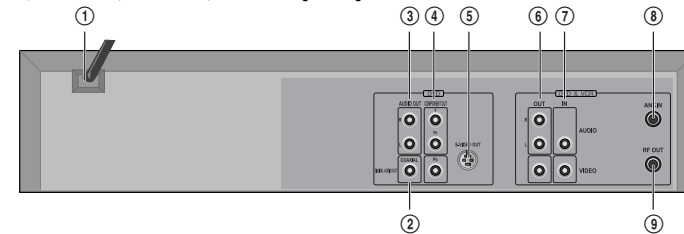

- 1 Power Cord**  
It is a jack for supplying power to the unit. Connect to outlet in a wall.
- 2 Digital Output (COAXIAL) Jack**  
To enjoy sound quality of theater level in home, connect this jack with amp or unit embedded with digital audio decoder.
- 3 AUDIO Out Jack**
- 4 COMPONENT Out Jack**  
To obtain better screen quality, connect the unit to TV or monitor with COMPONENT(480i) input.
- 5 S-Video Output Jack**
- 6 A/V Output Jack**
- 7 A/V Input Jack**
- 8 Connection to Antenna Cable**
- 9 Connection to TV**

## Accessories

<p>Remote Control</p>	<p>2 Batteries</p>	<p>RF cable</p>	<p>Connecting cable to Audio/Video jack</p>	<p>Owner's Manual/Warranty</p>
-----------------------	--------------------	-----------------	---	--------------------------------

• To purchase accessories or not supplied parts additionally, contact your nearest dealer or service center. But, owner's manual and warranty are not sold additionally.

# Remote Control

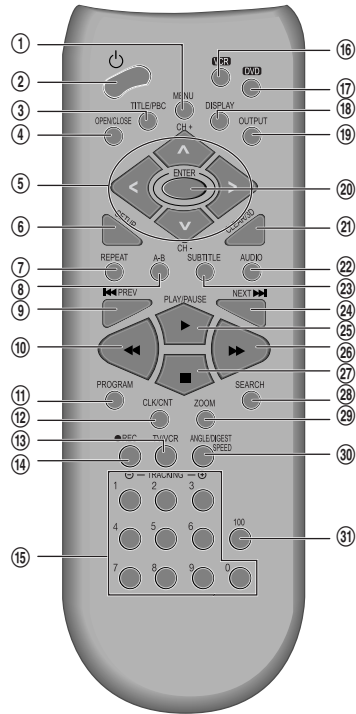

- ① [DVD] MENU button
- ② POWER button
- ③ [DVD] TITLE /PBC button
- ④ [DVD] OPEN/CLOSE button, [VCR] EJECT button
- ⑤ [DVD, VCR] MOVE/SELECT in OSD, [VCR] Channel Up/Down button
- ⑥ SETUP button
- ⑦ [DVD] REPEAT Playback button
- ⑧ [DVD] REPEAT a defined period from A to B button
- ⑨ [DVD] PREVIOUS button (move into a previous chapter or track)
- ⑩ REVERSE SEARCH button
- ⑪ [VCR] TIMER RECORDING button, [DVD] PROGRAM button
- ⑫ [DVD, VCR] CLOCK/COUNTER button
- ⑬ [DVD, VCR] TV/VCR button
- ⑭ [VCR] Record button
- ⑮ [DVD, VCR] NUMBER button, [VCR] TRACKING -/+ button
- ⑯ VCR SELECT button
- ⑰ DVD SELECT button
- ⑱ [DVD, VCR] OSD DISPLAY button
- ⑲ OUTPUT Selection button
- ⑳ ENTER button
- ㉑ CLEAR/3D button
- ㉒ [DVD] AUDIO LANGUAGE Select, [VCR] AUDIO Select button
- ㉓ [DVD] SUBTITLE Select button
- ㉔ [DVD] NEXT button (Move into a next chapter or track), [VCR] Frame Advance button in pause mode
- ㉕ PLAY/PAUSE button
- ㉖ FORWARD SEARCH button
- ㉗ STOP button
- ㉘ [DVD] Chapter/Title/Time SEARCH button
- ㉙ [DVD] ZOOM button
- ㉚ [DVD] ANGLE, [VCD] DIGEST, [VCR] Record SPEED button
- ㉛ [VCR] 100 button

## Child Lock!!!

Press the power [⏻] button of the remote control for about 8 seconds. No buttons of front panel and remote control can be operated now and Lock indicator ("L O C K") will be displayed on window display. To release child lock, press the power [⏻] button of the remote control for about 8 seconds.

# Connecting with TV

- In the initial SET, exclusive channel for video is set to CH 3. To change this setting, set again in "CHANNEL SET" screen in VCR operation.
- In connecting RF cable to TV, set TV channel to CH3.

## Various methods in connecting with TV

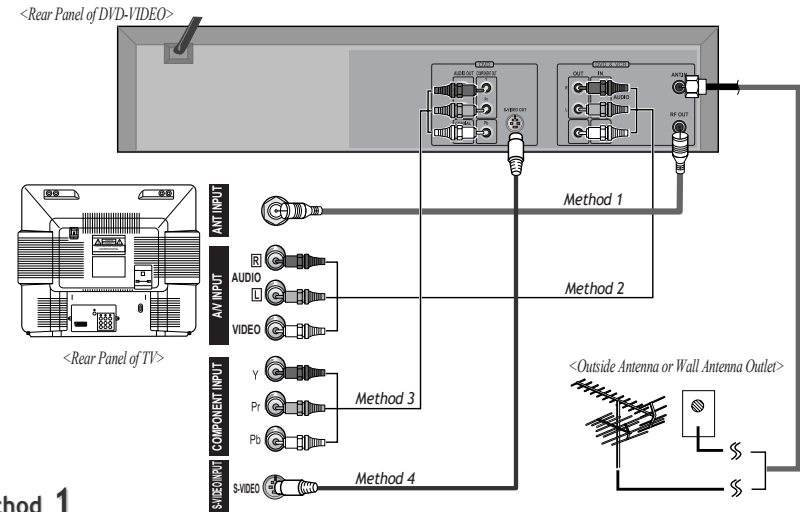

### Method 1

Remove circular cable (RF cable) (surplus cable) plugged in "ANT.IN" Jack in rear panel of TV. Connect the cable to "ANT.IN" jack in rear panel of DVD-Video. Connect TV to DVD-Video. Connect "RF OUT" jack in DVD-Video with "ANT.IN" jack in TV with RF cable.

### Method 2 : Connecting to a TV that has a audio/video in jacks

Connect VIDEO OUT jack in DVD-Video to VIDEO IN jack in TV, and AUDIO OUT jack in DVD-Video to AUDIO IN jack in TV with connecting cable of Audio/Video jack. Select VCR mode by pressing TV/INPUT button in TV, you can view more clear screen and sound than connection with RF cable only.

### Method 3 : Connecting to a TV that has a component video in jacks

Use a component video cable (commercially available) in place of the yellow video cable to enjoy higher quality pictures. The component video connection only supplies video (picture) in the DVD mode of the DVD-Video. Therefore, in order to use the VCR features or view TV channels at the DVD-Video, you still need to either connect the RF coaxial cable between the ANT-OUT jack of the DVD-Video and the TV's Antenna In jack, or connect the video cable.

### Method 4 : Connecting to a TV that has a S-Video in jacks

Use a S-Video cable (not supplied) to enjoy higher quality pictures.



- VHF: 2 -13 channels of TV, UHF: 14-69 channels of TV, CATV: Broadcasting is transmitted with cable from broadcasting station by contract with the station and consumers. It does not need any antenna.
- In/Out jack in Audio/Video terminal: - In: A jack used to receive signal required in this unit from other units. - Out: A jack used to send signal of this unit to other units.
- Connect with Audio/Video terminal, you can enjoy more clear video and audio. (Use OUTPUT button in this remote control to select video mode.)
- If screen is broken in connecting COMPONENT Out to Pr, Pb, Y of TV COMPONENT In jack, connect to Cr, Cb, Y.



# Connecting with Cable Box

- You should install a distributor additionally.

## How to connect

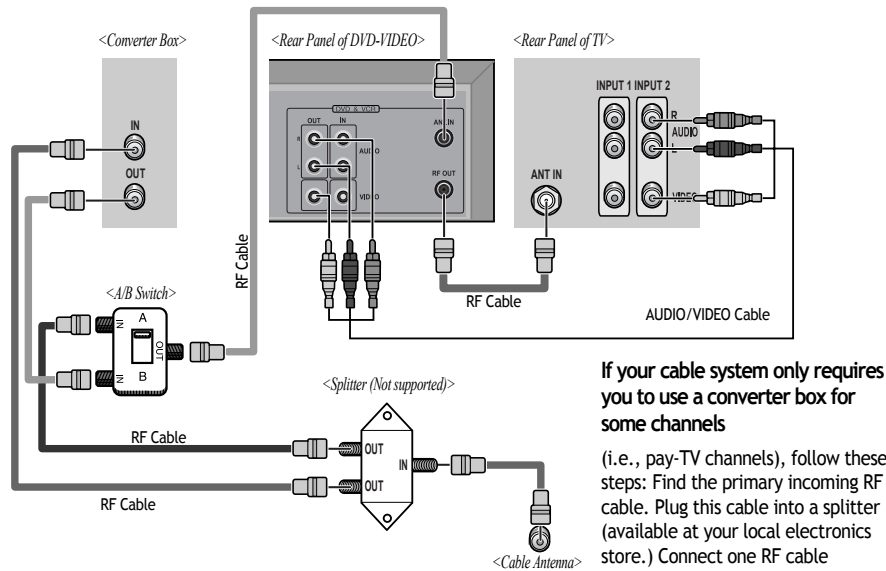

splitter and the IN terminal on the converter box.

Connect another RF cable between the other OUT terminal on the splitter and the A-IN terminal on an A/B switch (available at your local electronics store.) Connect a third RF cable between the OUT terminal on the converter box and the B-IN terminal on the A/B switch.

Connect a RF cable between the OUT terminal on the A/B switch and the ANT. IN on your DVD-VIDEO.

When the A/B switch is in the B position, use the converter box to change channels; when the A/B switch is in the A position, use the DVD-VIDEO to change channels.

## How to watch general broadcasting with recording CATV

- Set Channel Select switch of Converter Box to CH 3 or 4 as same as video exclusive channel. Press [SET] button in [VCR] operation to set video exclusive channel in "CHANNEL SET" screen.
- Press channel button of Converter Box to select channel to be recorded. In this case, if you want to watch CATV to be recorded, press [TV/INPUT] button of TV to select "Out (VCR)".
- Press [REC] button in DVD-Video.
- To watch general broadcasting, press channel button in TV to select the desired channel.

- For some types of TV, you should press [TV/INPUT] button in TV remote control and convert from Out 1 (VCR 1) or Out 2 (VCR 2) mode to Broadcasting Channel mode to change TV channel.
- Change channel selection of CATV receiver in recording, contents of recording is changed.

# Connecting with Other Video Equipment

- You can connect a wide variety of audio/video equipment to your DVD-Video, including : an additional VCR, Laser Disc Player, DVD Player, Camcorder, Satellite Receiver, Video Game. Since all of these devices use essentially the same connections, they will be described together.

## How to Connect

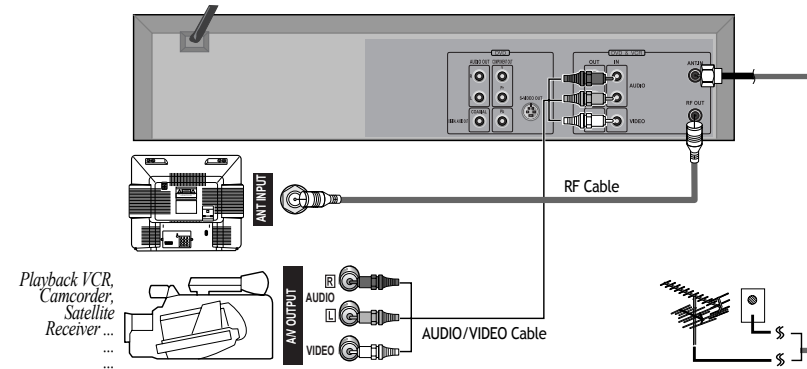

- Connect Audio/Video Out jack in other video equipment to Audio/Video In jack in rear panel (or front panel) of DVD-Video with connecting cable.
- Connect "ANT. IN" jack in TV to "RF. OUT" jack in DVD-Video with RF cable.
- To record contents of other video equipment with DVD-Video, insert recording tape attached recording box in DVD-Video.

## How to Copy/Edit) Tape with Other Video Equipment

- Turn on DVD-Video.
  - Press [OUTPUT] button of remote control and adjust DVD-Video to display "External Input 1" or "External Input 2" in TV screen.
  - Press [PLAY] button in other video equipment.
  - Press [REC] button in DVD-Video if you want to record contents of other video equipment.
  - Press [Pause] button in DVD-Video when unnecessary or undesired scene is displayed in recording.
- (Caution) Recording is released automatically after 5 minutes since pressing [PAUSE] button. Press [REC] button if you want to record again.

# Connecting with an Analog Audio

## How to Connect

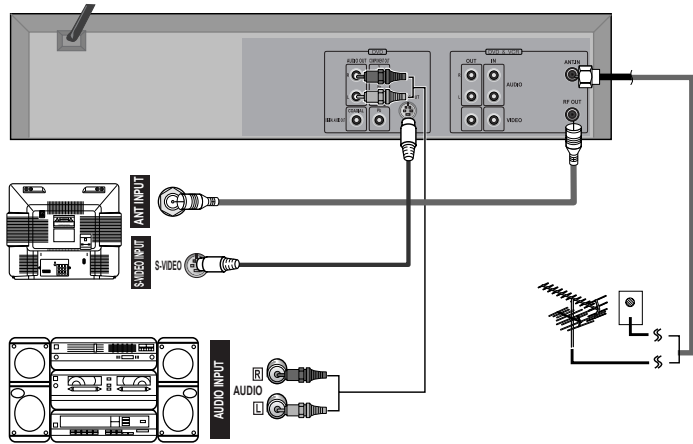

- 1 Connect Audio jack. Connect **AUDIO OUT** in rear panel of DVD-Video to In jack of stereo sound unit.
- 2 For Input Select in stereo unit, Select "External Input" connected with DVD-Video.
- 3 Playback DVD disc or Hi-Fi videotape, you can hear sound in speaker of stereo unit.

# Connecting with a Dolby Digital decoder or DTS decoder

## How to Connect

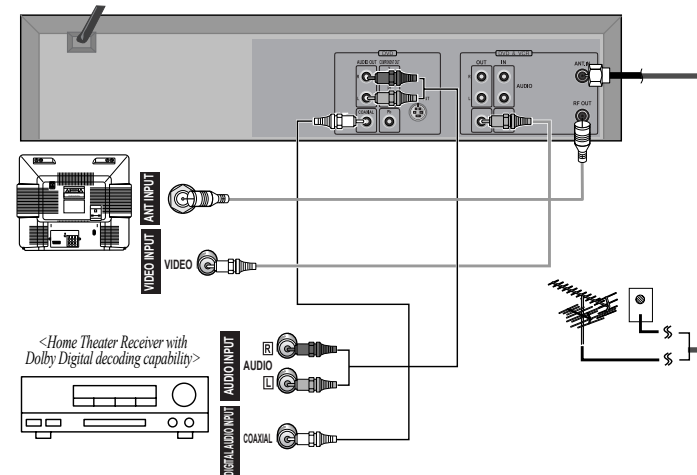

- 1 If using this DVD-Video to play a DVD disc in 5.1 channel Dolby Digital Surround, or DTS surround formats, the DVD-Video outputs a Dolby Digital, or DTS data stream from its COAXIAL DIGITAL AUDIO OUT jack. By hooking the DVD-Video up to a Dolby Digital or DTS decoder, you can enjoy a more convincing, realistic ambience with powerful and high-quality surround sound of a professional standard such as can be heard in movie theaters.
- 2 Use an audio coaxial digital cable (not included) for the audio connections.

Manufactured under license from Dolby Laboratories.

"Dolby" and the double-D symbol are trademarks of Dolby Laboratories.

# Output Select

## To Select DVD

Press [DVD] button.

If DVD mode is correctly selected, DVD on the operation display window is lighted. Then, remote control button works as DVD function. Press the [DVD] button, then the mode of DVD-Video Player becomes to the DVD OPERATION mode.



## To Select VCR

Press [VCR] button.

If VCR mode is correctly selected, VCR on the operation display window is lighted. Then, remote control button works as VCR function. Press the [VCR] button, then it becomes to the VCR OPERATION mode.



## To Select Watch Modes or External Input

Press [OUTPUT] button.

Whenever you press [OUTPUT] button, VCR PLAYBACK, BROADCASTING RECEPTION and EXTERNAL INPUT is selected in order.

# Clock Set

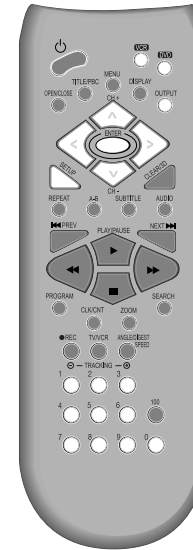

- Set TV to CH 4( or 3).
- Press [VCR] button on remote control to change into VCR mode and follow the procedures below.

**1** Press [SETUP] button.  
Press [ENTER] button to select CLOCK SET.  
Select Time and Date Set with [ENTER] button in CLOCK SET screen.

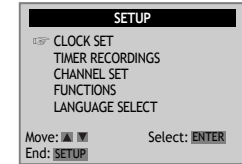

**2** Set the current date and time with [ <, >, ^, v ] button or [NUMBER] button.  
For DATE SET, follow the order of Month / Day / Year ; for TIME SET, follow the order of Hour / Minute in CLOCK SET screen.

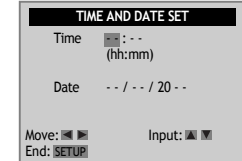
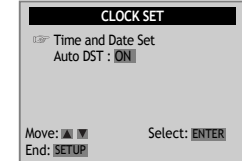

**3** If CLOCK SET is completed, press [SETUP] button.

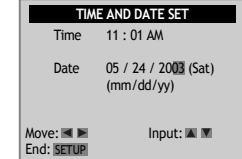

Basic Operation

# DVD Playback

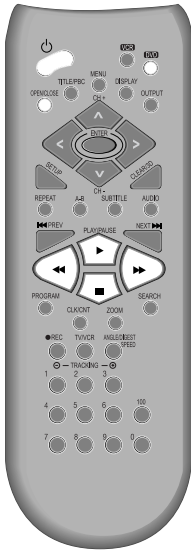

- 1 Press [⏻] button to power on.  
Press [DVD] button of remote control to change into DVD mode.
- 2 Press [OPEN/CLOSE] button to open the disc tray.  
Place a disc firmly on the disc tray, making its label look upward.
- 3 Insert the disc and press [OPEN/CLOSE] button to close the tray.  
The disc tray is closed and after checking the disc's condition, Playback or Stop function starts to operate.
- 4 To playback it, press [PLAY/PAUSE] button.
  - In the case of DVD,  
DVD menus and titles are displayed on TV screen.
  - In the case of S-VCD and VCD2.0  
the menus are displayed on TV screen and it is converted into PBC (Playback Back Control) mode.
  - In the case of CD, VCD1.1 and MP3,  
the disc plays in order of its track numbers.
- 5 To stop it, press [■] button.  
For pause, press [PLAY/PAUSE] button in playback mode.  
If you press this button once more, it starts playback again.
- 6 Press [OPEN/CLOSE] button to remove the disc.

If you press no button in 5 minutes after you are opened the tray, the player closes the tray automatically to prevent from damage.

## Various Playback Methods

- If you want fast (or reverse) playback, press [▶▶] or [◀◀] button in Playback mode. You can watch fast playing (reverse) screen.  
*\* This reverse playback can be unavailable for certain DVD. Unavailable for MP3.*
- If you want slow (or reverse) playback, press [▶▶] or [◀◀] button in Pause mode. You can watch the desired screen in the slow forward (reverse) playback.  
*\* For the case of Video CD, this reverse slow playback function is unavailable. The Ⓞ mark will appear.*
- If you want still picture, press [PAUSE] button in Playback mode. You can watch the desired screen in Pause status.

# VCR Playback

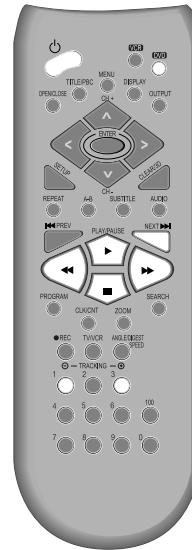

- 1 Press [⏻] button to power on.  
Press [VCR] button of remote control to change into VCR mode.
- 2 Insert the desired tape.
- 3 If you want to playback it, press [PLAY/PAUSE] button.  
When the operational status is flickering or poor, adjust it with [TRACKING +/-] button.
- 4 To stop it, press [■] button.  
For pause, press [PLAY/PAUSE] button in playback mode.  
If you press this button once more, it starts playback again.
- 5 Press [EJECT] button in the front part or [OPEN/CLOSE] button on remote control to remove the tape.

## Various Playback Methods

- If you want fast forward (or reverse) playback, press [▶▶] or [◀◀] button in Playback mode. You can watch fast playing (rewinding) screen.
- If you want Still picture, press [PLAY/PAUSE] in Playback mode. You can watch the desired screen in pause status.
- If you want slow-motion playback, press [▶▶] button in Pause mode. You can watch the desired screen in the slow forward playback.  
*\* NOTE: VCR doesn't have Slow Reverse Playback function.*
- If you want to watch a series of screens one by one, (FRAME ADVANCE) press [NEXT ▶▶] button in Pause mode. Each time you press this button, the picture advances one frame.



If the product, which has a auto-detector, detects a contaminated head(s), it shows the conditions to notice the contamination on screen.

*\* In case of the notice on screen, please rub the heads with a head-cleaner followed by "How to use a head-cleaner".*

## To Adjust Display

This product includes automatic Tracking function and enables users to enjoy clear picture without an additional operation. Provided that the following problems can be solved by the manual adjustment, which improves display quality. (During automatic display adjustment, "Adjusting Display" are displayed on TV screen.)

- If the screen is poor in Playback mode,
  - If noises occur in the upper or lower part of screen in slow playback mode,
  - If paused picture vibrates up and down.
- Use [TRACKING +/-] buttons of remote control to adjust the display suitable for watching.

## To Memorize Automatically Channels

**1 Press [SETUP] button.**  
Press [V] button to move into CHANNEL SET, and then select CHANNEL SET with [ENTER] button.

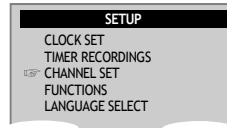

**2 Select "AUTO CHANNEL SEARCH".**  
Press [ENTER] button in CHANNEL SET window to select AUTO CHANNEL SEARCH.

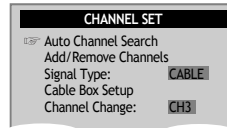

**Select "Detect Automatically".**  
Press [ENTER] button in AUTO CHANNEL SEARCH window to detect the channel automatically.

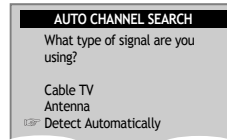

Channel number changes successively from 01 to 125, while only broadcasting channels are memorized automatically. When memory process is completed, the lowest number's one of memorized channels is displayed.

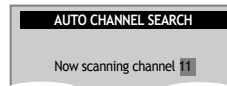

**3 Please, check the memorized channels.**  
To check the memorized channels, press [CH+/-] button on remote control.

## To Memorize Channels Manually

- When the desired broadcasting finished or you want to add unmemorized channels owing to poor signals to the memory, follow the procedures below.

**1 Press [SETUP] button and select "CHANNEL SET".**  
Select "Add/Remove Channels".

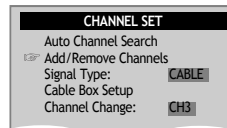

**2 Select the desired channel and memorize it.**  
Press [NUMBER] button of remote control to select the desired channel to memorize. When [>] button is pressed, "REMOVED" under channel number converts into "ADDED".



**3 Check the memorized channel.**  
To check the memorized channel, press [CH+/-] button on remote control.

## To Delete Channels Manually

- After memorizing automatically channels, when the same broadcasting is memorized in more than two channels, or you want to delete badly displayed channels, follow the procedures below.

**1 Press [SETUP] button and select "CHANNEL SET".** Select "Add/Remove Channels".



**2 Select the desired channel and delete it.**  
Press [NUMBER] button of remote control to select the desired channel to delete. When [<] button is pressed, "ADDED" under the channel number converts into "REMOVED".

**3** To check the deleted channel, press [CH+/-] button on remote control.

## Selecting cable or antenna viewing

- You must set the viewing mode for your VCR, choosing either CABLE (cable system connection) or ANTENNA (antenna connection).

**To set the viewing mode:**

Press [ENTER] to toggle the setting between CABLE and ANTENNA in CHANNEL SET screen.

When the desired viewing mode is displayed, press [SETUP] twice to exit.

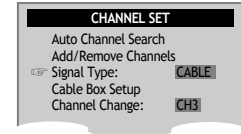

## To Set Cable Box

**1 Press [SETUP] button and select "CHANNEL SET".**  
Select "Cable Box Setup".

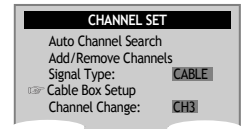

**2 Select "Cable Box Channel".**  
Press the channel number which matches to the output of the Cable Box to connect between Cable Box and this unit.

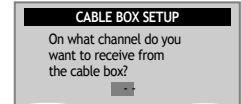

## To Set Output Channel

Press [SETUP] button and select "CHANNEL SET". Select "Channel Change".

By pressing [ENTER] button, set the exclusive channel for video on the desired one of CH3 or CH4.

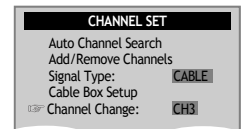

## To Record With VCR



- 1** Press [⏻] button to power on.
  - Press [VCR] button of remote control to change into VCR mode.
  - Power on TV and select Ch 3, or press [INPUT] button of TV set to select External Input mode.

---

- 2** Insert a recordable tape.
 

Insert a tape with recording tab.

---

- 3** With [CHANNEL], [NUMBER] and [OUTPUT] buttons, select the desired broadcasting channel or external input unit to record.

---

- 4** Select the desired speed (SP or SLP) with [SPEED] button.

---

- 5** Press [REC] button.
 

Then, it starts recording.

---

- 6** If you want to pause recording, press [PAUSE] button.
 

After pressing [PAUSE] button, if the pause status continues for five minutes, the recording is released automatically.

---

- 7** To exit recording, press [STOP] button.

## To Enjoy Another TV Channel or DVD during recording

- 1** If you want to watch another TV channel during recording with video, press [TV/VCR] button.
 

It is available of changing into and watching another TV channel by pressing TV [CHANNEL] buttons.
- 2** If you want to playback DVD during recording with video, insert a DVD disc.
 

Place the desired DVD disc on DVD tray, press [DVD] button to convert OUTPUT into DVD mode and press [PLAY] button. Then, you can watch DVD.

## To Record From DVD To Videotape during DVD playback

- 1** Press [DVD] button of remote control to change into DVD mode.
 

Insert the desired DVD disc.

When it is a DVD disc with copy protect function, you can't copy it.

Insert a recordable tape.
- 2** Play the DVD disc and press [REC] button.
 

DVD plays and VCR starts recording.
- 3** To exit copy, press [■] button.
 

Also it stops automatically when DVD playback is finished or recorded tape is reached to the end.

This product incorporates copyright protection technology that is protected by method claims of certain U.S. patents and other intellectual property rights owned by Macrovision Corporation and other rights owners. Use of this copyright protection technology must be authorized by Macrovision Corporation, and is intended for home and other limited viewing uses only unless otherwise authorized by Macrovision Corporation. Reverse engineering or disassembly is prohibited.

## One Touch timer Recording (OTR)

- When your urgent business happens suddenly in watching TV or you want to record the current TV program for the desired time, follow the procedures below.

- 1** First, follow the steps 1 to 4 in "Recording With VCR".
- 2** Press [REC] button as much as you want. See the "Recording Times Table" below.
 

Once	.....	continuous recording until you press STOP button
Twice	.....	recording for 30 mins from current time
3 (times)	.....	recording for 1 hour
.....	.....	.....
9	.....	recording for 4 hours
10	.....	returning to the status of Once Press
- 3** To stop Recording mode, press [STOP] button more than 5 seconds.

# Timer Recordings

## TIMER RECORDINGS

- Power on TV.
- Make sure that current time is set correctly.
- Insert a recordable tape with recording tab.
- Prior to the setting, press [VCR] button to change to VCR mode.

**1** Press [SETUP] button and select "TIMER RECORDINGS".  
Move into "TIMER RECORDINGS" with [V] and then, select the desired one with [ENTER] button.



**2** Select "Make a New Program".  
Press [ENTER] button to select "Make a new Program".



**3** Select "Timer Recording method".  
Move into desired recording type with [V] and then, select the desired one with [ENTER] button.

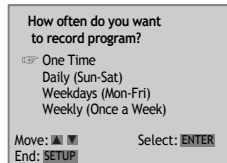

For Timer Recording method details, see "Various TIMER REC" in the page 24.

**4** Select "a broadcasting to record".  
Select the desired broadcasting channel with [NUMBER] buttons.

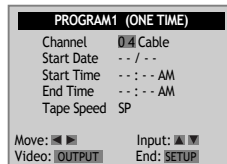

\*\*If Converter Box and video are connected to Video/Audio terminal, set "EXTERNAL INPUT" on TIMER REC CH by using "OUTPUT" button.

When moves into "Cable", select one of "Cable"/"Antenna" with [V] or [^] button.

**5** Set "the date and time to record".  
Select the date, start time and end time to record with [NUMBER] buttons.

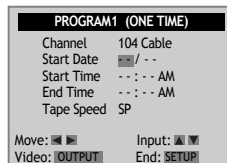

If a recordable tape is not inserted in Stop mode under Power ON, "Waiting for TIMER RECORDINGS. Insert a recordable tape" message is displayed in the center of screen, for all changes or output conversions incurred during TIMER RECORDINGS SET.

**6** Set proper "RECORDING SPEED".  
Select one of SP/SLP with [V] or [^] button.  
For more information on recording speed, see "Using video cassette" in the page 24.

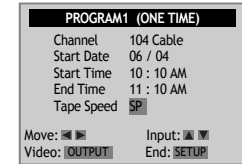

**7** Press [SETUP] button to complete the setting.  
"Program # has been saved. For program recording, insert a cassette...." message is displayed.  
TIMER RECORDINGS indicator, is displayed in the operation display window.  
On the reserved time, TIMER RECORDINGS starts to operate.

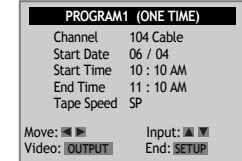

PROGRAM 1 has been saved.  
For program recording, insert a cassette.  
To leave your cable box on and tuned to preset channel.

## To Confirm or Cancel TIMER RECORDINGS

**1** Select "Review/Cancel Programs".

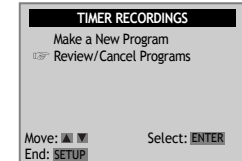

**2** Confirm reservation-recording details in turn with [V] button and then, press [CLEAR] button on the position of the details to delete.

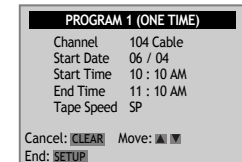

## Timer Program Setting

Press [PROGRAM] button in VCR mode.

You can set the Timer Program.

Before timer program setting, clock should be set correctly and video mode should be selected.

## Various TIMER RECORDINGS

**One Time:** It is available of TIMER RECORDINGS at the desired specified time.

**Daily :** Once you set TIMER RECORDINGS of the desired program telecasted at the same time day after day, it is available of daily recordings. It is available of TIMER RECORDINGS from Sunday to Saturday.

**Weekday :** It is similar to Daily TIMER RECORDINGS, but this TIMER RECORDINGS is available from Monday to Friday.

**Weekly :** Once you select one day of the week, it is available of TIMER RECORDINGS in the same day weekly.

## Using video cassettes

Before you play or record on a video cassette tape, be certain to read this information on the proper care and use of video cassettes.

Only use video cassettes that bear the VHS mark: .

There are four types of video cassettes: T-60, T-90, T-120, and T-160. The amount you can record on a tape is dependent upon the tape speed at which you record. The table below lists the recording time(hours:minutes) for each tape type according to recording speed.

Tape Type	SP Mode (Standard Play)	SLP Mode (Extended Play)
T-60	1:00	3:00
T-90	1:30	4:30
T-120	2:00	6:00
T-160	2:40	8:00

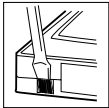

### Protecting video cassettes from accidental erasure

Cassettes have a safety tab to prevent erasure. Break off the safety tab with a screw driver. If you wish to record on a cassette without a safety tab, cover the hole with cellophane tape.

### Inserting video cassettes

Firmly insert the cassette into the cassette compartment with the label up. An inverted cassette cannot be inserted.

### Removing video cassettes

Press [EJECT] on the front panel and the VCR will eject the tape. Pull the cassette out gently.



- Audio-visual material may include works of copyright which must not be recorded without authorization of the copyright owner.
- **If you insert a video cassette without a safety tab into the unit :** After setting the timer recording program, " " will blink on the display panel in the power off mode and the unit will automatically eject the cassette. In the power on mode, the unit will playback automatically.
- **If you insert a video cassette with a safety tab into the unit :** After setting the timer recording program, the unit will be stand-by mode in power off mode.
- Do not attempt to pull out the video cassette once the unit begins to load the video cassette.
- Do not insert fingers or any foreign object beyond the door flaps of the cassette compartment; this could lead to injury or equipment damage.
- Do not attempt to insert a video cassette if the unit is unplugged.

# Watching and Recording Cable TV

## To Watch and Record Promptly Cable TV

- 1 Power on converter and then,** set a channel to watch or to record.  
**Power on DVD-video and then,** set the channel of DVD-video to the converter-connected channel (one of CH03/04/EXTERNAL INPUT).  
**Power on TV and then,** set the video-connected channel (one of CH03/04/VCR).

## 2 Simultaneous Recording and Watching

At this time, CH selected by the converter is displayed on TV screen. Simultaneously, press [REC] button of DVD-Video to record the CH selected by the converter, and press [REC] button more than two times to set on One Touch timer Recording (OTR).

## TIMER RECORDINGS of Cable TV

- 1 Reserve VCR.**  
According to TIMER REC procedures, select TIMER RECORDINGS SET window and complete the settings. At this time, the video channel should be input in CH3 (or CH4, EXTERNAL INPUT) of the converter-connected channel. Enter date and time of the cable program for TIMER RECORDINGS.

- 2 Adjust Converter.**  
Set converter to the cable TV channel to record.  
e.g.) To record CH48,  
Display CH48 with CONVERTER CHANNEL SELECT button.  
If there is TIMER REC function of converter, it is available of reservation.

- 3 Complete Reservation.**  
If you power on converter, video powers on automatically and starts recording at the reserved time.  
\*\*Home watching cable TV is unavailable of simultaneous recording function (while recording NBC program, watching CNN program). (Owing to mechanical features of converter, it is unavailable of simultaneous reception of two channels.)



### Play the tape automatically

- This feature allows the VCR to automatically start playing when you insert a tape with the safety tab removed.

- 1 Press [SETUP] button and select "FUNCTIONS".  
Move  into "FUNCTIONS" with [v] and then, select the desired one with [ENTER] button.



- 2 Press [ENTER] to switch between ON and OFF.
  - Select ON if you want a tape with its safety tab removed to start playing automatically when the tape is inserted.
  - Select OFF if you do not want a tape with its safety tab removed to start playing automatically.



### Switch the VCR to TV or VCR mode automatically

- This feature controls whether the TV/VCR switch changes automatically to the VCR mode when the VCR is turned on.

- 1 Press [SETUP] button and select "FUNCTIONS".  
Move  into "FUNCTIONS" with [v] and then, select the desired one with [ENTER] button.

- 2 Press [ENTER] to switch between ON and OFF.
  - Select ON if you want the VCR to switch to the VCR mode when the VCR is turned on or a cassette is inserted. This only applies if you connect the ANT. IN and RF OUT jacks of your VCR and TV and watch your VCR on channel 3 of your TV.
  - Select OFF if you want the VCR to remain in the TV mode. This is useful if you watch your VCR on the TV's video input and you don't want your antenna/cable signal interrupted by the VCR.



### Searching a cassette tape for programs (indexing)

- When you record a programs, the VCR places an index mark at the start of the recording. To search for an index mark:

- If two recordings overlap, the index mark for the second program will be erased. Therefore, when you use the index feature to find the second program, the VCR will skip over it.
- If you record multiple programs in one recording session, the VCR will only find the index mark that was placed on the video cassette tape when the recording session began.

- 1 Press [SETUP] button and select "FUNCTIONS".  
Select "Index Search".

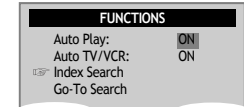

- 2 If you want to search through a certain number of index marks, press two number buttons to enter the number of marks you want to search. Press CLEAR on the remote to correct an entry.  
or  
Press REW to search backward or FF to search forward. The VCR will locate your index mark and begin playback. If you did not enter a specific index number, the VCR will locate the next index mark and begin playback. Press STOP to stop index searching.



### Searching with the tape counter (go- to search)

- You can mark a segment of the video cassette with the tape counter that will help you easily locate the segment later.

- Some index marks that may be missed by the VCR :
  - A mark too close to your location on the tape.
  - The mark at the beginning of a recorded segment of five minutes or less.
  - The first index mark on the tape when you start at the beginning of the tape.

- 1 Press [SETUP] button and select "FUNCTIONS".  
Select "Go-To Search".

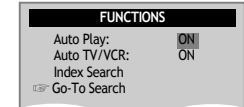

- 2 The tape counter is displayed on the screen. Input the tape counter you want to go and press REW or FF, the VCR will search for the time counter you want.

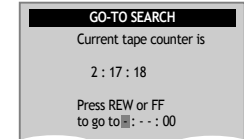

### Marking a tape for zero search

- 1 Use PLAY, REW, or FF to reach the point on the tape that you would like to mark as 0:00:00.
- 2 Press [DISPLAY] button to display the tape counter on the screen.
- 3 Press [CLEAR] button to reset the tape counter to 0:00:00.
- 4 You can continue to play the tape or perform other functions with the VCR.

## Display (O.S.D)

- 1 Press [DISPLAY] button to display the tape counter, clock and status mode on the TV screen.
- 2 And, by one more pressing [DISPLAY] button before disappearing the OSD from the screen, only the tape counter will remain on the screen.

## Daylight-Saving Time

- 1 Press [SETUP] button and select "CLOCK SET".  
Move  into "Auto DST" with [v].

- 2 Press [ENTER] to switch between ON and OFF.

- Select ON if you want the VCR's clock to automatically adjust for daylight-saving time.
- Select OFF if you do not want the VCR's clock to adjust for daylight-saving time.

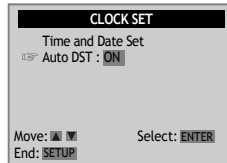

### SPRING Forward ; Fall Backward

In the Spring, daylight-saving time begins on the first Sunday in April. Because the clock automatically changes from 2:00 AM to 3:00 AM (forward one hour), remember to include the extra hour for timer recording falling within this time frame.

In the Autumn, daylight-saving time ends on the last Sunday in October.

The VCR clock automatically changes from 2:00 AM to 1:00 AM (back one hour). Therefore, it can affect your recording length.

## Changing the on-screen menu language

- You may select the language in which you would like the VCR's menu to be displayed: English, Spanish, or French.

- 1 Press [SETUP] button and select "LANGUAGE SELECT".

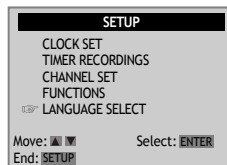

- 2 Select the language among English, Spanish or French by pressing [ENTER] button.



# Hi-Fi Stereo Playback (*Hi-Fi Model only*)

## Playing a tape in Hi-Fi high-quality

- "Hi-Fi" signal lights up in the top of a screen.
- Pressing [AUDIO] button changes menus one by one.

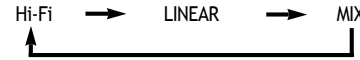

If there are some noises made in recording, please "Linear" to reduce them.

## Forced Mono

- In some cases, while receiving a stereo or SAP (Secondary Audio Programs), receiving condition may be poor, which may cause the stereo or SAP broadcasting to be interfered frequently or its volume to be uncontrollable. Just pressing [AUDIO] in stereo or SAP forces to fix the condition into mono sound.
- To return it, you have two choices, pressing [AUDIO] button again or picking up the channel again.



- While recording in stereo signal, it is recorded in Hi-Fi.
- SAP is available only in its service areas from stations.

## Recording Stereo or Secondary Audio Programs (SAP)

- Programs are broadcast in mono or stereo audio, or with a SAP.
- Pressing [AUDIO] button changes STEREO, MONO, SAP one by one.



- The following guidelines will help you decide on the best method for recording programs. Choose:
  - Stereo reception for normal recording and to record broadcast stereo television.
  - Mono reception if the stereo signal is weak and sound is too "noisy."
  - SAP reception to record a second audio program. An example of a SAP is a program that is broadcast in English, but has a Spanish SAP.
- You can only record stereo and SAPs if the program is a broadcast in stereo or with a SAP. Consult a television guide for program broadcast information.

## To skip scenes in a disc

DVD, VCD, VCD2.0, CD, MP3

To move to next chapter (or track), press [NEXT ►►] button.

The current chapter (or track) moves to the next chapter (or track).

Press [◄◄ PREV] button.

The current scene moves to the previous chapter (or track) or first scene of current chapter (or track).

## Directly moving to a desired title (DVD)

DVD

- Some movie discs may contain multiple titles. If the disc has a movie title menu recorded on it, the [TITLE] button can be used to select the movie title. Details of operation may differ depending on the disc used.

\* Selecting a title may not be available on certain DVD discs.

**1** Press the [TITLE/PBC] or [MENU] button.

A list of the titles on the disc is displayed.

For the case of VCD disc, menu screen will appear only when the disc has PBC function and PBC ON is activated.



**2** Press the [ENTER] button or [PLAY] button after pressing the [< > ^ v] button to select the desired title.

The selected title now starts playing.



## Playing a programmed order

DVD, VCD, CD

**1** While STOP or Playback, press [PROGRAM] button.

While the right figure is appearing, please input desired Title and Chapter number with NUMBER buttons. Press [ENTER] to go into next program number.

\* In case of VCD and CD, please input TRACK Number.

Program Title	Menu Chapter	Select : ENTER Title	Chapter
1	--	6	--
2	--	7	--
3	--	8	--
4	--	9	--
5	--	10	--
Previous ↑		Next ↓	
Play		Exit : SETUP	

**2** After completing setting, press [PLAY] button.

Then, titles and chapters (track) are played in the above-programmed order.

To exit from Program Play mode, press the [SETUP] button in Program menu screen.

## Repeating a defined period

DVD, VCD, CD, MP3

Each time you press [REPEAT] button in playback mode, repeat playback starts as below.

• DVD : Rep. Chapter --> Rep. Title --> Rep. Off



• VCD : Rep. One --> Rep. Disc --> Rep. Off

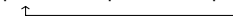

• CD : Rep. One --> Rep. Disc --> Rep. Random --> Rep. Off

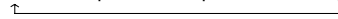

• MP3 : Rep. One --> Rep. Dir --> Rep. Disc --> Rep. Random --> Rep. Off



- Rep. Chapter : Current chapter will be repeatedly playback.
- Rep. Title : Current title will be repeatedly playback.
- Rep. One : Current track will be repeatedly playback.
- Rep. Disc : Current disc will be repeatedly playback.
- Rep. Random : Tracks in the disc will be playback in random order.
- Rep. Dir : Current directory in MP3 disc will be repeatedly playback.
- Rep. Off : Repeat playback will be cancelled.

## Repeating a defined period from A to B

DVD, VCD, CD

- You may repeat a defined period from A to B.

**1** At the point where you want to start the repeat playback, press [A-B] button.

The right figure appears and repeat playback start position (A) is set.



**2** At the point where you want to end the repeat playback, press [A-B] button again.

The repeat playback end position (B) is set and a defined period from A to B is playback repeatedly.



**3** To exit from repeat playback mode, press [A-B] button.

It enters into Normal Playback mode.



- A MP3 disc may not be repeated from A to B.

## Searching DVD with a title number, a chapter number or a time

DVD

- 1 If you want to search with a title number, press [SEARCH] button one time.

It shows total title numbers, chapter numbers and times. Please enter the new title number to be searched using the [NUMBER] buttons.

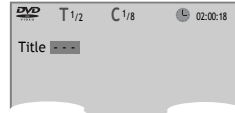

- 2 If you want to search with a chapter number, press [SEARCH] button twice.

Please enter the new chapter number to be searched using the [NUMBER] buttons.

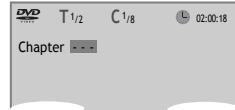

- 3 If you want to search with a time, press [SEARCH] button three times.

Please enter the new time to be searched using the [NUMBER] buttons.

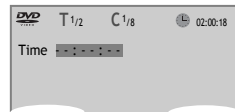

In completing entering, please press [ENTER] button.

PLAY starts from the selected position.

## Searching VCD and CD with a track number or time

VCD, CD

- 1 If you want to search with a time, press [SEARCH] button one time.

In case of PBC OFF, the screen like the right figure appears. Please enter the new time to be searched using the [NUMBER] button.



\* If it is PBC ON, pressing the time number converts PBC to OFF mode automatically.

- 2 If you want to search with a track time, press [SEARCH] button twice.

In case of PBC OFF, the screen like the right figure appears. It shows current track's time and the whole disc's hours. Please enter the new track time to be searched using the [NUMBER] button.

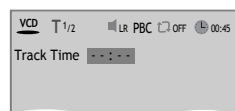

\* If it is PBC OFF, only the track's time appears.

- 3 In completing entering, please press [ENTER].

PLAY starts from the selected position.

\* In case of MP3, press [SEARCH] button one time. When it shows track [ ] , please enter the track number.

# Confirming the current PLAY mode on screen

## Confirming the current DVD disc mode

DVD

- 1 While in playing, press [DISPLAY] button.

It shows the disc type, current title, current chapter and time elapsed.



- 2 Press [DISPLAY] button again.

It shows the DVD disc logo, subtitle selected, audio selected, dolby digital logo, repeat playback mode and current angle.

To exit from Display mode, press [DISPLAY] button again.

## Confirming the current VCD, CD disc mode

VCD, CD

- While in playing, press [DISPLAY] button.

It shows the disc logo, current track, subtitle selected, audio selected, repeat playback mode, time elapsed and equalizer bar.

\* In case of CD, display screen appears automatically in playback mode. But subtitle and equalizer bar indicator will not appear.

To exit from Display mode, press [DISPLAY] button again.



## Confirming the current MP3 disc mode

MP3

- 1 Display screen appears automatically in Playback mode.

It shows the MP3 File information in disc, the directory, MP3 File name and directory list.

With [ < > ^ v ] buttons, you can move the cursor to directory or number of MP3 Music File. To go to desired directory or to playback MP3 File, press [ENTER] key.

\* The information of MP3 File means the disc type, current track, Bit rate, repeat playback mode, time elapsed and equalizer bar.

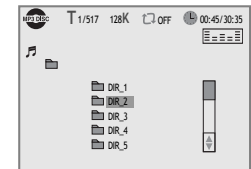

- 2 At the desired directory position, press [ENTER] button.

It shows the track list.

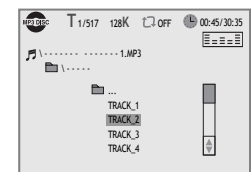

# AUDIO language, SUBTITLE language and 3D AUDIO

## Selecting an audio language

DVD

- The user may select an audio language and subtitle language if a disc includes Multi-language.

 A certain disc may not support audio select or subtitle select.

Keep pressing [AUDIO] button till the user's preferred language appears.

If DVD disc includes audio information, every time the user presses [AUDIO] button, English (ENG), French (FRE), Spanish (SPA) and others appear one by one.

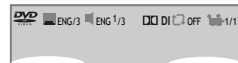

## Selecting a subtitle language

DVD

Keep pressing [SUBTITLE] button till the user's preferred language appears.

If a DVD disc includes subtitle information, every time the user presses [SUBTITLE] button, English (ENG), French (FRE), Spanish (SPA) and others appear one by one.

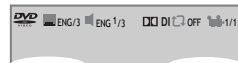

## Selecting 3D Audio

DVD, VCD, CD

- Sound Fields and Graphics Equalizer can be set.

Please press [3D] button.

If the right figure appears, move the cursor with [ $<$   $>$   $\wedge$   $\vee$ ] buttons.

The user may select a "Sound fields" among Standard, Theater, Amphitheater, Live, Concert, Church, Wide, Hall or Stadium.

Also, select a "Graphics equalizer" among Standard, Classic, Rock, Jazz, Pop or User.

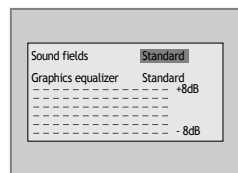

\* When setting graphics equalizer, sound fields changes to "Standard" automatically.

# ZOOM, Multi Angle and Digest play

## Using a zoom function

DVD, VCD

- The user can enlarge the current screen about 1.3 or 2 times.

Keep pressing [ZOOM] button till the preferred zoom appears.

Every time the user presses [ZOOM] button, a zoom magnification changes 1.3 times (X1.3) → 2 times (X2) → OFF → 1.3 times (X1.3) → ... one by one.

A base point to be enlarged is centre and the point can be changed with the operation of [ $<$   $>$   $\wedge$   $\vee$ ] button.

 For the case of VCD, only 2 times Zoom is available.



## Different Angle

DVD

- If a disc includes multi angle information, the user can watch a screen in multi angles. The function is limited to a DVD disc supporting multi angle information.

Keep pressing [ANGLE] button till the preferred angle appears.

Every time the user presses [ANGLE] button, an angle degrees changes in a consecutive order.



## Digest play

DVD, VCD2.0

Press the [DIGEST] button in playback or stop mode.

All the contents of VCD are divided to 9 parts and the first scene of each parts are shown on the screen.

Press the [ENTER] button after moving to the desired scene with [ $<$   $>$   $\wedge$   $\vee$ ] button.

The selected scene now starts playing.

 Only activates with VCD 1.0 or VCD 2.0 discs.



# About MP3 discs

## Playing a disc containing MP3 files

MP3

This unit will play MP3 files recorded on CD-R and CD-RW discs.

MP3

- 1 Turn on your television and select the channel assigned to this DVD player.
- 2 Press the DVD open [OPEN/CLOSE] button, the disc tray opens.
- 3 Put a disc containing MP3 files on the disc tray with the label side up.
- 4 Press the DVD open [OPEN/CLOSE] button, the disc tray closes.
- 5 The unit will take a short while to load the disc and display the directory structure.
- 6 Press the [ < > ^ v ] navigation buttons of the remote control to select the folder, then press the [ENTER] button to confirm.
- 7 Press the [ < > ^ v ] navigation buttons of the remote control to select the file you want to listen to, then press the [ENTER] button and this selected file is located and played back.
- 8 After starting playback, the track list is on-screen. You can move the highlight onto the folder name above the track list and change folder with the [PREV] button. Press the [SEARCH] button twice in stop mode to get back to folder tree view.

### ■ Play and Pause

Press the [PLAY/PAUSE] button to switch between play and pause.

### ■ Search for a track

The [SEARCH] button works on MP3 discs as well as CD audio.

### ■ To stop playback

Press the [STOP] button.

### ■ To skip to the next or previous file

- Press the [NEXT ►►] button of the remote control briefly while playing, to skip ahead to the beginning of the next file. Each time you press the button consecutively, the beginning of the next file is located and played back.
- Press the [PREV ◄◄] button of the remote control briefly while playing, to skip back to the beginning of the previous file. Each time you press the button consecutively, the beginning of the previous file is located and played back.

 The ability of this unit to read MP3 discs is dependent on the followings:

- The Bit Rate must be within 64-256 kbps.
- The maximum number of directories should not exceed 32.
- The maximum depth level of directories should not exceed 4.
- File names should be named using 8 or fewer letters and/or numbers, and must incorporate the "MP3" file extension. EXAMPLE: \*\*\*\*\*.MP3 where each \* is a letter or number.
- Use only letters and/ or numbers in file names. If you use special characters, the file and/ or folder names may not be displayed correctly on the on-screen display.
- The CD-R or CD-RW discs should be written using the 'disc at once' method.
- The disc which is made with ISO 9660 format can be playback.

# Displaying menus in a disc

## To display menus in a disc

DVD, VCD2.0

- If a disc includes menus, the user may use them.

- 1 Press [TITLE/PBC] or [MENU] button.
  - It shows menus in the disc. Also they are different according to discs. ("Return" will appear on the OSD with VCD2.0.)
  - If it is a VCD2.0, select PBC ON mode by pressing [TITLE/PBC] button.  
\* CD and VCD1.1 do not support the function.
- 2 Move a cursor to a relative item with arrow buttons of [ < > ^ v ] button and select one with [ENTER] button or [PLAY] button.

## LANGUAGE Setup

- A user can set OSD language, Audio, Subtitle and Disc Menu.

 "OSD" means "On Screen Display".

- 1 While STOP or RESUME STOP, press [SETUP] button.
- 2 Selecting a OSD language.  
Please select a language to be displayed on DVD screen.
- 3 Selecting Audio language.  
Set it as the preferred audio language. In case the audio language is set and recorded in the DISC, it is automatically played in the set language in every playing. For example, English is set and recorded as audio language in the DISC, it is played in English.
- 4 Selecting Subtitle language.  
Please set it as the preferred language. In case the subtitle language is set and recorded in the DISC, it is automatically played in the set language in every playing. For example, English is set and recorded as subtitle language in the DISC, it is played in English.
- 5 Selecting DISC MENU language.  
Please set it as the preferred DISC MENU language. In case the DISC MENU language is set and recorded in the DISC, it is automatically played in the set language in every playing. For example, English is set and recorded as a DISC MENU language in the DISC, it is played in English.

 In case a disc does not include setting languages information, the selected language does not appear.



# VIDEO Setup

- A user can set up a connected TV condition and screen.

**1** While STOP or RESUME STOP, press [SETUP] button.



**2** Select TV Aspect.

If a user selects "4:3 PS", the user can watch only a center of the original scene of "16:9".

If a user selects "4:3 LB", the user can watch the original scene of "16:9", but the top and bottom of the screen look black color.

If a disc size is originally recorded in 4:3, a user cannot watch it in a wide screen though a user sets a size as "16:9 Wide".

**3** Select Video Out.

A user may select a Video Out between Component and S-Video.

# AUDIO Setup

- A user may select audio menu according to a user's speaker set.

**1** While STOP or Resume STOP, press [SETUP] button.

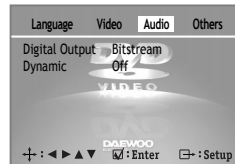

**2** Select a digital output.

You can set following 2 values of digital output;

- **Bitstream:** The same signal as audio signal recorded in disc goes to digital audio output terminal.
- **LPCM:** Decoded audio signal goes to digital output terminal.

**3** Select a Dynamic Range

You can set following 2 values of Dynamic Range;

- **Off :** You can hear the same sound as recorded in disc.
- **Full :** You can hear loud sound softer and soft sound louder.

# Others Setup

**1** While STOP or RESUME STOP, press [SETUP] button.



**2** Select character display window.  
Select "On" to make OSD(On Screen Display) language displayed in screen.

**3** Select screensaver.  
If bright scenes continue to be displayed in screen, TV can be damaged. Set the screensaver to "On", the screensaver functions automatically and DVD logo moves continuously if the resume stop, stop, open status is maintained for about 5 minutes.

**4** Select defaults.  
If you select defaults, every function set returns to FACTORY Defaults except PARENTAL.

**5** Entering a password.  
Input password display appears.  
Enter a user's password by pressing 4 [Digit] buttons.



**6** Select Parental.  
Press [ENTER] button to set the selected item.  
It consists of 8 levels of parental control, violence, sexual scene, strong sexual scene and others to protect children from watching those scenes.

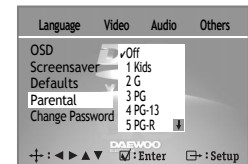

**7** Changing a password.  
For the change of a user's password, please move to "Change Password" and enter new password.



 "Parental Lock" activates only if you set a password and the unit goes into Lock status. When the disc has no parental function even if the disc for adult only, Parental Lock doesn't activate.

 The initial password is 3308. In case you forget newly-input password, you can use 3308 as a password.

## Playable Disc

- DVD, Video CD (Version 1.1, 2.0), S-VCD and Audio CD

Disc type	Playable	Restriction
DVD	Possible	Region number 1 or Region number All
Video CD	Possible	Version 1.0/1.1/2.0, SVCD/CVD
CD	Possible	PCM
CD-G	Possible	Only Audio playback
CD-ROM	Possible	MP3 File
CD-R	Possible	Video-CD/CD/CD-ROM (MP3 File)
CD-RW	Possible	Video-CD/CD/CD-ROM (MP3 File)
DVD-R	Possible	DVD Video
DVD-RW	Possible	DVD Video
DVD+RW	Possible	DVD Video
DVD-ROM	Impossible	
DVD-RAM	Impossible	
Photo CD	Impossible	

### REGION MANAGEMENT INFORMATION

This unit is designed and manufactured to respond to the Region Management information that is recorded on a DVD disc. The region number of this player is "1". If the region number described on the DVD discs does not correspond to the Region number of this player, the player will not play this disc. This player will play DVD discs made for "ALL" regions. Therefore, this player will play DVD discs marked with labels containing the region number "1" or "ALL".



(Region 1)



(Region ALL)

## Terms related with DVD

- DVD** A DVD (abbreviation of Digital Versatile Disc or Digital Video Disc) can include 135 minutes of video information. And for audio, it can hold up to 8 kinds of languages and 32 kinds of subtitle languages. By using MPEG-2 video compression and digital 3D surround sound, DVD realizes high-defined screen and quality sound like a movie theater.
- CDDA** A CDDA (abbreviation of Compact disc digital audio) is a music disc that is currently used.
- MP3** Audio compression format that enables audio files to be stored and transferred on a computer with a relatively small file size. It enables you to enjoy CD quality music. (Short for MPEG-1 Layer 3)
- PBC** This is recorded on a Video CD 2.0, Video CD 3.0, SVCD and CVD. The scenes or information to be viewed (or listened to) can be selected interactively with the TV monitor by looking at the menu shown on the TV monitor. It stands for PlayBack Control.

- CHAPTER** It means the information recorded in a DVD. A title in a DVD is divided into many tracks, of which a track is called as a chapter. A certain scene of a screen can be quickly searched with the chapter number.
- TITLE** It means the information recorded in a DVD. A DVD can be divided into many titles.
- TRACK** It means the information recorded in a video CD and audio CD. A disc consists of many a track, for which a user can search a certain position.
- dts** Digital Theatre System is a 5.1 -channel surround sound system, which is widely used in movie theatres around the world. It enables the bit rate to be increased to provide good sound quality. "DTS" and "DTS Digital Out" are trademarks of Digital Theater Systems, Inc.
- Multi Angle** Some DVD discs contain the various scenes that have been simultaneously shot from a number of different angles.
- PCM** Linear PCM is a signal-recording format used in a CD, while CD is recorded in 44.1kHz/16bit, a DVD is recorded in 48KHz/16bit up to 96KHz/24bit.
- Dolby Digital** Dolby Digital enables the delivery of mono through 5.1-channel audio at data rates from 32 kbps to 640 kbps, thus offering flexibility and economical performance as well as uncompromised sound quality.
- Bitstream** Digital audio data that is decoded into an analog signal for subsequent output to speakers.
- Lt/Rt** It indicates L/R of Dolby Digital 2CH Downmix output.
- Downmix** DOWNMIX is reproducing the proper audio when audio format recorded on a disc differs from the output audio channel configuration. For example, with just one stereo speaker system you can hear full 5.1 channel audio.
- S-VIDEO** The S-VIDEO output separates the color (C) and luminance (Y) signals before transmitting them to the TV set in order to achieve a sharper picture. So this must be selected from the menu to enable the S-VIDEO output to function.
- COMPONENT** It is called color difference signal and is a technology to divide and transmit a color signal (C) into B-Y (Pb) and R-Y (Pr) color difference signal. This technology supplies clearer and more vivid picture than composite video type .

## Handling Disc

- To keep a disc clean condition, please do not touch a side containing play information.
- Do not attach a bit of paper or sticky tape on it.
- Do not expose a disc to a direct sunlight or electric heating systems.
- After using it, please keep a disc in a case.



## Cleaning Disc

- Before using it, please rub it from center toward outside with clean clothes.
- Do not use any type of solvent such as thinner, benzol (benzene), commercial cleaning goods or antistatic sprays.





# Basic information about VCR and Videotape

## Terms related with VCR

- AFT** Automatic fine tuning, a circuit that automatically adjusts TV reception to optimum condition.
- CABLE** Cable television.
- Index Search** A feature of this VCR that automatically records an index each time recording begins. It helps you locate a particular segment of the tape quickly and easily.
- SLP** Super Long Play, an intermediate tape recording speed that combines most of the picture/audio quality obtainable at the standard recording speed with some of the tape economy of Extended Play.
- OSD** On-screen display of information pertinent to the features of the VCR.
- OTR** One-touch recording, a feature that allows you to record the program you're watching by pressing the REC key. Each press of the key increases the recording time by 30 minutes, up to four hours.
- RF** Radio frequency, the composite audio/video signal supplied to a TV receiver (or other video component) by an antenna or cable system.
- Safety tab** The plastic tab at the back of a video tape cassette which, when removed, prevents accidental erasure of a recording.
- SP** Standard play, the recording speed to use when the best picture quality is of prime importance (and when total recording time is not).

## What is dew condensation symptom?

- If a VCR is moved from a cool place to a warm and damp place or a place facing a direct cool wind from air-conditioner...and others, temperature varies sharply, which makes dew on head drums of VCR.

### If dew condensation occurs,

- First, turn it on for one or two hours before using it.
- Do not use it because it may develop troubles of a VCR or videotape.

## How to use a head cleaner

- In case of a old or contaminated videotape, screen may not be clean from the contamination of VCR heads. Please remove contaminants using a head-cleaner like below order.

- Insert a head-cleaner into VCR.
- Press [PLAY] for 5 seconds, and then press [FF] for about 10 seconds.

PLAY (5 secs)



FF (10 secs)

- Eject a head-cleaner from VCR.
  - If the screen is not clean yet, please repeat the above 2 or 3 times more.
  - A head-cleaner is not for sale. Please ask it for the nearest agent.
  - In case a user ask the removal of contaminants of us, the user should pay extra charges.

# Before doubting about troubles (DVD)

Symptom	Checks
• The player does not play.	<ul style="list-style-type: none"> <li>▶ If a DVD is from overseas, it may not be played. Please check a DVD's region code whether it has the relative region code 1 or ALL.</li> <li>▶ Please check whether a DVD is inserted in a right direction.</li> <li>▶ If it is a CD-ROM for PC or DVD-ROM, it does not work.</li> </ul>
• No sound comes through.	<ul style="list-style-type: none"> <li>▶ Play mode may be "SLOW" or "PAUSE" (In abnormal speed play, no sound comes through)</li> <li>▶ Did you connect the parts in right way?</li> <li>▶ Please check the operative condition of TV or amplifier.</li> <li>▶ From SETUP, please check "AUDIO" items.</li> </ul>
• A disc is playing but screen does not appear or poor screen appears.	<ul style="list-style-type: none"> <li>▶ Did you turn on your TV sets?</li> <li>▶ Did you connect the parts in right way?</li> <li>▶ The play may be in "PAUSE".</li> <li>▶ A disc may have some contaminants or be damaged.</li> <li>▶ A disc may be bad one.</li> </ul>
• Sound is irregular	<ul style="list-style-type: none"> <li>▶ Please check the connection with Dolby Digital amplifier.</li> <li>▶ Please check the plugs are connected with one another tightly.</li> <li>▶ Some contaminants may be remained in connection terminal.</li> </ul>
• Remote control does not work.	<ul style="list-style-type: none"> <li>▶ Please check the degree of remote control, distance or any interruption.</li> <li>▶ Battery may be weak or exhausted.</li> <li>▶ When you operate DVD, use it by pressing [DVD] button.</li> <li>▶ Unplug the power plug and plug it again.</li> </ul>
• Dolby Digital sound does not work	<ul style="list-style-type: none"> <li>▶ Dolby Digital sound can be worked in the Dolby Digital amplifier only.</li> <li>▶ Please check "Dolby Digital" mark on your DVD.</li> <li>▶ In case of playing it through digital output, while pressing [STOP], please check whether "DIGITAL OUTPUT" is "BITSTREAM" by pressing [SETUP].</li> <li>▶ Please check the connection is correct.</li> </ul>
• [AUDIO] or [SUBTITLE] button does not work.	<ul style="list-style-type: none"> <li>▶ If a DVD does not include language information, it does not support the function.</li> </ul>
• [ANGLE] button does not work while a DVD is playing.	<ul style="list-style-type: none"> <li>▶ "ANGLE" is supported only in a DVD contains multi angle scenes. Also a user can confirm the support with the "ANGLE" mark on screen.</li> </ul>
• "MENU" does not appear while a DVD is playing.	<ul style="list-style-type: none"> <li>▶ Please check the degree of remote control, distance or any interruption.</li> <li>▶ Please check a battery in remote control whether it is exhausted or not.</li> <li>▶ A DVD may not contain menu information.</li> </ul>
• Screen shakes or appears only in black and white. (or Subtitle shakes)	<ul style="list-style-type: none"> <li>▶ A disc may have some contaminants or be damaged.</li> <li>▶ If you playback a DVD disc of PAL system whose region code is "ALL", the playback screen may shake.</li> </ul>
• The file name of MP3 (CD-R) appears with strange letters.	<ul style="list-style-type: none"> <li>▶ The file name of MP3 recognize only the Alphabet (A-Z, a-z), numbers (0-9) and a special symbol on keyboard (-, !, @, #, \$ ...) and 10 letters can be displayed in maximum.</li> <li>▶ The letters except above case will be displayed like "----".</li> </ul>
• Any MP3 (CD-R) file isn't displayed.	<ul style="list-style-type: none"> <li>▶ If the surface of disk is injured, the file display and playback can be impossible.</li> </ul>

# Before doubting about troubles (VCR)

Symptom	Checks
• "Power On" does not work.	➤ Please check whether a power plug is inserted in an electric outlet.
• It does not work even in "Power On".	➤ Please check whether a videotape is inserted in. ➤ Try to insert a plug again.
• A videotape is not inputted in.	➤ Please check whether a power plug is inserted in an electric outlet. ➤ Please check whether a videotape is in. ➤ Please check whether a videotape is inserted in a right direction (a side of transparent window should be on the upside) ➤ Have you inputted a videotape again just after the tape was ejected? Please try it again after fully ejecting it. ➤ When a videotape forces to be ejected, the tape may not be inputted. In the case, please pull out an outlet, and then push the tape smoothly.
• On inputting a videotape, the tape is re-ejected.	➤ That's why a safe mode to protect a videotape is operated automatically. Please pull out the tape and input it again.
• A videotape is not ejected.	➤ In case the product is used for a long time, a videotape may not be ejected for a film inside may be stretched. In the case, please pull out a power plug for about 10mins and then press [EJECT] button.
• A channel on video and a play screen does not appear.	➤ Please check your antenna's connection. ➤ TV channel should be fixed on video channel (3 or 4). ➤ Please check your antenna's signal whether it may be weak. In case of its weakness, please use a frequency amplifier connected with the device. ➤ Press [TV/VCR] and then let "VCR" is displayed on the display panel.
• Noise (screen noise) appears on screen.	➤ While in no use of VCR, was it turned on? ➤ While in recording a program, do you watch another channel? ➤ Select TV by pressing [TV/VCR] button on remote control.
• Noise appears on screen after recording.	➤ While in playing a videotape, there may happen some noise or blot in the part of the beginning of a videotape or resuming "PAUSE", which are not breakdown.
• While in playing, noise appears.	➤ Please press [TRACKING] for better screen. Videotape may be poor. Try to change it to another one.
• Sound and screen are irregular. • Sound comes out but screen does not appear. • Screen is irregular and stripes appears. • "Screen Error" message is displayed in a screen.	➤ Please use a head-cleaner to clean VCR heads. VCR heads may be contaminated.
• While recording and playing, the top of screen extremely waves.	➤ Since VCR Play signals are not stable like a TV signals, screen may be unstable or curved while in playing. To fix the problem, please horizontal adjustment.
• A screen is not clear.	➤ In case videotape is the one recorded by other products or old one, stripe may appear on the screen. ➤ Try to adjust the screen by [TRACKING+/-] button. ➤ Try to use a head-cleaner.
• A screen at pause is trembling or slow screen is not clear.	➤ Try to use a head-cleaner. ➤ Try to adjust the screen by [TRACKING+/-] button.

Symptom	Checks
• Recording a TV program is impossible.	➤ Please check whether a channel is fixed on video. If not, you have to turn it into "TV" by pressing [OUTPUT] button. ➤ Please check whether the timer recording info is right. ➤ Are RF cables inputted antenna connection terminal correctly? ➤ Does a CH number selected in display section appear? ➤ Please check a tab on a tape whether it is broken or not. (If it was broken, please scotch-tape it) ➤ Check whether the screen is displayed in VCR Only Channel. Press [OUTPUT] button in this remote controller to adjust in "General Broadcast" condition. ➤ Is the rounded line (RF cable) connected in "ANT.IN" terminal?
• Once pressing [REC], a videotape is ejected automatically.	➤ Please check whether the clock is right. ➤ Does the display on your video show "┐" (Ready to timer recording)? Please make it out. ➤ Please check whether the timer recording info is right. ➤ Please check a tab on a tape whether it is broke or not. (If it was broken, please scotch-tape it)
• Timer recording of Cable TV does not work.	➤ Was a cable data output code connected correctly? ➤ Were a converter manufacturer setup and output channel right? ➤ Did you enter a password? (Please cancel it.) ➤ Did you turn off your player? (Please turn it on.)
• In spite of pressing [CHANNEL], a channel can not be set.	➤ You may not memorize channels. ➤ Please check your channel setting or press a number button.
• While duplicating, screen is not clean and distorted.	➤ Some tapes or discs distributed in the market for lending is set to prevent copy in manufacturing. These tapes cannot be duplicated in a good condition.
• remote control does not work.	➤ Battery may be weak or exhausted. ➤ A receiver of remote control may be different with a sender.
• Buttons on remote control do not work.	➤ In case a videotape is positioned in the beginning, "VISS REW" and "REW" do not work. ➤ In case a videotape is positioned in the end, "FF", "VISS FF", "PLAY" and "REC" do not work. ➤ Please check whether another button is pressed.
• VISS index search does not work.	➤ Are you playing a tape that is not recorded in this recorder? (Try to record it with the recorder.) ➤ You may start recording it in "REC-PAUSE". Please start recording it from stop condition.
• Cable broadcasting can not be selected.	➤ Please select "CABLE" not "NETWORK" from the "CHANNEL SETTING".

# Specifications

Power	AC 120V, 60Hz	
Consumed electricity	24W (supplementary 4W)	
Weight	4.6kg	
Dimension (WxHxD)	435mm x 93mm x 255mm	
Operative temperature	+5°C-35°C	
Installation condition	Horizontal / Relative humidity under 80%	
Received channels	VHF: 2-13 CH / UHF: 14-69 CH / Cable: 1-125	
Signal type	NTSC COLOR	
Antenna Input/output	U/V-mixed: 75Ω unbalanced	
VIDEO input	1.0 Vp-p unbalanced, RCA JACK	
AUDIO input	-8.8dBm, RCA JACK	
VHF output	3 or 4 CH	
VIDEO output (common use of DVD and VCR)	VIDEO output terminal, 1.0 Vp-p unbalanced, RCA JACK	
VIDEO output (DVD only)	S-VIDEO output (75Ω In load Y: 1.0Vp-p, C:0.286Vp-p) COMPONENT output (75Ω In load Y: 1.0Vp-p, Pb:0.7Vp-p, Pr:0.7Vp-p)	
AUDIO output (common use of DVD and VCR)	Audio output terminal (2 kinds): -8.8dBm(VCR), 2.0Vrms(DVD), RCA JACK	
AUDIO output (DVD only)	Analogue AUDIO output (2 CH): 2.0Vrms Digital audio output (COAXIAL)	
Playable tape	Very high dense tapes with VHS marks	
Playable disc	DVD, VIDEO-CD, CD (12mm), CD (8mm), MP3, CD-R, CD-RW	
Tape speed	SP: 33.35mm/s, SLP: 11.12mm/s	
Playtime	SP: 2hrs, SLP: 6hrs (use of T-120 tape)	
Clock display	12 hrs AM/PM	
Time Recording	8 programs a year	
VIDEO S/N (VCR)	Over 45dB(Standard recording)	
Resolution	VCR	Over 220 lines (Standard recording)
	DVD	Over 500 lines (DVD Disc PLAY)
AUDIO (VCR)	Over 69dB (Hi-Fi), over 40dB (Mono)	
AUDIO (DVD)	90dB	
AUDIO dynamic range	90dB	

## DVD Audio output standards

Output	Disc type		
	DVD	VIDEO-CD	CD
Analogue Audio output	48/96KHz sampling	44.1KHz sampling	44.1KHz sampling
Digital Audio output	48KHz sampling	44.1KHz sampling	44.1KHz sampling

# Warranty

DEAM (Daewoo Electronics America) warrants each new electronic product manufactured by it to be free from defective material and workmanship and agrees to remedy any such defect or to furnish a new part (at the Company's option) in exchange for any part of any unit of its manufacture which under normal installation, use and service disclosed such defect, provided the unit is delivered by the owner to us or to our authorized distributor from whom purchased or authorized service station intact, for our examination with all transportation charges prepaid to our factory. To establish and receive warranty service at our factory or authorized service facilities, proof of purchase/dated sales invoice is required. Written authorization must be obtained before any merchandise is returned to the factory.

This warranty does not extend to any of our electronic products which have been subjected to misuse, neglect, accident, incorrect wiring not our own, improper installation, unauthorized modification, or used in violation of instructions furnished by us, nor units which have been repaired or altered outside of our factory, nor to cases where the serial number thereof has been removed, defaced or changed.

This warranty is in lieu of all warranties expressed or implied and no representative or person is authorized to assume for us any other liability in connection with the sale of our electronic products.

## Over-the-counter exchange of initially defective units

A unit is described as initially defective when the dealer opens the unit and finds that it is inoperative or a customer opening a new unit finds that it is initially defective. This unit may be returned to the factory by the dealer for exchange. Under no circumstances will a customer be permitted to return an initially defective unit directly to the factory.

Model	Parts	Labor
DV6T834N/DV6T834B/DV6T844N/DV6T844B /DV6T534N/DV6T534B/DV6T544N/DV6T544B	1 Year	3 months



This instrument is listed by Underwriter's Laboratories, Inc. It is designed and manufactured to meet rigid U.L. safety standards against X-radiation, fire, casualty and electrical hazards.

## Daewoo Electronics America Inc.

120 Chubb Ave,  
Lyndhurst, NJ 07071 USA

For more information about this or other  
Daewoo products, call 1-800-DAEW008.