

DAEWOO 
ELECTRONICS





DVD Recorder

DVR065

User Manual

Important Safeguards

	CAUTION RISK OF ELECTRIC SHOCK DO NOT OPEN	
<p>CAUTION: TO REDUCE THE RISK OF ELECTRIC SHOCK, DO NOT REMOVE COVER (OR BACK). NO USER-SERVICEABLE PARTS INSIDE. REFER SERVICING TO QUALIFIED SERVICE PERSONNEL.</p>		



The lightning flash with arrowhead symbol, within an equilateral triangle, is intended to alert the user to the presence of uninsulated 'dangerous voltage' within the product's enclosure that may be of sufficient magnitude to constitute a risk of electric shock.



The exclamation point within an equilateral triangle is intended to alert the user to the presence of important operating and servicing instructions in the literature accompanying the appliance.

WARNING TO REDUCE THE RISK OF FIRE OR ELECTRIC SHOCK, DO NOT EXPOSE THIS APPLIANCE TO RAIN OR MOISTURE.

CAUTION TO PREVENT ELECTRIC SHOCK, MATCH WIDE BLADE OF PLUG TO WIDE SLOT, FULLY INSERT.
ATTENTION POUR ÉVITER LES CHOC ÉLECTRIQUES, INTRODUIRE LA LAME LA PLUS LARGE DE LA FICHE DANS LA BORNE CORRESPONDANTE DE LA PRISE ET POUSSER JUSQU'AU FOND.

WARNING:

Do not install this equipment in a confined space such as a bookcase or similar unit.

NOTE TO CABLE/TV INSTALLER:

This reminder is provided to call the cable TV system installer's attention to Article 820-40 of the National Electric Code (U.S.A.). The code provides guidelines for proper grounding and, in particular, specifies that the cable ground shall be connected to the grounding system of the building, as close to the point of the cable entry as practical.

CLASS 1	LASER PRODUCT
KLASSE 1	LASER PRODUKT
LUOKAN 1	LASER LAITE
KLASS 1	LASER APPARAT
CLASSE 1	PRODUIT LASER

CAUTION:

This DVD Recorder employs a Laser System. To ensure proper use of this product, please read this owner's manual carefully and retain for future reference. Should the DVD Recorder require maintenance, contact an authorized service center. Use of controls, adjustments, or the performance of procedures other than those specified herein may result in hazardous radiation exposure. To prevent direct exposure to laser beam, do not try to open the enclosure. Visible laser radiation when open. DO NOT STARE INTO BEAM.

CAUTION:

The apparatus should not be exposed to water (dripping or splashing) and no objects filled with liquids, such as vases, should be placed on the apparatus.

FCC WARNING:

This equipment may generate or use radio frequency energy. Changes or modifications to this equipment may cause harmful interference unless the modifications are expressly approved in the instruction manual. The user could lose the authority to operate this equipment if an unauthorized change or modification is made.

REGULATORY INFORMATION: FCC Part 15

This product has been tested and found to comply with the limits for a Class B digital device, pursuant to Part 15 of the FCC Rules. These limits are designed to provide reasonable protection against harmful interference when the product is operated in a residential installation. This product generates, uses, and can radiate radio frequency energy and, if not installed and used in accordance with the instruction manual, may cause harmful interference to radio communications. However, there is no guarantee that interference will not occur in a particular installation. If this product does cause harmful interference to radio or television reception, which can be determined by turning the product off and on, the user is encouraged to try to correct the interference by one or more of the following measures:

- Reorient or relocate the receiving antenna.
- Increase the separation between the product and receiver.
- Connect the product into an outlet on a circuit different from that to which the receiver is connected.
- Consult the dealer or an experienced radio/TV technician for help.

FCC COMPLIANCE:

The responsible party for this product's compliance is: GoVideo, 7835 East McClain Drive, Scottsdale, AZ 85260, USA.

SERIAL NUMBER:

The serial number is found on the back of the DVD Recorder. This number is for this unit only. You should record requested information here and retain this guide as a permanent record of your purchase.

Model No. _____

Serial No. _____

IMPORTANT SAFETY INSTRUCTIONS

CAUTION: PLEASE READ AND OBSERVE ALL WARNINGS AND INSTRUCTIONS IN THIS OWNER'S MANUAL AND THOSE MARKED ON THE PRODUCT. RETAIN THIS MANUAL FOR FUTURE REFERENCE.

This product has been designed and manufactured to assure personal safety. Improper use can result in electric shock or fire hazard. The safeguards incorporated in this product will protect you if you observe the following procedures for installation, use, and servicing.

This product does not contain any parts that can be repaired by the user.

DO NOT REMOVE THE CABINET COVER, OR YOU MAY BE EXPOSED TO DANGEROUS VOLTAGE. REFER SERVICING TO QUALIFIED SERVICE PERSONNEL ONLY.

- | | |
|--|--|
| <p>1 Read these instructions.
All these safety and operating instructions should be read before the product is operated.</p> <p>2 Keep these instructions.
The safety, operating and use instructions should be retained for future reference.</p> | <p>3 Heed all warnings.
All warnings on the product and in the operating instructions should be adhered to.</p> <p>4 Follow all instructions.
All operating and use instructions should be followed.</p> |
|--|--|

5 Do not use this product near water.

For example: near a bath tub, wash bowl, kitchen sink, laundry tub, in a wet basement; or near a swimming pool; and other areas located near water.

6 Clean only with dry cloth.

Unplug this product from the wall outlet before cleaning. Do not use liquid cleaners.

7 Do not block any ventilation openings. Install in accordance with the manufacturer's instructions.

Slots and openings in the cabinet are provided for ventilation and to ensure reliable operation of the product and to protect it from overheating. The openings should never be blocked by placing the product on a bed, sofa, rug or other similar surface. This product should not be placed in a built-in installation such as a bookcase or rack unless proper ventilation is provided or the manufacturer's instructions have been adhered to.

8 Do not install near any heat sources such as radiators, heat registers, stoves, or other apparatuses (including amplifiers) that produce heat.**9 Make sure that rating of your household electricity supply matches that shown on the back of your product.****10 Protect the power cord from being walked on or pinched particularly at plugs, convenience receptacles, and the point where they exit from the product.****11 Only use attachments/accessories specified by the manufacturer.****12 Use only with the cart, stand, tripod, bracket, or table specified by the manufacturer, or sold with apparatus. When a cart is used, use caution when moving the cart/ product combination to avoid injury from tip-over.****13 Unplug this product during lightning storms or when unused for long periods of time.****14 Refer all servicing to qualified service personnel. Servicing is required when the product has been damaged in any way, such as: Power-supply cord or plug is damaged; liquid has been spilled or objects have fallen into the product; the product has been exposed to rain or moisture, does not operate normally, or has been dropped.****15 Do not connect the product to the power supply if you have just moved it from a cold environment to a warm room. This can lead to condensation inside the product, which can damage it. Wait for approximately 2 hrs for it to reach room temperature.****16 Make sure the product is placed at least 4 inches (10 cm) apart from other home appliances or obstacles to ensure sufficient ventilation.****17 This product is designed to work continuously. Switching it off does not disconnect it from the power outlet. To disconnect it from the power outlet you have to unplug it.****18 The disconnect device shall remain readily operable.**

Table of Contents

INTRODUCTION

<i>Important Safeguards</i> _____	<i>i</i>
<i>Table of Contents</i> _____	<i>1</i>
<i>Overview</i> _____	<i>2</i>
<i>Identification of Controls</i> _____	<i>6</i>

CONNECTIONS

<i>Connecting Antenna/Cable</i> _____	<i>11</i>
<i>Connecting a TV</i> _____	<i>12</i>
<i>Connecting an Amplifier/Receiver</i> _____	<i>13</i>
<i>Connecting Optional Equipment</i> _____	<i>14</i>
<i>Connecting a Digital Camcorder</i> _____	<i>14</i>

SETUP

<i>Initial Installation</i> _____	<i>15</i>
<i>Initial Setup</i> _____	<i>17</i>
Setup Menu Overview	17
INSTALLATION Settings	17
RECORDING OPTIONS Settings	20
LANGUAGE Settings	21
PREFERENCE / Video Settings	22
PREFERENCE / Audio Settings	23
PREFERENCE / Parental Controls	24
Various PREFERENCE Settings	26
System Information	27
Restore Defaults	27
<i>On-Screen Display Overview</i> _____	<i>28</i>

PLAYBACK

<i>DVD Playback</i> _____	<i>31</i>
<i>Other Disc Playback</i> _____	<i>35</i>

RECORDING

<i>Basic Recording</i> _____	<i>37</i>
Recording from TV	37
One Touch Record (OTR)	38
Checking the Recording Time	38
To Pause the Recording	38
<i>Timer Recording</i> _____	<i>39</i>
<i>Recording from an External Input</i> _____	<i>41</i>

DISC OPERATION

<i>Disc Initialize</i> _____	<i>43</i>
<i>Disc Operation in DVD±RW disc</i> _____	<i>43</i>
<i>Disc Operation in DVD±R, DVD-RW disc</i> _____	<i>45</i>

DISC EDIT

<i>Title Menu</i> _____	<i>46</i>
-------------------------	-----------

REFERENCE

<i>Troubleshooting</i> _____	<i>49</i>
<i>Technical Specifications</i> _____	<i>52</i>

Overview

DVD, DVD+R, DVD+RW?

What is a DVD?

DVD (Digital Versatile Disc) is a storage medium that combines the convenience of the compact disc with the latest digital video technology. DVD video uses modern MPEG2 data compression technology that enables an entire feature film to be stored on a single five inch disc.

How good is the resolution of DVD compared with VHS?

The razor-sharp digital images have more than 500 lines of resolution at 720 pixels per line. This is more than twice as high as VHS and even better than laser disc quality. DVD picture quality is easily comparable to the digital masters produced in recording studios.

What is a DVD+RW?

DVD+ReWritable uses 'phase change' media, the same technology on which rewritable CDs are based. A high-performance laser is used to change the reflective properties of the recording layer; this process can be repeated more than a thousand times.

What is a DVD+R?

Unlike a DVD+RW disc, a DVD+R (write-once DVD) can only be written to once. If it is not finalized after a recording, further recordings can be added to it. Old recordings can be deleted but they can no longer be overwritten. The deleted recordings (titles) are marked 'deleted title'.

Before a DVD+R can be played in a DVD player, it must be finalized in the DVD Recorder. Once this process is complete, no further recordings can be added.

What can I do with my DVD Recorder?

Your DVD Recorder is a machine for recording and playing back digital video discs with 'two-way' compatibility with the universal DVD video standard. This means:

- existing DVD video discs can be played on the recorder.
- recordings made on your DVD Recorder can be played on other DVD video players and DVD-ROM drives.

Dual Media

Supporting Disc	±RW / ±R
Recording Format	±Disc + VR format
Finalize	-RW, -R, +R
After finalize other DVD playback	All disc can playback
Consumer	Does not need selection (recording format)
Remark :	

A DVD Recorder that supports 'dual media' recording allows DVD+RW format recording (+VR) on either DVD-R, DVD-RW, DVD+R or DVD+RW media. Any editing feature that is available with the +RW logical format is available on any of the media types. This system allows the flexibility for the consumer to use any of the above media formats for recording in the same system. Since the +VR format is DVD-Video compatible, the consumer can take any disk recorded on this platform and should be capable of playing it back on the majority of DVD players on the market.

Regional code



If the region number on your DVD disc does not correspond to the region number of this player, the disc cannot be played.

Which discs you can use

The following discs can be used in your DVD Recorder:

Playback and recording

DVD+RW (Digital Versatile Disc + ReWritable)
 DVD-RW (DVD-Rerecordable)
 DVD+R (Digital Versatile Disc + Write-Once)
 DVD-R (DVD-Recordable)

Playback only

DVD Video (Digital Versatile Disc)
 Audio CD (Compact Disc Digital Audio)
 CD-R (CD recordable) Audio/ CD-RW (CD rewritable) Audio
 Video Format : JPEG
 Audio Format : CDDA / MP3



Not all recordable CDs may be played by your player.

Disc-related Terms

Title (DVD only)

The main film, accompanying feature content, or music album. Each title is assigned a title reference number enabling you to locate it easily.

Chapter (DVD only)

Sections of a movie or a musical piece that are smaller than titles. A title is composed of one or several chapters. Each chapter is assigned a number to enable you to easily locate the chapter you want. Depending on the disc, chapters may not be labeled.

Track (Audio CD only)

Sections of a movie or a musical piece on an audio CD. Each track is assigned a number, enabling you to easily locate the track you want.

About DVD Recording

Notes on Recording

- The recording times shown are not exact because the DVD Recorder uses variable bit-rate video compression. This means that the exact recording time will depend on the material being recorded.
- When recording a TV broadcast, if the reception is poor or the picture contains interference, the recording times may be shorter.
- Discs recorded at high speeds (equal to or greater than 2X) may not be recognized.
- If you record still pictures or audio only, the recording time may be longer.
- The displayed times for recording and time remaining may not always add up to the exact length of the disc.
- The available recording time may decrease if you heavily edit a disc.
- When using a DVD+R disc, you can keep recording until the disc is full, or until you finalize the disc. Before you start a recording session, check the amount of recording time left on the disc.

Recording TV Audio Channels

The DVD Recorder can record one or two channel audio. For TV broadcasts, this usually means mono or stereo, but some programs are broadcast with a main and a SAP (Secondary Audio Program) audio channel. You can record either the main audio or the SAP audio.

Restrictions on Video Recording

- You cannot record copy-protected video using this DVD Recorder. Copy-protected video includes DVD-Video discs and some satellite broadcasts. If copy-protected material is encountered during a recording, recording will pause or stop automatically and an error message will be displayed on-screen.
- Video that is 'copy-once only' can only be recorded using DVD+RW discs with CPRM.

Copyright Notice

- Audio and video recordings you make using the DVD Recorder are for your personal use only. You may not sell, lend, or rent them to other people.
- This product incorporates copyright protection technology that is protected by method claims of certain U.S. patents and other intellectual property rights owned by Macrovision Corporation and other rights owners. Use of this copyright protection technology must be authorized by Macrovision Corporation, and is intended for home and other limited viewing uses only unless otherwise authorized by Macrovision corporation. Reverse engineering or disassembly is prohibited.

Precautions

Handling the Unit

When shipping the unit

The original shipping carton and packing materials come in handy. For maximum protection, re-pack the unit as it was originally packaged at the factory.

When setting up the unit

The picture and sound of a nearby TV, VCR, or radio may be distorted during playback. In this case, position the unit away from the TV, VCR, or radio, or turn off the unit after removing the disc.

To keep the surface clean

Do not use volatile liquids, such as insecticide spray, near the unit. Do not leave rubber or plastic products in contact with the unit for a long period of time. They will leave marks on the surface.

Cleaning the Unit

To clean the cabinet

Use a soft, dry cloth. If the surfaces are extremely dirty, use a soft cloth lightly moistened with a mild detergent solution. Do not use strong solvents such as alcohol, benzene, or thinner, as these might damage the surface of the unit.

To obtain a clear picture

The DVD Recorder is a high-tech, precision device. If the optical pick-up lens and disc drive parts are dirty or worn, the picture quality will be poor. Regular inspection and maintenance are recommended after every 1,000 hours of use. (This depends on the operating environment.) For details, please contact your nearest dealer.

Remote Control Operation Range

Point the remote control at the remote sensor and press the buttons.

Distance: Within 23 ft (7 m) of the remote sensor.

Angle: Within 30° in each direction of the remote sensor.

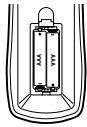
Remote Control Battery Installation

Detach the battery cover on the rear of the remote control, and insert two AAA batteries. Make sure the polarities (+ and -) are aligned correctly.

**Caution**

Do not mix old and new batteries. Never mix different types of batteries (standard, alkaline, etc.).

Notes on Discs**Handling Discs**

Do not touch the playback side of the disc. Hold the disc by the edges so that fingerprints will not get on the surface. Do not stick paper or tape on the disc.

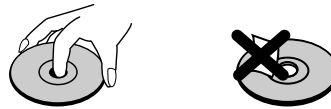
**Storing Discs**

After playing, store the disc in its case.

Do not expose the disc to direct sunlight or sources of heat, or leave it in a parked car exposed to direct sunlight, as there may be a considerable temperature increase inside the car.

Cleaning Discs

Fingerprints and dust on the disc can cause poor picture quality and sound distortion. Before playing, clean the disc with a clean cloth. Wipe the disc from the center outward.

Do not use strong solvents such as alcohol, benzene, thinner, commercially available cleaners, or anti-static spray intended for older vinyl records.

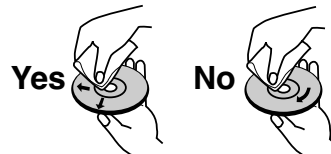
**About Symbols****About the  Symbol**

'■ 5 ■

Identification of Controls

Front Panel

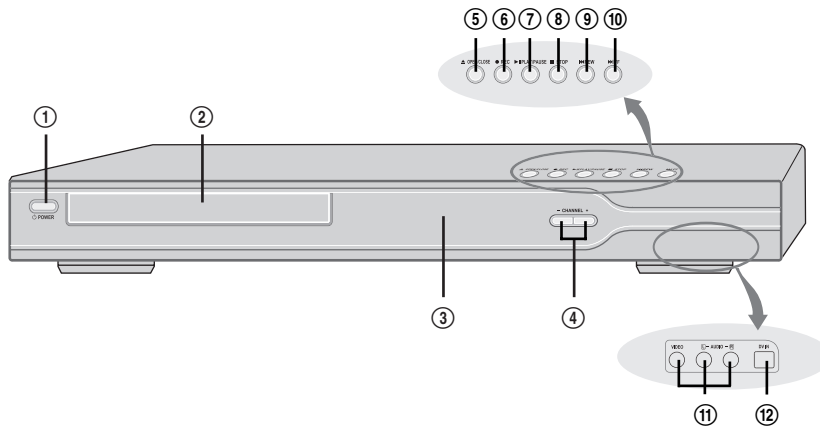

① **POWER (STANDBY/ON)**

Turns the DVD Recorder on and off.

② **Disc Tray (DVD deck)**

Insert a disc here.

③ **Front Panel Display**

Shows the current status of the DVD Recorder.

④ **CH+/-**

Scans up or down through memorized channels. Also moves up and down in DVD navigation menus.

⑤ **OPEN/CLOSE**

Opens or closes the disc tray.

⑥ **REC**

Starts recording. Press repeatedly to set the recording time.

⑦ **PLAY/PAUSE**

Starts playback of a disc. Pauses playback or recording temporarily.

⑧ **STOP**

Stops playback.

⑨ **PREV**

Skips to previous chapter.

⑩ **NEXT**

Skips to next chapter.

⑪ **LINE1 (VIDEO, L-AUDIO-R)**

Connects to the audio/video output of an external source (VCR, Camcorder, etc.).

⑫ **DV IN**

Connects to the DV output of an external source (VCR, Camcorder, etc.).

Front Panel Display

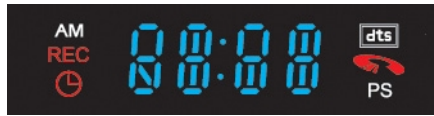

Channel

CH23 TV Channel C123 CATV Channel

Input mode

AW-1 AV1 input AW-2 AV2 input
 DW DV input

Recording on disc

11:15 ^{dts} PS Indicates a DVD Timer recording is set. 11:15 ^{dts} PS Indicates a DVD Timer Recording is in standby mode.
 REC 11:15 ^{dts} PS Indicates the DVD is recording. REC 0:30 ^{dts} PS OTR Recording mode
 REC RECP ^{dts} PS Recording Pause mode

Others

SAFE Indicates when the DVD Recorder is locked.
 TV Indicates the DVD Recorder is in TV mode (set by [TV/DVD] button).
 I-S Indicates when the DVD Recorder+ VCR is outputting the video signal in Interlaced Scan mode. P-S Indicates when the DVD Recorder+ VCR is outputting the video signal in Progressive Scan mode.
^{dts} Indicates the dts title is playing.

Remote Control

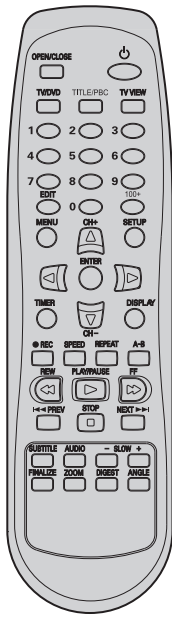





-  Turns the DVD Recorder on and off.

-  Opens and closes the disc tray in DVD mode.

-  Switches between the DVD Recorder tuner and your TV tuner.

-  Displays a disc's Title menu, if available.

-  Switches the DVD Recorder input to TV tuner, Line 1, Line 2, or DV.

-  - Selects numbered options in menus.
-  - Selects TV channels.
-  - Manually adjust tracking.



-  Displays the edit menu for DVD+RW/+R discs or sets a chapter marker.

-  Accesses DVD disc menus.

-  Displays or exits the Setup menu.

-  Displays the Timer Recording menu.

-  Displays information about the currently loaded disc or TV channel.

-  - ◀▶▲▼ : Selects menu options.
-  - CH(+/-) : Selects channels.



-  Confirms menu selections.

-  Starts recording. Press repeatedly to set the recording time. For more details, Refer to One Touch Record (OTR) on page 39.

-  Selects Recording mode: - Approx 1 Hour (HQ mode), 2 Hours (SP mode), 4 Hours (EP mode), 8 Hours (SEP mode)

-  Repeats the current chapter, track, title or the entire disc.

-  Repeats playback between two points (A and B).

-  - Starts playback.
-  - Pauses playback or recording temporarily. Press again to exit Pause mode.

-  Searches backward/forward.

-  Stops playback or recording.

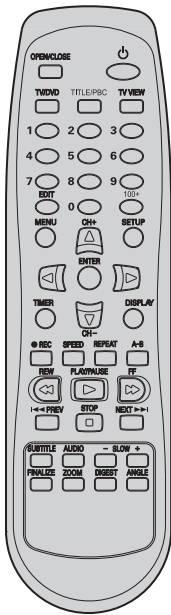

Skips to the next or previous chapter/track.

Selects a subtitle language, if available.

Selects an audio language (DVD), audio channel (CD) or audio type (TV).

Increases or decreases the slow motion speed when playing a DVD.

Displays the finalize menu for DVD+R discs.

Enlarges the DVD video image.

Displays the digest menu for DVD+RW/+R discs.

Selects a DVD camera angle, if available.

Rear panel

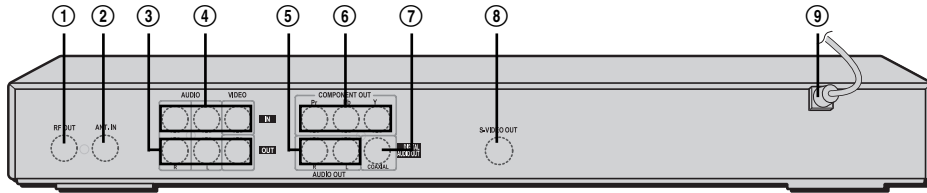

- ① **RF OUT (TO TV)**
Connect to a TV with an RF coaxial input.
- ② **RF IN (FROM ANT.)**
Connect to your antenna or cable TV outlet.
- ③ **AV OUT (VIDEO, L-AUDIO-R)**
Connect to a TV with video and audio inputs.
- ④ **LINE2 (VIDEO, L-AUDIO-R)**
Connect to the audio/video outputs of an external source (VCR, Camcorder, etc.).
- ⑤ **AUDIO OUT (L-AUDIO-R)**
Connect to other equipment with audio inputs.
- ⑥ **COMPONENT/PROGRESSIVE VIDEO OUT (Y Pb Pr)**
Connect to a TV with Component Video (Y Pb Pr) inputs.
- ⑦ **COAXIAL (Digital Audio Out)**
Connect to an amplifier with a coaxial digital audio input.
- ⑧ **S-VIDEO OUT**
Connect to a TV with an S-Video Input.
- ⑨ **AC Power Cord**
Plug into a power outlet.



Caution

Do not touch the inner pins of the jacks on the rear panel. Electrostatic discharge may cause permanent damage to the DVD Recorder.

Connections

INTRODUCTION

CONNECTIONS



- There are a variety of ways to connect the DVD Recorder to your TV and other equipment. Use only one of the connections described below. Whichever TV connection you use will work with all input sources.
- Please refer to the manuals for your TV, VCR, stereo system, or other devices as necessary to make the best connections.
- For better sound reproduction, connect the DVD Recorder's AUDIO OUT jacks to the audio in jacks of your amplifier, receiver, stereo, or audio/video equipment. See 'Connecting an Amplifier/Receiver' on page 13.



Caution

- Make sure the DVD Recorder is connected directly to the TV, and the TV is set to the correct video input.
- Do not connect the DVD Recorder's AUDIO OUT jack to the phono in jack (record deck) of your audio system.
- Do not connect the DVD Recorder via your VCR. The DVD image could be distorted by the copy protection system.

Connecting Antenna/Cable

- 1 Disconnect the antenna/cable from the rear of your TV.
- 2 Connect this cable to the jack marked ANT IN (FROM ANT.) on the rear panel of the DVD Recorder.

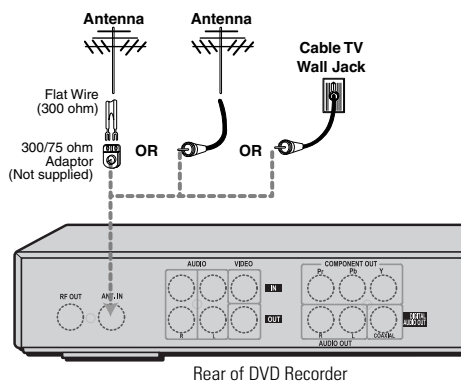

Cable Service Without Cable Box

If your cable wire is connected to your TV without a converter or descrambler box, unscrew the wire from your TV and attach it to the ANT IN (FROM ANT.) jack on the rear panel of the DVD Recorder.

Use the supplied coaxial cable to connect between the DVD Recorder's OUT (TO TV) jack and the antenna input jack on your TV. With this connection, you can receive all midband, superband, and hyperband channels (all cable channels).

Cable Service With Cable Box

If a cable box is required in your cable system, follow the instructions shown at right. This hookup permits both TV and DVD Recorder operation.

To view or record a CATV channel:

- 1 Tune the TV to the correct video input channel.
- 2 Set the DVD Recorder to the output channel of the cable box using the [CH ▲/▼] or the [0-9] buttons on your DVD Recorder (e.g., CH3).
- 3 Select the channel you wish to view on the cable box.

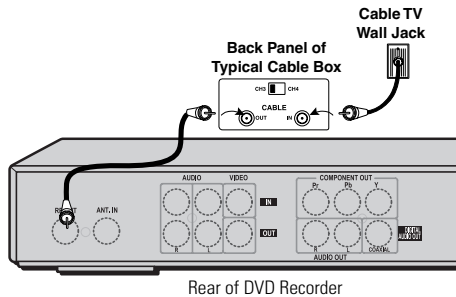

If you are using a cable box to tune channels, it is not necessary to run Auto Channel Search as indicated on page 18.

Connecting a TV

Choose one of the following TV connections, depending on the capabilities of your equipment.

 **All video signals are available from all video outputs.** That means that whichever TV connection you use, it will work with all input sources, including VHS out of the Component/Progressive Video Output.

RF Coaxial Connection

Connect the RF OUT (TO TV) jack on the DVD Recorder to the antenna in jack on your TV using the supplied coaxial cable (R). If you use this connection, tune your TV to the DVD Recorder's RF output channel (CH 3 or 4).

How to set the DVD Recorder's RF output channel

Press [SETUP] → Installation → Modulator Out to change the RF out channel. For details refer to page 18.

Audio/Video Connection

- 1 Connect the VIDEO OUT jack on the DVD Recorder to the video in jack on your TV using the supplied video cable (V).
- 2 Connect the Left and Right AUDIO OUT jacks from the DVD Recorder to the left/right audio in jacks on your TV using the supplied audio cables (A).

S-Video Connection

- 1 Connect the S-VIDEO OUT jack on the DVD Recorder to the S-Video in jack on your TV using an S-Video cable (S).
- 2 Connect the Left and Right AUDIO OUT jacks from the DVD Recorder to the left/right audio in jacks on your TV using the supplied audio cables (A).

Component Video Connection

- 1 Connect the COMPONENT/PROGRESSIVE VIDEO OUT jacks on the DVD Recorder to the corresponding input jacks on your TV using a Y Pb Pr cable (C) if the Component Video jacks (Y, Pb, Pr) are available on your TV.
- 2 Connect the Left and Right AUDIO OUT jacks from the DVD Recorder to the left/right audio in jacks on your TV using the supplied audio cables (A).

Progressive Scan Connection

- If your television is a high-definition or 'digital ready' television, you may take advantage of the DVD Recorder's Progressive Scan output for the highest video resolution possible.
- If your TV does not accept the Progressive Scan format, the picture will appear scrambled.

- 1 Connect the COMPONENT/PROGRESSIVE VIDEO OUT jacks on the DVD Recorder to the corresponding in jacks on your TV using an optional Y Pb Pr cable (C).
- 2 Connect the Left and Right AUDIO OUT jacks from the DVD Recorder to the left/right audio in jacks on your TV using the supplied audio cables (A).

-  Be sure to set the DVD Recorder to Progressive Scan mode by pressing and holding [P.SCAN] for 3 seconds (or changing the Scan Mode in the Setup Menu; see page 21).
- Progressive Scan does not work with the RF, Audio/Video or S-Video connections.

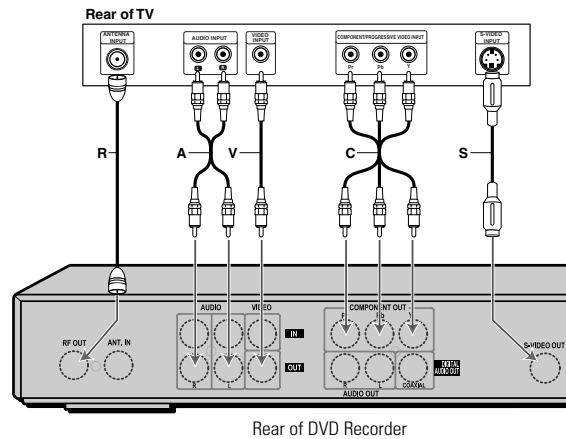

Connecting an Amplifier/Receiver

Connecting to an amplifier equipped with two channel analog stereo or Dolby Pro Logic II/Pro Logic

Connect the Left and Right AUDIO OUT jacks on the DVD Recorder to the left and right audio in jacks on your amplifier, receiver, or stereo system, using the supplied audio cables (A).

Connecting to an amplifier equipped with two channel digital stereo (PCM) or to an Audio/Video receiver equipped with a multi-channel decoder (Dolby Digital™, MPEG 2, or DTS)

- 1 Connect the DVD Recorder's DIGITAL AUDIO OUT jack (COAXIAL X) to the corresponding in jack on your amplifier. Use an optional digital coaxial audio cable.
- 2 You will need to activate the DVD Recorder's digital output; see 'AUDIO Settings' on page 22.

Digital Multi-Channel Sound?

A digital multi-channel connection provides the best sound quality. For this you need a multi-channel audio/video receiver that supports one or more of the audio formats supported by your DVD Recorder (MPEG 2, Dolby Digital, and DTS). Check the receiver manual and the logos on the front of the receiver.



- Due to the DTS Licensing agreement, the digital output will be in DTS digital out when DTS audio stream is selected.



- If the audio format of the digital output does not match the capabilities of your receiver, the receiver will produce a strong, distorted sound or no sound at all.
- 5.1 channel digital surround sound via the digital connection can only be obtained if your receiver is equipped with a digital multi-channel decoder.
- To see the audio format of the current DVD on the on-screen display, press [AUDIO].

The DVD Recorder does not perform internal (2-channel) decoding of DTS sound tracks. To enjoy DTS multi-channel surround, you must connect the DVD Recorder to a DTS compatible receiver via one of the DVD Recorder's digital audio outputs.

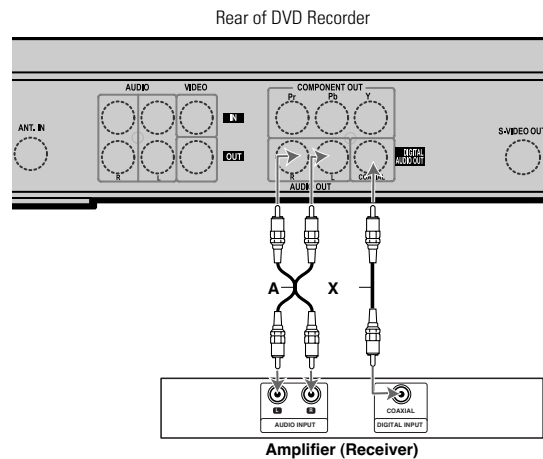

Connecting Optional Equipment

To receive audio/video signals from other equipment, connect the LINE1 or LINE2 jacks on the DVD Recorder to the audio/video out jacks on your external component, using optional audio/video cables.

Jack Panel of Accessory Component (VCR, Camcorder, etc.)

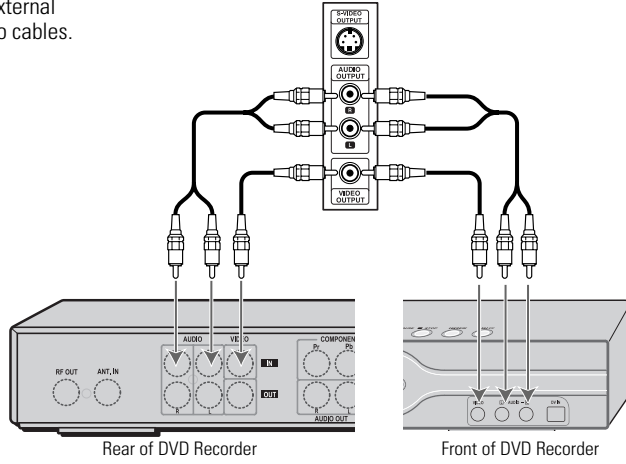

Connecting a Digital Camcorder

Using the front panel DV IN jack, it is possible to connect a DV digital camcorder, video deck or DVD+R/RW recorder and digitally transfer DV tapes or DVD+R/RW discs to DVD+R/RW.

Use a DV cable (not supplied) to connect the DV In/Out jack of your DV camcorder/video deck to the front panel DV IN jack of the DVD Recorder.

 This jack is for connection to DV equipment only. It is not compatible with digital satellite tuners or D-VHS video decks.

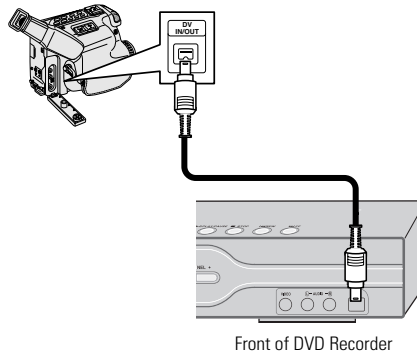

Initial Installation

Initial Installation

After successfully connecting your DVD Recorder to your TV and other devices, this chapter will show you how to complete the initial installation.

 You must follow the initial installation process to set the time, date, channels, and language preferences for the DVD Recorder.

1 A 'Initial Setup Wizard' is displayed on the screen. Make sure the RF cable from your antenna or cable TV jack is connected.

2 Select the desired language for the on-screen menu using [▲/▼]. Press [ENTER] to confirm.

3 Select the desired disc menu language using [▲/▼]. Press [ENTER] to confirm.

4 Select the desired disc playback audio language using [▲/▼]. Press [ENTER] to confirm.

5 Select the desired disc playback subtitle language using [▲/▼]. Press [ENTER] to confirm.

6 Select the desired signal type using [▲/▼]. Press [ENTER] to confirm.

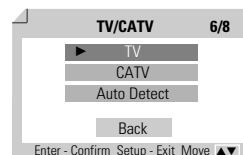
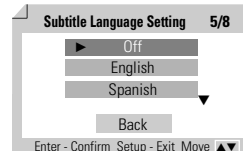
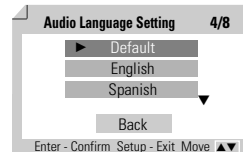
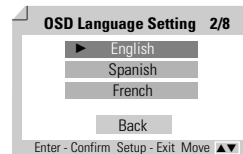
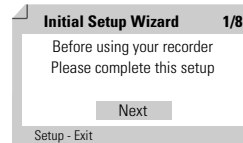

CONNECTIONS

SETUP

7 The DVD Recorder detects channels automatically and stores them in memory.

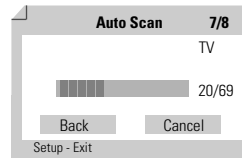

8 After finishing Auto Channel Search, set the clock.

9 Use [◀/▶] to move left/right and use [▲/▼] to change the settings.

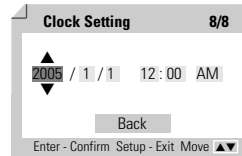

10 After setting the clock, press [ENTER] to confirm. If you cancel the process during Initial Installation, you should repeat this procedure.

Initial Setup

Setup Menu Overview

The DVD Recorder Setup menu includes four categories, including: Initial Setup, Disc Operation, Disc Edit and Timer Recording. Press [SETUP], [◀/▶] and [ENTER] on the remote control to view the first and second levels of the Setup menu.

1. Initial Setup Screen

go to page 17-27.

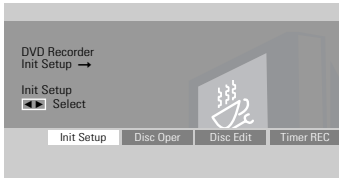

2. Disc Operation Screen

go to page 43-45.

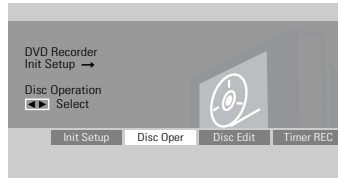

3. Disc Edit Screen

go to page 46-48.



4. Timer Recording Screen

go to page 39-40.

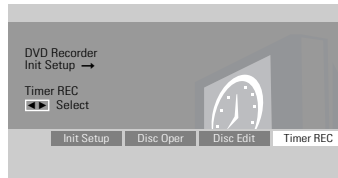

SETUP

INSTALLATION Settings

Tuning Band

- 1 Press [SETUP]. The Setup menu appears.
While 'Init Setup' is selected, press [ENTER] to go to the initial setup page.
- 2 Use [◀/▶] to select 'Installation Page'.
- 3 While 'Installation Page' is selected, press [▼] to select 'TV/CATV'.
- 4 Press [▶] to move to the second level.
- 5 Use [▲/▼] to select TV or CATV, then press [ENTER].

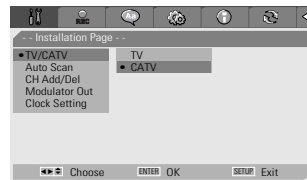

TV: If you are using a standard antenna to receive channels.

CATV: If you are using basic cable to receive channels.

i If you are receiving channels from a cable box or satellite receiver connected to the LINE1 or LINE2 inputs, there is no need to set Tuning Band or search for channels. Set the DVD Recorder to its LINE1 or LINE2 input and select the desired channel on your cable box or satellite receiver.

Auto Channel Search

The DVD Recorder has a frequency synthesized tuner capable of receiving up to 181 channels. These include VHF channels 2-13, UHF channels 14-69 and CATV channels 1-125.

Preparation:

Connect the DVD Recorder to the desired type of antenna or cable TV system, as shown in 'Connecting Antenna/Cable' on page 11.

- 1 Follow steps 1-2 as shown under Tuning Band.
- 2 While 'Installation Page' is selected, press [▲/▼] to select 'Auto Scan'.
- 3 Press [ENTER] to begin the channel search.

The tuner will automatically search for all available channels in your area and place them in the tuner's memory.

 After Auto Channel Search is complete, follow the instructions above to make sure that Tuning Band is set correctly (TV or CATV).

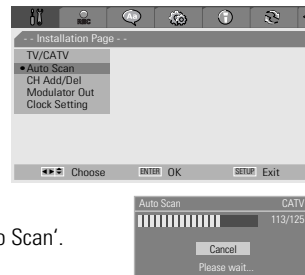

Add/Remove Channels

This feature allows you to manually add or delete channels from your channel list.

- 1 Follow steps 1-2 as shown under Tuning Band.
- 2 Use [▲/▼] to select 'CH Add/Del'.
- 3 Press [ENTER]. The Channel Add/Delete menu appears.
- 4 Use [CH+/-] or [0-9] to select a channel then toggle the add/delete selection by pressing [◀/▶].
- 5 Press [SETUP] to exit the Channel Add/Delete menu.

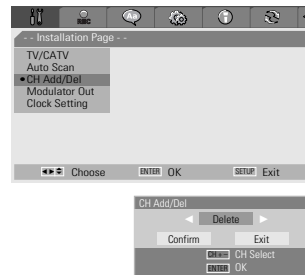

Modulator Out

This feature allows you to set the RF Output channel to your TV (you only need to set this if you are using the RF Out connection to your TV).

- 1 Follow steps 1-2 as shown under Tuning Band.
- 2 Use [▲/▼] to select 'Modulator Out'.
- 3 Press [▶] to move to the second level.
- 4 Use [▲/▼] to set the Modulator Out channel to 'CH3' or 'CH4'.
- 5 Press [ENTER] to confirm.

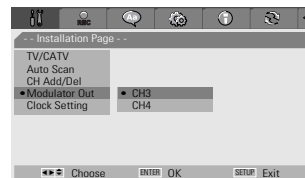

Set Clock

- 1 Follow steps 1-2 as shown under Tuning Band.
- 2 Use [▲/▼] to select 'Set Clock'.
- 3 Press [ENTER]. The Set Clock menu appears.
- 4 Enter the date and time.
 - ◀/▶ (left/right): Moves the cursor to the previous or next column.
 - ▲/▼ (up/down): Changes the setting at the current cursor position.
- 5 Press [ENTER] to confirm your setting, then press [SETUP] to exit the Setup menu.

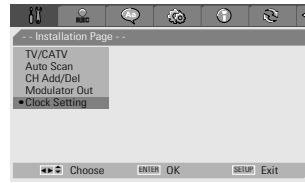

SETUP

RECORDING OPTIONS Settings

DVD Record Quality

You can set the default DVD recording quality to: HQ (High Quality - 1 hr/disc), SP (Standard Quality - 2 hrs/disc), EP (Extended Play - 4 hrs/disc) or SEP (Very Low Quality - 8 hrs/disc).

1 Press [SETUP]. The Setup menu appears.

While 'Init Setup' is selected, press [ENTER] to go to the initial setup page.

2 Use [◀/▶] to select 'Record Options Page' .

3 While 'Record Options Page'  is selected, press [▼] to select 'DVD Quality'.

4 Press [▶] to move to the second level.

5 Use [▲/▼] to select the desired Record Quality (**HQ**, **SP**, **EP** or **SEP**).

6 Press [ENTER] to confirm your selection, then press [SETUP] to exit the menu.

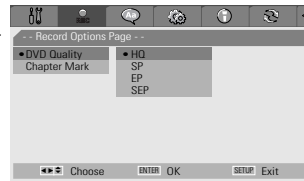

Auto Chapter

During recording, chapter markers are added automatically at fixed intervals.

You can set this interval to **5 Min**, **10 Min** or **15 Min**.

But when you set DVD Record quality "SEP", Auto Chapter interval could be set only '10 Min' or '15 Min'.

To turn off automatic chapter marking, select '**Off**'.

Follow the same procedure as the DVD Record Quality.

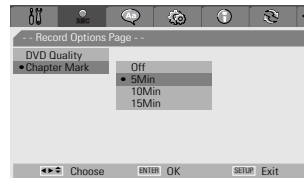

LANGUAGE Settings

OSD Language

Select a language for the DVD Recorder Setup menu and on-screen displays.

- 1 Press [SETUP]. The Setup menu appears.
While 'Init Setup' is selected, press [ENTER] to go to the initial setup page.
- 2 Use [◀] and [▶] to select 'Languages Page'.
- 3 While 'Language' is selected, press [▼] to select 'OSD Lang'.
- 4 Press [▶] to move to the second level.
- 5 Use [▲/▼] to select the desired language.
- 6 Press [ENTER] to confirm your selection, then press [SETUP] to exit the menu.



Menu/Subtitle/Audio Language

Select your preferred language for Disc Menus, Subtitles, and Audio soundtracks.



Default: The disc's default language is selected.

Follow the same procedure as the OSD Language.



SETUP

PREFERENCE / Video Settings

- 1 Press [SETUP]. The Setup menu appears.
While 'Init Setup' is selected, press [ENTER] to go to the initial setup page.
- 2 Use [◀/▶] to select 'Preference Page' .
- 3 While 'Preference Page'  is selected, press [▼] to select 'Video'.
- 4 Press [▶]. The 'Video' submenu is displayed.

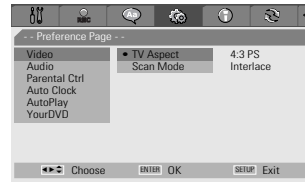

TV Aspect Ratio

- 1 Use [▲/▼] to select 'TV Aspect' while the 'Video' submenu is displayed.
- 2 Press [▶] to go to the second level.
- 3 Use [▲/▼] to select the desired TV Aspect.
- 4 Press [ENTER] to confirm your selection.
- 5 Press [SETUP] to exit the menu.

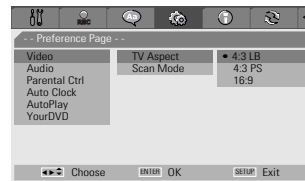

4:3 LB : Select when a standard 4:3 TV is connected. Displays theatrical images with masking bars above and below the picture.

4:3 PS : Select when a standard 4:3 TV is connected. Displays pictures cropped to fill your TV screen. Both sides of the picture are cut off.

16:9 : Select when a 16:9 wide screen TV is connected.

Scan Mode

Progressive Scan Video provides the highest picture quality with reduced flickering.

- If you are using the COMPONENT/PROGRESSIVE VIDEO OUT jacks, but are connecting the DVD Recorder to a standard (analog) television, set Scan Mode to **Interlace**.
- If you are using the COMPONENT/PROGRESSIVE VIDEO OUT jacks for connection to a TV or monitor that is compatible with a Progressive Scan signal, set Scan Mode to **Progressive**.

Follow the same procedure as TV Aspect Ratio to change the Scan Mode.

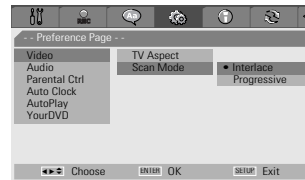

Caution

Once the Progressive Scan setting is entered, an image will only be visible on a Progressive Scan compatible TV or monitor.

PREFERENCE / Audio Settings

Follow the same procedure as Video Settings to select Audio Settings.

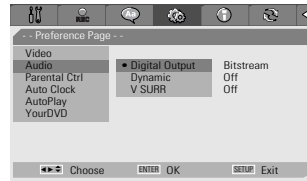

Digital Output

- 1 Use [▲/▼] to select 'Digital Output' while the Audio submenu is displayed.
- 2 Press [▶] to go to the second level.
- 3 Use [▲/▼] to select the desired digital output type.
- 4 Press [ENTER] to confirm your selection.
- 5 Press [SETUP] to exit the menu.

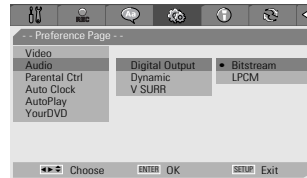

SETUP

LPCM

Select when connected to a 2 channel digital stereo amplifier. The DVD Recorder's digital audio signal will be output in the PCM 2ch format when you play a DVD recorded with a Dolby Digital (only for DVD) or MPEG soundtrack. If the DVD is recorded with a DTS sound track then no sound will be heard.

Bitstream

Select when connected to a Dolby Digital or DTS decoder (or an amplifier or other equipment with a Dolby Digital or DTS decoder).

Dynamic Range

While watching DVD movies, you may wish to compress the dynamic range of the audio output (the difference between the loudest and quietest passages). This allows you to listen to a movie at a lower volume without losing clarity of sound.

Set 'Dynamic' to **Low** or **High** for this effect.

Follow the same procedure as 'Digital Output' to set the Dynamic Range.

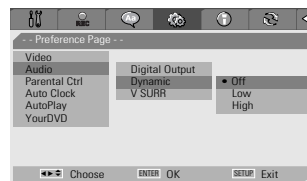

Virtual Surround

You can enjoy a simulated 3D effect from two speakers by setting 'V SURR (Virtual Surround)' to **On**.

Follow the same procedure as 'Digital Output' to set the Virtual Surround option.

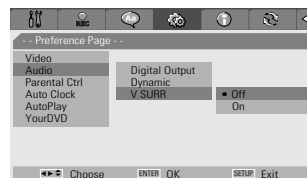

PREFERENCE / Parental Controls

Set Parental Level

The Parental Controls feature allows you to prevent DVDs from being played based on their ratings or to have certain discs played with alternative scenes. You can set the parental level from 1 to 8.

- 1 Press [SETUP]. The Setup menu appears.

While 'Init Setup' is selected, press [ENTER] to go to the initial setup page.

- 2 Use [◀/▶] to select 'Preference Page' .

- 3 While 'Preference Page'  is selected, press [▼] to select 'Parental Ctrl'.

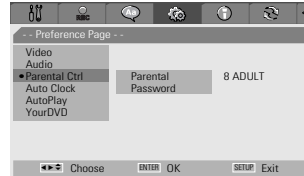

- 4 Press [▶] to select 'Parental'. Then press [▶] again to change parental level.

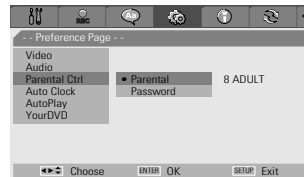



- 5 Use [▲/▼] to select the desired parental level and press [ENTER] to confirm.

Off: If you select Unlock, the Lock feature is not active. All discs will play in full.

Level 1 to 8: Some discs contain scenes not suitable for children. If you set a rating for the DVD Recorder, all scenes with the same rating or lower will be played. Higher rated scenes will not be played unless an alternative scene is available on the disc. The alternative must have the same rating or a lower one. If no suitable alternative is found, playback will stop. You must enter the 4-digit password or change the rating level in order to play the disc.

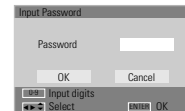
- 6 The Password Input dialog will appear. Enter a 4-digit password using the [0-9] buttons. If this is the first time you have entered a password, you will be prompted to enter the password again to confirm it.



 The initial password is '3308'. You must enter this password before you can change the Parental Level.

- 7 After setting the password, press [ENTER] while 'Set Parental Level' is displayed.

- 8 Press [ENTER] to confirm your rating selection, then press [SETUP] to exit the menu.

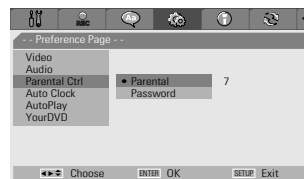

Change Password

1 While 'Preference Page' is selected, press [▼] to select 'Parental Ctrl'.

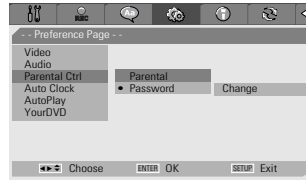

2 Select 'Password' then press [▶] to select 'Change'.

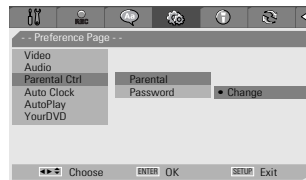

3 Press [ENTER]. The Input Password submenu appears. Enter your current 4-digit password then press [ENTER].



4 Enter a new 4-digit password, then press [ENTER]. Re-enter the new password to confirm, press [ENTER].



- **Master Password** : If you forget your password, press 3,3,0,8 on the remote control and then press [ENTER].
- Set the new password to something other than '0000'.

SETUP

Various PREFERENCE Settings

Auto Clock

Auto Clock enables the DVD Recorder to set the clock automatically whenever it is in Standby mode (plugged in but powered off).

- 1 Use [▲/▼] to select 'Auto Clock'.
- 2 Press [▶] to go to the second level.
- 3 Use [▲/▼] to set the Auto Clock Status to **On** or **Off**.
- 4 Press [ENTER] to confirm.

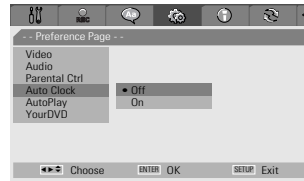

AutoPlay

Enables you to skip the ads and trailers and play your DVDs automatically when they are inserted in the tray.

- 1 Use [▲/▼] to select 'AutoPlay'.
- 2 Press [▶] to go to the second level.
- 3 Use [▲/▼] to set the AutoPlay Status to **On** or **Off**.
- 4 Press [ENTER] to confirm.

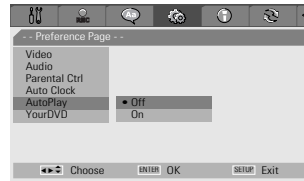

YourDVD

Whenever DVD title is inserted, your settings (audio, subtitle language and sound mode) will be displayed with YourDVD turned "On".

- 1 Use [▲/▼] to select 'YourDVD'.
- 2 Press [▶] to go to the second level.
- 3 Use [▲/▼] to set the YourDVD Status to **On** or **Off**.
- 4 Press [ENTER] to confirm.

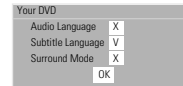
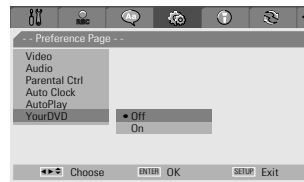

System Information

System Information helps service personnel identify key firmware information about your DVD Recorder in case service is required.

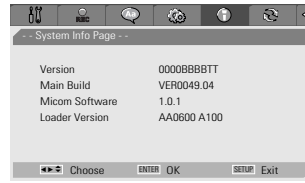

Restore Defaults

If you wish, you can reset the DVD Recorder to its original factory settings.

- 1 Press [SETUP].
- 2 Use [◀/▶] to select 'Restore Defaults Page' .
- 3 Press [ENTER].
- 4 The Initialize menu will appear. Use the [▲▼◀▶] buttons to select 'OK' and press [ENTER].



- Some options cannot be reset, including Parental Controls, Password, and Country Code.
- After Restoring Defaults the unit reboots automatically and the Installation menu appears. You must set the country, language, channel, and clock settings again.

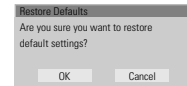
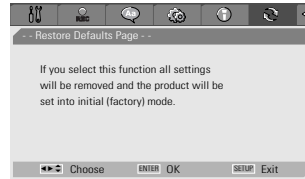

SETUP

On-Screen Display Overview

The On-Screen Display provides feedback on the status of the DVD Recorder and/or the currently loaded disc. To access the On-Screen Display (or OSD), press the [DISPLAY] button.

Displaying DVD Information









- 1 During disc playback, press [DISPLAY] to show information about the current disc.
- 2 While the disc information is displayed, press [DISPLAY] again to show the disc status window.



Changing menu options in display menu

- 1 Press [DISPLAY] during playback. The on-screen display appears on the TV screen.
- 2 Use [◀▶] to select the desired icon on the on-screen display. Press [ENTER] to display a submenu.
- 3 Use [▲▼] to change the numbers. Press [ENTER] to confirm.

• Displaying icons on DVD disc

-  **Title** : Shows the current title number and total number of titles, and skips to the desired title number.
-  **Chapter** : Shows the current chapter number and total number of chapters, and skips to the desired chapter number.
-  **Time Elapsed** : Shows the elapsed playing time, and skips to the desired time.
-  **Audio** : Shows the current audio soundtrack language, encoding method, and channel number, and changes the setting; AC3 5.1 CH English or AC3 2 CH English
-  **Subtitle** : Shows the current subtitle language, and changes the setting; Off, English, French or Spanish
-  **Repeat** : Shows the current repeat mode, and changes the setting; Chapter, Title, All or Off
-  **A-B Repeat** : Shows the current A-B repeat mode, and changes the setting; A-, A-B or Off
-  **Random Repeat** : Shows the current random repeat mode, and changes the setting; On or Off
-  **OSD Language** : Shows the current OSD language, and changes the setting; English, French or Spanish

- **Displaying icons on CDDA disc**



Track : Shows the current track number and total number of tracks, and skips to the desired track number.



Time Elapsed : Shows the elapsed playing time, and skips to the desired time.



Audio Effect : Shows the current audio effect, and changes the setting; Stereo or Mix-Mono



Sound Effect : Shows the current sound effect, and changes the setting; Off, Concert, Living Room, Hall, Bathroom, Cave, Area or Church



Repeat : Shows the current repeat mode, and changes the setting; Track, All or Off



A-B Repeat : Shows the current A-B repeat mode, and changes the setting; A-, A-B or Off



Random Repeat : Shows the current random repeat mode, and changes the setting; On or Off



OSD Language : Shows the current OSD language, and changes the setting; English, French or Spanish

PLAYBACK

Displaying TV Information

While watching TV, press [DISPLAY] to display/remove the on-screen display. If no rewritable DVD disc is inserted, you would see a screen like the following: If a DVD+R or DVD+RW disc is inserted, the disc information is displayed at the first button press. If you press [DISPLAY] again then the TV information is displayed.



Changing the TV Audio Channel

Some TV programs are broadcast with both a main and a Secondary Audio Program (SAP). You can change the TV audio using the [AUDIO] button.

Press [AUDIO] repeatedly to change the TV audio, according to the Broadcast audio signal as shown below.

- **STEREO+SAP Audio Signal** : Stereo → Mono → SAP → Stereo
- **STEREO Audio Signal** : Stereo → Mono → Stereo
- **SAP Audio Signal** : Mono → SAP → Mono
- **MONO Audio Signal** : Mono

The current audio channel is displayed on-screen.

- If SAP is selected, but there is no SAP channel being broadcast, you will still hear the main audio channel.
- If the sound is poor quality when set to Stereo, you can often improve it by changing to Mono.
- When an external input is selected, the audio channel can be switched only to Stereo.

Changing TV Channels

If no disc is playing, you can change TV channels using the [0-9] or [CH +/-] buttons on the remote control or [CH ▲/▼] buttons on the front panel.



Antenna channels are numbered 2 through 69. Cable channels are numbered 1 through 125.

DVD Playback

Before You Begin

- 1 Press the [DVD] button to set the remote control to operate the DVD deck.
- 2 Turn the TV on and select the video input source connected to the DVD Recorder.
Audio system: Turn the audio system on and select the input source connected to the DVD Recorder.

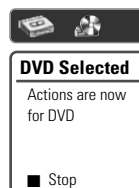

Playing a DVD

- 1 Press [EJECT] to open the disc tray.
- 2 Load your disc in the tray with the playback side down (label side up).
- 3 Press [EJECT] to close the tray.
- 4 READING appears on the front panel display, and playback starts automatically. If playback does not start, press [PLAY (▶)]. In some cases, the Disc menu might appear instead.

Playing a DVD+R (+RW, -R, -RW)

When a DVD+RW or unfinalized DVD+R (-R, -RW) is inserted, no title is played automatically but the current TV channel displays on the screen.

- 1 If you want to play a title on the DVD+R (+RW, -R, -RW), you must press [MENU] or [PLAY] to display the disc menu of a thumbnail index for each recorded title on the disc.

The index picture screen of the title will be displayed. Also title information (name of recording, recorded day, time, recording quality) will be displayed.



- 2 Select a title to play using [◀▶] then press [ENTER] or [PLAY].

If a Disc menu is displayed

- A Disc menu may be displayed when you load a DVD. Use the [◀▶▲▼] buttons to select the title/chapter you want to view, then press [ENTER] to start playback. Press [TITLE] or [MENU] to return to the Disc menu.
- If the Parental Level feature is set and the disc is below the current Parental Level setting, the 4-digit code must be entered and/or the disc must be authorized; see 'Set Parental Level' on page 24.
- The DVD Recorder will not play discs with Region codes different from the DVD Recorder. The Region code for this DVD Recorder is 1 (one).
- Unless stated otherwise, all operations described below use the remote control. Some features may also be available in the Setup menu.
- A disc which is recorded by computer at high speeds (greater than or equal to 2x) may not be recognized.
- A disc which is recorded with unauthorized movie material may not be played.
- A disc which is recorded by other recorder or not recorded correctly may not be recognized or played.

Still Picture and Frame-by-Frame Playback

- 1 Press [PLAY/PAUSE] during playback. The DVD Recorder will go into Pause mode.
- 2 You can back up or advance the picture frame-by-frame by pressing [FF (▶▶)] repeatedly during Pause mode.

Fast Forward/Backward

- 1 Press [REW (◀◀)] or [FF (▶▶)] during playback. The DVD Recorder will go into Search mode.
- 2 Press [REW] or [FF] to select the desired speed: ▶▶ X2, ▶▶ X4, ▶▶ X8, ▶▶ X16, ▶▶ X32, ▶ (forward) or ◀, ◀◀ X2, ◀◀ X4, ◀◀ X8, ◀◀ X16, ◀◀ X32 (backward).

Slow Motion

Press [SLOW+] or [SLOW-] to enter Slow Motion mode. The default speed is 1/2. When you press [SLOW+] or [SLOW-] repeatedly, the speed will be set to 1/4, 1/8, 1/16, and normal speed.

Changing the Audio Language

Press [AUDIO] and then press [AUDIO] repeatedly during playback to hear a different audio language or audio track.

Subtitles

Press [SUBTITLE] and then press [SUBTITLE] repeatedly during playback to select among all available subtitle languages.

Camera Angle

If a DVD contains scenes recorded at different camera angles, angle icon displays automatically. You can select among these angles during playback.

Press [ANGLE] and then press it repeatedly during playback to select the desired angle.

The number of the current angle appears on the TV screen.



The Camera Angle icon is displayed on the TV screen when alternate angles are available.

Zoom

The Zoom function allows you to magnify the video image and scroll around the enlarged image.

- 1 Press [ZOOM] during Play mode to activate the Zoom function.
Each press of the [ZOOM] button changes the Zoom level as follows: X1 (normal size) → X2 → X3 → X4 → X1/2 → X1/3 → X1/4 → X1 (normal size)
- 2 Use the [◀▶▲▼] buttons to scroll around the zoomed picture.
- 3 To resume normal playback, press [ZOOM] repeatedly until the X1 (normal picture) appears.



The Zoom function may not work on some DVDs.

Repeat

- 1** To repeat the currently playing chapter, press [REPEAT]. REPEAT CHAPTER appears on the TV screen.
- 2** To repeat the currently playing title, press [REPEAT] a second time. REPEAT TITLE appears on the TV screen.
- 3** To repeat the whole disc, press [REPEAT] a third time. REPEAT DISC appears on the TV screen.
- 4** You can play in other modes (including Repeat, A-B, Shuffle, or Scan) by pressing [REPEAT] repeatedly.



You can repeat a scene that starts when 'Repeat A-' displays on the screen. To mark the end point, press [A-B]. Press [A-B] again to repeat the scene.

A-B

You can repeat a scene between two points (A and B):

- 1** Press [PLAY/PAUSE] play to the start of the desired scene.
- 2** Press [A-B] to mark the start point.
- 3** Use [FF], [NEXT] to search the end point.
- 4** Press [A-B] to mark the end point.
- 5** The marked scenes are repeated continuously until you stop the repeat by pressing [A-B] button again.

Selecting Titles

When a disc has more than one title, you can select among all available titles as follows:

- 1** Press [DISPLAY] and use [▲▼] to select the Title icon. Press [ENTER] to display a submenu. Use [▲▼] to select the desired title number and press [ENTER] to confirm.

Selecting Chapters

When a title on a disc has more than one chapter, you can select among all available chapters as follows:

- 1** Press [PREV (◀◀)] or [NEXT (▶▶)] briefly during playback to select the next or previous chapter.
- 2** To skip directly to any chapter during playback, press [DISPLAY]. Use [▲▼] to select the Chapter icon, then press [ENTER] to display a submenu. Use [▲▼] to select the desired chapter number and press [ENTER] to confirm.

Disc Menus

Many DVDs contain Disc menus that allow you to access special features. To open a Disc menu, press [MENU]. Then use the [0-9] buttons to directly select the desired options, or use the [▲▼] buttons to highlight your desired selection and press [ENTER].

- 1 Press [MENU]. The Disc menu is displayed.
- 2 To exit the Disc menu, press [STOP] or [TV VIEW].

Title Menus

- 1 Press [TITLE]. If the current title has a menu, the Title menu will appear on the TV screen. Otherwise, the Disc menu may appear.
- 2 The Title menu may contain camera angles, spoken languages and subtitle options, as well as the chapters for the title.

Digest

For displaying the edit menu for DVD+RW / +R discs, for setting chapter markers.

- 1 Press [DIGEST]. The Digest menu is displayed.
- 2 To exit the Disc menu, press [STOP] or [TV VIEW].

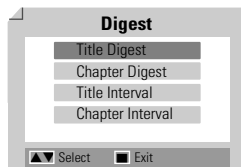

Other Disc Playback

Audio CD/MP3 PLAYBACK

The DVD Recorder can play audio CDs and MP3 files on CD-ROM, CD-R or CD-RW discs.

- 1 Insert the CD disc and close the tray. The Audio CD or MP3 CD menu appears on the TV screen after a few moments to load the disc.
- 2 Use [▲▼] to select a track or a file, then press [PLAY] or [ENTER].

During playback, the current track's elapsed playing time will appear on the menu. Playback will stop at the end of the disc.

On the MP3 CD menu, you can display the folders on the disc.

Use [▲▼◀▶] to select the folder icon on the MP3 CD menu then press [ENTER] or [PLAY].



You can also display just the tracks in the folders.

Use [▲▼◀▶] to select a folder then press [ENTER].

- 3 While playing an Audio CD, use [FF] or [REW] for 2X, 4X, 8X, 16X, 32X speed playback.
- 4 Use [PLAY/PAUSE] to pause playback while the disc is playing.
- 5 To stop playback at any time, press [STOP].



- Press [REPEAT] to repeat a track (file) and press again to repeat the whole disc.



PLAYBACK

JPEG CD PLAYBACK

The DVD Recorder can display JPEG files on CD-R/RW.

- 1 Insert your CD and close the tray. The JPEG CD folder tree appears.
- 2 If there are folders which contain JPEG files, select the desired folder using [▲▼◀▶] and press [ENTER].

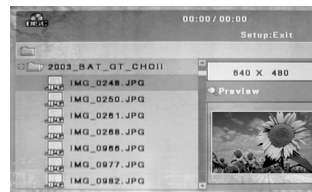

- 3 Select the thumbnail you want to display using [▲▼◀▶] and press [ENTER].
- 4 The full size image will be displayed and a slide show starts automatically with a time interval of 10 seconds.



Other Disc Playback

- 5** Press [NEXT] or [PREV] to manually skip to the next or previous image.
- 6** Press [▶] (or [◀]) to rotate the image (counter) clockwise.
- 7** Press [STOP] to exit the slideshow.



- When a CD contains both MP3 files and JPEG files, the default Play mode is JPEG image files.
- The DVD Recorder can playback up to 1000 files per disc.
- MP3 files encoded below 64kbps are not supported.

Basic Recording

Recording from TV

Follow the instructions below to record a TV program.

1 Turn on the DVD Recorder and load a recordable disc .

Make sure your TV input is set to view the DVD Recorder.

2 Set the desired Recording mode in DVD Record Quality menu by pressing [SETUP] button.

Approx 1 Hour (HQ mode), 2 Hours (SP mode), 4 Hours (EP mode), 8 Hours (SEP mode)

3 If your DVD Recorder does not show a TV program, press [TV VIEW] on the remote control. Use [CH ▲ / ▼] to select the TV channel you wish to record.

4 Press [AUDIO] to select the audio channel to record (Stereo, SAP, or Mono).

The table below shows what audio channel will be recorded with different settings and different types of broadcasts.

The last column (Monitor Audio) shows what you will hear during recording. For example, if the TV broadcast is in Stereo, then setting the DVD Recorder to Stereo will record the broadcast in Stereo, and the Monitor Audio will also be in Stereo.

- If you set the audio channel to SAP, but no SAP channel is broadcast, the main audio (Mono or Stereo) will be recorded.

TV Broadcast	Selected Audio	Broadcast Audio		Monitor Audio
		L Ch	R Ch	
MONO	MONO	MONO	MONO	MONO
STEREO	STEREO	L	R	STEREO
	Left	L	L	Left
	Right	L	R	Right
	MONO	MONO	MONO	MONO
MONO+ SAP	MONO	MONO	MONO	MONO
	SAP	SAP	SAP	SAP
STEREO+SAP	STEREO	L	R	STEREO
	SAP	SAP	SAP	SAP
	MONO	MONO	MONO	MONO

5 Press [REC (●)] once.

Recording will start. The REC indicator lights on the front panel display.

Recording continues until you press [STOP] or the disc is full.

To record for a fixed length of time, see One Touch Record on the next page.

6 Press [STOP (■)] to stop recording.



- The maximum number of DVD titles per disc is 49. If the DVD Recorder is powered off during DVD recording, the recording will not be saved.
- If a DVD+RW or unfinalized DVD+R (-R, -RW) disc is inserted in the tray, no title is played automatically after loading is finished.
- If you are recording to a blank DVD+R (+RW, -R, -RW) disc, it may take up to 7 minutes for post processing after recording.



One Touch Record (OTR)

One Touch Recording allows you add recording time in fixed increments at the touch of a button.

- 1 Follow steps 1-4 under *Recording from TV*.
- 2 Press [REC (●)] repeatedly to set the length of the recording.

Recording starts after the first press. Each subsequent press increases the recording time by 30 minutes within the available space. The recording time is displayed on the front panel display.

Checking the Recording Time

Total time and recorded time are displayed on the TV screen after pressing [DISPLAY]. Recorded time is displayed on the OSD.

To Pause the Recording

- 1 Press [PLAY/PAUSE] to pause the disc during recording.
- 2 When you want to continue recording, press [PLAY/PAUSE] or [REC (●)].



Note

- To quit One Touch Recording, press [STOP].
- The DVD Recorder will automatically power off when One Touch Recording ends.

Timer Recording

The Timer Recording function allows you to record up to 8 programs within a period of one month.

1 Insert recordable media such as DVD±R ,DVD±RW.

2 Press [TIMER].

or Press [SETUP] and select 'Timer REC'. Then press [ENTER].

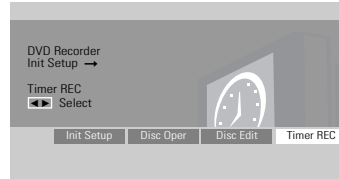

The 'Timer Recording' menu appears.

Use [▲▼] to move to a timer recording slot, and press [ENTER] to modify it.

If you did not set the clock on the DVD Recorder, you must do so before programming a timer recording.

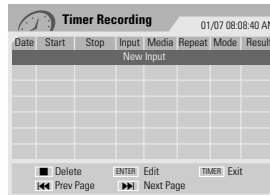

3 Enter the necessary information for your Timer Recording(s).

- Date – Choose a date up to 1 month in advance, or select a daily or weekly program.
- Start – Set the recording start time.
- Stop – Set the recording end time.
- Input – Choose the desired channel, or one of the external inputs from which to record.
- Repeat – Choose frequency of the recording. Once, Daily, Weekly, Weekday.
- Media - Choose desired media using [▲▼].
- Title - Enter into title edit mode pressing [●].
- Mode – Choose a Record mode.
HQ, SP, EP or SEP

[◀▶] – Moves the cursor left/right.

[▲▼] – Changes the setting at the current cursor position.

Press [SETUP] to exit the Timer Record menu.

Press [ENTER] after filling in all the program information.

Press [TIMER] to display the Timer Record List.



4 Press [ENTER] to save the program.

The Timer Record List will appear.

5 Press [SETUP] to exit the Timer Record List.

6 Timer indicator will light or blinking. Power Off the DVD Recorder to start the Timer Recording.



- The Timer indicator lights on the front panel display when the DVD Recorder is ready for the Timer Recording.
- The disc timer indicator is blinking if disc timer recordings are overlapped.
- The DVD Recorder will record the audio according to the current TV tuner setting (Stereo, Mono or SAP). Use the [AUDIO] button to set the audio before switching the DVD Recorder to Standby mode.
- The DVD Recorder will automatically power off when the Timer Recording ends.
- There is a short delay when a timer recording finishes to confirm the recorded program. If two timer recordings are set to record sequentially (one right after the other), the very beginning of the later program may not be recorded.

Canceling a Timer Recording

You can clear a Timer Recording any time before the recording actually starts.

- Use [▲▼] to select the program you want to erase on the Timer Recorder List. Press [■STOP] to delete the program.

Stopping a Timer Recording in Progress

After a Timer Recording has started, you can still cancel the program by pressing and holding [■STOP] for 3 seconds.

Timer Recording Troubleshooting

Even if a Timer Recording is set, the DVD Recorder will not record if:

- No disc is loaded.
- A non-recordable disc is loaded.
- Disc is protected in the 'Disc Operation' menu; see page 47.
- There are already 49 titles recorded on the disc.

You cannot enter a Timer Recording if:

- A recording is already under way.
- The start time has already passed.
- Eight Timer Recordings have already been set.

If two or more Timer Recordings overlap:

- You should set only one Timer Recording.
- You can choose replace old Timer Recording or not.
- Only one Timer recording will work.

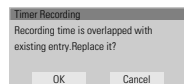

Confirmation is not possible when:

- Disc is protected in the 'Disc Operation' menu; see page 47.
- There are already 49 titles recorded on the disc.

If the disc is damaged, the recording may not complete successfully, even if the Check field shows 'Rec. OK'.

Recording from an External Input

Recording from External Components

You can record from an external component, such as a camcorder or VCR, connected to any of the DVD Recorder's external inputs.

1 Make sure the component you want to record from is connected properly to the DVD Recorder; see pages 11 and 14.

2 Use [**▲** **▼**] to select the external input to record from.

- Tuner: Built-in tuner
- LINE1 : Audio/Video on front panel
- LINE2 : Audio/Video Input on back panel
- DV: DV input on front panel.

3 Load a recordable disc.

4 Set the desired Recording mode in DVD Record Quality menu by pressing [SETUP] button.

HQ (High Quality - 1 hr/disc), SP (Standard Play - 2 hrs/disc), EP (Extended Play - 4 hrs/disc), SEP (Very Low Quality - 8 hrs/disc)

5 Press [REC (●)] once.

Recording will start. The REC indicator lights on the front panel display.

Recording continues until you press [STOP] or the disc is full.

To record for a fixed length of time, see 'One Touch Record' on page 39.

6 Press [STOP (■)] to stop recording.



Note

If your source is copy-protected, you will not be able to record it using the DVD Recorder. See 'Copyright Notice' on page 4 for more details.

RECORDING

Recording from a Digital Camcorder

You can record from a digital camcorder connected to the DV IN jack on the front panel of the DVD Recorder. You can use the DVD Recorder remote to control both the camcorder and the DVD Recorder. Before recording, make sure the digital camcorder is properly connected to the front panel DV IN jack; see page 14.



The source signal must be DVC SD format.

Some camcorders cannot be controlled using the DVD Recorder remote.

If you connect a second DVD recorder using a DV cable, you cannot control the second recorder from this one.

You cannot control the DVD Recorder remotely from a component connected to the DV IN jack.

You cannot record date and time information from a DV cassette.

1 Make sure your digital camcorder is connected to the front panel DV IN jack; see page 14.

2 Press [TV VIEW] repeatedly to select the DV input.

DV appears on the front panel display and the TV screen.

3 Find the place on the camcorder tape from which you want to start recording.

For best results, pause playback at the point you want to start recording. Depending on your camcorder, you can use the DVD Recorder remote to control the camcorder using the STOP, PLAY, and PAUSE functions.

4 Press [REC] once to start recording.

Recording is automatically stopped if the DVD Recorder detects no signal. You can pause or stop the recording by pressing [PLAY/PAUSE] or [STOP]. You cannot control the camcorder from the remote control during recording.

What is DV?

Using DV, also known as i.LINK, you can connect a DV-equipped camcorder to the DVD Recorder using a single DV cable for input and output of audio, video, data and control signals.

The i.LINK interface is also known as IEEE 1394-1995.

"i.LINK" and the "i.LINK" logo are trademarks.

- The DVD Recorder is only compatible with DV-format (DVC-SD) camcorders. Digital satellite tuners and Digital VHS video recorders are not compatible.
- You cannot connect more than one DV camcorder at a time to the DVD Recorder.
- You cannot control the DVD Recorder from external equipment connected via the DV IN jack (including two DVD Recorders).
- It may not always be possible to control the connected camcorder via the DV IN jack.
- Audio input to the DV IN jack should be 32 or 48kHz (not 44.1kHz).
- Picture disturbance on the recording may occur if the source component pauses playback or plays an unrecorded section of tape, or if the power fails in the source component, or if the DV cable becomes disconnected.

Disc Operation

Disc Initialize

- If you load a blank DVD±R (±RW) disc, it will be initialized (formatted to enable recording).
- Do not start recording until disc initialization is complete.
- If you load a DVD±RW that has already been used you can record a program immediately.

Disc Operation in DVD±RW disc

For recordable DVD media, such as DVD±R and DVD±RW discs, you can manage the disc using the Disc Menu. The DVD±RW Disc Menu allows you to erase, lock, or unlock your disc. You can also make it compatible with most other DVD players.

At first, go to Disc Operation mode.

- 1 Press [SETUP]. The Setup menu appears.
- 2 While 'Disc Oper' is selected, press [ENTER] to go to the Disc Operation page.

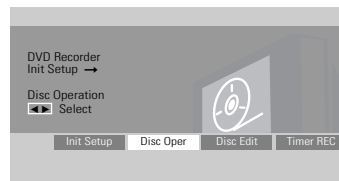

Erase the disc (DVD±RW)

- 3 Use [▲/▼] to select the 'Erase' menu.
- 4 If you want to erase the whole disc, press [ENTER].
- 5 To confirm, select 'OK'. To cancel, select 'Cancel'.

If you select 'OK' and press [ENTER], all the contents of the disc will be lost.

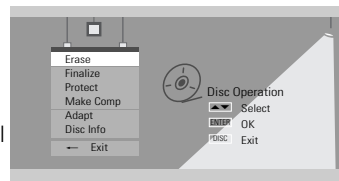

Protect Disc (DVD±R, DVD±RW)

If you want to protect a disc from accidental recording, editing, or erasing, you can lock the disc. Later, if you change your mind, you can unprotect the disc.

- 3 Use [▲/▼] to select 'Protect' menu.
- 4 If you want to protect the whole disc, press [ENTER].
- 5 To confirm, select 'OK'. To cancel, select 'Cancel'.

If you select 'OK' and press [ENTER], all the contents of the disc will be protected.

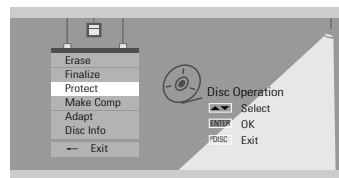

RECORDING

DISC OPERATION&EDIT

Make Compatible (DVD±RW)

'Make Compatible' for a DVD±RW will automatically create a menu screen for navigating the disc. This menu screen is accessible by pressing [MENU] or [TITLE].

- 3 Press [▲/▼] to select 'Make Compatible'.
- 4 If you want to make the disc compatible, press [ENTER].
- 5 To confirm, select 'OK'. To cancel, select 'Cancel'.

If you select 'OK' and press [ENTER], your disc will be make compatible.

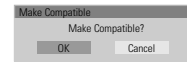
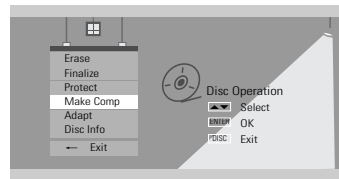

- 'Make Compatible' can take up to 3-4 minutes depending on the type of disc, how much is recorded on the disc, and the number of titles on the disc.
- If you do not make your DVD±RW disc compatible, your edits will not be recognized by other DVD players.

Adapt

Disc menus created through DVD recorders by different manufacturers each have their own distinct structure. The 'ADAPT' function allows you to format a recorded disc's menu to match that of the Daewoo DVDR. This will increase compatibility and ease of use. After the 'ADAPT' function is completed, recorded title contents remain the same while the Disc menu has been changed.

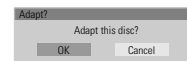
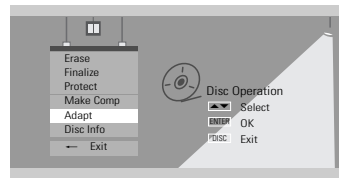

- 3 Use [▲/▼] to select 'Adapt' menu.
 - 4 If you want to adapt the whole disc, press [ENTER].
 - 5 To confirm, select 'OK'. To cancel, select 'Cancel'.
- If you select 'OK' and press [ENTER], the disc will be adapted.

Information

- 3 Press [▲/▼] to select 'Disc Info'.
- 4 The Disc Info Menu shows you disc information, such as disc type, number of recordings, total titles, free space, etc.

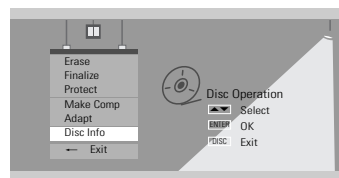

RECORD	Empty	TITLE NO.	3	Remainder
DISC	DVD±RW			HD: 60 (M)
				SP: 116 (M)
RECORD	Recordable (NTSC)			EP: 233 (M)
FREE	154/4414MB			SEP: 438 (M)

Disc Operation in DVD±R, DVD-RW disc

For recordable DVD media, such as DVD±R and DVD±RW discs, you can manage the disc using the Disc Menu. The DVD±R, DVD-RW Disc Menu allows you to rename your disc or finalize it so it will be compatible with most other DVD players.

At first, go to Disc Operation mode.

- 1 Press [SETUP]. The Setup menu appears.
- 2 While 'Disc Oper' is selected, press [ENTER] to go to the Disc Operation page.

Finalize (DVD±R, DVD-RW)

Finalizing a DVD±R, DVD-RW 'locks' its recordings in place so the disc can be played on most standard DVD players or computers equipped with DVD-ROM drives.

- 3 Use [▲/▼] to select 'Finalize' menu.
 - 4 If you want to finalize the whole disc, press [ENTER].
 - 5 To confirm, select 'OK'. To cancel, select 'Cancel'.
- If you select 'OK' and press [ENTER], the disc will be finalized.

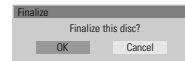
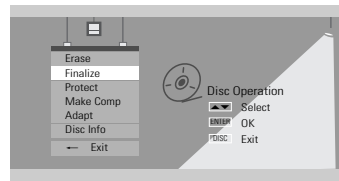

- Once you have finalized a DVD±R, DVD-RW disc, you cannot edit or record anything else on that disc.
- It may take over 7 minutes for finalizing the edited disk, you'd better wait till the set finish the finalizing operation.
- 'Finalize' can take up to 3-4 minutes depending on the type of disc, how much is recorded on the disc, and the number of titles on the disc.

Disc Edit

Title Menu

You can manage the titles on your DVD±R/±RW discs using the Title menu.

At first, go to Disc Edit mode.

- 1 Press [SETUP]. The Setup menu appears.
- 2 While 'Disc Edit' is selected, press [ENTER] to go to the Disc Edit page.

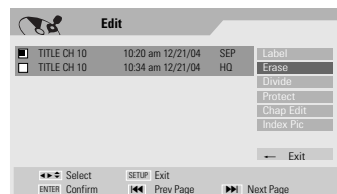
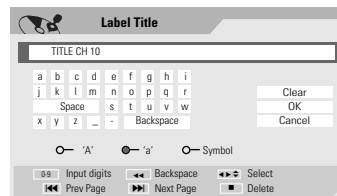
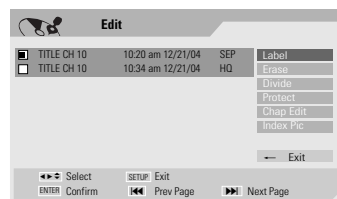
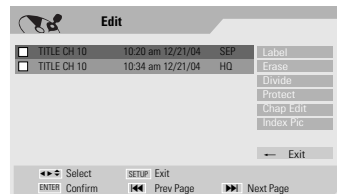
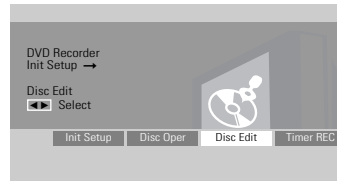

Label a Title

To change the name of a title:

- 2 Select the title to be labelled using [ENTER].
- 3 Select 'Label' using [▲ ▼].
- 4 Press [ENTER] to change the title name.
- 5 The Keyboard Menu will be displayed. Use [◀ ▶ ▲ ▼] to select a character or function and press [ENTER].
- 6 After the new title name is complete, select 'OK' and press [ENTER].

Erase a Title

- 2 Select the title to be erased using [ENTER].
- 3 Then select 'Erase' using [▲ ▼].
- 4 Press [ENTER] to erase the title.
- 5 Select 'Yes' and press [ENTER] to confirm.
- 6 The Erase Title progress bar will be displayed. This may take several seconds.
- 7 After erasing is complete, the erased title remains as an empty title.



You can erase titles on DVD±RW discs only.

Divide (DVD±RW)

This feature allows you to divide a title into two titles.

- 2 Select the title to be divided using [ENTER].
- 3 Select 'Divide' using [▲ ▼].
- 4 Press [ENTER] to divide the title.
- 5 Select 'Yes' and press [ENTER] to confirm.
- 6 Press [ENTER] when the preferred picture is on your TV screen.
- 7 It may take a few minutes to divide the title.

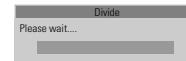
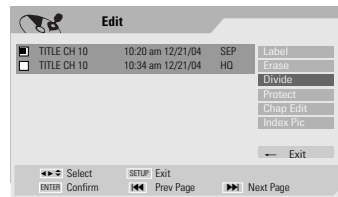

Protect

If you want to protect a title from accidental recording, editing, or erasing, you can lock the title. Later, if you change your mind, you can unprotect the title.

- 2 Select the title to be protected using [ENTER].
- 3 Select 'Protect' using [▲ ▼].
- 4 Press [ENTER] to protect the title.
- 5 Select 'Yes' and press [ENTER] to confirm.
- 6 The Protect Title progress bar will be displayed. This may takes several seconds. Protect icon '🔒' will appear in front of Title name.

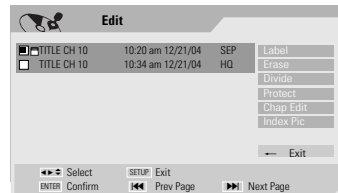
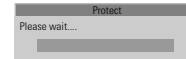
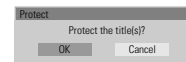
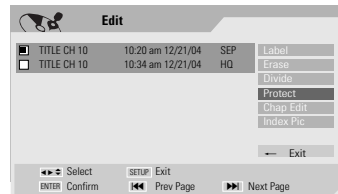

Edit Chapters

- 2 Select the title to be edited using [ENTER].
- 3 Select 'Chap Edit' using [▲ ▼].
- 4 Press [ENTER] to edit the chapters.
- 5 Select 'Yes' and press [ENTER] to confirm.
- 6 The Chapter Edit Menu will be displayed. Use [◀▶▲▼] to select one of the various chapter marker functions (Add, Delete, or Hide).
- 7 Press [ENTER] to confirm.

Add/Delete a Marker

You can add a chapter marker anywhere in a title during playback. Once the chapter is marked, you can use the chapter search feature as described above.

You can add/delete chapter markers or delete all chapter markers in a title.

Hide Chapters

This feature allows you to hide or unhide a chapter. After hiding a chapter, the chapter is not deleted but only hidden. If a chapter is hidden then it shows 'Unhide Chapter' and vice versa.

Change Index Picture

Each title displayed in the Playlist menu is represented by a thumbnail picture taken from the start of that title or chapter. If you prefer, you can select a different still picture from within the title.

- 2 Select the title to be edited using [ENTER].
- 3 Select 'Index Pic' using [▲ ▼].
- 4 Press [ENTER] to change the index picture.
- 5 Press [ENTER] when the preferred picture is on your TV screen.

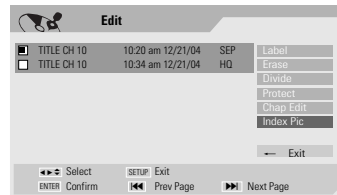
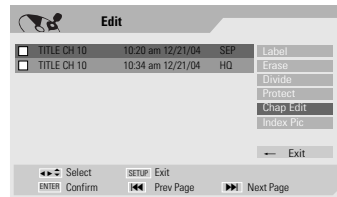

Troubleshooting

Check the following guide for the possible cause of a problem before contacting customer support.

Symptom	Cause	Solution
No power.	The power cord is disconnected.	Plug the power cord into the wall outlet securely.
No picture.	The TV is not set to receive DVD Recorder signal output.	Select the appropriate video input on the TV so the picture from the DVD Recorder appears on the TV screen.
	The video cable is not connected securely.	Connect the video cable securely.
	The TV power is turned off.	Turn on the TV.
No sound.	The equipment connected with the audio cable is not set to receive DVD Recorder signal output.	Select the correct input mode on the audio receiver so you can listen to the sound from the DVD Recorder.
	The audio cables are not connected securely.	Connect the audio cables securely.
	The power on the equipment connected with the audio cable is turned off.	Turn on the equipment connected with the audio cable.
	The audio cables are damaged.	Replace with new ones.
Playback picture is poor. DVD Recorder does not start playback.	The disc is dirty.	Clean the disc.
	No disc is inserted.	Insert a disc. (Check that the disc indicator on the front panel display is lit.)
	An unplayable disc is inserted.	Insert a playable disc. (Check the disc type, color system, and regional code.)
	The disc is placed upside down.	Place the disc with the playback side down.
	The disc is not placed within the guide.	Place the disc on the disc tray correctly inside the guide.
	The disc is dirty.	Clean the disc.
	The Parental Control level is set.	Cancel the Parental Control function or change the rating level.
Picture from external input is distorted.	The video signal from the external component is copy-protected.	You cannot connect via the DVD Recorder. Connect the component directly to your TV.
Some channels are skipped over when using [CH▲▼].	The skipped channels were deleted with the CH. Add/Del feature.	Use the CH. Add/Del feature to restore channels. See 'Add/Remove Channels' on page 18.
Picture or sound of broadcasting channel is weak or missing.	Antenna or cables are loose.	Tighten connections or replace cable.
	Wrong Tuning Band is selected in the DVD Recorder Setup menu.	Try all 'Tuning Band' options; see page 17 for details.
Camcorder image not shown.	Camcorder is off.	Turn camcorder on and operate properly.

Symptom	Cause	Solution
Camcorder image via A/V input to DVD Recorder is not shown on TV screen.	DVD Recorder's source is not set to LINE1/LINE2 composite.	Use [TV VIEW] to select AV input channel (LINE1/LINE2 composite).
Can't play disc recorded on this DVD Recorder on another DVD player.	The disc was not finalized (or not made compatible if using a DVD+RW).	Finalize the disc; see page 47.
	Some players will not play even a finalized disc.	No solution.
	Discs recorded with copy-once material cannot be played on other players.	No solution.
Cannot record or did not record successfully.	The remaining blank space on the disc is insufficient.	Use another disc.
	The source you are trying to record is copy-protected.	You cannot record the source.
	When setting the recording channel, the channel is tuned on your TV's tuner.	Select the channel on the DVD Recorder's built-in TV tuner.
Timer Recording not possible.	Clock in DVD Recorder is not set to correct time.	Set clock to correct time. See 'Set Clock' on page 19.
	Timer has been programmed incorrectly.	Reprogram Timer. See 'Timer Recording' on page 42.
	TIMER indicator light does not appear after programming timer.	Reprogram Timer.
Stereo Audio Record and/or Playback not present.	TV is not Stereo-compatible.	No solution.
	Broadcast program is not in stereo format.	No solution.
	DVD Recorder A/V Out jacks are not connected to TV A/V In jacks.	Make A/V connections. Stereo is available only via A/V output from DVD Recorder.
	DVD Recorder Audio/Video Out is not selected for viewing at the TV.	Select AUX or A/V source as TV input. Set TV audio channel mode to Stereo.
	DVD Recorder's TV audio channel is set to SAP or MONO.	See 'Changing the TV Audio Channel' on page 29.
Remote control does not work properly.	The remote control is not pointed at the remote sensor of the DVD Recorder.	Point the remote control at the remote sensor of the DVD Recorder.
	The remote control is too far from the DVD Recorder.	Operate the remote control within 23 ft (7m).
	There is an obstacle in the path of the remote control and the DVD Recorder.	Remove the obstacle.

Symptom	Cause	Solution
	The batteries in the remote control are dead.	Replace the batteries.
	The remote control is locked.	Press and hold [POWER] button on front over 5 seconds.
	The DVD Recorder is in the abnormal status.	Press and hold [DVD/VCR] button for 5 seconds to reset the DVD Recorder.
All of the buttons don't work or DVD screen stop suddenly.	DVD Recorder has interrupted by itself.	Press [RESET] switch on the rear panel.

Moisture Condensation

Moisture condensation can occur:

When the DVD Recorder is moved from a cold place to a warm place.

Under extremely humid conditions.

In locations where moisture condensation may occur:

Keep the DVD Recorder plugged into an AC power outlet with the power on. This will help prevent condensation.

When condensation has occurred, wait a few hours for the DVD Recorder to dry before using it.

Technical Specifications

General

Power requirements	AC 100–240V~, 50/60 Hz
Power consumption	Maximum 20W (Power-Off : 1.8W)
Dimensions (approx.)	16.5*2.0*12.6 inches (420*50*319 mm)(w*h*d)
Mass (approx.)	Net : 7.21 lbs (3.27kg), Gross :9.19 lbs (4.17kg)
Operating temperature	41°F to 95°F (5°C to 35°C)
Operating humidity	5% to 90%
Signal system	NTSC

Recording

Recording formats	DVD Video Recording, DVD-VIDEO
Recordable discs	DVD+R, DVD+RW, DVD-R, DVD-RW
Recordable time	Approx 1 Hour (HQ mode), 2 Hours (SP mode), 4 Hours (EP mode), 8 Hours (SEP mode)

Video recording format

Sampling frequency : 27MHz, Compression format : MPEG 2

Audio recording format

Sampling frequency : 48kHz, Compression format : MPEG1 Layer2

DVD Specifications

Laser system	Semiconductor laser, wavelength 650 nm
Frequency response	DVD (PCM 48 kHz): 8 Hz to 22 kHz, CD: 8 Hz to 20 kHz
Signal-to-noise ratio	More than 90 dB
Dynamic range	More than 90 dB
	■ Harmonic distortion Less than 0.06%

Inputs

ANTENNA IN	Antenna or CATV input, 75 Ω
VIDEO IN	1.0 V _{p-p} 75 Ω, sync negative, RCA jack x 2
AUDIO IN	-8.8 dBm more than 47 k, RCA jack (L, R) x 2
DV IN	4 pin (i.LINK/IEEE 1394 standard)

Outputs

VIDEO OUT	1 V _{p-p} 75 Ω, sync negative, RCA jack x 1
S-VIDEO OUT (Y)	1.0 V (p-p), 75 Ω, negative sync, Mini DIN 4-pin x 1, (C) 0.286 V (p-p) 75 Ω
COMPONENT VIDEO OUT (Progressive Scan)	(Y) 1.0 V (p-p), 75 Ω, negative sync, RCA jack x 1 (Pb)/(Pr) 0.7 V (p-p), 75 Ω, RCA jack x 2
AUDIO OUT	Digital audio : 0.5 V (p-p), 75 Ω, RCA jack x 1 Analog audio : 1.1 V _{rms} (1 kHz, -6 dB), 600 Ω, RCA jack (L, R) x 2
RF OUT	Channel 3 or 4 (Switchable)

Accessories

RCA cable	1	Remote control	1
RF Coaxial Cable	1	Batteries	2

Design and specifications are subject to change without notice.

Manufactured under license from Dolby Laboratories. Dolby and the double-D symbol are registered trademarks of Dolby Laboratories.
DTS and DTS Digital Out are registered trademarks of Digital Theater Systems, Inc.

Warranty

DEAM (Daewoo Electronics America) warrants each new electronic product manufactured by it to be free from defective material and workmanship and agrees to remedy any such defect or to furnish a new part (at the Company's option) in exchange for any part of any unit of its manufacture which under normal installation, use and service disclosed such defect, provided the unit is delivered by the owner to us or to our authorized distributor from whom purchased or authorized service station intact, for our examination with all transportation charges prepaid to our factory. To establish and receive warranty service at our factory or authorized service facilities, proof of purchase/dated sales invoice is required. Written authorization must be obtained before any merchandise is returned to the factory.

This warranty does not extend to any of our electronic products which have been subjected to misuse, neglect, accident, incorrect wiring not our own, improper installation, unauthorized modification, or used in violation of instructions furnished by us, nor units which have been repaired or altered outside of our factory, nor to cases where the serial number thereof has been removed, defaced or changed.

This warranty is in lieu of all warranties expressed or implied and no representative or person is authorized to assume for us any other liability in connection with the sale of our electronic products.

Over-the-counter exchange of initially defective units

A unit is described as initially defective when the dealer opens the unit and finds that it is inoperative or a customer opening a new unit finds that it is initially defective. This unit may be returned to the factory by the dealer for exchange. Under no circumstances will a customer be permitted to return an initially defective unit directly to the factory.

<i>Model</i>	<i>Parts</i>	<i>Labor</i>
DVR065	1 Year	3 months



This instrument is listed by Underwriter's Laboratories, Inc. It is designed and manufactured to meet rigid TUV safety standards against X-radiation, fire, casualty and electrical hazards.

Daewoo Electronics America Inc.

**120 Chubb Ave,
Lyndhurst, NJ 07071 USA**

For more information about this or other Daewoo products, call 1-800-DAEW008.