



MULTI-FUNCTION OVEN

KOC-1C4K

OWNER'S
MANUAL



Before operating this oven, please read these manual completely.
For safe use to avoid possible risk of tipping the oven, do not put heavy utensils or food on the door and tip the door.

PRECAUTIONS TO AVOID POSSIBLE EXPOSURE TO EXCESSIVE MICROWAVE ENERGY

- (a) **Do not attempt to operate this oven with the door** open since open-door operation can result in harmful exposure to microwave energy. It is important not to defeat or tamper with the safety interlocks.
- (b) **Do not place any object** between the oven front face and the door or allow soil or cleaner residue to accumulate on sealing surfaces.
- (c) **Do not operate the oven if it is damaged.** It is particularly important that the oven door close properly and that there is no damage to the: (1) door (bent), (2) hinges and latches (broken or loosened), (3) door seals and sealing surfaces.
- (d) The oven should not be adjusted or repaired by anyone except properly qualified service personnel.
- (e) **WARNING** : It is hazardous for anyone other than a competent person to carry out any service or repair operation that involves the removal of a cover which gives protection against exposure to microwave energy.
- (f) **WARNING** : Liquids and other foods must not be heated in sealed containers since they are liable to explode.
- (g) **WARNING** : Only allow children to use the oven without supervision when adequate instructions have been given so that the child is able to use the oven in a safe way and understands the hazards of improper use.
- (h) **WARNING** : When the appliance is operated in the combination mode, children should only use the oven under adult supervision due to the temperature generated. (if provided)

TABLE OF CONTENTS

• FEDERAL COMMUNICATIONS COMMISSION RADIO FREQUENCY INTERFERENCE STATEMENT	2	(Time Defrost with Microwave Feature)	24
• GROUNDING INSTRUCTIONS	2	• FERMENTATION (with Convection Feature)	25
• INSTALLATION	3	• STEAM CLEANING (with Microwave Feature)	26
• IMPORTANT SAFETY INSTRUCTIONS	4	• DEODORIZATION (with Convection Feature)	27
• GENERAL USE	5	• MEMORY COOK (with Microwave Feature)	28
• COOKING UTENSILS	6	• SETTING THE MEMORY COOK	29
• WHICH UTENSILS CAN BE USED IN THE OVEN?	7	• SETTING THE CLOCK	30
• CONTROL PANEL	8	• POWER SAVE MODE	31
• DISPLAY WINDOW	9	• REMINDER	31
• ACCESSORIES	10	• CHILD LOCK	31
• SETTING THE VOLUME LEVEL	11	• TO STOP THE OVEN WHILE THE OVEN IS OPERATING	31
• POPCORN	12	• ABNORMAL MESSAGES	31
• AUTO COOK	13	• ARCING	31
• INSTANT COOK	15	• GENERAL GUIDELINES	32
• MICROWAVE COOK	17	• CARE OF YOUR MICROWAVE OVEN	33
• SPEEDY COOK	18	• KEEP THE OVEN CLEAN	34
• CONVECTION COOK (Without Preheating)	19	• BEFORE CALLING FOR SERVICE	35
• CONVECTION COOK (With Preheating)	20	• QUESTIONS AND ANSWERS	36
• GRILL COOK	21	• SPECIFICATIONS	37
• COMBINATION COOK (Microwave+Convection)	22	• DISPOSAL OF USED ELECTRICAL & ELECTRONIC EQUIPMENT	37
• AUTO DEFROST (Weight Defrost with Microwave Feature)	23	• COOKING INSTRUCTIONS	38
• AUTO DEFROST			

FEDERAL COMMUNICATIONS COMMISSION RADIO FREQUENCY INTERFERENCE STATEMENT

WARNING:

This equipment generates and uses ISM frequency energy and if not installed and used properly, that is in strict accordance with the manufacturer's instructions, may cause interference to radio and television reception.

It has been type-tested and found to comply with limits for an ISM Equipment pursuant to part 18 of FCC Rules, which are designed to provide reasonable protection against such interference in a residential installation.

However, there is no guarantee that interference will not occur in a particular installation.

If this equipment does cause interference to radio or television reception, which can be determined by turning the equipment off and on, the user is encouraged to try to correct the interference by one or more of the followings.

- Reorient the receiving antenna of radio or television.
- Relocate the Microwave oven with respect to the receiver.
- Move the microwave oven away from the receiver.
- Plug the microwave oven into a different outlet so that microwave oven and receiver are on different branch circuits.

THE MANUFACTURER is not responsible for any radio or TV interference caused by UNAUTHORIZED MODIFICATION to this microwave oven. It is the responsibility of the user to correct such interference.

GROUNDING INSTRUCTIONS

This appliance must be grounded. In the event of an electrical short circuit, the grounding plug reduces the risk of electric shock by providing an escape wire for electric current. This appliance is equipped with a cord having a grounding wire with a grounding plug. The plug must be plugged into an outlet that is properly installed and grounded.

WARNING:

Improper use of the grounding can result in a risk of electric shock.

Consult a qualified electrician or serviceman if the grounding instructions are not completely understood, or if doubt exists as to whether the appliance is properly grounded, and either :

(1) If it is necessary to use an extension cord, use only a 3-wire extension cord that has a 3-blade grounding plug, and a 3-slot receptacle that will accept the plug on the appliance. The marked rating of the extension cord shall be equal to or greater than the electrical rating of the appliance.

or

(2) Do not use an extension cord, if the power supply cord is too short, have a qualified electrician or serviceman install an outlet near the appliance.

WARNING:

Do not cut or remove the third (ground) prong from the power cord under any circumstances.

INSTALLATION

1. Examine the oven after unpacking.

Check for damage such as a misaligned door, broken door or dent in the cavity.
If any damage is visible, DO NOT INSTALL, and notify your dealer immediately.

2. Level, flat location.

Install the microwave oven on a level, flat surface. Install the microwave oven more than 3ft.(914 mm)above the floor.

3. Ventilation.

Do not block air vents. If they are blocked during operation, the oven may overheat and eventually cause a failure.
For proper ventilation, allow 4 inches of space between oven top, sides, rear and adjacent surfaces.

4. Away from radio and TV sets.

Poor television reception and radio interference may result if the oven is located close to a TV, radio, antenna, feeder, etc.
Place the oven as far from them as possible.

5. Away from heating appliances and water taps.

Keep the oven away from heat, steam or splashing liquids. These things can adversely affect oven wiring and contacts.

6. Power supply.

- Check your local power source.

This microwave oven requires a current of approximately 14 amperes, 120Volts, 60Hz grounded outlet.

1. A short power-supply cord is provided to reduce the risks resulting from becoming entangled in or tripping over a longer cord.
2. Longer cord sets or extension cords are available and may be used if care is exercised in their use.
3. If a long cord or extension cord is used:
 - The marked electrical rating of the cord set or extension cord should be at least as great as the electrical rating of the appliance.
 - The extension cord must be a grounding type 3-wire cord.
 - The longer cord should be arranged so that it will not drape over the counter top or tabletop where it can be pulled on by children or tripped over unintentionally.

7. The minimum height of free space necessary above the top surface of the oven is about 4 inches.

When use 3-pronged plug

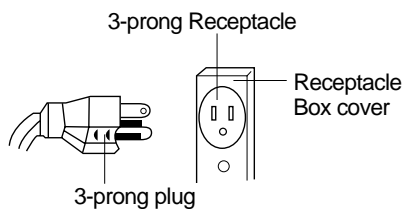

When use grounding adaptor, make sure the receptacle box is fully grounded.

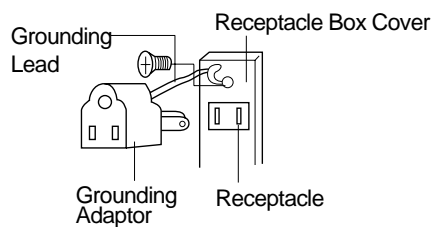

“THE CANADIAN ELECTRICAL CODE DOES NOT ALLOW THE USE OF THE GROUNDING ADAPTOR”

IMPORTANT SAFETY INSTRUCTIONS

When using electrical appliances, basic safety precautions should be followed, including the following:

WARNING - To reduce the risk of burns, electric shock, fire, injury to persons or exposure to excessive microwave energy:

1. Read all instructions before using the appliance.
2. Read and follow the specific "PRECAUTIONS TO AVOID POSSIBLE EXPOSURE TO EXCESSIVE MICROWAVE ENERGY" found on page 1.
3. This appliance must be grounded. Connect only to properly grounded outlet.
See "GROUNDING INSTRUCTIONS" found on page 2.
4. Install or locate this appliance only in accordance with the provided installation instructions.
5. Some products such as whole eggs and sealed containers - for example, closed glass jars-are able to explode and should not be heated in this oven.
6. As with any appliance, close supervision is necessary when used by children.
7. Only allow children to use the oven without supervision when adequate instructions have been given so that the child is able to use the oven in a safe way and understands the hazards of improper use.
8. Do not operate this appliance if it has a damaged cord or plug, if it is not working properly, or if it has been damaged or dropped.
9. This appliance should be serviced only by qualified service personnel. Contact nearest authorized service facility for examination, repair or adjustment.
10. Do not cover or block any openings on the appliance.
11. Do not store this appliance outdoors. Do not use this product near water — for example, near a kitchen sink, in a wet basement, or near a swimming pool, or similar locations.
12. Do not immerse cord or plug in water.
13. Keep cord away from heated surfaces.
14. Do not let cord hang over edge of table or counter.
15. When cleaning surfaces of door and oven that comes together on closing the door, use only mild, non-abrasive soaps or detergents applied with a sponge or soft cloth
16. To reduce the risk of fire in the oven cavity:
 - a) Do not overcook food. Carefully attend appliance when paper, plastic, or other combustible materials are placed inside the oven to facilitate cooking.
 - b) Remove wire twist-ties from paper or plastic bags before placing bag in oven.
 - c) If materials inside the oven ignite, keep oven door closed, turn oven off, and disconnect the power cord, or shut off power at the fuse or circuit breaker panel.
- d) Do not use the cavity for storage purposes. Do not leave paper products, cooking utensils, or food in the cavity when not in use.
17. Do not use this microwave oven to heat corrosive chemicals (for example, sulfides and chlorides). Vapours from such corrosive chemicals may interact with the contact and springs of the safety interlock switches thereby rendering them inoperable.
18. Keep the waveguide cover clean at all times.
Wipe the oven interior with a soft damp cloth after each use.
If you leave grease or fat anywhere in the cavity it may overheat, smoke or even catch fire when next using the oven.
19. Never heat oil or fat for deep frying as you cannot control the temperature and doing so may lead to overheating and fire.
20. Liquids, such as water, coffee, or tea are able to be overheated beyond the boiling point without appearing to be boiling due to surface tension of the liquid. Visible bubbling or boiling when the container is removed from the microwave oven is not always present. **THIS COULD RESULT IN VERY HOT LIQUIDS SUDDENLY BOILING OVER WHEN A SPOON OR OTHER UTENSIL IS INSERTED INTO THE LIQUID.**
To reduce the risk of injury to persons:
 - ① Do not overheat the liquid.
 - ② Stir the liquid both before and halfway through heating it
 - ③ Do not use straight-sided containers with narrow necks.
 - ④ After heating, allow the container to stand in the microwave oven for a short time before removing the container.
 - ⑤ Use extreme care when inserting a spoon or other utensil into the container.
21. Oversized foods or oversized metal utensils should not be inserted in a microwave oven as they may create a fire or risk of electric shock.
22. Do not clean with metal scouring pads. Pieces can burn off the pad and touch electrical parts involving a risk of electric shock.
23. Do not store any materials, other than manufacturer's recommended accessories, in this oven when not in use.
24. Do not cover racks or any other part of the oven with metal foil. This will cause overheating of the oven.
25. Do not operate the oven without the glass tray in place. Be sure it is properly sitting on the rotating base.

Prior to use(If your oven has a grill element)

In order to protect your oven during transportation and storage, the grill element is covered with a protective coating. To remove this coating the grill element must be heated for 5 minutes. This procedure will produce some bad odors as the protective coating on the element disappears.

SAVE THESE INSTRUCTIONS

GENERAL USE

Listed below are, as with all appliances, certain rules to follow and safeguards to assure top performance from this oven:

1. Do not use the oven for any reason other than food preparation, such as for drying clothes, paper, or any other nonfood items or for sterilizing purposes. They may catch on fire.
2. Do not use the oven when empty, this could damage the oven.
3. Do not use the oven cavity for any type of storage, such as papers, cookbook, cookware, etc.
4. Do not operate the oven without the metal tray in place. Be sure it is properly sitting on the rotating base.
5. Be caution when removing the metal tray after cooking meats that may have caused an accumulation of grease in the tray.
6. Unlike microwave-only ovens, this oven may become hot on the cabinet and oven door. Always use hot pads or oven mitts when placing or removing food and/or accessories from the oven. Be cautions about touching parts other than control panel during or immediately following grill or combination cooking.
7. If the oven is hot from combination cooking, do not use plastic or Styrofoam cookware for microwave cooking. They may melt.
8. Do not use recycled paper products for cooking. They may contain impurities which could cause sparks and/or fires when used during cooking.
9. Do not continue to cook with metal utensils if sparking appears. See "Accessories" section on page 7 for proper use of cookware.
10. Do not leave the oven unattended during short cooking times. Overcooking and fire may result.
11. Do not cook any food surrounded by a membrane, such as egg yolks, potatoes, chicken livers, etc., without first piercing them several times with a fork.
12. Do not pop popcorn unless popped in a microwave approved popcorn popper or unless it's commercially packaged and recommended especially for microwave ovens. Microwave popped corn produces a lower yield than conventional popping; there will be a number of unpopped kernels. Do not use oil unless specified by the manufacturer.
13. Do not attempt to operate this appliance with the door open.
14. Do not attempt to remove covers, panels, etc.
15. Look at the oven from time to time when food is heated or cooked in disposable containers of plastic, paper or other combustible materials.
16. If smoke is observed, switch off or unplug the appliance and keep the door closed in order to stifle any flames.
17. Microwave heating of beverages can result in delayed eruptive boiling, therefore care has to be taken when handling the container.
18. Make sure you remove caps or lids prior to cooking when you cook food sealed in bottles.
19. Do not put foreign material between the oven surface and door. It could result in excessive leakage of microwave energy.
20. When heating food in plastic or paper containers, keep an eye on the oven due to the possibility of ignition.
21. Always test the temperature of food or drink which has been heated in a microwave oven before you give it to somebody, especially to children or elderly people. This is important because things which have been heated in a microwave oven carry on getting hotter even though the microwave oven cooking has stopped.
22. Eggs in their shell and whole hard-boiled eggs should not be heated in microwave ovens since they may explode, even after microwave heating has ended;
23. Keep the waveguide cover clean at all times. Wipe the oven interior with a soft damp cloth after each use. If you leave grease or fat anywhere in the cavity it may overheat, smoke or even catch fire when next using the oven.
24. Never heat oil or fat for deep frying as you cannot control the temperature and doing so may lead to overheating and fire.
25. During use the appliance becomes hot. Care should be taken to avoid touching heating elements inside the oven.

COOKING UTENSILS

Utensils should be checked to ensure that they are suitable for use in microwave ovens.

UTENSIL TEST

Dishes that do not absorb microwave energy are best for microwave cooking. Look on the label to verify that particular cups, glasses, plates are indeed suitable, especially paper goods. If you are not sure, try this utensil test to check.

- Put the empty utensil in the microwave oven.
- Put one cup of water in a glass measure next to the empty utensil.
- Heat on P-HI for 1 minute.
- After 1 minute the water should be warm but the utensil should not. If the utensil is warm, it is not suitable for microwave cooking.

Recommended Use

Glass and glass-ceramic bowls and dishes - Use for heating or cooking.

Microwave browning dish - Use to brown the exterior of small items such as steaks, chops, or pancakes. follow the directions provided with you browning dish.

Microwaveable plastic wrap - Use to retain steam.

Leave a small opening for some steam to escape and avoid placing it directly on the food.

Wax paper - Use as a cover to prevent spattering.

Paper towels and napkins - Use for short term heating and covering; they absorb excess moisture and prevent spattering. Do not use recycled paper towels, which may contain metal and can catch fire.

Thermometers - Use only those labeled "Microwave Safe" and follow all directions. Check the food in several places. Conventional thermometers may be used once the food has been removed from the oven.

Limited Use

Aluminum foil - Use narrow strips of foil to prevent overcooking of exposed areas. Using too much foil can damage your oven, so be careful.

Ceramic, porcelain, and stoneware - use these if they are labeled "Microwave Safe." If they are not labeled, test them to make sure they can be used safely. Never use dishes with metallic trim.

Plastic - Use only if labeled "Microwave Safe." Other plastics can melt.

Straw, wicker, and wood - Use only for short-term heating, as they can be flammable.

Not Recommended

Glass jars and bottles - Regular glass is too thin to be used in a microwave, and can shatter.

Paper bags - These are a fire hazard, except for popcorn bags that are designed for microwave use.

Styrofoam plates and cups - These can melt and leave an unhealthy residue on food.

Plastic storage and food containers - Containers such as margarine tubs can melt in the microwave.

Metal utensils - These can damage your oven.

Remove all metal before cooking.

TO AVOID EXPLOSION AND SUDDEN BOILING

WARNING

Liquids, such as water, coffee, or tea are able to be overheated beyond the boiling point without appearing to be boiling due to surface tension of the liquid. Visible bubbling or boiling when the container is removed from the microwave oven is not always present. This could result in very hot liquids suddenly boiling over when a spoon or other utensil is inserted into the liquid.

To reduce the risk of injury to persons:

- Do not overheat the liquid.
- Stir the liquid both before and halfway through heating it
- Do not use straight-sided containers with narrow necks.
- After heating, allow the container to stand in the microwave oven for a short time before removing the container.
- Use extreme care when inserting a spoon or other utensil into the container.

1. Eggs

Never cook eggs in their shells. Steam will build up inside the shell during cooking and the egg will explode. If you want to cook or reheat eggs which have not been broken up by scrambling or mixing, you must always pierce the yolks or these will also explode. You should slice shelled hard boiled eggs before you reheat them in your microwave oven.

2. Piercing

Always pierce food which has a skin or membrane, for example, potatoes, tomatoes, apples, sausages etc. If you don't pierce them, steam will build up inside and they may explode.

3. Lids

Always remove the lids of jars and containers and take away food containers, before you cook using your microwave oven. If you don't, then steam and pressure might build up inside and cause an explosion even after the microwave cooking has stopped.

WHICH UTENSIL CAN BE USED IN THE OVEN?

Only use utensils that are suitable for use in microwave ovens.

Before use, the user should check that utensils are suitable for use in microwave ovens.

Material	Grill & Convection cooking	Microwave cooking	Combined cooking
Glass (general)	No	Yes (1)	No
Glass (heat resistant)	Yes	Yes	Yes
Glass-ceramic and ceramic (heat resistant)	Yes	Yes (1)	Yes (1)
Earthenware	Yes	Yes	Yes
China (heat resistant)	Yes	Yes	Yes
Plastic (general)	No	Yes (2)	No
Plastic (heat resistant)	Yes (2)	Yes (2)	Yes (2)
Aluminium foil containers /aluminium foil	Yes	Yes (3)	Yes
Metal baking tins	Yes (4)	No	Yes (4)
Metal (pots.pans, etc)	Yes	No	No
Paper	No	Yes	No

- Without metal parts or metal trims.
- Some plastics are heat-proof only to certain temperatures.
Check carefully!
- It is possible to use aluminium foil to shield delicate areas of food (this prevents over-cooking).
- Metal tins can be used in the combination methods, however if these are very deep, they will greatly reduce the efficiency, as metal shields the microwave energy from the food.

Microwave function only

Utensils and cooking containers used in a microwave oven should be of a material that does not act as a barrier to microwave energy. Generally this means that you should cook in either (paper), plastic, glass or ceramic. Metal pans reflect microwave energy and inhibit cooking, and should not be used. In addition to material, the shape of the container should also be considered. Round oval shapes give the most even cooking. Square or rectangular containers may over-cook foods in the corners because more energy is absorbed there. Shallow containers give more even cooking results.

Utensils made of china and ceramic excellent to use in your microwave oven. Most types of glass are also very good. Lead crystal glass can crack and should therefore, not be used. Plastics and paper can also be used, provided they can withstand the temperature of the heated food. For cooking only use plastics, which will withstand a temperature of over 250°F, e.g. polypropylene and polyamide. Some plastic materials, e.g. melamine, will be heated by the microwave, and be damaged. To find out if a certain container is suitable, the following simple test can be made: Place the empty container and a glass of water inside the microwave oven. The water is needed because the oven must not be operated empty or with empty containers only. Let the oven work on full power for one minute. A suitable container will only be lukewarm.

Metal containers, e.g. saucepans or frying pans should not be used in microwave ovens. Nor should plates or vessels with decorations be used since metal e.g. gold, might be part of the decoration and such decorations will be damaged. Small pieces of aluminium foil can 430°F used, but only to shield the areas that would over-cook (e.g. for covering chicken wings, leg tips and fish tails) but the foil must not touch the side of the oven as damage may occur.



Caution:

- There are a number of accessories available on the market. Before you buy, make sure they are suitable for microwave use.
- When you put food in the microwave oven, make sure that food, food supports or covering do not come in direct contact with any of the internal walls or the ceiling of the cavity since discolouration may take place.

CONTROL PANEL

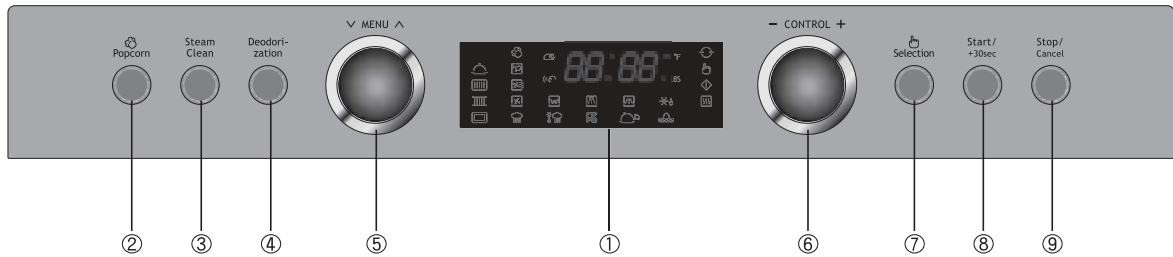

① Display

The display shows you some information such as cooking time, menu, quantity and temperature and so on.

② Popcorn() Button

You can pop 3.0 or 3.5 ounces of popcorn quickly and easily.

③ Steam cleaning() Button

This function helps you to clean the inside of oven.

④ Deodorization() Button

The oven has a special function to blow off smells in the oven.

⑤ Menu Dial Knob :

You can choose a cooking menu by turning the **Menu Dial** knob.

⑥ Control Dial Knob () :

You can enter cooking time, quantity, weight, and temperature by turning the **Control Dial** knob.

⑦ Selection() Button: You can confirm the contents you entered by pressing the **Selection** button.

⑧ Start/Speedy Cook () Button:

- You can start cooking immediately by pressing the **Start** button after entering cooking information such as cooking time, power level and so on.
- You can start the **Microwave** cook at power level 10 quickly by pressing the **Start** button.
- You can add 30 seconds to the cooking time up to 5 minutes each time the **Start** button is pressed.

⑨ Stop/Cancel() Button:

It is used for stopping the oven operation or clearing the display.



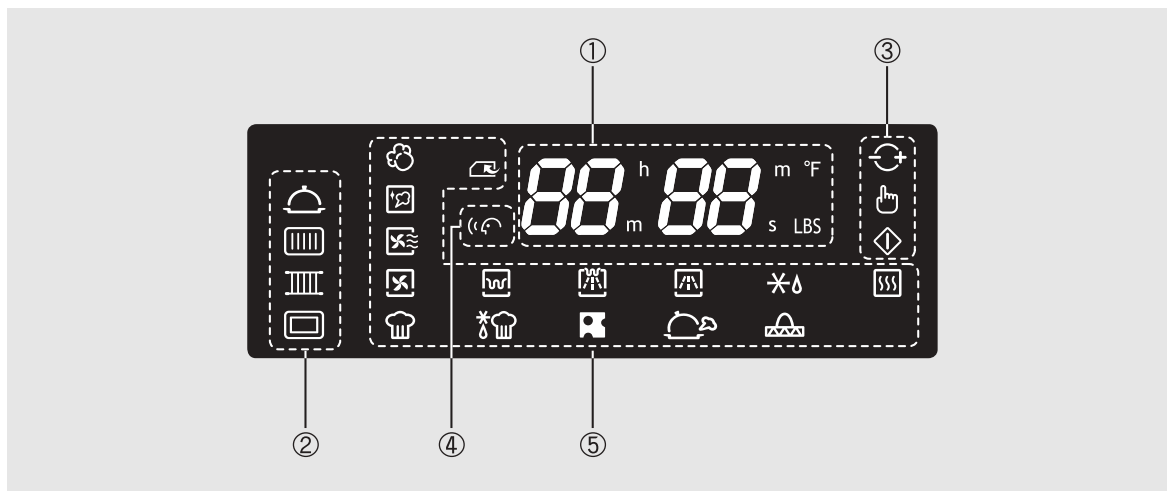





DISPLAY WINDOW









① Display window

The display shows you some cooking information such as cooking time, clock, temperature, quantity and so on.



② Icons of cookware

-  : It means a Steam bowl. If  lights in the display , use a steam bowl for cooking. (This is optional feature.)
-  : It means a Grill tray. If  lights in the display , use a grill tray for cooking. (This is optional feature.)
-  : It means a Grill rack. If  lights in the display , use a grill rack for cooking.
-  : It means a Metal tray. If  lights in the display , use a metal tray for cooking.































③ Icons of operation guide

-  : It means the Control dial knob. If  blinks, turn the control dial knob.
-  : It means the Selection button. If  blinks, press the selection button.
-  : It means the Start button. If  blinks, press the start/speedy cook button.

④ Icons of voice guide function

-  : It means the Voice guide function. If the voice guide function is activated,  turns on in the display. (Refer to "Setting the volume level" on the page 9.)

⑤ Icons of cooking menu

-  : It means Popcorn.  lights in the display during Popcorn.
-  : It means Steam cleaning.  lights in the display during Steam cleaning.
-  : It means Deodorization.  lights in the display during Deodorization.
-  : It means Convection cook.  lights in the display during Convection cooking.
-  : It means Grill cook.  lights in the display during Grill cooking.
-  : It means Combination cook.  lights in the display during Combination cooking.
-  : It means Microwave cook.  lights in the display during Microwave cooking.
-  : It means Auto defrost.  lights in the display during Auto defrosting.
-  : It means Auto cook.  lights in the display during Auto cook.
-  : It means Instant cook.  lights in the display during Instant cook.
-  : It means Fermentation.  lights in the display during Fermentation.
-  : It means Steam cook.  lights in the display during Steam cook. (This is optional feature.)
-  : It means Mexican cook.  lights in the display during Mexican cook. (This is optional feature.)
-  : It means Memory cook.  lights in the display during Memory cook.
-  : It means Preheating.  lights in the display during preheating in Convection cooking.

ACCESSORIES

This oven is equipped with several accessories. They can be used in various ways to facilitate cooking.

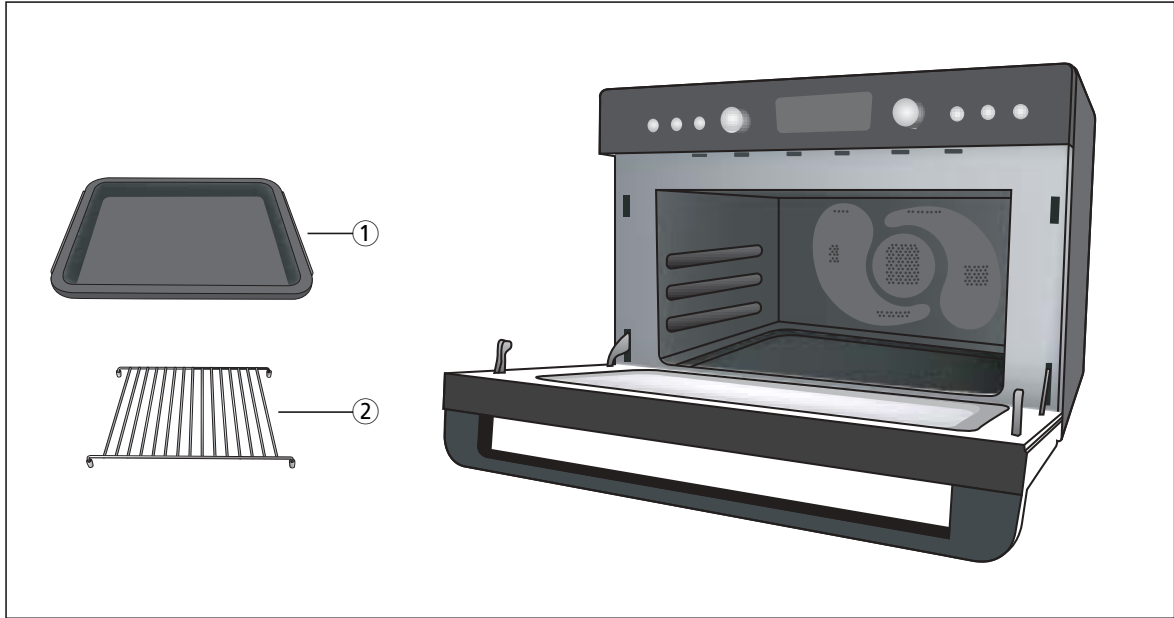



① **Metal Tray** - Put food or proper cookware on the metal tray.

NOTE : Metal Tray is attached to the left cushion.

② **Grill Rack** - Put the grill rack on the metal tray.
It should be always used with the metal tray for cooking.

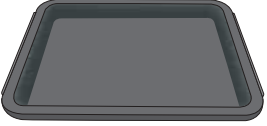
■ HOW TO USE THE ACCESSORIES OF COOKING

■ Metal Tray	■ Grill Rack
 <ul style="list-style-type: none"> • Microwave cooking • Auto defrosting • Quick defrosting • Fermentation • Memory cooking • Convection cooking • Auto cook menu: 3, 5 • Instant cook menu: 1, 5 	 <ul style="list-style-type: none"> • Put the grill rack on the metal tray. • It should be always used with the metal tray for cooking. • Grill cooking • Auto cook menu: 1, 2, 4, 6 • Instant cook menu: 2, 3, 4

SETTING THE VOLUME LEVEL

The volume level for voice guide function can be adjusted.

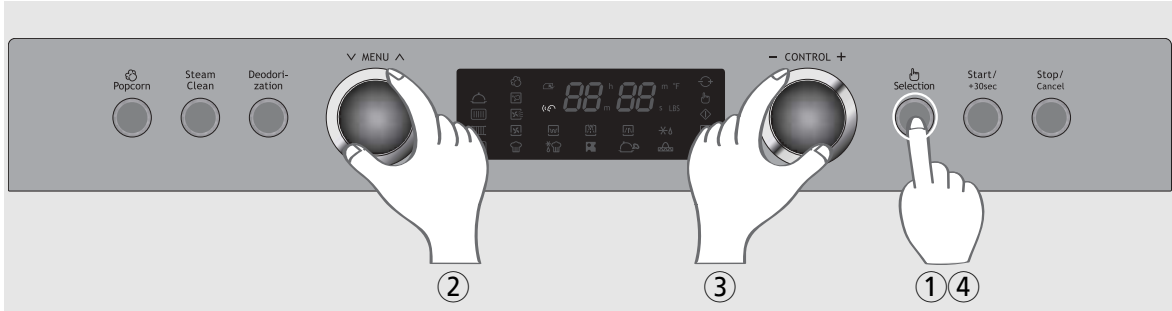

Example : To set the volume level on 2.



1. Press and hold the **Selection** button for 3 seconds.
The display shows "Func".



2. Turn the **Menu Dial** knob until the display lights **Voice guide function**.



3. Turn the **Control Dial** knob to select the volume level.
(example: When the volume level is adjusted to 2)
The volume level can be adjusted from 0 to 5.
(0= Mute, 1=Whispered, 2=Low, 3=Norm, 4=Loud, 5=MAX.)

If you don't want the voice guide function to work, choose 0 for mute.

4. Press the **Selection** button. Then the setting is completed.

Note :

If you select the volume level 0 for mute, the Voice indicator disappears in the display.
When the oven comes out of the factory, the volume level has been adjusted to 3.

POPCORN

You can pop a prepackaged microwave popcorn quickly and easily.
Please use only with prepackaged microwave popcorn weighing 3.0 to 3.5 ounces.

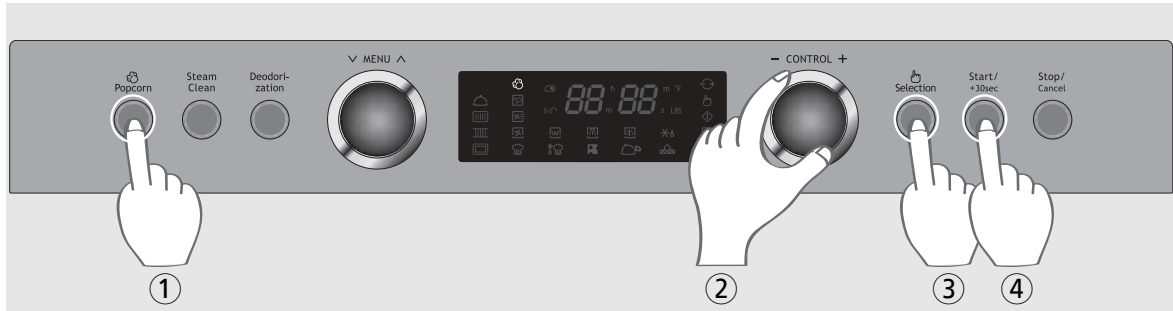

1. Press the **Popcorn** button. ()



2. Turn the Control **Dial knob** to set the weight.
(example : 3.5oz)



3. Press the **Selection** button. ()
In this procedure, you can add or subtract extra cooking time to the automatic cooking time (Min: 1min, Max : 5min) by turning the Control Dial knob.

4. Press the **Start** button .
The cooking time is automatically determined by the weight.



5. The display shows "**End**" and beep sounds when the cooking is completed.

WARNING : The oven and accessories are very hot after cooking.
Use a thick oven glove while you are handing food or accessories.

Note : • When you operate the oven at the first time, smoke and bad odor might come out from the oven. Then, it will be helpful to operate the oven in **Convection cook** at 430°F with no food for about 10 minutes.
• The cooling fan could be operated for a few minutes after cooking for the safety. The display will show "**Cool**" and "**0**" or "current time" in turns while the cooling fan is operated.

AUTO COOK

This function allows you to cook some kind of popular food easily and automatically.

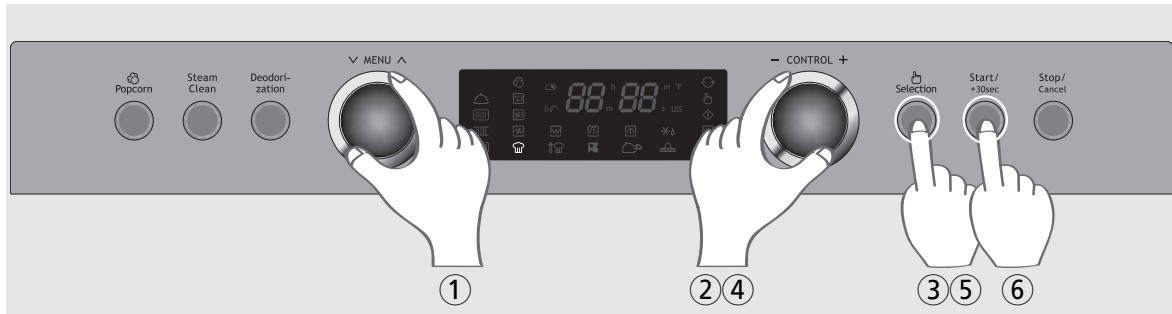

1. Turn the **Menu Dial Knob** to adjust to **AUTO COOK** .



2. Turn the **control dial knob**  to select **AUTO COOK** menu.

(example: Roast Pork)

- Three little horizontal bars turn on in the left side of the display and one of them blinks.
- It means an indicator of the place where a metal tray and grill rack is laid.
- If the second bar is blinking, it means a designated accessory is supposed to be laid on the second level in the oven.

3. Press the **Selection** button .



4. Turn the **control dial knob**  to set the weight.

(example : 2.0lb)

Refer to the auto cook menu chart on the next page.

5. Press the **Selection** button .

- In this procedure, you can add or subtract extra cooking time to the automatic cooking time by turning the **Control Dial** knob.



6. Press the **Start** button .

The cooking time is automatically determined by the weight

7. The display shows "**End**" and beep sounds when the cooking is completed.



WARNING: The oven and accessories are very hot after cooking.
Use a thick oven glove while you are handling food or accessories.

NOTE:

- When you operate the oven at the first time, smoke and bad odor might come out from the oven. Then, it will be helpful to operate the oven in **Convection cook** at 430°F with no food for about 10 minutes.
- The cooling fan could be operated for a few minutes after cooking for the safety. The display will show "**Cool**" and "**0**" or "current time" in turns while the cooling fan is operated.

Auto Cook Menu Chart

NO	Auto Cook Menu	Minimum Weight	Maximum Weight	Weight Step
1	ROAST PORK	2.0lb	4.0lb	0.2lb
2	ROAST BEEF	2.0lb	4.0lb	0.2lb
3	ROAST CHICKEN	2.0lb	3.4lb	0.2lb
4	BAKED FISH	0.6lb	1.8lb	0.2lb
5	FRESH VEGETABLE	0.4lb	1.0lb	0.1lb
6	CHICKEN PIECES	0.6lb	1.6lb	0.2lb

NO	Auto Cook Menu	Start Temp.	Method	Cookware	Features
1	ROAST PORK	Chilled temp.	1. Tie the joint into a neat shape. 2. Place the meat on the dish. 3. Brush with a little oil. 4. Place roasts fat-side down on the grill rack on the metal tray. 5. Cook on "AUTO COOK-ROAST PORK or ROAST BEEF". 6. When Beep, turn food over. 7. Remove from oven. Drain off any excess juices. 8. Stand for 10 minutes in foil before serving.	Metal tray Grill rack on the second level	Combination
2	ROAST BEEF				
3	ROAST CHICKEN	Chilled temp.	1. Wash and dry chicken. Tie the legs loosely together with string. 2. Pierce the skin a couple of times just under the legs. 3. Brush butter mixture all over the chicken on the dish. 4. Place roasts breast-side up on the metal tray. 5. Cook on "AUTO COOK-ROAST CHICKEN". 6. Remove from oven. Drain off any excess juices. Season with salt if required. Stand for 10 minutes in foil before serving.	Metal tray on the first level	Combination
4	BAKED FISH	Chilled temp.	1. All types of fresh fish(except battered or breadcrumbed fish) can be cooked whether whole, fillets or steaks. 2. Place the prepared fish in a buttered dish. 3. Season with salt and pepper, sprinkle with lemon juice and dot with butter. Do not cover dish. 4. Place on dish on the grill rack on the metal tray. 5. Cook on "AUTO COOK- BAKED FISH".	Metal tray Grill rack on the second level	Combination
5	FRESH VEGETABLES		1. Wash and trim. 2. Place prepared vegetables into a suitable sized container. 3. Sprinkle with 4-5 tbs. of water. 4. Cover with pierced cling film or a lid. 5. Place on dish on the metal tray. 6. Cook on "AUTO COOK- FRESH VEGETABLES." * For best results cut vegetables into similar sized pieces.	Metal tray on the first level	Microwave only
6	CHICKEN PIECES		1. Place the chicken pieces on the grill rack on the metal tray. 2. Cook on "AUTO COOK - CHICKEN PIECES". 3. When Beep, turn food over. 4. And the press start to continue cooking. 5. After cooking, stand covered with foil for 2~5minutes.	Metal tray Grill rack on the second level	Combination

INSTANT COOK

This function allows you to cook some kind of instant food easily and automatically.

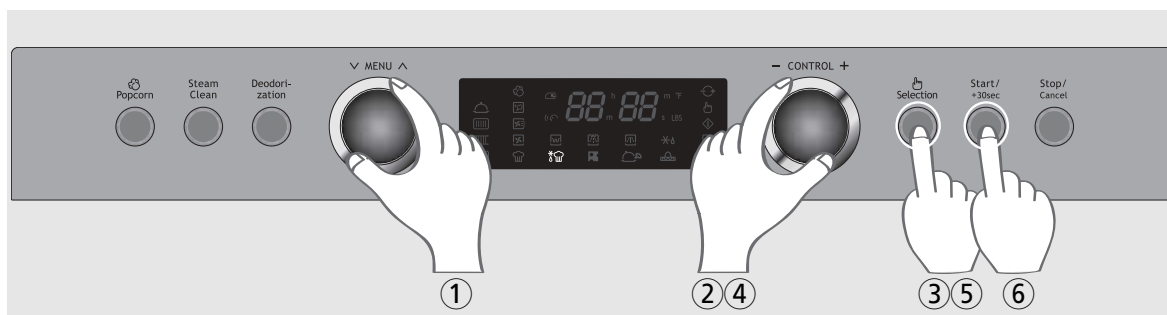

1. Turn the **Menu Dial Knob** to adjust to **INSTANT COOK** .



2. Turn the **control dial knob** to select Instant Cook menu.

(**example:** Frozen Hamburger)

- Three little horizontal bars turn on in the left side of the display and one of them blinks.
- It means an indicator of the place where a metal tray is laid.
- If the first bar is blinking, it means a designated accessory is supposed to be laid on the first level in the oven.

3. Press the **Selection button**.



4. Turn the **control dial knob** to enter the cooking quantity
Refer to the Instant cook menu chart on the next page.



5. Press the **Selection button**.

- In this procedure, you can add or subtract extra cooking time to the automatic cooking time by turning the Control Dial knob.

6. Press the **Start button**.

The cooking time is automatically determined by the weight



7. The display shows **"End"** and beep sounds when the cooking is completed.

WARNING: The oven and accessories are very hot after cooking.
Use a thick oven glove while you are handling food or accessories.

NOTE: • When you operate the oven at the first time, smoke and bad odor might come out from the oven. Then, it will be helpful to operate the oven in **Convection cook** at 430°F with no food for about 10 minutes.

- The cooling fan could be operated for a few minutes after cooking for the safety. The display will show **"Cool"** and **"0"** or "current time" in turns while the cooling fan is operated.

Instant Cook Menu Chart

No	Instant Cook Menu	Minimum Weight	Maximum Weight	Weight Step
1	FROZEN HAMBURGER	1 pcs	4 pcs	1 pcs
2	SAUSAGE	0.2lb	1.0lb	0.2lb
3	BAKED POTATO	1 pcs	5 pcs	1 pcs
4	FROZEN PIZZA	0.2lb	1.4lb	0.1lb
5	FROZEN VEGETABLE	0.4lb	1.0lb	0.1lb

No	Instant Cook Menu	Weight	Method	Cookware	Features
1	Frozen Hamburger	1pcs~4pcs	Remove from package and wrap in paper towel. Place Hamburgers directly on the metal tray. Set the weight and press Start button.	Metal tray on the first level	Microwave only
2	Sausage		Clean the sausages from cover and pierce with fork. Place sausages on the grill rack on the metal tray. Set the weight and press Start button. Turn over when oven beeps.	Metal tray Grill rack on the second level	Combination
3	Baked Potato	1pcs~5pcs	Choose medium sized potatoes 0.4~0.5lb. Wash and pierce with fork. Place potatoes on the grill rack on the metal tray. Set the weight and press Start button.	Metal tray Grill rack on the second level	Combination
4	Frozen Pizza		Remove from package. Place pizza on the grill rack on the metal tray. Set the weight and press Start button.	Metal tray Grill rack on the second level	Combination
5	Frozen Vegetable		Place in a suitable sized container. Add to 2 tbsp. of water. Cover with piercad cling film or a lid. Set the weight and press Start button. Stir after cooking. * Frozen vegetables may be cooked without any added water if preferred.	Metal tray on the first level	Microwave only

MICROWAVE COOK

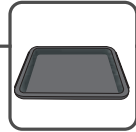

This function allows you to cook food with microwave energy. You can change the microwave power level from P-00 to P-HI. Each power level gives you microwave energy a certain percent of the time. P-HI means that the oven cooks food at full microwave energy. P-90 means that the oven cooks food at 90% microwave energy. A high setting will cook faster but food may need more frequent stirring, rotating or turning over. A lower setting will cook more evenly and need less stirring or rotating of the food. If the oven has been heated after grill cooking, convection cooking, or combination cooking, it may need to be cooled down before microwave cook. Never operate the oven with no food inside in microwave cook. It may cause fire to happen.

Tips : 1) Read this manual. It contains instructions to help you use and maintain your microwave oven properly.
 2) If you open the door during microwave cooking, the oven stops to working immediately.
 Then if you press the Start button, it restart to working. Or if you press the Stop/Cancel button, the cooking process is cancelled.

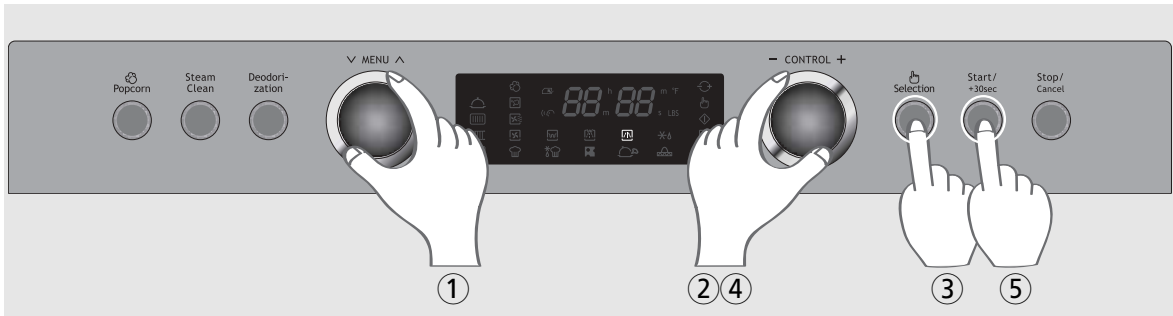

1. Turn the **Menu Dial Knob** to adjust to **MICROWAVE COOK** .



2. Select the appropriate power level by turning the **control dial knob** until the corresponding percentage is displayed.
 (example: for maximum power level cooking)



3. Press the **Selection button** .



4. Turn the **Control Dial Knob** to enter the cooking time.
 (example: 10 minutes of cooking time.)
 You can enter the cooking time up to 60 minutes in Microwave cook.

5. Press the **Start button** .



6. The display shows **"End"** and beep sounds when the cooking is completed.

Power level table					
Power level	percentage	Output	Power level	percentage	Output
P-HI	100%	800W	P-40	40%	320W
P-90	90%	720W	P-30	30%	240W
P-80	80%	640W	P-20	20%	160W
P-70	70%	560W	P-10	10%	80W
P-60	60%	480W	P-00	0%	0W
P-50	50%	400W			

WARNING: The oven and accessories are very hot after cooking.
 Use a thick oven glove while you are handing food or accessories.
Make sure that a metal tray is laid on the first level in the oven before Microwave cooking.

NOTE: • When you operate the oven at the first time, smoke and bad odor might come out from the oven. Then, it will be helpful to operate the oven in **Convection cook** at 430°F with no food for about 10 minutes.
 • The cooling fan could be operated for a few minutes after cooking for the safety.
 The display will show **"Cool"** and **"0"** or "current time" in turns while the cooling fan is operated.

SPEEDY COOK

This function allows you to cook immediately at full power of microwave energy only. It can be used as a speedy cook for 30 seconds. Then You can add 30 seconds to the time counting down each time the Start button is pressed. The maximum cooking time is 5 minutes.

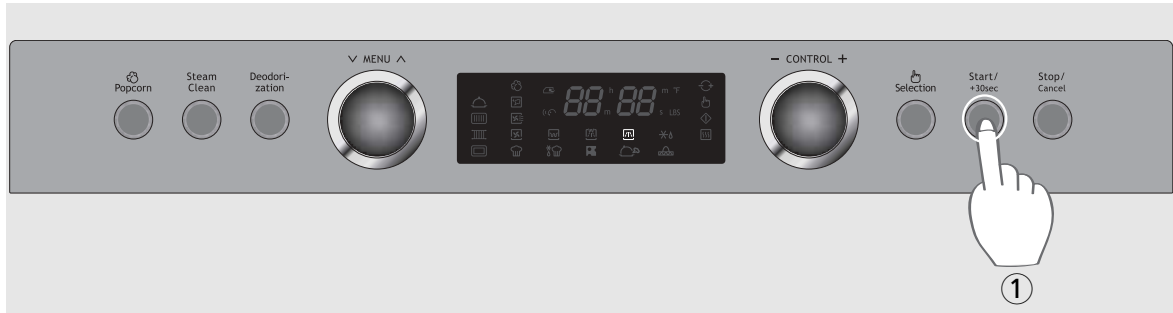

1. Press **START** button  .
The display shows "**30s**".
And the oven will start immediately.
(**example:** when you press the start button five times.)



2. The display shows "**End**" and beep sounds when the cooking is completed.

WARNING: The oven and accessories are very hot after cooking.
Use a thick oven glove while you are handling food or accessories.
Make sure that a metal tray is laid on the first level in the oven before Microwave cooking.

NOTE:

- When you operate the oven at the first time, smoke and bad odor might come out from the oven. Then, it will be helpful to operate the oven in **Convection cook** at 430°F with no food for about 10 minutes.
- The cooling fan could be operated for a few minutes after cooking for the safety. The display will show "**Cool**" and "**0**" or "current time" in turns while the cooling fan is operated.

CONVECTION COOK (Without Preheating)

This function enables you to cook food in the same way as in a traditional oven.

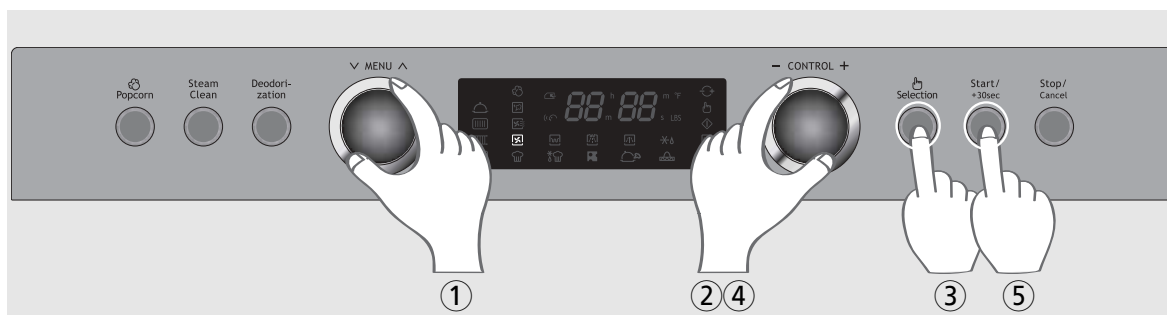

1. Turn the **Menu Dial Knob** to adjust to **CONVECTION COOK**.



2. Turn the **Control Dial Knob** to select the Temperature.
(example: 355°F)

Temperature sequence

355°F → 375°F → 390°F → 410°F → 430°F → 210°F → 230°F →
250°F → 265°F → 285°F → 300°F → 320°F → 340°F → 355°F →
375°F → 390°F → 410°F → 430°F

3. Press the **Selection** button.



4. Turn the **control dial knob** to enter the cooking time.
(example: 1 hour)
You can enter the cooking time up to 2 hours in Convection cook.

5. Press the **Start** button.



6. The display shows **"End"** and beep sounds when the cooking is completed.

WARNING: The oven and accessories are very hot after cooking.
Use a thick oven glove while you are handing food or accessories.

NOTE:

- When you operate the oven at the first time, smoke and bad odor might come out from the oven. Then, it will be helpful to operate the oven in **Convection cook** at 430°F with no food for about 10 minutes.
- The cooling fan could be operated for a few minutes after cooking for the safety. The display will show **"Cool"** and **"0"** or "current time" in turns while the cooling fan is operated.

CONVECTION COOK (With Preheating)

For convection cooking, it is recommended that you preheat the oven to the appropriate temperature before placing the food in the oven. The maximum preheating time is 30 minutes. If the cooking is not started immediately after preheating, the preheating indicator will continue to flash and the preheated oven temperature will be displayed. It is maintained for 15 minutes and then it is switched off automatically.

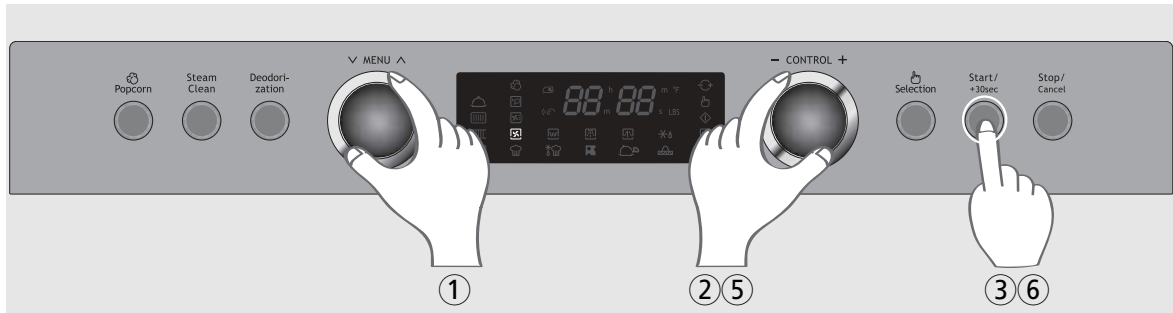

1. Turn the **Menu Dial Knob** to adjust to **CONVECTION COOK**.



2. Turn the **Control Dial Knob** to select the Temperature.
(example: 230°F)

Temperature sequence

355°F → 375°F → 390°F → 410°F → 430°F → 210°F → 230°F →
250°F → 265°F → 285°F → 300°F → 320°F → 340°F → 355°F →
375°F → 390°F → 410°F → 430°F

3. Press the **Start** button .
Temperature of preheating is in the display.
The oven will start preheating.
And is blinking during preheating.

4. When oven temperature reach to the preheating temperature, the oven will beep and the preheating temperature will be blinking in the display.
Then open the door and place your food in the oven.



5. Turn the **control dial knob** to enter the cooking time.
(example: 1 hour)
You can enter the cooking time up to 2 hours in Convection cook.

6. Press the **Start** button .



7. The display shows **"End"** and beep sounds when the cooking is completed.

WARNING: The oven and accessories are very hot after cooking.
Use a thick oven glove while you are handling food or accessories.

NOTE:

- When you operate the oven at the first time, smoke and bad odor might come out from the oven. Then, it will be helpful to operate the oven in **Convection cook** at 430°F with no food for about 10 minutes.
- The cooling fan could be operated for a few minutes after cooking for the safety. The display will show **"Cool"** and **"0"** or "current time" in turns while the cooling fan is operated.

GRILL COOK

The grill enables you to heat and brown food quickly without microwave energy.

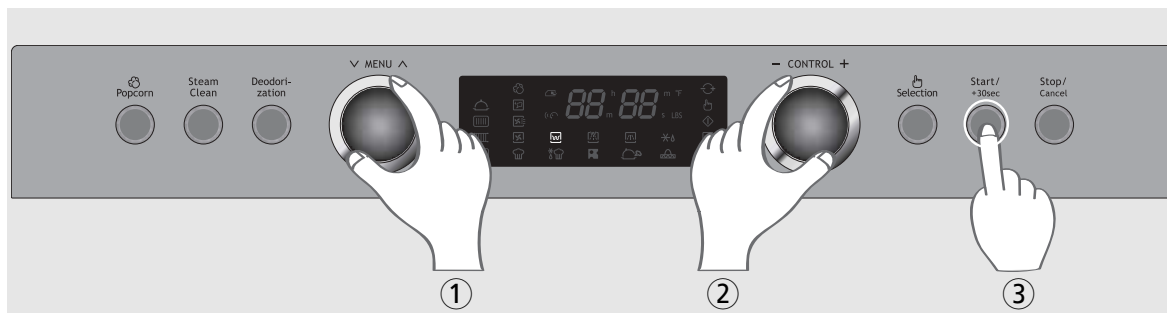

1. Turn the **Menu Dial Knob** to adjust to **GRILL COOK** .

2. Turn the **Control Dial Knob**  to enter the cooking time.

(example: 1 hour of cooking time.)

You can enter the cooking time up to 1 hour and 30 minutes in Grill cook.

3. Press the **Start button** .



4. The display shows "**End**" and beep sounds when the cooking is completed.

Tips : Put food on the grill rack on the metal tray. It helps food get good looking.

WARNING: The oven and accessories are very hot after cooking.
Use a thick oven glove while you are handing food or accessories.

NOTE : • When you operate the oven at the first time, smoke and bad odor might come out from the oven. Then, it will be helpful to operate the oven in **Convection cook** at 430°F with no food for about 10 minutes.

• The cooling fan could be operated for a few minutes after cooking for the safety.

The display will show "**Cool**" and "**0**" or "current time" in turns while the cooling fan is operated.

COMBINATION COOK (Microwave + Convection)

This function allows you to combine convection operation with microwave to produce traditional baked or roasted results in less time. Always use microwave-safe and oven-proof cookware. Glass or ceramic dishes are ideal as they allow the microwaves to penetrate the food evenly.

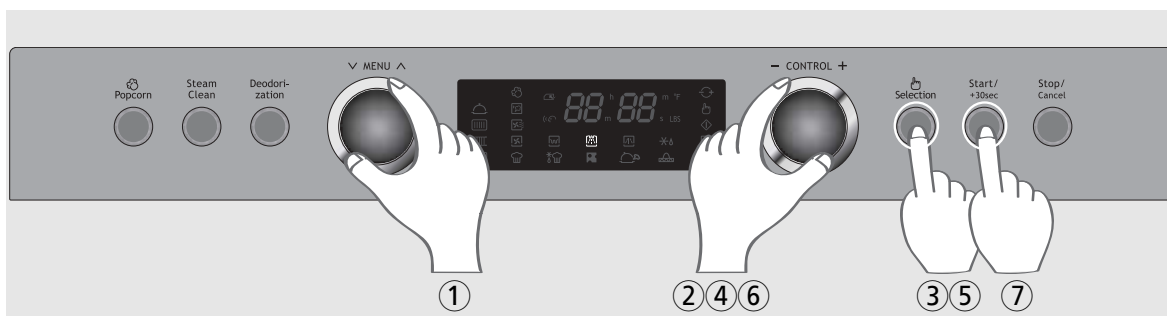

1. Turn the **Menu Dial Knob** to adjust to **COMBINATION COOK** .



2. Select the desired **combi** power level by turning the **Control Dial Knob**.

(example : C-HI)

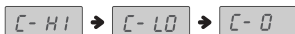

DISPLAY	Microwave Power
C-HI	50%
C-LO	30%
C-0	40%

3. Press the **Selection** button .



4. Turn the **control dial knob**  to select the Temperature.

(example: 355°F)

Temperature sequence
355°F → 375°F → 390°F → 410°F → 430°F → 210°F → 230°F → 250°F → 265°F → 285°F → 300°F → 320°F → 340°F → 355°F → 375°F → 390°F → 410°F → 430°F

5. Press the **Selection** button .



6. Turn the **control dial knob**  to enter the cooking time.

(example: 30minutes)

You can enter the cooking time up to 1 hour in Combination cook.

7. Press the **Start** button .



8. The display shows **"End"** and beep sounds when the cooking is completed.

WARNING: The oven and accessories are very hot after cooking. Use a thick oven glove while you are handing food or accessories.

NOTE:

- When you operate the oven at the first time, smoke and bad odor might come out from the oven. Then, it will be helpful to operate the oven in **Convection cook** at 430°F with no food for about 10 minutes.
- The cooling fan could be operated for a few minutes after cooking for the safety. The display will show **"Cool"** and **"0"** or "current time" in turns while the cooling fan is operated.

AUTO DEFROST (Weight Defrost with Microwave Feature)

Weight Defrost automatically sets the defrosting times and power levels to give even defrosting results for frozen food. During the defrosting process the oven will beep to remind you to check the food. The oven will beep, open the door, turn the frozen food over and close the door, press the **START** button.

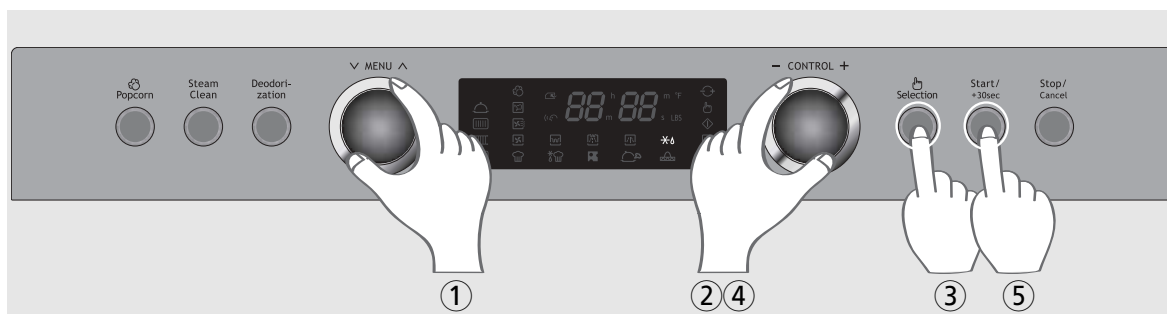
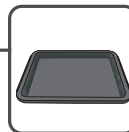

1. Turn the **Menu Dial Knob** to adjust to **AUTO DEFROST** *△.



2. Turn the **control dial knob** ↻ to set **"0 LBS"** in display.



3. Press the **Selection** button 🖱.



4. Turn the **control dial knob** ↻ to enter the weight.

(example : 2.2lb)

You can enter food weight from 0.5lb to 6lb.



5. Press the **Start** button ⏻.

The cooking time is automatically determined by the weight.

6. The oven will beep, open the door, turn the frozen food over and close the door, press the **Start** button ⏻ again.



7. The display shows **"End"** and beep sounds when the cooking is completed.

WARNING: The oven and accessories are very hot after cooking.
Use a thick oven glove while you are handling food or accessories.
Make sure that a metal tray is laid on the first level in the oven before Auto defrosting.

NOTE:

- When you operate the oven at the first time, smoke and bad odor might come out from the oven. Then, it will be helpful to operate the oven in **Convection cook** at 430°F with no food for about 10 minutes.
- The cooling fan could be operated for a few minutes after cooking for the safety. The display will show **"Cool"** and **"0"** or "current time" in turns while the cooling fan is operated.

AUTO DEFROST (Time Defrost with Microwave Feature)

During the defrosting process the oven will beep to remind you to check the food.
The oven will beep, open the door, turn the frozen food over and close the door, press the **START** button.

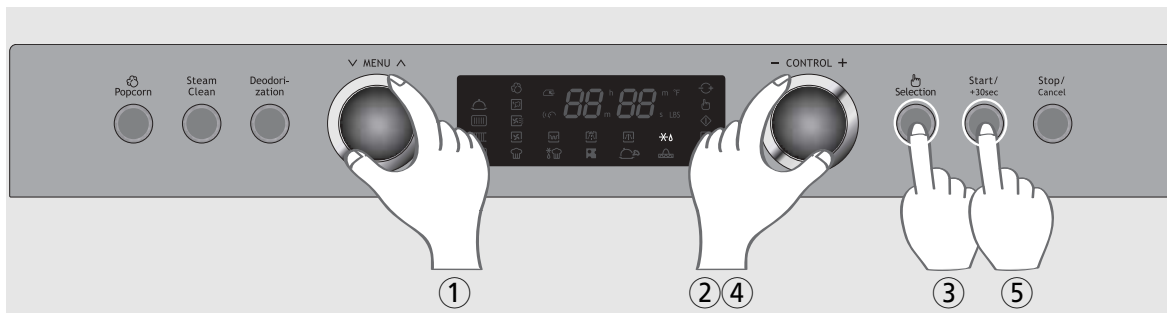
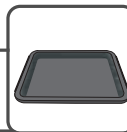

1. Turn the **Menu Dial Knob** to adjust to **AUTO DEFROST** *△.



2. Turn the **control dial knob** ↻ to set "**0 LBS**" in display.



3. Press the **Selection** button 🖱.



4. Turn the **control dial knob** ↻ to enter the defrosting time (**example** : 11minutes)
You can enter the defrosting time up to 60 minutes in Time defrost.

5. Press the **Start** button ⏸.

6. The oven will beep, open the door, turn the frozen food over and close the door, press the **Start** button ⏸ again.



7. The display shows "**End**" and beep sounds when the cooking is completed.

WARNING: The oven and accessories are very hot after cooking.
Use a thick oven glove while you are handling food or accessories.
Make sure that a metal tray is laid on the first level in the oven before Auto defrosting.

NOTE:

- When you operate the oven at the first time, smoke and bad odor might come out from the oven. Then, it will be helpful to operate the oven in **Convection cook** at 430°F with no food for about 10 minutes.
- The cooling fan could be operated for a few minutes after cooking for the safety. The display will show "**Cool**" and "**0**" or "current time" in turns while the cooling fan is operated.

FERMENTATION (with Convection Feature)

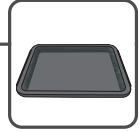

This function helps you to ferment doughs easily.

If the temperature in the inside of oven is high, it might reduce the quality of fermentation. Then you should cool the oven down to the room temperature before fermentation.

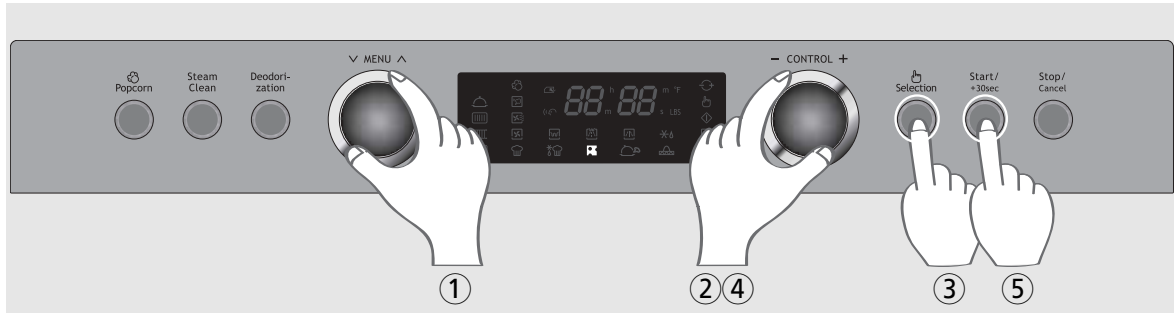

1. Turn the **Menu Dial** knob to adjust to the **Fermentation** .



2. Turn the **Control Dial** knob  to select the temperature.
(**example:** 105°F)

Temperature sequence

105°F → 115°F → 120°F → 95°F

3. Press the **Selection** button .



4. Turn the **Control Dial** knob  to enter the cooking time.
(**example:** 4 hours of cooking time.)

You can enter the cooking time up to 10 hours in Fermentation.

5. Press the **Start** button .

The oven starts working immediately.



6. The display shows "**End**" and beep sounds when the operation is finished.

WARNING: The oven and accessories are very hot after cooking.
Use a thick oven glove while you are handling food or accessories.

NOTE:

- When you operate the oven at the first time, smoke and bad odor might come out from the oven. Then, it will be helpful to operate the oven in **Convection cook** at 430°F with no food for about 10 minutes.
- The cooling fan could be operated for a few minutes after cooking for the safety. The display will show "**Cool**" and "**0**" or "current time" in turns while the cooling fan is operated.

STEAM CLEANING (with Microwave Feature)

This function helps you to clean the inside of oven.

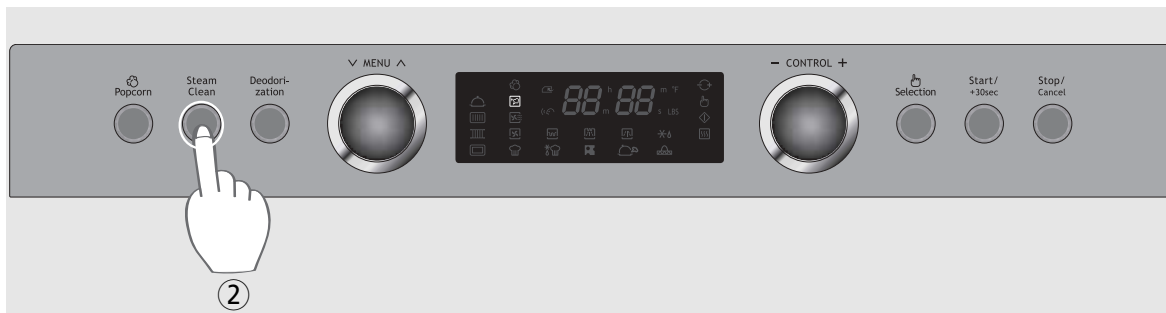
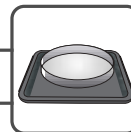

1. Put about 200cc water in a mug cup or small bowl in the middle of the metal tray on the first level in the oven.



2. Press the **Steam cleaning** button  .
The oven starts working immediately, and it works for 15 minutes.



3. The display shows "**door**" and "**oPEn**" in turns for 5 minutes if the operation is finished.



4. Open the door and wipe out the inner cavity with a dry cloth.

WARNING: The oven and accessories are very hot after cooking.
Use a thick oven glove while you are handling food or accessories.
Do not contain water in narrow-necked bottles. Even if the container is opened, pressure can build up. This can cause the container to burst, possibly resulting in injury.
Be careful when you open the door for cleaning inside the oven. Hot steam can cause burns. If possible, wait a little and open the door after finishing operation.

NOTE:

- When you operate the oven at the first time, smoke and bad odor might come out from the oven. Then, it will be helpful to operate the oven in **Convection cook** at 430°F with no food for about 10 minutes.
- The cooling fan could be operated for a few minutes after cooking for the safety. The display will show "**Cool**" and "**0**" or "current time" in turns while the cooling fan is operated.

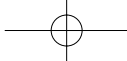

Deodorization (with Convection Feature)

The oven has a special function to blow off smells in the oven.
You'd better put a metal tray on the first level.

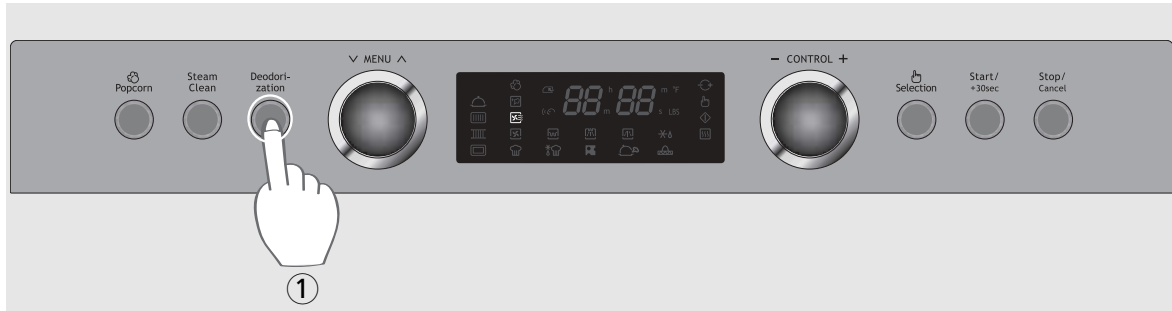
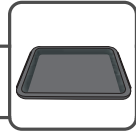

1. Press the **Deodorization** button .

The oven starts working immediately, and it works for 10 minutes.



2. The display shows "**End**" and beep sounds when the cooking is completed.

WARNING: The oven and accessories are very hot after cooking.
Use a thick oven glove while you are handing food or accessories.

NOTE:

- When you operate the oven at the first time, smoke and bad odor might come out from the oven. Then, it will be helpful to operate the oven in **Convection cook** at 430°F with no food for about 10 minutes.
- The cooling fan could be operated for a few minutes after cooking for the safety. The display will show "**Cool**" and "**0**" or "current time" in turns while the cooling fan is operated.

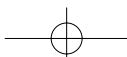

MEMORY COOK (with Microwave Feature)

You can save the microwave cook used frequently in the memory.

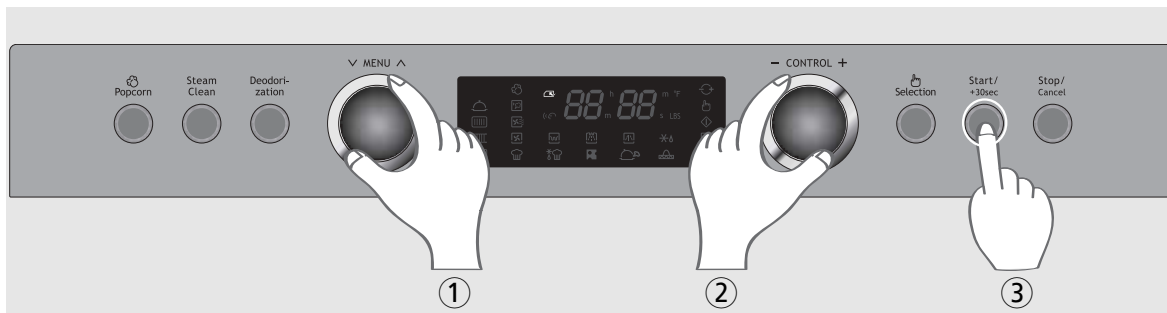
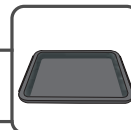

1. Turn the **Menu Dial** knob to adjust to **MEMORY COOK** .



2. Turn the **Control Dial** knob to select the number of memory.
(**example:** When you select the second memory storage)

3. Press the **Start** button .
The oven starts working.



4. The display shows **"End"** and beep sounds when the cooking is completed.

Note : When the oven comes out of the factory, Memory cook has been programmed as below.
But you can change the contents of memory cook later. (refer to next page)

No	Cooking time	Microwave power level
1	0:40	P-HI (100%)
2	1:20	P-HI (100%)
3	2:00	P-HI (100%)

WARNING: The oven and accessories are very hot after cooking.
Use a thick oven glove while you are handing food or accessories.
Make sure that a metal tray is laid on the first level in the oven before Memory cooking.

NOTE: • When you operate the oven at the first time, smoke and bad odor might come out from the oven. Then, it will be helpful to operate the oven in **Convection cook** at 430°F with no food for about 10 minutes.
• The cooling fan could be operated for a few minutes after cooking for the safety.
The display will show **"Cool"** and **"0"** or "current time" in turns while the cooling fan is operated.

SETTING THE MEMORY COOK

You can save the microwave cook used frequently in the memory.

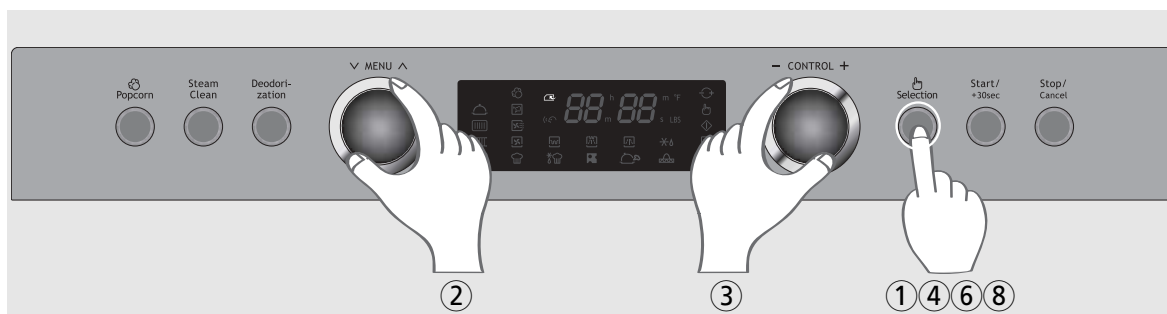

Example: If you want to save 30 seconds of microwave cook at full power into the second memory storage...



1. Press and hold the **Selection** button  for 3 seconds.
The display shows "Func".



2. Turn the **Menu the Dial** knob until the display lights **Memory cook**. 



3. Turn the **Control Dial** knob  to select one of memory storage.
(**example:** When you select the second memory storage)

4. Press the **Selection** button .



5. Turn the **Control Dial** knob  to select the microwave power level.
(**example:** at full power)

6. Press the **Selection** button .



7. Turn the **Control Dial** knob  to enter the cooking time.

8. Press the **Selection** button . Then the setting is completed.

Note :

- You can program three memory cooks in the memory storage.
- Microwave cook is only available for Memory cooking.
- If power is shut down, all the memory cooks stored in the memory storage are lost. And they will be changed to the default memory cooks programmed in the factory.

SETTING THE CLOCK

When the oven is plugged in, the display shows "0" with a sound.
Your oven provides you with a multiple (12hr/ 24hr) time format.
In order to set the clock, follow the steps below.

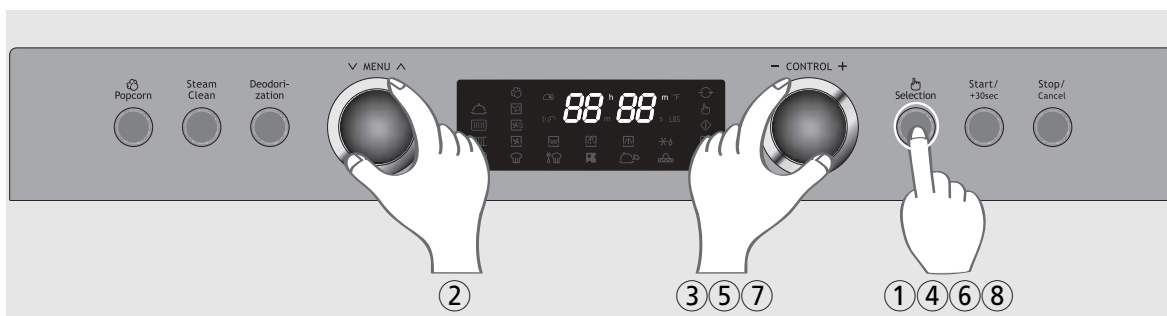

Example: If you want to set the clock to 10:25 ...



1. Press and hold the **Selection** button for 3 seconds.
The display shows "Func".



2. Turn the **Menu Dial** knob until the display shows "0h 0m".



3. Turn the **Control Dial** knob to select time format.
"12H" means 12-hour time format.
"24H" means 24-hour time format.

4. Press the **Selection** button.



5. Turn the **Control Dial** knob to enter the current hours.

6. Press the **Selection** button.



7. Turn the **Control Dial** knob to enter the current minutes.

8. Press the **Selection** button. Then the setting is completed.

Note :

- If you select the 12-hour time format, it will allow you to set the clock from 1:00 to 12:59.
- If you select the 24-hour time format, it will allow you to set the clock from 0:00 to 23:59.
- During power saving mode, the clock is turned off in the display.

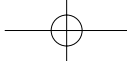

POWER SAVE MODE

Power save mode helps energy to be saved by turning the display off while the oven doesn't work for long time.

If the oven is left for 10 minutes without user's touch on a button and dial, Power save mode will work automatically to turn the display off. The power save mode could be cancelled when you press any button, turn a dial or open the door during the power save mode.

REMINDER

To remind you that you have food in the oven, the oven will display "End" and beep once a minute for 5 minutes until you either open the oven door or press any button.

CHILD LOCK

You may lock the control panel to prevent the oven from being accidentally started or used by children.

To lock or unlock the controls, press and hold the Stop button for about 3 seconds. While the control panel is locked, "Loc" will be displayed briefly when any button is pressed.

TO STOP THE OVEN WHILE THE OVEN IS OPERATING

1. Open the door.
 - Oven stops operating.
 - You can restart the oven by closing the door and touching **START/SPEEDY COOK** button.
2. Press the **Stop/Cancel** button.
 - Oven stops operating.
 - If you wish to cancel the cooking settings, press the **Stop/Cancel** button again.

ABNORMAL MESSAGE

- If the inside temperature of the oven is higher than expected or the temperature sensor doesn't work properly, "Err 2" message will be shown in the display.
- Unplug the power and call our technical service.
- When the temperature sensor is disconnected, "Err 3" message will be shown in the display.
- Unplug the power and call our technical service.

ARCING

If you see arcing, press **Stop/Cancel** button and correct the problem.

Arcing is the microwave term for sparks in the oven. Arcing is caused by:

- Metal or foil touching the side of the oven.
- Foil not molded to food (upturned edges act like antennas).
- Metal, such as twist-ties, poultry pins, or gold rimmed dishes, in the microwave.
- Recycled paper towels containing small metal pieces being used in the microwave.

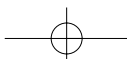

GENERAL GUIDE LINES

Since microwave cooking to some extent is different from traditional cooking, the following general guidelines should be considered whenever you use your microwave oven

If the food is undercooked

Check if:

- You have selected the correct power level.
- The selected time is sufficient-the times given in the recipes are approximate. They depend on initial temperature, weight and density of the food etc.
- The container is appropriate.

If the food is overcooked, i.e. dried out or burnt

Before you cook again, consider whether:

- The power level was too high.
- The set time was too long-the times in the recipes are approximate. They depend on initial temperature, weight and density of the food etc.

Points to remember when defrosting

- The shape of the package alters the defrosting time. Shallow rectangular packets defrost more quickly than a deep block. Separate pieces as they begin to defrost; free low slices defrost more easily.
- Shield areas of food with small pieces of foil if they start to become warm.
- When defrosting, it is better to under thaw the food slightly and allow the process to finish during the standing time.

The amount of food

The more food you want to prepare the longer it takes. A rule of thumb is that double amount of food requires almost double the time. If one potato takes four minutes to cook, approximately seven minutes are required to cook two potatoes.

Starting temperature of food

The lower the temperature of the food which is being put into the microwave oven, the longer time it takes. Food at room temperature will be reheated more quickly than food at refrigerator temperature.

Composition of the food

Food with a lot of fat and sugar will be heated faster than food containing a lot of water. fat and sugar will also reach a higher temperature than water in the cooking process. The more dense the food, the longer it takes to heat. "Very dense" food like meat takes longer time to reheat than lighter, more porous food like sponge cakes.

Size and shape

Smaller pieces of food will cook more quickly than larger pieces and uniform pieces of food cook more evenly than irregularly shaped foods.

With unevenly shaped food, the thinner parts will cook faster than the thicker areas. Place the thinner chicken wings and legs to the centre of the dish.

Stirring, turning of foods

Stirring and turning of foods are techniques used in conventional and well as in microwave cooking to distribute the heat quickly to the centre of the dish and avoid over-cooking at the outer edges of the food.

Covering food helps:

- To reduce spattering
- To shorten cooking times
- To retain food moisture

All covering, which will allow microwaves to pass through are suitable-See above "Which utensils can be used in the oven?"

Releasing pressure in foods

Several foods are tightly covered by a skin or membrane. These foods should be pricked with a fork or cocktail stick to release the pressure and to prevent bursting, as steam builds up within them during cooking. This applies to potatoes, chicken livers, sausages, egg yolks and some fruits.

Standing time

Always allow the food to stand for some time after using the oven. standing time after defrosting, cooking/reheating always improves the result since the temperature will then be evenly distributed through out the food.

In a microwave oven foods continue to cook even when the microwave energy is turned off. They are no longer cooking by microwaves, but they are still being cooked by the conduction of the high residual heat to the centre of the food. The length of standing time depends on the volume and density of the food. Sometimes it can be as short as the time it takes you to remove the food from the oven and take it to the serving table. However, with larger, denser foods, the standing time may be as long as 10 minutes. During 'standing', the internal temperature of the food will rise by as much as 45F and the food will finish cooking in this time.

Arranging food

This is done in several ways in microwave cooking to give more even cooking results.

If you are cooking several items of the same food such as jacket potatoes, place them in a ring pattern for uniform cooking. When cooking foods of uneven shapes or thickness, place the smaller or thinner area of the food towards the centre of the dish where it will be heated last.



Uneven foods such as fish should be arranged in the oven with the tails to the centre.

If you are saving a meal in the refrigerator or 'plating' a meal for reheating, arrange the thicker, denser foods to the outside of the plate and the thinner or less dense foods in the middle.

Place thin slices of meat on top of each other or interlace them. Thicker slices such as meat loaf and sausages have to be placed close to each other. Gravy or sauce should be reheated in a separate container.



Choose a tall, narrow container rather than a low and wide container. When reheating gravy, sauce or soup, do not fill the container more than 2/3.



When you cook or reheat whole fish, score the skin this prevents cracking. Shield the tail and head with small pieces of foil to prevent over-cooking but ensure the foil does not touch the sides of the oven.



CARE OF YOUR MICROWAVE OVEN

The oven should be cleaned regularly and any food deposits removed.

Failure to maintain the oven in a clean condition could lead to deterioration of the surface that could adversely affect the life of the appliance and possibly result in a hazardous situation.

- 1** Turn the oven off before cleaning.
- 2** Keep the inside of the oven clean. When food spatters or spilled liquids adhere to oven walls, wipe with a damp cloth. Mild detergent may be used if the oven gets very dirty. The use of harsh detergent or abrasives is not recommended.
- 3** The outside oven surface should be cleaned with soap and water, rinsed and dried with a soft cloth. To prevent damage to the operating parts inside the oven, water should not be allowed to seep into the ventilation openings.
- 4** If the Control Panel becomes wet, clean with a soft, dry cloth. Do not use harsh detergents or abrasives on Control Panel.
- 5** If steam accumulates inside or around the outside of the oven door, wipe with a soft cloth. This may occur when the microwave oven is operated under high humidity conditions and in no way indicates malfunction of the unit.
- 6** Don't use a steam cleaner in the oven.

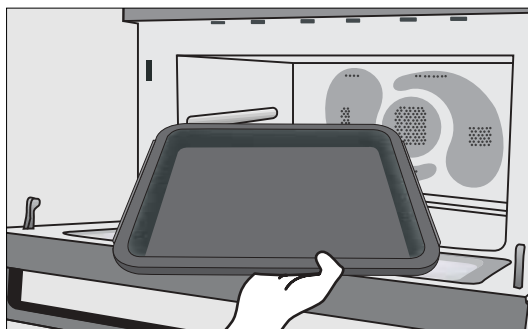

KEEP THE OVEN CLEAN

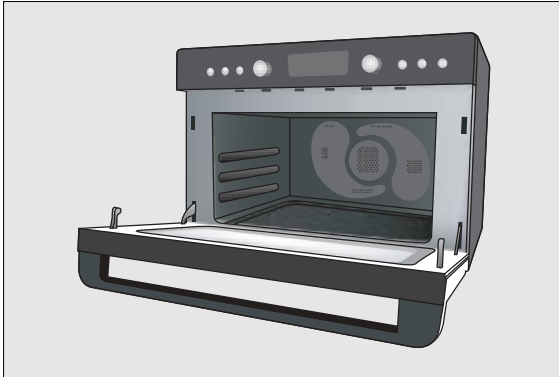

INSIDE THE OVEN

The interior three side walls and floor are stainless steel. For easy cleaning, wipe spills and splatters as they occur with a damp cloth or sponge with water and a mild detergent. Rinse the cavity of any cleaning residue with a clean damp or sponge after cleaning. Dry with a soft cloth.

These areas can also be cleaned by using plastic or nylon scouring pads recommended for use of Teflon and Silverstone*.

For hard to remove soil, use a mild non-abrasive cleaner. Use on the stainless steel areas only.

TOP SURFACE

Two quartz grill elements are installed on the top surface. As they are fragile, be careful not to press or grip them hard. Do not remove the grill elements to clean the surface.

Warning

Just as your traditional oven becomes hot also this oven will become hot during use of the grill functions or in combination with microwaves. Children should be supervised at all times when using the oven.

DOOR

While the oven door is still warm, any splatters or food soils should be wiped off with a damp sudsy cloth or sponge. Rinse with water and wipe dry with a cloth.

If steam or condensation appears around this area, wipe with a cloth. This may occur when the oven is operating under high humidity and with foods containing lots of moisture. This is a normal part of microwave cooking.

Note:

- Although your oven is provided with safety features, it is important to observe the following:
 1. It is important not to defeat or tamper with safety interlocks.
 2. Do not place any object between the oven front face and the door or allow residue to accumulate on sealing surfaces. Wipe the sealing area frequently with a mild detergent, rinse and dry. Never use abrasive powders or pads.
 3. When opened, the door must not be subjected to strain, for example, a child hanging on an opened door or any load could cause the oven to fall forward to cause injury and also damage to the door. Do not operate the oven if it is damaged, until it has been repaired by a service technician. It is particularly important that the oven closes properly and that there is no damage to the:
 - 1) Door(bent)
 - 2) Hinge and Hooks(broken or loosened)
 - 3) Door seals and sealing surface.
 4. The oven should not be adjusted or repaired by anyone except a properly competent service technician.
 5. The oven should be cleaned regularly and any food deposits removed;
 6. Failure to maintain the oven in a clean condition could lead to deterioration of the surface that could adversely affect the life of the appliance and possibly result in a hazardous situation;

EXTERIOR

CONTROL PANEL

Exercise care when cleaning this area. To clean, wipe the panel with a slightly dampened cloth, using only water. Wipe dry. Do not scrub this area or use any sort of chemical cleaner. Avoid use of excess water.

OUTSIDE SURFACE

The outside surfaces should be cleaned with soap and water, rinsed and dried with a soft cloth. Do not use any type of household or abrasive cleanser.

Note:

- DO NOT USE ANY TYPE OF OVEN CLEANER ON ANY PART OF THE OVEN. It will damage some of the interior and exterior surfaces of the oven.
- The oven should be cleaned regularly and any food deposits removed.
- Failure to maintain the oven in a clean condition could lead to deterioration of the surface that could adversely affect the life of the appliance and possibly result in a hazardous situation.

BEFORE CALLING FOR SERVICE

You can often correct operating problems yourself. If your microwave/grill oven fails to work properly, locate the operating problem in the chart below and try the solutions marked for each problems.

If the microwave/grill oven still does not work properly, contact the nearest Service Center.

Note:

It is quite normal for steam to be emitted around the door during the cooking cycle. The door is not intended to seal the oven cavity completely but its special design contributes to the complete safety of the appliance.

Caution:

1. Do not attempt to operate the oven while empty as this will cause damage.
2. As an exhaust is located in the rear of the oven, install the oven so as not to block the outlet.
If the microwave/grill oven still does not work properly, contact the nearest Service Center.

PROBLEM		1	2	3	4	5	6	7	8	9	10	11	12
Oven will not start		X	X	X	X								
Arcing or sparking						X	X						
Unevenly cooked foods						X		X	X	X			
Overcooked foods											X		
Undercooked foods						X				X	X	X	
Improper defrosting						X		X	X		X		X

SOLUTION		1	2	3	4	5	6	7	8	9	10	11	12
Is start button pressed?													
Is power cord plugged in?													
Is door closed?													
Set the cooking time.													
Use approved cookware only.													
Do not operate with oven empty.													
Supplied tray must be used.													
Turn of stir food.													
Completely defrost food.													
Turn correct dial knob / Press correct Function buttons													
Check to see that oven ventilation parts are not blocked.													
Do "manual cooling" over 10 minutes.													

QUESTIONS AND ANSWERS

*** Q : I accidentally ran my microwave oven without any food in it. Is it damaged?**

A : Running the oven empty for a short time will not damage the oven. However, it is not recommended.

*** Q : Can I open the door when the oven is operating?**

A : The door can be opened anytime during the cooking operation. Then microwave energy will be instantly switched off and the time setting will maintain until the door is closed.

*** Q : Why do I have moisture in my microwave oven after cooking?**

A : The moisture on the side of your microwave oven is normal. It is caused by steam from cooking food hitting the cool oven surface.

*** Q : Does microwave energy pass through the viewing screen in the door?**

A : No. The metal screen bounces back the energy to the oven cavity. The holes are made to allow light to pass through. They do not let microwave energy pass through.

*** Q : Why do eggs sometimes pop?**

A : When baking or poaching eggs, the yolk may pop due to steam build-up inside the yolk membrane. To prevent this, simply pierce the yolk with a toothpick before cooking. Never cook eggs without piercing their shells.

*** Q : Why this standing time recommended after the cooking operation has been completed?**

A : Standing time is very important.
With microwave cooking, the heat is in the food, not in the oven. Many foods build up enough internal heat to allow the cooking process to continue, even after the food is removed from the oven. Standing time for joints of meat, large vegetables and cakes is to allow the inside to cook completely, without overcooking the outside.

*** Q : What does "standing time" mean?**

A : "Standing time" means that food should be removed from the oven and covered for additional time to allow it to finish cooking. This frees the oven for other cooking.

*** Q : Why does my oven not always cook as fast as the microwave cooking guide says?**

A : Check your cooking guide again, to make sure you've followed directions exactly ; and to see what might cause variations in cooking time. Cooking guide times and heat settings are suggestions, to help prevent overcooking... the most common problem in getting used to a microwave oven.
Variations in the size, shape and weights and dimensions could require longer cooking time. Use your own judgment along with the cooking guide suggestions to check whether the food has been properly cooked just as you would do with a conventional cooker.

*** Q : Will the microwave oven be damaged if it operates while empty?**

A : Yes. Never run it empty.

SPECIFICATIONS

Power supply		120V AC, 60Hz SINGLE PHASE WITH GROUNDING
Microwave	Power consumption	1500 W
	Output power	800 W
	Frequency	2,450 MHz
Grill power consumption		1250 W
Convection power consumption		1450 W
Combination heating power consumption		1600 W
Outside Dimension(WXDXH)		20.63 X 14.76 X 18.78 in.
Cavity Dimensions(WXDXH)		15.75 X 9.17 X 14.37 in.
Net Weight		Approx. 59.4 lbs
Maximum Cooking time	Microwave	60 minutes
	Grill	1 hour and 30 minutes
	Convection	2 hours
	Combination	1 hour
	Fermentation	10 hours
Select function		Microwave / Grill / Convection / Combination
Microwave power level		11 stages

* Microwave oven is a Group 2 ISM equipment in which radio-frequency energy is intentionally generated and used in the form of electromagnetic radiation for the treatment of material. This oven is a Class B equipment suitable for use in domestic establishments and in establishments directly connected to a low voltage power supply network which supplies buildings used for domestic purposes.

* Specifications are subject to change without notice.

DISPOSAL OF USED ELECTRICAL & ELECTRONIC EQUIPMENT



The meaning of the symbol on the product, its accessory or packaging indicates that this product shall not be treated as household waste. Please, dispose of this equipment at your applicable collection point for the recycling of electrical & electronic equipments waste. In the European Union and Other European countries which there are separate collection systems for used electrical and electronic product. By ensuring the correct disposal of this product, you will help prevent potentially hazardous to the environment and to human health, which could otherwise be caused by unsuitable waste handling of this product. The recycling of materials will help conserve natural resources. Please do not therefore dispose of your old electrical and electronic equipment with your household waste. For more detailed information about recycling of this product, please contact your local city office, your household waste disposal service or the shop where you purchased the product.

COOKING INSTRUCTIONS

Only use utensils that are suitable for use in microwave ovens.

To cook food in the microwave oven, the microwaves must be able to penetrate the food, without being reflected or absorbed by the dish used.

Care must therefore be taken choosing the utensil. If the utensil is marked microwave-safe, you do not need to worry.

The following table lists various of utensil and indicates whether and how they should be used in a microwave oven.

Utensil	Safe	Comments
Aluminium foil	▲	Can be used in small quantities to protect areas against overcooking. Arcing can occur if the foil is too close to the oven wall or if too much foil is used.
Crust plate	●	Do not preheat for more than 8minutes.
China and earthenware	●	Porcelain, pottery, glazed earthenware and bone china are usually suitable, unless deco-rated with a metal trim.
Disposable polyester cardboard dishes	●	Some frozen foods are packaged in these dishes.
Fast-food packaging • Polystyrene cups containers • Paper bags or newspaper • Recycled paper or metal trims	● × ×	Can be used to warm food. Overheating may cause the polystyrene to melt. May catch fire. May cause arcing.
Glassware • Oven-to-table ware • Fine glassware • Glass jars	● ● ●	Can be used, unless decorated with a metal trim. Can be used to warm foods or liquids. Delicate glass may break or crack if heated suddenly. Must remove the lid. Suitable for warming only.
Metal • Dishes • Freezer bag twist ties	× ×	May cause arcing or fire.
Paper • Plates, cups, napkins and Kitchen paper • Recycled paper	● ×	For short cooking times and warming. Also to absorb excess moisture. May cause arcing.
Plastic • Containers • Cling film • Freezer bags	● ● ▲	Particularly if heat-resistant thermoplastic. Some other plastics may warp or discolour at high temperatures. Do not use Melamine plastic. Can be used to retain moisture. Should not touch the food. Take care when removing the film as hot steam will escape. Only if boilable or oven-proof. Should not be airtight. Prick with a fork, if necessary.
Wax or grease-proof paper	●	Can be used to retain moisture and prevent spattering.

● : Recommended use

▲ : Limited Use

× : Not Recommended

Limited Warranty



DAEWOO ELECTRONICS AMERICA, INC. warrants the following **Microwave** to be free from defective material and workmanship and agrees to remedy any such defect or to furnish a new part (at the Company's option) in exchange for any part of any unit of its manufacture which under normal installation, use and service disclosed such defect, provided the unit is delivered by the owner to store or dealer where purchased or Daewoo authorized service center. To establish and receive warranty service at our store, dealer or our authorized service center, a sales receipt or bill of sales is required for proof of purchase.

This warranty does not extend to any of our electronic products which have been subjected to misuse, neglect, accident, incorrect wiring not our own, improper installation, unauthorized modification or to use in violation of instructions furnished by us, nor units which have been repaired or altered outside of our factory, nor to cases where the serial number thereof has been removed, defaced, or changed.

This warranty is in lieu of all warranties expressed or implied and no representative or person is authorized to assume for us any other liability in connection with the sales of our electronic products.

Over the counter exchange for units that are initially defective. Initial defective is described as when the dealer opens the unit and finds that it is inoperative or an individual customer opening a new unit and finding that it is initially defective. This unit may be returned to the factory by the dealer for exchange. Under no circumstances will an individual customer be permitted to return defective unit directly to factory. Exchange must be directly with the dealer. When this unit is returned to dealer, a copy of the purchase evidence stating the date of purchase is to be put in the individual box for dealer's further control with the factory.

<u>Model</u>	<u>Parts</u>	<u>Labor</u>
KOC-1C4K	1 year	1 year

Note: The warranty service center list is constantly changing with the addition of our current qualified service centers. If there is inadequate or no local service facility subject individual customer will call DAEWOO on the toll free number **1-877-DWESV3(1-877-393-7823)** www.e-daewoo.com to be provided with further informations.