

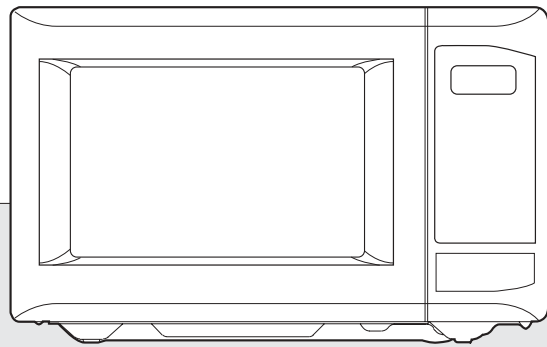

MICROWAVE OVEN

KOR-106FB

OPERATING INSTRUCTIONS
& COOK BOOK



Before operating this oven, please read these instructions completely.

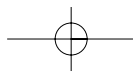

PRECAUTIONS TO AVOID POSSIBLE EXPOSURE TO EXCESSIVE MICROWAVE ENERGY

- (a) **Do not attempt to operate this oven with the door open** since open-door operation can result in harmful exposure to microwave energy. It is important not to defeat or tamper with the safety interlocks.
- (b) **Do not place any object** between the oven front face and the door or allow soil or cleaner residue to accumulate on sealing surfaces.
- (c) **Do not operate the oven if it is damaged.** It is particularly important that the oven door close properly and that there is no damage to the: (1) door (bent), (2) hinges and latches (broken or loosened), (3) door seals and sealing surfaces.
- (d) The oven should not be adjusted or repaired by anyone except properly qualified service personnel.

TABLE OF CONTENTS

- PRECAUTIONS..... 1
- IMPORTANT SAFETY INSTRUCTIONS 2
- FEDERAL COMMUNICATIONS COMMISSION RADIO FREQUENCY
- INTERFERENCE STATEMENT (U.S.A. ONLY)..... 3
- GROUNDING INSTRUCTIONS..... 3
- INSTALLATION 4
- IMPORTANT 4
- SPECIFICATIONS..... 5
- FEATURES DIAGRAM 6
- OPERATION PROCEDURE 8
- CONTROLS..... 9
 - SETTING THE CLOCK..... 9
 - TIME DEFROSTING 9
 - WEIGHT DEFROSTING..... 10
 - COOKING IN ONE STAGE 11
 - COOKING IN TWO STAGES..... 11
 - KITCHEN TIMER MODE 12
 - SPEED COOK..... 13
 - ONE TOUCH COOKING 13
 - LESS, MORE..... 15
 - CHILD SAFETY LOCK 15
 - TO STOP THE OVEN WHILE THE OVEN IS OPERATING 15
- UTENSIL TEST 16
- MICROWAVE UTENSILS 16
- CARE OF YOUR MICROWAVE OVEN 17
- USE YOUR MICROWAVE OVEN SAFELY..... 18
- BEFORE YOU CALL FOR SERVICE..... 19
- QUESTIONS AND ANSWERS 19

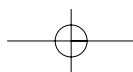

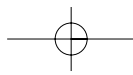

IMPORTANT SAFETY INSTRUCTIONS

When using electrical appliances, basic safety precautions should be followed, including the following:

WARNING-To reduce the risk of burns, electric shock, fire, injury to persons or exposure to excessive microwave energy:

1. Read all instructions before using the appliance.
2. Read and follow the specific "PRECAUTIONS TO AVOID POSSIBLE EXPOSURE TO EXCESSIVE MICROWAVE ENERGY" found on page 1.
3. This appliance must be grounded. Connect only to properly grounded outlet.
See "GROUNDING INSTRUCTIONS" found on page 3.
4. Install or locate this appliance only in accordance with the provided installation instructions.
5. Some products such as whole eggs and sealed containers - for example, closed glass jars-are able to explode and should not be heated in this oven.
6. Use this appliance only for its intended use as described in this manual. Do not use corrosive chemicals or vapors in this appliance. This type of oven is specifically designed to heat, cook, or dry food. It is not designed for industrial or laboratory use.
7. As with any appliance, close supervision is necessary when used by children.
8. Do not operate this appliance if it has a damaged cord or plug, if it is not working properly, or if it has been damaged or dropped.
9. This appliance should be serviced only by qualified service personnel.
Contact nearest authorized service facility for examination, repair or adjustment.
10. Do not cover or block any openings on the appliance.
11. Do not store this appliance outdoors. Do not use this product near water — for example, near a kitchen sink, in a wet basement, or near a swimming pool, or similar locations.
12. Do not immerse cord or plug in water.
13. Keep cord away from heated surfaces.
14. Do not let cord hang over edge of table or counter.
15. Either:
 - a) When cleaning surfaces of door and oven that comes together on closing the door, use only mild, non-abrasive soaps or detergents applied with a sponge or soft cloth , or
 - b) When separate cleaning instructions are provided, See door surface cleaning instructions on.
16. To reduce the risk of fire in the oven cavity:
 - a) Do not overcook food. Carefully attend appliance when paper, plastic, or other combustible materials are placed inside the oven to facilitate cooking.
 - b) Remove wire twist-ties from paper or plastic bags before placing bag in oven.
 - c) If materials inside the oven ignite, keep oven door closed, turn oven off, and disconnect the power cord, or shut off power at the fuse or circuit breaker panel.
 - d) Do not use the cavity for storage purposes. Do not leave paper products, cooking utensils, or food in the cavity when not in use.
17. Do not use this microwave oven to heat corrosive chemicals (for example, sulfides and chlorides). Vapours from such corrosive chemicals may interact with the contact and springs of the safety interlock switches thereby rendering them inoperable.
18. Keep the waveguide cover clean at all times. Wipe the oven interior with a soft damp cloth after each use. If you leave grease or fat anywhere in the cavity it may overheat, smoke or even catch fire when next using the oven.
19. Never heat oil or fat for deep frying as you cannot control the temperature and doing so may lead to overheating and fire.
20. Liquids, such as water, coffee, or tea are able to be overheated beyond the boiling point without appearing to be boiling due to surface tension of the liquid. Visible bubbling or boiling when the container is removed from the microwave oven is not always present. **THIS COULD RESULT IN VERY HOT LIQUIDS SUDDENLY BOILING OVER WHEN A SPOON OR OTHER UTENSIL IS INSERTED INTO THE LIQUID.** To reduce the risk of injury to persons:
 - ① Do not overheat the liquid.
 - ② Stir the liquid both before and halfway through heating it
 - ③ Do not use straight-sided containers with narrow necks.
 - ④ After heating, allow the container to stand in the microwave oven for a short time before removing the container.
 - ⑤ Use extreme care when inserting a spoon or other utensil into the container.

SAVE THESE INSTRUCTIONS

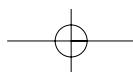

FEDERAL COMMUNICATIONS COMMISSION RADIO FREQUENCY INTERFERENCE STATEMENT(U.S.A. ONLY)

WARNING:

This equipment generates and uses ISM frequency energy and if not installed and used properly, that is in strict accordance with the manufacturer's instructions, may cause interference to radio and television reception.

It has been type-tested and found to comply with limits for an ISM Equipment pursuant to part 18 of FCC Rules, which are designed to provide reasonable protection against such interference in a residential installation.

However, there is no guarantee that interference will not occur in a particular installation.

If this equipment does cause interference to radio or television reception, which can be determined by turning the equipment off and on, the user is encouraged to try to correct the interference by one or more of the followings.

- Reorient the receiving antenna of radio or television.
- Relocate the Microwave oven with respect to the receiver.
- Move the microwave oven away from the receiver.
- Plug the microwave oven into a different outlet so that microwave oven and receiver are on different branch circuits.

THE MANUFACTURER is not responsible for any radio or TV interference caused by UNAUTHORIZED MODIFICATION to this microwave oven. It is the responsibility of the user to correct such interference.

GROUNDING INSTRUCTIONS

This appliance must be grounded. In the event of an electrical short circuit, the grounding plug reduces the risk of electric shock by providing an escape wire for electric current. This appliance is equipped with a cord having a grounding wire with a grounding plug. The plug must be plugged into an outlet that is properly installed and grounded.

WARNING: Improper use of the grounding can result in a risk of electric shock.

Consult a qualified electrician or serviceman if the grounding instructions are not completely understood, or if doubt exists as to whether the appliance is properly grounded, and either :

- (1) If it is necessary to use an extension cord, use only a 3-wire extension cord that has a 3-blade grounding plug, and a 3-slot receptacle that will accept the plug on the appliance. The marked rating of the extension cord shall be equal to or greater than the electrical rating of the appliance. or
- (2) Do not use an extension cord, if the power supply cord is too short, have a qualified electrician or serviceman install an outlet near the appliance.

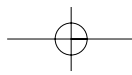

INSTALLATION

1. Examine the oven after unpacking.

Check for damage such as a misaligned door, broken door or dent in the cavity.
If any damage is visible, DO NOT INSTALL, and notify your dealer immediately.

2. Level, flat location.

Install the microwave oven on a level, flat surface.

3. Ventilation.

Do not block air vents. If they are blocked during operation, the oven may overheat and eventually cause a failure.

For proper ventilation, allow 3 inches of space between oven top, sides, rear and adjacent surfaces.

4. Away from radio and TV sets.

Poor television reception and radio interference may result if the oven is located close to a TV, radio, antenna, feeder, etc.

Place the oven as far from them as possible.

5. Away from heating appliances and water taps.

Keep the oven away from heat, steam or splashing liquids. These things can adversely affect oven wiring and contacts.

6. Power supply.

This microwave oven requires a power supply of approximately 9 Amperes, 220 Volts, 60Hz and a grounded outlet. A short power cord is provided to reduce the risk of the user becoming entangled in or tripping over a longer cord. Longer cord sets or extension cords are available and may be used if care is exercised.

If an extension cord is used, the marked electrical rating of the cord should be at least as great as the electrical rating of the oven.

The extension cord must be a grounding-type 3-wire cord. The longer cord should be arranged so it does not drape over the table top or counter where children can pull on it or trip over it.

7. The minimum height of free space necessary above the top surface of the oven is 100mm.

IMPORTANT

The wire in this mains lead colored in accordance with the following code.

Green-and-yellow	: Earth
Blue	: Neutral
Brown	: Live

As the colors of the wires in the mains lead of this appliance may not correspond with the colored markings identifying the terminals in your plug, proceed as follows.

The wire which is colored green-and-yellow must be connected to the terminal in the plug which is marked with the letter 'E', earth symbol or colored green-and-yellow.

The wire which is colored blue must be connected to the terminal which is marked with the letter 'N' or colored black.

The wire which is colored brown must be connected to the terminal which is marked with the letter 'L' or colored red.

WARNING: This appliance must be earthed.

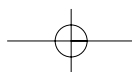

SPECIFICATIONS

POWER SUPPLY		220V AC 60Hz, SINGLE PHASE WITH GROUNDING
MICROWAVE	INPUT POWER	1350 W
	ENERGY OUTPUT	900 W
	FREQUENCY	2,450MHz
OUTSIDE DIMENSIONS (W x H x D)		495 x 294 x 379mm
CAVITY DIMENSIONS (W x H x D)		320 x 237 x 343mm
NET WEIGHT		APPROX. 14Kg
TIMER		59 min. 99 sec.
POWER SELECTIONS		10 Levels

* Specifications are subject to change without notice.

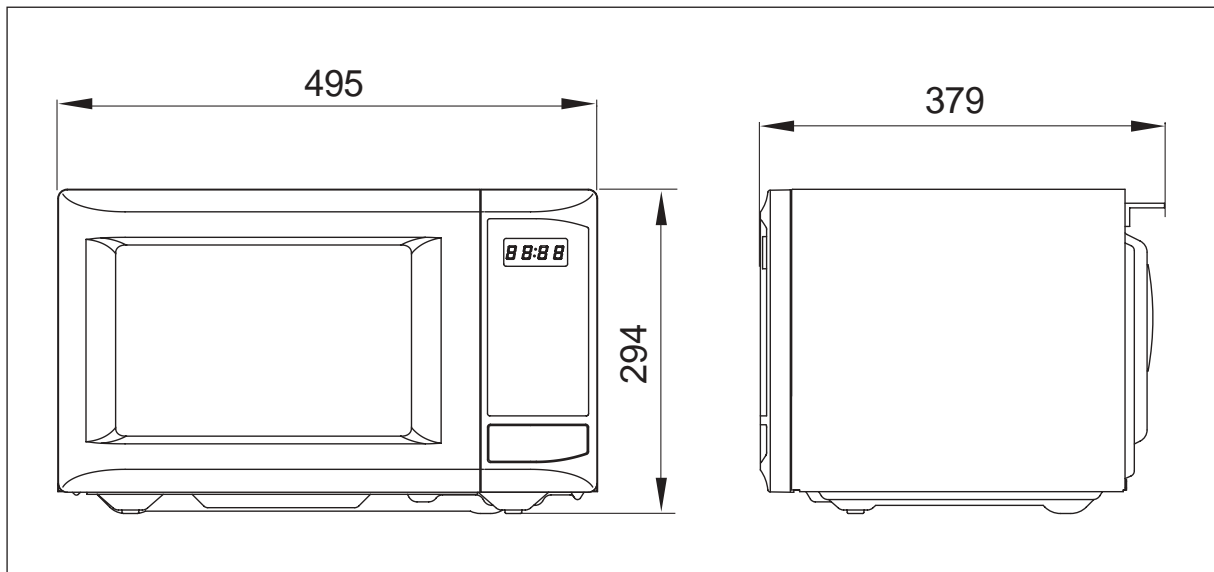

FEATURES DIAGRAM

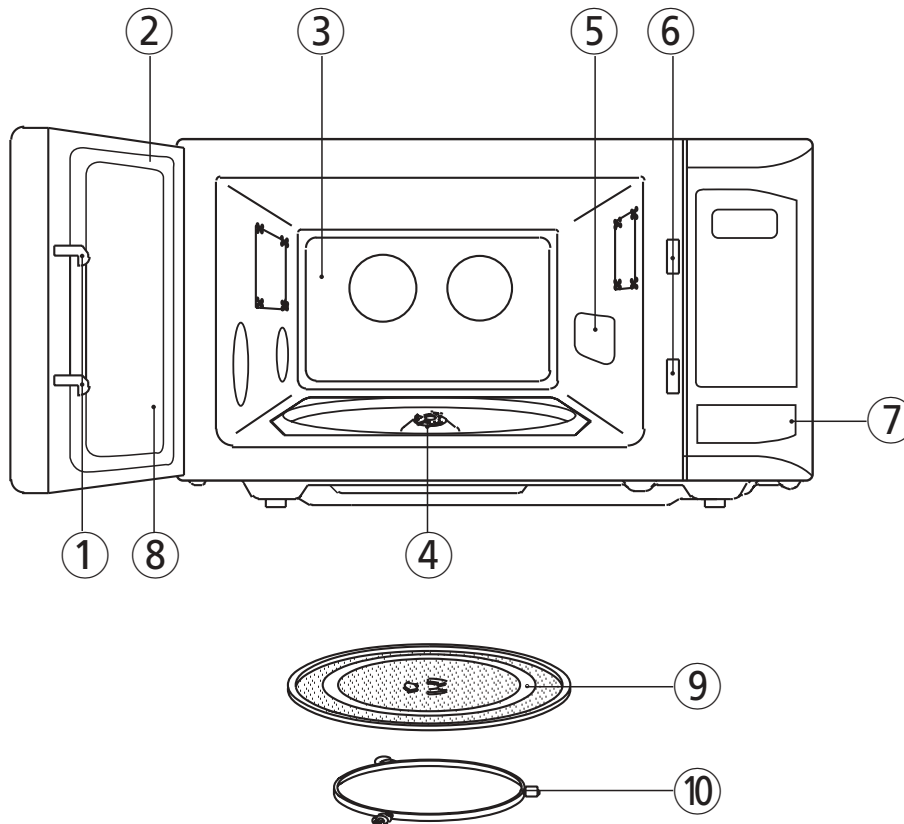

- ① **Door latch** - When the door is closed, it will automatically shut off. If the door is opened while the oven is operating, the magnetron will automatically shut off.
- ② **Door seal** - The door seal surfaces prevent microwaves escaping from the oven cavity.
- ③ **Oven cavity**
- ④ **Coupler** - This fits over the shaft in the center of the oven cavity floor. This is to remain in the oven for all cooking.
- ⑤ **Waveguide cover** - Protects the microwave outlet from splashes of cooking foods.
- ⑥ **Safety interlock system**
- ⑦ **Door open button** - To open the door push the door open button.
- ⑧ **Viewing screen** - Allows viewing of food. The screen is designed so that light can pass through, but not the microwave.
- ⑨ **Glass cooking tray** - Made of special heat resistant glass. The tray must always be in proper position before operating. Do not cook food directly on the tray.
- ⑩ **Roller guide** - This must always be used for cooking together with the glass cooking tray.

FEATURES DIAGRAM (continued)

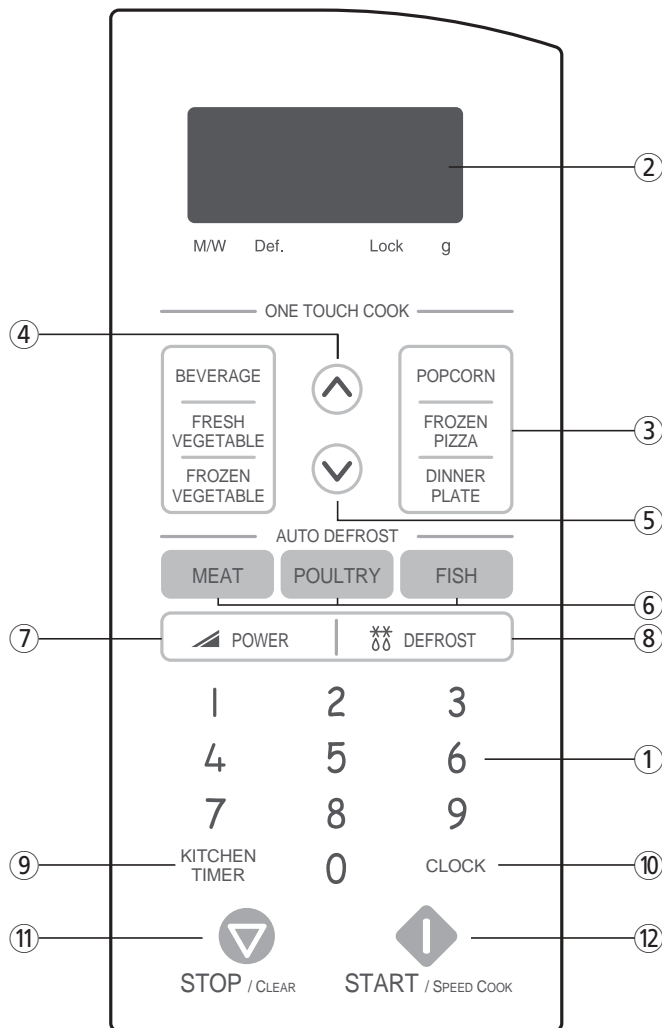

- ① **Time set pad**-Used to set the cooking time and the present time.
- ② **Display**-Cooking time, power level, indicators and present time are displayed.
- ③ **One touch**-Used to cook or reheat specific quantities of food.
- ④ **More**-Used to add time to cooking.
- ⑤ **Less**-Used to remove time from cooking.
- ⑥ **Auto Defrost**-Used to defrost foods.(for weight)
- ⑦ **Power**-Used to set power level.
- ⑧ **Defrost**-Used to defrost foods.(for time)
- ⑨ **Kitchen Timer**-Used as a minute timer, to delay the start of cooking, or to set a holding time after cooking.
- ⑩ **Clock**-Used to set clock.
- ⑪ **Stop/Clear**-Used to stop the oven operation or to delete the cooking data.
- ⑫ **Start/Speed cook**-Used to start the oven and also used to set a reheat time.

OPERATION PROCEDURE

This section includes useful information about oven operation.

1. Plug power supply cord into 9Amp, 220V AC 60Hz power outlet.
2. After placing the food in a suitable container, open the oven door and put it on the glass tray.
The glass tray and roller guide must always be in place during cooking.
3. Shut the door. Make sure that it is firmly closed.

- | | |
|---|--|
| <p>1 The oven light is on only when the microwave oven is operating.</p> <p>2 The oven door can be opened at any time during operation by touching the door release button on the control panel. The oven will automatically shut off.</p> <p>3 Each time a pad is touched, a BEEP will sound to acknowledge the touch.</p> <p>4 The oven automatically cooks on full power unless set to a lower power level.</p> <p>5 The display will show “ : 0” when the oven is plugged in.</p> <p>6 Time clock returns to the present time when the cooking time ends.</p> | <p>7 When the STOP/CLEAR pad is touched during the oven operation, the oven stops cooking and all information retained. To erase all information(except the present time), touch the STOP/CLEAR pad once more. If the oven door is opened during the oven operation, all information is retained.</p> <p>8 If the START pad is touched and the oven does not operate, check the area between the door and door seal for obstructions and make sure the door is closed securely. The oven will not start cooking until the door is completely closed or the program has been reset.</p> |
|---|--|

Make sure the oven is properly installed and plugged into the electrical outlet.

WATTAGE OUTPUT CHART

- The power-level is set by pressing the POWER pad. The chart shows the display, the power level and the percentage of power.

Touch POWER pad	Power level (Display)	Approximate Percentage of Power
once	P-HI	100%
twice	P-90	90%
3 times	P-80	80%
4 times	P-70	70%
5 times	P-60	60%
6 times	P-50	50%
7 times	P-40	40%
8 times	P-30	30%
9 times	P-20	20%
10 times	P-10	10%
11 times	P-00	0%

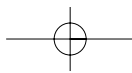

CONTROLS

SETTING THE CLOCK

When the oven is first plugged in, the display will flash “:0” and a tone will sound. If the AC power ever goes off, the display shows “:0” when the power comes back on.

CLOCK

1. Touch CLOCK pad.
This is a 12 hour clock system.
2. Touch CLOCK pad once more.
This is a 24 hour clock system.

NOTE : This oven has a multiple clock system. If you want a 12 hour clock system, omit this step.

3. Enter the correct time of day by touching the time set pads.

4. Touch CLOCK pad.

The display stops blinking, and the colon starts blinking. If you selected 12 hour clock system, this digital clock allows you to set from 1:00 to 12:59. If you selected 24 hour clock system, this digital clock allows you to set from 0:00 to 23:59.

NOTE: If you attempt to enter an incorrect time, the time will not be set and a error signal tone will sound. Touch the CLOCK pad and re-enter the time

TIME DEFROSTING

When TIME DEFROST is selected, the automatic cycle divides the defrosting time into periods of alternating defrost and stand times by cycling on and off.

DEFROST

1. Touch DEFROST pad.

The DEF indicator lights and “:0” is displayed.

2. Touch the time set pads for the desired time.

The display will show what you touched.

3. Touch START pad.

NOTE: Your oven can be programmed for 59 minutes 99 second.(59:99)

When you touch START pad, the DEF indicator starts blinking to show the oven is in the DEFROST mode. The display counts down the time to show you how much defrosting time is left in the DEFROST mode. The oven beeps during the defrosting cycle to signal that the food needs to be turned or rearranged. When the defrosting time ends, you will hear 3 beeps.

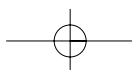

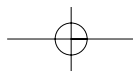

WEIGHT DEFROSTING

AUTO DEFROST lets you easily defrost food by eliminating guesswork in determining defrosting time. Follow the steps below for easy defrosting.

- | | | |
|-------------|--|--|
| MEAT | 1. Touch MEAT pad. | The lb indicator light and “500” is displayed. |
| | 2. Select the desired defrosting weight.
(Refer to the weight defrost chart below.) | The display will show what you touched. |
| | 3. Touch START pad. | MEAT DEFROSTING begins. |

- | | | |
|----------------|--|--|
| POULTRY | 1. Touch POULTRY pad. | The lb indicator light and “800” is displayed. |
| | 2. Select the desired defrosting weight.
(Refer to the weight defrost chart below.) | The display will show what you touched. |
| | 3. Touch START pad. | POULTRY DEFROSTING begins. |

- | | | |
|-------------|--|--|
| FISH | 1. Touch FISH pad. | The lb indicator light and “300” is displayed. |
| | 2. Select the desired defrosting weight.
(Refer to the weight defrost chart below.) | The display will show what you touched. |
| | 3. Touch START pad. | FISH DEFROSTING begins. |

* WEIGHT DEFROST CHART

Touch pad	MEAT	POULTRY	FISH
once	500 g	800 g	300 g
twice	800 g	1000 g	500 g
3 times	1000 g	1200 g	800 g
4 times	1200 g	1500 g	1000 g

The defrosting time is automatically determined by the weight selected. When you touch START pad, the g indicator goes off and the DEF indicator blinks and the defrosting time counts down in the display window. The oven beeps during the defrosting cycle to signal that the food needs to be turned or rearranged. When the defrosting time ends, you will hear 3 beeps.

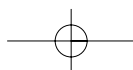

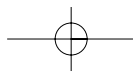

COOKING IN ONE STAGE

POWER X 6
 1. Touch POWER pad.
 (Select the desired power level.)

The M/W indicator lights.
 The display will show what you touched.
 This example shows power level 5.

Note : If steps 1 and 2 are omitted, the oven will cook at full power.

2. Touch number pads for the cooking time.

The display will show what you touched.

Note : Your oven can be programmed for 59 minutes 99 seconds. (59 : 99)

3. Touch START pad.

When you touch START pad, the M/W indicator starts blinking to show the oven is cooking.
 The display counts down the time to show how much cooking time is left. When the cooking time ends, you will hear 3 beeps.

NOTE: Using lower power levels increases the cooking time which is recommended for foods such as cheese, milk and slow cooking of meats.

COOKING IN TWO STAGES

All recipes require the frozen foods to be defrosted fully before cooking.
 This oven can be programmed to automatically defrost foods before cooking.

DEFROST
 1. Touch DEFROST pad.

The DEF indicator lights and “ : 0” is displayed.

2. Touch number pads for the defrosting time you want.

The display will show what you touched.

POWER X 6
 3. Touch POWER pad.
 (Select the desired power level.)

The M/W indicator lights and “P-HI” is displayed.
 The display will show what you touched.
 This example shows power level 5.

4. Touch number pads for the desired cooking time.

The display will show what you touched.

5. Touch START pad.

When you touch START pad, the DEF and M/W indicators come on to confirm the power levels selected. The DEF indicator starts blinking to show you that the oven is in DEFROST mode.
 The display counts down the time remaining in DEFROST mode. When the oven beeps, turn over, break apart and/or redistribute the food. At the end of DEFROST mode, the oven will beep and start M/W cook. The DEF indicator goes off and the M/W indicator starts blinking. The display counts down the time remaining in M/W mode. When M/W cook ends, you will hear 3 beeps.

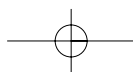

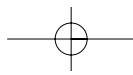

KITCHEN TIMER MODE

Timer operates as a minute timer, can be set to delay cooking and used to set a holding time after cooking. However delay cooking can not be programmed for defrost. Timer operates without microwave energy.

HOW TO USE AS A MINUTE TIMER

- | | |
|--|--|
| <div style="border: 1px solid gray; padding: 5px; width: fit-content;">KITCHEN
TIMER</div> | <p>1. Touch KITCHEN TIMER pad. The TIMER indicator lights and “ : 0” is displayed.</p> <p>2. Press the amount of time you want to count down. The display will show what you touched.</p> <p>3. Touch START pad.</p> |
|--|--|

The TIMER indicator starts blinking and the display counts down the time remaining in KITCHEN TIMER mode. When KITCHEN TIMER mode ends, you will hear 3 beeps.

HOW TO USE TO DELAY THE START OF COOKING

- | | |
|--|--|
| <div style="border: 1px solid gray; padding: 5px; width: fit-content;">KITCHEN
TIMER</div> | <p>1. Touch KITCHEN TIMER pad. The TIMER indicator lights and “ : 0” is displayed.</p> <p>2. Press the amount of time you want to delay. The display will show what you touched.</p> <p>3. Program the desired power level and cooking time for food to be cooked. The M/W indicator lights and the selected power level & cooking time are displayed.</p> <p>4. Touch START pad.</p> |
|--|--|

When you touch START pad, the TIMER indicator starts blinking and the display counts down the time remaining in KITCHEN TIMER mode. When KITCHEN TIMER mode ends, the oven will beep. The TIMER indicator goes off and M/W indicator starts blinking. The display counts down the time remaining in M/W mode. When M/W cook ends, you will hear 3 beeps.

HOW TO USE TO SET A HOLDING TIME

- | | |
|--|---|
| <div style="border: 1px solid gray; padding: 5px; width: fit-content;">KITCHEN
TIMER</div> | <p>1. Program the desired cooking time. The M/W indicator lights and the selected time is displayed.</p> <p>2. Touch KITCHEN TIMER pad. The TIMER indicator lights and “ : 0” is displayed.</p> <p>3. Press the amount of time you want the oven to hold. The display will show what you touched.</p> <p>4. Touch START pad.</p> |
|--|---|

The M/W indicator starts blinking and the display counts down the time remaining in M/W mode. When the M/W cook ends, the oven will beep. The M/W indicator goes off and TIMER indicator starts blinking. The display counts down the time remaining in KITCHEN TIMER mode. When the KITCHEN TIMER mode ends, you will hear 3 beeps.

Note : Your oven can be programmed for 59 minutes 99 seconds. (59 : 99)

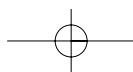

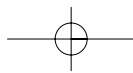

SPEED COOK

SPEED COOK allows you to reheat for 30 seconds at 100% (full power) by simply touching the SPEED COOK pad.

By repeatedly touching the SPEED COOK pad, you can also extend reheating time to 5 minutes by 30 second increments.

SPEED
COOK

1. Touch SPEED COOK pad.

When you touch SPEED COOK, “:30” is displayed.

After 1.5 seconds, the oven starts reheating.

ONE TOUCH COOKING

One touch cook allows you to cook or reheat many of your favorite foods by touching just one pad.

To increase quantity, touch the chosen pad until number in display is same as the desired quantity to cook. (except for POPCORN)

POPCORN

1. Touch POPCORN pad once for 99g bag.

When you touch POPCORN pad once, “99” is displayed.

After 1.5 seconds, the display is changed into cooking time and the oven starts cooking.

- NOTE:**
1. Use prepackaged room-temperature microwave popcorn.
 2. Place bag in oven according to manufacturer's directions.
 3. Pop only one bag at a time.
 4. After popping, open bag carefully: popcorn and steam are extremely hot.
 5. Do not reheat unpopped kernels or reuse bag.
 6. Do not leave oven unattended while popping popcorn.

CAUTION: If prepackaged popcorn is of a different weight than the recommended weight, do not use the popcorn pad. Follow the manufacturer instruction.

FROZEN
PIZZA

1. Touch FROZEN PIZZA pad once for 200g pizza or twice for 400g pizza.

When you touch FROZEN PIZZA pad once, “200” is displayed.

After 1.5 seconds, the display is changed into the cooking time and the oven starts cooking.

*** FROZEN PIZZA ***

- 200g : Touch FROZEN PIZZA once.
- 400g : Touch FROZEN PIZZA twice within 1.5 seconds.

- NOTE:**
- 1 Use only one frozen pizza at a time
 2. Use only frozen pizza made for microwave ovens.
 3. If the cheese of frozen pizza does not melt sufficiently, cook a few seconds longer.
 4. Some brands of frozen pizza may require more or less cooking time.

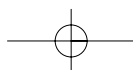

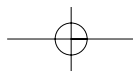

ONE TOUCH COOKING (continued)

BEVERAGE

1. Touch BEVERAGE pad once for 1 cup, twice for 2 cups or three times for 3 cups.

When you touch BEVERAGE pad once, "1" is displayed.
After 1.5 seconds, the display changes into cooking time of quantity and the oven starts cooking.

* BEVERAGE * (200ml/cup)

- 1 cup (mug) : Touch BEVERAGE once.
- 2 cups (mugs) : Touch BEVERAGE twice within 1.5 seconds.
- 3 cups (mugs) : Touch BEVERAGE three times within 1.5 seconds.

DINNER PLATE

1. Touch DINNER PLATE pad once for 350g of dinner plate or twice for 450g of dinner plate.

When you touch DINNER PLATE pad once, "350" is displayed.
After 1.5 seconds, the display shows the cooking time and the oven starts cooking.

* DINNER PLATE *

- 350g : Touch DINNER PLATE once.
- 450g : Touch DINNER PLATE twice within 1.5 seconds.

FRESH VEGETABLE

1. Touch FRESH VEGETABLE pad once for 200g of fresh vegetable or twice for 400g of fresh vegetable.

When you touch FRESH VEGETABLE pad once, "200" is displayed.
After 1.5 seconds, the display shows cooking time and the oven starts cooking.

* FRESH VEGETABLE *

- 200g : Touch FRESH VEGETABLE once.
- 400g : Touch FRESH VEGETABLE twice within 1.5 seconds.

FROZEN VEGETABLE

1. Touch FROZEN VEGETABLE pad once for 200g of frozen vegetable or twice for 400g of frozen vegetable.

When you touch FROZEN VEGETABLE pad once, "200" is displayed.
After 1.5 seconds, the display shows cooking time and the oven starts cooking.

* FROZEN VEGETABLE *

- 200g : Touch FROZEN VEGETABLE once.
- 400g : Touch FROZEN VEGETABLE twice within 1.5 seconds.

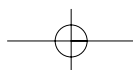

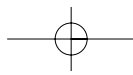
**START**

1. Touch START pad.

When you touch START pad, the display changed into cooking time of quantity and the oven starts cooking.

LESS, MORE

To alter onetouch cooking or cooking time whilst oven is in operation, use LESS or MORE.(except for defrosting)

Press LESS/MORE to decrease/increase the onetouch cooking time in multiples of 10 second.

The overall onetouch cooking time can be increased to a maximum of 59 minutes 99 seconds.

Press LESS/MORE to decrease/increase the cooking time in multiples of 1 minute.

The overall cooking time can be increased to a maximum of 59 minutes.

CHILD SAFETY LOCK

The safety lock prevents unwanted oven operation such as by small children.

To set, press and hold STOP/CLEAR for 3 seconds, a beep sounds and LOCK indicator lights.

To cancel, press and hold STOP/CLEAR for 3 seconds, a beep sounds and LOCK indicator goes off.

TO STOP THE OVEN WHILE THE OVEN IS OPERATING

1. Press STOP/CLEAR pad.

- You can restart the oven by touching START pad.
- Touch STOP/CLEAR once more to erase all instructions.
- You must enter in new instructions.

2. Open the door.

- You can restart the oven by closing the door and touching START.

NOTE: Oven stops operating when door is opened.

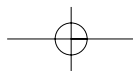

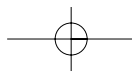

UTENSIL TEST

Dishes that do not absorb microwave energy are best for microwave cooking. Look on the label to verify that particular cups, glasses, plates are indeed suitable, especially paper goods. If you are not sure, try this utensil test to check.

- Put the empty utensil in the microwave oven.
- Put one cup of water in a glass measure next to the empty utensil.
- Heat on HI for 1 minute.
- After 1 minute the water should be warm but the utensil should not. If the utensil is warm, it is not suitable for microwave cooking.

MICROWAVE UTENSILS

Glass, Ceramic and China

Ovenproof glass or ceramic baking dishes are the most used microwave utensils.

Many of these items are readily available in most homes: glass measures, custard cups, mixing bowls, covered casseroles, pie plates and round or square cake dishes. Ovenproof dinnerware is usually safe to use in the microwave.

Do not heat or cook in glass jars or bottles.

Do not use dishes with silver, gold, platinum or other metal trim. Arcing may occur and/or the dish may break.

Do not use delicate or stemmed glassware. Although the glass may be transparent to microwave energy, heat from the food may cause the glassware to crack.

Plastics

Plastic dishes, cups, mugs and bowls may be used in the oven for short periods of time. None of these should be used in the oven for prolonged periods because distortion and melting may occur. Check manufacturer's recommendations concerning microwave safety.

Plastic wrap can be used to cover dishes in most recipes if the dish is deep enough to avoid plastic wrap touching the food. Always vent the wrap by folding back one corner to allow excess steam to escape.

Plastic cooking bags should be slit before cooking so excess steam can escape.

Do not use wire twist ties to close the bag. Wire twist ties can cause arcing which can damage the oven.

Paper

Paper cups, wax paper, napkins, paper towels, and plates may be used for short cooking. Prolonged time in the oven can cause paper to burn. Do not use recycled paper products, such as brown paper bags. They contain impurities which may cause arcing and damage the oven.

Metal

Metal utensils should not be used in the oven. Metal reflects microwave energy so foods will not cook evenly. Metal can cause arcing and damage the oven.

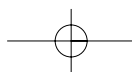

CARE OF YOUR MICROWAVE OVEN

- 1** Turn the oven off before cleaning.
- 2** Keep the inside of the oven clean. When food spatters or spilled liquids adhere to oven walls, wipe with a damp cloth. Mild detergent may be used if the oven gets very dirty. The use of harsh detergent or abrasives is not recommended.
- 3** The outside oven surface should be cleaned with soap and water, rinsed and dried with a soft cloth. To prevent damage to the operating parts inside the oven, water should not be allowed to seep into the ventilation openings.
- 4** If the Control Panel becomes wet, clean with a soft, dry cloth. Do not use harsh detergents or abrasives on Control Panel.
- 5** If steam accumulates inside or around the outside of the oven door, wipe with a soft cloth. This may occur when the microwave oven is operated under high humidity conditions and in no way indicates malfunction of the unit.

- 6** It is occasionally necessary to remove the glass tray for cleaning. Wash the tray in warm sudsy water or in a dishwasher.

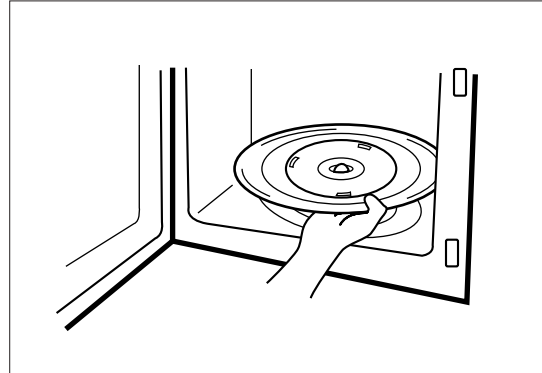

- 7** The roller guide and oven cavity floor should be cleaned regularly to avoid excessive noise. Simply wipe the bottom surface of the oven with mild detergent water or window cleaner and dry. The roller guide may be washed in mild sudsy water.

ROLLER GUIDE

- 1** The ROLLER GUIDE and oven floor should be cleaned frequently to prevent excessive noise.
- 2** The ROLLER GUIDE MUST ALWAYS be used for cooking together with the Glass Tray.

GLASS TRAY

- 1** DO NOT operate the oven without the Glass Tray in place.
- 2** DO NOT use any other Glass Tray with this oven.
- 3** If Glass Tray is hot, ALLOW TO COOL before cleaning or placing it in water.
- 4** DO NOT cook directly on the Glass Tray.

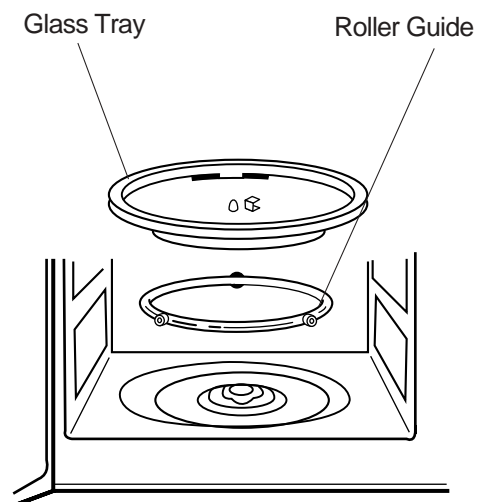

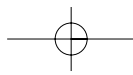

USE YOUR MICROWAVE OVEN SAFELY

General Use

Do not attempt to defeat or tamper with safety interlocks.

Do not place any object between the oven front frame and the door or allow residue to build up on sealing surfaces. Wipe with a mild detergent, rinse and dry. Never use abrasive powders or pads.

Do not subject the oven door to strain or weight such as a child hanging on an open door.

This could cause the oven to fall forward resulting in injury to you and damage to the oven.

Do not operate the oven if door seals or sealing surfaces are damaged; or if door is bent; or if hinges are loose or broken.

Do not operate the oven empty. This will damage the oven.

Do not attempt to dry clothes, newspapers or other materials in the oven. They may catch on fire.

Do not use recycled paper products as they may contain impurities which may cause sparks or fires.

Do not hit or strike the control panel with hard objects. This can damage the oven.

Food

Never use your microwave oven for home canning. The oven is not designed for proper home canning. Improperly canned food may spoil and be dangerous to consume.

Always use the minimum recipe cooking time. It is better to undercook rather than overcook foods. Undercooked foods can be returned to the oven for more cooking. If food is overcooked, nothing can be done.

Heat small quantities of food or foods with low moisture carefully. These can quickly dry out, burn or catch on fire.

Do not heat eggs in the shell. Pressure may build up and eggs can explode.

Potatoes, apples, egg yolks and sausages are examples of food with non-porous skins. These must be pierced before cooking to prevent bursting.

Do not attempt to deep fat fry in your microwave oven.

Always stir liquids before heating. Heated liquids can erupt, if not mixed with air.

Do not leave the oven unattended while popping corn.

Do not pop corn in a paper bag unless it is the commercially prepared Microwave Popcorn product. The kernels can overheat and ignite a brown paper bag.

Do not put packaged Microwave Popcorn bags directly on the oven tray. Place the package on a microwave safe glass or ceramic plate to avoid overheating and cracking the oven tray.

Do not exceed the Microwave Popcorn manufacturers' suggested popping time. Longer popping does not yield more popcorn but it can result in scorch, burn of fire. Remember, the Popcorn bag and tray can be too hot to handle. Remove with caution and use pot holders.

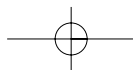

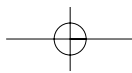

BEFORE YOU CALL FOR SERVICE

Refer to the following checklist, you may prevent an unnecessary service call.

* The oven doesn't work :

1. Check that the power cord is securely plugged in.
2. Check that the door is firmly closed.
3. Check that the cooking time is set.
4. Check for a blown circuit fuse or tripped main circuit breaker in your house.

* Sparking in the cavity;

1. Check utensils. Metal containers or dishes with metal trim should not be used.
2. Check that metal skewers or foil does not touch the interior walls.

If there is still a problem, contact the service station.

A list of these stations is included in the oven.

DO NOT ATTEMPT TO SERVICE THE OVEN YOURSELF !

QUESTIONS AND ANSWERS

* **Q** : I accidentally ran my microwave oven without any food in it. Is it damaged?

A : Running the oven empty for a short time will not damage the oven. However, it is not recommended.

* **Q** : Can the oven be used with the glass tray or roller guide removed?

A : No. Both the glass tray and roller guide must always be used in the oven before cooking.

* **Q** : Can I open the door when the oven is operating?

A : The door can be opened anytime during the cooking operation. Then microwave energy will be instantly switched off and the time setting will maintain until the door is closed and START is touched.

* **Q** : Why do I have moisture in my microwave oven after cooking?

A : The moisture on the side of your microwave oven is normal. It is caused by steam from cooking food hitting the cool oven surface.

* **Q** : Dose microwave energy pass through the viewing screen in the door?

A : No. The metal screen bounces back the energy to the oven cavity. The holes are made to allow light to pass through. They do not let microwave energy pass through.

