

Crosley

LCD TELEVISION INSTRUCTION MANUAL

C32HDGB

C37HDGB

C42HDGB

**Proper use guarantees
product life.**

Before using the product, be advised
that you read this owner's manual well
and try to operate it.

Caution

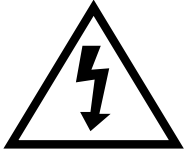
	CAUTION RISK OF ELECTRIC SHOCK DO NOT OPEN	
CAUTION : TO REDUCE THE RISK OF ELECTRIC SHOCK, DO NOT REMOVE COVER (OR BACK). NO USER-SERVICEABLE PARTS INSIDE. REFER SERVICING TO QUALIFIED SERVICE PERSONNEL.		

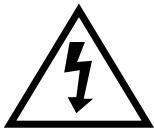

The lightning flash with arrowhead symbol, within an equilateral triangle, is intended to alert the user to the presence of uninsulated "dangerous voltage" within the product's enclosure that may be of sufficient magnitude to constitute a risk electric shock.



The exclamation point within an equilateral triangle is intended to alert the user to the presence of important operating and servicing instructions in the literature accompanying the appliance.

WARNING : TO REDUCE THE RISK OF FIRE OR ELECTRIC SHOCK HAZARD, DO NOT EXPOSE THIS APPLIANCE TO RAIN OR MOISTURE.

CAUTION : TO PREVENT ELECTRIC SHOCK, MATCH WIDE BLADE OF PLUG TO WIDE SLOT, FULLY INSERT.

Caution

FCC RF IINTERFERENCE STATEMENT

NOTE :

This equipment has been tested and found to comply with the limits for a Class B digital device, pursuant to Part 15 of the FCC Rules. These limits are designed to provide reasonable protection against harmful interference in a residential installation.

This equipment generates, uses and can radiate radio frequency energy and, if not installed and used in accordance with the instructions, may cause interference to radio communications. However, there is no guarantee that interference will not occur in a particular installation.

If this equipment does cause interference to radio or television reception which can be determined by turning the equipment off and on, the user is encouraged to try to correct the interference by one or more of the following measures.

- Reorient or relocate the receiving antenna.
- Increase the separation between the equipment and receiver.
- Connect the equipment into an outlet on a circuit different from that to which the receiver is connected.
- Consult authorized service centers for help.
- Only shielded interface cable should be used.

Finally, any changes or modifications to the equipment by the user not expressly approved by the grantee or manufacturer could void the users authority to operate such equipment,

Important Safeguards

Please read the following safeguards for your TV and retain for future reference. Always follow all warnings and instructions marked on the television.

1. Read, Retain and Follow All Instructions

Read all safety and operating instructions before operating the TV. Retain them safely for future reference. Follow all operations and instructions accordingly.

2. Heed Warnings

Adhere to all warnings on the appliance and in the operating instructions.



3. Cleaning

Unplug the TV from the wall outlet before cleaning. Do not use liquid, abrasive, or aerosol cleaners. Cleaners can permanently damage the cabinet and screen. Use a lightly dampened cloth for cleaning.



4. Attachments and Equipment

Never add any attachment and/or equipment without approval of the manufacturer as such additions may result in the risk of fire, electric shock or other personal injury.



5. Water and Moisture

The apparatus shall not be exposed to dripping or splashing and that no objects filled with liquids, such as vases, shall be placed on the apparatus.

6. Setting

Do not place this TV on an unstable cart, stand or table. Placing the TV on an unstable base can cause the TV to fall, resulting in serious personal injuries as well as damage to the TV. Use only a cart, stand, bracket or table recommended by the manufacturer or salesperson.

7. Ventilation

Slots and openings in the cabinet are provided for ventilation and to ensure reliable operation of the TV and to protect it from overheating. Do not cover the ventilations openings in the cabinet and never place the set in a confined space such as built-in cabinet unless proper ventilation is provided. Leave a minimum 10 cm gap all around the unit.

8. Power Source

This TV should be operated only from the type of power source indicated on the marking label. If you are not sure of the type of power supplied to your home, consult your appliance dealer or local power company.

9. Grounding or Polarization

This TV is equipped with a polarized alternating current line plug (a plug having one blade wider than the other). This plug will fit into the power outlet only one way. This is a safety feature. If you are unable to insert the plug fully into the outlet, try reversing the plug. If the plug should still fail to fit, contact your electrician to replace your obsolete outlet. Do not defeat the safety purpose of the polarized plug. A warning that an apparatus with CLASS I construction shall be connected to a MAINS socket outlet with a protective earthing connection.

10. Power-Cord Protection

Power-supply cords should be routed so that they are not likely to be walked on or pinched by items placed upon or against them, paying particular attention to cords at plugs, wall outlets, and the point where they exit from the TV. MAINS plug is used as the disconnect device, the disconnect device shall remain readily operable.

11. Lightning

For added protection for this TV during a lightning storm, or when it is left unattended and unused for long periods of time, unplug it from the wall outlet and disconnect the antenna or cable system. This will prevent damage to the TV due to lightning and power-line surges.

Important Safeguards

13. Power Lines

An outside antenna system should not be located in the vicinity of overhead power lines or other electric light or power circuits, or where it can fall into such power lines or circuits. When installing an outside antenna system, extreme care should be taken to keep from touching such power lines or circuits as contact with them might be fatal.

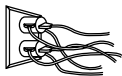

14. Overloading

Do not overload wall outlets and extension cords as this can result in a risk of fire or electric shock.

15. Object and Liquid Entry

Never push objects of any kind into this TV through openings as they may touch dangerous voltage points or short-out parts that could result in fire or electric shock. Never spill liquid of any kind on or into the TV.

16. Outdoor Antenna Grounding

If an outside antenna or cable system is connected to the TV, be sure the antenna or cable system is grounded so as to provide some protection against voltage surges and built-up static charges. Section 810 of the National Electric Code, ANSI /NFPA No. 70-1984, provides information with respect to proper grounding of the mast and supporting structure, grounding of the lead in wire to an antenna discharge unit, size of grounding conductors, location of antenna discharge unit, connection to grounding electrodes, and requirements for the grounding electrode.

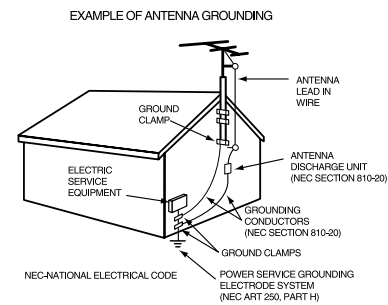

17. Servicing

Do not attempt to service this TV yourself as opening or removing covers may expose you to dangerous voltage or other hazards. Refer all servicing to qualified service personnel.

18. Damage Requiring Service

Unplug the TV from the wall outlet and refer servicing to qualified service personnel under the following conditions:

- When the power-supply cord or plug is damaged.
- If liquid has been spilled, or objects have fallen into the TV.
- If the TV has been exposed to rain or water.
- If the TV does not operate normally by following the operating instructions. Adjust only those controls that are covered by the operating instructions as an improper adjustment of other controls may result in damage and will often require extensive work by a qualified technician to restore the TV to its normal operation.
- If the TV has been dropped or the cabinet has been damaged.
- When the TV exhibits a distinct change in performance - this indicates a need for service.

19. Replacement Parts

When replacement parts are required, be sure the service technician has used replacement parts specified by the manufacturer or have the same characteristics as the original part. Unauthorized substitutions may result in fire, electric shock or other hazards.

20. Safety Check

Upon completion of any service or repair to the TV, ask the service technician to perform safety checks to determine that the TV is in safe operating condition.



21. Heat

The product should be situated away from heat sources such as radiators, heat registers, stoves, or other products (including amplifiers) that produce heat.

Warning

This section must be read carefully and followed by the user prior to the operation of the product.

The manual states important instructions for the user's own safety, and the proper operation of the product.



Warning

Ignoring or disregarding the contents of this section and improper operation of the product may result in the person's death or serious injury.

In case of an accident, please unplug the unit from the outlet immediately.

To reduce the risk of electric shock, do not remove cover or back. No user-serviceable parts inside. Refer to qualified service personnel for repair.



Do not put any object that contains water - such as flowerpot - near to the unit. The water may penetrate into the unit, and be a cause of fire or hazardous electric shock.



To prevent fire and damages to the product, unplug the unit from the outlet during lightning storm, or when it is left unattended and unused for a long period of time.

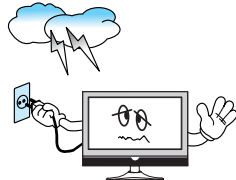

Do not put on or use the product near water and moisture - such as in a bathroom, washbowl, etc. It may be a cause of fire and electric shock hazards.



Slots and openings in the case are provided for ventilation to ensure reliable operation of the product. Never put in any item - such as a coin, paper, match - through these openings since it may touch dangerous voltage points that could result in fire or shock hazard.

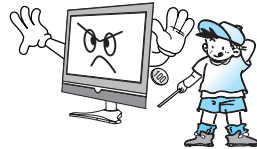

Do not let children hang on or climb on the product since it may be a cause of serious injury.



Hold the plug when unplugging the unit from the outlet. The cord may cause fire or electric shock if damaged.



Do not cause the product to lean or put it in an unstable place since it may cause a serious injury to a person, as well as damage to the product if it falls.



Warning

This section must be read carefully and followed by the user prior to the operation of the product.

The manual states important instructions for the user's own safety, and the proper operation of the product.



Caution

Ignoring or disregarding the contents of this section and improper operation of the product may result in the person's death or serious injury.

Please keep the user's manual in a safe place for future reference.

Do not put volatile substance-such as benzene, naphtha- near the product since it may cause a change in the product's colour.

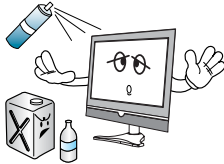

Do not spill water or drop the remote controller since it may be a cause of malfunctioning.



Do not view the TV too closely since it may cause damage in your eyesight.

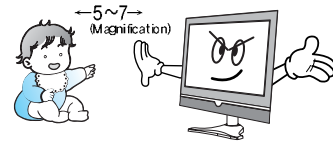

Refer servicing to qualified service personnel for cleaning at least once a year since dust inside the TV set may be a result or fire and malfunctioning of the product.



Do not cover the top of the television set. Ventilation will be prevented, and it may be a cause of fire if the product is internally overheated.



The product should be situated away from any heat source-such as radiators, heat registers, stoves, or other products that produce heat.

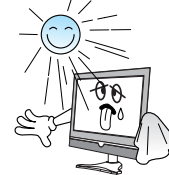

Do not put on any heavy item on the power cord since it may result in fire or hazardous electric shock if the cord is damaged.

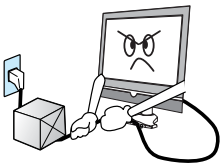

Please be advised of electric wires and cables when installing the antenna. It may be a cause of hazardous electric shock and fire if the antenna touches or falls on the electric wire; thus, it must be installed firmly, and far away from the cables.



Unplug the power from the outlet and all the related connections from the unit to prevent electric shock. At least two people must work together to move the TV set when transporting to prevent the TV from falling, and consequently, any serious injury or damage.



Do not touch the power cord with moisturized or wet hands when plugging to or unplugging from the outlet since it may be a cause of electric shock.



Do not expose the product to a dusty or moisturized place since it may be a cause of malfunctioning.



Table of Contents

Installation and Maintenance

Antenna Connection	9
Video Connection	12
Camcorder & Video Game Connection	13
DVD Player Connection	14
STB(Set Top Box) Connection	15
PC Connection	16
Cable TV Broadcasting Connection	18
Connect with the Dolby Digital AMP	19
Name of Each Part	20

Basic Guide

Parts of the Remote Controller	22
Method To Use Basic Menu	24
To Watch TV	25
Setting Up TV Stations	27
Selection of TV/VIDEO Input Signal	30
Selection Multimedia Input Signal	31

Application Guide

Picture Adjustment	33
Sound Adjustment	37
Features - Closed Caption	42
Features - PIP/POP	44
Features - Parental Control	46
Features - ETC	49
Time Setting	51
Channel Banner	54
Troubleshooting	56
Standard of Product	58

Supplied Accessories

Make sure that the following accessories are provided with the product.

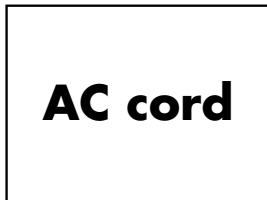

AC cord

AC cord

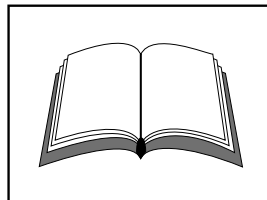

Instruction manual

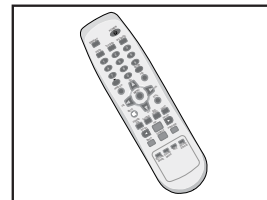

Remote controller

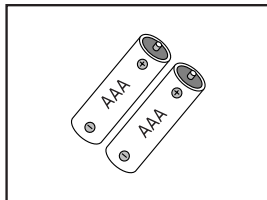

Batteries

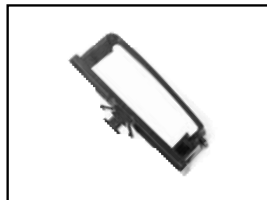

Cable holder

The method of wire arrangement

1. Assemble the cable holder enclosed on the back of TV. (PICTURE 1)
(ASSEMBLY METHOD: After you push the "A"(prominence part of cable holder) in the hole, rotate the cable holder clockwise as an angle of 90°. You can separate in reverse order of assembly.)
2. Open the cable holder. (PICTURE 2)
(you can open the cable holder then press and push "B" part.)
3. After arranging cables with the cable holder, lock "B" again. (PICTURE 3)

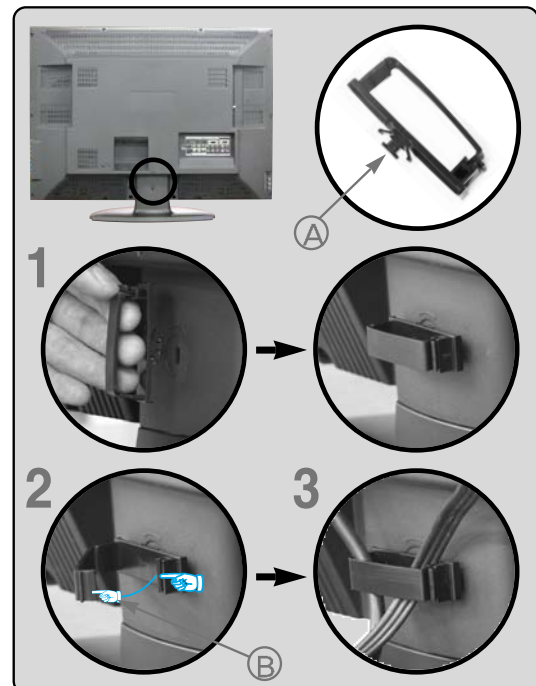

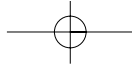

Antenna Connection

Indoor Antenna Connection

1. Connect the feeder cable of the antenna to the combining adapter.

WHEN THE IMAGE IS NOT CLEAR : Unclear screen image and bad reception may be a cause of wrong antenna connection. Be sure to check its direction and place when installing.

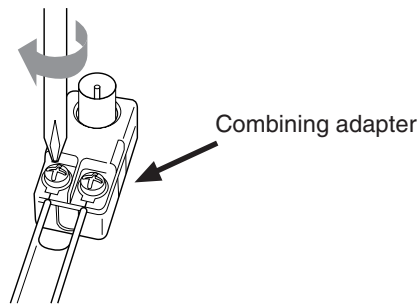

2. Connect the combining adapter to the antenna input at the left side of the TV set.

WHEN USING THE COMBINING ADAPTER : You may obtain the combining adapter at your closest Service Center.

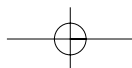
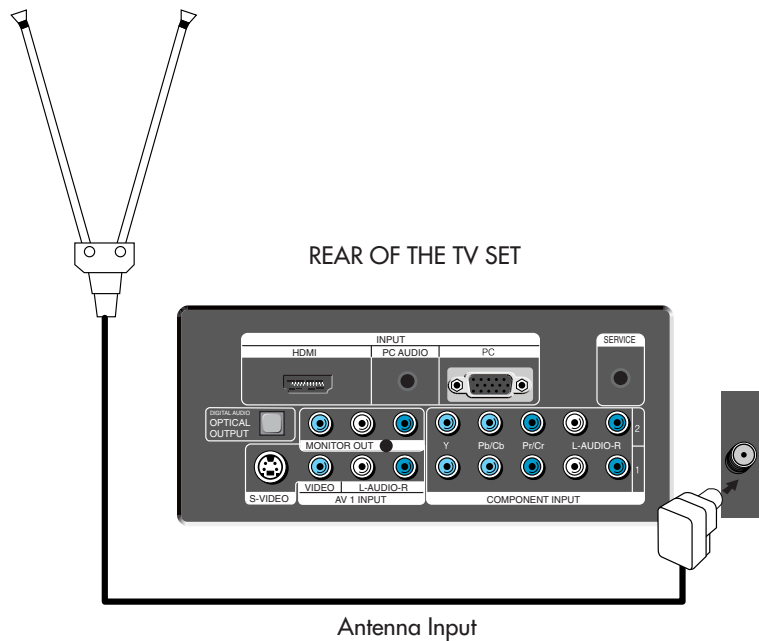

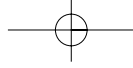

Antenna Connection

Antenna Connection

Such community TV Antenna installation may be found in most of co-op apartments.

When a coaxial cable is used : Plug the coaxial cable to the antenna socket on the wall.

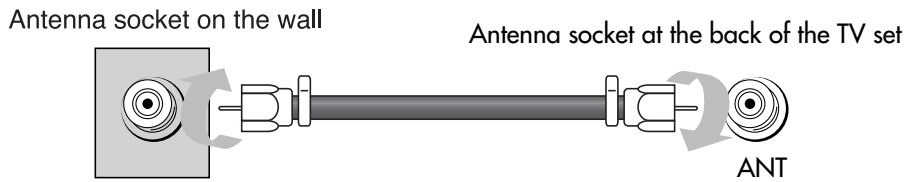

When a feeder cable is used : Plug the coaxial cable to the antenna socket on the wall.

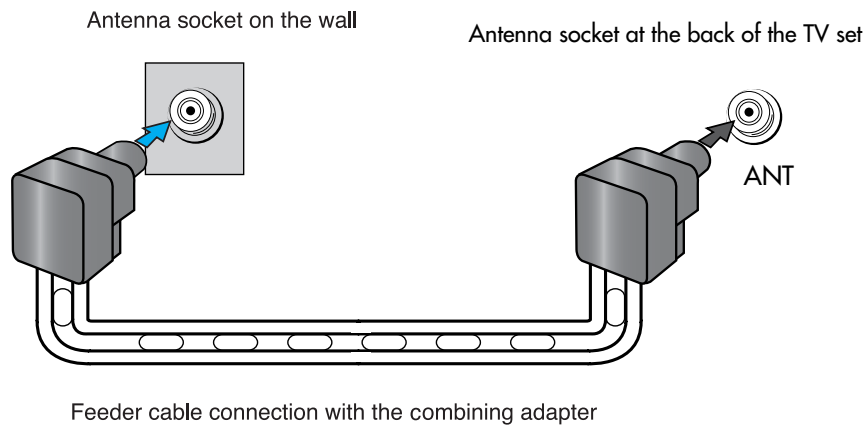

Feeder cable connection with the combining adapter

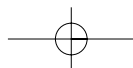
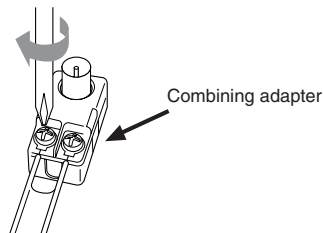

Antenna Connection

Outdoor Antenna Connection

Outdoor Antenna connection-such as VHF or/and UHF-may be necessary for installation at private houses

Single Antenna Connection

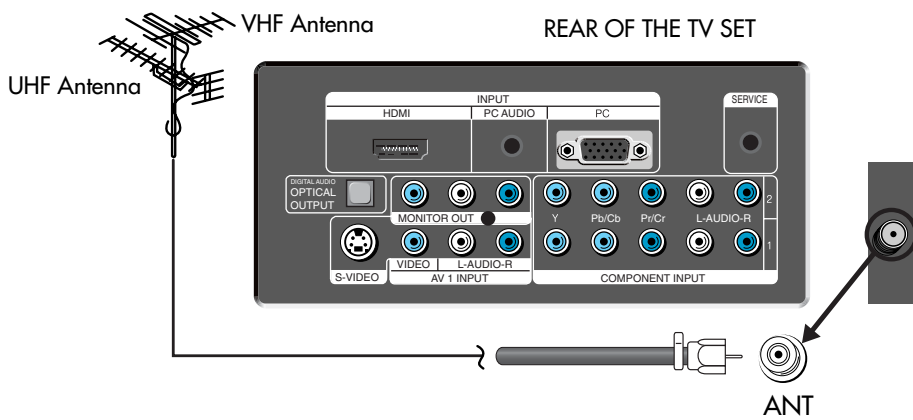

Separate Antenna Connection.

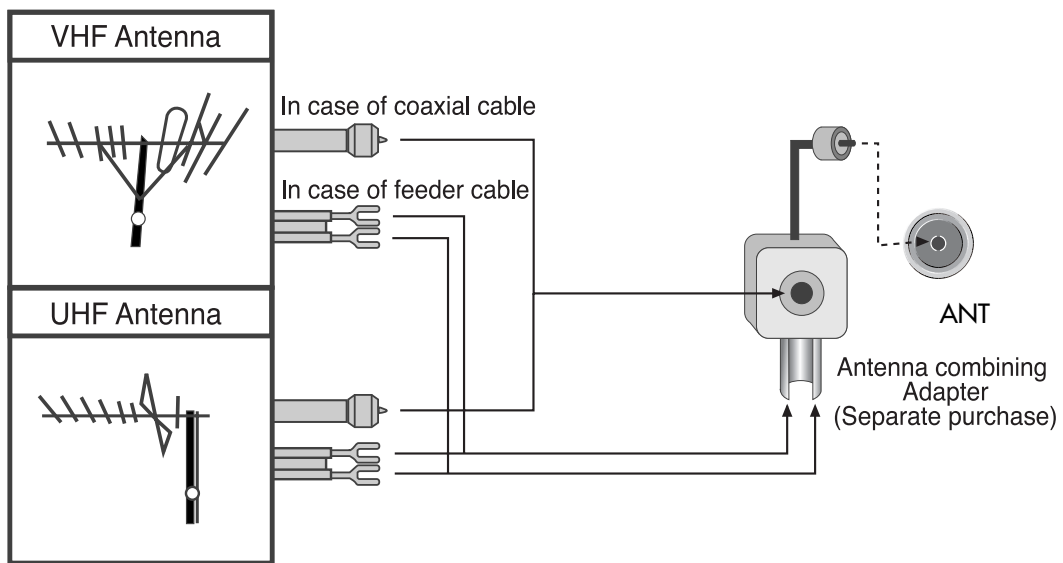

Video Connection

Connecting with an External Source

You may connect S-Video 1 (Rear of the TV) or S-Video 2 (Side) input to enjoy clearer and brighter picture images. You can make the connection with the AV1 or AV2 input.

REAR AND SIDE OF THE TV SET

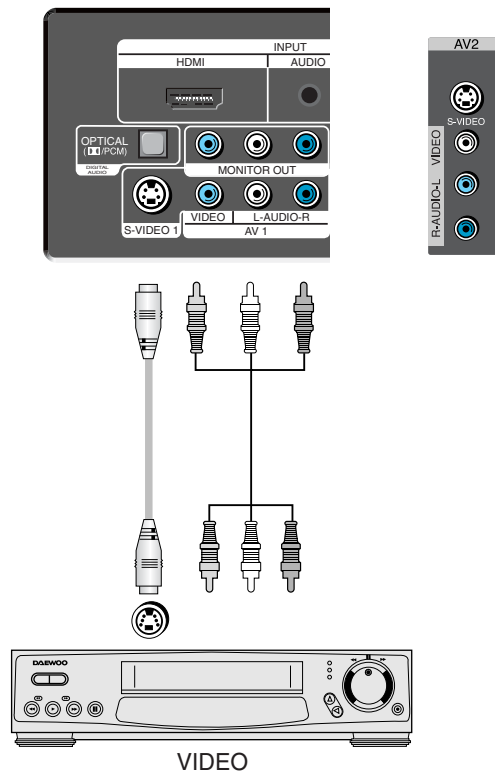

- Note :**
- If your AV device has both Video OUT terminal and S-Video OUT terminal, S-Video connection is recommended for better picture quality.
 - If S-Video and RCA jack are connected at the same time, the TV set will only detect the S-Video mode.

Camcorder & Video Game Connection

Watching the Camcorder Recording or Video Game on TV

1. Prepare the S-video and RCA connector.
2. These connectors connect to Video1/2 or S-Video1/2 like below the picture.
3. Turn on the TV set and camcorder/video game.
4. Select Video1/2 or S-video1/2, using the "TV/VIDEO" of the Remote controller or "TV/VIDEO" button of the TV set.

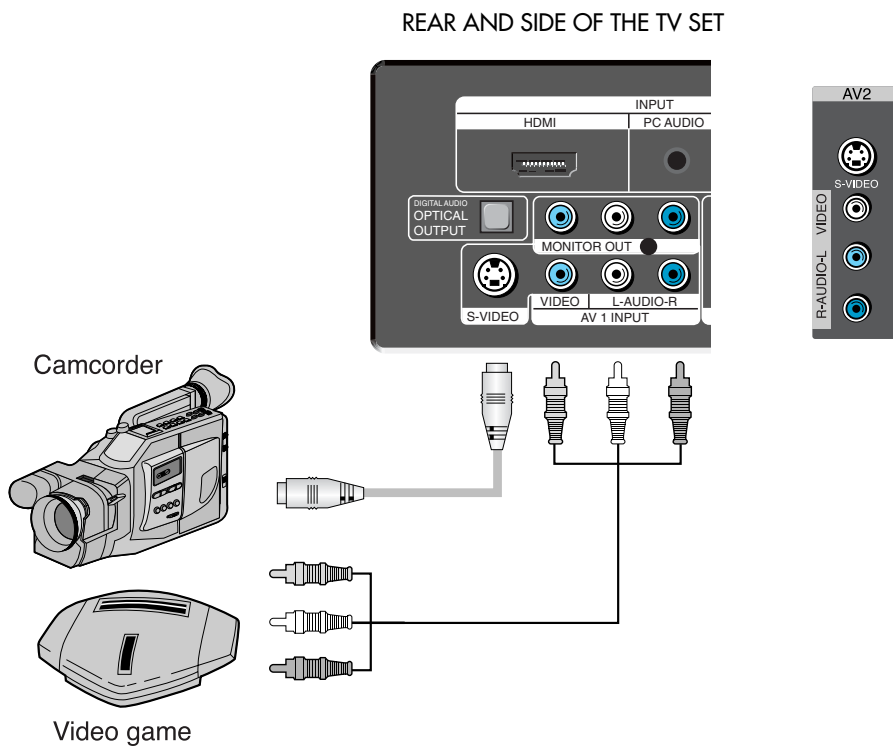

- Note :**
- If your AV device has both Video OUT terminal and S-Video OUT terminal, S-Video connection is recommended for better picture quality.
 - If S-Video and RCA jack are connected at the same time, the TV set will only detect the S-Video mode.

DVD player connection

When connecting with a component cable

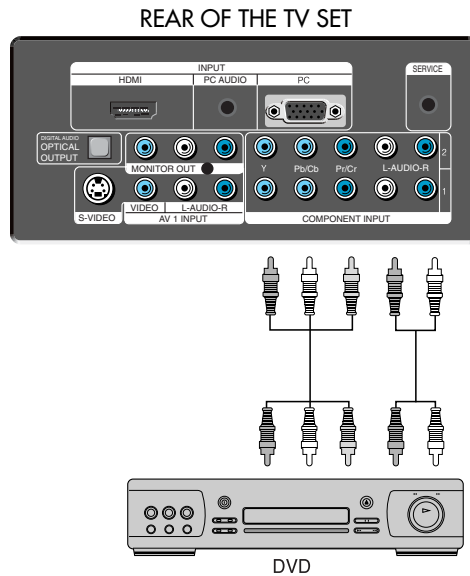

Note : When you connect with the component, please check the color of cable between DVD and TV set.

When connecting with a S-VHS cable and RCA cable

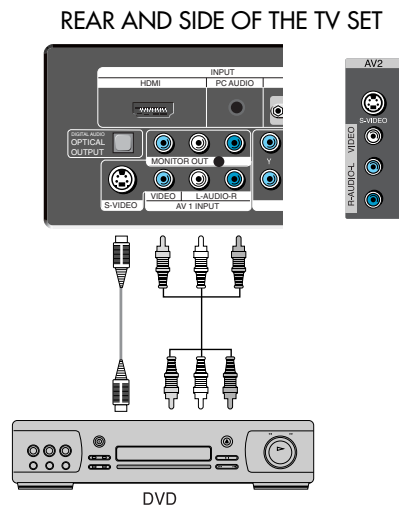

- Note :**
- If your AV device has both Video OUT terminal and S-Video OUT terminal, S-Video connection is recommended for better picture quality.
 - If S-Video and RCA jack are connected at the same time, the TV set will only detect the S-Video mode.

STB(Set Top Box) Connection

When connecting with a HDMI cable

REAR OF THE TV SET

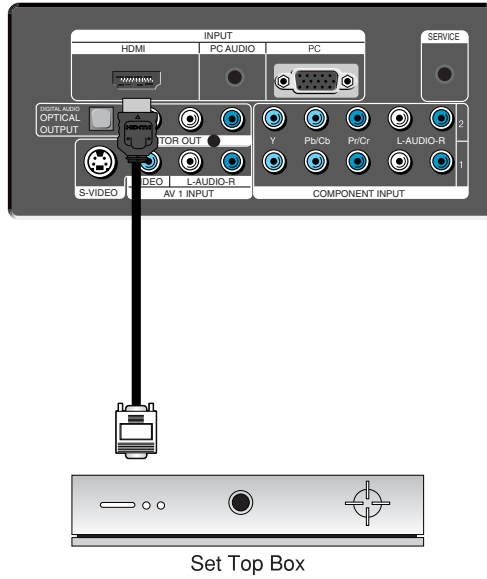

Set Top Box

When connecting with a component cable

REAR OF THE TV SET

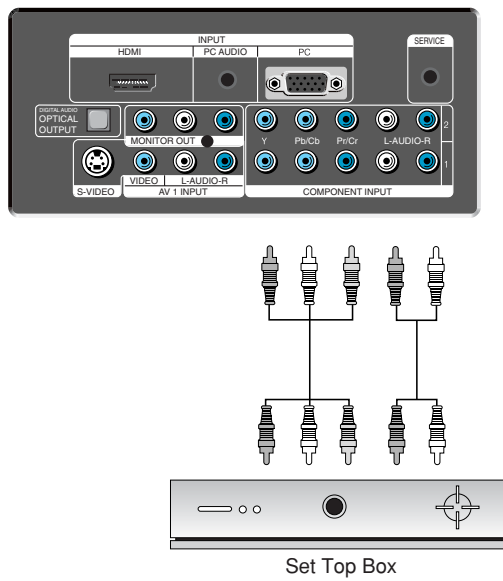

Set Top Box

PC Connection

When connecting with PC(D-Sub) cable.

1. Adjust PC resolution to available resolution in LCD TV.
2. Connect between PC and TV set using the D-Sub and Audio cable like below the picture.
3. Turn on the PC and TV set.
4. Select PC mode by pressing "MULTIMEDIA" button on the remote control or "TV/VIDEO" button of the TV set.

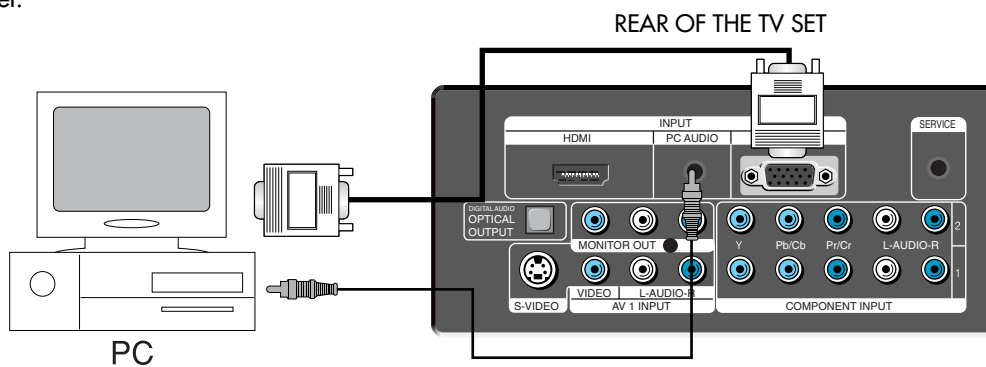

When connecting with a HDMI cable.

1. Adjust PC resolution to available resolution in LCD TV.
2. Connect between PC and TV set using the HDMI and Audio cable like below the picture.
3. Turn on the PC and TV set.
4. Select HDMI mode by pressing "MULTIMEDIA" button on the remote control or "TV/VIDEO" button of the TV set.

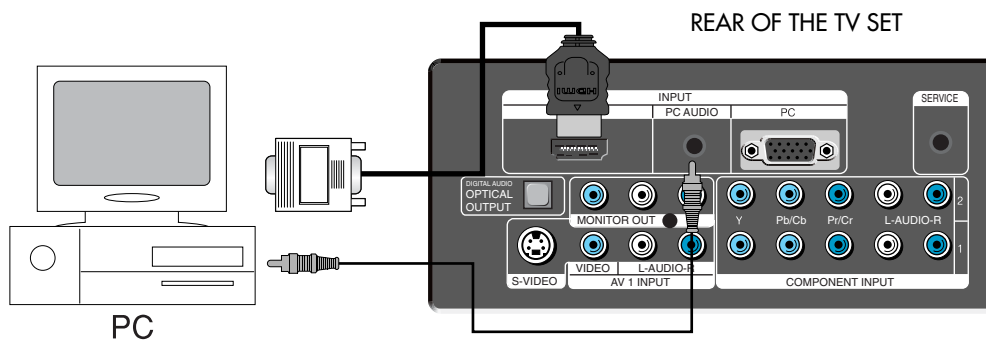

Note : If the graphic card of the PC only support DVI signal, you must connect the Audio cable like above the picture.

PC Connection

PC CONNECTION NOTES:

- 1) If there is a [Vertical Frequency] setting menu in the [Screen] Menu of the PC, adjust the frequency to 60Hz.
- 2) If the PC resolution is too high, it may be hard to read letters. Select a suitable resolution.
- 3) HDMI input port receives only Digital Signal.
- 4) Depending on the graphic card when you plug & unplug the HDMI connection, the screen may not display correctly.
Restart the computer if this happens.

Multi input resolution available in LCD TV.

Resolution	V-freq	HDMI	PC(D-Sub)	Component	Standard
640 X 480	60Hz	○	○	X	VESA Standard
	75Hz	○	○	X	VESA Standard
800 X 600	60Hz	○	○	X	VESA Standard
	75Hz	○	○	X	VESA Standard
1024 X 768	60Hz	○	○	X	VESA Standard
	75Hz	○	○	X	VESA Standard
1280 X 768	60Hz	○	○	X	VESA Standard
	75Hz	○	○	X	VESA Standard
1280 X 1024	60Hz	○	○	X	VESA Standard
	75Hz	○	○	X	VESA Standard
720 X 480i	60Hz	X	X	○	
720 X 480p	60Hz	○	○	○	
1280 X 720p	60Hz	○	○	○	
1920 X 1080i	60Hz	○	○	○	
1920 X 1080p	60Hz	○	○	○	

Note :

1. When you connect with component, PC (D-Sub), and HDMI, you must check the input resolution of external devices.
2. So if this mode is used at PC mode, the screen can be enlarged.

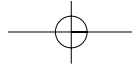

Cable TV Broadcasting Connection

External Input Connection Source

Watching cable television is only possible after you have subscribed to the local broadcasting company and installed a cable receiver. You may make the connection to either the Component input, Video1 input or Video2 input.

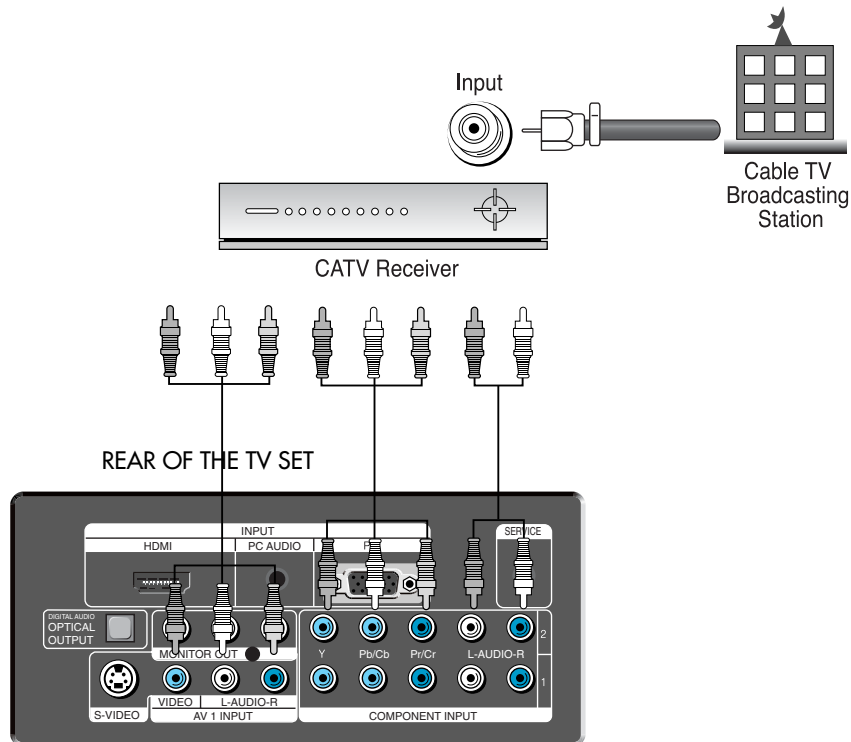

Antenna Input Connection

Watching cable television is only possible after you have subscribed to the local broadcasting company and installed a cable receiver.

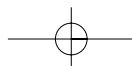
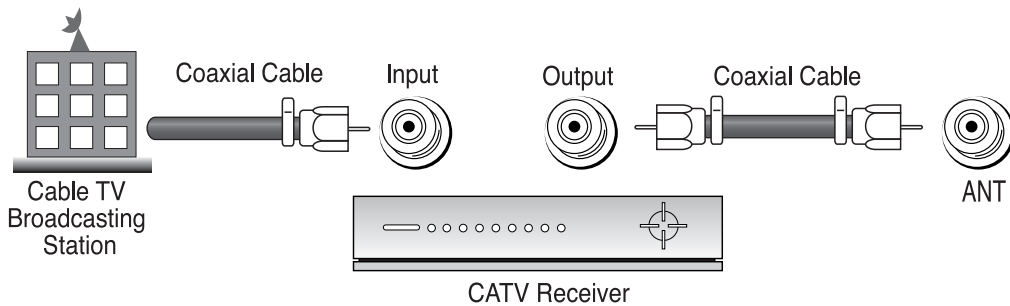

Connect with the Dolby Digital AMP.

If you connect the optical output to a Dolby digital AMP, you can listen to better sound.

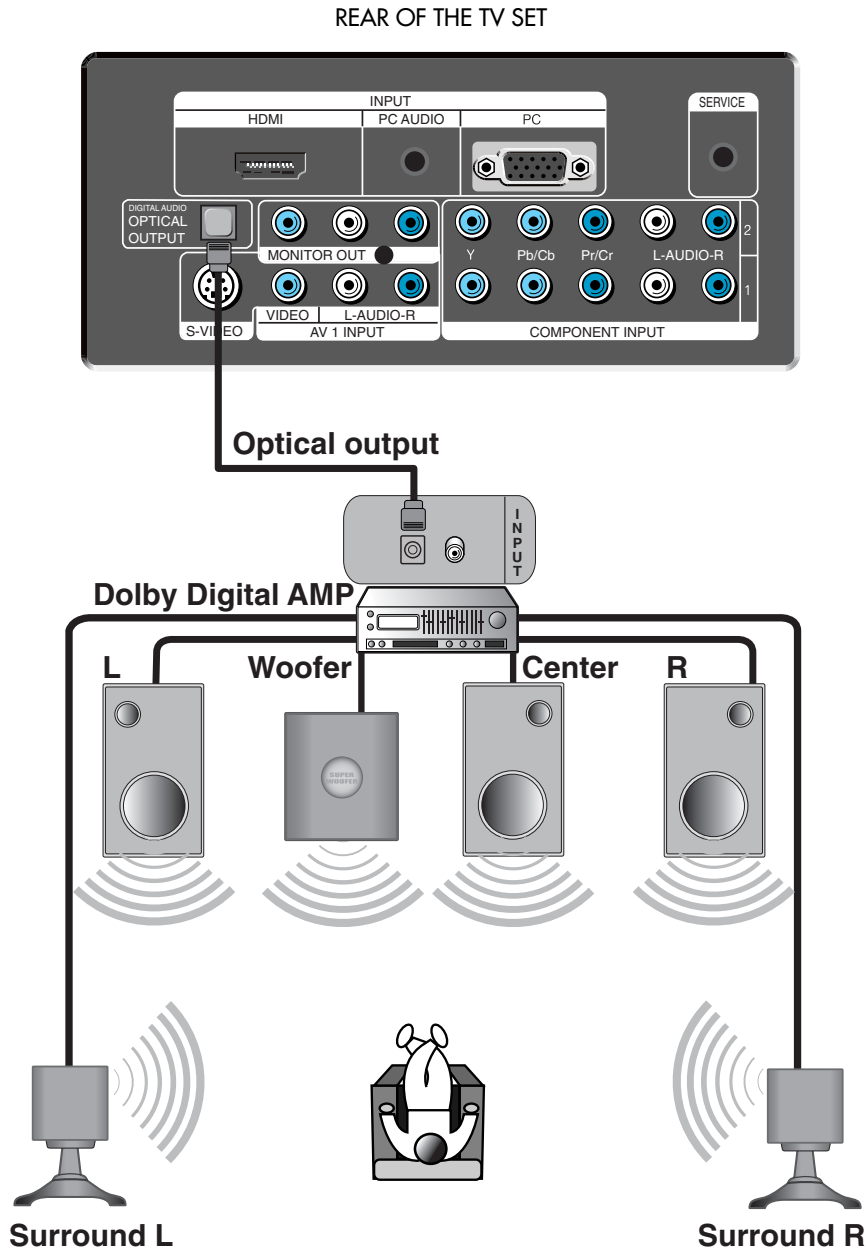

Name of Each Part

Front Panel and Side

Buttons on the TV set have the same functions as those of the remote controller.

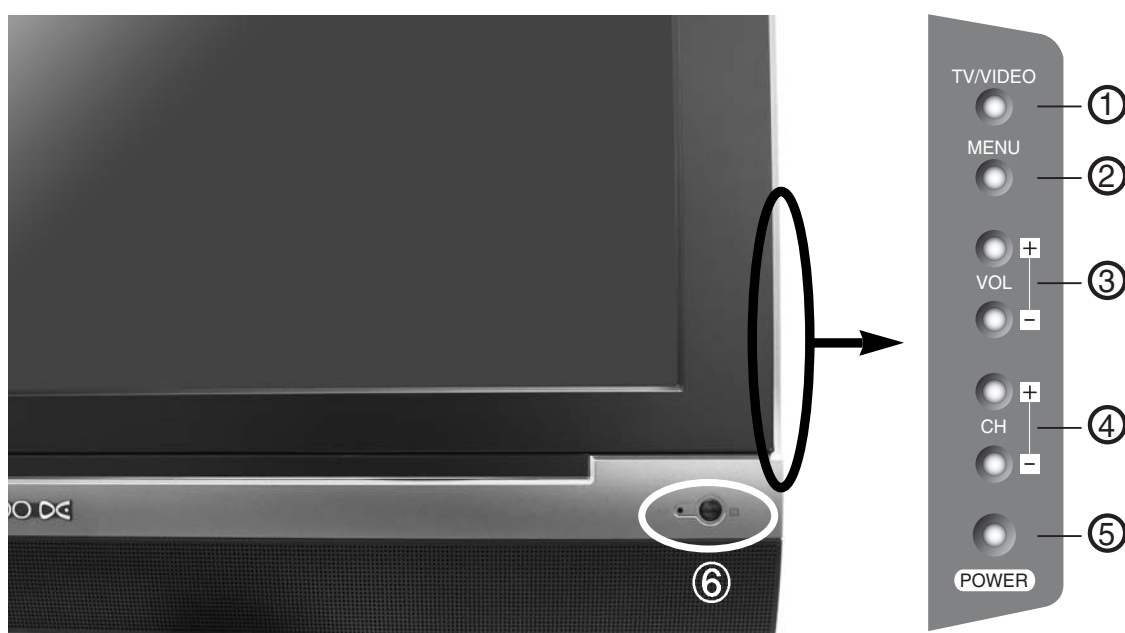

Control Key Buttons.

- ① **TV/VIDEO Buttons** : Each time you press this button, the TV will cycle through:
TV → Video1(S-Video1) → Video2(S-Video2) → COMPONENT1 → COMPONENT2 → HDMI → PC
- ② **MENU Button** : Use this button to enter and exit the MENU.
- ③ **VOL Buttons** : Use this buttons to change your TV's volume or to move the cursor in the menu.
- ④ **CH Buttons** : Use this buttons to change channels on your TV or to move the cursor in the menu.
- ⑤ **POWER Button** : Use this button to TV STAND-BY mode/TV ON mode.
- ⑥ **Remote controller signal receiver**

The screen contains the remote controller signal receiving window; therefore, point the remote controller towards the screen when using it.

Stand-by <LED Indicator>

- LED RED - Standby
- LED BLUE - SET ON

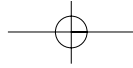

Name of Each Part

Rear of the TV set

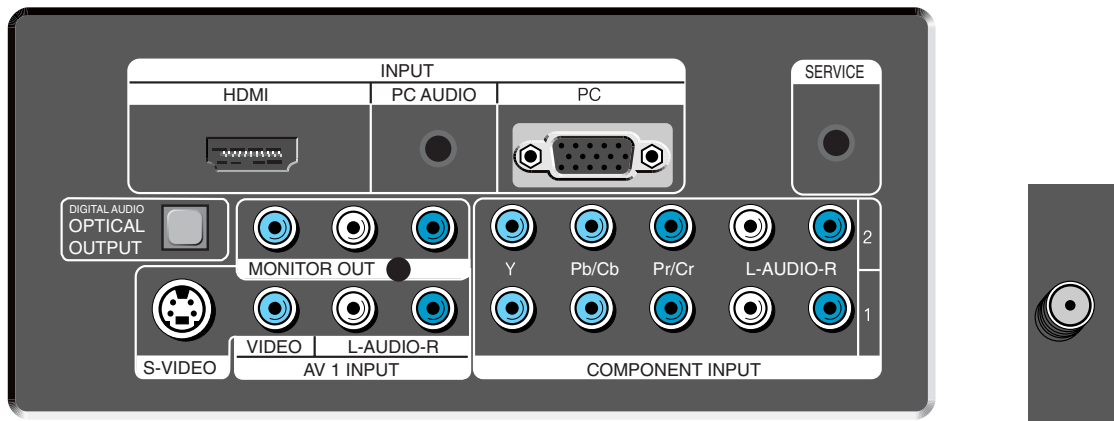

REAR OF THE TV SET

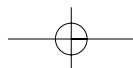

Parts of the Remote Controller

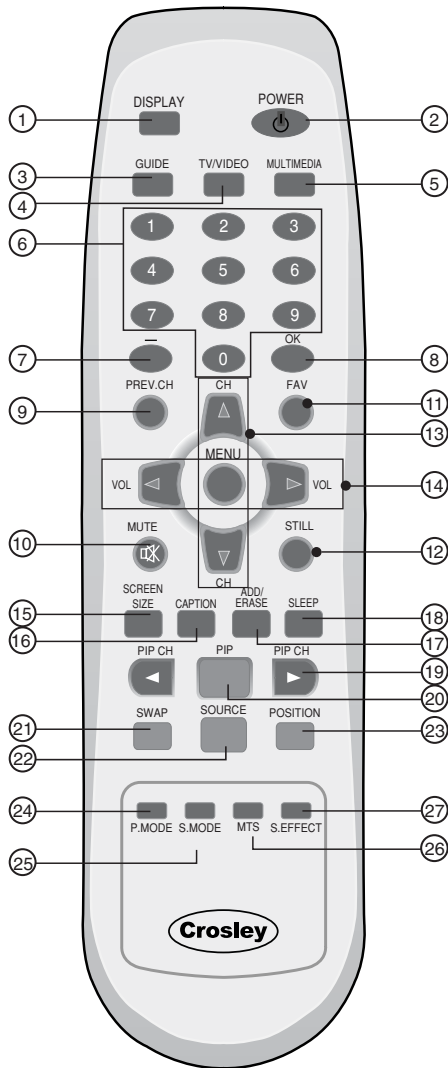

1. DISPLAY: Display the present modes (ATV/DTV, Video1/2, COMP.1/2, HDMI and PC) and signal information.

Note: In Analog TV mode, you can see information about the Channel number, Sound, and Clock. In Digital TV mode, you can see information about a channel number, name, broadcasting time and more.

2. (POWER): Turns the TV on and off.

3. GUIDE: Access Electronic Program Guide (EPG). It works only in DTV mode.

4. TV/VIDEO: Each time you press this button, the TV will cycle Through: TV → AV1/2(S-Video1/2) → TV

5. MULTIMEDIA: Each time you press this button, the TV will cycle Through: Comp.1/2 → HDMI → PC → Comp. 1/2

6. NUMBER: Press the numbers on this board; you can select CH directly in TV mode. (EX: When you want to select CH10, you should press down "1" and "0" within 2second. If you only press down "1", after 2second, CH1 will be selected.)

7. — (DASH) : Used to enter a program number for multiple program channels such as 2-1, 2-2, etc.

8. OK: Confirms a selection.

9. PREV CH: Press this button, you can tune to the previous channel.

10. (MUTE): Press this button, and the sound goes off. Press again, and the sound returns.

11. FAV : Press to switch to your favorite channels.

12. STILL : Press this button to freeze the picture.

13. ▲CH▼: Press to switch to your memorized channels in sequence.

14. ◀VOL▶: Adjust the volume.

15. SCREEN SIZE: Select screen aspect ratio. 16:9 → 4:3 → LB[16:9] → LBS[16:9]

Note: When current mode is multimedia (PC and HDMI), the aspect only work as the 16:9 or 4:3 mode. And "Screen Size" function is not available in PIP mode.

16. CAPTION: Controls the caption decoder.

Parts of the remote controller

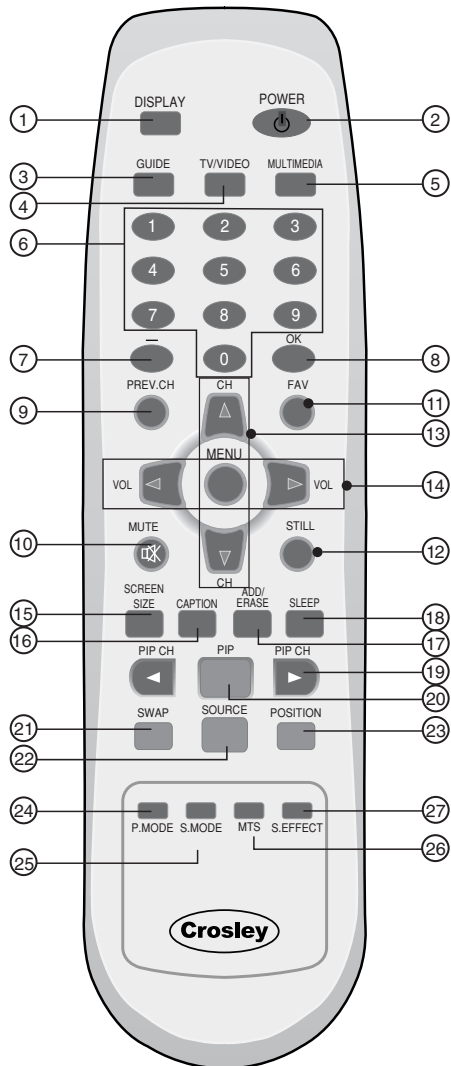

17. ADD/DEL: Use to add or delete channels to/from memory.

18. SLEEP: Sleep Timer setting.

SLEEP TIMER: Off → 15min → 30min → 60min → 90min → 120min → OFF

Note: If an active signal is not present for about 30 minutes, the set will automatically turn to ST-BY mode.

19. ◀CH▶: Displays the available channels in sequence.

20. PIP: Select either PIP / POP On or Off.

21. SWAP: Swap the main screen for sub screen.

22. SOURCE: Sub Screen input mode change as follows PIP table mode or POP table mode.

23. POSITION: Move the sub window position in PIP mode.

Position: right bottom → left bottom → left top → right top

24. P. MODE: Picture modes change as follows:

Normal → Dynamic → Cinema → User → Normal

25. S.MODE : Using this button, Select the desired sound mode.

Normal → Movie → Music → News → User → Normal

Note: SOUND MODE can be selected only SOUND EFFECT is off.

26. MTS: In Analog, you can select sound mode (Mono/Stereo/SAP). In Digital, you can select audio tracks (English/Spanish/French).

Note: The availability of audio track depends upon the program.

27. S.EFFECT: Using this button, Select the desired sound effect.

Off → VOICE EFFECT → DYNAMIC BASS → Off

Inserting Batteries into the Remote Control Unit

To load the batteries, turn the remote control handset over and open the battery compartment. Insert the batteries (Two 1.5v, type AAA). Make sure that the polarity matches with the (+) and (-) marks inside of the battery compartment.

Note: To avoid damage from possible battery leakage, remove the batteries if you do not plan to use the remote control handset for an extended period of time.

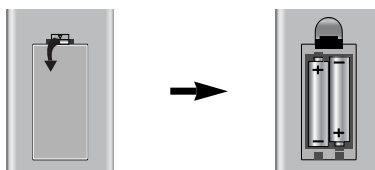

Method To Use Basic Menu

Basic Menu

- The basic menu appears on the screen if you press the menu button of the remote control.
- There are 5 items Picture, Sound, Channel, Features, and Time in the basic menu.
- Each item has sub-items under it. If the desired item is selected, the relevant sub-items are displayed upward.

1. Press the "MENU" button.

- The main menu appears if you press the "MENU" button.

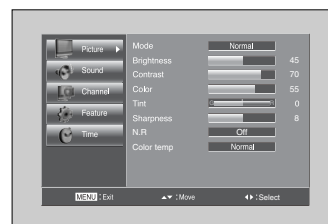
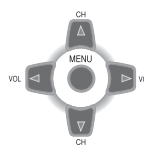

2. Press the "▲CH▼" button.

- You may setup according to the directions on the screen after selecting the desired item by pressing the "▲CH▼" button.
- If the setup is completed, exit from the menu by pressing the "MENU" button.

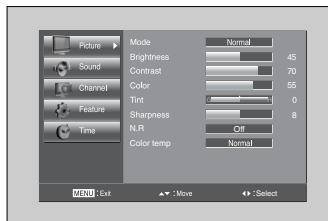
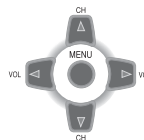

Picture

Adjusts Picture Mode

- Mode(Normal, Dynamic, Cinema, User), Brightness, Contrast, Color, Tint (NTSC only), Sharpness, Noise Reduction, and Color Temp.



Sound

Adjusts Sound Mode

- Balance, Effect(Off/Voice Effect/Dynamic Bass), AVC, Mode (Normal/ Movie / Music / News / User), Equalizer, Digital Vol. and Speaker



Channel

Adjusts Channel Mode

- Auto Search, Antenna (Air / Cable), Fine Tune, Favorite Channel Edit, Strength



Feature

Adjusts Feature Mode

- Caption, Caption Style, PIP, Background, Language, MGDI plus, Parental Control, and Initialize.



Time

Adjusts Time Mode

- Clock, Auto Clock, Off timer, Off time, Wake Timer, Wake Time, Wake CH, Wake Vol, Time zone, DST

To Watch TV

On/Off, Number, —, Enter, Mute, Display, ◀VOL▶, ▼CH▲

- Buttons with same name in the main body performs the same function.

Press the "POWER" button on TV set or Remote controller.

Note:

- The buttons of the remote control and the main body operate only when AC power turn on.
- You must pull out the plug of TV set to shut off the AC Power

When pressing the Digit Key button

- Press the "ENTER" button if using the number button for channel selection. For example, to watch the No.9 channel, Press the number button "9" and the "ENTER" button. If pressing only number "9" button, it takes a longer time to select the channel.
- To watch the No.9-1 channel, Press the button "9", "—", "1" and "ENTER" in sequence.

To suddenly turn sound off

- Press the "MUTE" (🔇) button.
 - No sound is heard if "MUTE (🔇)" is displayed on the screen.
 - Sound is heard again if you press the "MUTE (🔇)" button once again.
- For example, please use this button when telephone rings or when guest comes while watching TV.

Check of TV operation status

- Pressing the "DISPLAY" button, the status of channel or clock broadcasting being currently watched or entry status of video component is displayed on the screen.

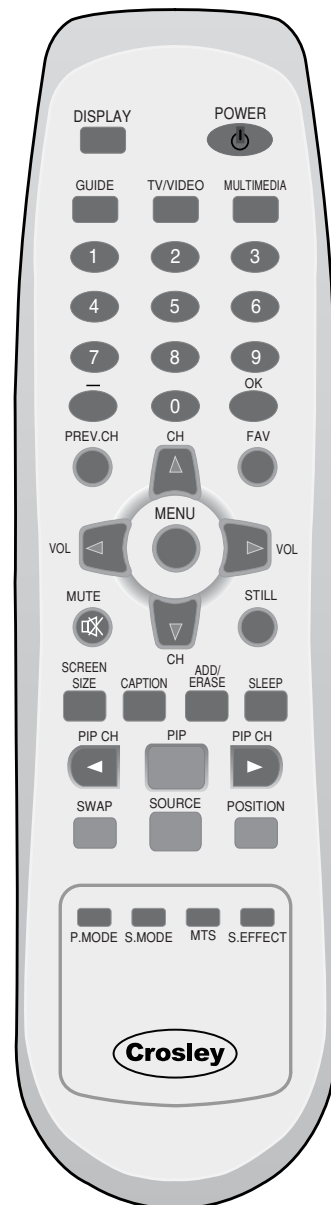

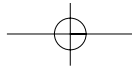

To Watch TV

1. Press the "POWER" button on TV set or remote controller.

- The Stand-by LED lamp turns on in red color.
- Press the "POWER" button on the TV set or remote controller.
- The Stand By LED lamp on the front panel begins to flicker in blue color and the TV turns on.



POWER



2. Press the "▼CH▲" button.

- Select the desired program by pressing the "▲CH▼" button or the number buttons.

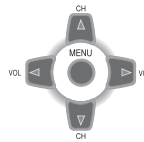

3. Adjust volume.

- Sound reduces by pressing the "◀VOL" button.
- Sound increases by pressing the "VOL▶" button.

Note : Sound mutes by pressing the "MUTE" (㉸) button.

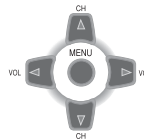

4. Press the "POWER" button of right side of the set or Remote controller for turning the TV off.

- TV turns off and the power lamp changes to red color.

POWER

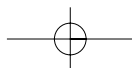
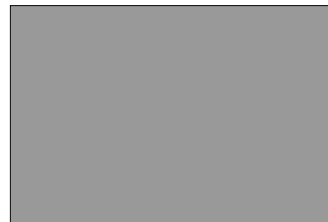

Setting Up TV Stations

Auto Search to find Channels

- All stations that can be received are stored by this method. It is recommended that you use Auto tuning during installation of this set.

1. Press the "MENU" button to select the Channel menu.

- Move the selection bar to the Channel menu with "▲CH▼" buttons.

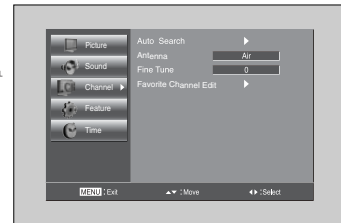
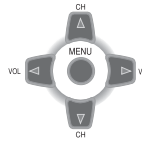

2. Select the "Antenna"

- Place the selection bar on Antenna and select Air, Cable with "◀VOL▶" buttons.

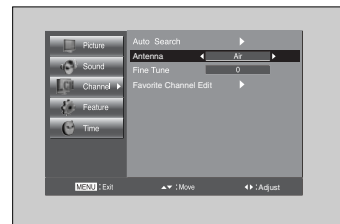
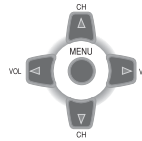

3. Select the "Auto Search".

- Place the selection bar on **Auto Search** and press the "◀VOL▶" button.

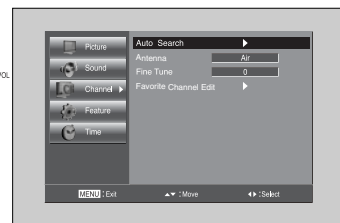
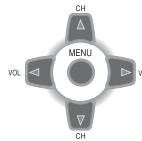

4. Press wait until the Channel menu appears.

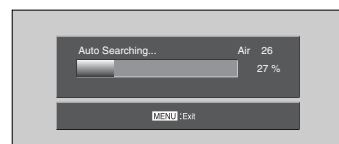

Setting Up TV Stations

Fine tune

1. Searching for channel finely

- Select a Channel number you want to tune finely with the "▲CH▼" buttons.
- Press the "MENU" button and move to the Channel menu.
- Move the selection bar to the Fine tune with "▲CH▼" buttons.
- Press the "◀VOL▶" buttons to adjust the fine tuning.

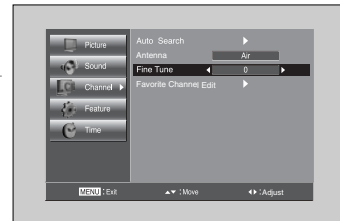
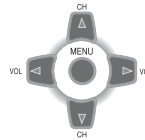

Note:

- If you are unable to get a good picture or Sound because of a poor broadcasting signal, adjustment of Frequency might improve it.

Channel Add/Delete

1. Adding the Channel

- Select a Channel number you want to add with the "NUMBER" buttons.
- Press the "ADD/ERASE" button to add the channel
- Move the selection box to the Yes and press the "ADD/ERASE" button again.

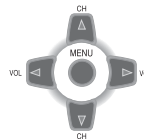

2. Deleting the Channel

- Select a Channel number you want to delete
- Press the "ADD/ERASE" button to delete the channel
- Move the selection box to the Yes and press the "ADD/ERASE" button again.

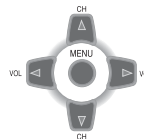

Setting Up TV Stations

Favorite Channel Edit

1. Locate the selection bar on the Favorite Channel Edit.

- Move to Favorite Channel Edit in the Channel menu.
- Press the "◀VOL▶" buttons.

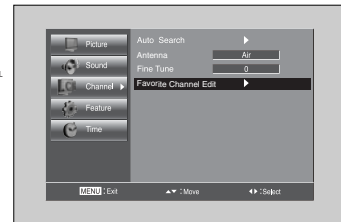
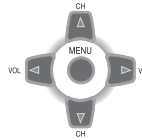

2. Add the Favorites Channel

- Move the selection bar to the Current Channel with "▲CH▼" buttons.
- Select a Channel number you want to add in Favorites Channel List with the "◀VOL▶" buttons.
- Add the Channel with "DISPLAY" button.

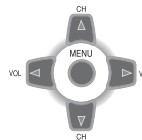

3. Delete the Favorites Channel

- Move a Favorite Channel you want to delete in Favorites Channel List with the "▲CH▼/◀VOL▶" buttons.
- Delete the Favorite Channel with "DISPLAY" button.

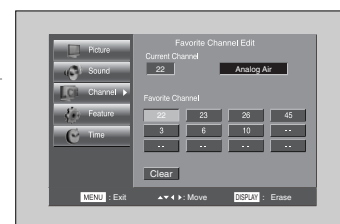
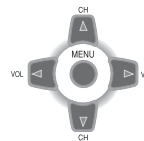

4. Viewing the Favorite CH

- Whenever pressing "FAV" button, the Channel changes as the selected Channel order.

Signal Strength(Digital TV mode only)

- Reveals how strong your DTV signal is and whether you need to adjust your antenna.
- The higher the signal strength, the less likely you are to experience picture degradation.
- Digital TV Signals; May not be available in all areas, nor broadcast all channels.

1. Locate the selection bar on the strength.

- Move to strength in the Channel menu.
- Display the strength status of digital signal.

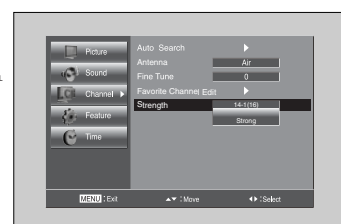
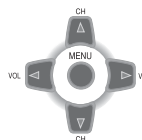

Selection of TV/VIDEO Input Signal

When watching video, Camcorder, DVD, Cable TV with External Input

- When pressing TV/VIDEO button on the remote controller screen changes as follows:
TV => AV1(S-Video1) => AV2(S-Video2) => TV

1. Press the "TV/VIDEO" button on the remote controller.

- Screen changes as follows whenever pressing the "TV/VIDEO" button.
TV => AV1(S-Video1) => AV2(S-Video2) => TV

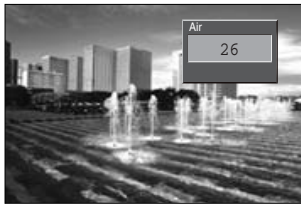
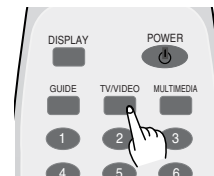

Note:

- If S-video and RCA jack are connected at the same time, the TV set will only detect the S-Video mode.
- If sound signal is mono method, connect it to the L-terminal of the sound input terminal.