

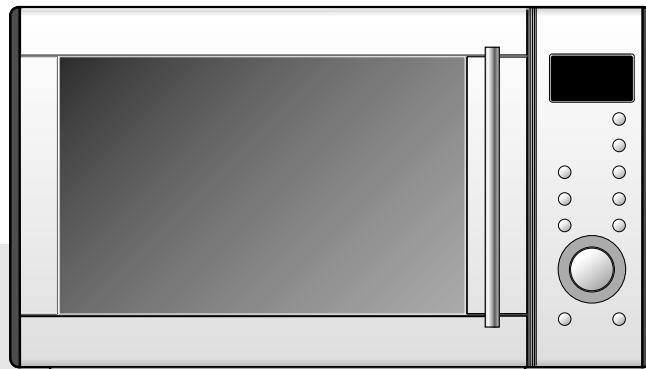

1.0 cu.ft Microwave Oven Convection

KOC-924T9N

Instruction Manual
and Cooking Guide



Before operating this oven, please read these instructions completely.

PRECAUTIONS TO AVOID POSSIBLE EXPOSURE TO EXCESSIVE MICROWAVE ENERGY

- (a) **Do not attempt to operate this oven with the door open** since open-door operation can result in harmful exposure to microwave energy. It is important not to defeat or tamper with the safety interlocks.
- (b) **Do not place any object** between the oven front face and the door or allow soil or cleaner residue to accumulate on sealing surfaces.
- (c) **Do not operate the oven if it is damaged.** It is particularly important that the oven door close properly and that there is no damage to the: (1) door (bent), (2) hinges and latches (broken or loosened), (3) door seals and sealing surfaces.
- (d) The oven should not be adjusted or repaired by anyone except properly qualified service personnel.

TABLE OF CONTENTS

PRECAUTIONS TO AVOID POSSIBLE EXPOSURE TO EXCESSIVE MICROWAVE ENERGY	1
TABLE OF CONTENTS	1
IMPORTANT SAFETY INSTRUCTION	2
FEDERAL COMMUNICATIONS COMMISSION RADIO FREQUENCY	3
GROUNDING INSTRUCTIONS	3
INSTALLATION	4
SPECIFICATIONS	5
FEATURES DIAGRAM	6~7
ACCESSORIES	8
BEFORE OPERATION	9
SETTING THE CLOCK	9
CHILD LOCK AND POWER SAVE MODE	10
OPERATION	11
MICROWAVE COOKING - Microwave Usage	11
GRILL COOKING - No Microwaves	12
CONVECTION COOKING(with pre-heat) - No Microwaves	13
CONVECTION COOKING(traditional cooking)-No Microwaves	14
COMBINATION COOKING	15
WEIGHT DEFROST - Microwave Usage	16
TIME DEFROST - Microwave Usage	16
AUTO COOK - Microwave Usage	17
SPEEDY COOK	19
TO STOP THE OVEN WHILE THE OVEN IS OPERATING	19
ABNORMAL MESSAGES	19
GENERAL GUIDE LINES	20
COOKING INSTRUCTION	21
COOKING UTENSILS	21
MICROWAVE PRINCIPLES	22
HOW MICROWAVE COOK FOOD	22
COOKING TECHNIQUES	23
DEFROSTING GUIDE	24
DEFROSTING CHART	25
COOKING CHART	26
REHEATING CHART	30
CARE OF YOUR MICROWAVE OVEN	31
USE YOUR MICROWAVE OVEN SAFELY	32
BEFORE YOU CALL FOR SERVICE	33
QUESTIONS AND ANSWERS	34

IMPORTANT SAFETY INSTRUCTIONS

When using electrical appliances, basic safety precautions should be followed, including the following:

WARNING - To reduce the risk of burns, electric shock, fire, injury to persons or exposure to excessive microwave energy:

1. Read all instructions before using the appliance.
2. Read and follow the specific "PRECAUTIONS TO AVOID POSSIBLE EXPOSURE TO EXCESSIVE MICROWAVE ENERGY" found on page 1.
3. This appliance must be grounded. Connect only to properly grounded outlet.
See "GROUNDING INSTRUCTIONS" found on page 3.
4. Install or locate this appliance only in accordance with the provided installation instructions.
5. Some products such as whole eggs and sealed containers - for example, closed glass jars-are able to explode and should not be heated in this oven.
6. Use this appliance only for its intended use as described in this manual. Do not use corrosive chemicals or vapors in this appliance. This type of oven is specifically designed to heat, cook, or dry food. It is not designed for industrial or laboratory use.
7. As with any appliance, close supervision is necessary when used by children.
8. Do not operate this appliance if it has a damaged cord or plug, if it is not working properly, or if it has been damaged or dropped.
9. This appliance should be serviced only by qualified service personnel.
Contact nearest authorized service facility for examination, repair or adjustment.
10. Do not cover or block any openings on the appliance.
11. Do not store this appliance outdoors. Do not use this product near water — for example, near a kitchen sink, in a wet basement, or near a swimming pool, or similar locations.
12. Do not immerse cord or plug in water.
13. Keep cord away from heated surfaces.
14. Do not let cord hang over edge of table or counter.
15. Either:
 - a) When cleaning surfaces of door and oven that comes together on closing the door, use only mild, non-abrasive soaps or detergents applied with a sponge or soft cloth , or
 - b) When separate cleaning instructions are provided, See door surface cleaning instructions on.
16. To reduce the risk of fire in the oven cavity:
 - a) Do not overcook food. Carefully attend appliance when paper, plastic, or other com-bustible materials are placed inside the oven to facilitate cooking.
 - b) Remove wire twist-ties from paper or plastic bags before placing bag in oven.
 - c) If materials inside the oven ignite, keep oven door closed, turn oven off, and disconnect the power cord, or shut off power at the fuse or circuit breaker panel.
 - d) Do not use the cavity for storage purposes. Do not leave paper products, cooking utensils, or food in the cavity when not in use.
17. Do not use this microwave oven to heat corrosive chemicals (for example, sulfides and chlorides). Vapours from such corrosive chemicals may interact with the contact and springs of the safety interlock switches thereby rendering them inoperable.
18. Keep the waveguide cover clean at all times.
Wipe the oven interior with a soft damp cloth after each use. If you leave grease or fat anywhere in the cavity it may overheat, smoke or even catch fire when next using the oven.
19. Never heat oil or fat for deep frying as you cannot control the temperature and doing so may lead to overheating and fire.
20. Liquids, such as water, coffee, or tea are able to be overheated beyond the boiling point without appearing to be boiling due to surface tension of the liquid. Visible bubbling or boiling when the container is removed from the microwave oven is not always present. **THIS COULD RESULT IN VERY HOT LIQUIDS SUDDENLY BOILING OVER WHEN A SPOON OR OTHER UTENSIL IS INSERTED INTO THE LIQUID.** To reduce the risk of injury to persons:
 - ① Do not overheat the liquid.
 - ② Stir the liquid both before and halfway through heating it
 - ③ Do not use straight-sided containers with narrow necks.
 - ④ After heating, allow the container to stand in the microwave oven for a short time before removing the container.
 - ⑤ Use extreme care when inserting a spoon or other utensil into the container.

Prior to use(If your oven has a grill element)

In order to protect your oven during transportation and storage, the grill element is covered with a protective coating. To remove this coating the grill element must be heated for 5 minutes. This procedure will produce some bad odors as the protective coating on the element disappears.

SAVE THESE INSTRUCTIONS

FEDERAL COMMUNICATIONS COMMISSION RADIO FREQUENCY INTERFERENCE STATEMENT

WARNING:

This equipment generates and uses ISM frequency energy and if not installed and used properly, that is in strict accordance with the manufacturer's instructions, may cause interference to radio and television reception.

It has been type-tested and found to comply with limits for an ISM Equipment pursuant to part 18 of FCC Rules, which are designed to provide reasonable protection against such interference in a residential installation.

However, there is no guarantee that interference will not occur in a particular installation.

If this equipment does cause interference to radio or television reception, which can be determined by turning the equipment off and on, the user is encouraged to try to correct the interference by one or more of the followings.

- Reorient the receiving antenna of radio or television.
- Relocate the Microwave oven with respect to the receiver.
- Move the microwave oven away from the receiver.
- Plug the microwave oven into a different outlet so that microwave oven and receiver are on different branch circuits.

THE MANUFACTURER is not responsible for any radio or TV interference caused by UNAUTHORIZED MODIFICATION to this microwave oven. It is the responsibility of the user to correct such interference.

GROUNDING INSTRUCTIONS

This appliance must be grounded. In the event of an electrical short circuit, the grounding plug reduces the risk of electric shock by providing an escape wire for electric current. This appliance is equipped with a cord having a grounding wire with a grounding plug. The plug must be plugged into an outlet that is properly installed and grounded.

WARNING:

Improper use of the grounding can result in a risk of electric shock.

Consult a qualified electrician or serviceman if the grounding instructions are not completely understood, or if doubt exists as to whether the appliance is properly grounded, and either :

- (1) If it is necessary to use an extension cord, use only a 3-wire extension cord that has a 3-blade grounding plug, and a 3-slot receptacle that will accept the plug on the appliance. The marked rating of the extension cord shall be equal to or greater than the electrical rating of the appliance.
or
- (2) Do not use an extension cord, if the power supply cord is too short, have a qualified electrician or serviceman install an outlet near the appliance.

WARNING:

Do not cut or remove the third (ground) prong from the power cord under any circumstances.

INSTALLATION

- 1 Examine the oven after unpacking.**

Check for damage such as a misaligned door, broken door or dent in the cavity. If any damage is visible, DO NOT INSTALL, and notify your dealer immediately.
- 2 Level, flat location.**

Install the microwave oven on a level, flat surface and more than 3ft(914mm) above the floor.
- 3 Ventilation.**

Do not block air vents. If they are blocked during operation, the oven may overheat and eventually cause a failure. For proper ventilation, allow 4 inches of space between oven top, sides, rear and adjacent surfaces.
- 4 Away from radio and TV sets.**

Poor television reception and radio interference may result if the oven is located close to a TV, radio, antenna, feeder, etc. Place the oven as far from them as possible.
- 5 Away from heating appliances and water taps.**

Keep the oven away from heat, steam or splashing liquids. These things can adversely affect oven wiring and contacts.
- 6 Power supply.**

This microwave oven requires a power supply of approximately 13 Amperes, 120 Volts, 60Hz and a grounded outlet. A short power cord is provided to reduce the risk of the user becoming entangled in or tripping over a longer cord. Longer cord sets or extension cords are available and may be used if care is exercised in their use.
If an extension cord is used, the marked electrical rating of the cord should be at least as great as the electrical rating of the oven.
The extension cord must be a grounding-type 3-wire cord. The longer cord should be arranged so that it will not drape over the table top or counter where it can be pulled on by children or tripped over unintentionally.
- 7** The minimum height of free space necessary above the top surface of the oven is 4inches.

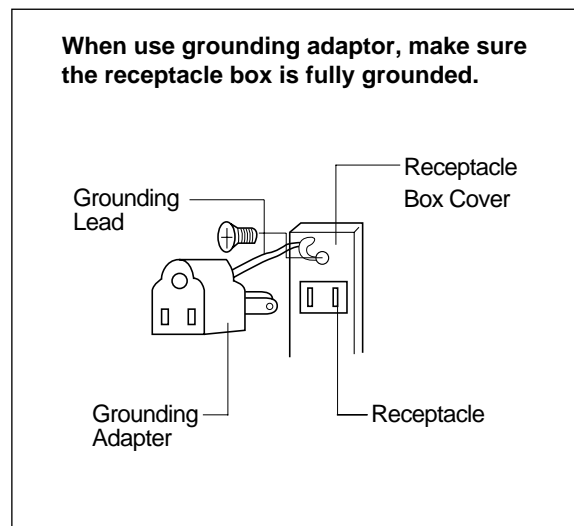
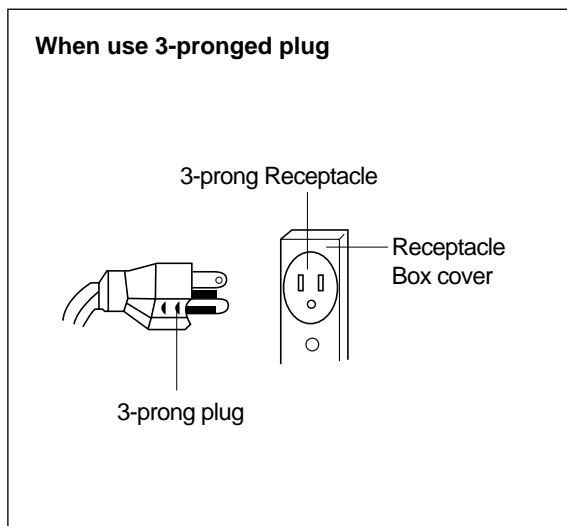

"THE CANADIAN ELECTRICAL CORD DOES NOT ALLOW THE USE OF THE GROUNDING ADAPTOR"

SPECIFICATIONS

POWER SUPPLY		120V AC 60 Hz SINGLE PHASE WITH GROUNDING
MICROWAVE	POWER CONSUMPTION	1500W
	OUTPUT POWER	1000W
	FREQUENCY	2450 MHZ
GRILL POWER CONSUMPTION		850W
CONVECTION POWR CONSUMPTION		1450W
COMBINATION HEATING POWER CONSUMPTION		1500W
OUTSIDE DIMENSIONS (WXHxD)		542 x 329 x 515 mm (21.3 x 13.0 x 20.3 in.)
CAVITY DIMENSIONS (WXHxD)		350 x 230 x 355 mm (13.8 x 9.1 x 14.0 in.)
NET WEIGHT		APPROX. 20 Kg (44.1 lbs.)
TIMER		60 min.
POWER SELECTIONS		10 LEVELS

** Specifications are subject to change without notice.*

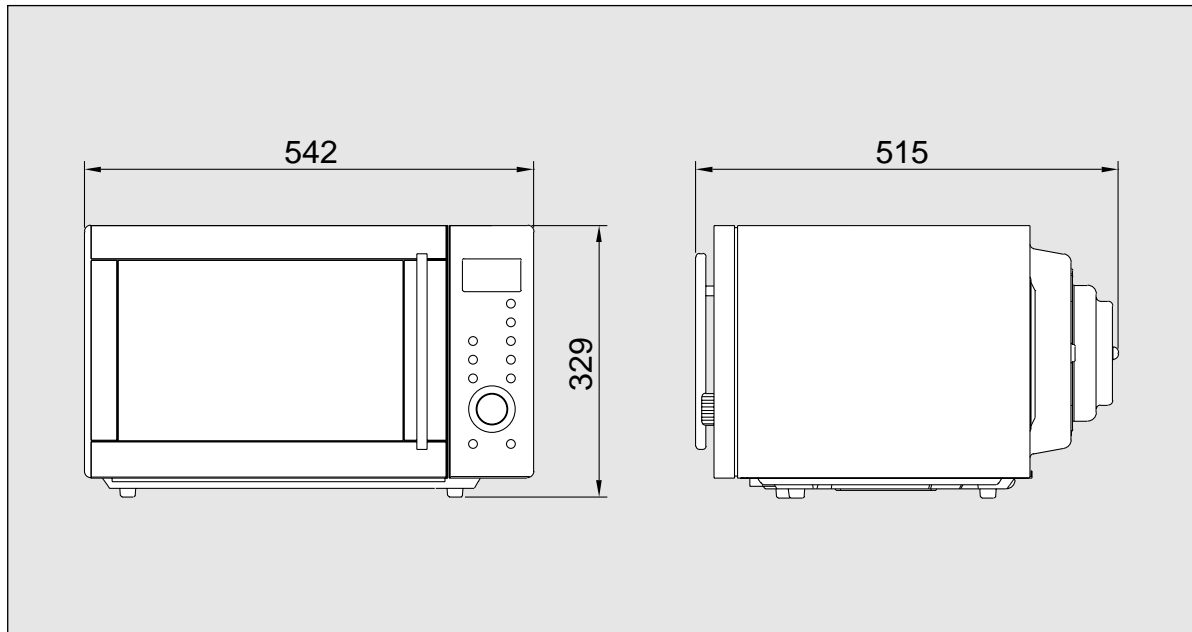

FEATURES DIAGRAM

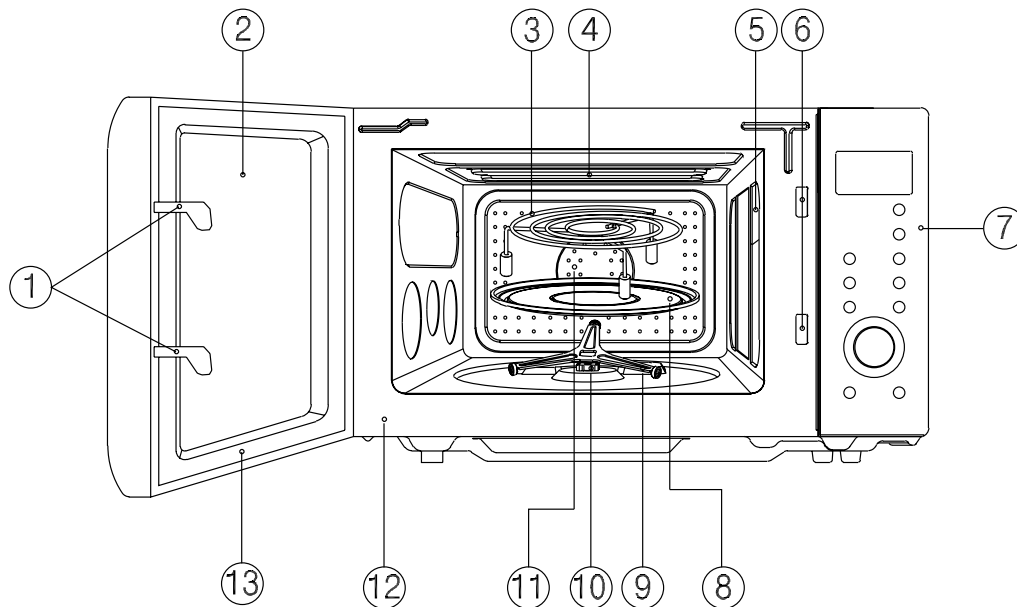

- ① **DOOR HOOK** - When the door is closed, it will automatically lock shut. If door is opened while oven is operating, the magnetron will immediately stop operating.
- ② **DOOR VIEWING SCREEN** - Allows viewing of food. The screen is designed so that light can pass through, but not the microwave.
- ③ **METAL RACK**
- ④ **TOP HEATER** - Turns on when convection, grill and combi cooking is selected.
- ⑤ **OVEN LAMP** - Automatically turns on during oven operating.
- ⑥ **SAFETY INTERLOCK SYSTEM**
- ⑦ **CONTROL PANEL**
- ⑧ **TURNTABLE TRAY** - Rotates during cooking and ensure even distribution of Microwaves. It can also be used as a cooking utensil.
- ⑨ **ROLLER GUIDE** - This must always be used for cooking together with the turntable tray.
- ⑩ **COUPLER** - This fits over the shaft in the center of the ovens cavity floor. This is to remain in the oven for all cooking.
- ⑪ **CONVECTION OUTLET & FAN**
- ⑫ **OVEN FRONT PLATE**
- ⑬ **DOOR SEAL** - Door seal maintains the microwave energy within the oven cavity and prevents microwave leakage.

FEATURES DIAGRAM (continued)

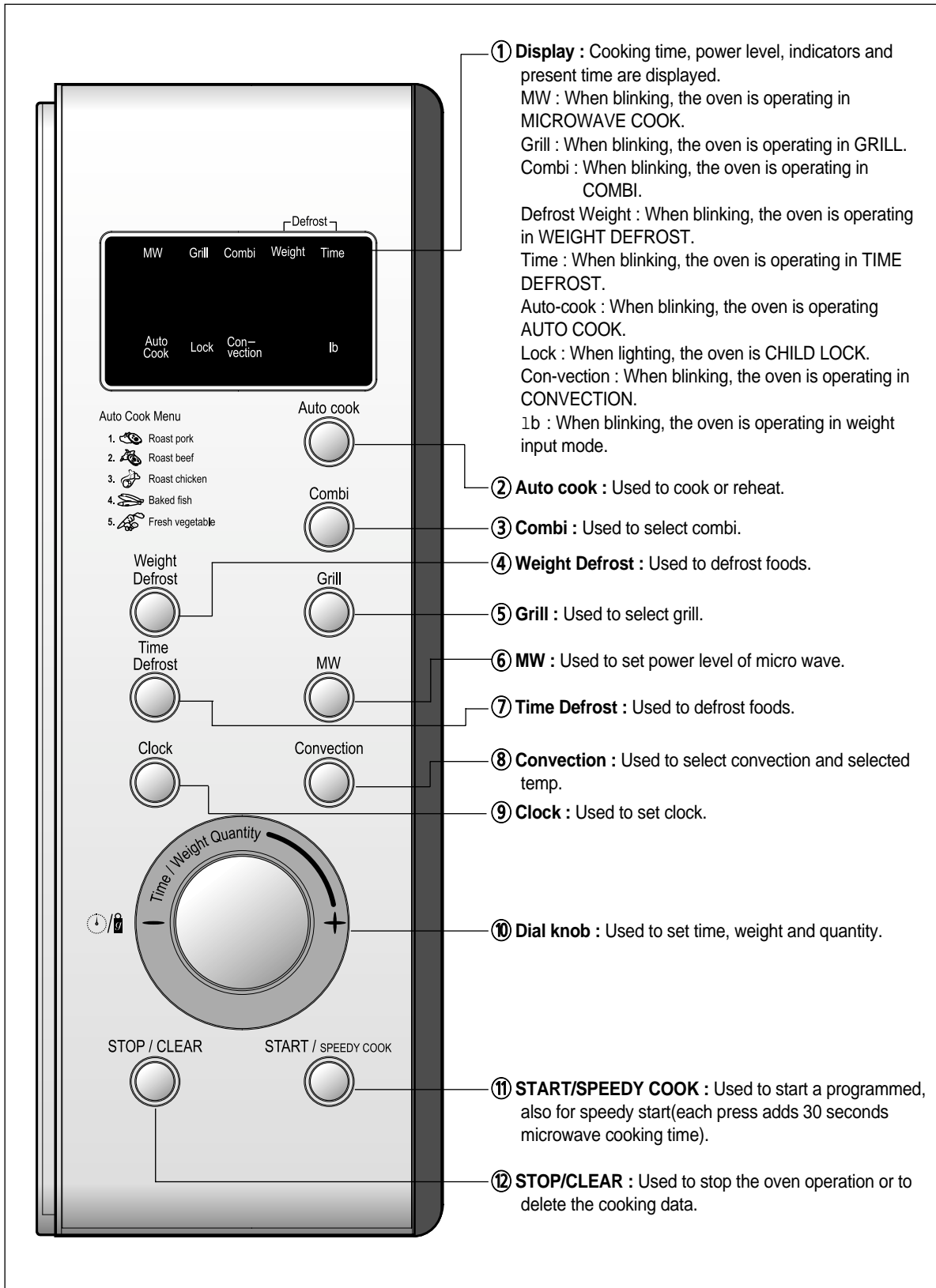

ACCESSORIES

This oven comes equipped with several accessories. They can be used in various ways to facilitate cooking.

■ Rotating base

This fits over the shaft in the center of the oven's cavity floor.

This to remain in the oven for all cooking. It should only be removed for cleaning.

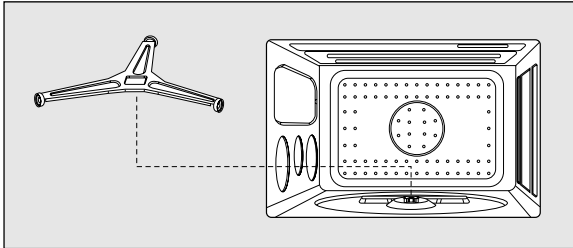

Important:

The rotating base must be placed in the center of the oven's cavity and fitted in the rotating shaft exactly.

In case the rotating base does not fit in the rotating shaft, the rotating base might become as tray and sparks can occur.

■ Turntable tray or turntable

This metal tray fits over the rotating base and locks into place.

This is to be used in the oven for all cooking. It rotates clockwise or counterclockwise during cooking. It is easily removable for cooking and cleaning needs.

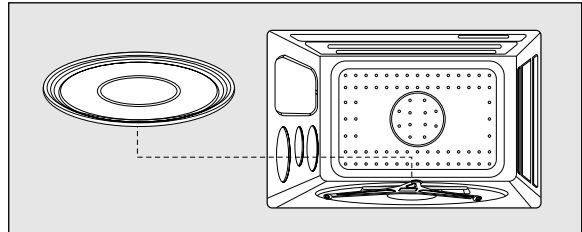

■ Metal rack

This metal rack is used with the turntable tray.

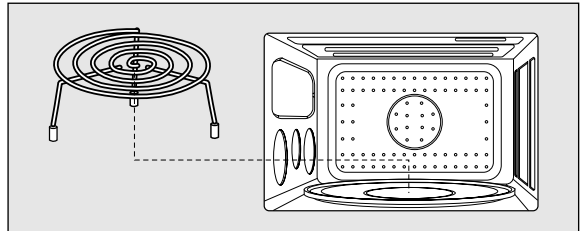

■ HOW TO USE THE ACCESSORIES OF COOKING

■ Turntable

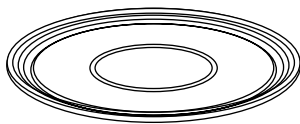

- Microwave cooking
- Convection cooking
- Combination cooking
- Auto cooking

■ Metal rack

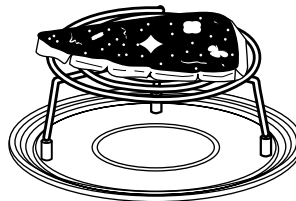

- Grill cooking
- Auto cooking(1, 2, 3, 4)
- No convection cooking

BEFORE OPERATION

SETTING THE CLOCK

When your oven is plugged in, the display will flash " :0" and a tone will sound. If the AC power ever goes off, the display shows " :0" when the power comes back on.

Your oven has multiple(12hr/24hr) clock system. To set the clock follow under procedure.

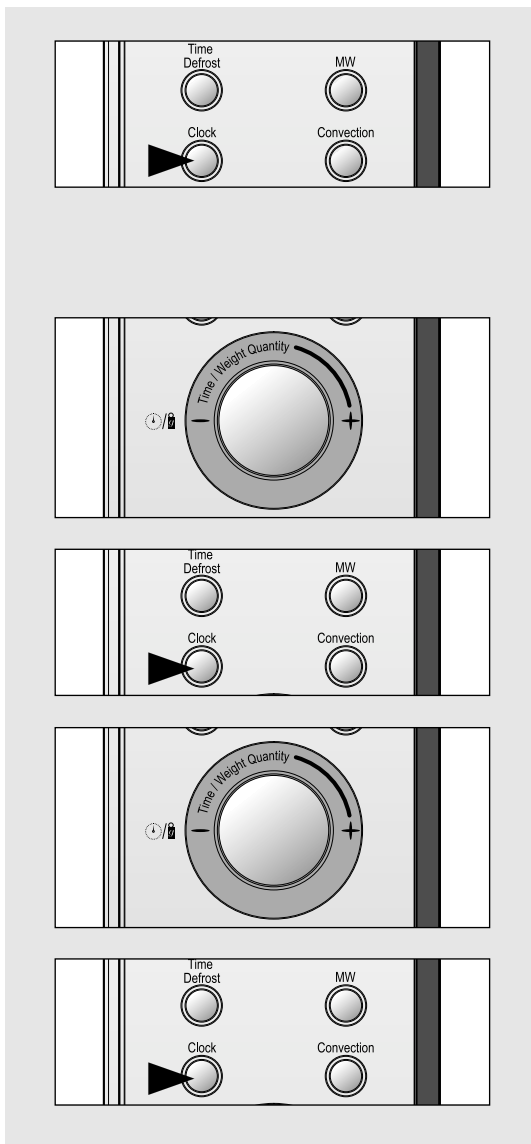

Example : To set 5:30

1. Press **Clock** button once. (example : to set " 5:30 ")
The display will be " 12H " shows.
2. Press **Clock** button once more, " 24H " shows in display.
This is a 24hour clock system. If you want 12hour clock system, omit this step.
3. Turn the **dial knob** to set the hour number " 5: ".
The hour number starts blinking, the colon will right.
4. Press **Clock** button. " 5:00 " shows in display.
The minute number starts blinking, the colon and hour number will light.
5. Turn the **dial knob** until " 5:30 " in the display window.
6. Press **Clock** button. The colon starts blinking.
If you selected 12hour clock system, this digital clock allows you to set from **1:00** to **12:59**.
If you selected 24hour clock system, this digital clock allows you to set from **0:00** to **23:59**.

CHILD LOCK AND POWER SAVE MODE

Child lock : The child lock prevents the oven from being used. For example because children could hurt themselves on hot liquids etc.

Power save mode : This function is used for saving energy.

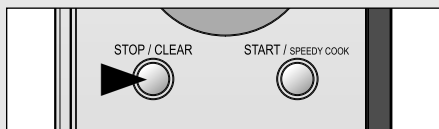

To set child lock

1. Press STOP/CLEAR button.
": 0" or clock appears in the display.
2. Press and then hold STOP/CLEAR button for 3 seconds.
The oven will lock indicator lights.
Now the oven cannot be operated.
3. To cancel child lock simply repeat procedure 2.
The oven will beep and lock indicator disappears.
The oven is again available for normal use.

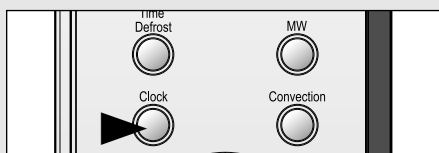
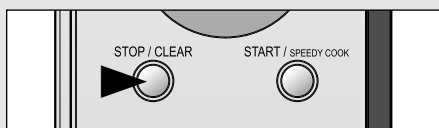

To set power save mode

1. Press STOP/CLEAR button.
": 0" or clock appears in the display.
2. Press and then hold Clock button for 3 seconds.
The display will turn off and a beep sounds.
To operate the oven in power save mode, press any key or turn the knob.
Then " :0" or clock will be shown and the operation of all function key will be same as in the normal mode.
But if there is no operation within 10 seconds in clear mode or while manipulating the key, all the contents of display will disappear.
3. To cancel power save simply repeat setting procedure.
When the display is on.
The power save mode will be canceled and a beep sounds.
The oven is again available for normal use.

OPERATION

Tips : Also remember to read this operating instruction for proper safety information and instruction before using the oven. Prior to setting the controls, place one cup of water in the oven, on a heat-proof glass measuring cup, for testing purposes.

Note : When the cooking time has elapsed the oven beeps three times, " : 0" or clock appears in the display, the rotating plate stops turning and the oven light turns off. The oven will continue to beep every 1 minute until the **STOP/CLEAR** button is pressed, or the door is opened.

The cooling fan continues to run for 5 minutes after cooking has stopped when it takes over 3 minutes for cooking.(the display will show "**COOL**" and " :0 or clock") Opening the door during cooking will cause the oven to shut off and the cooking process and any displayed countdown to pause. When the **START/SPEEDY COOK** button is pressed, the cooking countdown will resume. When the **STOP/CLEAR** button is pressed, the cooking is canceled. The oven displays the set cooking time in 10 seconds steps(up to 5 minutes cooking time), in 30 seconds steps(up to 10 minutes cooking time), in 1 minutes steps(up to 60 minutes cooking time).

MICROWAVE COOKING - Microwave Usage

This MICROWAVE COOKING method allows you to cook food for a desired time. In addition to the maximum power level(100%), you can select different microwave power from 9 other levels, 10% to 90% for the foods that require slower cooking. If you have used the appliance for grilling, convection or combination cooking, let the oven cool down before using again. Never switch the microwave oven on when it is empty.

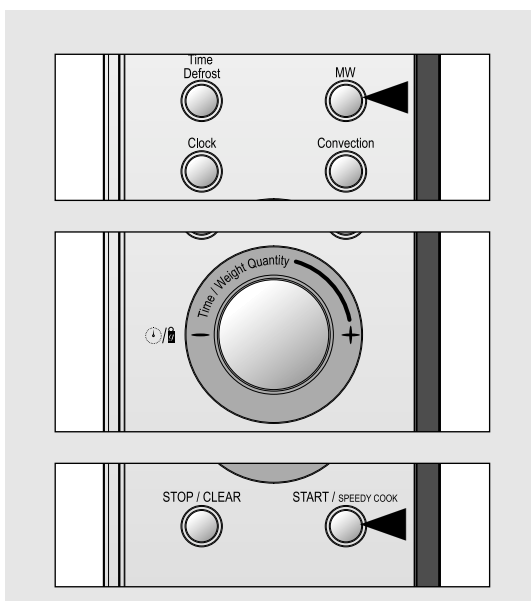

1. Press **MW** button once. **MW** indicator lights. " **P-HI** " shows in display.
2. Select the appropriate power level by pressing the **MW** button again until the corresponding percentage is displayed. Refer to the power level table below for further details.
3. Turn the **dial knob** to set the cooking time. For a cooking time of 5 minutes 30 seconds, turn the **dial knob** to the right to set 5:30. (up to 60 minutes) " **5:30** " shows in display.
4. Press **START/SPEEDY COOK** button. The oven light comes on and the turntable starts rotating. Cooking starts and the time in the display will count down.

Note : The oven will automatically work on 100% microwave power if a cooking time is entered without the power level previously being selected. You can check the power level while cooking is in progress by pressing the **MW** button. The display will show the current power level for 3 seconds.

Power level table

Power level	percentage	Output	Power level	percentage	Output
P-HI	100%	1000W	P-50	50%	500W
P-90	90%	900W	P-40	40%	400W
P-80	80%	800W	P-30	30%	300W
P-70	70%	700W	P-20	20%	200W
P-60	60%	600W	P-10	10%	100W
			P-00	0%	0W

GRILL COOKING - No Microwaves

The grill enables you to heat and brown food quickly, without using microwaves.

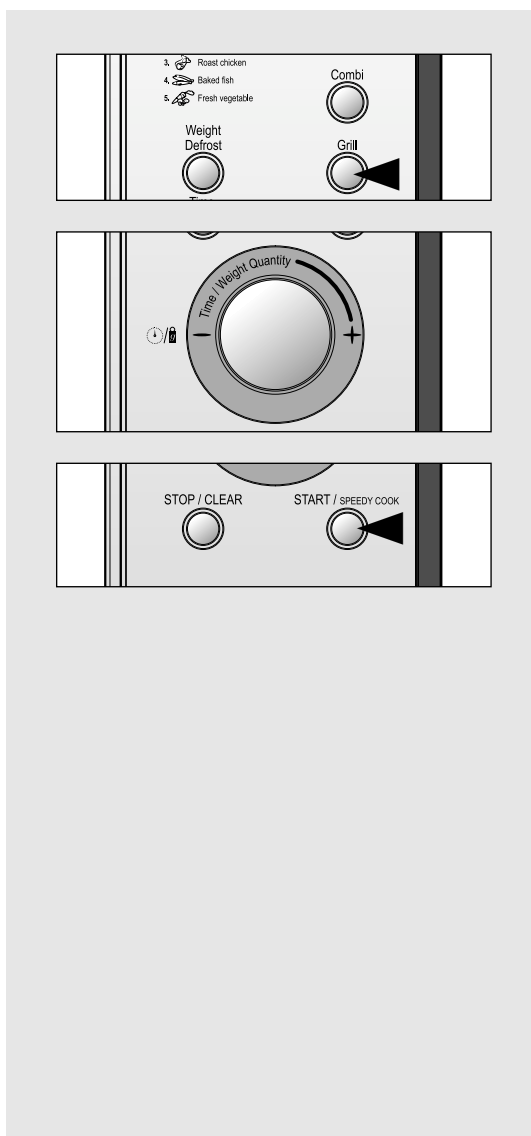

1. Press **Grill** button once. **GRILL**(upper grill) indicator lights.

2. Turn the **dial knob** to set the grilling time.
For a grilling time of 11 minutes, turn the **dial knob** to the right to set 11:00. (up to 60 minutes)
"11:00" shows in display.

3. Press **START/SPEEDY COOK** button.
The oven light comes on and the turntable starts rotating.
Cooking starts and the time in the display will count down.

Note :
The heating element is located in the top of the oven.

Note : When first using the grill heaters, smoke and odour will be given off. To avoid this happening when food is being cooked, heat the upper and lower grills without food for approximately 10 minutes.
Place food directly on the rack, in a flan dish or on a heat resistant plate on the rack.

WARNING :
The temperature inside the oven and window is very high. Do not touch the oven window and metallic interior of the oven when taking food in and out.
Use thick oven gloves while handling food or accessories.

Suggested use	Cookware
This method is ideal for toasting bread or muffins. Remember the oven will be hot. Place all food on metal rack.	Use oven-proof cookware. As there is no microwave energy being used you can place metal tins directly onto the metal rack with no

CONVECTION COOKING(with pre-heat) - No Microwaves

For convection cooking, it is recommended that you preheat the oven to the appropriate temperature before placing the food in the oven.

The maximum preheating time is 30 minutes. If the cooking is not started immediately after preheating, the convection indicator will continue to flash and the preheated oven temperature will be displayed.

It is maintained for 15 minutes; it is then switched off automatically.

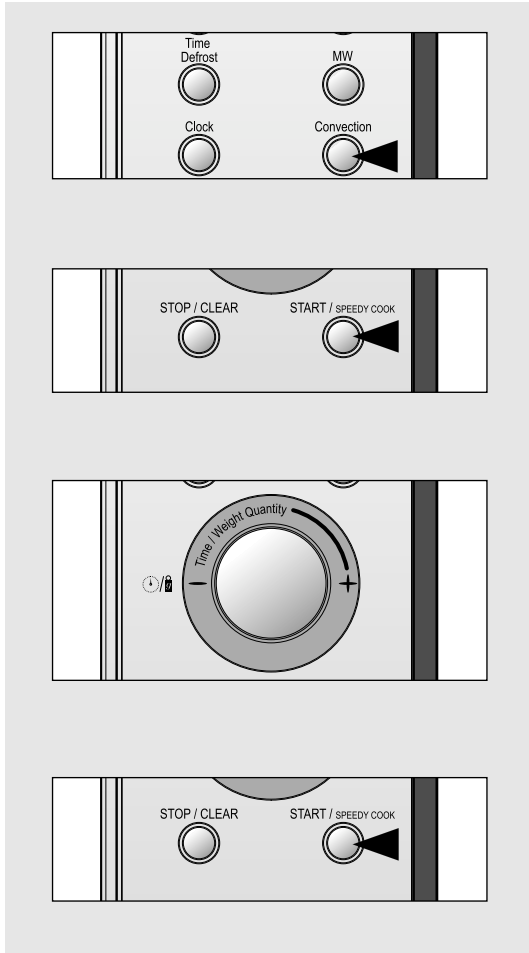

1. Press **Convection** button once. **CONVECTION** indicator lights. **"230F"** shows in display.

2. Select the convection cooking temperature by pressing the **Convection** button again until the corresponding temperature is displayed.

Temperature sequence
230F → 250F → 265F → 285F → 300F → 320F →
340F → 355F → 375F → 390F → 410F → 430F →
445F → 465F → 480F

3. Press **START/SPEEDY COOK** button. **CONVECTION** indicator blinks.

Temperature of preheating and **"PrE-"** blink alternatively in the display.

The oven will now preheat. When oven is preheated the oven will beep and the preheated oven temperature will appear in the display.

Then open the door and place your food in the oven. Oven temperature and shows in display.

4. Turn the **dial knob** to set the cooking time.

For a cooking time of 11 minutes, turn the **dial knob** to the right to set 11:00.(up to 60 minutes)

"11:00" shows in display.

5. Press **START/SPEEDY COOK** button.

The oven light comes on and the turntable starts rotating. Cooking starts and the time in the display will count down.

CONVECTION COOKING(traditional cooking)-No Microwaves

The convection mode enables you to cook food in the same way as in a traditional oven. Microwaves are not used.

Always use oven gloves when touching the recipients in the oven, as they will be very hot.

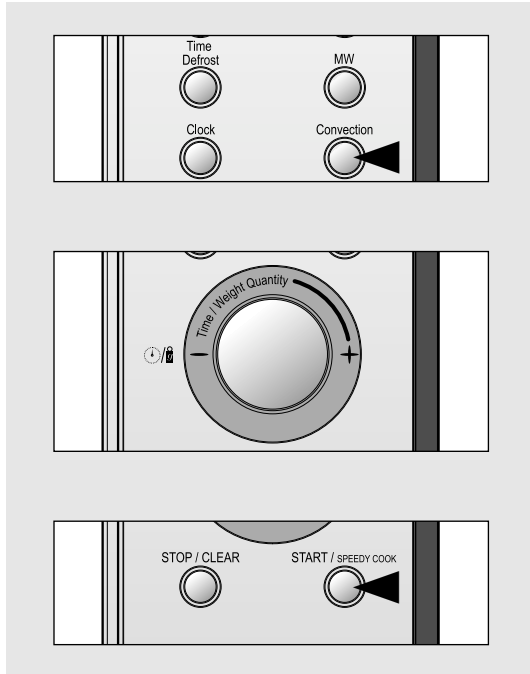

1. Press **Convection** button once. **CONVECTION** indicator lights. "230F" shows in display.
2. Select the convection cooking temperature by pressing the **Convection** button again until the corresponding temperature is displayed.

Temperature sequence
230F → 250F → 265F → 285F → 300F → 320F → 340F → 355F → 375F → 390F → 410F → 430F → 445F → 465F → 480F

3. Turn the **dial knob** to set the cooking time. For a cooking time of 11 minutes, turn the **dial knob** to the right to set 11:00.(up to 60 minutes) "11:00" shows in display.
4. Press **START/SPEEDY COOK** button. The oven light comes on and the turntable starts rotating. Cooking starts and the time in the display will count down.

Note: You can check the setting temperature while cooking is in progress by pressing the **Convection** button.

Suggested use	Cookware
<p>This function is ideal for cooking meringues, cookies, biscuits, scones, bread, puddings, large fruit cakes and all pastries. Remember the oven will be hot. Place all food on metal tray.</p>	<p>Use oven-proof cookware. As there is no microwave energy being used you can place metal tins directly onto the metal tray with no danger of arcing.</p>

COMBINATION COOKING (Microwave + Convection + Upper Grill)

This function allows you to combine convection operation with microwave to produce traditional baked or roasted results in less time.

Always use microwave-safe and oven-proof cookware. Glass or ceramic dishes are ideal as they allow the microwaves to penetrate the food evenly.

Always use oven gloves when touching the recipients in the oven, as they will be very hot.

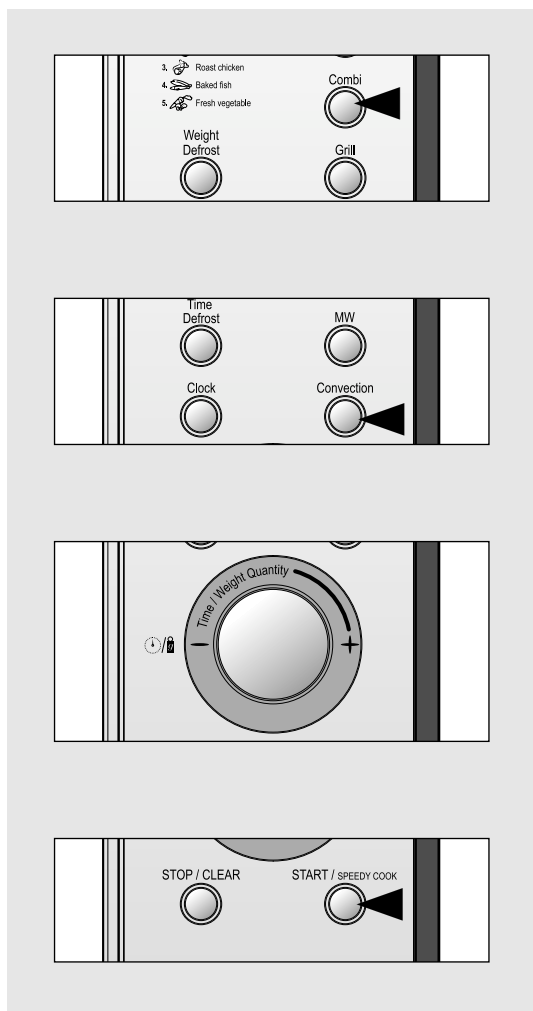

1. Press **Combi** button once.

COMBI indicator light and "C-0" will show in the display.

2. Press **Convection** button once.

"230F" shows in display.

Select the convection cooking temperature by pressing the Convection button again until the corresponding temperature is displayed.

Temperature sequence
230F → 250F → 265F → 285F → 300F → 320F →
340F → 355F → 375F → 390F → 410F → 430F →
445F → 465F → 480F

3. Turn the **dial knob** to set the cooking time.

For a cooking time of 11 minutes, turn the **dial knob** to the right to set 11:00. (up to 60 minutes)

"11:00" shows in display.

4. Press **START/SPEEDY COOK** button.

The oven light comes on and the turntable starts rotating. Cooking starts and the time in the display will count down.

Note: You can check the cooking temperature while cooking is in progress by pressing the **Convection** button.

The display will show the cooking temperature for 3 seconds.

In sequential operation mode, only "C-0" can be selected.

WEIGHT DEFROST - Microwave Usage

Weight Defrost automatically sets the defrosting times and power levels to give even defrosting results for frozen food. During the defrosting process the oven will beep to remind you to check the food. The oven will beep, open the door, turn the frozen food over and close the door, press the **START/SPEEDY COOK** button.

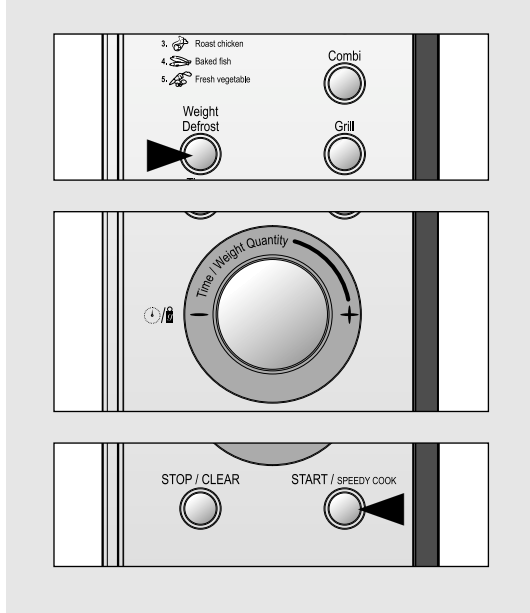

1. Press **Weight Defrost** button once. The **Weight-Defrost** indicator lights an “ : 0.0 ” is displayed. The “ 1b ” indicator blinks.

2. Turn the **dial knob** to set the weight.
Weight can be set up from 0.5lb to 6.5lb .

The weight will change in 0.5lb increments or decrements.

For a defrosting weight of 2lb, turn the **dial knob** to the right to set 2.0. "2.0 "shows in display.

3. Press **START/SPEEDY COOK** button.
The oven light comes on and the turntable starts rotating.

Note : WEIGHT DEFROSTING beging. The defrosting time is determined by the weight entered.

TIME DEFROST - Microwave Usage

During the defrosting process the oven will beep to remind you to check the food. The oven will beep, open the door, turn the frozen food over and close the door, press the **START/SPEEDY COOK** button.

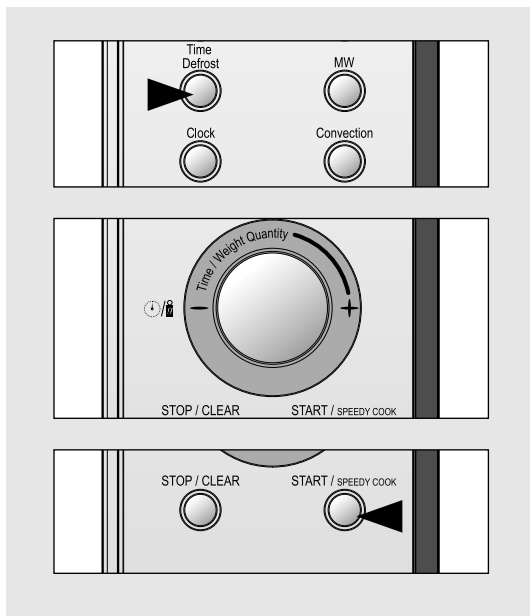

1. Press **Time Defrost** button once. The **Time-Defrost** indicator lights and “ : 0 ” is displayed.

2. Turn the **dial knob** to set the defrosting time.
For a time of 11 minutes, turn the **dial knob** to the right to set 11:00.(up to 60 minutes)
"11:00 "shows in display.

3. Press **START/SPEEDY COOK** button.
The oven light comes on and the turntable starts rotating.
Cooking starts and the time in the display will count down.

AUTO COOK - Microwave Usage

This function allows you to simply and automatically cook a range of popular foods. Always use oven gloves when touching the recipients in the oven.

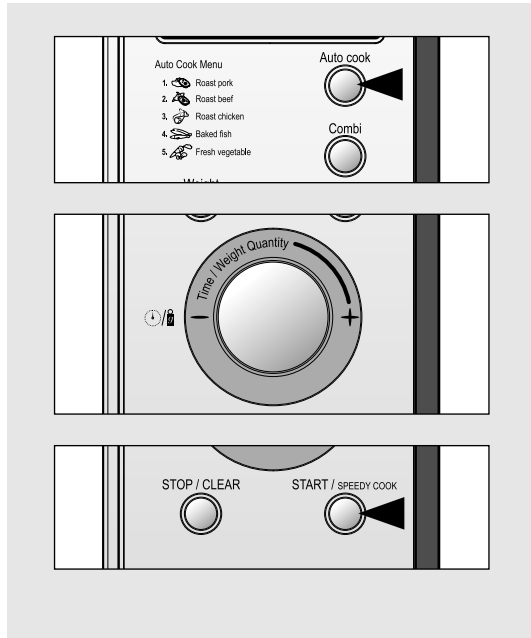

1. Press **Auto Cook** button once.
Auto Cook indicator light.
"AC-1 " will show in the display.
2. Select the menu by pressing the **Auto Cook** button until the required menu is displayed.
Refer to the auto cook menu chart below for further details.
3. Turn the **dial knob** to set the cooking weight.
For a cooking weight of 2lb, turn the **dial knob** to the Right to set 2lb.(up to 4.0lb)
"2.0" shows in display. "1b" shows in display.
Refer to the auto cook menu chart below for further details.
4. Press **START/SPEEDY COOK** button.
The oven light comes on and the turntable starts rotating.

Note : You can check the setting cooking menu while the cooking is in progress by pressing the **Auto Cook** button.

Auto Cook Menu Chart

Press auto cook key	Auto Cook Menu	Minimum Weight	Maximum Weight	Weight Step
Once	ROAST PORK	1 lb	4 lb	0.2 lb
Twice	ROAST BEEF	1 lb	4 lb	0.2 lb
3 times	ROAST CHICKEN	1.6 lb	6 lb	0.2 lb
4 times	BAKED FISH	0.6 lb	2 lb	0.2 lb
5 times	FRESH VEGETABLE	0.2 lb	2 lb	0.1 lb

Auto Cook Menu	Start Temp.	Method	Cookware
ROAST PORK	Chilled temp.	<ol style="list-style-type: none"> 1. Tie the joint into a neat shape. 2. Place the pork directly on the metal rack on the turntable. 3. Brush with a little oil. 4. Place roasts fat-side down a metal rack. 5. Cook on "AUTO COOK-ROAST PORK or ROAST BEEF". 6. Turn over when hearing the beep. 7. Remove from oven. Drain off any excess juices. 8. Stand for 10 minutes in foil before serving. 	Place the pork or beef directly on the metal rack on the turntable.
ROAST BEEF			
ROAST CHICKEN	Chilled temp.	<ol style="list-style-type: none"> 1. Wash and dry chicken. Tie the legs loosely together with string. 2. Pierce the skin a couple of times just under the legs. 3. Brush butter mixture all over the chicken directly on the metal rack on the turntable. 4. Place roasts breast-side down a metal rack. 5. Cook on "AUTO COOK-ROAST CHICKEN". 6. Turn over when hearing the beep. 7. Remove from oven. Drain off any excess juices. Season with salt if required. Stand for 10 minutes in foil before serving. 	Place the chicken directly on the metal rack on the turntable.
BAKED FISH	Chilled temp.	<ol style="list-style-type: none"> 1. All types of fresh fish(except battered or breadcrumbed fish) can be cooked whether whole, fillets or steaks. 2. Place the prepared fish in a buttered dish. 3. Season with salt and pepper, sprinkle with lemon juice and dot with butter. Do not cover dish. 4. Place on dish on the metal rack on the turntable. 5. Cook on "AUTO COOK- BAKED FISH". 	Micro and heat proof shallow dish. (e.g Pyrex.)
FRESH VEGETABLE	Chilled temp.	<ol style="list-style-type: none"> 1. Wash and trim. 2. Place prepared vegetables into a suitable sized container. 3. Sprinkle with 4-5 tbs. of water. 4. Cover with pierced cling film or a lid. 5. Place on dish on the turntable. 6. Cook on "AUTO COOK- FRESH VEGETABLE. <p>* For best results cut vegetables into similar sized pieces.</p>	Microproof dish. (e.g Pyrex.)

SPEEDY COOK

The speedy cook function allows the oven to be cooking immediately on full power. The speedy cook button has been pre-programmed to increase in increments of 30 seconds up to a maximum time of 5 minutes.

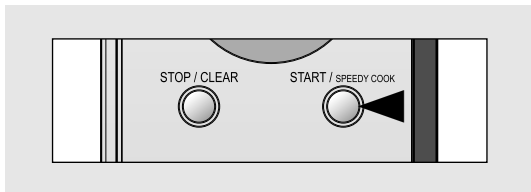

1. Press **START/SPEEDY COOK** button.

The oven will be " : 30" is displayed. MW indicator lights. And the oven will start immediately. No need to press **START/SPEEDY COOK** button. The oven light comes on and the turn table starts rotating and the time in the display will count down in seconds.

TO STOP THE OVEN WHILE THE OVEN IS OPERATING

1. Open the door.
 - Oven stops operating.
 - You can restart the oven by closing the door and touching **START/SPEEDY COOK** button.
2. Press the **STOP/CLEAR** button.
 - Oven stops operating.
 - If you wish to cancel the cooking settings, press the **STOP/CLEAR** button again.

ABNORMAL MESSAGE

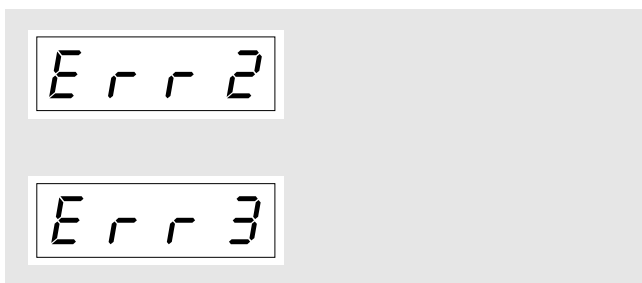

- If the inside temperature of the oven is higher than expected or the temperature sensor doesn't work properly, "Err 2" message will be shown in the display.
- Unplug the power and call our technical service.
- When the temperature sensor is disconnected, "Err 3" message will be shown in the display.
- Unplug the power and call our technical service.

GENERAL GUIDE LINES

Since microwave cooking to some extent is different from traditional cooking, the following general guidelines should be considered whenever you use your microwave oven

If the food is undercooked

Check if:

- You have selected the correct power level.
- The selected time is sufficient-the times given in the recipes are approximate. They depend on initial temperature, weight and density of the food etc.
- The container is appropriate.

If the food is overcooked,i.e. dried out or burnt

Before you cook again, consider whether:

- The power level was too high.
- The set time was too long-the times in the recipes are approximate. They depend on initial temperature, weight and density of the food etc.

Points to remember when defrosting

- The shape of the package alters the defrosting time. Shallow rectangular packets defrost more quickly than a deep block. Separate pieces as they begin to defrost; free flow slices defrost more easily.
- Shield areas of food with small pieces of foil if they start to become warm.
- When defrosting, it is better to under thaw the food slightly and allow the process to finish during the standing time.

The amount of food

The more food you want to prepare the longer it takes. A rule of thumb is that double amount of food requires almost double the time. If one potato takes four minutes to cook, approximately seven minutes are required to cook two potatoes.

Starting temperature of food

The lower the temperature of the food which is being put into the microwave oven, the longer time it takes. Food at room temperature will be reheated more quickly than food at refrigerator temperature.

Composition of the food

Food with a lot of fat and sugar will be heated faster than food containing a lot of water. fat and sugar will also reach a higher temperature than water in the cooking process.

The more dense the food, the longer it takes to heat. "Very dense" food like meat takes longer time to reheat than lighter, more porous food like sponge cakes.

Size and shape

Smaller pieces of food will cook more quickly than larger pieces and uniform pieces of food cook more evenly than irregularly shaped foods.

With unevenly shaped food, the thinner parts will cook faster than the thicker areas. Place the thinner chicken wings and legs to the centre of the dish.

Stirring, turning of foods

Stirring and turning of foods are techniques used in conventional and well as in microwave cooking to distribute the heat quickly to the centre of the dish and avoid over-cooking at the outer edges of the food.

Covering food helps:

- To reduce spattering
- To shorten cooking times
- To retain food moisture

All covering, which will allow microwaves to pass through are suitable-See above "Which utensils can be used in the oven?"

Releasing pressure in foods

Several foods are tightly covered by a skin or membrane. These foods should be pricked with a fork or cocktail stick to release the pressure and to prevent bursting, as steam builds up within them during cooking. This applies to potatoes, chicken livers, sausages, egg yolks and some fruits.

Standing time

Always allow the food to stand for some time after using the oven. standing time after defrosting, cooking/reheating always improves the result since the temperature will then be evenly distributed through out the food.

In a microwave oven foods continue to cook even when the microwave energy is turned off. They are no longer cooking by microwaves, but they are still being cooked by the conduction of the high residual heat to the centre of the food.

The length of standing time depends on the volume and density of the food. Sometimes it can be as short as the time it takes you to remove the food from the oven and take it to the serving table. However, with larger, denser foods, the standing time may be as long as 10 minutes. During 'standing', the internal temperature of the food will rise by as much as 8°C and the food will finish cooking in this time.

Arranging food

This is done in several ways in microwave cooking to give more even cooking results.

If you are cooking several items of the same food such as jacket potatoes, place them in a ring pattern for uniform cooking. When cooking foods of uneven shapes or thickness, place the smaller or thinner area of the food towards the centre of the dish where it will be heated last.



Uneven foods such as fish should be arranged in the oven with the tails to the centre.

If you are saving a meal in the refrigerator or 'plating' a meal for reheating, arrange the thicker, denser foods to the outside of the plate and the thinner or less dense foods in the middle.



Place thin slices of meat on top of each other or interlace them. Thicker slices such as meat loaf and sausages have to be placed close to each other. Gravy or sauce should be reheated in a separate container.



Choose a tall, narrow container rather than a low and wide container. When reheating gravy, sauce or soup, do not fill the container more than 2/3.



When you cook or reheat whole fish, score the skin this prevents cracking.

Shield the tail and head with small pieces of foil to prevent over-cooking but ensure the foil does not touch the sides of the oven.



COOKING INSTRUCTIONS

Utensils should be checked to ensure that they are suitable for use in microwave ovens.

UTENSILS TEST

Place the utensil in question next to a glass measure filled with water, in the microwave oven. Microwave at high power for 1-2 minutes. If the water heats up, but the utensil remains cool, the utensil is microwave-safe. However if the utensil becomes warm, microwaves are being absorbed by the utensil and it should not be in the microwave oven. You probably have many items on hand in your kitchen right now that can be used as cooking equipment in your microwave oven. Read through the following checklist.

COOKING UTENSILS

Recommended Use

- **Glass and glass-ceramic bowls and Dishes** - Use for heating or cooking.
- **Microwave browning dish** - Use to brown the exterior of small items such as steaks, chops, or pancakes. Follow the directions provided with your browning dish.
- **Microwaveable plastic wrap** - Use to retain steam. Leave a small opening for some steam to escape and avoid placing it directly on the food.
- **Wax paper** - Use as a cover to prevent spattering.
- **Paper towels, and napkins** - Use for short term heating and covering; they absorb excess moisture and prevent spattering. Do not use recycled paper towels, which may contain metal and can catch fire.
- **Thermometers** - Use only those labeled "Microwave Safe" and follow all directions. Check the food in several places. Conventional thermometers may be used once the food has been removed from the oven.
- **Microwave cling film, microwave roasting bags** - Microwave cling film and bags must be vented for steam to escape, pierce in 4-5 places. Do not use plastic or metal ties as they may melt or catch fire due to electrical 'arcing'.

Limited Use

- **Aluminum foil** - Use narrow strips of foil to prevent overcooking of exposed areas. Using too much foil can damage your oven, so be careful.
- **Ceramic, porcelain, and stoneware** - Use these if they are labeled "Microwave Safe." If they are not labeled, test them to make sure they can be used safely. Never use dishes with metallic trim.
- **Plastic** - Use only if labeled "Microwave Safe." Other plastics can melt.
- **Thin plastic, paper, straw and wooden containers** - Always attend the oven closely. Look at the oven from time to time when cooking or reheating food in disposable containers of plastic, paper or other combustible material. Only use for warming food. Pay special attention as over-heating may cause a fire in your oven.

Not Recommended

- **Glass jars and bottles** - Regular glass is too thin to be used in a microwave, and can shatter.
- **Paper bags** - These are a fire hazard, except for popcorn bags that are designed for microwave use.
- **Styrofoam plates and cups** - These can melt and leave an unhealthy residue on food.
- **Plastic storage and food containers** - Containers such as margarine tubs can melt in the microwave.
- **Metal utensils** - These can damage your oven. Remove all metal before cooking.

MICROWAVING PRINCIPLES

Microwave energy has been used in this country to cook and reheat food since early experiments with RADAR in World War II. Microwaves are present in the atmosphere all the time, both naturally and manmade sources. Manmade sources include radar, radio, television, telecommunication links and car phones.

HOW MICROWAVES COOK FOOD

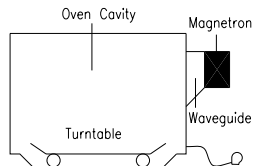

In a microwave oven, **► ABSORPTION** electricity is converted into microwave by the **MAGNETRON**.

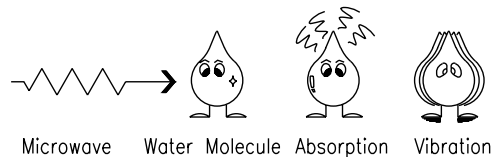

► REFLECTION

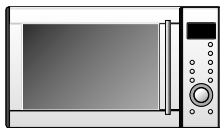

The microwaves bounce off the metal walls and the metal door screen.

► TRANSMISSION

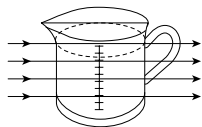

Then they pass through the cooking containers to be absorbed by the water molecules in the food, all foods contain water to a more or lesser extent.

The microwaves cause the water molecules to vibrate which causes **FRICTION**, i.e. **HEAT**. This heat then cooks the food. Microwaves are also attracted to fat and sugar particles, and foods high in these will cook more quickly. Microwaves can only penetrate to a depth of 1 1/2 - 2 inches(4-5cm) and as heat spreads through the food by conduction, just as in a traditional oven, the food cooks from the outside inwards.

WEIGHT & MEASURE CONVERSION CHART

■ POUNDS & OUNCES TO GRAMS

POUNDS(lb.)	GRAMS(g)
1/4	114
1/2	227
3/4	341
1	454
2	907
3	1361
4	1814
5	2268
6	2722
7	3175
8	3629
9	4082
10	4526
11	4990

OUNCES(oz.)	GRAMS(g)
1	28
2	57
3	85
4	113
5	142
6	170
7	198
8	227

OUNCES(oz.)	GRAMS(g)
9	255
10	284
11	312
12	340
13	369
14	397
15	425
16	454

■ FLUID MEASUREMENTS

1 Cup	= 8 fluid ounces	= 240 ml.
1 Pint	= 16 fluid ounces	= 480 ml.
1 Quart	= 32 fluid ounces	= 960 ml.
1 Gallon	= 128 fluid ounces	= 3840 ml.

■ WEIGHT DEFROST AND COOK CONVERSION CHART

Ounces	Hundredths of a Pound	Tenths of a Pound	Grams
1-2	.06-.15	0.1	50
3-4	.16-.25	0.2	100
5-6	.26-.35	0.3	150
7	.36-.45	0.4	200
8-9	.46-.55	0.5	250
10-11	.56-.65	0.6	300
12-13	.66-.75	0.7	350
14	.76-.85	0.8	400
15-16	.86-.95	0.9	450

COOKING TECHNIQUES

STANDING TIME

Dense foods e.g. meat, jacket potatoes and cakes, require standing time (inside or outside of the oven) after cooking, to allow heat to finish conducting to cook the center completely. Wrap meat joints and jacket potatoes in aluminium foil while standing. Meat joints need approx. 10-15 minutes, jacket potatoes 5 minutes. Other foods such as plated meal, vegetables, fish etc require 2-5 minutes standing. After defrosting food, standing time should also be allowed. If food is not cooked after standing time, return to the oven and cook for additional time.

MOISTURE CONTENT

Many fresh foods e.g. vegetables and fruit, vary in their moisture content throughout the season, particularly jacket potatoes. For this reason cooking times may have to be adjusted. Dry ingredients e.g. rice, pasta, can dry out during storage so cooking times may differ.

DENSITY

Porous airy foods heat more quickly than dense heavy foods.

CLING FILM

Cling film helps keep the food moist and the trapped steam assists in speeding up cooking times. Pierce before cooking to allow excess steam to escape. Always take care when removing cling film from a dish as the build-up of steam will be very hot.

SHAPE

Even shapes cook evenly. Food cooks better by microwave when in a round container rather than square.

SPACING

Foods cook more quickly and evenly if spaced apart. NEVER pile foods on top of each other.

STARTING TEMPERATURE

The colder the food, the longer it takes to heat up. Food from a fridge takes longer to reheat than food at room temperature.

LIQUIDS

All liquids must be stirred before and during heating. Water especially must be stirred before and during heating, to avoid eruption. Do not heat liquids that have previously been boiled. DO NOT OVERHEAT.

TURNING & STIRRING

Some foods require stirring during cooking. Meat and poultry should be turned after half the cooking time.

ARRANGING

Individual foods e.g. chicken portions or chops, should be placed on a dish so that the thicker parts are towards the outside.

QUANTITY

Small quantities cook faster than large quantities, also small meals will reheat more quickly than large portions.

PIERCING

The skin or membrane on some foods will cause steam to build up during cooking. These foods must be pierced or a strip of skin should be peeled off before cooking to allow the steam to escape. Eggs, potatoes, apples, sausages etc, will all need to be pierced before cooking. DO NOT ATTEMPT TO BOIL EGGS IN THEIR SHELLS.

COVERING

Cover foods with microwave cling film or a lid. Cover fish, vegetables, casseroles, soups. Do not cover cakes, sauces, jacket potatoes or pastry items.

DEFROSTING GUIDE

GENERAL INFORMATION

- ⇒ Put the food on a microwave rack (roasts, bone-in pieces) or in a microwave casserole (small pieces such as cubes or strips) or weigh at home on a kitchen scale. Round number to the nearest tenth of a pound and choose that number with each item pads.
- ⇒ The shape of food items, especially larger ones, will vary affect the way defrost. Always check the status after the standing time. Fish, seafood and poultry should still be somewhat icy in the center the held under cold running water to finish defrosting. If more time is needed, use DEFROST by time to add time in small increments.
- ⇒ Halfway through the defrosting process, a series of beeps will indicate that it is time to change the position of the item being defrosted. The includes turning over or rotating the item, separating defrosted pieces or sections, or shielding.
- ⇒ Shielding means to use a 2-inch strip of aluminum foil to protect thinner or unevenly shaped part from beginning to cook. Microwave energy will not penetrate the foil. Some rules apply to the use of foil:
 - Do not let the foil pieces touch each other or the sides of the microwave oven.
 - Be sure that all ends are touched under and lie flat to the food.
 - Remember to adjust foil when a item is turned over and cover with wax paper.
- ⇒ To prepare food for freezer storage(and later defrosting), wrap tightly in moisture proof packaging. If using freezer plastic bags, be sure to let all the air out to prevent freezer bump on the food. Package so that food is as evenly shaped as possible ease in defrosting

COMBINATION MICROWAVE OVENS:

- 1) Oversized foods or oversized metal utensils should not be inserted in a microwave oven as they may create a fire or risk of electric shock.
- 2) Do not clean with metal scouring pads. Pieces can bum off the pad and touch electrical parts involving a risk of electric shock.
- 3) Do not store any materials, other than manufacturer's recommended accessories, in this oven when not in use.
- 4) Do not cover racks or any other part of the oven with metal foil. This will cause overheating of the oven.

DEFROSTING CHART

Item and Weight	Defrosting Time	Standing Time	Special Techniques
BEEF Minced beef 454g (1 lb.)	5-7 min.	5-7 min.	Break apart and remove thawed portions with fork.
Stew Meat 681 (1 ¹ / ₂ lbs.)	6-8 min.	5-7 min.	Separate and rearrange once.
Loin Roast 907g (2 lbs.)	10-12 min.	5-7 min.	Turn over after half the time. Shield as needed.
Patties 4 (113g (4 oz.))	2-4 min.	5-7 min.	Turn over after half the time.
PORK Loin Roast 907g (2 lbs.)	8-10 min.	7-10 min.	Turn over after half the time. Shield as needed.
Spareibs 454g (1 lb.)	3-5 min.	5-7 min.	Separate and rearrange once.
Chops 4 (142g (5 oz.))	3-5 min.	5-7 min.	Separate and turn over once.
Minced 454g (1 lb.)	4-6 min.	5-7 min.	Break apart and remove thawed portions with fork.
POULTRY Whole Chicken 1134g (2 ¹ / ₂ lbs.)	10-14 min.	10-15 min.	Breat side down. Turn over after half the time. Shield as needed.
Chicken Breasts 454g (1 lb.)	5-7 min.	5-7 min.	Separate and rearrange once.
Fryer Chicken (cut up) 907g (2 lbs.)	7-9 min.	5-7 min.	Separate and rearrange once.
Chicken Thighs 681g (1 ¹ / ₂ lbs.)	6-10 min.	5-7 min.	Separate and rearrange once.
FISH & SEAFOOD Whole Fish 454g (1 lb.)	2-3 min.	5-7 min.	Turn over after half the time. Shield as needed.
Fish Fillets 681g (1 ¹ / ₂ lb.)	3-4 min.	5-7 min.	Separate and turn over once.
Shrimp 227g (1/2 lb.)	1-2 min.	5-7 min.	Separate and rearrange once.

* The times are approximate because freezer temperatures vary.

VEGETABLE					
ITEM	POWER LEVEL	PREPARATION	QUANTITY	COOKING TIME	STANDING TIME
Artichokes, fresh	P-HI	Whole	4(8 oz. each)	5-7 min.	5 min.
Artichokes, frozen	P-HI	Hearts	250g(9 oz. pkg)	6-8 min.	5 min.
Asparagus, fresh	P-HI	1 ¹ / ₂ -in.pieces	500g(1 lb.)	3-5 min.	3 min.
Asparagus, frozen	P-HI	Whole spears	280g(10 oz. pkg)	5-7 min.	3 min.
Broccoli, fresh	P-HI	Spears	500g(1 lb.)	3-5 min.	-
Broccoli, frozen	P-HI	Whole or cut	280g(10 oz. pkg)	5-7 min.	3 min.
Brussels sprouts, fresh	P-HI	Whole	280g(10 oz. tub)	3-5 min.	-
Brussels sprouts, frozen	P-HI	Whole	280g(10 oz. pkg)	5-7 min.	3 min.
Carrots, fresh	P-HI	1/2-in.slices	500g(1 lb.)	4-6 min.	3 min.
Carrots, frozen	P-HI	Sliced	280g(10 oz. pkg)	3-4 min.	3 min.
Cauliflower, frozen	P-HI	florets	280g(10 oz. pkg)	3-4 min.	3 min.
Celery, fresh	P-HI	1/2-in.slices	500g(1 lb.)	3-5 min.	5 min.
Corn, fresh	P-HI	on cob, husked	4 ears	5-7 min.	5 min.
Corn, frozen	P-HI	on cob, husked	4 ears	5-7 min.	5 min.
	P-HI	whole kernel	280g(10 oz. pkg)	4-6 min.	3 min.
Eggplant, fresh	P-HI	cubed	500g(1 lb.)	3-5 min.	3 min.
	P-HI	whole, pierced	500-700g(1-1 ¹ / ₂ lb.)	4-6 min.	5 min.
Leeks fresh	P-HI	whole, ends	500g(1 lb.)	4-6 min.	5 min.
Lima beans, frozen	P-HI	whole	280g(10 oz. pkg)	4-6 min.	3 min.
Mixed vegetables frozen	P-HI	-	280g(10 oz. pkg)	4-6 min.	3 min.
Mushrooms, fresh	P-HI	sliced	500g(1 lb.)	2-3 min.	3 min.
Okra, frozen	P-HI	sliced	280g(10 oz. pkg)	4-6 min.	5 min.
Onions, fresh	P-HI	whole, peeled	8-10 small	5-7 min.	5 min.
Pea pods(snow peas), frozen	P-HI	whole	170g(6 oz. pkg)	2-3 min.	3 min.
Peas and carrots	P-HI	-	280g(10 oz. pkg)	2-3 min.	3 min.
Parsnips, fresh	P-HI	cubed	500g(1 lb.)	4-6 min.	5 min.
Potatoes, white or sweet, fresh	P-HI	whole	4(6 oz. each)	15-17 min.	3 min.
	P-HI	whole	8(6 oz. each)	18-20 min.	5 min.
Squash, summer, fresh	P-HI	1/2-in.slices	500g(1 lb.)	3-5 min.	3 min.
Squash, summer, frozen	P-HI	sliced	280g(10 oz. pkg)	3-5 min.	3 min.
Squash, winter, fresh	P-HI	whole, pierced	700g(1 ¹ / ₂ lbs.)	6-8 min.	5 min.
Squash, winter, frozen	P-HI	whipped	340g(12 oz. pkg)	4-6 min.	3 min.
Succotash, frozen	P-HI	-	280g(10 oz. pkg)	3-5 min.	3 min.
Turnips	P-HI	cubed	4 cups	4-6 min.	3 min.

Grill / Combination / Convection	Ingredients	Method
<p>Beef Kabobs (Serve 4)</p>	<p>2/3 cup Italian salad dressing 454(1 lb.) beef sirloin steak, boneless cut into 2.5cm(1" cubes) cubes 1/2 green pepper, cored and cut into 8 pieces 4 large mushrooms 4 cherry tomatoes 4 whole garlic Buttered cooked rice</p>	<ol style="list-style-type: none"> 1. Pour dressing into microwaveable medium casserole. Cook on 100% microwave power for 1 minute or until heated. Add beef and stir to coat. Cover; refrigerate for at least 4 hours. 2. When ready to assemble kabobs, alternate beef, green pepper, mushroom, cherry tomato, green pepper and garlic on four 23cm (9") metal skewers. 3. Place kabobs on metal rack on turntable. Grill for 15 minutes; turn kabobs over Grill for 7 minutes. Serve on rice.
<p>Bacon cheese Stuffed Potatoes (Serves 4)</p>	<p>4 medium baking potatoes (about 681g(1 1/2 lbs.) 6 slices bacon 1/2 cup milk 1 cup ricotta cheese 1/2 cup freshly grated Parmesan cheese divided 1 egg, slightly beaten 1/4 tsp salt 1/2 tsp dry mustard Dash ground pepper 1 tsp chives</p>	<ol style="list-style-type: none"> 1. Prick well-scrubbed potatoes twice. Place 2.5cm(1") apart in oven. Cook on 100% microwave power for 7 1/2 to 9 1/2 minutes. Wrap in foil; Let stand at least 5 minutes to complete cooking. 2. While potatoes are standing. microwave bacon. Place bacon on 2 layer of paper towel. Cover with 2 more layers of towels. Cook on 100% microwave power for 3 to 4 minutes, or until slightly underdone. Let stand while preparing potatoes. 3. Cut thin lengthwise slice from top of each potato. Carefully scoop pulp from potatoes, leaving 0.6cm(1/4") shells; mash potato with fork in large bowl. 4. Mix in ricotta, 1/2 cup parmesan cheese, egg, salt, mustard and pepper until smooth. 5. Crumble bacon; add two-third of it to potato mixture. Mix in desired amount of milk. Mound Potato mixture in shells and sprinkle with remaining bacon and chives over top. 6. Arrange stuffed potatoes on turntable. Cook Convection for 30-35 minutes at 430°F(220°C) or until tops are lightly browned.
<p>Apple pie</p>	<p>450g (1lb) shortcrust pastry 300g (12oz) prepared apples cored, peeled, sliced 25g (1oz) brown sugar For the glaze 1 egg, beaten 30ml (2tbsp) milk 12 1/2g (1/2 oz) caster sugar</p>	<ol style="list-style-type: none"> 1. Roll out half the pastry and line a 22cm(9") pie plate. 2. Place prepared fruit on lined plate and sprinkle with brown sugar. 3. Roll out the remaining pastry to make a lid for the pie. Moisten edge of lined plate and place lid on pie, press edges together gently to seal. Cut off excess pastry around edges with a sharp knife. 4. Mix together the egg and mix to form a glaze, brush over pie and sprinkle with caster sugar. 5. place pie on turntable. Bake on Convection 350°F(180°C) for 45-50 minutes until light golden brown.

Grill / Combination / Convection	Ingredients	Method
Peanut butter cookies (Serve 12-15)	150g (6oz) butter 75g (3oz) crunchy peanut butter 100g (4oz) soft brown sugar 1 egg, beaten 150g (6oz) flour 50g (2oz) unsalted peanuts shelled and chopped	<ol style="list-style-type: none"> Mix the butter, peanut butter, sugar and egg together. Add the flour and chopped nuts and mix to a firm dough. Place rounded teaspoonfuls on greased baking trays and flatten slightly. Preheat the oven. When oven is preheated, place metal rack on turntable. Cook Convection 338°F(170°C) for 30-35 minutes or until golden. Leave on tray for 3-4 minutes, then transfer to cooling rack. Store in an airtight tin when cool.
Short Cake (Serve 5-6)	2 cups flour 1/3 cup shortening 2 tbsp sugar 1 baking powder 1 tsp salt 3/4 cup milk sweetened fruit	<ol style="list-style-type: none"> Blend dry ingredients in medium mixing bowl. Cur in shortening until crumbly. Stir in milk until just moistened. Knead dough gently on floured surface about 2 minutes. Press into 20cm (8") round glass baking dish. Cook Convection for 25 minutes at 410°F (210°C). Then Cook on 100% microwave power for 1 1/2 to 2 minutes or until toothpick inserted in centre comes out clean. Split and serve with sweetened fruit.

REHEATING CHART

ITEM	QUANTITY	POWER LEVEL	COOKING TIME	SPECIAL INSTRUCTION
Appetizers (bite size)	2 servings	P-HI	1-2 min.	Heat 12 at time on paper towel lined paper plate or microwave oven roasting rack
Breakfast entrée	110~140g(4-5 oz.)	P-HI	1-2 min.	If containers is 3/4-inch deep, remove foil cover and replace foil tray in original box. For containers more then 3/4-inch deep, remove food to similar size glass container; heat, covered. If no top crust stir occasionally.
Entrée	250g(8-9 oz.)	P-HI	6-8 min.	
Regular TV-style dinner	600g(21 oz.)	P-HI	10-12 min.	
Hearty TV-style dinner	300g(11 oz.) 480g(17 oz.)	P-HI P-HI	4-6 min. 5-8 min.	
Fried chicken	2 pieces	P-HI	1-2 min.	Arrange, on paper tower lined paper plate, covered with paper tower.
	4 pieces	P-HI	2-4 min.	
	6 pieces	P-HI	3-5 min.	
Fried fresh fillets	2 fillets	P-HI	1-2 min.	
	4 fillets	P-HI	2-4 min.	
Pizzas (sliced)	1	P-HI	1-2 min.	
	2	P-HI	2-3 min.	
	4	P-HI	3-6 min.	
Pouch dinners	140~160g(5-6 oz.)	P-HI	2-3 min.	Pierce pouch. Set on plate. Turn over halfway through cooking.
	280~300g(10-11 oz.)	P-HI	5-7 min.	
Bagels	2	P-60	1-2 min.	Each individually wrapped in paper toweling (for 1-2) or arrange on paper plate, cover with paper toweling.
	4	P-60	2-4 min.	
Danish	1	P-60	¹ / ₂ -1 min.	
	2	P-60	1-2 min.	
	4(6 oz. pkg) 6(13 oz. pkg)	P-60 P-60	2-3 min. 3-4 min.	
Dinner rolls	6	P-60	1-2 min.	
Hard rolls	1(1-1 ¹ / ₄ oz.)	P-60	¹ / ₂ -1 min.	
	2	P-60	1-2 min.	
	4	P-60	2-3 min.	
Frozen Juice	170g(6 oz.)	P-HI	1-2 min.	
Concentrates	340g(12 oz.)	P-HI	2-3 min.	
Non-Dairy creamer	450g(16 oz.)	P-60	6-8 min.	
Pancake	280g(10 oz.)	P-60	3-5 min.	
Frozen vegetables	160g(6 oz.)	P-60	5-7 min.	Pierce box, set on plate. If box is foil wrapped, remove foil. If vegetables are in pouch, pierce pouch. Let stand 5 min.
	280g(10 oz.)	P-60	6-10 min.	
Cheese cake	500g(17 oz.)	P-60	3-4 min.	Remove from original container. Arrange on a serving plate. Let stand 5 minutes after cooking(to defrost). Add an additional 1-2 minutes to serve warm.
Brownies	360g(13 oz.)	P-60	1-3 min.	
Pound cake	300g(10 ³ / ₄ oz.)	P-60	1-2 min.	
Coffee cake	300~340g(11-12 oz.)	P-60	2-3 min.	

CARE OF YOUR MICROWAVE OVEN

- 1 Turn the oven off before cleaning.
- 2 Keep the inside of the oven clean. When food spatters or spilled liquids adhere to **oven wetal, plate tray** wipe with a damp cloth. Mild detergent may be used if the oven gets very dirty. The use of harsh detergent or abrasives is not recommended.
- 3 The outside oven surface should be cleaned with soap and water, rinsed and dried with a soft cloth. To prevent damage to the operating parts inside the oven, water should not be allowed to seep into the ventilation openings.
- 4 If the Control Panel becomes wet, clean with a soft, dry cloth. Do not use harsh detergents or abrasives on Control Panel.
- 5 If steam accumulates inside or around the outside of the oven door, wipe with a soft cloth. This may occur when the microwave oven is operated under high humidity conditions and in no way indicates malfunction of the unit.

USE YOUR MICROWAVE OVEN SAFELY

General Use

Do not attempt to defeat or tamper with safety interlocks.

Do not place any object between the oven front frame and the door or allow residue to build up on sealing surfaces. Wipe with a mild detergent, rinse and dry. Never use abrasive powders or pads.

Do not subject the oven door to strain or weight such as a child hanging on an open door.

This could cause the oven to fall forward resulting in injury to you and damage to the oven.

Do not operate the oven if door seals or sealing surfaces are damaged; or if door is bent; or if hinges are loose or broken.

Do not operate the oven empty. This will damage the oven.

Do not attempt to dry clothes, newspapers or other materials in the oven. They may catch on fire.

Do not use recycled paper products as they may contain impurities which may cause sparks or fires.

Do not hit or strike the control panel with hard objects. This can damage the oven.

Food

Never use your microwave oven for home canning. The oven is not designed for proper home canning. Improperly canned food may spoil and be dangerous to consume.

Always use the minimum recipe cooking time. It is better to undercook rather than overcook foods.

Undercooked foods can be returned to the oven for more cooking. If food is overcooked, nothing can be done.

Heat small quantities of food or foods with low moisture carefully. These can quickly dry out, burn or catch on fire.

Do not heat eggs in the shell. Pressure may build up and eggs can explode.

Potatoes, apples, egg yolks and sausages are examples of food with non-porous skins.

These must be pierced before cooking to prevent bursting.

Do not attempt to deep fat fry in your microwave oven.

Always stir liquids before heating. Heated liquids can erupt, if not mixed with air.

Do not leave the oven unattended while popping corn.

Do not pop corn in a paper bag unless it is the commercially prepared Microwave Popcorn product. The kernels can overheat and ignite a brown paper bag.

Do not put packaged Microwave Popcorn bags directly on the oven tray. Place the package on a microwave safe glass or ceramic plate to avoid overheating and cracking the oven tray.

Do not exceed the Microwave Popcorn manufacturers' suggested popping time. Longer popping does not yield more popcorn but it can result in scorch, burn or fire. Remember, the Popcorn bag and tray can be too hot to handle. Remove with caution and use pot holders.

ARCING

If you see arcing, open the door and correct the problem.

Arcing is the microwave term for sparks in the oven.

Arcing is caused by:

- Metal or foil touching the side of the oven.
- Foil not molded to food (upturned edges act like antennas).
- Metal, such as twist-ties, poultry pins, or gold rimmed dishes, in the microwave.
- Recycled paper towels containing small metal pieces being used in the microwave.

BEFORE YOU CALL FOR SERVICE

Refer to following checklist, you may prevent an unnecessary service call.

* The oven doesn't work;

1. Check that the power cord is securely plugged in.
2. Check that the door firmly closed.
3. Check that the cooking time is set.
4. Check for a blown circuit fuse or tripped main circuit breaker in your house.

* Sparking in the cavity;

1. Check that utensils are metal containers or dishes with metal trim.
2. Check that metal skewers touch the interior walls.

If there is still a problem, contact the service station.

A list of these stations is included in the oven.

DO NOT ATTEMPT TO SERVICE THE OVEN YOURSELF!

QUESTIONS AND ANSWERS

* Q : I accidentally ran my microwave oven without any food in it. Is it damaged?

A : Running the oven empty for a short time will not damage the oven.
However, it is not recommended.

* Q : Can the oven be used with the glass tray or roller guide removed?

A : No. Both the glass tray and roller guide must always be used in the oven before cooking.

* Q : Can I open the door when the oven is operating?

A : The door can be opened anytime during the cooking operation. Then microwave energy will be instantly switched off and the time setting will maintain until the door is closed and START is touched.

* Q : Why do I have moisture in my microwave oven after cooking?

A : The moisture on the side of your microwave oven is normal. It is caused by steam form cooking food heating the cool oven surface.

* Q : Dose microwave energy pass through the viewing screen in the door?

A : No. The metal screen bounces back the energy to the oven cavity. The holes are made to allow light to pass through. They do not let microwave energy pass through.

* Q : Why do eggs sometimes pop?

A : When baking or poaching eggs, the yolk may pop due to steam build-up inside the yolk membrane. To prevent this, simply pierce the yolk with a toothpick before cooking. Never cook eggs without piercing their shells.

QUESTIONS AND ANSWERS (continued)

* Q : Why is standing time recommended after the cooking operation has been completed?

A : Standing time is very important.

With microwave cooking, the heat is in the food, not in the oven. Many foods build up enough internal heat to allow the cooking process to continue, even after the food is removed from the oven. Standing time for joints of meat, large vegetables and cakes allows the inside to cook completely, without overcooking the outside.

* Q : What does “standing time” mean?

A : “Standing time” means that food should be removed from the oven and covered for additional time to allow it to finish cooking. This frees the oven for other cooking.

* Q : Why does my oven not always cook as fast as the microwave cooking guide says?

A : Check your cooking guide again, to make sure you've followed directions exactly ; and to see what might cause variations in cooking time. Cooking guide times and heat settings are suggestions, to help prevent over-cooking... the most common problem in getting used to a microwave oven.

Variations in the size, shape and weights and dimensions could require longer cooking time. Use your own judgement along with the cooking guide suggestions to check whether the food has been properly cooked just as you would do with a conventional cooker.

* Q : Will the microwave oven be damaged if it operates while empty?

A : Yes. Never run it empty.

* Q : Can I operate my microwave oven without the turntable or turn the turntable over to hold a large dish?

A : No. If you remove or turn over the turntable, you will get poor cooking results. Dishes used in your oven must fit on the turntable.

* Q : Is it normal for the turntable to turn in either direction?

A : Yes. The turntable rotates clockwise or counterclockwise, depending on the rotation of the motor when the cooking cycle begins.

* Q : Can I pop popcorn in my microwave oven? How do I get the best results?

A : Yes. Pop packaged microwave popcorn following manufactures guidelines or use the preset POPCORN pad. Do not use regular paper bags. Use the “listening test” by stopping the oven as soon as the popping slows to a “pop” every 1 or 2 seconds. Do not repop unpopped kernels. Do not pop popcorn in glass cookware.

Limited Warranty

DAEWOO

DAEWOO ELECTRONICS AMERICA, INC. warrants the following microwave ovens to be free from defective material and workmanship and agrees to remedy any such defect or to furnish a new part (at the Company's option) in exchange for any part of any unit of its manufacture which under normal installation, use and service disclosed such defect, provided the unit is delivered by the owner to use or to our authorized distributor from whom purchased or authorized service station, intact, for our examination with all transportation charges prepaid to our factory. To establish and receive warranty service at our factory or authorized service facilities, a sales receipt or bill of sales is required for proof of purchase.

Written authorization must be obtained before any merchandise is returned to the factory.

This warranty does not extend to any of our electronic products which have been subjected to misuse, neglect, accident, incorrect wiring not our own, improper installation, unauthorized modification, or to use in violation of instructions furnished by us, nor units which have been repaired or altered outside of our factory, nor to cases where the serial number there of has been removed, defaced or changed.

This warranty is in lieu of all warranties expressed or implied and no representative or person is authorized to assume for us any other liability in connection with the sales of our electronic products.

Over the counter exchange for units that are initially defective. Initial defective is described as when the dealer opens the unit and finds that it is inoperative or an individual customer opening a new unit and finding that it is initially defective. This unit may be returned to the factory by the dealer for exchange. Under no circumstances will an individual customer be permitted to return defective unit directly to factory. Exchange must be directly with dealer. When this unit is returned to dealer, a copy of the purchase evidence stating the date or purchase is to be put in the individual box for dealer's further control with the factory.

<u>MODEL</u>	<u>PARTS</u>	<u>LABOR</u>	<u>MAGNETRON</u>
Microwave Oven Model: KOC-924T9N	1 year	1 year	5 years

Note: The warranty service center list is constantly changing with the addition of our current qualified service centers. If there is inadequate or no local service facility, subject individual customer will call DAEWOO on the toll free number **1-800-DAEWOO8(1-800-323-9668)** to be provided with further informations.