



CINTIQ[®] companion

- ⓔ Quick start guide
- ⓓ Schnellstartanleitung
- Ⓝ Snelgids
- ⓕ Guide de mise en route
- ⓐ Guida rapida
- ⓔ Guía de arranque rápido
- ⓕ Руководство по быстрому запуску
- ⓐ Podręcznik szybkiej instalacji

Professional Hybrid Creative Tablet



wacom





Welcome

Thank you for buying a Cintiq Companion Hybrid. You hold in your hands a unique tool that will let you create both in the studio and when mobile. It is a fully functional Cintiq pen display when attached to a PC or Mac and when untethered is a capable Android tablet designed specifically for creative work.

Before using your new Cintiq please read this Quick start guide. It is very important that you follow the setup instructions so that your Cintiq will function properly.

After installation you can find many resources on how to use your new Cintiq. When in mobile mode look on your Cintiq for the Wacom Mobile Center app which has links to tutorials and support.

At the conclusion of the setup you will be asked to register your new Cintiq with Wacom. We strongly encourage you to do so in order to take advantage of all the available Wacom resources.

Sincerely

The Wacom Team





Supplied accessories

EN

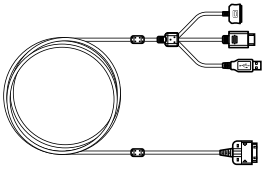

3-in-1 cable

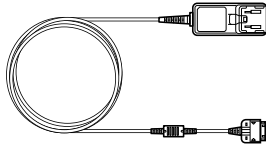

Power adapter

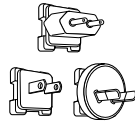

Plug



Pen

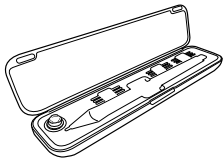

Pen case



Color rings



Pen nibs



Nib removal
tool

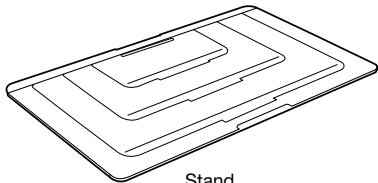

Stand



Quick start guide



Cloth



Getting to know the Cintiq

1. Home button
2. Rocker Ring
3. ExpressKeys
4. Light sensor
5. Front camera
6. Grip pad
7. Speaker
8. Stand slots
9. Rear camera
10. Power button
11. Microphone
12. Headphone jack
13. USB port
14. 3-in-1 connector
15. Micro HDMI port (video out)
16. MicroSD card slot
17. Microphone
18. Battery status LED

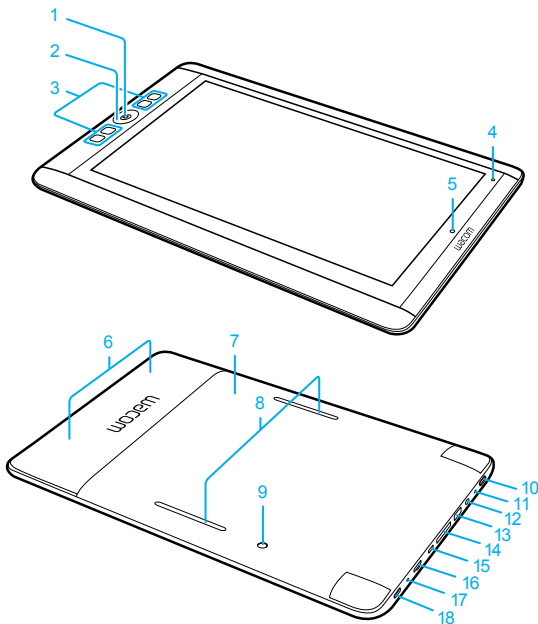

See the User's Manual for details.



Using the stand

EN

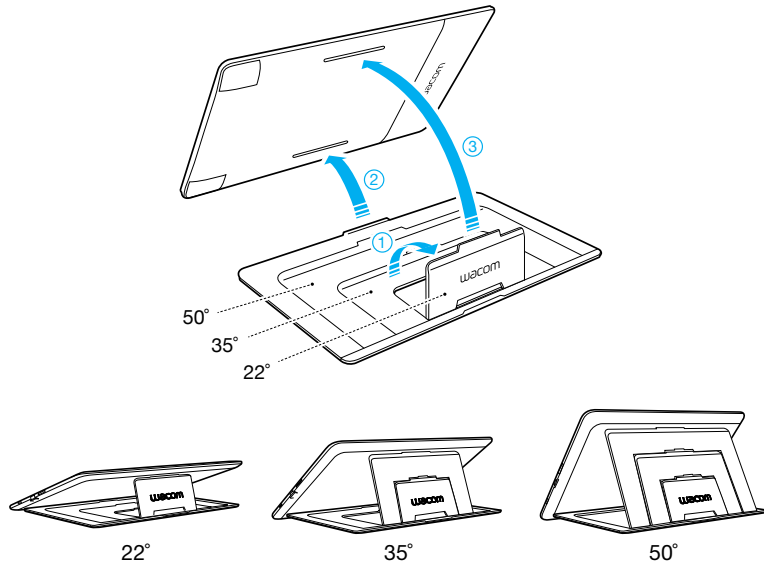

Setting up the Cintiq for the first time

1. For full setup make sure you have access to a wifi network.
2. Connect the 3 in 1 cable as shown.
3. Turn on the Cintiq by pressing the power button for 2 seconds.
4. Follow on-screen instructions to first setup mobile mode. When prompted, calibrate pen to screen cursor. Click on the cross hairs and test the calibration before accepting it. Calibration must be done separately in mobile and desktop modes.

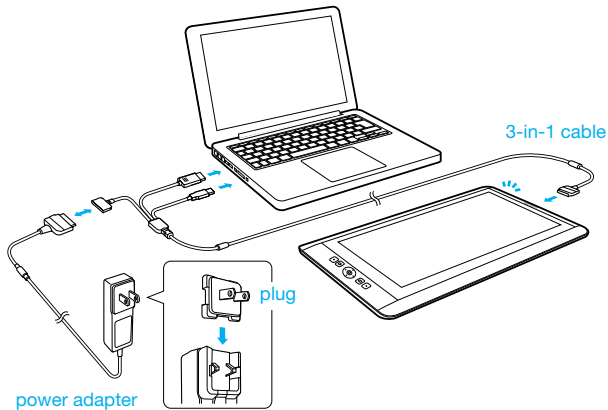

Make sure the Cintiq is connected to AC power before beginning setup.



Setting up the Cintiq for Desktop mode

1. After Mobile Mode setup, the Cintiq will automatically switch into Desktop mode.
2. A virtual CD, “Install_CCH”, will appear. Open the virtual CD and click on “Startup” (Windows) or “Install Tablet” (Macintosh). Follow the instructions to install the driver and software.



If nothing is displayed

1. Disconnect 3-in-1 cable to switch back to Mobile Mode.
 2. Launch “Wacom Center” from the Android programs screen.
 3. Select “Desktop Driver Installation”, check the checkbox for “Show virtual Desktop Driver CD”.
 4. Reconnect the 3-in-1 cable to switch to Desktop Mode, and look for “Install_CCH”.
3. Double click the “Install tablet”, and follow on-screen instructions.

Using the pen with Cintiq

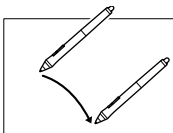

Move the pen slightly above the display, without touching the surface, to position the display cursor.

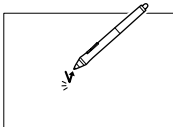

Tap the display once with the pen tip to select.

Choose a color ring to distinguish your pen.

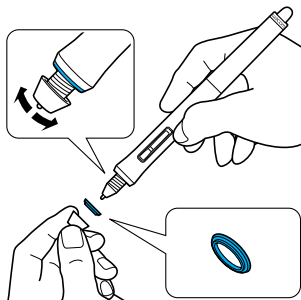

For best performance wipe off the display regularly with the cleaning cloth.

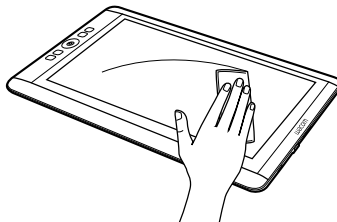



More information in the Wacom Center

The Wacom Center is a software utility available in both Mobile and Desktop Modes. It provides quick access to:

- Frequently used Cintiq settings
- User manual help with information on customizing your Cintiq, changing pen nibs, tips and tricks and troubleshooting
- Pen calibration. Wacom recommends to re-calibrate after significantly changing your working position or viewing angle
- Important Product Information such as specifications, warranties, licensing and care of your Cintiq
- Software updates
- Access to Wacom support

Wacom Mobile Center is available when your Cintiq is in Mobile Mode and running the Android OS



Wacom Desktop Center is available in Desktop Mode when your Cintiq is connected to your PC or Mac with the HDMI and USB cables



Registering Your Cintiq

Please register your Cintiq at the end of the setup process or in the Wacom Center.

Support options

Please check the back of this guide for the Technical Support contact information for your country.





Willkommen

Vielen Dank, dass Sie sich für ein Cintiq Companion Hybrid entschieden haben. Sie halten ein einzigartiges Werkzeug in Ihren Händen, mit dem Sie sowohl im Studio als auch unterwegs kreativ sein können. Schließen Sie es an Ihren PC oder Mac an, um es als voll funktionsfähiges Cintiq Stift-Display zu verwenden. Oder nutzen Sie es unterwegs als leistungsfähiges Android-Tablett, das speziell für kreative Arbeiten entwickelt wurde.

Bitte lesen Sie diese Schnellstartanleitung vor dem ersten Gebrauch Ihres neuen Cintiq. Damit Ihr Cintiq einwandfrei funktioniert, beachten Sie beim Einrichten bitte unbedingt die folgenden Anweisungen.

Nach der Installation stehen Ihnen zahlreiche Zusatzinformationen zur Nutzung Ihres neuen Cintiq zur Verfügung. Suchen Sie im mobilen Modus auf Ihrem Cintiq nach der Wacom Mobile Center-App, die Links zu Lernprogrammen und Support enthält.

Wenn Sie mit dem Einrichten fertig sind, werden Sie gebeten, Ihr neues Cintiq bei Wacom zu registrieren. Wir möchten Sie darin bestärken, die Registrierung durchzuführen, damit Sie alle verfügbaren Wacom Ressourcen voll nutzen können.

Mit freundlichen Grüßen

Das Wacom Team





Mitgeliefertes Zubehör

DE

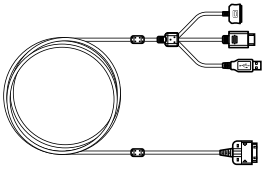

3-in-1-Kabel

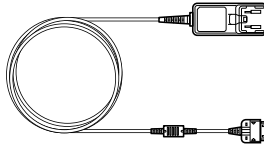

Netzadapter

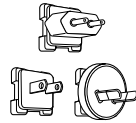

Stecker

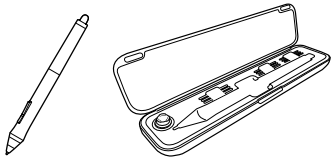

Stift

Stifttui



Farbringe



Stiftspitzen



Werkzeug zum Entfernen der Stiftspitzen

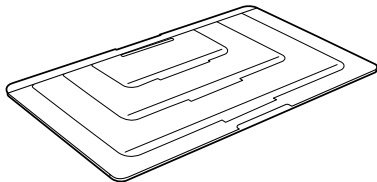

Aufstellvorrichtung



Schnellstartanleitung



Tuch





Lernen Sie Ihr Cintiq kennen

1. Home Button
2. Rocker Ring
3. ExpressKeys
4. Lichtsensor
5. Kamera an der Vorderseite
6. Halterung
7. Lautsprecher
8. Schlitz für Standfuß
9. Kamera an der Rückseite
10. Netzschalter
11. Mikrofon
12. Kopfhöreranschluss
13. USB-Anschluss
14. 3-in-1-Anschluss
15. Micro HDMI-Anschluss (Videoausgang)
16. MicroSD-Kartensteckplatz
17. Mikrofon
18. LED zur Batteriestatusanzeige

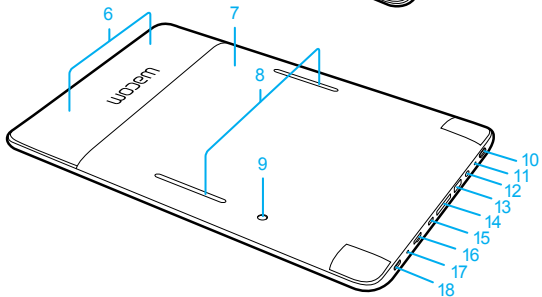
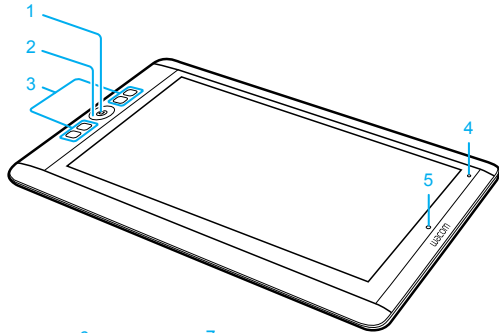

Weitere Informationen dazu finden Sie im Benutzerhandbuch.





Standfuß verwenden

DE

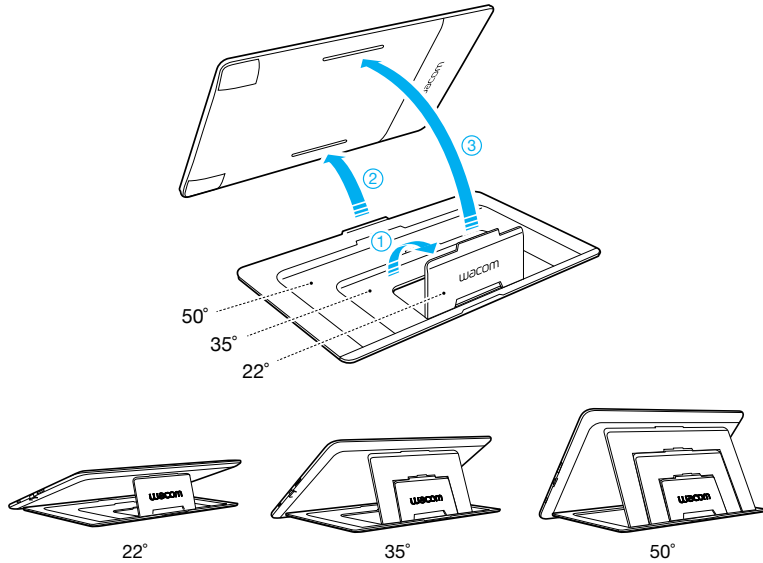



Cintiq erstmals einrichten

1. Um das Gerät vollständig einrichten zu können, überprüfen Sie, ob eine Verbindung zum WLAN-Netzwerk hergestellt ist.
2. Schließen Sie das 3-in-1-Kabel wie abgebildet an.
3. Schalten Sie das Cintiq ein, indem Sie den Netzschalter 2 Sekunden lang gedrückt halten.
4. Zum erstmaligen Einrichten des mobilen Modus, folgen Sie den Bildschirmanweisungen. Wenn Sie dazu aufgefordert werden, kalibrieren Sie Ihren Stift zum Bildschirmcursor. Klicken Sie auf das Fadenkreuz und testen Sie die Kalibrierung vor dem Bestätigen. Die Kalibrierung muss im mobilen und im Desktop-Modus separat vorgenommen werden.

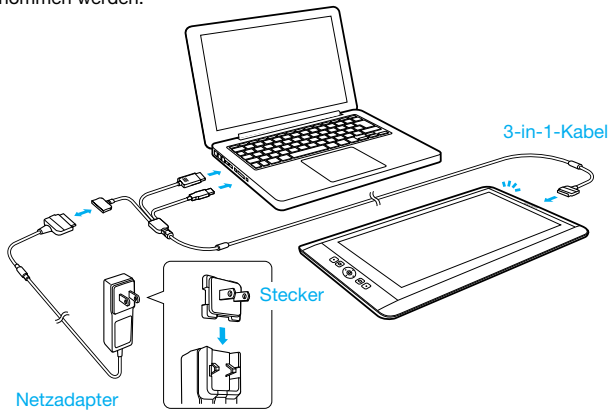

Überprüfen Sie vor dem Einrichten, ob das Cintiq an die Stromversorgung angeschlossen ist.





Cintiq für den Desktop-Modus einrichten

DE

1. Wenn der mobile Modus eingerichtet wurde, schaltet das Cintiq automatisch in den Desktop-Modus.
2. Die virtuelle „Install_CCH“-CD wird angezeigt. Öffnen Sie die virtuelle CD und klicken Sie auf „Start“ (Windows) oder „Tablett installieren“ (Macintosh). Folgen Sie den Anweisungen, um den Treiber und die Software zu installieren.



Wenn nichts angezeigt wird,

1. entfernen Sie das 3-in-1-Kabel, um in den mobilen Modus zu wechseln.
 2. starten Sie das „Wacom Center“ aus dem Android-Programmbildschirm.
 3. wählen Sie „Desktop-Treiberinstallation“ und aktivieren Sie das Kontrollkästchen „Virtuelle Desktop-Treiber-CD anzeigen“.
 4. schließen Sie das 3-in-1-Kabel erneut an, um in den Desktop-Modus zu wechseln. Gehen Sie zu „Install_CCH“.
3. Führen Sie auf „Tablett installieren“ einen Doppelklick aus und folgen Sie den Bildschirmanweisungen.





Stift mit dem Cintiq verwenden

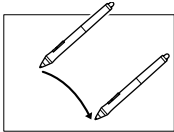

Bewegen Sie den Stift leicht über das Display (ohne die Tabletoberfläche zu berühren), um den Bildschirmcursor zu positionieren.

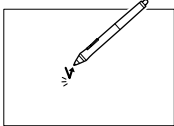

Tippen Sie zum Auswählen einmal mit der Stiftspitze auf das Display.

Wählen Sie einen Farbring, um Ihren Stift zu kennzeichnen.

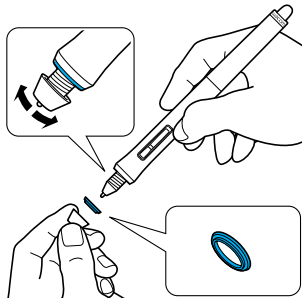

Für eine optimale Funktion wischen Sie das Display regelmäßig mit dem Reinigungstuch ab.

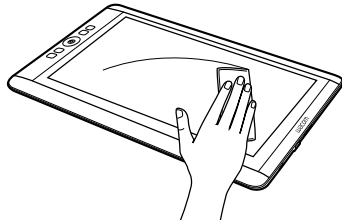



Weitere Informationen erhalten Sie im Wacom Center

Das Wacom Center ist ein Software-Dienstprogramm, das sowohl für den mobilen als auch für den Desktop-Modus verfügbar ist. Damit haben Sie schnellen Zugriff auf:

DE

- Häufig verwendete Cintiq Einstellungen
- Hilfe zum Benutzerhandbuch mit Informationen zum Anpassen Ihres Cintiq, Auswechseln der Stiftspitze, sowie Tipps, Tricks und Fehlerbehebungen
- Stiftkalibrierung. Wacom empfiehlt eine Neukalibrierung nach jeder erheblichen Veränderung der Arbeitsposition oder des Blickwinkels
- Wichtige Produktinformationen wie Spezifikationen, Garantie- und Lizenzbestimmungen sowie Pflege Ihres Cintiq
- Software-Updates
- Zugang zum Wacom Support

Das Wacom Mobile Center ist verfügbar, wenn auf Ihrem Cintiq der mobile Modus aktiviert ist und das Android-Betriebssystem läuft

Das Wacom Desktop Center ist im Desktop-Modus verfügbar, wenn Ihr Cintiq über das HDMI- und USB-Kabel mit Ihrem PC oder Mac verbunden ist



Cintiq registrieren

Bitte registrieren Sie Ihr Cintiq nach dem Einrichten oder direkt im Wacom Center.

Support-Optionen

Nähere Informationen zum technischen Kundendienst in Ihrem Land finden Sie auf der Rückseite dieser Anleitung.





Welkom

Bedankt voor uw aanschaf van een Cintiq Companion Hybrid. U beschikt hiermee over een uniek hulpmiddel waarmee u zowel op het werk als onderweg aan de slag kunt. Het is een volledig functionele Cintiq-pendisplay wanneer deze is aangesloten op een pc of Mac, en een krachtige Android-tablet voor creatieve werkzaamheden wanneer het apparaat niet is aangesloten.

Lees deze snelgids voordat u uw nieuwe Cintiq gaat gebruiken. Het is belangrijk dat u de installatie-instructies volgt om ervoor te zorgen dat uw Cintiq goed werkt.

Na de installatie kunt u allerlei informatiebronnen vinden voor het gebruik van uw nieuwe Cintiq. Zoek in de mobiele modus op uw Cintiq naar de app Wacom Mobile Center. Deze app bevat koppelingen naar leerprogramma's en ondersteuning.

Na voltooiing van de installatie wordt u gevraagd om uw nieuwe Cintiq te registreren bij Wacom. Wij raden u sterk aan dit te doen om te kunnen profiteren van alle beschikbare informatiebronnen van Wacom.

Met vriendelijke groeten,

Het Wacom-team





Meegeleverde accessoires

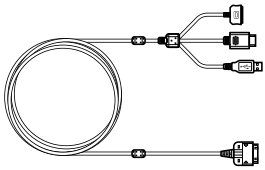

3-in-1-kabel

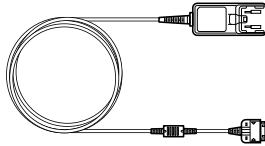

Stroomadapter

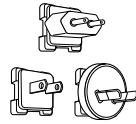

Stekker

NL



Pen

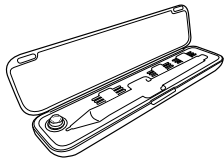

Penetui



Gekleurde
ringen



Penpunten



Penpunt-
verwijderaar

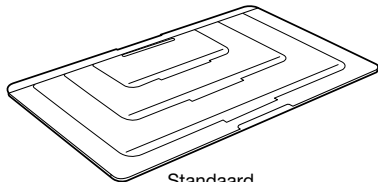

Standaard



Snelgids



Doek





Kennismaken met de Cintiq

1. Home Button
2. Rocker Ring
3. ExpressKeys
4. Lichtsensor
5. Camera aan voorzijde
6. Grippad
7. Luidspreker
8. Sleuven voor de standaard
9. Camera aan achterzijde
10. Aan/uit-knop
11. Microfoon
12. Hoofdtelefoonaansluiting
13. USB-poort
14. 3-in-1-aansluiting
15. Micro HDMI-poort (video-uit)
16. MicroSD-kaartsleuf
17. Microfoon
18. Led voor batterijstatus

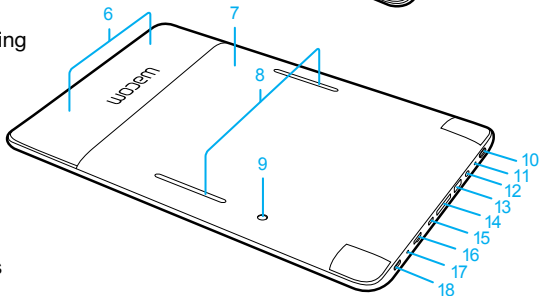
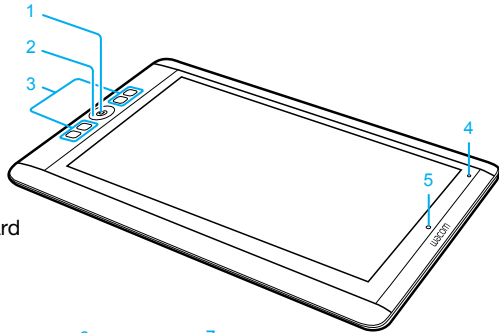

Raadpleeg de gebruikershandleiding voor meer informatie.





De standaard gebruiken

NL

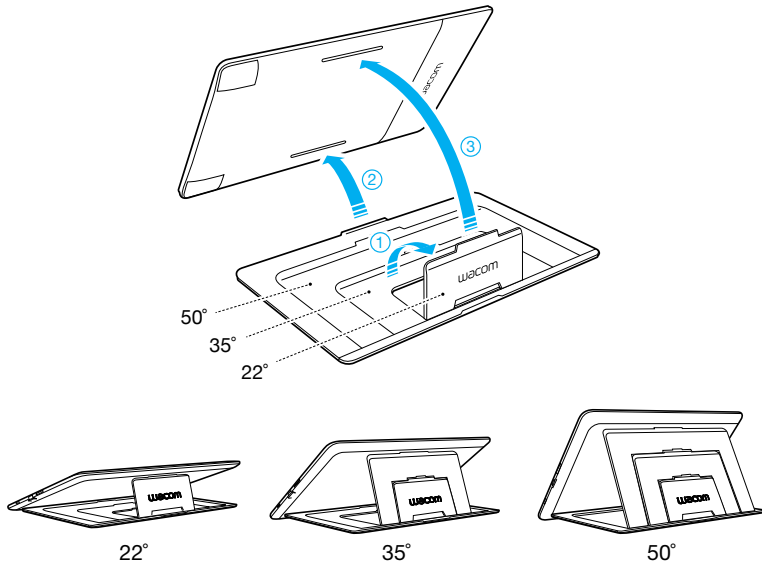



De Cintiq configureren voor het eerste gebruik

1. Zorg dat u toegang hebt tot een Wi-Fi-netwerk voor een volledige installatie.
2. Sluit de 3-in-1-kabel aan zoals getoond.
3. Schakel de Cintiq in door de aan/uit-knop 2 seconden ingedrukt te houden.
4. Volg de instructies op het scherm om eerst de mobiele modus te configureren. Kalibreer de pen met de schermcursor wanneer hierom wordt gevraagd. Klik op de kruisens en test de kalibratie voordat u deze accepteert. De kalibratie moet apart worden uitgevoerd in de mobiele modus en desktop-modus.

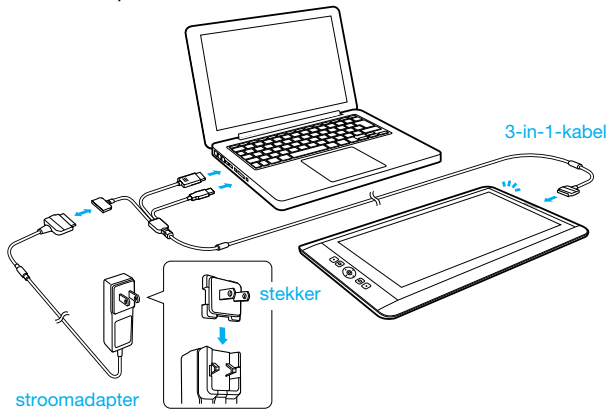

Zorg dat de Cintiq op een stopcontact is aangesloten voordat u begint met de installatie.





De Cintiq configureren voor de desktop-modus

1. Na de configuratie van de mobiele modus schakelt de Cintiq automatisch over naar de desktop-modus.
2. Er verschijnt een virtuele cd "Install_CCH". Open de virtuele cd en klik op "Startup" (Windows) of "Installeer tablet" (Macintosh). Volg de instructies om het stuurprogramma en de software te installeren.



Als niets wordt weergegeven

1. Koppel de 3-in-1-kabel los om terug te keren naar de mobiele modus.
 2. Start "Wacom Center" vanuit het scherm Android-programma's.
 3. Selecteer "Installatie van desktopstuurprogramma", schakel het selectievakje "Virtuele cd met desktopstuurprogramma's weergegeven" in.
 4. Sluit de 3-in-1-kabel opnieuw aan om naar de desktop-modus te gaan en kijk of u "Install_CCH" ziet.
3. Dubbelklik op "Tablet installeren" en volg de instructies op het scherm.

NL





De pen gebruiken met Cintiq

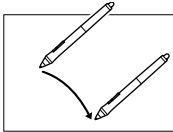

Beweeg de pen net boven het scherm, zonder het oppervlak aan te raken, om de displaycursor te positioneren.



Tik om te selecteren eenmaal met de penpunt op de tablet.

Kies een kleur ring om uw pen voor u herkenbaar te maken.

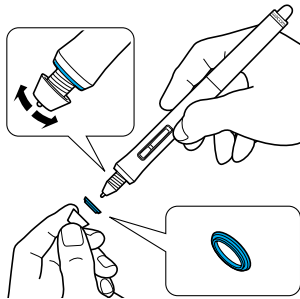

Veeg het scherm regelmatig schoon met het reinigingsdoekje om verzekerd te zijn van de beste resultaten.

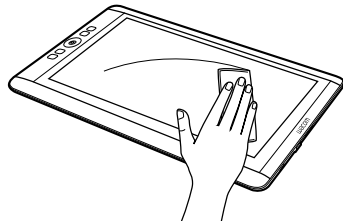



Meer informatie in het Wacom Center

Het Wacom Center is een softwareprogramma dat beschikbaar is in de mobiele modus en de desktop-modus. Het geeft snel toegang tot:

- Vaak gebruikte Cintiq-instellingen
- Gebruikersinformatie over het aanpassen van uw Cintiq, het omwisselen van penpunten, tips en trucs, en probleemoplossing
- Penkalibratie. Wacom raadt u aan de pen opnieuw te kalibreren als u uw werkpositie of kijkhoek in belangrijke mate verandert.
- Belangrijke productinformatie zoals specificaties, garantiebepalingen, licentiebepalingen en informatie over de verzorging van uw Cintiq
- Software-updates
- Toegang tot Wacom-ondersteuning

Het Wacom Mobile Center is beschikbaar wanneer uw Cintiq zich in de mobiele modus bevindt en het Android-besturingssysteem gebruikt.



Het Wacom Desktop Center is beschikbaar in de desktop-modus wanneer uw Cintiq is aangesloten op uw pc of Mac met de HDMI- en USB-kabels



Uw Cintiq registreren

Registreer uw Cintiq aan het einde van het installatieproces in het Wacom Center.

Ondersteuningsopties

Op de achterzijde van deze gids vindt u de contactgegevens van de technische ondersteuningdienst voor uw land.

NL





Bienvenue

Merci d'avoir choisi un Cintiq Companion Hybrid. Vous tenez entre vos mains un outil unique qui vous permettra de créer en toute liberté, où que vous soyez. C'est un écran à stylet Cintiq entièrement fonctionnel lorsqu'il est connecté à un PC ou à un Mac, et qui devient, lorsqu'il est utilisé seul, une tablette Android performante conçue spécialement pour vos travaux créatifs.

Veillez lire le guide de mise en route fourni avant de commencer à utiliser votre nouveau Cintiq. Il est essentiel que vous suiviez les instructions d'installation afin que votre Cintiq fonctionne correctement.

Une fois l'installation terminée, vous pourrez accéder à de nombreuses ressources concernant l'utilisation de votre nouveau Cintiq. En mode mobile, recherchez l'application Wacom Mobile Center sur votre Cintiq. Vous y retrouverez des liens vers des tutoriels et de l'aide.

Une fois la configuration effectuée, vous serez invité à enregistrer votre nouveau Cintiq auprès de Wacom. Nous vous encourageons vivement à le faire, afin de profiter de toutes les ressources Wacom disponibles.

Cordialement,

L'équipe Wacom





Accessoires fournis

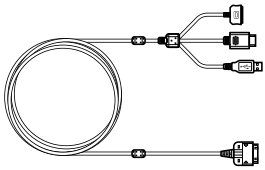

Câble 3 en 1

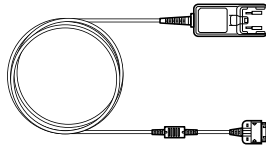

Adaptateur secteur

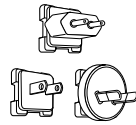

Prise d'alimentation

FR



Stylus

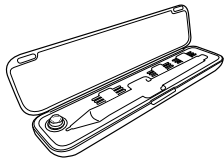

Étui du stylus



Bagues de couleur



Pointes de stylus



Extracteur de pointe

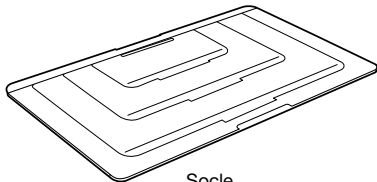

Socle



Guide de mise en route



Chiffon





Familiarisation avec le Cintiq

1. Home Button
2. Rocker Ring
3. ExpressKeys
4. Capteur de lumière
5. Caméra avant
6. Zone antidérapante
7. Haut-parleur
8. Encoches du socle
9. Caméra arrière
10. Bouton d'alimentation
11. Microphone
12. Prise pour écouteurs
13. Port USB
14. Connecteur 3 en 1
15. Port micro-HDMI (sortie vidéo)
16. Emplacement pour carte Micro SD
17. Microphone
18. Voyant d'état de la batterie

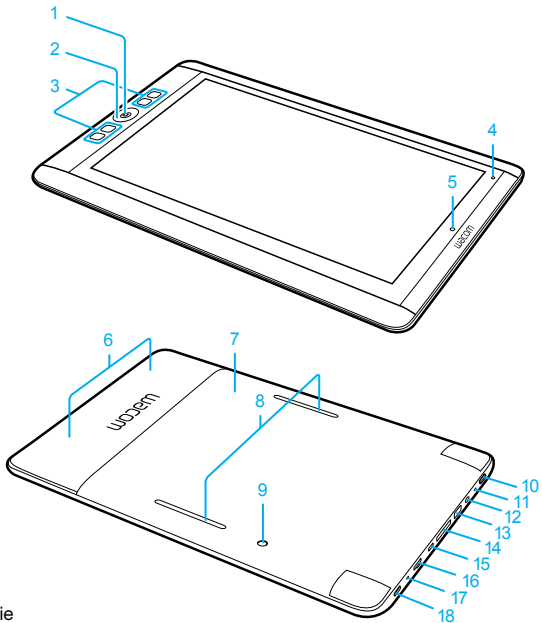

Reportez-vous au manuel de l'utilisateur pour plus de détails.





Utilisation du socle

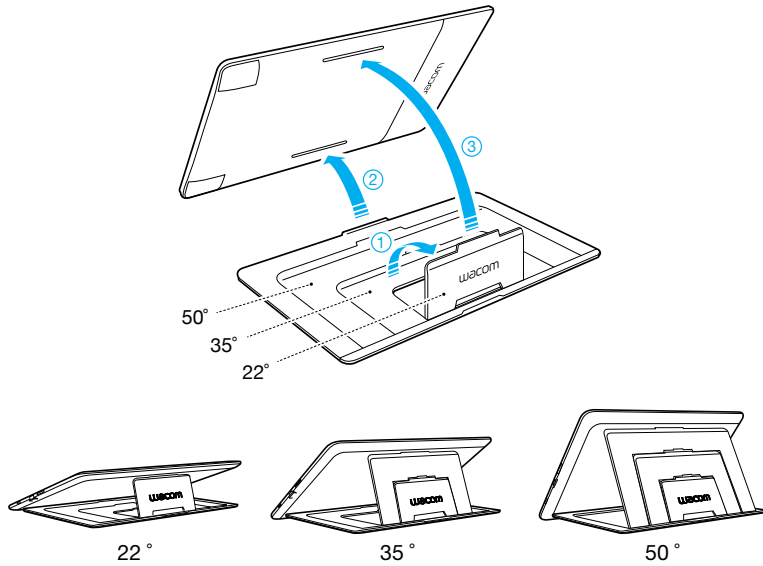



Première configuration du Cintiq

1. Pour effectuer une configuration complète, assurez-vous que vous avez accès à un réseau WiFi.
2. Branchez le câble 3 en 1 tel qu'indiqué sur le schéma.
3. Mettez le Cintiq sous tension en appuyant sur le bouton d'alimentation pendant 2 secondes.
4. Suivez les instructions indiquées à l'écran pour configurer d'abord le mode mobile. Lorsque vous y êtes invité, étalonnez le stylet en fonction du curseur à l'écran. Cliquez sur les croix et testez l'étalonnage avant de l'accepter. L'étalonnage doit être effectué séparément pour le mode mobile et pour le mode stationnaire.

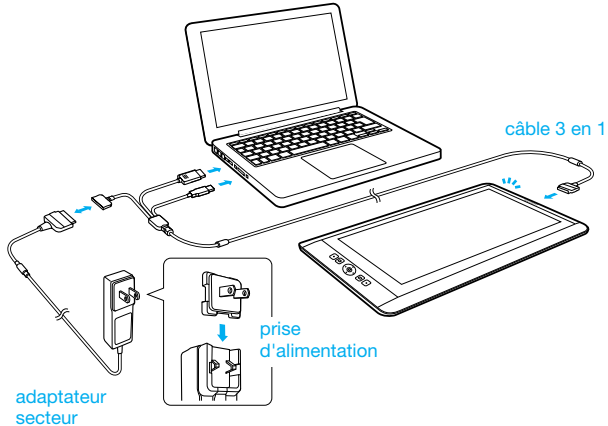

Assurez-vous que le Cintiq est connecté à l'alimentation secteur avant de débiter la configuration.





Configuration du Cintiq en mode stationnaire

1. Une fois la configuration en mode mobile effectuée, le Cintiq basculera automatiquement en mode stationnaire.
2. Un CD virtuel, « Install_CCH », apparaîtra à l'écran. Ouvrez le CD virtuel et cliquez sur « Démarrage » (Windows) ou « Installer la tablette » (Macintosh). Suivez les instructions indiquées pour installer le pilote et le logiciel.



Si aucune instruction ne s'affiche à l'écran

1. Déconnectez le câble 3 en 1 pour basculer en mode mobile.
 2. Ouvrez l'application « Wacom Center » à partir de l'écran des programmes Android.
 3. Sélectionnez « Installation des pilotes », cochez la case « Afficher le CD virtuel des pilotes ».
 4. Reconnectez le câble 3 en 1 pour basculer à nouveau en mode stationnaire et recherchez « Install_CCH ».
3. Double-cliquez sur « Installer la tablette » et suivez les instructions indiquées à l'écran.

FR





Utilisation du stylet avec le Cintiq

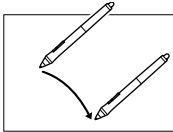

Déplacez légèrement le stylet au-dessus de l'écran (sans le toucher) pour positionner le curseur.

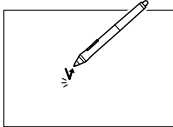

Appuyez brièvement sur l'écran à l'aide de la pointe du stylet pour effectuer une sélection.

Choisissez une bague de couleur pour personnaliser votre stylet.

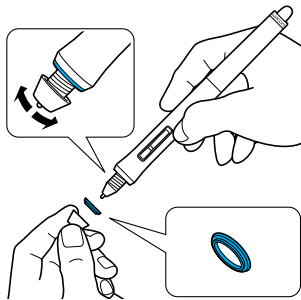

Pour un fonctionnement optimale, essayez régulièrement l'écran avec le chiffon.

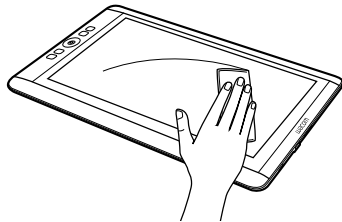



Plus d'informations sur l'application Wacom Center

L'application Wacom Center est un utilitaire disponible à la fois en mode mobile et en mode stationnaire. Il permet d'accès rapidement aux éléments suivants :

- Paramètres Cintiq fréquemment utilisés
- Aide du manuel de l'utilisateur contenant des informations sur la personnalisation de votre Cintiq et le changement des pointes de stylets, des conseils et des astuces ainsi que des informations relatives au dépannage
- Étalonnage du stylet. Wacom recommande d'étalonner à nouveau votre stylet si vous modifiez votre position de travail ou votre angle de vision
- Informations importantes concernant le produit : spécifications, garanties, licences et entretien de votre Cintiq
- Mises à jour logicielles
- Accès à l'Assistance Wacom

FR

L'application Wacom Mobile Center est accessible lorsque votre Cintiq est en mode mobile et qu'il s'exécute sur un système d'exploitation Android



L'application Wacom Desktop Center est accessible en mode stationnaire lorsque votre Cintiq est connecté à votre PC ou à votre Mac à l'aide des câbles HDMI et USB



Enregistrement de votre Cintiq

Veillez enregistrer votre Cintiq à la fin du processus d'installation, ou via l'application Wacom Center.

Assistance

Vous trouverez les coordonnées de l'assistance technique pour votre pays à l'arrière de ce guide.





Benvenuti

Grazie per aver acquistato Cintiq Companion Hybrid. Cintiq è uno strumento unico che permette di creare in ufficio e in viaggio: un display interattivo completamente funzionale, quando collegato a un PC o un Mac, e un tablet Android potente, progettata appositamente per lavori creativi, quando non è raccordato.

Prima di usare il nuovo dispositivo Cintiq, leggere la Guida rapida. È molto importante seguire le istruzioni di configurazione per un funzionamento corretto.

Una volta terminata la configurazione, sono disponibili numerose risorse su come usare il nuovo Cintiq. In modalità mobile, cercare l'applicazione Wacom Mobile Center che dispone dei collegamenti a tutorial e supporto.

Al termine della configurazione, verrà richiesto di registrare il nuovo Cintiq a Wacom. Questa operazione è particolarmente consigliata, per poter sfruttare i vantaggi di tutte le risorse Wacom disponibili.

Cordiali saluti,

Il team Wacom





Accessori forniti in dotazione

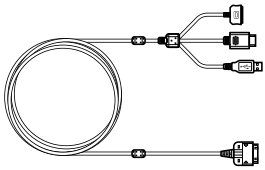

Cavo 3 in 1

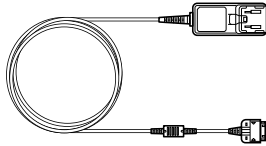

Alimentatore

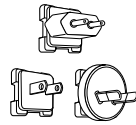

Spina



Penna digitale

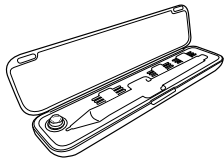

Custodia di ricarica della penna digitale



Anelli colorati



Punte della penna digitale



Rimozione punta della penna digitale strumento

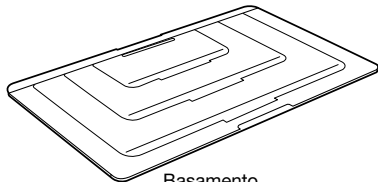

Basamento



Guida rapida



Panno





Descrizione di Cintiq

1. Home Button
2. Rocker Ring
3. ExpressKey
4. Sensore luce
5. Fotocamera anteriore
6. Impugnatura
7. Altoparlante
8. Slot per il basamento
9. Fotocamera posteriore
10. Pulsante di accensione
11. Microfono
12. Jack per cuffie
13. Porta USB
14. Connettore 3 in 1
15. Porta micro HDMI (uscita video)
16. Slot schede MicroSD
17. Microfono
18. LED di stato della batteria

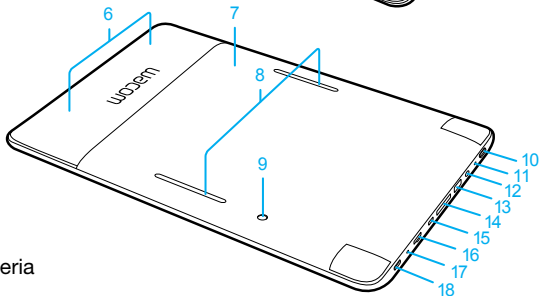
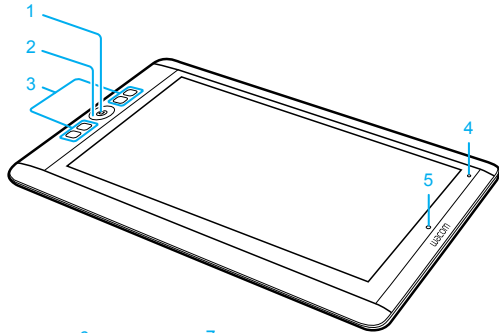

Per i dettagli, consultare la Guida per l'utente.





Uso del basamento

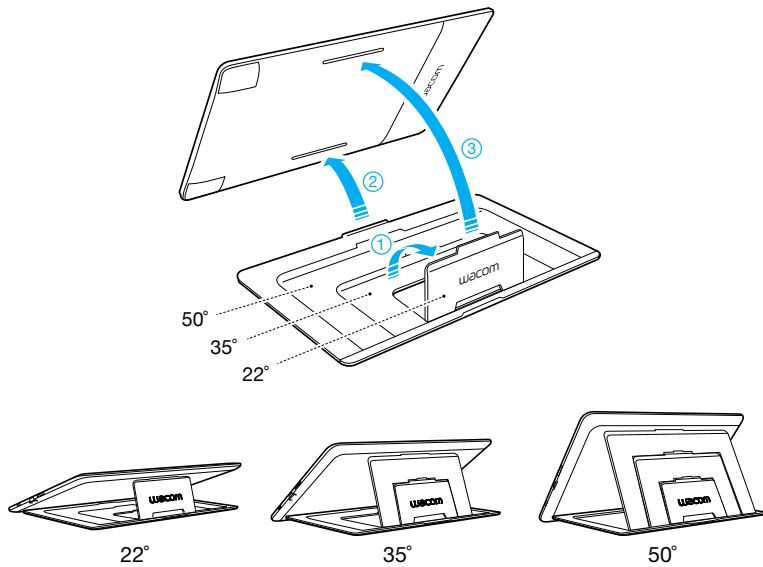



Prima configurazione di Cintiq

1. Per completare la configurazione, assicurarsi di avere accesso alla rete Wi-Fi.
2. Collegare il cavo 3 in 1 come mostrato.
3. Attivare Cintiq tenendo premuto il pulsante di accensione per 2 secondi.
4. Seguire le istruzioni a video per la prima installazione in modalità mobile. Quando richiesto, calibrare la penna digitale con il cursore sullo schermo. Fare clic sui crocini e testare la calibrazione prima di accettarla. La calibrazione deve essere effettuata separatamente tra modalità mobile e stazionario.

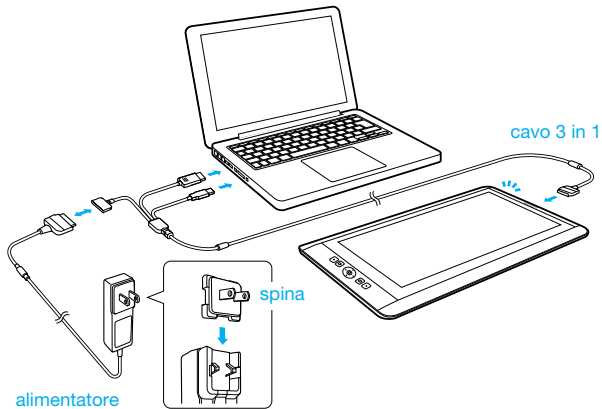

Assicurarsi che Cintiq sia collegato alla corrente CA prima di avviare la configurazione.





Configurazione di Cintiq per la modalità stazionario

1. Terminata la configurazione in modalità mobile, Cintiq passa automaticamente alla modalità stazionario.
2. Verrà visualizzato il CD virtuale "Install_CCH". Aprire il CD virtuale e fare clic su "Avvio" (Windows) o "Installa tablet" (Macintosh). Seguire le istruzioni per installare driver e software.



Se non viene visualizzato nulla

IT

1. Scollegare il cavo 3 in 1 per passare nuovamente in modalità mobile.
 2. Avviare "Wacom Center" dalla schermata dei programmi Android.
 3. Selezionare "Installazione driver desktop", poi la casella di controllo per "Mostra CD virtuale del driver desktop".
 4. Ricollegare il cavo 3 in 1 per passare alla modalità stazionario e cercare "Install_CCH".
3. Fare doppio clic su "Installa tablet" e seguire le istruzioni a video.





Uso della penna digitale con Cintiq

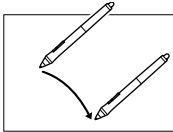

Per posizionare il cursore, muovere la penna digitale leggermente sopra il display, senza toccarlo.

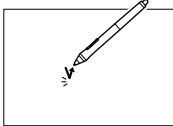

Con la punta della penna digitale toccare il display una volta per selezionare.

Scegliere un anello colorato per distinguere la penna digitale.

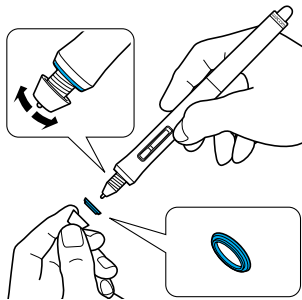

Per un funzionamento ottimale, pulire regolarmente il display con un panno pulito.

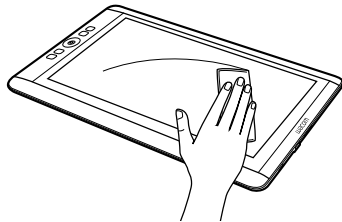



Maggiori informazioni su Wacom Center

Wacom Center è una utility software disponibile sia per la modalità mobile che per quella desktop. Fornisce accesso rapido a:

- Impostazioni Cintiq usate di frequente
- Manuale per l'utente con le informazioni per personalizzare Cintiq, cambiare le punte della penna digitale, trovare suggerimenti, trucchetti e procedure di risoluzione dei problemi
- Calibrazione della penna digitale. Wacom consiglia la ricalibrazione dopo aver cambiato in modo significativo la posizione di lavoro o l'angolo di visuale
- Importanti informazioni sul prodotto come specifiche, garanzie, licenze e procedure di manutenzione di Cintiq
- Aggiornamenti software
- Accesso al supporto Wacom

Wacom Mobile Center è disponibile quando Cintiq si trova in modalità mobile ed è in esecuzione sul sistema operativo Android



Wacom Desktop Center è disponibile nella modalità stazionaria, quando Cintiq è collegato al PC o al Mac tramite cavi HDMI e USB



IT

Registrazione di Cintiq

Registrare Cintiq al termine della procedura di configurazione o in Wacom Center.

Opzioni di supporto

Controllare il retro della presente guida per informazioni su come contattare il Supporto tecnico locale.

