

# intuos™

USER'S MANUAL FOR MACINTOSH®

intuos

intuos

intuos



WACOM

Wacom Intuos™ User's Manual for Macintosh®, March 25, 1999

English V2.0 for MacintoshEuropean English V2.0 for Macintosh

Copyright © Wacom Company, Limited, 1999

All rights reserved. No part of this manual may be reproduced except for your express personal use. Wacom reserves the right to revise this publication without obligation to provide notification of such changes. Wacom does its best to provide current and accurate information in this manual. However, Wacom reserves the right to change any specifications and product configurations at its discretion, without prior notice and without obligation to include such changes in this manual.

## **TRADEMARKS**

Wacom is a registered trademark. Intuos, Tool ID, QuickPoint, DuoSwitch, and DualTrack are trademarks of Wacom Company, Limited in the United States and/or other countries. Acrobat® Reader Copyright © 1987-1997 Adobe Systems Incorporated. All rights reserved. Adobe, Acrobat, and Photoshop are trademarks of Adobe Systems Incorporated which may be registered in certain jurisdictions. MetaCreations and Painter are either registered trademarks or trademarks of MetaCreations Corporation. Apple, the Apple logo, and Macintosh are registered trademarks of Apple Computer, Inc., registered in the U.S. and other countries. Any additional company and product names mentioned in this documentation may be trademarked and/or registered as trademarks. Mention of third-party products is for information purposes only and constitutes neither an endorsement nor a recommendation. Wacom assumes no responsibility with regard to the performance or use of these products.

## RADIO AND TELEVISION INTERFERENCE

The equipment described in this manual generates, uses, and can radiate radio-frequency energy. If it is not installed and used properly—that is, in strict accordance with Wacom Instructions—it may cause interference with radio and television reception.

### FCC NOTICE

This equipment has been tested and found to comply with the limits for a Class B digital device in accordance with the specifications in Part 15 of FCC rules. These specifications are designed to provide reasonable protection against such interference in a residential installation. However, there is no guarantee that interference will not occur in a particular installation.

You can determine whether your tablet is causing interference by disconnecting it from the computer. If the interference stops, it was probably caused by the tablet.

If your tablet does cause interference to radio or television reception, try to correct the interference by using one or more of the following measures:

- Rotate the television or radio antenna until the interference stops.
  - Move the tablet farther away from the television or radio.
  - Plug the computer into an outlet that is on a different circuit from the television or radio.
- If necessary, consult your authorized Wacom dealer or an experienced radio/television technician for additional suggestions. Changes or modifications to this product not authorized by Wacom could void the FCC Certification and negate your authority to operate the product.

This product was tested for FCC compliance under conditions that included the use of shielded cables and connectors between system components. It is important that you use shielded cables and connectors to reduce the possibility of causing interference to radios, television sets, and other electronic devices.

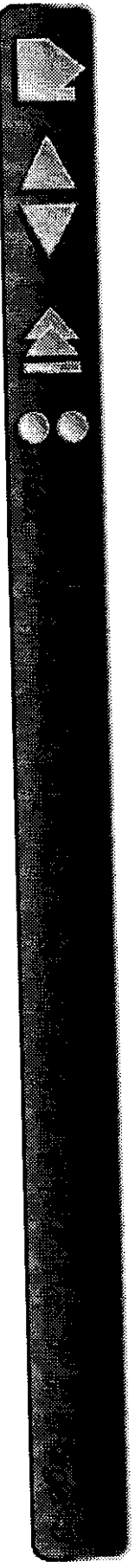

## CE DECLARATION

The Intuos™ digitizing tablets, models ~~GD-0405-A, GD-0608-A, GD-0912-A, GD-1212-B, GD-1218-B~~, GD-0405-U, GD-0608-U, GD-0912-U, GD-1212-U, and GD-1218-U have been tested by the ~~WAVE Corporation~~ in Japan and found to comply to the following harmonized European Norms:

- EN 50082-1 (electromagnetic immunity)
- EN 55022 Class B (electromagnetic emissions)

~~The Wacom power adaptors have been tested by their manufacturers and found to comply to the following harmonized~~

~~European Norms:~~

- EN 50082-1 or EN 55104 (electromagnetic immunity)
- EN 50081-1 or EN 55014 (electromagnetic emissions)
- EN 60742 (safety of low voltage devices)

Based on the results of these tests, Wacom declares that the above mentioned devices conform to Article 10.1 of the European Council Directive 89/336/EEC and to the European Council Directive 73/23/EEC, and indicates this conformity by the CE-sign on each device.

The device must be installed and operated always in strict accordance to the instructions given in this handbook. Any changes or modifications to this product that were not specifically authorized by Wacom will invalidate this declaration.

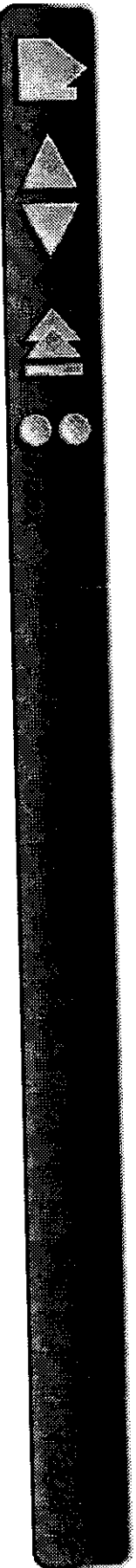

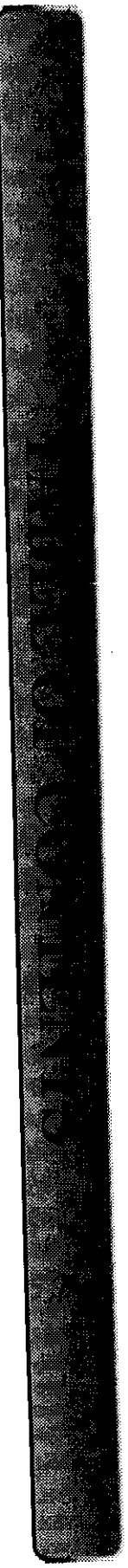

Trademarks	2	<del>Using the Pen</del>	29
Radio and Television Interference	3	<del>Holding the Pen</del>	29
FCC Notice	3	<del>Pointing</del>	30
CE Declaration	4	<del>Clicking</del>	31
About the Manual	8	<del>Using the Side Switch</del>	32
Navigating the Manual	10	<del>Dragging</del>	38
<b>INSTALLATION</b>	11	<del>Proximity</del>	34
ADB Tablet Installation	12	<del>Drawing with Pressure</del>	35
Serial Tablet Installation	13	<del>Drawing with Tilt</del>	36
USB Tablet Installation	14	<del>Erasing</del>	37
iMac Requirements	15	<del>Eye-Hand Coordination Exercise</del>	38
Uninstalling the Software	16	<del>Using the Airbrush</del>	39
Registration	16	<del>Holding the Airbrush</del>	40
Product Information	16	<del>Using the 4D Mouse</del>	41
<b>USING INTUOS</b>	17	<del>Setting Right- or Left-Handed Operation</del>	42
Appearance and Features	18	<del>Using the 4D Mouse Thumbwheel</del>	43
Intuos 4x5A6 Tablet	18	<del>Using the Lens Cursor</del>	44
Intuos 6x8A5 and 9x12A4 Regular Tablets	19	<del>Caring for Your Tools and Tablet</del>	45
Intuos 12x12A4 Oversize and 12x18A3 Tablets	20	<del>Replacing the Pen or Airbrush Tip</del>	46
Intuos Tools	21	<b>CUSTOMIZING</b>	47
Setting Up Your Work Area	24	<del>Opening the Control Panel</del>	48
<del>Working with the Tablet</del>	25	<del>Control Panel Features</del>	49
<del>  Adjusting the Pen Stand</del>	25	<del>  Tabs</del>	50
<del>  Adjusting Tablet Incline</del>	26	<del>  Control Panel Lists</del>	52
<del>  Using The Tablet Menu Strip</del>	27	<del>  Control Panel Buttons</del>	53

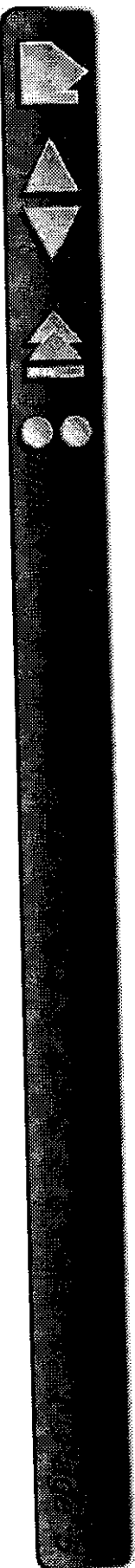

<del>Resolving Software Conflicts</del>	<del>117</del>
<del>Using the Extensions Manager</del>	<del>117</del>
<del>Manually Resolving a Conflict</del>	<del>118</del>
<del>Testing Your Intuos Tools</del>	<del>121</del>
<del>Testing a Pen or Airbrush</del>	<del>121</del>
<del>Testing a 4D Mouse or Lens Cursor</del>	<del>123</del>
<del>Troubleshooting Tables</del>	<del>124</del>
<del>ADB Tablet Problems</del>	<del>124</del>
<del>Serial Tablet Problems</del>	<del>125</del>
<del>USB Tablet Problems</del>	<del>127</del>
<del>General Problems</del>	<del>128</del>
<del>Contacting Technical Support</del>	<del>133</del>
<del>Linking to the Web Page</del>	<del>138</del>
<del>Pre-Contact Checklist</del>	<del>138</del>
<del>Who to Call</del>	<del>134</del>
<del>USA, Canada, Central and South America</del>	<del>135</del>
<del>Europe, Middle East and Africa</del>	<del>136</del>
<del>Japan</del>	<del>137</del>
<del>Asia Pacific (English)</del>	<del>137</del>
<del>Europe, Middle East and Africa</del>	<del>138</del>
<del>USA, Canada, Central and South America</del>	<del>139</del>
<del>Japan</del>	<del>140</del>
<del>Asia Pacific (English)</del>	<del>140</del>
<b>APPENDICES</b>	
<del>Installing Multiple Tablets</del>	<del>141</del>
<del>Product Specifications</del>	<del>143</del>
<del>General Specifications for All Intuos Tablets</del>	<del>143</del>
<del>Intuos 4x5A6 Tablet (Models GD-0405-A, GD-0405-U)</del>	<del>144</del>
<del>Intuos 6x8A5 Tablet (Models GD-0608-A, GD-0608-U)</del>	<del>144</del>

<del>Intuos 9x12A4 Regular Tablet (Models GD-0912-A, GD-0912-U)</del>	<del>145</del>
<del>Intuos 12x12A4 Oversize Tablet (Models GD-1212-R, GD-1212-U)</del>	<del>145</del>
<del>Intuos 12x18A3 Tablet (Models GD-1218-R, GD-1218-U)</del>	<del>145</del>
<del>Intuos Pen (Model GP-300E)</del>	<del>146</del>
<del>Intuos Airbrush (Model GP-400E)</del>	<del>146</del>
<del>Intuos Inking Pen (Model GP-110)</del>	<del>146</del>
<del>Intuos Stroke Pen (Model GP-120)</del>	<del>147</del>
<del>Intuos 4D Mouse (Model GC-500)</del>	<del>147</del>
<del>Intuos Lens Cursor (Model GC-210)</del>	<del>147</del>
<del>Parts and Accessories</del>	<del>148</del>
<del>Ordering Parts and Accessories</del>	<del>148</del>
<del>Pens</del>	<del>148</del>
<del>Airbrush</del>	<del>149</del>
<del>4D Mouse</del>	<del>149</del>
<del>Lens Cursor</del>	<del>149</del>
<del>Other Parts and Accessories</del>	<del>150</del>
<del>License and Warranties</del>	<del>151</del>
<del>Software License</del>	<del>151</del>
<del>Limited Warranty</del>	<del>152</del>
<del>Warranty on Sales Outside of U.S. and Canada</del>	<del>154</del>
<del>License and Warranties</del>	<del>155</del>
<del>Software License Agreement</del>	<del>155</del>
<del>Limited Warranty and Liability</del>	<del>156</del>
<del>Liability of WACOM</del>	<del>157</del>
<b>GLOSSARY</b>	
<del>INDEX</del>	<del>158</del>

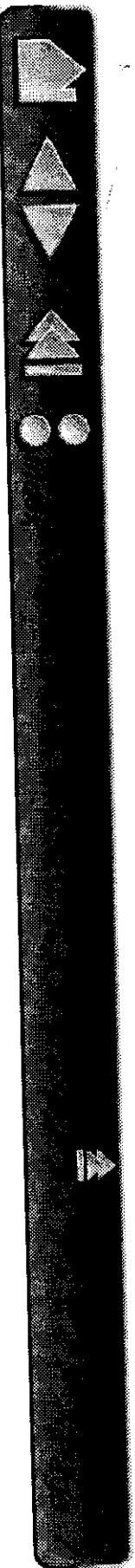

## ABOUT THE MANUAL

This interactive User's Manual provides quick access to information about Intuos. Just click on a navigation button or highlighted word to move through the document. The information is common to all tablet types (ADB, serial, and USB), unless otherwise noted.

- The Table of Contents enables you to go directly to a topic by clicking on it.
- Installation describes how to install the hardware and software, and how to uninstall the software.
- Using Intuos introduces you to the many capabilities of your Intuos system, including a description of the various tablet models, and the features and functions of each Intuos tool. This section also includes exercises for new users.
- Customizing describes how you can change the control panel settings to optimize Intuos tablets and tools for your personal work style.
- Advanced Features allow further customization of your Intuos Graphics Tablet System. Explore them after you have become familiar with using Intuos and the basic control panel settings.
- Having Trouble? Need troubleshooting guidelines? Do you have a question for Technical Support? You will find the answers to most common questions here.
- The Appendices include product specifications, license and warranty information, and a listing of replacement parts and accessories. If you are using more than one tablet on your computer, you will find instructions on adding and working with multiple tablets.

If you are new to electronic documentation, be sure to read Navigating the Manual.

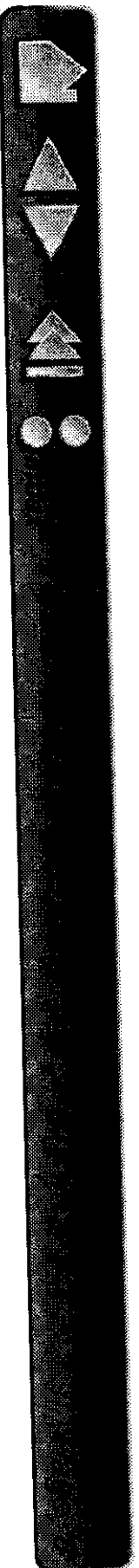

SMALL CAPITAL LETTERS are used to identify the names of keyboard keys, dialog boxes, and control panel options.

As you read through the *Customizing* and *Advanced Features* chapters, you will notice that the screen shots of the control panel tabs do not show the tab buttons. These are intentionally left out in order to save space within the manual.

Remember that you can always use the Acrobat Reader zoom-in tool to increase the size of the manual on your display screen.

Certain kinds of information are not included in this manual:

- Information about your specific computer hardware.
- Information about your operating system.
- Information about other Wacom tablets.
- Information about application software. Many graphics applications have built-in support for Intuos features (such as pressure-sensitivity, tilt, airbrush simulation, 3D navigation with the 4D Mouse, and two-handed input). You can find a listing of applications that support these features at Wacom's web site (see Product Information). Refer also to your application manuals for information on how best to use Intuos features within specific applications.

Your best source of information for the above information is the set of manuals and disks that came with your hardware, operating system, applications, or other Wacom tablets.

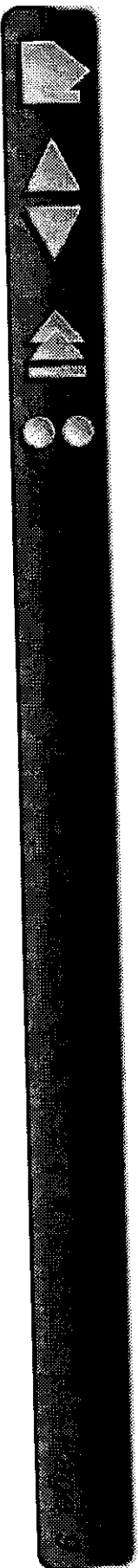



# NAVIGATING THE MANUAL

Use the navigation controls to move through the manual:



Go to front page.



Go to Table of Contents.



Go to Index.



Go back to previous view.



Page back, or page forward.



Go to beginning of section.



Go to topic.



Topic continued.

The Acrobat Reader provides you with additional tools for using and printing the manual. Refer to the *Acrobat Reader Online Guide* for more information.

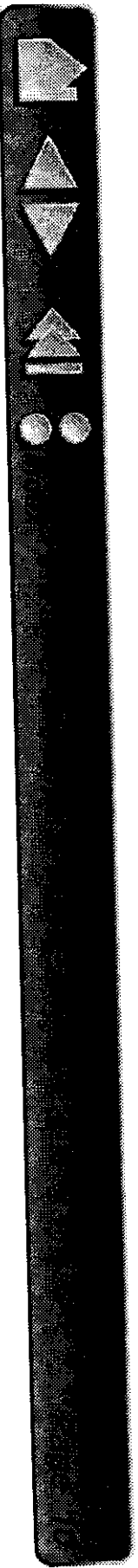

Intuos ADB and serial tablets are compatible with Macintosh systems using Mac OS 7.0 or later, and with all applications that support a mouse.

USB tablets are compatible with any Power Macintosh equipped with a USB port, and with all applications that support a mouse. For the iMac, you will need Mac OS 8.5 or greater, Mac OS ROM 1.2.1 or greater, and iMac Update 1.1.

The Wacom control panel requires a 640 x 480 or larger color monitor for proper display.

- ADB TABLET INSTALLATION**
- SERIAL TABLET INSTALLATION**
- USB TABLET INSTALLATION**
- UNINSTALLING THE SOFTWARE**
- REGISTRATION**

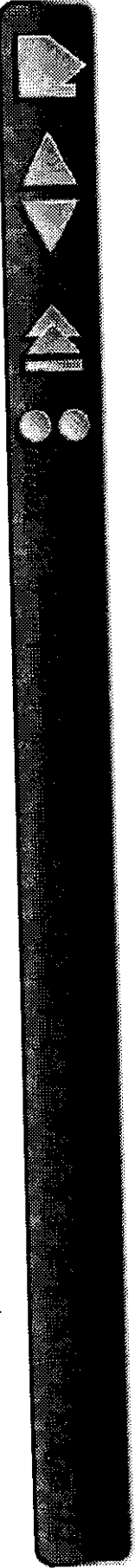

# USB TABLET INSTALLATION

Intuos USB tablets run in high-speed, high-power USB mode. The tablet must be plugged directly into a USB port on your computer or into a powered USB hub. USB ports support hot-plugging so you can connect or disconnect Intuos without turning off your computer.

If you are using an iMac, refer to the [iMac Requirements](#) section before installing Intuos.

1. Plug the USB connector into a USB port at the back of your computer or into a powered USB hub.
2. If your computer is off, turn it on now. The tablet LED will light to indicate Intuos has registered as a USB device. If the LED does not light, your USB port may not be functioning properly; go to [Having Trouble?](#)  
Intuos is working in mouse emulation mode. You should now be able to use your Intuos Pen on the tablet to move the screen cursor.  
**Important:** For pressure-sensitivity, you must install the tablet software from the Intuos CD-ROM. Disable any virus protection programs and close all open applications before installing the software.
3. Insert the Intuos CD-ROM into your computer.
4. Double-click on the INSTALL icon and follow the prompts.

After restarting your computer, you will be able to use the pen to move the screen cursor with absolute positioning. If you had any trouble with this installation, go to [Having Trouble?](#)

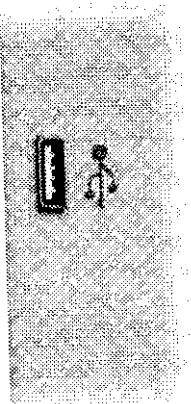

&&Cable image needs  
update for GD USB, filename  
USBcable.tif

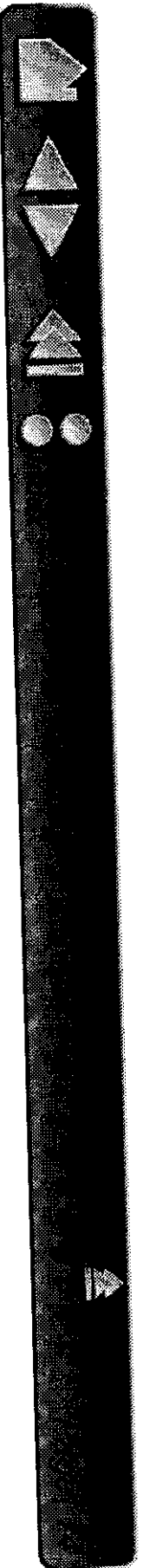

Each time you start your computer, the Wacom Tablet startup icon tells you if the tablet driver has successfully loaded.



The driver is loading.



The driver did not load.

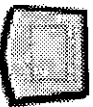

The driver has loaded successfully.



The driver loaded, but a Wacom tablet cannot be found. The tablet may be unplugged.

## IMAC REQUIREMENTS

Intuos requires Mac OS 8.5 or greater and Mac OS ROM 1.2.1 or greater.

1. **Verify the Mac OS and ROM versions:** Click on the Apple icon and select ABOUT THIS COMPUTER.... The ABOUT THIS COMPUTER dialog box will appear with the OS version displayed in the top right corner. Mac OS 8.5 or greater is required. If the version shown is older than Mac OS 8.5, contact your local computer dealer to purchase an upgrade. If Mac OS ROM version 1.2.1 or greater displays under the Mac OS version, your iMac does not need the firmware or OS ROM update. If it does not appear or an older Mac OS ROM is installed, continue with the instructions below to install the iMAC FIRMWARE UPDATE and then install iMAC UPDATE 1.1.
2. **Install the iMac Firmware Update:** In the APPLE iMAC UPDATES folder located on the Intuos CD-ROM, double-click on the iMAC FIRMWARE UPDATE icon. This will decompress the file. Then double-click on the iMAC FIRMWARE UPDATE icon that appears on the desktop and follow the prompts. If in doubt, install this update.
3. **Install iMac Update 1.1:** Install iMAC UPDATE 1.1 by double-clicking on the iMAC UPDATE 1.1 icon located in the APPLE iMAC UPDATES folder. This will decompress the file. Then double-click on the iMAC UPDATE icon that appears on the desktop and follow the prompts. If in doubt, install this update.
4. After updating your system, perform the [USB Tablet Installation](#).

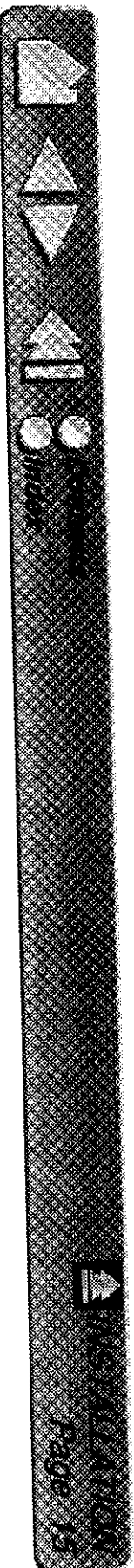

# UNINSTALLING THE SOFTWARE

To remove the Intuos software from your system:

1. Insert the Intuos CD-ROM into your computer and double-click on the INSTALL icon.
2. Select REMOVE instead of INSTALL.

## REGISTRATION

To register your product, please complete and mail in the Wacom Registration Card that came with your tablet.

Online registration may be available in some regions. If available, the Internet location will be printed on your Registration Card.

## PRODUCT INFORMATION

To learn more about which software applications currently support your Intuos tablet and tools, visit the Wacom web site for your region:

USA, Canada, Central and South America	<a href="http://www.wacom.com/productinfo">http://www.wacom.com/productinfo</a>
Europe, Middle East and Africa	<a href="http://www.wacom.de/productinfo">http://www.wacom.de/productinfo</a>
Japan	<a href="http://tablet.wacom.co.jp">http://tablet.wacom.co.jp</a>
Asia Pacific (English)	<a href="http://www.wacom.co.jp/asia-pacific">http://www.wacom.co.jp/asia-pacific</a>

To learn more about which software applications currently support your Intuos tablet and tools, visit the Wacom web site for your region:

Europe, Middle East and Africa	<a href="http://www.wacom.de/productinfo">http://www.wacom.de/productinfo</a>
USA, Canada, Central and South America	<a href="http://www.wacom.com/productinfo">http://www.wacom.com/productinfo</a>
Japan	<a href="http://tablet.wacom.co.jp">http://tablet.wacom.co.jp</a>
Asia Pacific (English)	<a href="http://www.wacom.co.jp/asia-pacific">http://www.wacom.co.jp/asia-pacific</a>

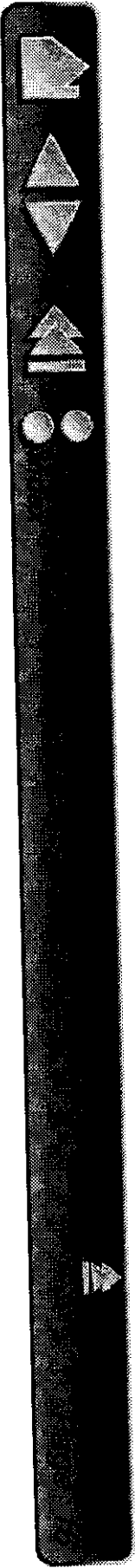

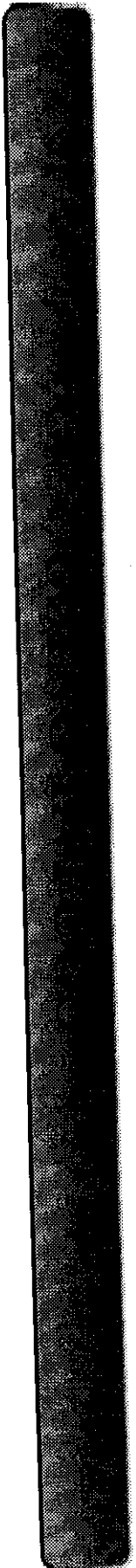

This section introduces you to the Intuos Graphics Tablet System. If you are new to using a graphics tablet and tablet input tools, read the following sections. They describe your Intuos tools and explain how to use them with the tablet.

**APPEARANCE AND FEATURES**

**SETTING UP YOUR WORK AREA**

**WORKING WITH THE TABLET**

**USING THE PEN**

**USING THE AIRBRUSH**

**USING THE 4D MOUSE**

**USING THE LENS CURSOR**

**CARING FOR YOUR TOOLS AND TABLET**

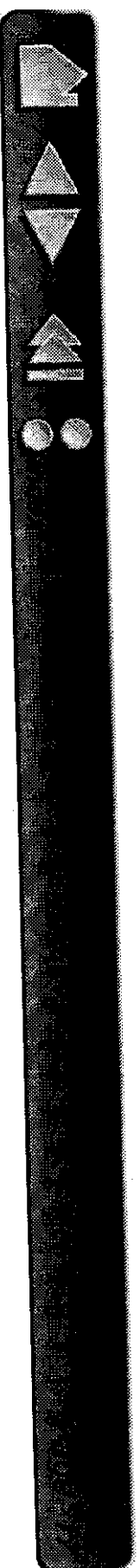

# APPEARANCE AND FEATURES

The Intuos Graphics Tablet System consists of two basic elements: a graphics tablet that serves as your work area, and the Intuos Tools you use with the tablet. For a complete listing of Intuos tablets, refer to Parts and Accessories.

## INTUOS 4X5A6 TABLET

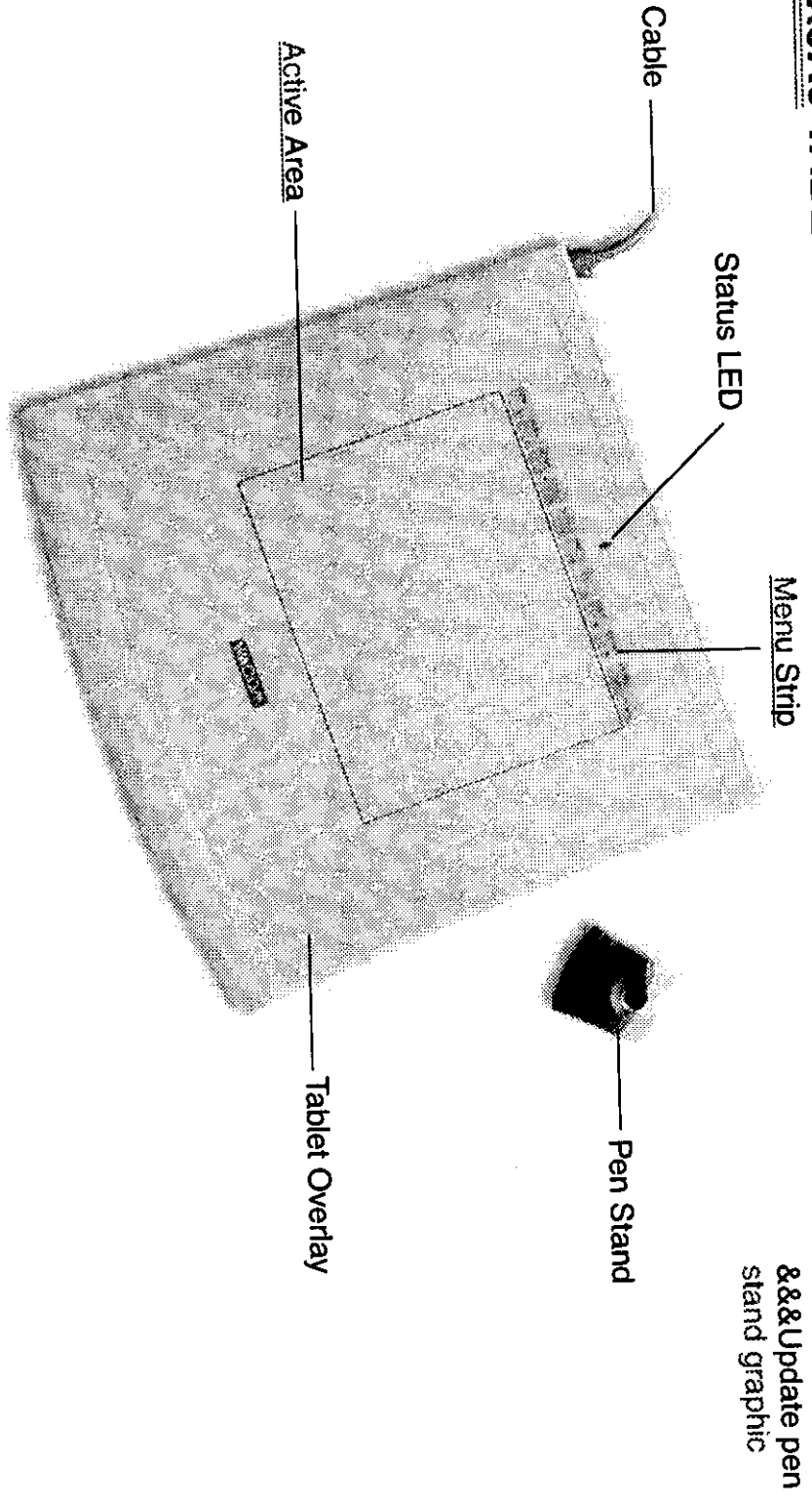

**Note:** To learn more about your tablet, see Working with the Tablet.

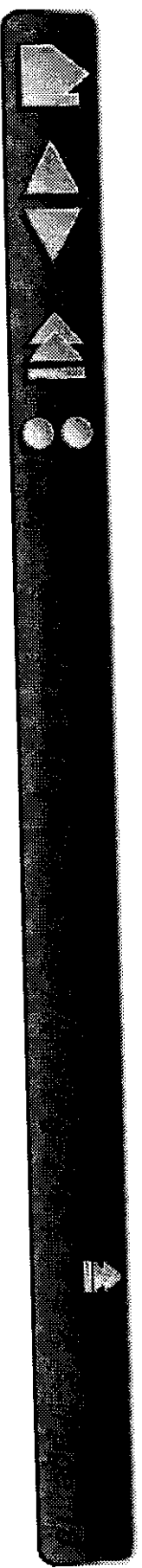

# INTUOS 6X8A5 AND 9X12A4 REGULAR TABLETS

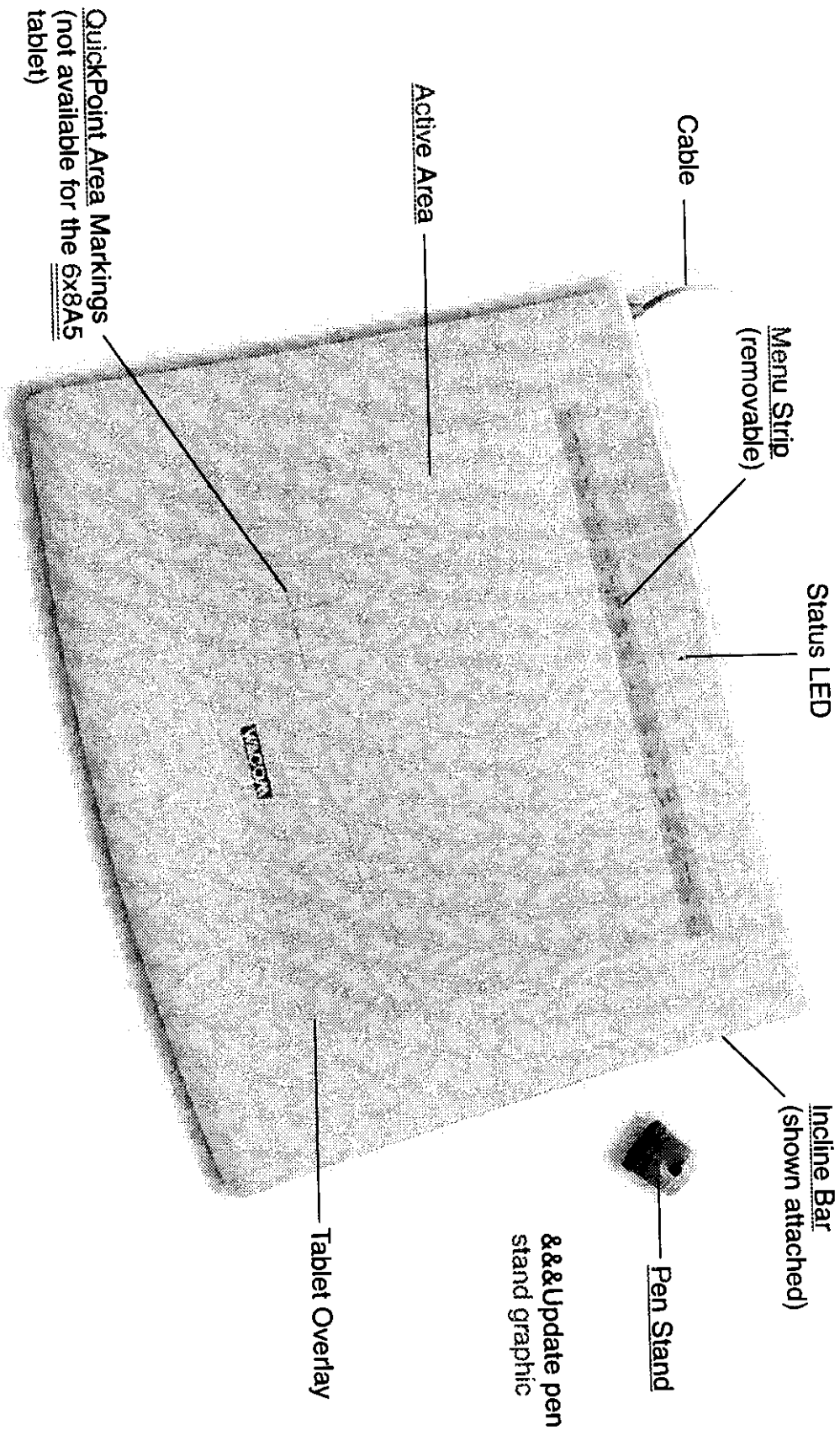

**Note:** The Intuos 9x12A4 regular tablet is shown. To learn more about your tablet, see Working with the Tablet.

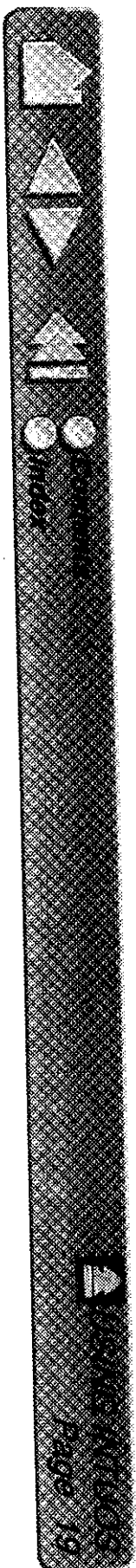



# INTUOS 12X12A4 OVERSIZE AND 12X18A3 TABLETS

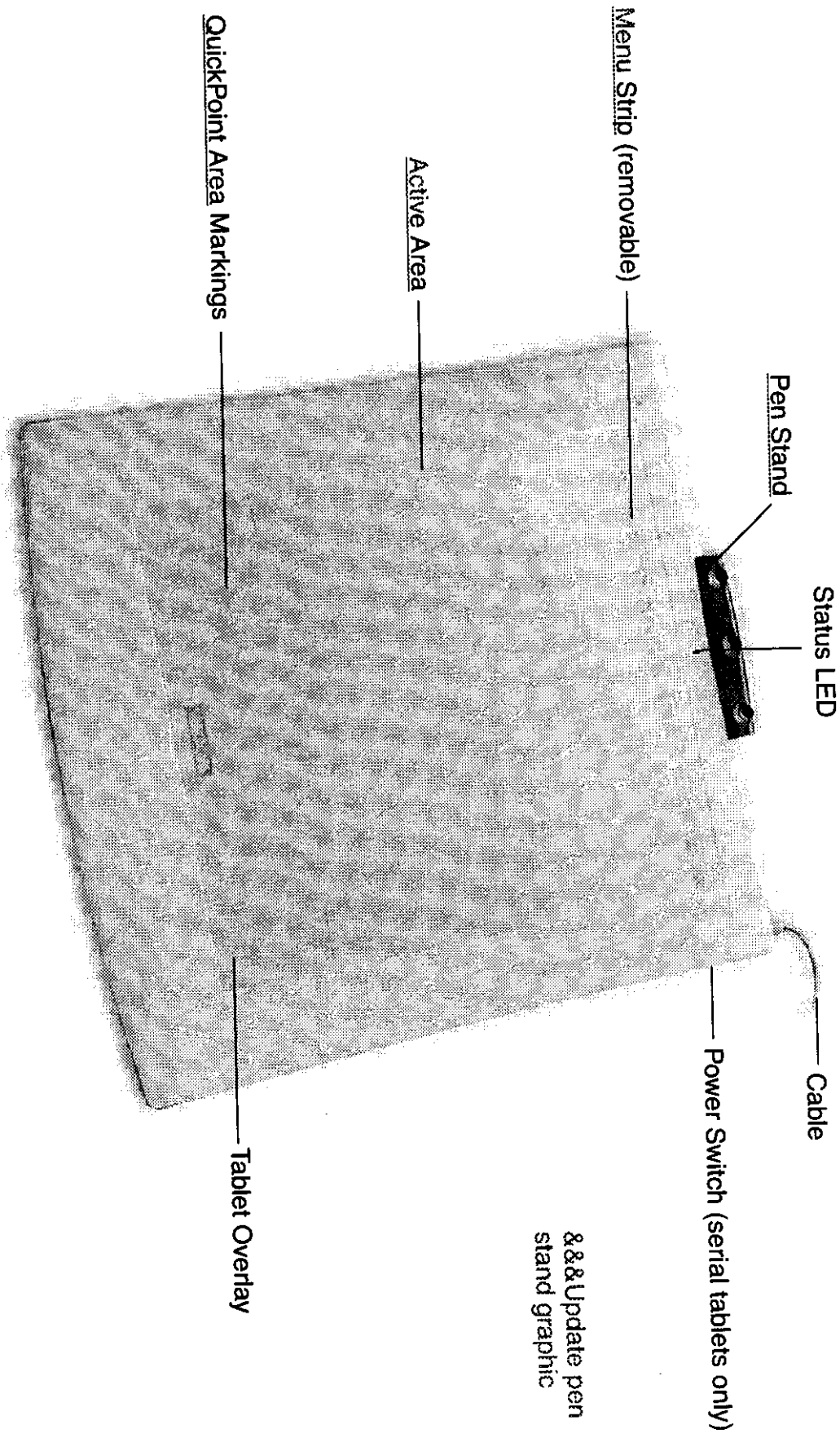

&& Update pen stand graphic

**Note:** The Intuos 12X12A4 oversize tablet is shown. To learn more about your tablet, see Working with the Tablet.

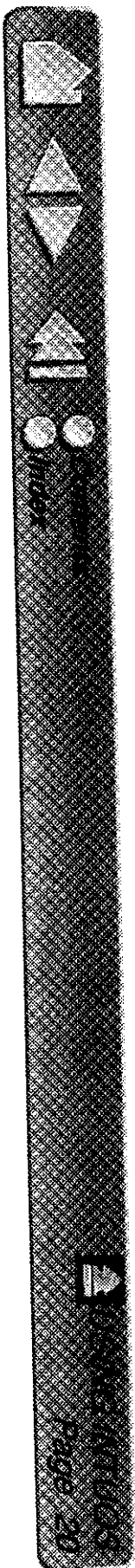

# INTUOS TOOLS

A variety of Intuos tools are available for your tablet. All Intuos tools are cordless, batteryless, and ergonomically designed. Each tool also has a Tool ID, enabling you to work with multiple tools on the same tablet and to customize each tool differently.

**Note:** The tool(s) included with your tablet will vary depending on which tablet model and configuration you purchased.

The Intuos Pen and Airbrush are pressure-sensitive freehand tools for image editing and creating natural-looking pen and brush strokes.

Apply the color-coded decals when using multiple pens with customized settings.

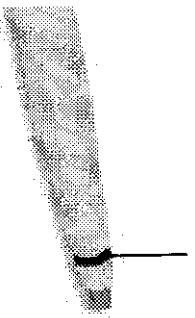

DuoSwitch (rocker style)

Replaceable Nib (pen tip)

Intuos Pen

Eraser

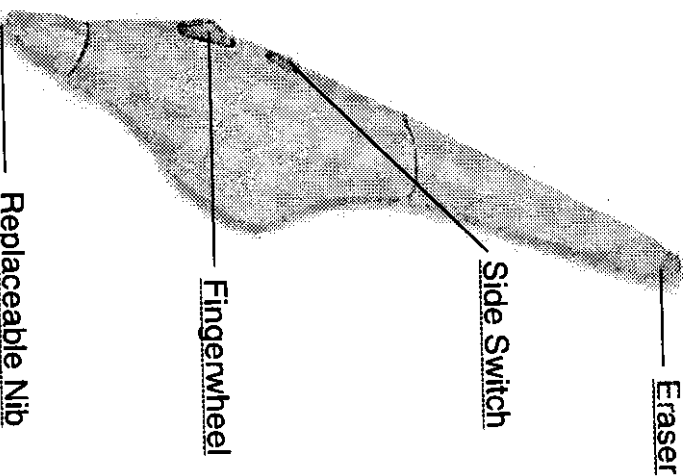

Intuos Airbrush

Replaceable Nib

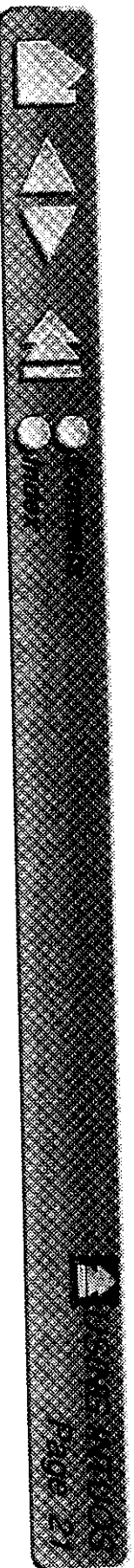

The Intuos 4D Mouse is an ideal tool for 2D or 3D navigation. It provides four degrees of control: x and y position, thumbwheel position, and positional rotation. The thumbwheel can be used for application-specific tasks in supporting applications.

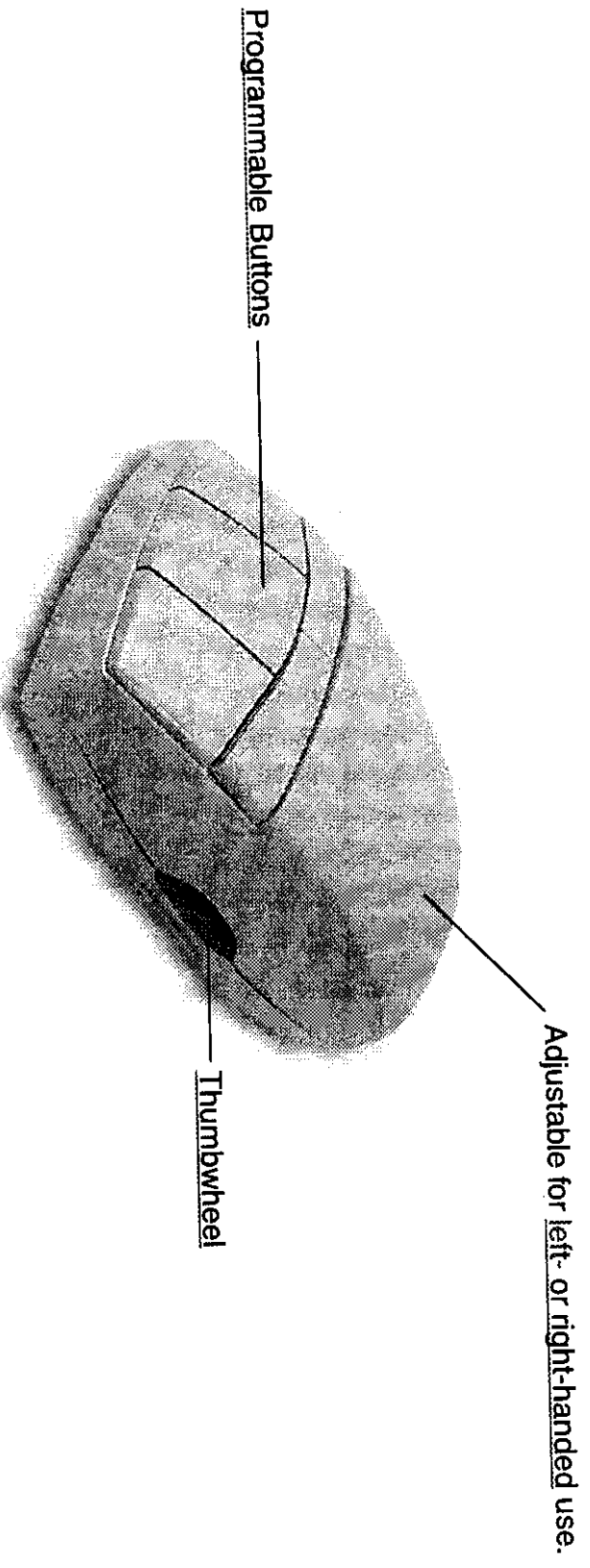

4D Mouse

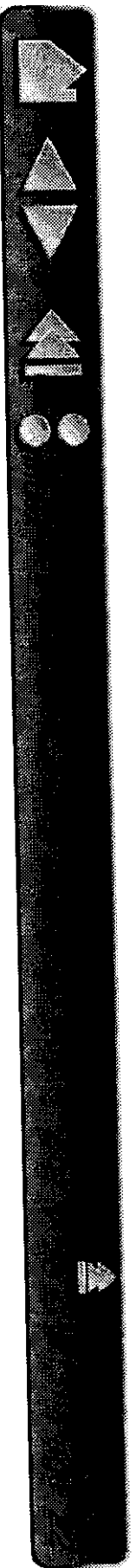

The Lens Cursor is an ideal tool for entering precise coordinate position information. Use the Lens Cursor with graphics and CAD applications for very accurate tracing or for digitizing images.

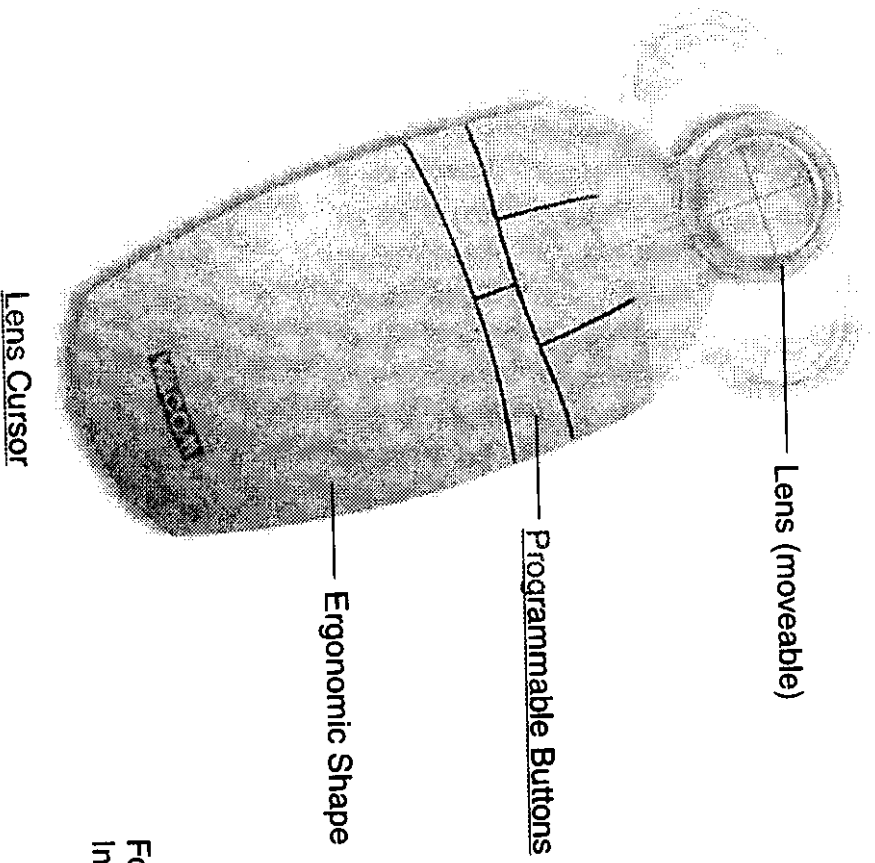

For information on these and other available Intuos tools, refer to [Parts and Accessories](#).

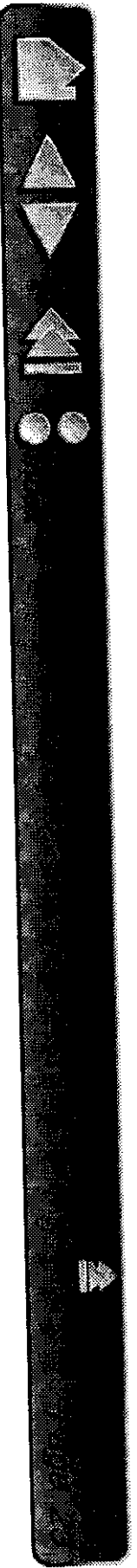

## SETTING UP YOUR WORK AREA

Organize your work area so you can work comfortably. Position your Intuos tablet, input tools, and keyboard so they are easily accessible without unnecessary reaching. Your monitor should be positioned so you can view it comfortably with a minimum of eyestrain.



To minimize fatigue:

- Take short breaks between tasks to stretch and relax your muscles.
- Use a gentle grip when working with your Intuos tools.
- Alternate tasks throughout the day.
- Minimize awkward postures and repetitive movements that cause discomfort.

For some tablet models, you can adjust the tablet incline and attach the pen stand to better fit your work style. Refer to [Adjusting Tablet Incline](#) and [Adjusting the Pen Stand](#) for additional information.

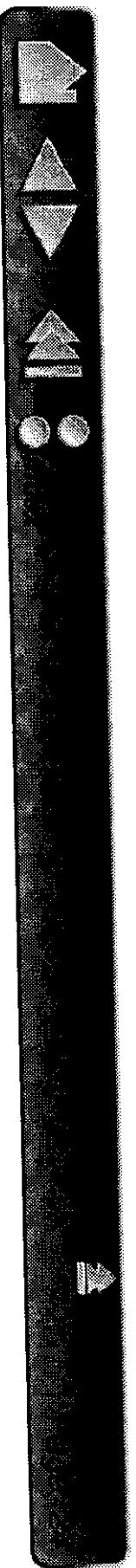

## **USA, Canada, Central and South America**

**Contact your local distributor, or:**

Worldwide Web: <http://www.wacom.com/productsupport>

24-hour Technical Support information:

Answerbook—online support database.

FAQs—Frequently Asked Questions and answers.

Software updates.

Email support.

Anonymous FTP Site: [ftp.wacom.com/pub/drivers](ftp://ftp.wacom.com/pub/drivers)

Software updates.

Phone: ++1-360-896-9833

Technical Support. (English)  
(Normal business hours, Pacific Time)

FAX: ++1-360-896-9724

Technical Support. (English)

Internet Email: [support@wacom.com](mailto:support@wacom.com)

Automated mailback support. (English)

Fast FAX: 1-800-922-7590 (USA and Canada)

Automated support and sales information.  
(English)

**To purchase parts and accessories, call toll-free: 1-888-884-1870 (USA and Canada only). Outside of the USA and Canada, please contact your local dealer or distributor.**

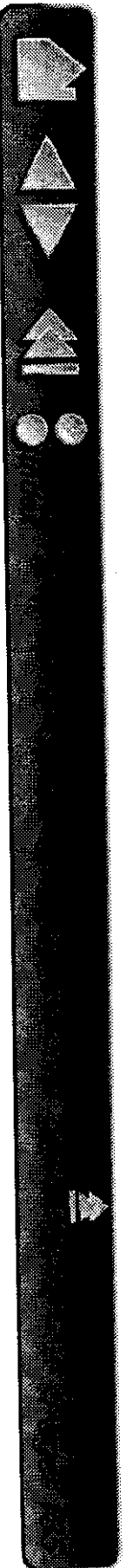

## **USA, Canada, Central and South America**

**Contact your local distributor, or:**

Worldwide Web: <http://www.wacom.com/productsupport>

24-hour Technical Support information:

Answerbook—online support database.

FAQs—Frequently Asked Questions and answers.

Software updates.

Email support.

---

Anonymous FTP Site: <ftp.wacom.com/pub/drivers>

Software updates.

---

Phone: ++1-360-896-9833

Technical Support. (English)

(Normal business hours, Pacific Time)

---

FAX: ++1-360-896-9724

Technical Support. (English)

---

Internet Email: [support@wacom.com](mailto:support@wacom.com)

Automated mailback support. (English)

---

Fast FAX: 1-800-922-7590 (USA and Canada)

Automated support and sales information.  
(English)



# PRODUCT SPECIFICATIONS

## GENERAL SPECIFICATIONS FOR ALL INTUOS TABLETS

Coordinate resolution	100 lppmm (2540 lpi)
Accuracy (pen)	+/- 0.25 mm (0.010 in)
Accuracy (Lens Cursor)	+/- 0.15 mm (0.006 in), +/- 0.25 mm (0.010 in) on Intuos <u>4x5A6</u> , <u>6x8A5</u> , and <u>9x12A4</u> regular tablets
Tilt	+/- 60 degrees, +/- 50 degrees for Intuos <u>4x5A6</u> tablets
Maximum reading height with pen	6 mm (0.24 in)
Maximum report rate	200 points per second
Communication interface	<del>Apple Desktop Bus (ADB) (for <u>4x5A6</u>, <u>6x8A5</u>, and <u>9x12A4</u> regular tablets)</del> <del>Serial (for <u>12x12A4</u> oversize and larger tablets)</del> USB (all USB tablets)
Connector	4 pin, mini-circular DIN (4x5A6, 6x8A5, and 9x12A4 regular tablets) <del>9-pin, D-sub, female (12x12A4 oversize and larger tablets)</del> USB A (all USB tablets)
<del>Power requirements (ADB tablets)</del>	<del>DC 5V, 100mA, from ADB port</del>
Power requirements (USB tablets)	DC 5V, less than 500mA, from primary USB port or powered USB hub
<del>Power supply (12x12A4 oversize and larger serial tablets)</del>	<del>DC 12V 200mA</del>
Power Adaptor(s) (12x12A4 oversize and larger serial tablets)	AEC-3512B-W (120V, USA), AD-3923FM-W (230V, Continental Europe), AD-4230S-W (240V, Australia), AD-7442-W (240V, UK)
Operating temperature	5 to 40 degrees C (41 to 104 degrees F)
Storage temperature	-10 to +60 degrees C (14 to 140 degrees F)
Operating relative humidity	20% to 80% noncondensing
Storage relative humidity	20% to 90% noncondensing
Certification	FCC class B

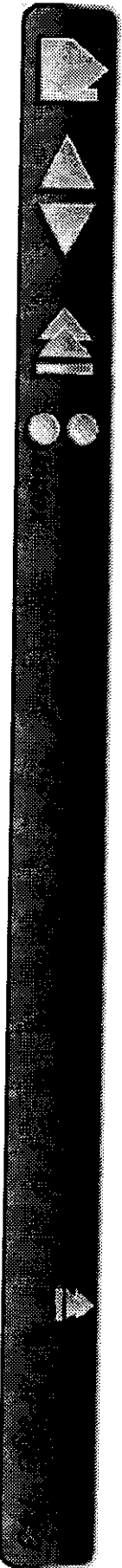
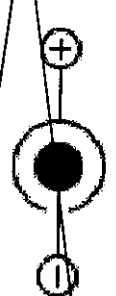



Compliance

VCCI Class B, CE

## **INTUOS 4X5A6 TABLET (MODELS GD-0405-A, GD-0405-U)**

Active area (W x D)	127.0 x 106.0 mm (5.0 x 4.24 in)
Physical size (W x D x H)	225.0 x 210.0 x 7.5 mm (9.0 x 8.4 x 0.29 in)
Cable length	2.5 m (8.2 ft)
Weight	540 g (1.19 lb)
Power consumption	<del>0.5 watts (ADB)</del> , 2.0 watts (USB)

## **INTUOS 6X8A5 TABLET (MODELS GD-0608-A, GD-0608-U)**

Active area (W x D)	203.2 x 162.4 mm (8.13 x 6.45 in)
Physical size (W x D x H)	334.0 x 258.0 x 14.0 mm (13.36 x 10.32 x 0.56 in)
Cable length	2.5 m (8.2 ft)
Weight	880 g (1.94 lb)
Power consumption	<del>0.5 watts (ADB)</del> , 2.0 watts (USB)

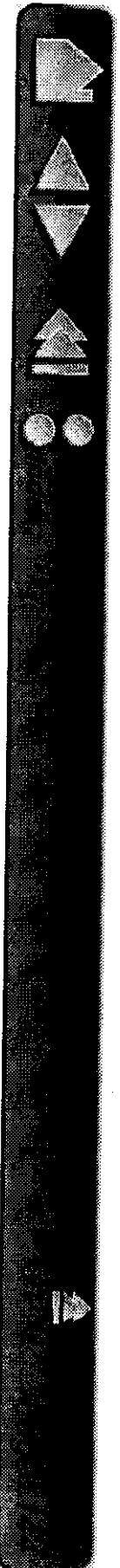

## **INTUOS 9X12A4 REGULAR TABLET (MODELS GD-0912-A, GD-0912-U)**

Active area (W x D)	304.8 x 240.6 mm (12.19 x 9.62 in)
Physical size (W x D x H)	456.0 x 361.0 x 14.0 mm (17.97 x 14.22 x 0.56 in)
Cable length	2.5 m (8.2 ft)
Weight	1.6 kg (3.52 lb)
Power consumption	<del>0.5 watts (ADB)</del> , 2.0 watts (USB)

## **INTUOS 12X12A4 OVERSIZE TABLET (MODELS GD-1212-R, GD1212-U)**

Active area (W x D)	304.8 x 316.8 mm (12.19 x 12.67 in)
Physical size (W x D x H)	444.0 x 435.5 x 37.0 mm (17.76 x 17.42 x 1.48 in)
Cable length	2.5 m (8.2 ft)
Weight	2.1 kg (4.62 lb)
Power consumption	<del>1.2 watts (Serial)</del> , 2.0 watts (USB)

## **INTUOS 12X18A3 TABLET (MODELS GD-1218-R, GD-1218-U)**

Active area (W x D)	457.2 x 316.8 mm (18.28 x 12.67 in)
Physical size (W x D x H)	616.0 x 445.5 x 37.0 (24.64 x 17.82 x 1.48 in)
Cable length	2.5 m (8.2 ft)
Weight	3.0 kg (6.6 lb)
Power consumption	<del>1.2 watts (Serial)</del> , 2.0 watts (USB)

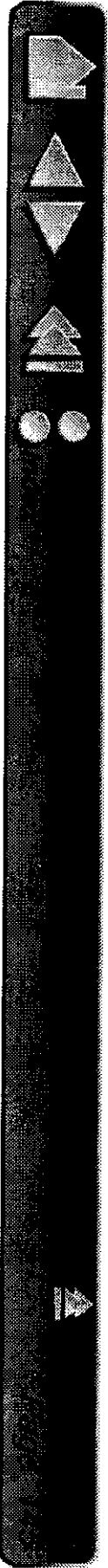

## **INTUOS PEN (MODEL GP-300E)**

Pen tip travel	0.1 mm (0.004 in) or less
Pressure levels	1024 levels
Eraser tip travel	1.3 mm (0.051 in), approximately
Physical size (L x D)	151 x 12.2 mm (5.9 x 0.48 in)
Weight	13 g (0.46 oz), approximately
Tip refill type	Polyacetal (Part No. PSI-A007)

## **INTUOS AIRBRUSH (MODEL GP-400E)**

Fingerwheel travel	10 mm (0.39 in)
Fingerwheel resolution	1024 levels
Pen tip travel	0.1 mm (0.04 in) or less
Pressure levels	1024 levels
Eraser tip travel	1.3 mm (0.05 in), approximately
Physical size (L x D)	162.5 x 32.6 mm (6.38 x 1.28 in)
Weight	24 g (0.85 oz), approximately
Tip refill type	Polyacetal (Part No. PSI-A007)

## **INTUOS INKING PEN (MODEL GP-110)**

Pen tip travel	0.1 mm (0.04 in) or less
Pressure levels	1024 levels
Physical size (L x D)	151 x 12.5 mm (5.94 x 0.49 in)
Weight	12 g (0.42 oz), approximately
Tip refill types	Polyacetal (Part No. PSI-A011) Ink refill, black (Part No. PSI-A023)



## **INTUOS STROKE PEN (MODEL GP-120)**

Pen tip travel	1.3 mm (0.05 in), approximately
Pressure levels	1024 levels
Physical size (L x D)	151 x 12.5 mm (5.94 x 0.49 in)
Weight	12 g (0.42 oz), approximately
Tip refill type	Polyacetal (Part No. PSI-A011)

## **INTUOS 4D MOUSE (MODEL GC-500)**

Physical size (L x D x H)	113.5 x 72.6 x 38.5 mm (4.47 x 2.86 x 1.52 in)
Weight	75 g (2.65 oz), approximately
Button stroke	1 mm (0.04 in), approximately
Thumbwheel travel	+/- 10 mm (+/- 0.4 in)
Thumbwheel resolution	+/- 1023 levels

## **INTUOS LENS CURSOR (MODEL GC-210)**

Physical size (L x D x H)	158.9 x 66.1 x 33.0 mm (6.29 x 2.60 x 0.79 in)
Weight	72 g (2.54 oz), approximately
Button stroke	1 mm (0.04 in), approximately

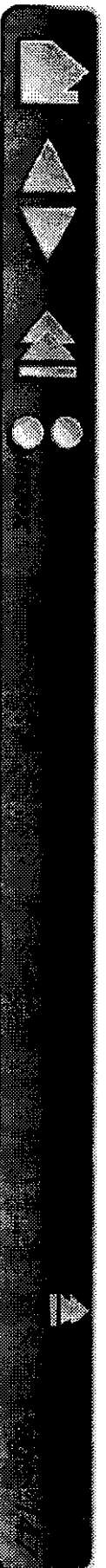

# intuos™

USER'S MANUAL FOR MACINTOSH®

Introduction

Contents

Index

WACOM



Wacom Intuos™ User's Manual for Macintosh®, March 25, 1999

English V2.0 for MacintoshEuropean English V2.0 for Macintosh

Copyright © Wacom Company, Limited, 1999

All rights reserved. No part of this manual may be reproduced except for your express personal use. Wacom reserves the right to revise this publication without obligation to provide notification of such changes. Wacom does its best to provide current and accurate information in this manual. However, Wacom reserves the right to change any specifications and product configurations at its discretion, without prior notice and without obligation to include such changes in this manual.

## TRADEMARKS

Wacom is a registered trademark. Intuos, Tool ID, QuickPoint, DuoSwitch, and DualTrack are trademarks of Wacom Company, Limited in the United States and/or other countries. Acrobat® Reader Copyright © 1987-1997 Adobe Systems Incorporated. All rights reserved. Adobe, Acrobat, and Photoshop are trademarks of Adobe Systems Incorporated which may be registered in certain jurisdictions. MetaCreations and Painter are either registered trademarks or trademarks of MetaCreations Corporation. Apple, the Apple logo, and Macintosh are registered trademarks of Apple Computer, Inc., registered in the U.S. and other countries. Any additional company and product names mentioned in this documentation may be trademarked and/or registered as trademarks. Mention of third-party products is for information purposes only and constitutes neither an endorsement nor a recommendation. Wacom assumes no responsibility with regard to the performance or use of these products.

## **RADIO AND TELEVISION INTERFERENCE**

The equipment described in this manual generates, uses, and can radiate radio-frequency energy. If it is not installed and used properly—that is, in strict accordance with Wacom instructions—it may cause interference with radio and television reception.

### **FCC NOTICE**

This equipment has been tested and found to comply with the limits for a Class B digital device in accordance with the specifications in Part 15 of FCC rules. These specifications are designed to provide reasonable protection against such interference in a residential installation. However, there is no guarantee that interference will not occur in a particular installation.

You can determine whether your tablet is causing interference by disconnecting it from the computer. If the interference stops, it was probably caused by the tablet.

If your tablet does cause interference to radio or television reception, try to correct the interference by using one or more of the following measures:

- Rotate the television or radio antenna until the interference stops.
- Move the tablet farther away from the television or radio.
- Plug the computer into an outlet that is on a different circuit from the television or radio.

If necessary, consult your authorized Wacom dealer or an experienced radio/television technician for additional suggestions. Changes or modifications to this product not authorized by Wacom could void the FCC Certification and negate your authority to operate the product.

This product was tested for FCC compliance under conditions that included the use of shielded cables and connectors between system components. It is important that you use shielded cables and connectors to reduce the possibility of causing interference to radios, television sets, and other electronic devices.

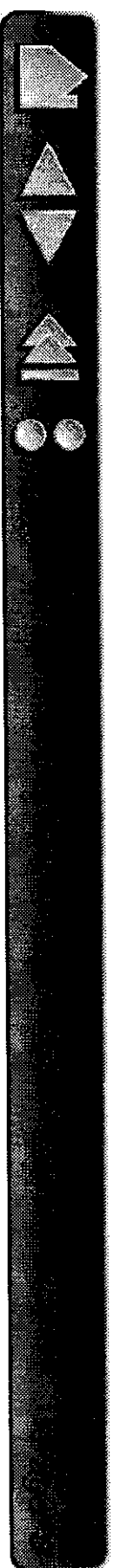

## CE DECLARATION

The Intuos™ digitizing tablets, models ~~GD-0405-A, GD-0608-A, GD-0912-A, GD-1212-R, GD-1218-R, GD-1218-B, GD-0405-U, GD-0608-U, GD-0912-U, GD-1212-U, and GD-1218-U~~ have been tested by ~~the WACOM Corporation~~ in Japan and found to comply to the following harmonized European Norms:

- EN 50082-1 (electromagnetic immunity)
- EN 55022 Class B (electromagnetic emissions)

~~The Wacom power adaptors have been tested by their manufacturers and found to comply to the following harmonized European Norms:~~

- EN 50082-1 or EN 55104 (electromagnetic immunity)
- EN 50081-1 or EN 55014 (electromagnetic emissions)
- EN 60742 (safety of low voltage devices)

Based on the results of these tests, Wacom declares that the above mentioned devices conform to Article 10.1 of the European Council Directive 89/336/EEC and to the European Council Directive 73/23/EEC, and indicates this conformity by the CE-sign on each device.

The device must be installed and operated always in strict accordance to the instructions given in this handbook. Any changes or modifications to this product that were not specifically authorized by Wacom will invalidate this declaration.

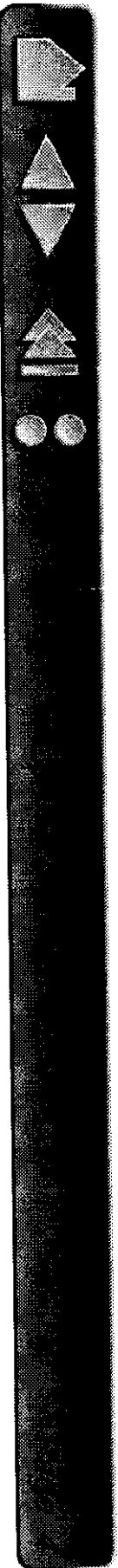



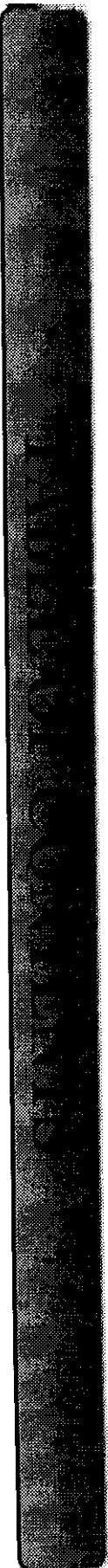

<u>Trademarks</u>	2
<u>Radio and Television Interference</u>	3
<u>FCC Notice</u>	3
<u>CE Declaration</u>	4
<u>About the Manual</u>	8
<u>Navigating the Manual</u>	10
<b>INSTALLATION</b>	11
<u>ADB Tablet Installation</u>	12
<u>Serial Tablet Installation</u>	13
<u>USB Tablet Installation</u>	14
<u>iMac Requirements</u>	15
<u>Uninstalling the Software</u>	16
<u>Registration</u>	16
<u>Product Information</u>	16
<b>USING INTUOS</b>	17
<u>Appearance and Features</u>	18
<u>Intuos 4x5A6 Tablet</u>	18
<u>Intuos 6x8A5 and 9x12A4 Regular Tablets</u>	19
<u>Intuos 12x12A4 Oversize and 12x18A3 Tablets</u>	20
<u>Intuos Tools</u>	21
<u>Setting Up Your Work Area</u>	24
<u>Working with the Tablet</u>	25
<u>Adjusting the Pen Stand</u>	25
<u>Adjusting Tablet Joints</u>	26
<u>Using the Tablet Menu Strip</u>	27
<u>Using the Pen</u>	29
<u>Holding the Pen</u>	29
<u>Pointing</u>	30
<u>Clicking</u>	31
<u>Using the Side Switch</u>	32
<u>Dragging</u>	33
<u>Proximity</u>	34
<u>Drawing with Pressure</u>	35
<u>Drawing with Tilt</u>	36
<u>Erasing</u>	37
<u>Eye-Hand Coordination Exercise</u>	38
<u>Using the Airbrush</u>	39
<u>Holding the Airbrush</u>	40
<u>Using the 4D Mouse</u>	41
<u>Setting Right- or Left-Handed Operation</u>	42
<u>Using the 4D Mouse Thumbwheel</u>	43
<u>Using the Lens Cursor</u>	44
<u>Caring for Your Tools and Tablet</u>	45
<u>Replacing the Pen or Airbrush Tip</u>	46
<b>CUSTOMIZING</b>	47
<u>Opening the Control Panel</u>	48
<u>Control Panel Features</u>	49
<u>Control Panel Lists</u>	50
<u>Control Panel Buttons</u>	51
<u>Control Panel Buttons</u>	52
<u>Control Panel Buttons</u>	53

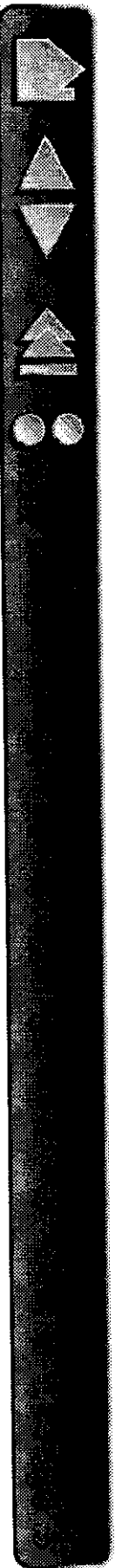

<u>Resolving Software Conflicts</u>	117
Using the Extensions Manager	117
Manually Resolving a Conflict	118
Testing Your Intuos Tools	121
Testing a Pen or Airbrush	121
Testing a 4D Mouse or Lens Cursor	123
<u>Troubleshooting Tables</u>	124
ADB Tablet Problems	124
Serial Tablet Problems	125
USB Tablet Problems	127
General Problems	128
<u>Contacting Technical Support</u>	133
Linking to the Web Page	133
Pre-Contact Checklist	133
Who to Call	134
USA, Canada, Central and South America	135
Europe, Middle East and Africa	136
Japan	137
Asia Pacific (English)	137
Europe, Middle East and Africa	138
USA, Canada, Central and South America	139
Japan	140
Asia Pacific (English)	140
<b>APPENDICES</b>	141
<u>Installing Multiple Tablets</u>	142
Product Specifications	143
General Specifications for All Intuos Tablets	143
Intuos 4x5A6 Tablet (Models GD-0405-A, GD-0405-U)	144
Intuos 6x8A5 Tablet (Models GD-0608-A, GD-0608-U)	144

<u>Intuos 9x12A4 Regular Tablet (Models GD-0912-A, GD-0912-U)</u>	145
<u>Intuos 12x12A4 Oversize Tablet (Models GD-1212-R, GD1212-U)</u>	145
<u>Intuos 12x18A3 Tablet (Models GD-1218-R, GD-1218-U)</u>	145
<u>Intuos Pen (Model GP-300E)</u>	146
<u>Intuos Airbrush (Model GP-400E)</u>	146
<u>Intuos Inking Pen (Model GP-110)</u>	146
<u>Intuos Stroke Pen (Model GP-120)</u>	147
<u>Intuos 4D Mouse (Model GC-500)</u>	147
<u>Intuos Lens Cursor (Model GC-210)</u>	147
<u>Parts and Accessories</u>	148
<u>Ordering Parts and Accessories</u>	148
Pens	148
Airbrush	149
4D Mouse	149
Lens Cursor	149
Other Parts and Accessories	150
License and Warranties	151
Software License	151
Limited Warranty	152
Warranty on Sales Outside of U.S. and Canada	154
License and Warranties	155
Software License Agreement	155
Limited Warranty and Liability	156
Liability of WACOM	157
<b>GLOSSARY</b>	158
<b>INDEX</b>	162

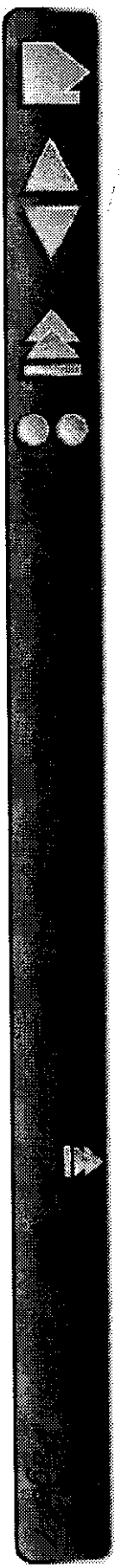

## ABOUT THE MANUAL

This interactive User's Manual provides quick access to information about Intuos. Just click on a navigation button or highlighted word to move through the document. The information is common to all tablet types (ADB, serial, and USB), unless otherwise noted.

- The Table of Contents enables you to go directly to a topic by clicking on it.
- Installation describes how to install the hardware and software, and how to uninstall the software.
- Using Intuos introduces you to the many capabilities of your Intuos system, including a description of the various tablet models, and the features and functions of each Intuos tool. This section also includes exercises for new users.
- Customizing describes how you can change the control panel settings to optimize Intuos tablets and tools for your personal work style.
- Advanced Features allow further customization of your Intuos Graphics Tablet System. Explore them after you have become familiar with using Intuos and the basic control panel settings.
- Having Trouble? Need troubleshooting guidelines? Do you have a question for Technical Support? You will find the answers to most common questions here.
- The Appendices include product specifications, license and warranty information, and a listing of replacement parts and accessories. If you are using more than one tablet on your computer, you will find instructions on adding and working with multiple tablets.

If you are new to electronic documentation, be sure to read Navigating the Manual.

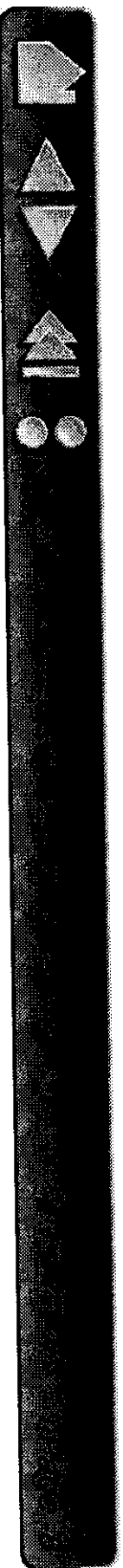

SMALL CAPITAL LETTERS are used to identify the names of keyboard keys, dialog boxes, and control panel options.

As you read through the *Customizing* and *Advanced Features* chapters, you will notice that the screen shots of the control panel tabs do not show the tab buttons. These are intentionally left out in order to save space within the manual.

Remember that you can always use the Acrobat Reader zoom-in tool to increase the size of the manual on your display screen.

Certain kinds of information are not included in this manual:

- Information about your specific computer hardware.
- Information about your operating system.
- Information about other Wacom tablets.
- Information about application software. Many graphics applications have built-in support for Intuos features (such as pressure-sensitivity, tilt, airbrush simulation, 3D navigation with the 4D Mouse, and two-handed input). You can find a listing of applications that support these features at Wacom's web site (see [Product Information](#)). Refer also to your application manuals for information on how best to use Intuos features within specific applications.

Your best source of information for the above information is the set of manuals and disks that came with your hardware, operating system, applications, or other Wacom tablets.

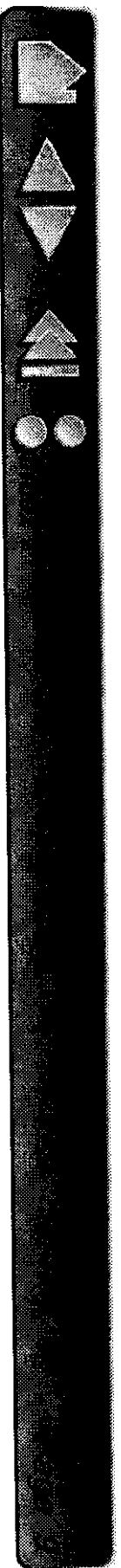

# NAVIGATING THE MANUAL

Use the navigation controls to move through the manual:



Go to front page.



Go to Table of Contents.



Go to Index.



Go back to previous view.



Page back, or page forward.



*HEADING TEXT*

Go to beginning of section.

Topic

Go to topic.



Topic continued.

The Acrobat Reader provides you with additional tools for using and printing the manual. Refer to the *Acrobat Reader Online Guide* for more information.

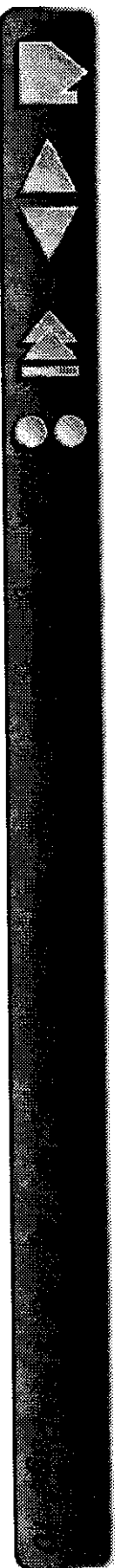



Intuos ADB and serial tablets are compatible with Macintosh systems using Mac OS 7.0 or later, and with all applications that support a mouse.

USB tablets are compatible with any Power Macintosh equipped with a USB port, and with all applications that support a mouse. For the iMac, you will need Mac OS 8.5 or greater, Mac OS ROM 1.2.1 or greater, and iMac Update 1.1.

The Wacom control panel requires a 640 x 480 or larger color monitor for proper display.

**ADB TABLET INSTALLATION**

**SERIAL TABLET INSTALLATION**

**USB TABLET INSTALLATION**

**UNINSTALLING THE SOFTWARE**

**REGISTRATION**

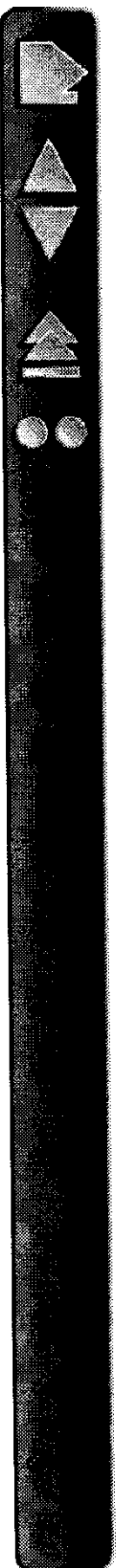

# USB TABLET INSTALLATION

Intuos USB tablets run in high-speed, high-power USB mode. The tablet must be plugged directly into a USB port on your computer or into a powered USB hub. USB ports support hot-plugging so you can connect or disconnect Intuos without turning off your computer.

If you are using an iMac, refer to the [iMac Requirements](#) section before installing Intuos.

1. Plug the USB connector into a USB port at the back of your computer or into a powered USB hub.
2. If your computer is off, turn it on now. The tablet LED will light to indicate Intuos has registered as a USB device. If the LED does not light, your USB port may not be functioning properly; go to [Having Trouble?](#)  
Intuos is working in mouse emulation mode. You should now be able to use your Intuos Pen on the tablet to move the screen cursor.  
*Important:* For pressure-sensitivity, you must install the tablet software from the Intuos CD-ROM. Disable any virus protection programs and close all open applications before installing the software.
3. Insert the Intuos CD-ROM into your computer.
4. Double-click on the INSTALL icon and follow the prompts.

After restarting your computer, you will be able to use the pen to move the screen cursor with absolute positioning. If you had any trouble with this installation, go to [Having Trouble?](#)

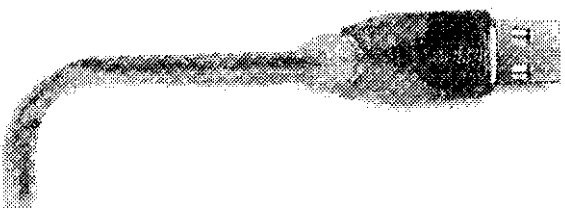
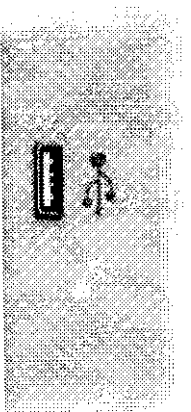

To tablet

&&&Cable image needs  
update for GD USB, filename  
USBcable.tif

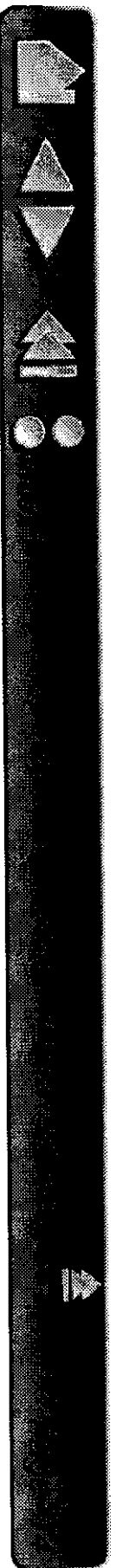

Each time you start your computer, the Wacom Tablet startup icon tells you if the tablet driver has successfully loaded.



The driver is loading.



The driver did not load.

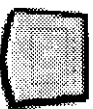

The driver has loaded successfully.



The driver loaded, but a Wacom tablet cannot be found. The tablet may be unplugged.

## IMAC REQUIREMENTS

Intuos requires Mac OS 8.5 or greater and Mac OS ROM 1.2.1 or greater.

1. **Verify the Mac OS and ROM versions:** Click on the Apple icon and select ABOUT THIS COMPUTER.... The ABOUT THIS COMPUTER dialog box will appear with the OS version displayed in the top right corner. Mac OS 8.5 or greater is required. If the version shown is older than Mac OS 8.5, contact your local computer dealer to purchase an upgrade. If Mac OS ROM version 1.2.1 or greater displays under the Mac OS version, your iMac does not need the firmware or OS ROM update. If it does not appear or an older Mac OS ROM is installed, continue with the instructions below to install the iMAC FIRMWARE UPDATE and then install iMAC UPDATE 1.1.
  2. **Install the iMac Firmware Update:** In the APPLE iMAC UPDATES folder located on the Intuos CD-ROM, double-click on the iMAC FIRMWARE UPDATE icon. This will decompress the file. Then double-click on the iMAC FIRMWARE UPDATE icon that appears on the desktop and follow the prompts. If in doubt, install this update.
  3. **Install iMac Update 1.1:** Install iMAC UPDATE 1.1 by double-clicking on the iMAC UPDATE 1.1 icon located in the APPLE iMAC UPDATES folder. This will decompress the file. Then double-click on the iMAC UPDATE icon that appears on the desktop and follow the prompts. If in doubt, install this update.
  4. After updating your system, perform the [USB Tablet Installation](#).



# UNINSTALLING THE SOFTWARE

To remove the Intuos software from your system:

1. Insert the Intuos CD-ROM into your computer and double-click on the INSTALL icon.
2. Select REMOVE instead of INSTALL.

## REGISTRATION

To register your product, please complete and mail in the Wacom Registration Card that came with your tablet.

Online registration may be available in some regions. If available, the Internet location will be printed on your Registration Card.

## PRODUCT INFORMATION

To learn more about which software applications currently support your Intuos tablet and tools, visit the Wacom web site for your region:

USA, Canada, Central and South America	<a href="http://www.wacom.com/productinfo">http://www.wacom.com/productinfo</a>
Europe, Middle East and Africa	<a href="http://www.wacom.de/productinfo">http://www.wacom.de/productinfo</a>
Japan	<a href="http://tablet.wacom.co.jp">http://tablet.wacom.co.jp</a>
Asia Pacific (English)	<a href="http://www.wacom.co.jp/asia-pacific">http://www.wacom.co.jp/asia-pacific</a>

To learn more about which software applications currently support your Intuos tablet and tools, visit the Wacom web site for your region:

Europe, Middle East and Africa	<a href="http://www.wacom.de/productinfo">http://www.wacom.de/productinfo</a>
USA, Canada, Central and South America	<a href="http://www.wacom.com/productinfo">http://www.wacom.com/productinfo</a>
Japan	<a href="http://tablet.wacom.co.jp">http://tablet.wacom.co.jp</a>
Asia Pacific (English)	<a href="http://www.wacom.co.jp/asia-pacific">http://www.wacom.co.jp/asia-pacific</a>

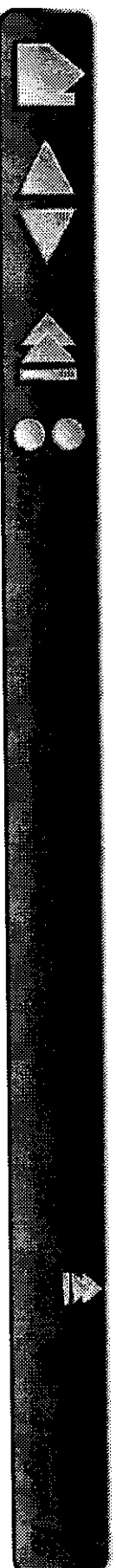

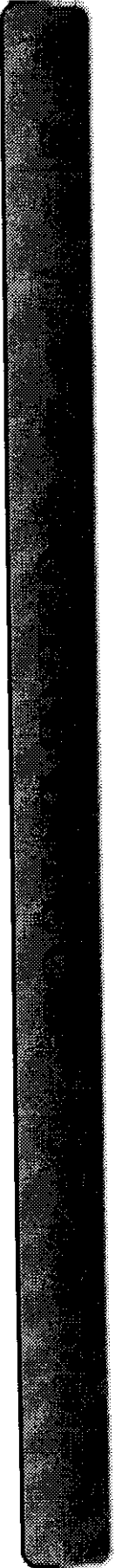

This section introduces you to the Intuos Graphics Tablet System. If you are new to using a graphics tablet and tablet input tools, read the following sections. They describe your Intuos tools and explain how to use them with the tablet.

**APPEARANCE AND FEATURES**

**SETTING UP YOUR WORK AREA**

**WORKING WITH THE TABLET**

**USING THE PEN**

**USING THE AIRBRUSH**

**USING THE 4D MOUSE**

**USING THE LENS CURSOR**

**CARING FOR YOUR TOOLS AND TABLET**

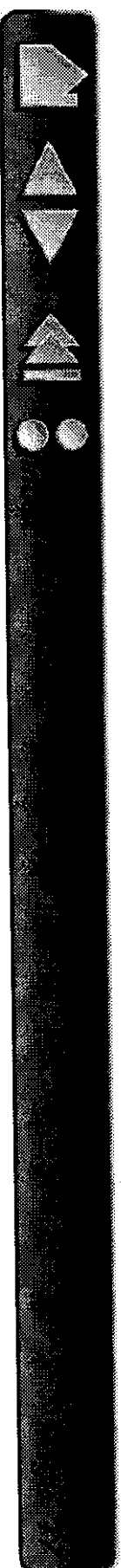

# APPEARANCE AND FEATURES

The Intuos Graphics Tablet System consists of two basic elements: a graphics tablet that serves as your work area, and the Intuos Tools you use with the tablet. For a complete listing of Intuos tablets, refer to Parts and Accessories.

## INTUOS 4X5A6 TABLET

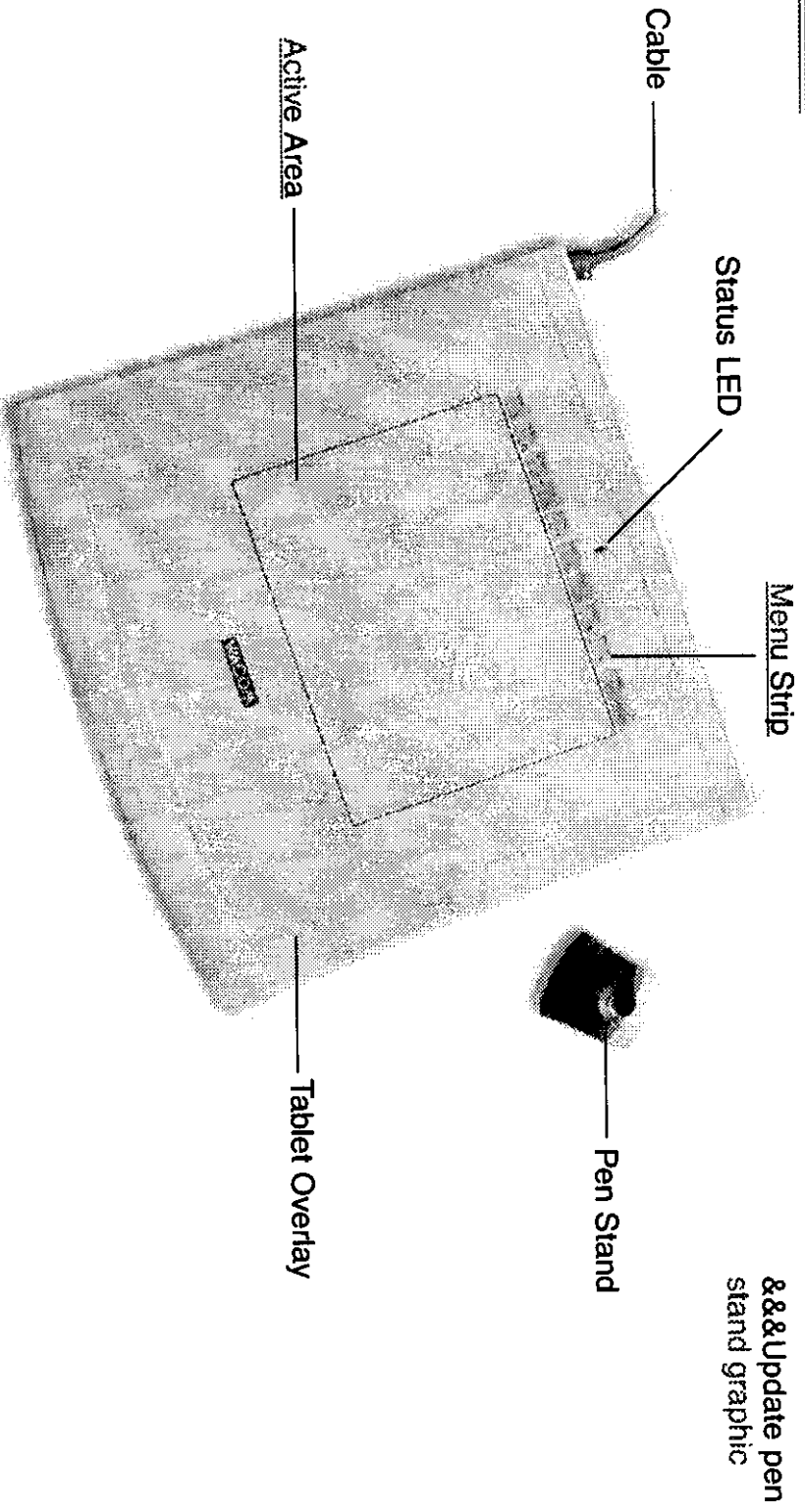

**Note:** To learn more about your tablet, see Working with the Tablet.

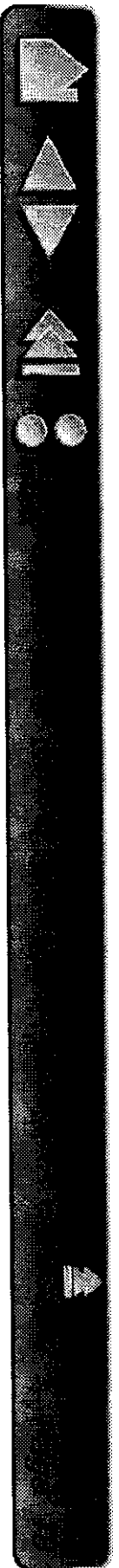

# INTUOS 6X8A5 AND 9X12A4 REGULAR TABLETS

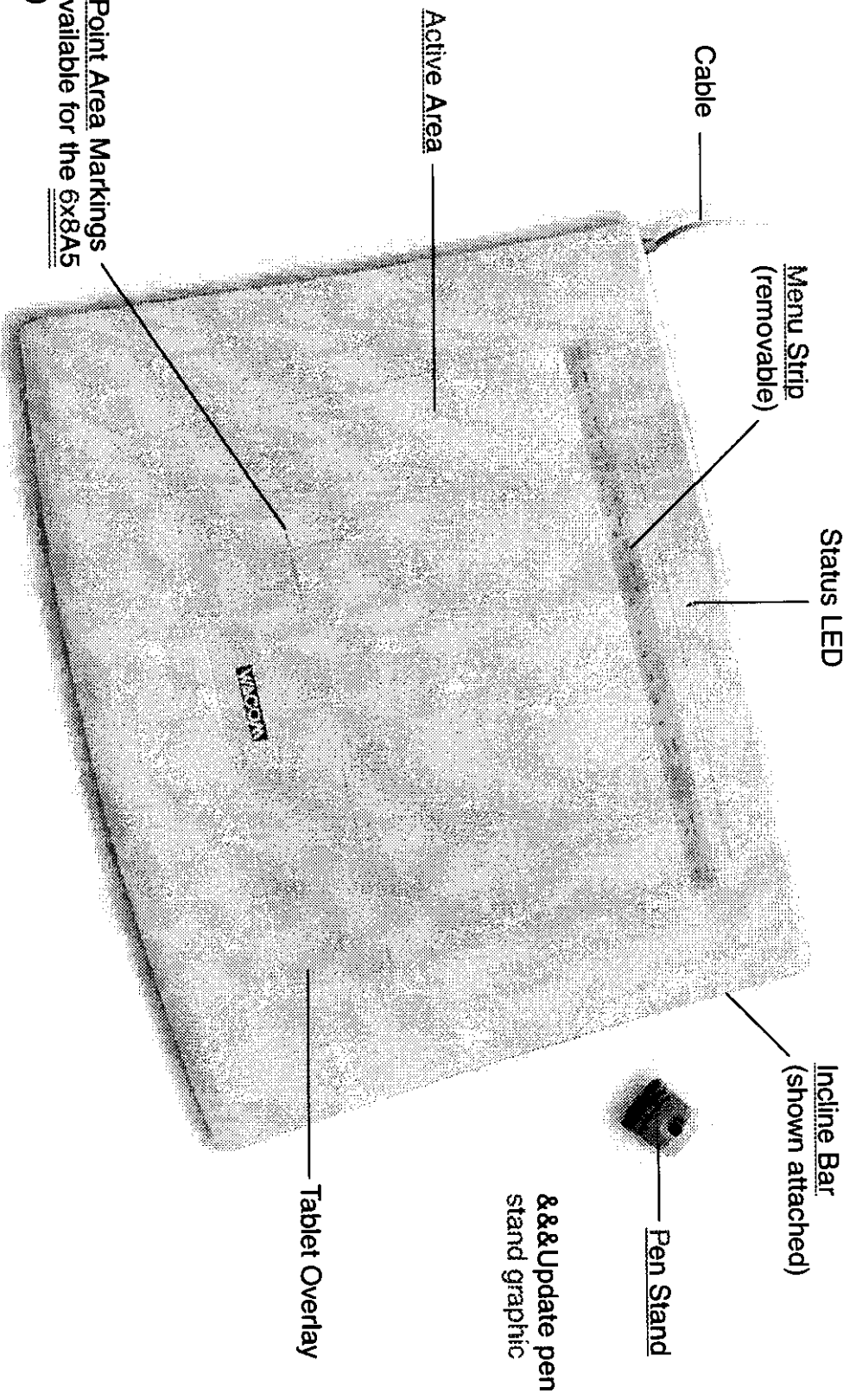

**Note:** The Intuos 9x12A4 regular tablet is shown. To learn more about your tablet, see [Working with the Tablet](#).

# INTUOS 12X12A4 OVERSIZE AND 12X18A3 TABLETS

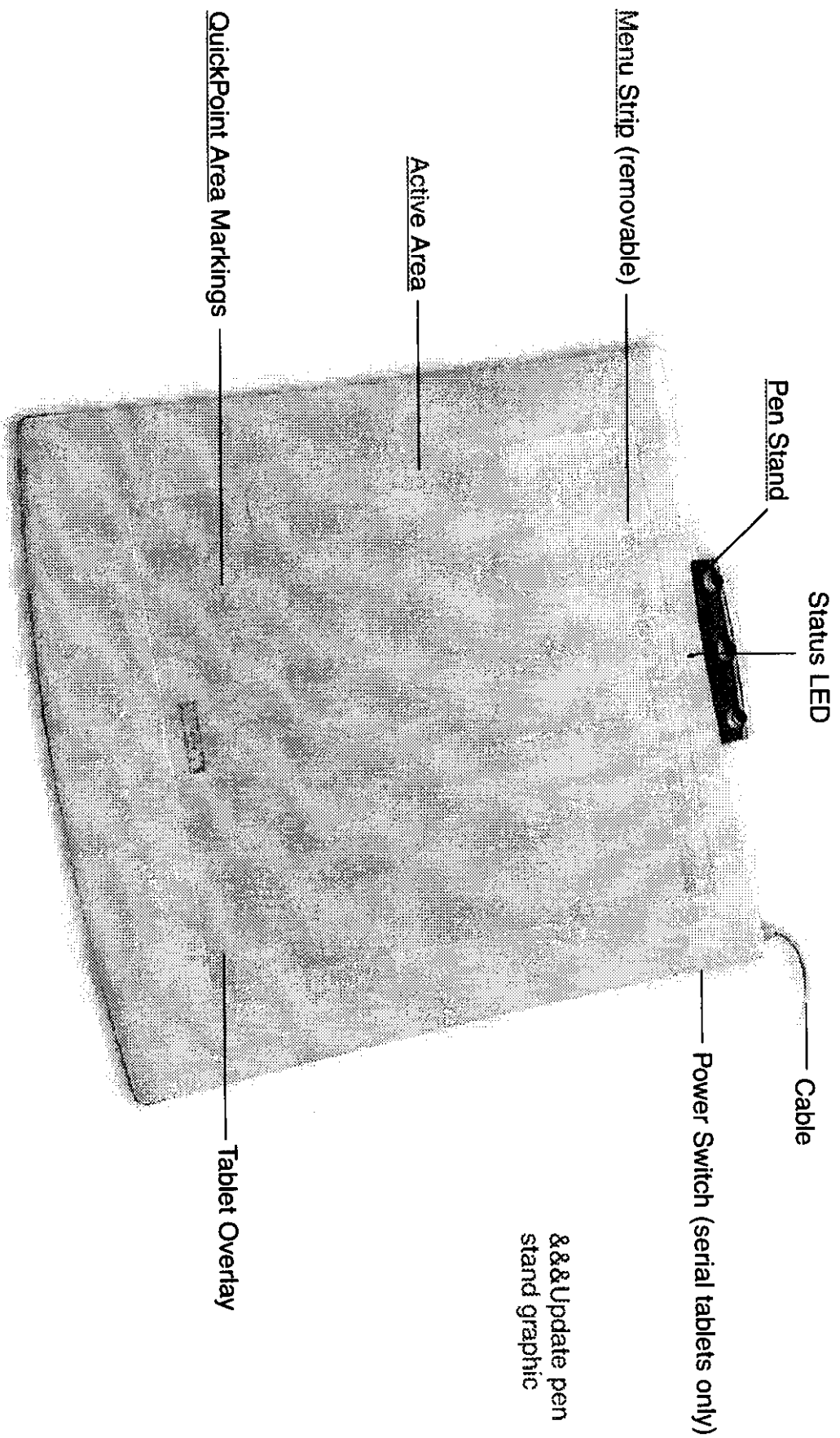

Update pen stand graphic

**Note:** The Intuos 12X12A4 oversize tablet is shown. To learn more about your tablet, see [Working with the Tablet](#).

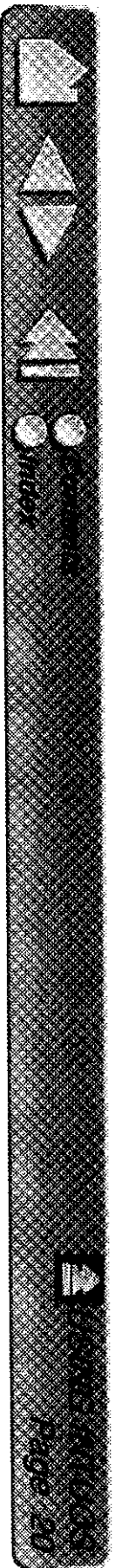

## INTUOS TOOLS

A variety of Intuos tools are available for your tablet. All Intuos tools are cordless, batteryless, and ergonomically designed. Each tool also has a Tool ID, enabling you to work with multiple tools on the same tablet and to customize each tool differently.

**Note:** The tool(s) included with your tablet will vary depending on which tablet model and configuration you purchased.

The Intuos Pen and Airbrush are pressure-sensitive freehand tools for image editing and creating natural-looking pen and brush strokes.

Apply the color-coded decals when using multiple pens with customized settings.

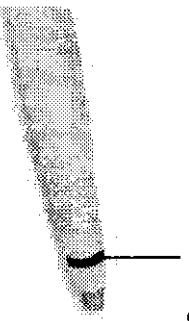

Eraser

DuoSwitch (rocker style)

Replaceable Nib (pen tip)

Intuos Pen

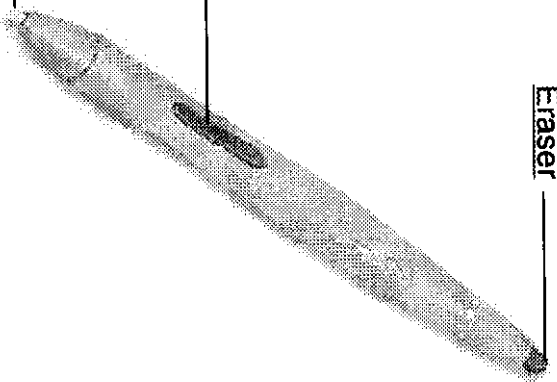

Eraser

Side Switch

Fingerwheel

Replaceable Nib

Intuos Airbrush

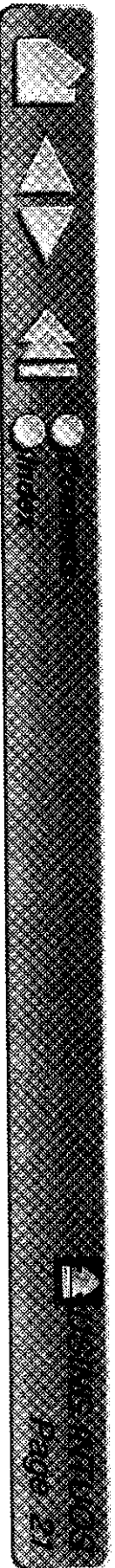
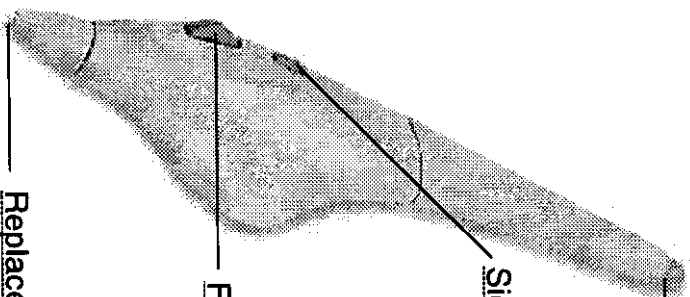

The Intuos 4D Mouse is an ideal tool for 2D or 3D navigation. It provides four degrees of control: x and y position, thumbwheel position, and positional rotation. The thumbwheel can be used for application-specific tasks in supporting applications.

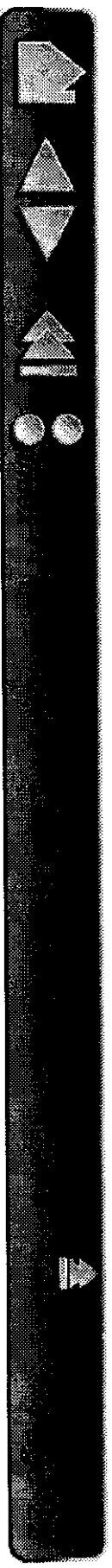
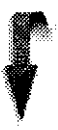
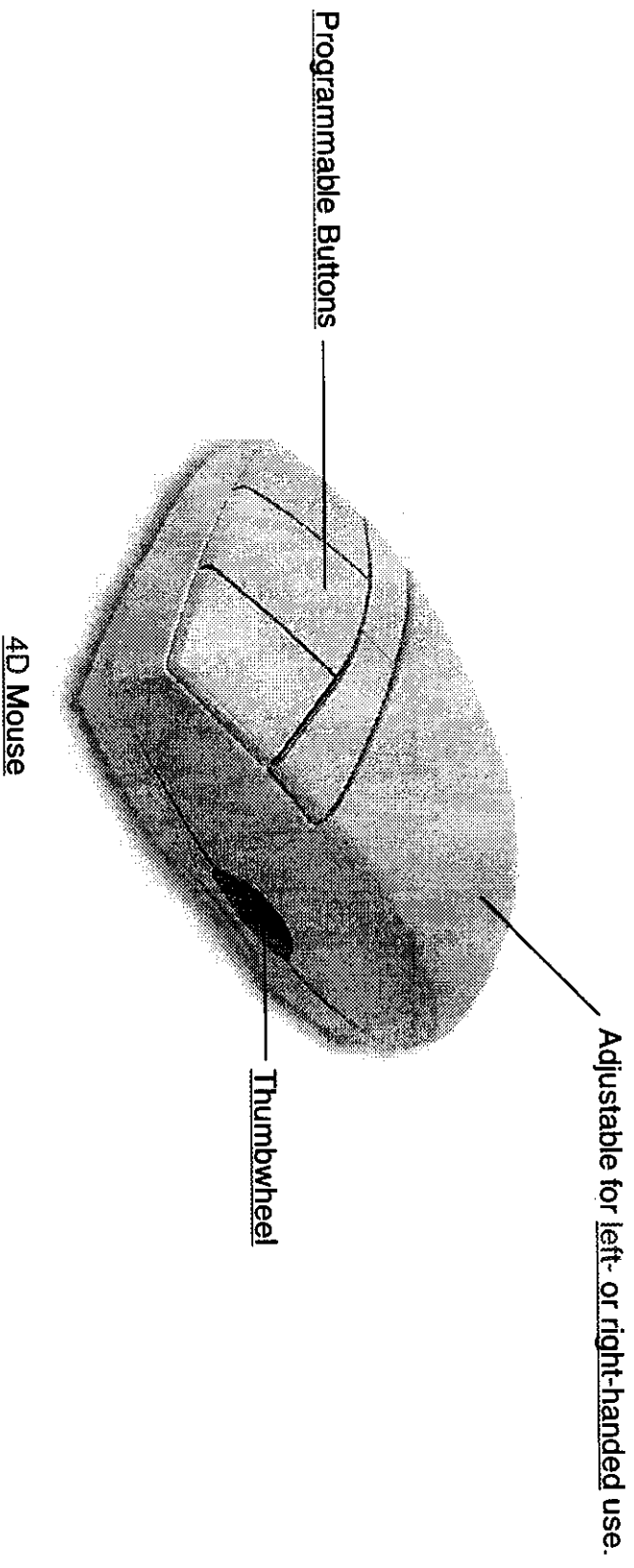

The Lens Cursor is an ideal tool for entering precise coordinate position information. Use the Lens Cursor with graphics and CAD applications for very accurate tracing or for digitizing images.

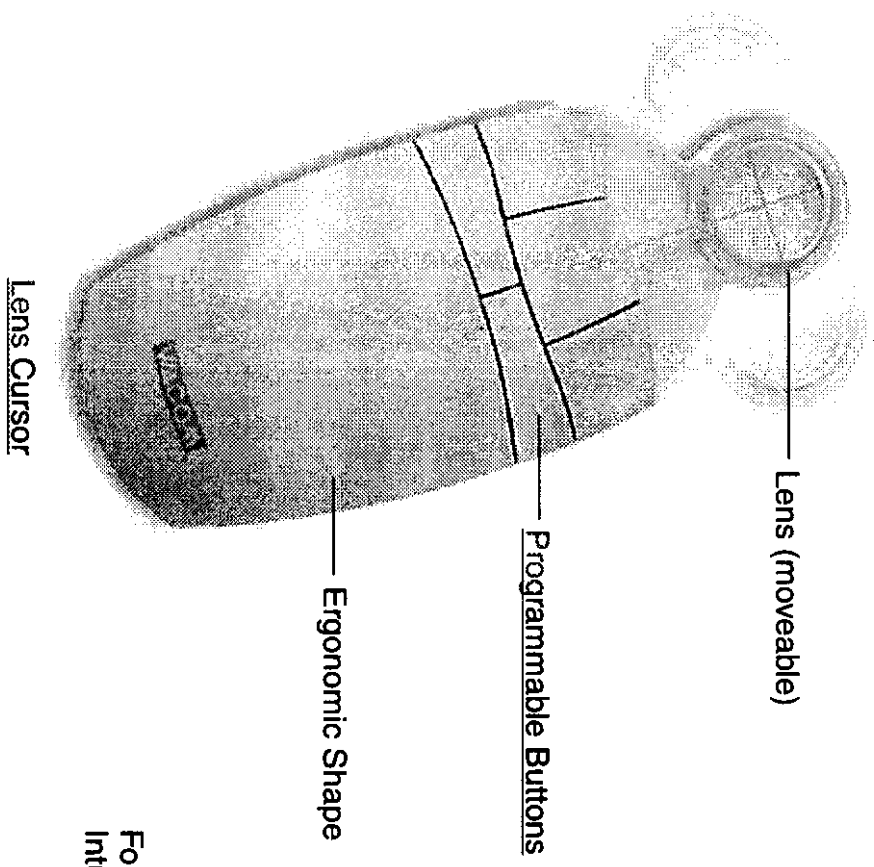

For information on these and other available Intuos tools, refer to [Parts and Accessories](#).





## SETTING UP YOUR WORK AREA

Organize your work area so you can work comfortably. Position your Intuos tablet, input tools, and keyboard so they are easily accessible without unnecessary reaching. Your monitor should be positioned so you can view it comfortably with a minimum of eyestrain.

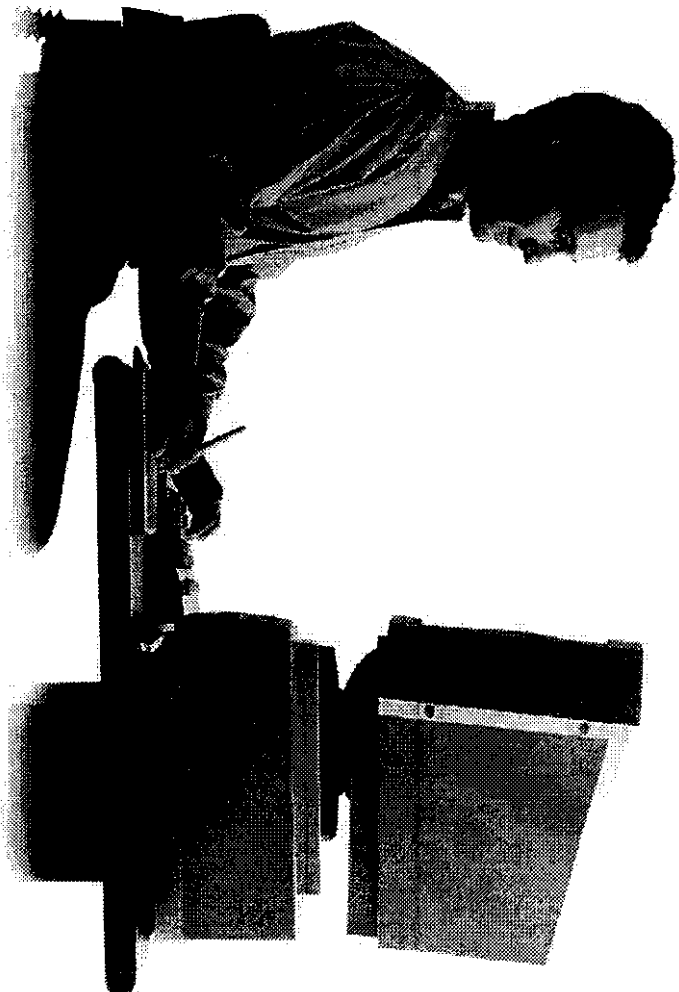

To minimize fatigue:

- Take short breaks between tasks to stretch and relax your muscles.
- Use a gentle grip when working with your Intuos tools.
- Alternate tasks throughout the day.
- Minimize awkward postures and repetitive movements that cause discomfort.

For some tablet models, you can adjust the tablet incline and attach the pen stand to better fit your work style. Refer to [Adjusting Tablet Incline](#) and [Adjusting the Pen Stand](#) for additional information.

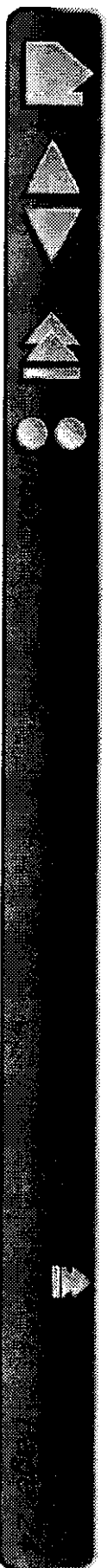

## **USA, Canada, Central and South America**

**Contact your local distributor, or:**

Worldwide Web: <http://www.wacom.com/productsupport>

24-hour Technical Support information:

Answerbook—online support database.

FAQs—Frequently Asked Questions and answers.

Software updates.

Email support.

Anonymous FTP Site: [ftp.wacom.com/pub/drivers](ftp://ftp.wacom.com/pub/drivers)

Software updates.

Phone: ++1-360-896-9833

Technical Support. (English)

(Normal business hours, Pacific Time)

FAX: ++1-360-896-9724

Technical Support. (English)

Internet Email: [support@wacom.com](mailto:support@wacom.com)

Automated mailback support. (English)

Fast FAX: 1-800-922-7590 (USA and Canada)

Automated support and sales information.  
(English)

**To purchase parts and accessories, call toll-free: 1-888-884-1870 (USA and Canada only). Outside of the USA and Canada, please contact your local dealer or distributor.**



## **USA, Canada, Central and South America**

**Contact your local distributor, or:**

Worldwide Web:

<http://www.wacom.com/productsupport>

24-hour Technical Support information:

Answerbook—online support database.

FAQs—Frequently Asked Questions and answers.

Software updates.

Email support.

Anonymous FTP Site: <ftp.wacom.com/pub/drivers>

Software updates.

Phone: ++1-1-360-896-9833

Technical Support. (English)  
(Normal business hours, Pacific Time)

FAX: ++1-1-360-896-9724

Technical Support. (English)

Internet Email: [support@wacom.com](mailto:support@wacom.com)

Automated mailback support. (English)

Fast FAX: 1-800-922-7590 (USA and Canada)

Automated support and sales information.  
(English)



# PRODUCT SPECIFICATIONS

## GENERAL SPECIFICATIONS FOR ALL INTUOS TABLETS

Coordinate resolution	100 lppmm (2540 lpi)
Accuracy (pen)	+/- 0.25 mm (0.010 in)
Accuracy (Lens Cursor)	+/- 0.15 mm (0.006 in), +/- 0.25 mm (0.010 in) on Intuos <u>4x5A6</u> , <u>6x8A5</u> , and <u>9x12A4</u> regular tablets
Tilt	+/- 60 degrees, +/- 50 degrees for Intuos <u>4x5A6</u> tablets
Maximum reading height with pen	6 mm (0.24 in)
Maximum report rate	200 points per second
Communication interface	<del>Apple Desktop Bus (ADB) (for <u>4x5A6</u>, <u>6x8A5</u>, and <u>9x12A4</u> regular tablets)</del> <del>Serial (for <u>12x12A4</u> oversize and larger tablets)</del> <u>USB (all USB tablets)</u>
Connector	4 pin, mini-circular DIN (4x5A6, 6x8A5, and 9x12A4 regular tablets) <del>9-pin, D-sub, female (12x12A4 oversize and larger tablets)</del> <u>USB A (all USB tablets)</u>
<del>Power requirements (ADB tablets)</del>	<del>DC 5V, 100mA, from ADB port</del>
Power requirements (USB tablets)	DC 5V, less than 500mA, from primary USB port or powered USB hub
<del>Power supply (12x12A4 oversize and larger serial tablets)</del>	<del>DC 12V 200mA</del>
Power Adaptor(s) ( <u>12x12A4 oversize and larger serial tablets</u> )	AEC-3512B-W (120V, USA), AD-3923F-W-W (230V, Continental Europe), AD-4230S-W (240V, Australia), AD-7442-W (240V, UK)
Operating temperature	5 to 40 degrees C (41 to 104 degrees F)
Storage temperature	-10 to +60 degrees C (14 to 140 degrees F)
Operating relative humidity	20% to 80% noncondensing
Storage relative humidity	20% to 90% noncondensing
Certification	FCC class B



Compliance

VCCI Class B, CE

## **INTUOS 4X5A6 TABLET (MODELS GD-0405-A, GD-0405-U)**

Active area (W x D)	127.0 x 106.0 mm (5.0 x 4.24 in)
Physical size (W x D x H)	225.0 x 210.0 x 7.5 mm (9.0 x 8.4 x 0.29 in)
Cable length	2.5 m (8.2 ft)
Weight	540 g (1.19 lb)
Power consumption	<del>0.5 watts (ADB)</del> , 2.0 watts (USB)

## **INTUOS 6X8A5 TABLET (MODELS GD-0608-A, GD-0608-U)**

Active area (W x D)	203.2 x 162.4 mm (8.13 x 6.45 in)
Physical size (W x D x H)	334.0 x 258.0 x 14.0 mm (13.36 x 10.32 x 0.56 in)
Cable length	2.5 m (8.2 ft)
Weight	880 g (1.94 lb)
Power consumption	<del>0.5 watts (ADB)</del> , 2.0 watts (USB)



## **INTUOS 9X12A4 REGULAR TABLET (MODELS GD-0912-A, GD-0912-U)**

Active area (W x D) 304.8 x 240.6 mm (12.19 x 9.62 in)  
Physical size (W x D x H) 456.0 x 361.0 x 14.0 mm (17.97 x 14.22 x 0.56 in)  
Cable length 2.5 m (8.2 ft)  
Weight 1.6 kg (3.52 lb)  
Power consumption ~~0.5 watts (ADB)~~, 2.0 watts (USB)

## **INTUOS 12X12A4 OVERSIZE TABLET (MODELS GD-1212-R, GD1212-U)**

Active area (W x D) 304.8 x 316.8 mm (12.19 x 12.67 in)  
Physical size (W x D x H) 444.0 x 435.5 x 37.0 mm (17.76 x 17.42 x 1.48 in)  
Cable length 2.5 m (8.2 ft)  
Weight 2.1 kg (4.62 lb)  
Power consumption ~~1.2 watts (Serial)~~, 2.0 watts (USB)

## **INTUOS 12X18A3 TABLET (MODELS GD-1218-R, GD-1218-U)**

Active area (W x D) 457.2 x 316.8 mm (18.28 x 12.67 in)  
Physical size (W x D x H) 616.0 x 445.5 x 37.0 (24.64 x 17.82 x 1.48 in)  
Cable length 2.5 m (8.2 ft)  
Weight 3.0 kg (6.6 lb)  
Power consumption ~~1.2 watts (Serial)~~, 2.0 watts (USB)

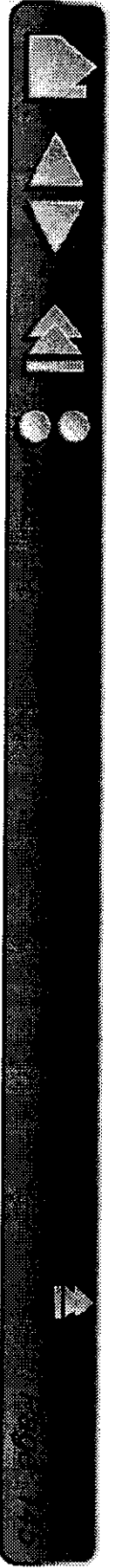

## **INTUOS PEN (MODEL GP-300E)**

Pen tip travel	0.1 mm (0.004 in) or less
Pressure levels	1024 levels
Eraser tip travel	1.3 mm (0.051 in), approximately
Physical size (L x D)	151 x 12.2 mm (5.9 x 0.48 in)
Weight	13 g (0.46 oz), approximately
Tip refill type	Polyacetal (Part No. PSI-A007)

## **INTUOS AIRBRUSH (MODEL GP-400E)**

Fingerwheel travel	10 mm (0.39 in)
Fingerwheel resolution	1024 levels
Pen tip travel	0.1 mm (0.04 in) or less
Pressure levels	1024 levels
Eraser tip travel	1.3 mm (0.05 in), approximately
Physical size (L x D)	162.5 x 32.6 mm (6.38 x 1.28 in)
Weight	24 g (0.85 oz), approximately
Tip refill type	Polyacetal (Part No. PSI-A007)

## **INTUOS INKING PEN (MODEL GP-110)**

Pen tip travel	0.1 mm (0.04 in) or less
Pressure levels	1024 levels
Physical size (L x D)	151 x 12.5 mm (5.94 x 0.49 in)
Weight	12 g (0.42 oz), approximately
Tip refill types	Polyacetal (Part No. PSI-A011) Ink refill, black (Part No. PSI-A023)



## **INTUOS STROKE PEN (MODEL GP-120)**

Pen tip travel	1.3 mm (0.05 in), approximately
Pressure levels	1024 levels
Physical size (L x D)	151 x 12.5 mm (5.94 x 0.49 in)
Weight	12 g (0.42 oz), approximately
Tip refill type	Polyacetal (Part No. PSI-A011)

## **INTUOS 4D MOUSE (MODEL GC-500)**

Physical size (L x D x H)	113.5 x 72.6 x 38.5 mm (4.47 x 2.86 x 1.52 in)
Weight	75 g (2.65 oz), approximately
Button stroke	1 mm (0.04 in), approximately
Thumbwheel travel	+/- 10 mm (+/- 0.4 in)
Thumbwheel resolution	+/- 1023 levels

## **INTUOS LENS CURSOR (MODEL GC-210)**

Physical size (L x D x H)	158.9 x 66.1 x 33.0 mm (6.29 x 2.60 x 0.79 in)
Weight	72 g (2.54 oz), approximately
Button stroke	1 mm (0.04 in), approximately

