



WARNING

Turn off the power of the Cintiq 15X in the area where prohibited to use. It may cause other electronic devices to malfunction.

Do not use the Cintiq 15X in a facility control system that requires extremely high reliability. It may cause other electronic devices to malfunction or, other device may cause the Cintiq 15X to malfunction.



HIGH VOLTAGE

Do not open the Cintiq 15X It has the risk of electric shock.

Only use the AC adaptor that came with your Interactive Pen Display. If a different type of AC adaptor is used, the Interactive Pen Display will not work properly or it may be damaged. Using a different type of AC adaptor also has the potential to result in fire.

If the Cintiq 15X is broken due to fall or hit, do not leave it connected to the power. It has the potential to result in fire.



CAUTION

Prevent your children from swallowing the UltraPen nib or side switch. The pen nib or side switch may accidentally be pulled out if children are biting on them.

Do not touch the liquid crystal if leaked; it is irritative. In case of contact, rinse immediately with running water for more than 15 minutes. If it went into the eye or mouth, consult physician.

Be sure to ground the power adaptor cable at the receptacle when plugging in.

Preface

The Wacom® Cintiq™ 15X is an integrated LCD tablet designed for direct draw-on-screen interface with your computer. The Cintiq 15X Interactive Pen Display components include a Wacom tablet internally mounted behind a 15.0" diagonal TFT color LCD monitor, and Wacom's UltraPen®.

This manual describes how to install the Cintiq 15X Interactive Pen Display hardware and software.

It also describes how to use the Interactive Pen Display and UltraPen.

Information on using the Wacom Tablet Control Panel for customizing your tablet and pen settings is available in the Interactive Pen Display online Help, located under the HELP menu in the Wacom Tablet Control Panel.

The following are not included with this product:

- Information about your specific computer hardware.
- Information about your operating system.
- Information about application software. To use the pressure-sensitivity of the UltraPen with your favorite drawing application, refer to instructions in that application's manuals.

Please refer also to your computer hardware, operating system, or software application manuals.

Precautions on handling the Cintiq 15X

- Do not lift up the Cintiq 15X by holding the stand. It may damage the open-close mechanism of the stand. When you lift up the Cintiq 15X, be sure to hold the main unit casing.
- Do not put heavy articles on the Interactive Pen Display; this may damage the cover glass or stand.
- Do not place heavy article on the Cintiq 15X cables. Near the cable connectors, do not apply heavy stress on the cables or do not repeat bending the cables. It may damage the Cintiq 15X.
- Do not connect or disconnect the DVI video cable or power cable while the Interactive Pen Display or your computer is turned on; it may damage the LCD display or computer video card.

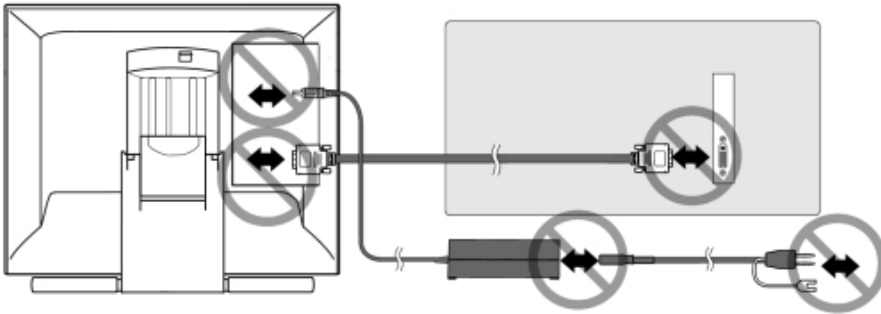

- For use with DVI, do not use any graphics card that Cintiq 15X can not be used with. It may damage the Cintiq 15X.
- Do not disassemble the Cintiq 15X or pen. This may cause the device to malfunction. In this case, Wacom shall have no responsibility to repair or replace the product.
- Do not use or store the Cintiq 15X where:
 - Temperature changes are severe (e.g., outdoors or inside a vehicle).
 - The Cintiq 15X and pen are exposed to direct sunlight or heat from an appliance.
 - The Cintiq 15X and pen are exposed to water or any other kind of liquid.
 - Temperature or humidity exceeds the specifications.
- Do not block the ventilation holes in the rear panel. It may overheat and damage the Cintiq 15X.
- Do not use the Cintiq 15X in a dusty environment. It may damage the Cintiq 15X.
- Do not scratch the cover glass of the Cintiq 15X. Avoid placing sharp objects on the glass surface. If the pen tip becomes sharp or angular, it may damage the coating on the cover glass of the Interactive Pen Display. Please replace the pen nib as necessary.
- Do not use detergent to clean the cover glass of the Cintiq 15X—this may alter the surface friction and deteriorate the handwriting feel.

Radio and Television Interference (U.S.A.)

The equipment described in this manual generates, uses, and can radiate radio-frequency energy. If it is not installed and used properly that is, in strict accordance with Wacom instructions it may cause interference with radio and television reception.

Federal Communication Commission Interference Statement

This equipment has been tested and found to comply with the limits for a Class B digital device, pursuant to Part 15 of the FCC Rules. These limits are designed to provide reasonable protection against harmful interference in a residential installation. This equipment generates, uses and can radiate radio frequency energy and, if not installed and used in accordance with the instructions, may cause harmful interference to radio communications. However, there is no guarantee that interference will not occur in a particular installation. If this equipment does cause harmful interference to radio or television reception, which can be determined by turning the equipment off and on, the user is encouraged to try to correct the interference by one of the following measures:

- Reorient or relocate the receiving antenna.
- Increase the separation between the equipment and receiver.
- Connect the equipment into an outlet on a circuit different from that to which the receiver is connected.
- Consult the dealer or an experienced radio/TV technician for help.

FCC Caution: To assure continued compliance, (example - use only shielded interface cables when connecting to computer or peripheral devices). Any changes or modifications not expressly approved by the party responsible for compliance could void the user's authority to operate this equipment.

Table of Contents

Checking Packed Components	5
Installation	6
LCD Monitor Installation	
Wacom Tablet Software Installation for Windows and Macintosh	
Calibrating the Tablet	
Cintiq 15X Component Functions	10
Front View	
Rear View	
Mounting the Cintiq 15X onto a Mount Arm or Other Stand	
Caring For Your Cintiq 15X	
Using the UltraPen	
UltraPen	
Pen Type Settings in the Wacom Tablet Control Panel	
Replacing the Pen Tip	
Using the UltraPen	13
UltraPen	
Using a Pen	
Adjusting the LCD Monitor	15
Factory Presets, Auto Adjust and User Settings	
Functions and Uses of the MENU Window	
Adjusting Pitch and Phase	
Power Saving	
Caring For Your Cintiq 15X	19
Cleaning Your Cintiq 15X	
Replacing the Pen Tip	
Troubleshooting for Display	20
Specifications	22
General Specifications	
LCD Display	
Tablet	
UltraPen	

Checking Packed Components

In your package you will find the following items:

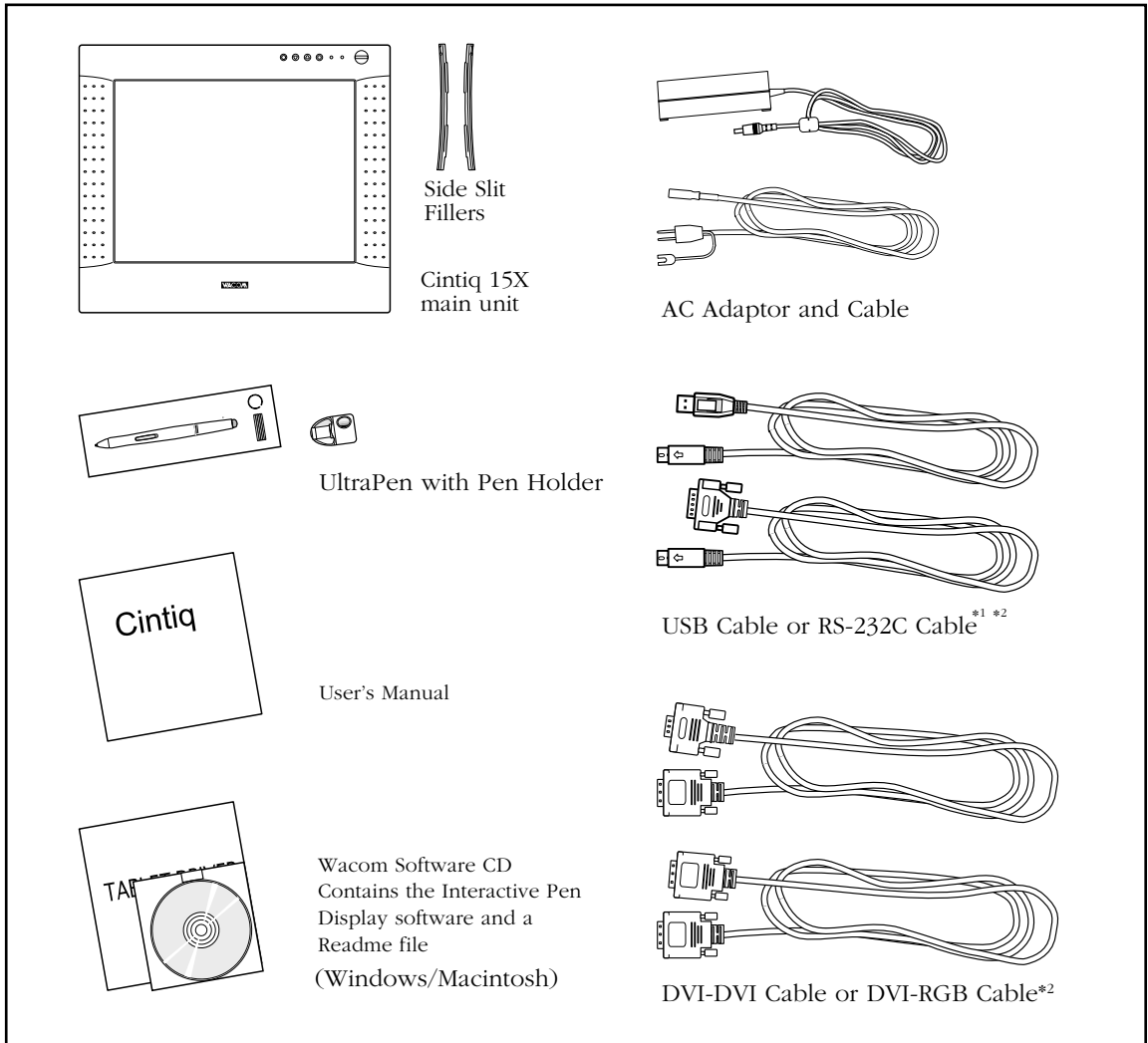

*1 For Cintiq 15X only. Do not use this for other devices.

*2 One either cable is included.

Please retain the package box for storage or transportation.

Installation

LCD Monitor Installation

First install the Cintiq 15X as a monitor. Do not connect the USB cable or serial data cable until instructed for the tablet software installation.

① Turn off your computer.

IMPORTANT: Never connect or disconnect the DVI video cable or power cable while your computer or Interactive Pen Display is powered on. This can damage the LCD display or video card.

② Connect the DVI-to-DVI cable or DVI-RGB cable between the Cintiq 15X and your computer.

③ Set the DVI / Analog RGB switch. Turn it up for Analog RGB, and turn it down for DVI.

√ Connect the AC adaptor to the Cintiq 15X.

⑤ Connect the AC adaptor power cable and plug the adaptor into an AC outlet.

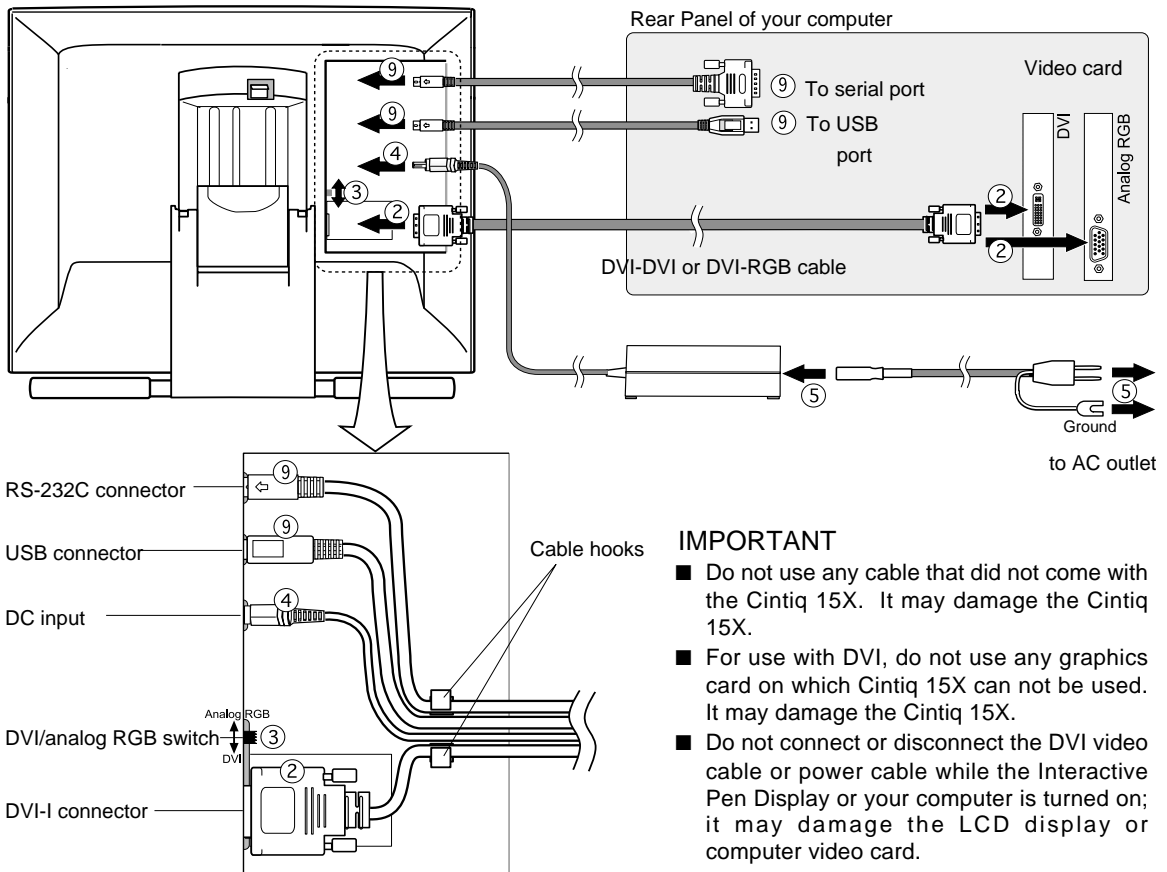

-
- ≈ Turn on the power switch of the Cintiq 15X. The power lamp will light green , and then turns orange.
- △ Turn on your computer to start your operating system.
- ⑧ By looking at the Cintiq 15X display, configure the monitor settings for proper size and color resolution. (The recommended resolution is 1024 x 768. Other settings may give unsatisfactory results.)
- The color pallet and number of colors are as follows:
- High Color (16 bit), 65,536 color
 - True Color (24 bit), 16,770,000 color approximate
- The number of colors is constrained by the performance of your computer or graphics card. Refer to the documentation of the manufacturer for details.
- ⑨ To install the Wacom tablet software, turn off your computer and connect the USB cable or serial data cable.

Tablet Software Installation for Windows* and Macintosh

- ① After connecting all cables of the Cintiq 15X, turn on the Cintiq 15X and your computer. Allow the operating system to fully load.
- ② Insert the Wacom Tablet CD into the CD-ROM drive. The Wacom tablet software installer menu should automatically display. If the menu does not display, double-click on the INSTALL icon (located on the CD). Click on the INSTALL CINTIQ button and follow the prompts to install the driver software.
- ③ Windows: After the driver installation is complete, make sure you can use your UltraPen on the tablet display to move the screen cursor.
- Macintosh: After the driver installation is complete, restart your Macintosh. You will be able to use your UltraPen on the tablet display to move the screen cursor.

Be sure to read the README file for late braking news.

If you have trouble in the Tablet software installation, refer to the TROUBLESHOOTING CHAPTER in the online Help in the Wacom Tablet CD. You can also open the online Help from the HELP menu from the WACOM TABLET control pane.

Precede to CUSTOMIZING YOUR CINTIQ 15X – THE BASICS.

* Windows 95 and later

Customizing Your Cintiq 15X – The Basics

Opening the Wacom Tablet Control Panel

The Wacom Tablet Control Panel makes it easy to customize your Interactive Pen Display and UltraPen.

To open the control panel:

Windows: Click on the Windows Start button and choose Programs. From the Wacom Tablet group, choose the Wacom Tablet option.

Macintosh: From the Apple menu, choose Control Panels and then Wacom Tablet.

When you open the control panel, an icon for the UltraPen is displayed in the Tool List and the appropriate tabs are displayed. To customize the UltraPen, make your changes to the tab controls.

On Windows systems, be sure to click **APPLY** or **OK** to save your changes.

Note: Application-specific settings are for advanced users. Refer to the online Help for more information on creating and using application-specific settings.

Displays applications with customized settings.

Displays an icon for the UltraPen.

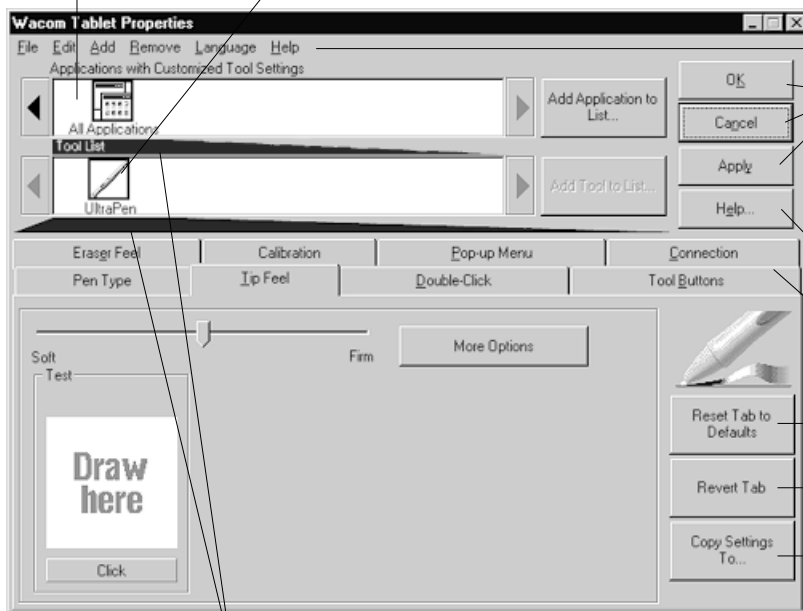

The pull-down menus access a variety of control panel features.

For Windows only: **OK** saves changes and closes the control panel. **Cancel** closes the control panel without saving changes. Use **Apply** to save changes without closing the control panel.

Displays online Help for the control panel.

Tabs display settings for the selected application.

Resets the selected tab to its factory default values

Returns a tab to its previously saved or last applied settings.

Copies settings from one tool or application to another.

Windows screen capture shown.

Current selections are highlighted. Wedges emphasize the relationship between tab settings and the selected tool and application.

Calibrating the Tablet

You will need to calibrate the tablet in order to line up the screen cursor position with the position of the UltraPen on the Interactive Pen Display. This is required to adjust for parallax caused by the clear plastic overlay. After setting the tablet in its working position, follow the procedure below to calibrate the tablet.

- ① From the Wacom Tablet Control Panel, select the CALIBRATION tab.

If you are working with multiple monitors, select the Monitor that corresponds to the tablet's LCD display.

- ② Click on the CALIBRATE... button to display the monitor calibration screen..



- ③ Hold the pen as you normally do, and use the pen tip to click on the crosshairs in the upper-left corner.

- ④ Then click on the crosshairs that are displayed in the lower-right corner. (You will need to click Apply or OK for the changes to take effect.)

NOTE: The calibration setting applies to all applications

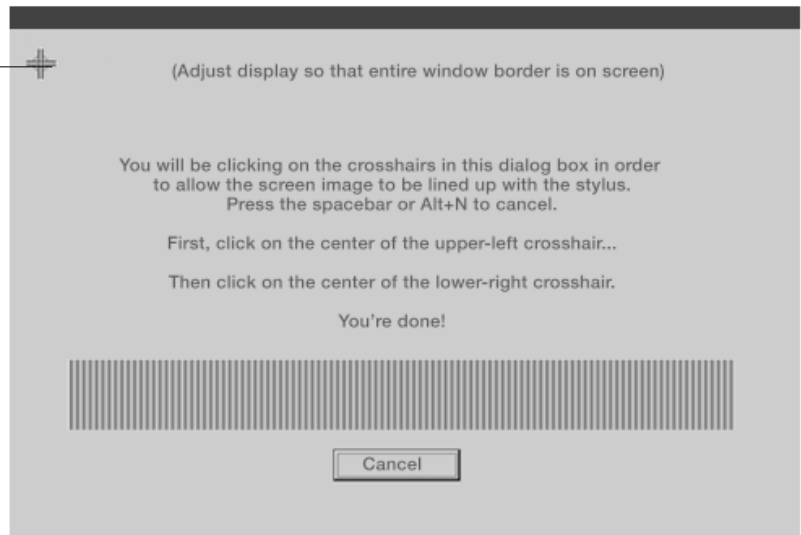

Cintiq 15X Component Functions

Front View

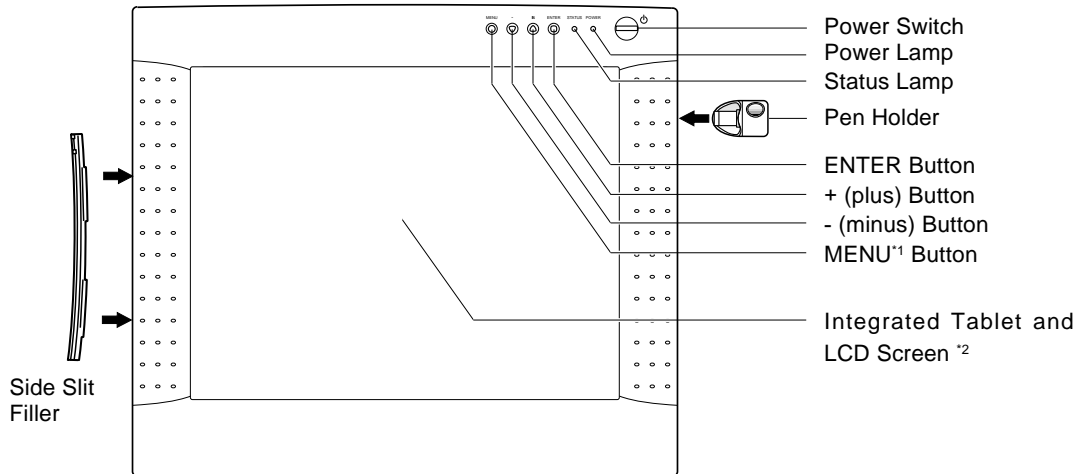

Power Switch

Turns the power to the Cintiq 15X on or off.

Power Lamp

Lights green when power has properly been supplied to the Cintiq 15X. Turns orange or flashes when your computer goes into power management mode and stops sending the video signal to the Cintiq 15X.

Status Lamp

Lights green when a pen switch is pressed.

Pen Holder

Can attach and detach at the location shown in the above drawing. When attached, it can be moved up and down, or rotated. It can also be attached to the left side.

Side Slit Fillers

Closes the side slit on which the pen holder is not attached.

ENTER Button

Press this button when you select or exit an item in MENU*2 window.

*1 You can select the language to display the MENU window. ☞ P11

*2 - On a TFT liquid crystal display, a very small number of pixels may be permanently illuminated or not illuminated at all. This does not mean that the display is defective.

- When pressing the LCD panel hard it may temporarily cause moire to appear. This does not mean the display is defective.

- When a still image is displayed for a long period of time, an after image may temporarily remain.

+ (plus) Button, - (minus) Button

Press this button when you change the item or settings in MENU window.

MENU Button

Opens and closes the MENU window.

Integrated Tablet and LCD Screen

The LCD monitor and tablet sensor function as an integrated input and output device.

The LCD resolution is 1024 x 768 pixels at 16,777,216 colors. The tablet sensor reports coordinates, pressure, switch, and eraser information.

The characteristics of the LCD may cause an inaccurate display of color tones. It is recommended that the tones be checked on a color-adjusted CRT monitor.

Rear View

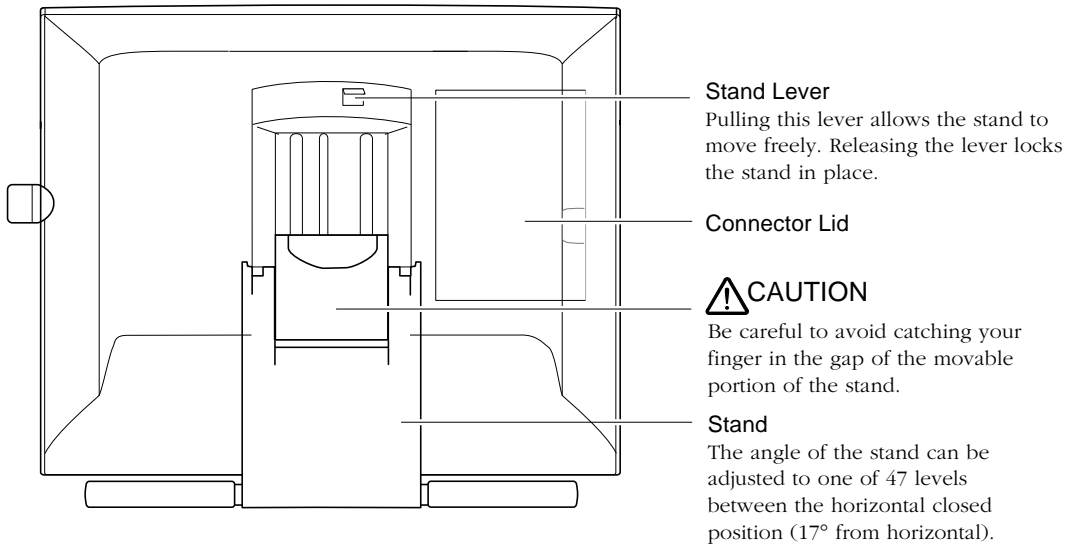

IMPORTANT

Do not lift up the Cintiq 15X by holding the stand. It may damage the open-close mechanism of the stand. When you lift up the Cintiq 15X, be sure to hold the main unit casing.

Be sure to close the stand when packing the Cintiq 15X Interactive Pen Display. If you do not close the stand, the notched mechanism may be damaged during transportation and storage.

* As the tablet of the Cintiq 15X emits electromagnetic waves in a certain frequency, if another tablet is closely placed to the Cintiq 15X, the screen cursor may jitter or jump around. To solve this problem, place the tablet away from the Cintiq 15X

Cintiq 15X Component Functions

Using the side slit filler

To attach the side slit filler:

- ① Adjust the bottom of the side slit filler to the bottom of the side slit.
- ② Fill in the slit pressing the top of the side slit filler.

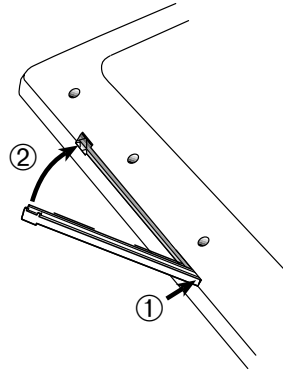

To remove the side slit filler:

Pull out the top of the side slit filler using a screwdriver.

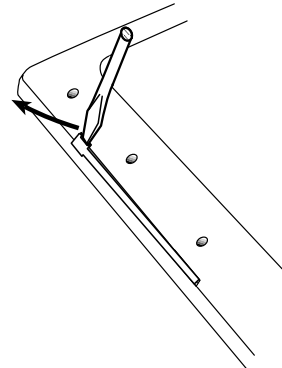

Mounting the Cintiq 15X onto a Mount Arm or Other Stand

The Cintiq 15X conforms to VESA FPMPM standard.

You can dismantle the stand and mount the Cintiq 15X onto a VESA conformed mount arm or other stand. (Screw gap: 75 mm, Thread pitch: 0.7 mm)

- ① Turn off your computer and the Cintiq 15X, and disconnect all cables from the Cintiq 15X.
- ② Place the Cintiq 15X on a flat table facing down. Be sure to spread a soft cloth between the table and Cintiq 15X front panel to protect the surface.
- ③ Unscrew and dismantle the stand.

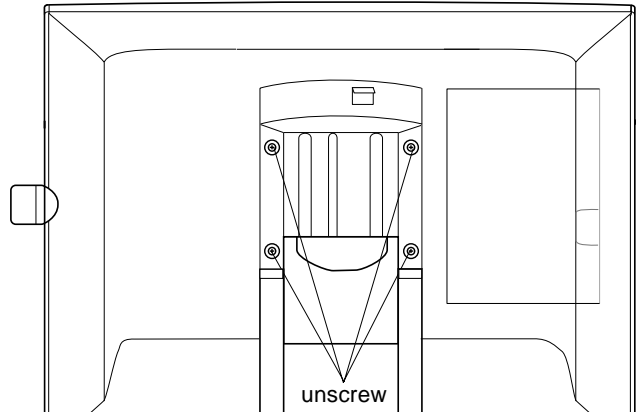

- ④ Using the four screws of Cintiq 15X stand, firmly mount the Cintiq 15X onto the arm.
- ⑤ Connect all cables by following the instruction on page 6.

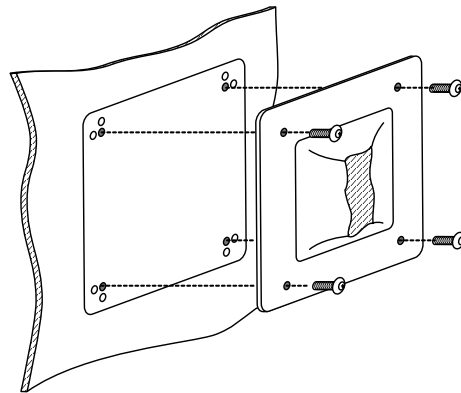

⚠ CAUTION

When mounting the Cintiq 15X onto an arm or other stand, be sure to follow the instructions in the documentation of the manufacturer. If improperly installed, it may cause Cintiq 15X to fall and be damaged.

Using the UltraPen

UltraPen

Hold the UltraPen as you would a pencil. Make sure the side switch is in a convenient location where you can press it with your thumb or forefinger, but won't accidentally press it while drawing.

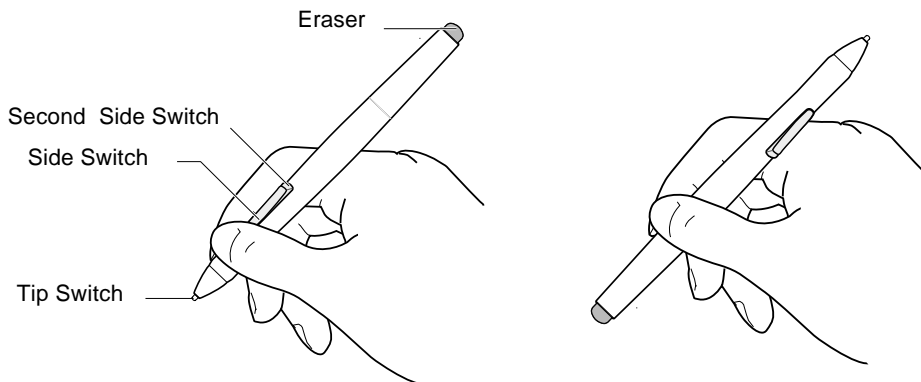

Pen Tip

When the pen tip is within proximity (5 mm or 0.2 in) of the active area, the tablet reports:

- The x, y coordinates of the pen tip.
- The pressure applied to the pen tip.
- Whether a side switch is on or off.

When pressure is applied to the pen tip, the tip switch is turned on and the pen simulates a mouse button click.

Eraser

To use the eraser, hold the UltraPen upside down. When the eraser is within proximity of the active area, the tablet reports the x, y coordinates and the pressure applied to the eraser.

The eraser can be used as an eraser or assigned to another function, depending on the application. The tablet distinguishes the tip switch from the eraser switch.

Side Switch and Second Side Switch

These switches are programmable, and can be used to perform the same click and double-click functions as the tip switch. The switches are turned on when pressed, and are otherwise turned off. Please refer to the online Help for more information on side switch settings.

Using the UltraPen

Using a Pen

Pointing and Selecting

Move the UltraPen above the Cintiq 15X Interactive Pen Display screen to position the screen cursor.

The cursor instantly jumps to the new location (absolute positioning). Press the pen tip on the Interactive Pen Display screen to make a selection.

NOTE: If the screen cursor is not aligned with the pen tip, you will need to calibrate the Interactive Pen Display.

Clicking

Tap the Interactive Pen Display screen once with the pen tip, or touch the pen to the display screen with enough pressure to generate a mouse click.

Double-Clicking

Press the upper side switch (Windows systems) or quickly tap the Interactive Pen Display screen twice in the same place with the pen tip. Double-clicking is easier when the pen is perpendicular to the tablet screen.

Dragging

Select an object, then slide the pen tip across the Interactive Pen Display screen to move the object.

Erasing

In supporting applications, the pen's eraser works like the eraser on a pencil. In text applications, use the eraser to select text, then lift the eraser from the tablet to delete the text.

Adjusting the LCD Monitor

Factory Presets, Auto Adjust and User Settings

Factory Presets: The Cintiq 15X is programmed with some prevailing display modes as defaults so that the Cintiq 15X can display the image with the best quality based on the incoming signals for most cases.

Auto Adjust: When the Cintiq 15X first receives the signals with a display mode out of factory presets, the Auto Adjust automatically adjusts horizontal/vertical position, phase and pitch if horizontal frequency is between 28 to 64 kHz and vertical frequency is between 48 to 75 Hz. The adjusted settings will be stored in the Cintiq 15X to display in the best condition when the same signals are received next time. This is effective for analog RGB only. While the Auto Adjust is working, except for the power switch, all buttons will not work.

User Settings: For any display modes, once you manually set the display by using the MENU window, the settings will be stored in the Cintiq 15X to display in the same condition when the Cintiq 15X receives the same signals next time.

Functions and Uses of the MENU Window

To open the MENU Window: Press the MENU button 'O'.

To switch an item: Press the + (plus) button 'D' or the - (minus) button 'V'.

To change setting in the item: Press the ENTER button 'Q' to activate the item, then press the + (plus) button 'D', - (minus) button 'V' and/or ENTER button 'Q'.

To exit the MENU Window: Press the MENU button 'O'.

● Contrast

Adjusts contrast.

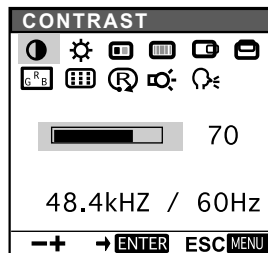

□ Phase

(Analog RGB only)
Calibrates phase when the Auto Adjust is not enough. ☞ P18

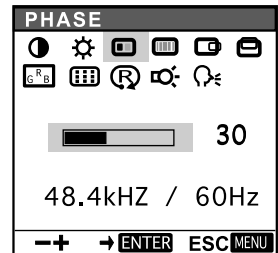

⚙️ Brightness

Adjusts black level.

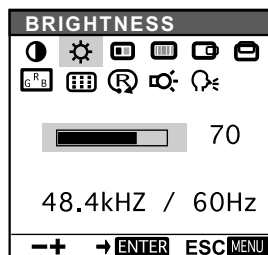

▨ Pitch

(Analog RGB only)
Calibrates pitch when the Auto Adjust is not enough. ☞ P18

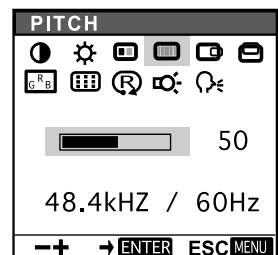

Adjusting the LCD Monitor

Horizontal Position

(Analog RGB only)
Adjusts horizontal position of display.

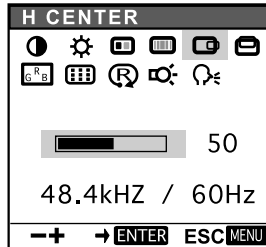

Vertical Position

(Analog RGB only)
Adjusts vertical position of display.

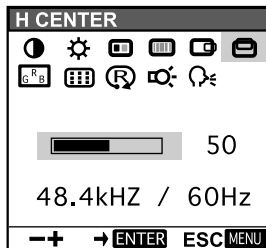

Color Management

You can select one from 9300, 6500, 5000 deg. in Kelvin and user setting. You can change the user setting by selecting the icon ↵.

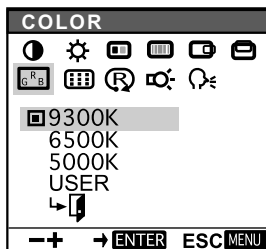

In the user setting, change red and blue to calibrate color centering on green. To exit, select the icon ↵.

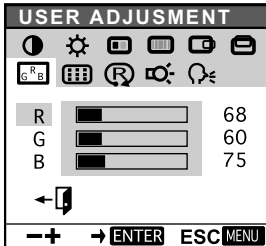

Menu Position

Moves the MENU window to one of nine positions.

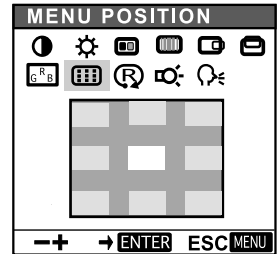

Reset

AUTO ADJUST resets the horizontal/vertical position, phase and pitch to the condition that the Auto Adjust did. RECALL resets the display to the factory default. Selecting the icon ↵ exits the Reset window without resetting anything.

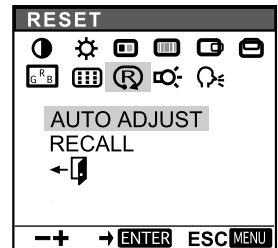

Backlight Level

Adjusts the backlight level.

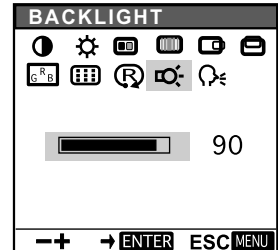

Language

Selects one language from six options: English, German, French, Spanish, Italian and Japanese.

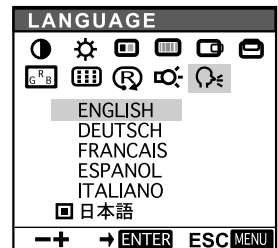

Adjusting Pitch and Phase (analog RGB only)

Some models of computer or graphics card may not allow the Auto Adjust to fully work when the Cintiq is first connected. If the display does not fit the LCD panel border or some part of text show blurred, adjust pitch and phase by following the below procedure. The resolution 1024 x 768 is recommended for the best effect.

- ① From the Wacom Tablet Control Panel, select the CALIBRATION tab.

If you are working with multiple monitors, select the Monitor that corresponds to the tablet's LCD display.

- ② Click on the CALIBRATE... button to display the monitor calibration screen..



- ③ Open the MENU window and select Pitch.

√ Adjust the Pitch level so that the adjustment pattern (fine vertical stripes) displays evenly.

- ⑤ Select Phase and adjust the Phase level so that played the adjustment pattern shows clearly.

≈ After completing the adjustments press the ENTER button 'O' and MENU button 'O' to exit.

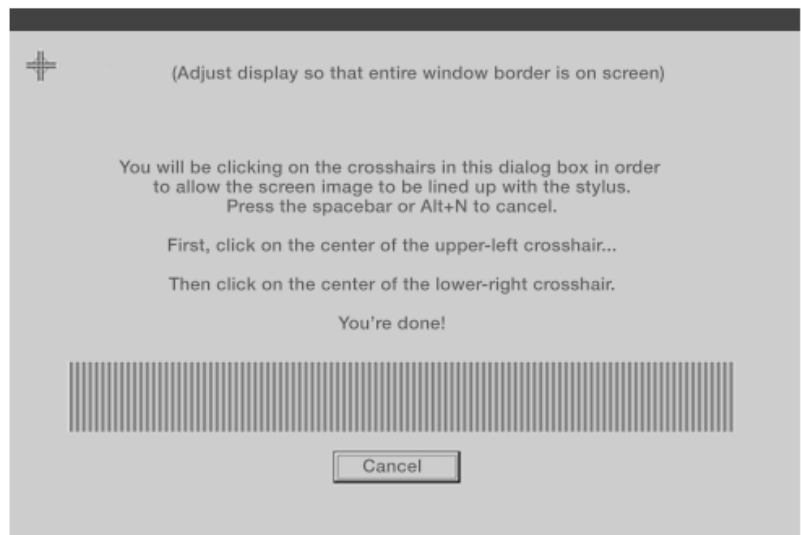

Adjusting the LCD Monitor

HINT (Windows only): You can also adjust Pitch and Phase in the display of closing the Windows.

If the pitch is not calibrated, vertical moire appears in the darkened area. And if the phase is not calibrated, the darkened area ripples.

Power Saving

Cintiq 15X conforms to VESA and Energy Star power saving guidelines. When the Cintiq is used with a VESA DPMS (display Power Management signaling) compliant computer or graphics card, it will automatically comply with the below Power Saving parameters.

Power Saving Mode	H-sync	V-sync	Video	Power Consumption	Power Lamp
Power ON	Yes	Yes	Active	45W max.	Green
Standby mode	No	Yes	Blanked	5W max.	Orange/Green
Suspend mode	Yes	No	Blanked	5W max.	Orange/Green
OFF mode	No	No	Blanked	5W max.	Orange

Caring For Your Cintiq 15X

Cleaning Your Cintiq 15X

To clean the Cintiq 15X casing, use a soft cloth with mild detergent (such as dish washing liquid) diluted with water. Do not use paint thinner, benzine, alcohol, or other organic solvents to clean the Cintiq 15X casing or pen.

Do not use detergent to clean the cover glass. This may alter the surface friction and deteriorate the handwriting feel. To clean the cover glass of the Cintiq 15X, use a soft, dry cloth. If necessary, slightly moisten the cloth with water and try again. When cleaning, apply only a light amount of pressure to the cover glass and do not make the surface wet.

Replacing the Pen Tip

The pen tip will wear with normal use. When the nib gets too short, you can replace it with one of the extra nibs that came with your UltraPen. If the pen tip wears and becomes angular, it may damage the coating on the cover glass of the Cintiq 15X Interactive Pen Display. To avoid this, periodic nib replacement is recommended.

To insert a new nib:

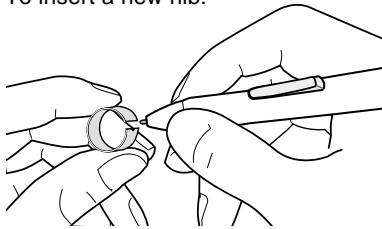

Slide it straight into the barrel of the pen. Firmly push the nib until it stops. The new nib will slide into the correct position.

To remove the old nib:

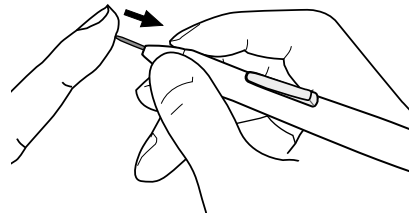

Clasp it with the o-ring tool that came with your UltraPen and pull the old nib straight out of the pen.

CAUTION

Prevent your children from swallowing the UltraPen nib or side switch. The pen nib or side switch may accidentally be pulled out if children are biting on them.

Troubleshooting for Display

If you encounter problems with the Cintiq display, refer to the following tables. Your problem may be described here, and you can try the solution offered.

For problems regarding tablet or pen, refer to the Troubleshooting chapter in the online Help that can be accessed from the Wacom Tablet control panes.

Problem	Hint
<p>The message "OUT OF SCAN RANGE" appears..</p> <div data-bbox="113 503 463 654"><p>i INFORMATION</p><p>OUT OF SCAN RANGE</p><p>xx .xkHz / xxHz</p></div>	<p>The frequency of input signals do not match the Cintiq 15X. Connect different monitor and set the horizontal frequency to some value between 28 to 64 kHz and vertical frequency to same value between 48 to 75Hz.</p>
<p>■ The message "NO INPUT SIGNAL" appears..</p> <div data-bbox="113 741 463 892"><p>i INFORMATION</p><p>NO INPUT SIGNAL</p><p>GO TO POWER SAVE</p></div>	<ul style="list-style-type: none">■ Check the video signal cable, check the connector pins if bent or broken.■ If your computer is in the power management mode, move the mouse or hit any key on the keyboard.■ Check if the graphics card is properly installed.
<p>■ The power lamp show orange LED light, or flashes orange and green</p>	
<p>The message "CABLE DISCONNECTED" appears.</p> <div data-bbox="113 1045 463 1196"><p>i INFORMATION</p><p>CABLE DISCONNECTED</p><p>GO TO POWER SAVE</p></div>	<ul style="list-style-type: none">■ Check the video signal cable, check the connector pins if bent or broken.■ The video signal cable used may not be the one came with the Cintiq 15X. Please use the cable came with the Cintiq 15X.
<ul style="list-style-type: none">■ The power lamp does not light and nothing displays.■ Nothing displays even though power switch is turned on..	<ul style="list-style-type: none">■ Check the power cable and if power switch is ON.■ For DVI, check if DVI/analog RGB switch is turned to the DVI side. ↪ P 6 <p>Restart your computer after switching to the DVI side.</p>

Problem	Hint
<ul style="list-style-type: none"> ■ Display ripples. ■ Display flickers 	<ul style="list-style-type: none"> ■ Adjust pitch and phase. ☞ P16, 18 ■ Check if display adaptor or graphics card matches the Cintiq 15X specifications. ■ Adjust the refresh rate of your computer.
Display is not clear.	<ul style="list-style-type: none"> ■ Adjust contrast or brightness. ☞ P16 ■ Adjust pitch and phase. ☞ P16, 18 ■ Set the refresh rate to XGA (1024 x 768)
Display is doubled or tripled.	<ul style="list-style-type: none"> ■ Do not extend the video signal cable. So not use a input selector. ■ Connect the
<ul style="list-style-type: none"> ■ Display and CLCD panel are not lined-up. ■ Display size is not correct. 	<ul style="list-style-type: none"> ■ Adjust pitch and phase. ☞ P16, 18 ■ Adjust horizontal and vertical position. ☞ P17 <p>Some graphics card may not show display in proper size.</p>
Display is dark.	<ul style="list-style-type: none"> ■ Adjust brightness. ☞ P16 ■ Adjust backlight. ☞ P17
<ul style="list-style-type: none"> ■ Display ripples or shows moire. ■ Color is not even. 	<ul style="list-style-type: none"> ■ Adjust pitch and phase. ☞ P16, 18
White color doesn't show white.	Adjust color. ☞ P17

Specifications

General Specifications

Physical dimensions (WxDxH): 405x340x53mm (excluding the stand)
Weight: 4.9kg (including the stand)
Main Unit input Voltage: DC18V
Power consumption: 45W or less (DC18V)
Operating temp. & humidity: 5 to 35 deg. C, 80%RH (non condensing)
Storage temp. & humidity: -10 to 60deg. C, 90%RH (non condensing) (maximum storage humidity is 38% at 60 deg.C, and maximum storage temperature is 42 deg. C at 90% humidity)

LCD Display

Display: a-Si TFT active matrix LCD
Screen size: 15 in
Resolution (75Hz Max.): 1024x768 pixels (XGA), 800x600 pixels (SGA), 640x480 pixels (VGA)
Pixel pitch: 0.297(W) x 0.297(H)mm
Color depth: 256 levels: 16,777,216 colors (24 bit)
Signal Inputs: Analog RGB: -0.7Vp-p, 75ohms, positive
Synchronous signals: TTL level, 2.2kohms, free polarity (H/V separate or complex sync).
Digital signals: DVI
Synchronous frequency: H--30 to 65kHz, V--50 to 75Hz
DDC2B

Plug and Play

Std. Display Modes (default)

Res. dots x lines	H. freq. (kHz)	V. freq. (Hz)	H/V pol.
720x400	31.50	70.08	-/+
640x480	31.47	59.94	-/-
640x480	35.00	66.67	-/-
640x480	37.50	75.00	-/-
800x600	37.88	60.32	+/+
800x600	46.87	75.00	+/+
832x624	49.73	74.60	-/-
1024x768	48.36	60.00	-/-
1024x768	60.02	75.03	+/+
1024x768	60.24	74.93	-/-

All scan modes are N.I.

Number of programmable 18 (excluding defaults)

On a TFT liquid crystal display, a very small number of pixels may be permanently illuminated or not illuminated at all. This does not mean that the display is defective.

Tablet

Reading technology:	Electromagnetic give and receive method
Active area:	304.1 x 228.1mm
Resolution:	20 lpmm (0.05mm) max.
Accuracy:	+/-0.5mm, four corners (7 mm wide, 25 mm long from each corner of four "L" shaped areas) to be +/-1.0mm
Maximum reading height:	5mm
Maximum report rate:	205 points/sec. max (RS-232C), 100 points/sec. (USB)
Pressure levels	512 levels
Communication I/F	USB, RS-232C

UltraPen

UP-813E

Side switch:	Double (rocker switch)
Pressure:	Tip and Eraser
Tip travel:	0.1mm max.
Eraser tip travel:	2 mm approximate
Tip switch ON load:	30g max.
Physical dimensions, weight:	11.4 dia x 140.5 mm, 12grams

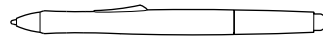

UP-714W (optional)

Side switch:	Single
Pressure:	Tip only
Tip travel:	0.1mm max.
Tip switch ON load:	30g max.
Physical dimensions, weight:	9.0 dia x 140.0 mm, 8 grams

