

# Radio and Television Interference (U.S.A.)

The equipment described in this manual generates, uses, and can radiate radio-frequency energy. If it is not installed and used properly that is, in strict accordance with Wacom instructions it may cause interference with radio and television reception.

## Federal Communications Commission (FCC) Notice

This equipment has been tested and found to comply with the limits for Class B digital devices, pursuant to Part 15 of FCC Rules. These limits are designed to provide reasonable protection against harmful interference in a residential installation.

This equipment generates, uses and can radiate radio frequency energy and, if not installed and used in accordance with the instructions, may cause harmful interference to radio communications. However, there is no guarantee that interference will not occur in a particular installation.

You can determine whether the tablet equipment is causing interference by powering it off. If the interference stops, it was probably caused by the tablet.

If your tablet equipment does cause interference to radio or television reception, you may be able to correct the interference by using one or more of the following measures:

- Rotate the television or radio antenna until the interference stops.
- Move the tablet equipment farther away from the television or radio.
- Plug the tablet equipment and computer into an outlet that is on a different circuit from the television or radio.

If necessary, consult your Wacom dealer or an experienced radio/television technician for help.

Changes or modifications to this product not authorized by Wacom could void the FCC Certification and negate your authority to operate the product.

# Table of Contents

## **Checking Packed Components** **3**

---

## **Installation** **4**

---

- LCD Monitor Installation
- Wacom Tablet Software Installation
- Calibrating the Tablet

## **PL-700 Component Functions** **8**

---

- Front View
- Rear View
- Mounting the PL-700 onto a Mount Arm or Other Stand
- Caring For Your PL-700
- Using the UltraPen
- UltraPen
- Pen Type Settings in the Wacom Tablet Control Panel
- Replacing the Pen Tip

## **Specifications** **13**

---

- General Specifications
- LCD Display
- Tablet
- UltraPen

# Checking Packed Components

In your package you will find the following items:

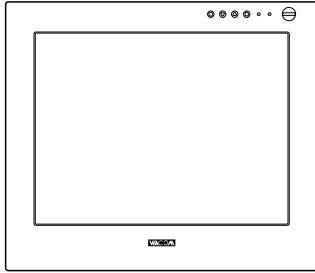

PL-700

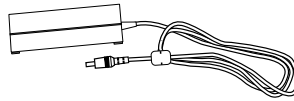

AC Adaptor and Power Cable

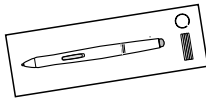

UltraPen with Pen Stand

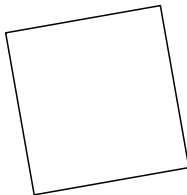

User's Manual

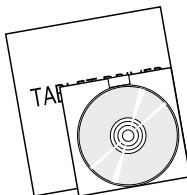

Wacom Software CD  
Contains the Interactive  
Pen Display software  
and a Readme file  
(Windows/Macintosh)

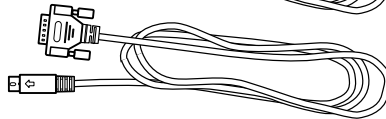

USB Cable or RS-232C Cable

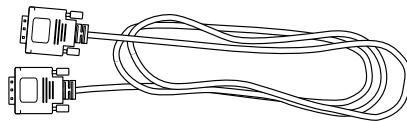
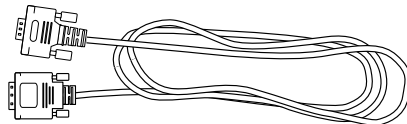

DVI-DVI Cable or DVI-RGB Cable

# Installation

## LCD Monitor Installation

First install the PL-700 as a monitor. Do not connect the USB cable or serial data cable until instructed in the tablet software installation.

① Turn off your computer.

**Caution:** Never connect or disconnect the DVI video cable or power cable while your computer or the PL-700 is powered on. This can damage the LCD display or video card.

② Connect the DVI-DVI cable or DVI-RGB between the PL-700 and your computer.

③ Set the DVI / Analog RGB switch. Turning up is for Analog RGB, and turning down is for DVI.

④ Connect the AC adaptor to the PL-700.

⑤ Connect the AC adaptor power cable and plug the adaptor into an AC outlet.

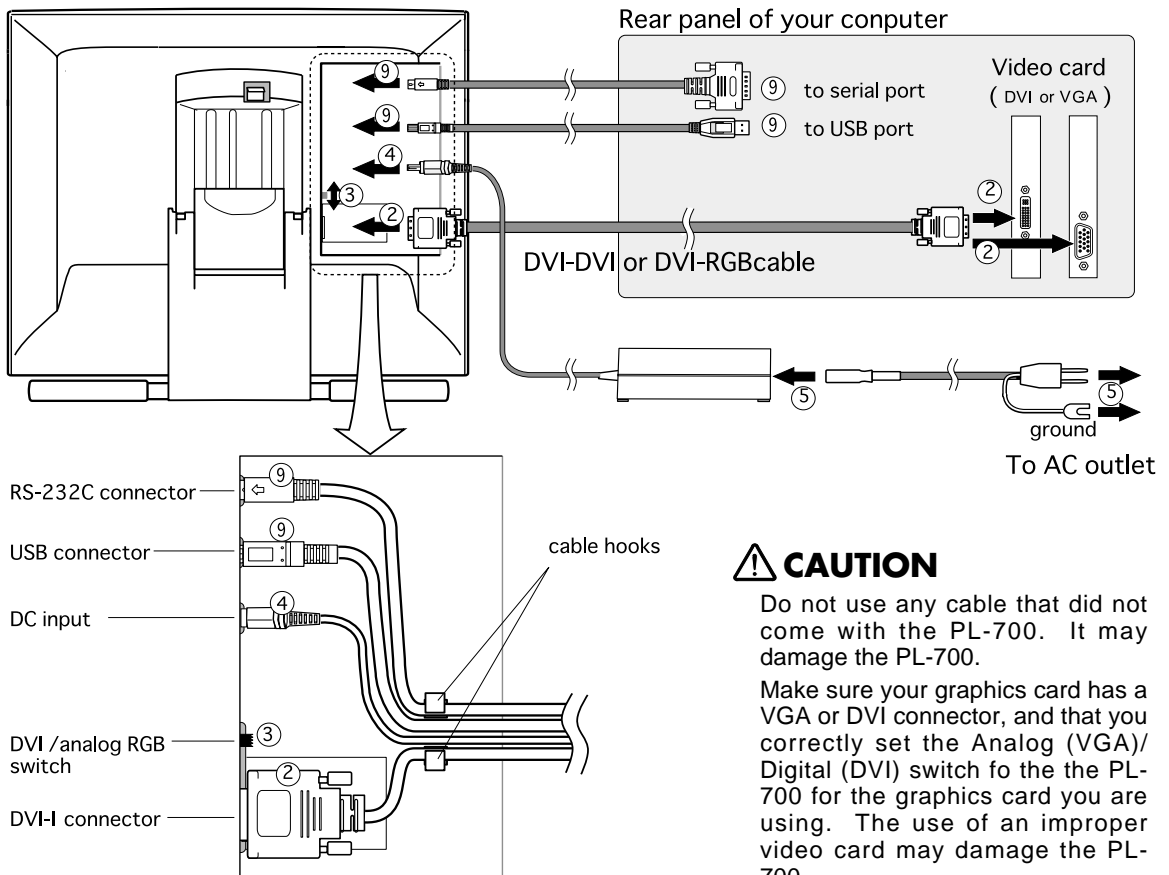

- 
- ⑥ Turn on the power switch of the PL-700. The power lamp will lite green, and then turns orange.
  - ⑦ Turn on your computer to start your operating system.
  - ⑧ As necessary configure the monitor settings for proper size and color resolution. (The recommended resolution is 1280 x 1024. Other settings may give unsatisfactory results.)

the color palett and number of locors are as follows:

- High Color (16 bit), 65,536 color
- True Color (24 bit), 16,770,000 color approximate

The number of colotrs is constrained by the performance of your computer or graphics card. Refere to the documentation of the manufacturer for detaills.

## **Wacom Tablet Software Installation**

After setting the monitor for proper size and color resolution, turn off your computer and connect the USB cable or serial data cable. (⑨)

Then, install the Wacom tablet software. Refere to the Tablet Software Installation Guide for the instructions.

## **Calibrating the Tablet**

As necessary, you can calibrate the tablet in order to line up the screen cursor position with the position of the UltraPen on the Interactive Pen Display. This is required to adjust for parallax caused by the glass overlay. To calibrate the tablet, from the Wacom Tablet Control Panel, select the Monitor tab. Refere to the Wacom Tablet Help for details.

# PL-700 Component Functions

---

## Front View

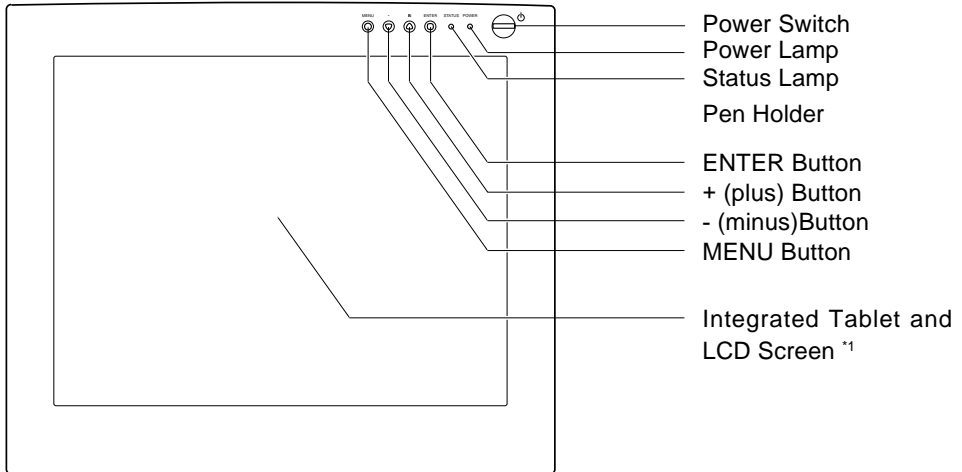

### **Power Switch**

Turns the power to the PL-700 on or off.

### **Power Lamp**

Lights green when power has properly been supplied to the PL-700. Turns orange or flashes when your computer goes into power management mode and stops sending the video signal to the PL-700.

### **Status Lamp**

Lights green when a pen switch is pressed.

### **ENTER Button**

Press this button when you select or exit an item in the OSD menu.

### **+ (plus) Button, - (minus)Button**

Press this button when you change the option or settings in the OSD menu.

### **MENU Button**

Opens or closes the OSD menu.

---

\*1 - On a TFT liquid crystal display, a very small number of pixels may be permanently illuminated or not illuminated at all. This does not mean that the display is defective.

- When pressing the LCD panel hard it may temporarily cause moire to appear. This does not mean the display is defective.
- When a still image is displayed for a long period of time, a n after image may temporarily remain.

---

## Integrated Tablet and LCD Screen

The LCD monitor and tablet sensor function as an integrated input and output device.

The LCD resolution is 1280 x 1024 pixels at 16,777,216 colors. The tablet sensor reports en coordinates, pressure, switch, and eraser information.

## Rear View

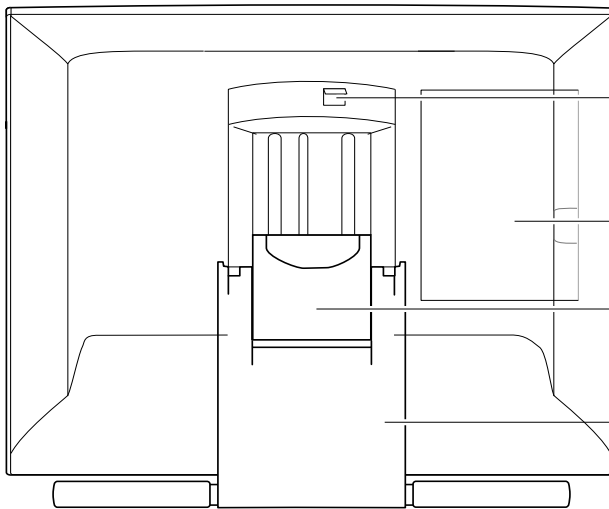

### Stand Lever

Pulling this lever allows the stand to move freely. Releasing the lever locks the stand in place.

### Connector Lid



### CAUTION

Be careful to avoid catching your finger in the gap of the movable portion of the stand.

### Stand

The stand can be used to adjust the tilt angle of the unit from low (18° from horizontal) to high (72° from horizontal).

## IMPOTANT

Be sure to close the stand when packing the Cintiq Interactive Pen Display.

If you do not close the stand, the notched mechanism may be damaged during transportation and storage. Do not lift the PL-700 by the stand; this may damage the stand mechanism. When lifting the PL-700, always do so by grasping the main unit casing.

## PL-700 Component Functions

---

### Mounting the PL-700 onto a Mount Arm or Other Stand

The PL-700 conforms to VESA FPMPM standard.

You can remove the adjustable stand and mount the PL-700 onto a VESA conforming mount arm or stand.

(Screw gap: 75 mm, Thred pitch: 0.7 mm )

- ① Turn off your computer and the PL-700. Then disconnect all cables from the PL-700.
- ② Protect the display screen surface by spreading a soft cloth onto a flat table and placing Cintiq face down on the cloth.
- ③ Remove the four screws and lift the adjustable stand assembly away from the body of the unit.
- ④ Using the appropriate screws for your mounting platform, firmly attach Cintiq to the alternate mounting platform.

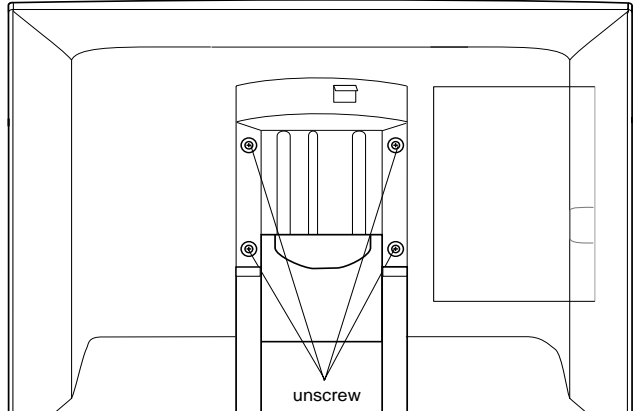

- ⑤ Rettach the cabling and retain the four screws just removed.

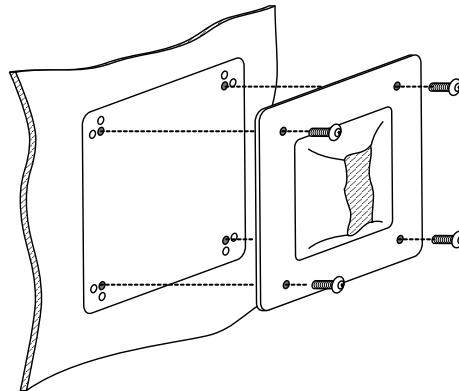

#### CAUTION

When attaching Cintiq onto an alternate mounting platform, be sure to follow all instructions in the documentation supplied by the platform manufacturer. If improperly installed, the unit could fall and be damaged.



---

## **Caring For Your PL-700**

To clean the PL-700 casing, use a soft cloth with mild detergent (such as dish washing liquid) diluted with water. Do not use paint thinner, benzine, alcohol, or other organic solvents to clean the PL-700 casing or pen.

To clean the cover glass of the PL-700, use a soft, dry cloth. If necessary, slightly moisten the cloth with water and try again. When cleaning, apply only a light amount of pressure to the cover glass and do not make the surface wet. Do not use detergent to clean the cover glass; this may damage the coating on the screen.

# Using the UltraPen

---

## UltraPen

Hold the UltraPen as you would a pencil. Make sure the side switch is in a convenient location where you can press it with your thumb or forefinger, but won't accidentally press it while drawing.

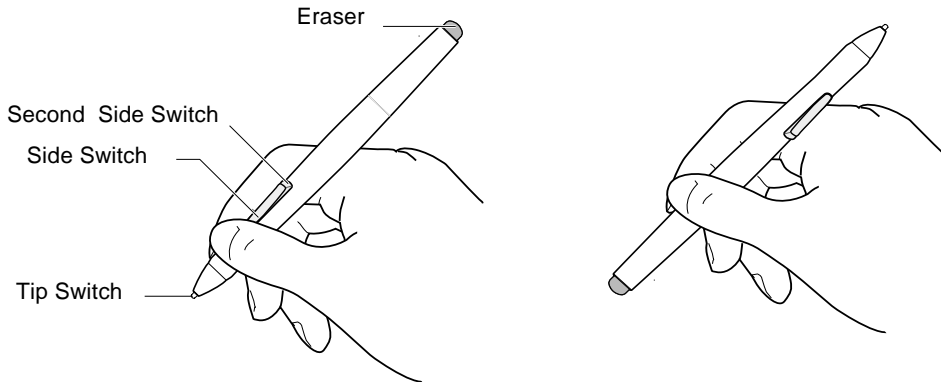

### Pen Tip

When the pen tip is within proximity (5 mm or 0.2 in) of the active area, the tablet reports:

- The x, y coordinates of the pen tip.
- The pressure applied to the pen tip.
- Whether a side switch is on or off.

When pressure is applied to the pen tip, the tip switch is turned on and the pen simulates a mouse button click.

### Eraser

To use the eraser, hold the UltraPen upside down. When the eraser is within proximity of the active area, the tablet reports the x, y coordinates and the pressure applied to the eraser.

The eraser can be used as an eraser or assigned to another function, depending on the application. The tablet distinguishes the tip switch from the eraser switch.

### Side Switch and Second Side Switch

These switches are programmable, and can be used to perform the same click and double-click functions as the tip switch. The switches are turned on when pressed, and are otherwise turned off. Please refer to the online Help for more information on side switch settings.

---

## Using a Pen

### Pointing and Selecting

Move the UltraPen above the Cintiq Interactive Pen Display screen to position the screen cursor.

The cursor instantly jumps to the new location (absolute positioning). Press the pen tip on the Interactive Pen Display screen to make a selection.

**Note:** If the screen cursor is not aligned with the pen tip, you will need to calibrate the Interactive Pen Display.

### Clicking

Tap the Interactive Pen Display screen once with the pen tip, or touch the pen to the display screen with enough pressure to generate a mouse click.

### Double-Clicking

Press the upper side switch (Windows systems) or quickly tap the Interactive Pen Display screen twice in the same place with the pen tip. Double-clicking is easier when the pen is perpendicular to the tablet screen.

### Dragging

Select an object, then slide the pen tip across the Interactive Pen Display screen to move the object.

### Erasing

In supporting applications, the pen's eraser works like the eraser on a pencil. In text applications, use the eraser to select text, then lift the eraser from the tablet to delete the text.

### Replacing the Pen Tip

The pen tip will wear with normal use. When the nib gets too short, you can replace it with one of the extra nibs that came with your UltraPen. If the pen tip wears and becomes angular, it may damage the coating on the cover glass of the Cintiq Interactive Pen Display. To avoid this, periodic nib replacement is recommended.

#### To insert a new nib:

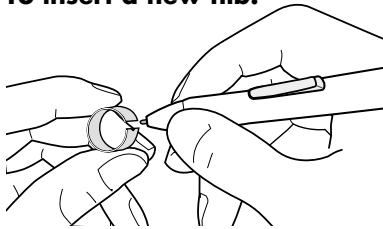

Slide it straight into the barrel of the pen. Firmly push the nib until it stops. The new nib will slide into the correct position.

#### To remove the old nib:

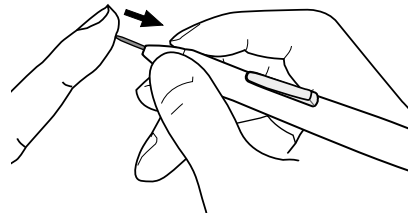

Clasp it with the o-ring tool that came with your UltraPen and pull the old nib straight out of the pen.

#### **CAUTION**

Prevent your children from swallowing the UltraPen nib or side switch. The pen nib or side switch may accidentally be pulled out if children are biting on them.

# Specifications

---

## General Specifications

---

Physical dimensions(WxDxH):	418x362x57mm (excluding the stand)	
Weight:	5.4kg (including the stand)	<= TBD
Main Unit input Voltage:	DC18V	
Power consumption:	45W or less (DC18V)	
Operating temp. & humidity:	5 to 35deg. C, 80%RH (non condensing)	
Storage temp. & humidity:	-10 to 60deg. C, 90%RH (non condensing) (maximum storage humidity is 38% at 60 deg.C, and maximum storage temperature is 42 deg. C at 90% humidity)	

---

## LCD Display

---

Display:	a-Si TFT active matrix LCD
Screen size:	17 in
Resolution(75Hz Max.)	1280x1024 pixels (SXGA), 1024x768 pixels (XGA), 800x600 pixels (SGA), 640x480 pixels (VGA)
Pixel pitch:	0.264(W) x 0.264(H)mm
Color depth:	256 levels: 16,777,216 colors (24 bit)
Signal Inputs:	Analog RGB: 0.7Vp-p, 75ohms, positive Synchronous signals: TTL level, 2.2kohms, free polarity (H/V separate or complex sync.) Digital sygnals: DVI 1.0 Synchronous frequency: H--30 to 80kHz, V--50 to 75Hz
Plug and Play	DDC2B

---

On a TFT liquid crystal display, a very small number of pixels may be permanently illuminated or not illuminated at all. This does not mean that the display is defective.

## Tablet

---

Reading technology:	Electromagnetic resonance method
Active area:	337.9 x 270.3mm
Resolution:	20 lpmm (0.05mm) max.
Accuracy:	+/-0.5mm, four corners ( 7 mm wide, 25 mm long from each corner of four "L" shaped areas) to be +/-1.0mm
Maximum reading height:	5mm
Maximum report rate:	205 points/sec. max.
Pressue levels	512 levels
Communicatin I/F	USB, RS-232C

---

---

# UltraPen

---

## UP-813E

Side switch: Double (rocker switch)  
Pressure: Tip and Eraser  
Tip travel: 0.1mm max.  
Eraser tip travel: 2 mm approximate  
Tip switch ON load: 30g max.  
Physical dimensions, weight: 11.4 dia x 140.5 mm, 12grams

