



**User Manual
and
Integrator's Guide**

**Boomer-III DataTAC
OEM Modem Module:
BM3-800D**

Revision 0.4
October 2003

© Wavenet Technology Pty Ltd
ACN 079 965 003

Publication No. BM310012WT04

Draft October 2003

This publication is copyright and no part may be reproduced or copied without the prior consent of:

| | | |
|-----------------------------|------------|--|
| Wavenet Technology Pty Ltd. | Telephone: | +61 8 9262 0200 |
| 140 Burswood Rd | Facsimile: | +61 8 9355 5622 |
| Burswood, 6100 | E-mail: | wavenet@wavenet.com.au |
| Western Australia | Web Site: | www.wavenet.com.au |

This manual is intended to be used for the operation of Wavenet Technology equipment. Performance figures quoted are typical values and subject to normal manufacturing and service tolerances.

Wavenet Technology Pty Ltd reserves the right to alter, without notice, the equipment, software or specification to meet technological advancement.

Microsoft, Windows and the Windows logo are registered trademarks or trademarks of Microsoft Corporation in the United States and other countries. Other product and company names herein may be the trademarks of their respective owners.

Whilst every precaution has been taken in the preparation of this document, neither Wavenet Technology Pty Ltd nor any of its representatives shall have any liability to any person or entity with respect to any liability, loss or damage caused or alleged to be caused directly or indirectly by the information contained in this book.

Published by Wavenet Technology Pty Ltd.

This product is a modular transmitter approved under FCC Part 2 and Part 90 rules.

800MHz Modem Module - FCC ID: PQS-BM3800D

This device complies with Part 15 Class B of the FCC rules. Operation is subject to the following two conditions:

- (1) This device may not cause harmful interference, and
- (2) This device must accept any interference received including interference that may cause undesired operation.

This product is approved under Industry Canada (IC) RSS119 rules.

800MHz Modem Module - IC: 4062A-BM3800D

Contents

| | |
|--|----|
| Introduction | 5 |
| Modem Features | 6 |
| Wireless Applications | 7 |
| Developer Support | 8 |
| Integrator Developers Kit..... | 8 |
| Compliance Statement | 9 |
| Information for Your Safety..... | 10 |
| The Integrator's Task | 11 |
| Plan the Product and Create the Design | 12 |
| Develop and Validate the Hardware | 15 |
| Develop Supporting Applications Software..... | 16 |
| Test and Approve the Product..... | 16 |
| Environmental Issues | 17 |
| Regulatory Requirements..... | 19 |
| Installing the Modem..... | 25 |
| Mounting the Boomer-III OEM Modem to Your Device | 26 |
| Connecting the Data Interface Port | 27 |
| Selecting & Positioning the Antenna | 39 |
| Supplying Power | 44 |
| Using the Modem Test Jig | 56 |
| Features | 56 |
| Exploring the Boomer-III Test Jig | 57 |
| Initial Calibration | 60 |
| Fitting the Boomer-III Modem | 60 |
| Software Development Tools..... | 62 |
| Wavenet SDK..... | 62 |
| Wavenet Commander | 65 |
| Wavenet Application Loader..... | 69 |
| Integration Testing | 74 |
| Hardware Integration..... | 74 |
| Desense and EMI | 75 |
| Regulatory Compliance | 76 |
| Application Software..... | 77 |
| Final Assembly | 77 |
| End User Problem Resolution | 77 |
| OEM Service Depot Repair | 78 |

Appendix A - NCL Interface80
 Generic NCL (Native Mode) 80
 Wavenet Specific NCL Extensions 85
 Appendix B – SDK NCL-API and Port Server 96
 Appendix C – SDK Sample programs 114
 Appendix D - Application Development..... 118
 Roaming Issues..... 119
 Power Management 123
 Wireless Data Systems Considerations 125
 Appendix E - Message Routing and Migration 128
 Standard Context Routing (SCR) 129
 DataTAC Messaging (DM) 130
 Other Development Issues 130
 Appendix F – Guide to Desense 132
 Noise Sources 133
 Receiver Susceptibilities..... 133
 Measurement Techniques 133
 Alternate Measurement Method 134
 Methods of Controlling Emissions 135
 RF Network Issues 137
 Antenna 138
 Desense Summary 138
 Appendix G - Numeric Conversion Chart..... 140
 Appendix H - Specifications 142
 Appendix I - Glossary..... 144

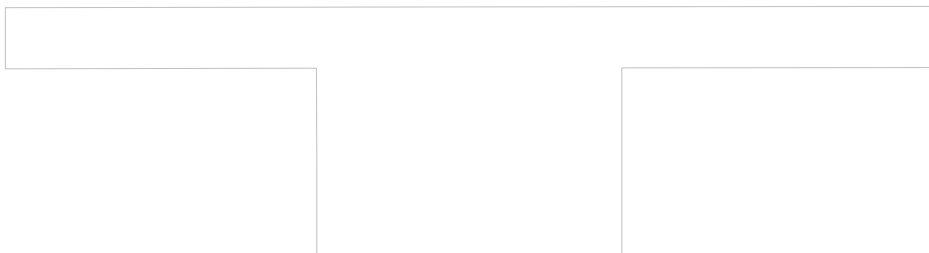
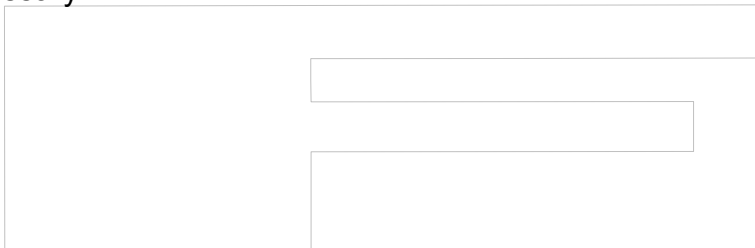

Introduction

The Boomer-III OEM Modem Module is a radio packet modem, intended for use on Motorola DataTAC 4000 SFR and DataTAC 5000 MFR data communication networks.

It is primarily designed to be integrated into customer equipment as an OEM module, for use with an Enterprise Application Server running wireless applications or as the RF communications enabler device for telemetry products. The modem operates on the 800MHz band

Messages from the end user are sent from the host/terminal through the serial interface, and are transmitted by the modem when it is in network contact. Messages to the end user are received and acknowledged by the modem, then passed to the host/terminal.

Within an area of coverage, the modem performs auto-roaming (auto-scanning, channel selection, and registration on a new channel). The modem operates in either battery save or non-battery save modes, as instructed by the network and overridden by the host/terminal. The modem determines which RF protocol to use, based on the attributes specified by the configured channel list, and dynamic channel information from the network.

The modem interfaces to the host/terminal by using the data interface port. The protocol supported over this link is the Native Control Language (NCL).

Although the modem has embedded software, it has no built in application software. All application software must be separately installed and run from the host/terminal to which the modem is connected. A Software Development Kit (SDK) is available and described later in this manual to assist this process.

A picture of the Boomer-III OEM Modem Module is shown below.

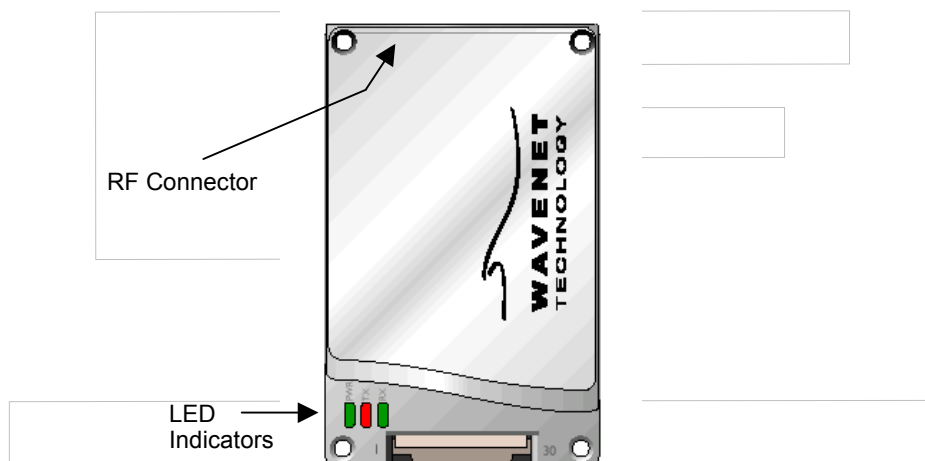

This manual contains the following major sections:

Section 1: Introduction

Section 2: The Integrator's Task

Section 3: Installing the Modem

Section 4: Modem Test Jig

Section 5: Wavenet Software Tools

Section 6: Integration Testing

In addition useful reference information has been included in the appendices.

Modem Features

The Boomer-III OEM Modem is smaller than the average size of a credit card. The modem is easily connected to many other devices and can be incorporated into a variety of package formats.

The Boomer-III OEM Modem has the following features:

Up to three UART Serial communications interface ports and one SPI port

On-Board Real Time Clock with battery back input option

Indicator lights showing power supply and data status

Five configurable multiple function digital/analogue inputs or five digital output lines for external control/monitoring

Software configurable RF calibration adjustments to suit specific networks

High sensitivity reception

Small footprint and low profile design

Low-voltage and low standby current consumption for battery based products

Auto-wake up of host/terminal on incoming messages

Roaming capabilities as defined by the network

Easy to install, service and update

Wireless Applications

Wireless applications in which the Boomer-III OEM Modem may be used include the following:

Meter Reading

The modem can be used to read billing information from intelligent electrical meters and basic disc meters. Data is transmitted wirelessly through a radio network to billing computers.

Point of Sale

The modem can perform handshaking and complete verification of all data transmitted through the wireless network whilst providing convenient operator mobility such as open air events or conferences.

Vending Machines

Vending machines can also utilise radio data technology. Many machines already transmit usage and refill requirements to company head offices via standard telephone lines. Radio modems allow vending machines to be placed in areas with poor access to telecommunications infrastructure, providing a cost-effective alternative to installing new telephone lines. On refilling, only the required refills will be despatched to the required sites maximising truck carrying capacity and consequently efficiency.

Alarm Detection

Conventional telephone wire connections are slow to dial out and can burn before the emergency call can be placed. Laws in many states and countries require businesses to have an on-line dial out fire alarm system. The Boomer-III OEM Modem offers a real solution to this problem.

Parking, Buses and Ticketing

Ticketing machines are being converted to cashless operation. The Boomer-III OEM Modem is the best alternative to facilitate the introduction of this cashless technology.

Developer Support

A complete developers program is offered by Wavenet to assist integrators in the design, testing and implementation phases of their wireless applications. This includes a developer's kit, modem software tools, sample source code and prototyping components. Wavenet's experienced team of RF and software engineers are available to give technical support as required.

Integrator Developers Kit

To facilitate the rapid development and deployment of wireless applications, Wavenet has available an Integrator Developers Kit which contains all the components necessary to get an evaluation and development platform up and running in the shortest possible time. The kit contains the following components:

Evaluation Board for interface to a PC for testing (Boomer-III Modem Test Jig)

Power cable for connection to a variable power supply

800 MHz (blue tip) antenna

Antenna cable

PC Serial interface cable

5 sample FPC strips for prototyping purposes

5 sample FPC connectors for prototyping purposes

Software Developers Kit on CDROM containing Integrators Guide and User Manual, Modem communications software, device drivers and sample source code

System Requirements

The minimum system requirements of a host/terminal emulation PC in order to utilise the Integrator Developers Kit are:

Intel compatible Pentium computer or higher

Windows 2000 or later

16MB RAM (memory) minimum, 32MB recommended

1MB available hard disk space

9-pin serial Port using a 16550 UART

3.5-inch Disk Drive

CD-ROM drive

Compliance Statement

The Wavenet Boomer-III OEM Modem Module has been tested and found to comply with the limits for a Class B digital device, pursuant to Part 15 of the FCC rules. These limits are designed to provide reasonable protection against harmful interference in a residential installation.

Output is specified at the antenna terminal of this module. This modular transmitter is only approved for OEM integration into final products that satisfy mobile operating requirements of 2.1091 of the FCC rules. The final product and its antenna must operate with a minimum separation distance of 20 cm or more from all persons using the antenna with maximum average gain not exceeding 5dBi to satisfy MPE compliance. Separate approval is required for this module to operate in portable products with respect to 2.1093 of FCC rules.

Wavenet has obtained certificates of Technical Acceptability for use in Canada in accordance with the Radio Standards Procedure RSP-100 and Radio Standards Specification RSS119, Issue 3.

This equipment generates, uses and can radiate radio frequency energy and, if not installed and used in accordance with the manufacturer's instructions, may cause interference harmful to radio communications.

There is no guarantee however, that interference will not occur in a particular installation. If this equipment does cause harmful interference to radio or television reception, which can be determined by turning the equipment off and on, the user is encouraged to try to correct the interference by one or more of the following measures:

Reorient or relocate the receiving antenna.

Increase the separation between the equipment and receiver.

Connect the equipment into an outlet on a circuit different from that to which the receiver is connected.

Consult your supplier or an experienced radio/TV technician for assistance.

Warning: *Changes or modifications to this unit not expressly approved by the party responsible for compliance could void the user's authority to operate this equipment.*

Information for Your Safety

Please read these safety instructions and the operation instructions provided in this manual before operating the Boomer-III OEM Modem.

Safe Use

Switch the modem off in areas where radio devices are forbidden, or when it may cause interference or danger. For example, fuel depots (fuel storage and distribution areas), chemical plants, and locations in which hazardous or combustible gases may be present and where blasting operations are in progress.

Do not use the modem in an aircraft. Such use may affect aircraft instrumentation, communication and performance and may be illegal.

Be aware that the modem may interfere with the functionality of inadequately protected medical devices, including pacemakers. Additionally, the effect of the radio signals from the modem on other electronic systems, including those in your car (such as electronic fuel-injection systems, electronic anti-skid braking systems, and electronic cruise-control systems) may affect the operation of these systems, which should be verified before use in the applications

Do not place the modem on an unstable surface. It may fall and damage the equipment.

Never push objects of any kind into the modem through openings as they may short out parts that could result in a fire or electrical shock. Never spill liquid of any kind on the modem. Do not use the modem near water (for example near a bathtub or sink, in a wet basement, near a swimming pool etc.). The modem should be situated away from heat sources.

Disconnect the modem from the power source before cleaning. Do not use liquid or aerosol cleaners. Use a damp cloth to clean the unit.

Disconnect the modem from the power source and contact your supplier if:

Liquid has been spilled or objects have fallen onto the modem.

It has been exposed to rain or water.

It has been dropped or damaged in any way.

It does not operate normally by following the instructions contained in this manual.

It exhibits a distinct change in performance.

Failure to observe all these instructions will void the limited warranty.

The Integrator's Task

This section provides background information and points out the objectives and tasks of reaching the goal of a successful implementation.

Areas of Focus

Serial Port
Pass-Through Capability

Benefits

- ❑ Enables modem diagnostics and software upgrades without the need to disassemble the host/terminal

Understanding RF Design

- ❑ Provides the required network coverage.
- ❑ Sets end-user performance criteria.
- ❑ Reduces risk of costly redesigns.

Software & Hardware

- ❑ Provides reliable operation through a state-of-the-art functional interface.
- ❑ Helps ensure longer service life and fewer field returns.

Because wireless data communication technologies are usually described using a unique variety of jargon, buzzwords, and technical details, it is sometimes hard to know where to start. You may also have difficulty evaluating this technical information when you find it.

As an OEM integrator, you must accurately choose where and how a wireless technology will facilitate communication for your application. You will also have to evaluate which technical considerations will give your product an edge over the competition.

To successfully integrate the Boomer-III OEM wireless modem into the host/terminal, you must perform the following tasks:

- ❑ Plan the product and create the design
- ❑ Develop and validate the hardware
- ❑ Develop supporting applications software
- ❑ Test and approve the product

As you review these tasks, allow sufficient time for such required activities as the regulatory approval process. Identify critical path activities up front.

Plan the Product and Create the Design

To plan the product and create the design, perform the following steps:

- ❑ Develop a usage model.
- ❑ Develop a message model.
- ❑ Define a service strategy.
- ❑ Investigate and obtain regulatory approval.

Develop a Usage Model

The usage model answers the question, “How will the end product be used (portable or mobile; 8 hours, 7 days a week; and so on)?”

Perhaps the most important enabler of success is a clear determination of how the final product is to be used. This steers the development process, because all design considerations drive toward meeting the needs of the final user. For example, design issues related to a mobile device, such as alternator noise and vibration, are completely different from considerations required for a fixed-point telemetry application powered by a solar panel. Defining what is and what is not important to the end user helps to make the critical engineering trade-off decisions that are inevitable in every product design.

Develop a Message Model

The message model defines how many messages are sent/received and how often. To create the message model, determine how much and how often data will be sent in each of the uplink (terminal to network) and downlink (network to terminal) directions.

Answer the question, “Is there a requirement for the terminal to be on and able to receive 8 hours a day, or does the user turn the unit on only when making a query to the Enterprise Server Application?” The answer has a direct bearing on the battery size and capacity requirement for powering the device. The amount of data sent and received is relevant in calculating the cost of airtime and deciding on which type of network connection to use. In short, the message model is required source data for making many engineering design decisions, especially in calculating such values as sleep time versus wake time and in determining battery capacity requirements.

For additional information, refer to section “Message Traffic Model” on page 46. The typical approach to creating the model is to define the peak and average network throughput requirements based on input from the user. Wavenet Technology is able to provide current consumption figures for each of the various modes of operation (receive and transmit, for example) and explain the functionality of the network Power Save protocol.

The network throughput of the host/terminal depends on many factors in addition to the raw throughput of the radio channel. For example, in addition to the overhead involved in forward error correction and

support for packet headers, the number of active users on a shared RF channel can directly affect network throughput.

Define a Service Strategy

The service strategy determines whether the integrated modem is the cause of a user's problem and sets a policy for keeping the end user operational during repair. The service strategy must consider all potential service situations and evaluate them in light of the usage model.

To ensure that a final product can be efficiently serviced, you must design for service-ability early in the development process. At a minimum, you must develop a functional service strategy that contains a well-considered procedure for performing unit-level screening. The test must primarily determine whether a fault lies with the modem or with the product. The test must also screen for network problems and human error.

Wavenet provides an evaluation board (a standalone test jig) and various software test utilities. The evaluation board provides a mounting platform and electrical interface to the modem. Testing is performed much more efficiently while the modem is still integrated within the host/terminal, whether for a factory end-of-line test or while at the user's site.

For your product to allow integrated testing of the modem, you are required to provide modem pass-through mode and utilise Wavenet Commander software. See "End User Problem Resolution" on page 77. Without pass-through, the modem must be mounted on the evaluation board for diagnostics and troubleshooting. Pass-through mode also allows for modem software upgrades.

A thoroughly developed OEM serviceability plan typically includes a needs assessment for developing software utilities that can assist in identifying communication problems between the host/terminal and the modem and between the modem and the RF network.

These utilities must be able to send commands to the modem, evaluate the modem responses, perform network connectivity testing, and verify data communication with the network.

The utilities can be developed using NCL. This link-layer protocol set provides the capability to monitor and evaluate the modem's operating condition and all communications to and from the network Enterprise Server Application. NCL 1.2 uses a command-response functional model. First, the network Enterprise Server Application asks for modem status and status of network connectivity.

The modem then responds with its status and the state of network connection management.

Such a software utility is essential for field service engineers and shop technicians to diagnose problems with the product and to troubleshoot a problem to a failed assembly or mismanaged communication link.

Diagnostic Capabilities

To provide modem diagnostics, there are three LEDs on the modem itself. When the unit is first powered up it goes through its own self test and the status is reflected in the visual status of the LEDs.

Customer Problem Isolation

When application-visible problems are discovered in the field, you must isolate the source of the problem. Is it the network, wireless modem, or the host/terminal that is not working as expected? Often it can be a user's misunderstanding of how to use the product.

Regardless, remote troubleshooting is essential to reducing the number of returned products and lowering service costs, particularly if the host/terminal must be disassembled for removal of the modem.

Wavenet recommends that your product application (both at the terminal and Enterprise Server Application ends) incorporate sufficient problem diagnostic software to determine the cause of the problem remotely. Often, the best approach is to incorporate progressively deeper loop back tests to determine the point at which the communication link fails.

As stated elsewhere, you need to make this remote diagnostic functionality be part of your standard software load.

End User Support

You have two choices in dealing with an integrated modem that needs to be swapped out and returned for service:

- Decommission the modem and re-use the LLI
- Replace the modem

If you decommission the modem Id (the LLI) from the defective unit and transfer it to a replacement unit, the user and the network operator are unaffected. This can only be done by an authorized Wavenet service centre with the appropriate permissions and authority. If you simply swap the defective unit with a replacement, the user must notify the network operator.

Investigate and Obtain Regulatory Approval

Most countries where the final product will be sold currently require approval from the local government regulatory body. It is your responsibility to investigate and obtain the proper regulatory approval and certification for each country in which the product is sold.

Regulatory issues are discussed in more detail in "Regulatory Requirements" on page 19. In addition, see "Regulatory Compliance" on page 76.

Develop and Validate the Hardware

To develop and validate the hardware, perform the following steps:

- ❑ Design the hardware platform
- ❑ Consider power supply options
- ❑ Select the source antenna
- ❑ Set up a development test environment

Design the Hardware Platform

Integrating a wireless modem into a hardware design requires many steps. Here again, the usage and message models are necessary to calculate issues such as battery size, heat dissipation, isolation from EMI, and physical mounting of the unit to ensure proper grounding.

Hardware design is your responsibility. Wavenet can provide recommendations where applicable and may also assist with verification of EMI-caused desense once the modem is integrated into the host/terminal.

Consider Power Supply Options

Power supply requirements vary according to the usage and message models. Beyond accounting for the current drain of the modem in its various operating modes, consider ripple and noise on the power lines, and the ability to supply sufficient instantaneous current to allow proper operation of the transmitter. Also, ensure that the power supply can accommodate the highest power consumption under transmit conditions and that the voltage does not fall below the minimum levels at the modem terminals. (Remember voltage drops can occur in the interconnectivity wiring and this must be kept as short as possible.)

Together, these requirements define the type and size of power supply to use with the modem. These issues are discussed in more detail in the sections "Supplying Power" on page 44 and "Batteries" on page 51.

Important: *Avoid use of switching power supplies. They can easily cause RF noise that desenses the modem.*

Select the Source Antenna

The ERP (Effective Radiated Power) generated by the antenna must meet the requirements of the various network operators. Consider these network requirements when you select an antenna system. See "Connecting & Positioning the Antenna" on page 39.

Set Up a Development Test Environment

A number of development test aids are available to assist in hardware and applications development. Wavenet can provide both the modem hardware and an evaluation board. The evaluation board is a specially developed circuit board with test points and jumper switches. The

evaluation board allows for maximum flexibility in accessing and controlling connections into and out of the modem. Wavenet also provides various software utilities that can help in performing development tests. See “Testing” on page 74.

Supplementing the test environment, the network operator sometimes provides a live development network, one separate from the production network on which you can develop and test your application.

Develop Supporting Applications Software

To develop supporting applications software, perform the following steps:

- Select a communications model
- Develop end-to-end applications software

Select a Communications Model

Select a communications model. Most vertical market applications use fleet (SCR) connections to a single Enterprise Server Application, whereas horizontal applications typically use a gateway to allow connection to the Internet or other external networks. See “Air Interface Protocols” on page 22.

Develop End-to-End Applications Software

In addition to coding the product-specific features for your application, you are urged to incorporate RF-specific reporting and monitoring features, such as received signal strength (RSSI), channel quality, and in-range/out-of-range conditions. Many applications track the number of packets sent and received and the various events and status indicators available from the modem. The Boomer-III modem uses a packetised serial interface (Native Control Language 1.2) to allow the application to simultaneously monitor RF-related information and application-specific data.

Test and Approve the Product

To test and approve the product, perform the following steps:

- Perform EMI and desense testing
- Set up a final test environment
- Install and field test the product

Perform EMI and Desense Testing

Proper modem operation requires that you minimize EMI (electromagnetic interference) radiated from your product's platform. Excess noise significantly reduces the wireless modem's ability to receive, making the network less likely to be heard.

Wavenet provides a test facility for measuring host/terminal emissions and subsequent modem desense of integrated host/terminals. See "Desense and EMI" on page 75. In addition, see "Guide to Desense" on page 132.

Set Up a Final Test Environment

To ensure proper assembly of the final product (antenna properly connected, serial port operational, and so on), perform an end-to-end test that proves the final product can receive and transmit at the required signal levels.

In locations where the final assembly test is performed within network coverage area, this test is relatively simple. In some countries the network operator may provide a dedicated test network for this purpose. You should consult with the relevant network operator for assistance prior to any testing commencing on a live or test network. In locations where network coverage is not available, or for products to be shipped to another country, it is necessary to test by secondary means.

The final assembly test must verify that all connections to the modem are made correctly. Testing on a network is not required. See "Final Assembly" on page 77, and "End User Problem Resolution" on page 77.

Install and Field Test the Product

When the product is shipped to a site, it is installed or mounted in a particular location, one that might restrict RF communications. The service question is whether the behaviour of a dysfunctional product is caused by poor coverage or a network service provider is down. To guarantee that the modem is located in an area of good coverage and that an end-to-end loop back message is possible, your product needs a software application to perform the test.

Your most effective approach to field testing is to include an installation test procedure as part of your standard software load. See "Final Assembly" on page 77 and see "End User Problem Resolution" on page 77.

Environmental Issues

The Boomer-III OEM modem is designed for a combination of easy serviceability and general ruggedness but are designed to be housed in a host/terminal. The modem is tested to conform to the environmental levels (for example, industrial use specifications and PC card standards) that meet the intended applications of most integrators. If you need additional ruggedness and safety in your products, you must engineer the environmental characteristics of your host/terminal to achieve a special safety rating.

General Precautions

- ❑ Minimise handling of static sensitive modules and components.
- ❑ Wear a grounded anti static wrist strap while handling static sensitive components.
- ❑ Do not bend or stress the modem in any way.
- ❑ Reinsert connectors straight and evenly to avoid causing short and open circuits.

ESD Handling Precautions

The Boomer-III OEM modem contains components sensitive to ESD (electrostatic discharge). For example, people experience up to 35kV ESD, typically while walking on a carpet in low humidity environments. In the same manner, many electronic components can be damaged by less than 1000 volts of ESD. Although the Boomer-III modem has been designed with a high level of ESD protection you should observe the following handling precautions when servicing host/terminal devices:

- ❑ Always wear a conductive wrist strap.
- ❑ Eliminate static generators (plastics, Styrofoam, and so on) in the work area.
- ❑ Remove nylon or polyester jackets, roll up long sleeves, and remove or tie back loose hanging neckties.
- ❑ Store and transport all static sensitive components in ESD protective containers.
- ❑ Disconnect all power from the unit before ESD sensitive components are removed or inserted, unless noted.
- ❑ Use a static safeguarded workstation, which can be set up by using an anti static kit. This kit typically includes a wrist strap, two ground cords, a static control table mat, and a static control floor mat.

When anti static facilities are unavailable use the following techniques to minimize the chance of damaging the equipment:

- ❑ Let the static sensitive component rest on a conductive surface when you are not holding it.
- ❑ When setting down or picking up the static sensitive component, make skin contact with a conductive work surface first and maintain this contact while handling the component.
- ❑ If possible, maintain relative humidity of 70-75% in development labs and service shops.

Regulatory Requirements

You are required to obtain regulatory approval of products that integrate the Boomer-III OEM wireless modem into a host/terminal. The specific details for achieving regulatory approval vary from country to country.

Worldwide, government regulatory agencies for communications have established standards and requirements for products that incorporate fixed, mobile, and portable radio transmitters. The Boomer-III OEM modem is certified in specific regional markets to levels of compliance appropriate for an integrated device.

Modem Only Certification

The non-integrated modem meets the regulatory requirements for the countries listed below (but related certification does not necessarily exist):

| Country | Regulation Agency | Related Requirements | Modem Model | Approval Number |
|--------------------------|---|--|-------------|-----------------|
| Australia | Australian Communications Authority (ACA) | FCC compliance is accepted | BM3-800D | Not applicable |
| Canada | Industry Canada (IC) | RSS119 – Radio Performance | BM3-800D | 4062A-BM3800D |
| United States of America | Federal Communications Commission (FCC) | FCC CFR Title 47, Part 15 Conducted and Emitted Radiation Class B FCC Part 90 – Radio Performance | BM3-800D | PQS-BM3800D |

Full Product Certification

As the integrator, you must determine what additional specific regulatory requirements are required for the country in which your product is sold. This means, your product must be individually certified, even though the Boomer-III OEM Modem Module may already be approved. The certification process includes submittal of prototype products and acceptable test results.

Integrators can use Boomer-III OEM Modem Module certifications to facilitate this integrated-product approval process. Upon request, Wavenet can send copies of the certifications and related information.

Be prepared for the certification process for your product to take from a few weeks to several months. Its duration can be affected by safety requirements, the type of product, and the country in which you are seeking approval.

Country Requirements

The country requirements given below are provided as a general guide to the certification processes in the regions and countries given. You

are strongly encouraged to use the services of a consultant or a full-service test house if you have limited expertise in meeting the regulatory requirements of a specific country.

All certification tests must be made by a qualified laboratory to ensure that the equipment complies with the applicable technical standards.

United States of America

The Federal Communications Commission (FCC) requires application for certification of digital devices in accordance with CFR Title 47, Part 2 and Part 15. A Wavenet Boomer-III OEM Modem Module is part of a complete system and certain testing is necessary for the integrated product.

FCC Part 15, Class A or B certification (dependant upon final integrated product type) must be performed with the maximum configuration use and include all peripherals of the integrated product. The application for certification must refer to the approval data on file for the particular Boomer-III Modem Module, as shown in the following example. Include the following language in the documentation inserting the name of the integrated product in place of xxx below:

“The Wavenet Boomer-III OEM modem module is a subassembly of xxx and has FCC Identifier PQS-BM3800D”

FCC Part 2 certification requires all integrated products to have routine environmental evaluation for radio-frequency (RF) exposure prior to equipment authorization or use in accordance with FCC rules 2.1091 and 2.1093 and FCC Guidelines for Human Exposure to Radio Frequency Electromagnetic Fields, OET Bulletin 65 and its Supplement C.

For “**portable devices**”, defined in accordance with FCC rules as transmitting devices designed to be used within 20 cm of the user body under normal operating conditions, Specific Absorption Rate (SAR) testing must be performed and the unit re-submitted for separate FCC certification approval. An exposure limit of 1.6 W/kg will apply to most OEM integrated applications.

For “**mobile or fixed devices**”, defined as transmitting devices designed to be generally used such that a separation distance of at least 20 cm is maintained between the body of the user and the transmitting radiated structure, Maximum Permissible Exposure (MPE) limits may be used with field strength or power density limit of 0.54 mW/cm² (at 806 MHz).

Wavenet submitted module specific information and test reports for generic MPE compliance. If the Boomer-III OEM Modem Module is used in a mobile or fixed application with an antenna system gain less than 5dBi, the MPE limits will not be exceeded. In this case, the following clause should be included in the installation and user documentation:

"To satisfy FCC RF exposure requirements a separation distance of 20 cm or more should be maintained between the antenna of this device and persons during device operation. To ensure compliance, operations at closer than this distance is not recommended."

If an antenna system is used which has an average gain greater than 5dBi then the integrated product must be re-tested as a complete unit and submitted with its own FCC ID.

It is mandatory for portable integrated products such as handheld and body-worn devices to comply with FCC guidelines for Specific Absorption Rate (SAR) requirements. Refer to OET Bulletin 65 and Supplement C (June 2002). The submission should include end product information, end product SAR/MPE test report, and a reference to the Wavenet Boomer-III OEM Modem Module FCC ID for all other Part 90 requirements.

It is a requirement for integrated product certification that you provide the following statement in user documentation:

"Regulatory Notice of Compliance

This equipment has been tested and found to comply within the limits for a Class B digital device, pursuant to Part 15 of the FCC Rules. These limits are designed to provide reasonable protection against harmful interference in a residential installation.

This equipment generates, uses, and can radiate radio frequency energy and, if not installed and used in accordance with the instructions, may cause harmful interference to radio communications. However, there is no guarantee that interference will not occur in a particular installation. If this equipment does cause harmful interference to radio or television reception, which can be determined by turning the equipment off and on, the user is encouraged to try to correct the interference by one or more of the following measures:

- Reorient or relocate the receiving antenna.
- Increase the separation between the equipment and receiver.
- Connect the equipment into an outlet on a circuit different from that to which the receiver is connected.
- Consult the dealer or an experienced radio/TV technician for help."

Labelling

The FCC requires the integrated product to be labelled as shown here:

"This product contains a type-accepted transmitter approved under FCC ID: PQS-BM3800D."

Refer to FCC CFR 47, Part 2, Subpart J for information on obtaining an FCC grantee code, FCC identifier requirements, label requirements, and other equipment authorisation procedures.

The FCC does not permit use of an FCC identifier until a Grant of Equipment Authorisation is issued. If you display a device at a trade show before the FCC has issued a grant, the following statement must be prominently displayed:

“This device has not been approved by the Federal Communications Commission. This device is not, and may not be, offered for sale or lease, sold or leased until the approval of the FCC has been obtained.”

Canada

Industry Canada (IC), formerly the Department of Communications, requires certification for all radio transceivers as either type-approved or technically accepted.

If you do not make any physical or electrical changes to the Boomer-III OEM modem and you add an antenna externally to your host/terminal, you are not required to make a formal application to Industry Canada, because Boomer-III OEM modems continue to be covered under the original Radio Equipment Certificate of Type Approval.

Most of the tests required for FCC applications can be used for Industry Canada applications. IC requires additional tests, which distinguishes their certification process as unique.

The Radio Standards Procedure RSP-100 describes the procedure for obtaining certification of radio equipment and labelling requirements. These documents are available upon request from Industry Canada in Ottawa or from their website at

http://spectrum.ic.gc.ca/~cert/certprocedures_radio_e.html .

Labelling

Industry Canada requires OEM products to be labelled as follows:

IC: XXXX-BM3800D

Or,

IC: XXXX-BM3800D

Where XXXX represents the number supplied to the OEM by Industry Canada.

Air Interface Protocols

Data exchange protocols transport data between the host/terminal and the network. Within the radio portion of the network, between the device and the base station, specialized RF protocols (RD-LAP or MDC4800) carry the data. These radio protocols are typically transparent to wireless applications.

The modem communicates over radio frequency channels using the RD-LAP 9.6, RD-LAP 19.2, or MDC 4800 protocols over 12.5 or 25kHz RF channels. The network-specific configuration is constant for all like devices on the network and includes the channel list and the system ID.

The modem has dual protocol capability on DataTAC 4000 systems in the United States and Canada. The modem's RF protocol is based on the attributes specified by the configured channel list, and dynamic channel information from the network.

On DataTAC 5000 systems, only the RD-LAP protocol is supported. The modem performs auto-roaming (that is, auto-scanning, channel selection, and registration on a new channel). Battery-save operation (Power Save protocol) is supported within most DataTAC networks.

RD-LAP Network Operation

The RD-LAP 9600 and 19200 protocols are used by DataTAC 4000 and 5000 networks. The modem supports both continuously keyed, multiple channel (MFR) and intermittently keyed, SFR (single frequency reuse) network configurations, depending on the network type. The RD-LAP protocol specifications provide the reference RF protocol link-access procedures supported by the wireless modem.

While on the network, the modem performs auto-roaming and battery-save (Power Save protocol) functions.

MDC 4800 Network Operation

The MDC 4800 protocol is available exclusively on Motient (United States) and Bell Mobility (Canada) networks. The modem supports intermittently keyed, SFR network operation.

Note: *On Motient and Bell Mobility networks the modem operates in either MDC 4800 mode or RD-LAP 19200 mode, as provided by local coverage, however, it is recommended contact be made with the relevant network operators to confirm specific details.*

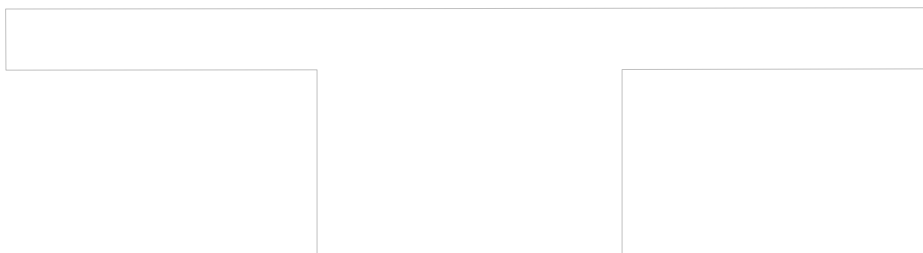
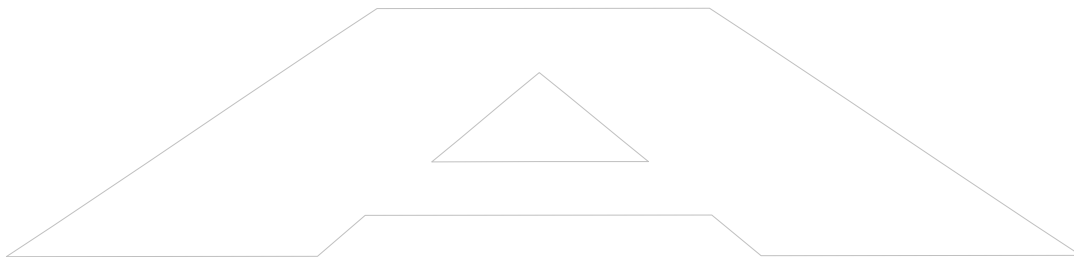
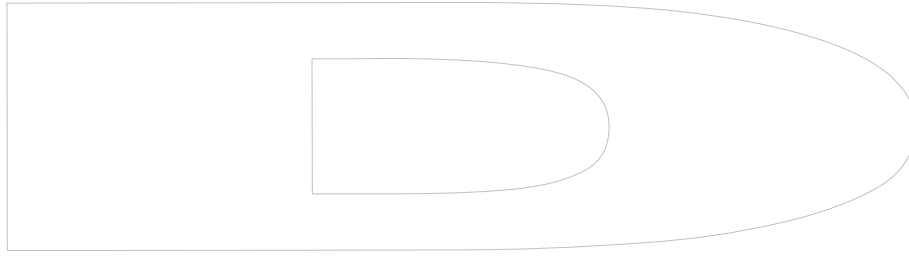

Installing the Modem

This section will help you to successfully integrate the Boomer-III OEM Modem into your custom application.

When integrating a wireless modem, internal connections and placements are critical to a successful implementation. Specific attention must be paid to the following support mechanisms:

- ❑ Mechanical mounting
- ❑ Serial interface and control
- ❑ Antenna connection
- ❑ Regulated power supply
- ❑ Application software
- ❑ Desense control

The OEM wireless modem is well suited for mobile or fixed applications. Ruggedised and capable of operating in extreme environments, the modem can provide communications for a wide variety of products.

Handheld Portable Terminal Use

Without question, handheld designs produce the most hostile environment for an integrated modem. A handheld device, such as a portable terminal, is typically battery powered, subjected to temperature extremes, and designed to be physically robust.

When designing portable devices, you must consider the following issues:

- ❑ DC power noise levels on the host/terminal interface
- ❑ Minimum operating voltage levels
- ❑ Shutdown procedures
- ❑ Device internal ambient temperature
- ❑ Antenna gain and proximity to user
- ❑ Repair and reprogramming facilities (pass-through mode of operation)
- ❑ Mechanical design for drop, vibration, dust, salt, and liquid spill

Note: *Regarding the mechanical design, the Boomer-III OEM modem is designed assuming that the host/terminal controls these conditions.*

Fixed Mount Usage

Fixed-mount usage eliminates most of the mechanical constraints of handheld designs, although the requirements still apply. Fixed-mount units are sometimes AC-line powered and require filtering to eliminate the 50Hz or 60Hz noise that can impair modem operation, depending upon country of use.

Other considerations include mobile usage, which typically implies vehicular applications. Some of the design implications of mobile usage include:

Resets

The design must attempt to eliminate modem resets caused by supply voltage drops while the vehicle is starting. This is very disruptive to the network link.

Supply and Noise Levels

Special care is required to ensure the modem is not subjected to DC voltages exceeding specifications. This could create costly damage to the RF section of the modem. Adhere to the power supply noise specifications in your design.

Antenna

The antenna must be mounted like any other cellular or land mobile radio antenna. Usually the vehicle roof provides a good ground plane unless it is fabricated of non-metallic material such as fibreglass.

Mounting the Boomer-III OEM Modem to Your Device

Before using your modem you must:

- Mount the Boomer-III OEM Modem to your device
- Connect the Data Interface Port
- Connect and position the antenna
- Supply power

A picture of the Boomer-III OEM Modem is shown below.

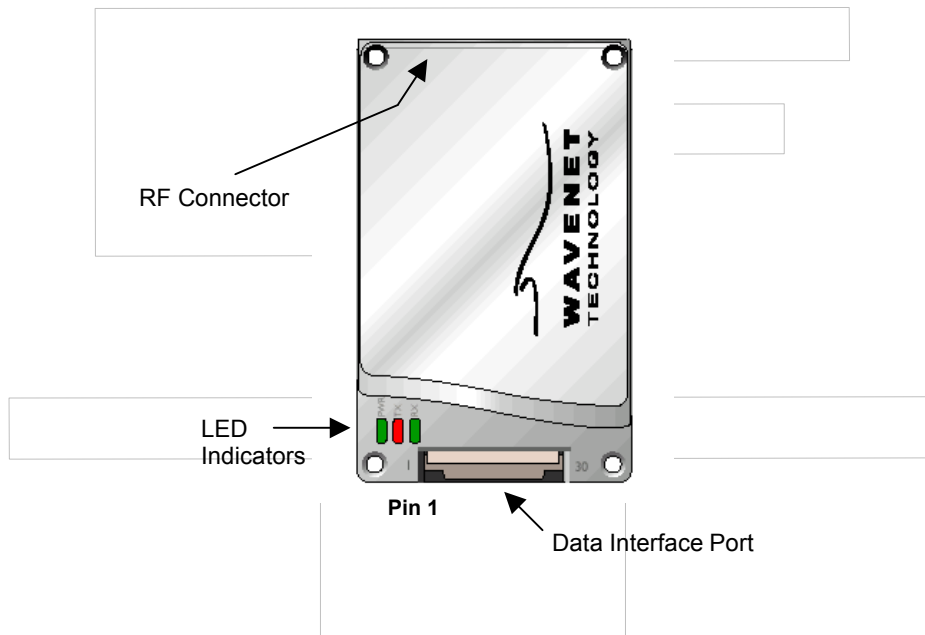

Proper mounting of the modem requires securely fastening it within the product housing. The mating surface should be flat and ensure a rigid mounting for the modem to minimise vibration to the unit. There should be an adequate supply of airflow to ensure the modem's temperature limits are not exceeded.

To ensure ease of access for installation and troubleshooting, locate the modem within the product in such a way that host and antenna connections are readily accessible. Quick access to the modem allows it to be efficiently removed, probed, and functionally tested.

The modem has M2.5 mounting holes in each corner. The mounting hole pattern is shown below;

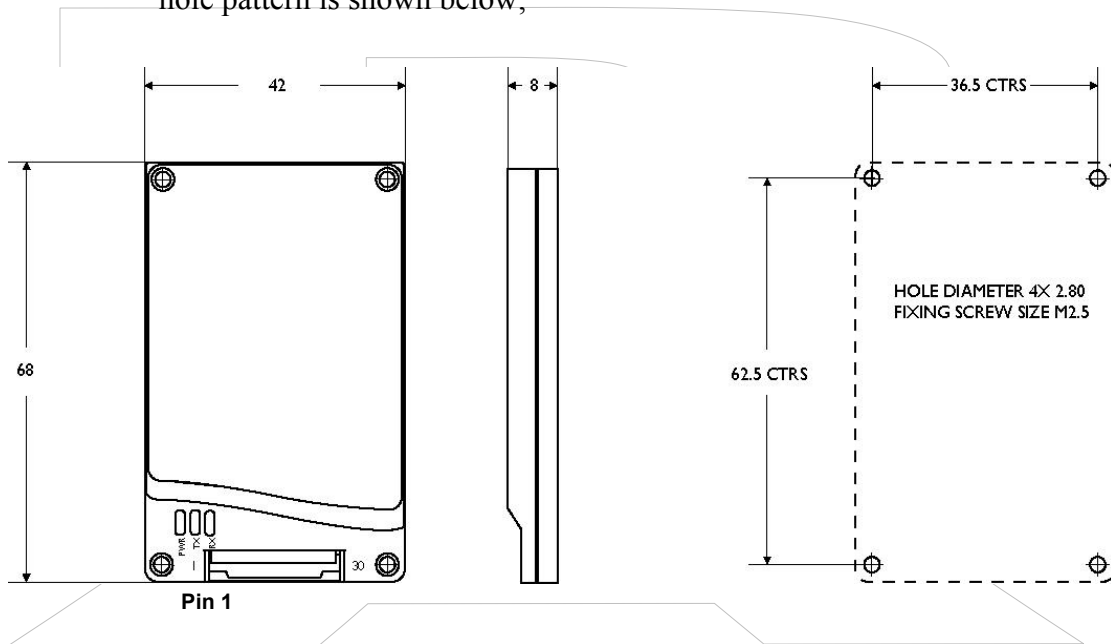

Connecting the Data Interface Port

There are two connectors to interface the Boomer-III OEM Modem with your device.

- RF Connector (described in the next section), and
- Data Interface Port

The data interface port is used to interface the modem to a serial computing device and a power supply. The power supply requirements are described in the next section.

A flat 30-way Flexible Printed Circuit (FPC) cable (approx 0.3 mm thick with 0.5 mm centreline spacing) is used between the Boomer-III OEM Modem's Data Interface Port and the host/terminal. The connector specification is given below.

The modem utilises connector part number 803-30-T-U from A-Point however, connector equivalents such as F006-52893 from Molex as shown below, may also be used in the host/terminal.

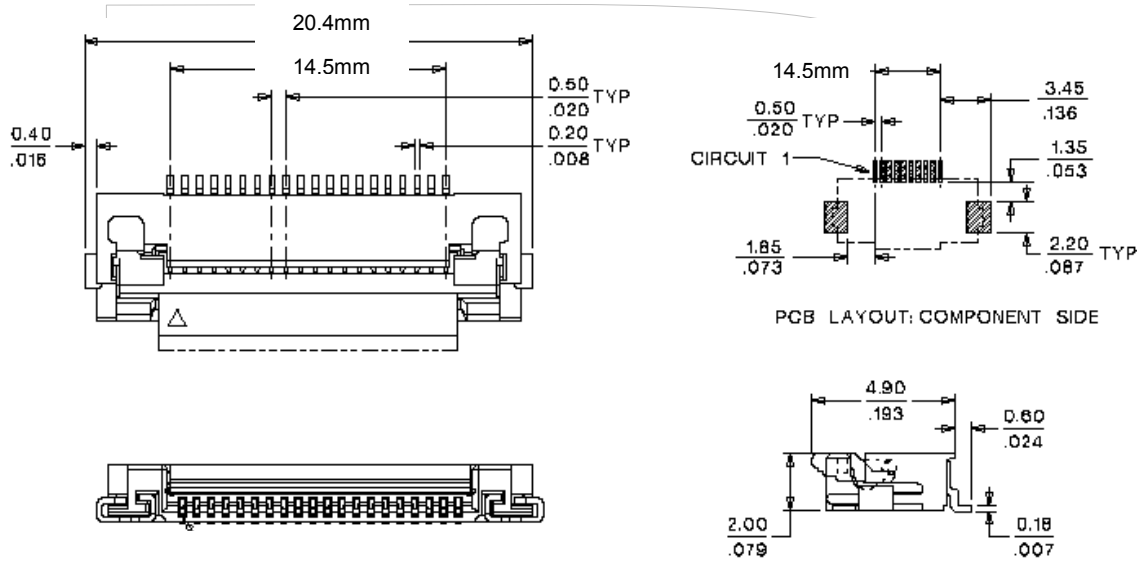

Molex FPC Connector F006-52893

Pin 1 of the connector is adjacent to the LED window; it is also marked on the housing.

The pin assignment of the Data Interface Connectors is shown in the following table.

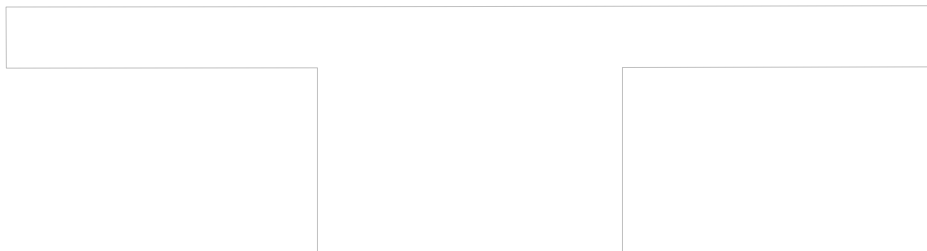
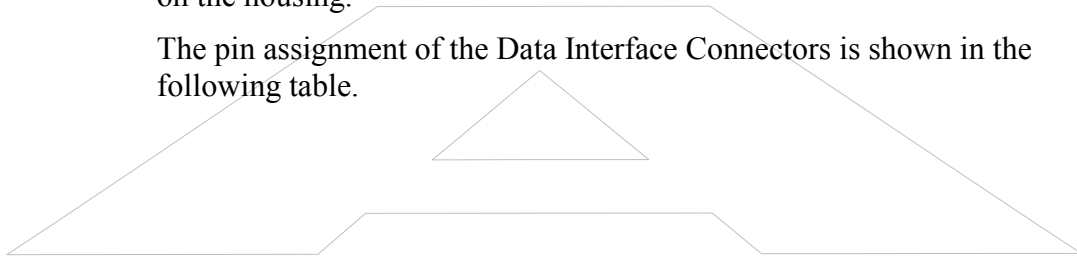

Data Interface Pin Descriptions

| Pin | Signal | Description | Signal | Reset State |
|-----|--------------|---------------------|----------------|----------------------|
| 1 | DCD | Data Carrier Detect | Output | High Impedance |
| 2 | RXD | Receive Data | Output | High Impedance |
| 3 | TXD | Transmit Data | Input | 100k pull up to 3V |
| 4 | DTR | Data Terminal ready | Input | 100k pull up to 3V |
| 5 | GND | Ground | Ground | 0V |
| 6 | DSR | Data Set Ready | Output | High Impedance |
| 7 | RTS | Request to Send | Input | 100k pull up to 3V |
| 8 | CTS | Clear to Send | Output | High Impedance |
| 9 | RI | Ring Indicator | Output | High Impedance |
| 10 | HCRESET | Modem Reset | Input | 40-80k pull up to 3V |
| 11 | RTC_BB | RTC battery backup | Input | High Impedance |
| 12 | HOSTPWR_ON | Modem Power on/off | Input | 80k pull down to 0V |
| 13 | LED0_MSGWTG | Message Waiting | Output | High Impedance |
| 14 | LED1_INRANGE | In Range | Output | High Impedance |
| 15 | LED2_LOWBAT | Low Battery | Output | High Impedance |
| 16 | SS0/RXD2 | Status Signal 0 | Bi-directional | 100k pull up to 3V |
| 17 | SS1/TXD2/AD1 | Status Signal 1 | Bi-directional | 100k pull up to 3V |
| 18 | SS2/RXD3/AD2 | Status Signal 2 | Bi-directional | 100k pull up to 3V |
| 19 | SS3/TXD3/AD3 | Status Signal 3 | Bi-directional | 100k pull up to 3V |
| 20 | HOST 3.8V | Supply Voltage | Supply | 3.4 – 4.2V |
| 21 | HOST 3.8V | Supply Voltage | Supply | 3.4 – 4.2V |
| 22 | HOST 3.8V | Supply Voltage | Supply | 3.4 – 4.2V |
| 23 | HOST 3.8V | Supply Voltage | Supply | 3.4 – 4.2V |
| 24 | TEST-PIN | Do not connect | | |
| 25 | HOST GND | Ground | Ground | 0V |
| 26 | HOST GND | Ground | Ground | 0V |
| 27 | HOST GND | Ground | Ground | 0V |
| 28 | HOST GND | Ground | Ground | 0V |
| 29 | TEST-PIN | Do not connect | | |
| 30 | SS4 | Status Signal 5 | Bi-directional | 100k pull up to 3V |

Warning: Do not connect the TEST-PIN terminals (pins 24 and 29) or the modem may malfunction. Leave disconnected.

Warning: The input voltage on RTC-BB (pin 11) must never exceed 3V under any circumstances or the modem may be damaged.

Note: The voltage range of most of the modem input pins is typically 0-3V, however, 0-5V may be used for compatibility with conventional digital logic, unless otherwise stated.

Modem On/Off Control

The modem on/off input line (HOSTPWR_ON) is an active high input signal and is fitted with a 33Ω series resistor for input protection. Internally it is passively pulled low (after the series resistor) to ground and is asserted with a high input signal.

The Boomer-III modem is fitted with a Real Time Clock that third party applications may utilise to wake-up the modem at a pre-programmed alarm time. This facility may be utilised to further reduce current consumption in battery powered applications, but note that the modem may need to re-register on the network after wake-up

The electrical interface specification and equivalent circuit is as follows:

Modem On/Off Control Equivalent Circuit

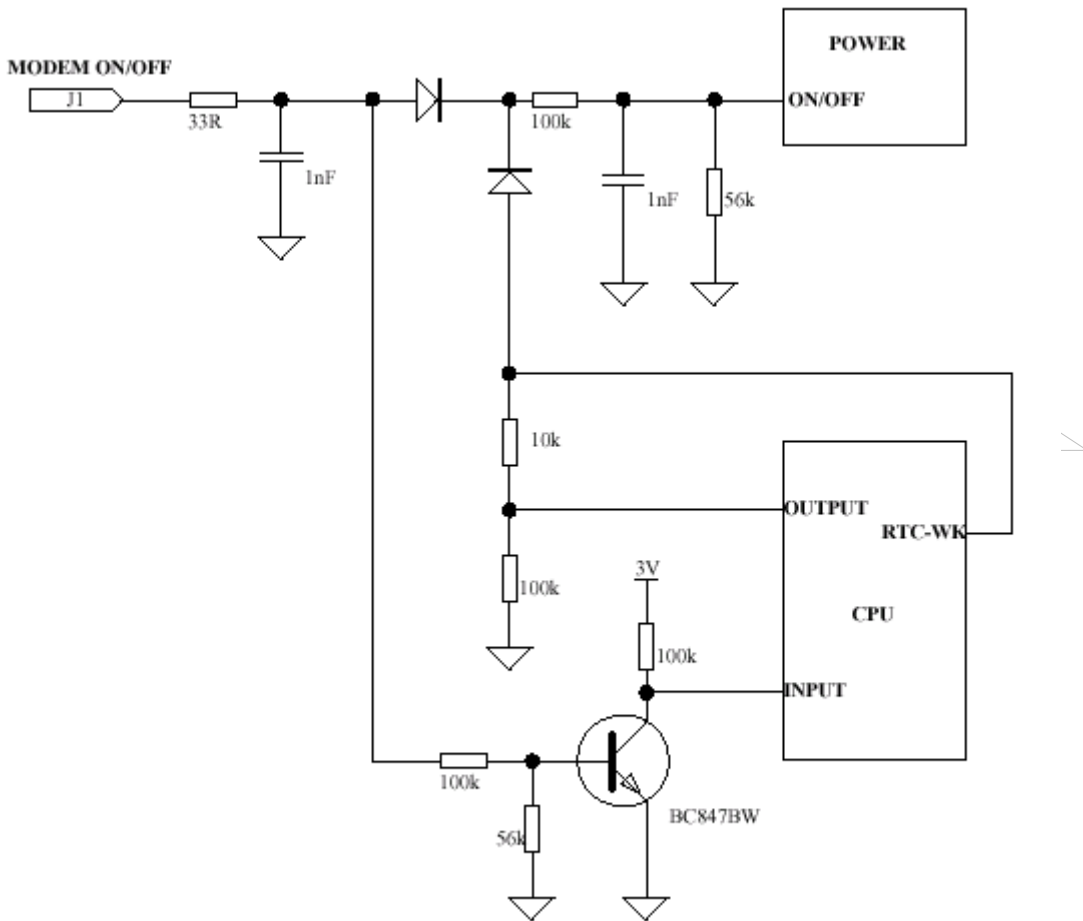

Modem On/Off Control Electrical Characteristics

| Parameter | Range | Low | High |
|---------------|--------------|-------------|--------------|
| Input Voltage | 0-3V OR 0-5V | 1.0 V (max) | 2.5 V (min) |
| Input Current | | 20 μA (max) | 100 μA (max) |

Warning: When the modem is turned off using the HOSTPWR_ON signal and HOST_3.8V power is removed, all other signals connected to the Data Interface Connector should also be turned off or set to 0V otherwise the modem may remain powered on via these signals.

Real Time Clock Battery Backup

The Boomer-III contains an on-board Real Time Clock (RTC) and the RTC Battery Backup (RTC_BB) pin is an optional input to maintain the clock settings (time and date) in the event the main power to the modem is removed. If used this input must be connected to a stable voltage supply (such as a suitable alkaline cell) that does not exceed the maximum input voltage specifications. If not required this input can be left disconnected and the RTC will be powered internally. The electrical interface specification and equivalent circuit is as follows:

Real Time Clock Equivalent Circuit

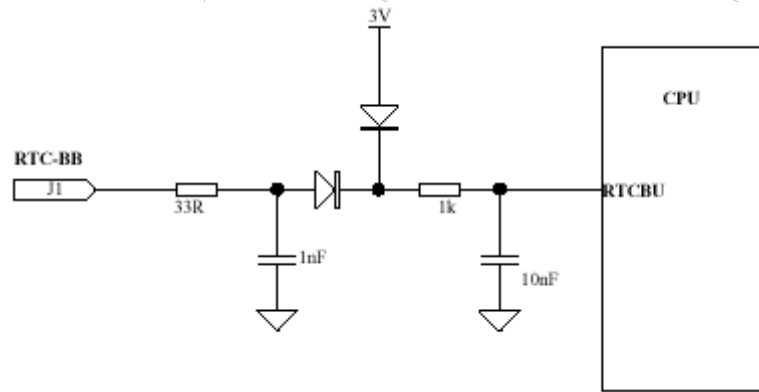

Real Time Clock Electrical Characteristics

| Parameter | Range | Min | Max |
|---------------|-------|-----------|------------|
| Input Voltage | | 2.1 V | 3V (max) |
| Input Current | | 1 μ A | 10 μ A |

Warning: The input voltage on RTC-BB (pin 11) must never exceed 3V under any circumstances or the modem may be damaged.

Modem Reset Input

The reset input line (HCRESET) is an active low input signal (TTL compatible) and is fitted with a 6.8kΩ series resistor for input protection. Internally it is passively pulled high (after the series resistor) to the supply rail (3V) and is asserted with an actively driven low signal to ground. The electrical interface specification and equivalent circuit is as follows:

Reset Input Equivalent Circuit

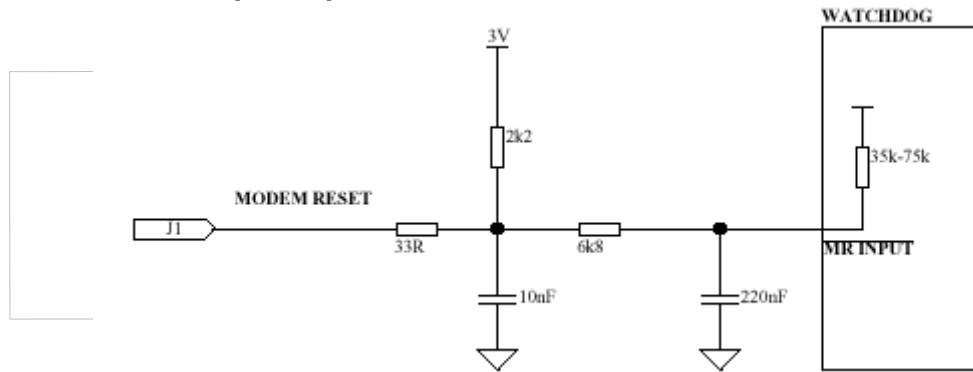

Reset Electrical Characteristics

| Parameter | Range | Reset Active | Reset Inactive |
|---------------|--------------|--------------|----------------|
| Input Voltage | 0-3V OR 0-5V | 0 V | 1.8 V (min) |
| Input Current | | 200 μA (max) | 200 μA (max) |
| Pulse width | 5mS (min) | | |

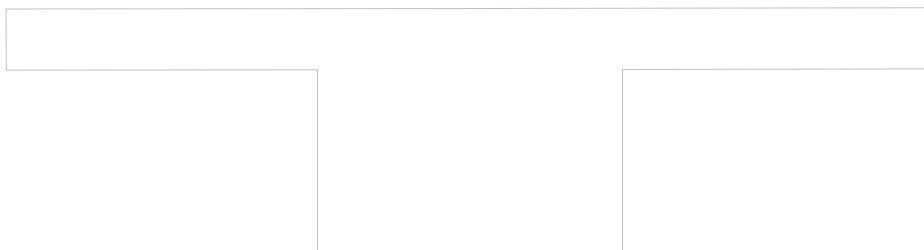

Serial Communications Interface

The modem communicates with the controller using the Data Interface Port connection interface. The host asynchronous serial interface on the Boomer-III OEM Modem operates at 3V and can be controlled by a wide variety of micro controllers and microprocessors.

If the modem is to be connected directly to a PC or other RS232 device, an interface must be provided to convert the signal voltage to the higher values required by an RS232 device.

The protocol supported over this link is network dependant. The data format is generally: 8 data bits, no parity, 1 stop bit, unless otherwise specified.

The serial interface lines (RXD, TXD, DCD, DTR, DSR, RTS, CTS, RI) are 3V logic compatible. They are fitted with a 33 Ω series resistor for protection. The electrical interface capability, equivalent circuit and operation of these lines is summarized below:

Serial Communications Interface Definitions

| J1 Pin # | Signal | Description | Signal | Active State |
|----------|--------|---------------------|--------|--|
| 1 | DCD | Data Carrier Detect | Output | Low when modem in-range |
| 2 | RXD | Receive Data | Output | Low when active |
| 3 | TXD | Transmit Data | Input | Low when active |
| 4 | DTR | Data Terminal Ready | Input | Low when ready |
| 6 | DSR | Data set ready | Output | Low when ready |
| 7 | RTS | Request to send | Input | High when host/terminal requires data throttling |
| 8 | CTS | Clear to send | Output | High when modem requires data throttling |
| 9 | RI | Ring indicator | Output | Pulses Low when messages are waiting |

Serial Communications Equivalent Circuits

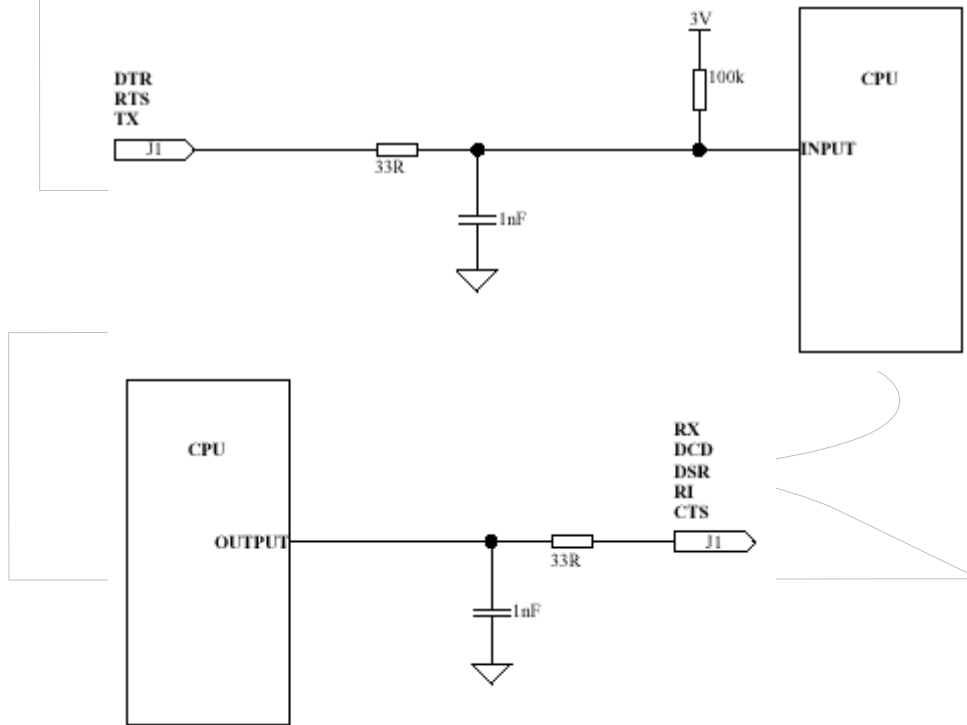

Serial Communications Electrical Characteristics

| Parameter | Range | Low | High |
|----------------|--------------|-------------------|-------------------|
| Input Voltage | 0-3V OR 0-5V | 0.8 V (max) | 2.0 V (min) |
| Output Voltage | 0 – 3V | 0.4 V (max) | 2.5 V (min) |
| Input Current | | 100 μ A (max) | 100 μ A (max) |
| Output Current | | 4 mA (max) | 4 mA (min) |

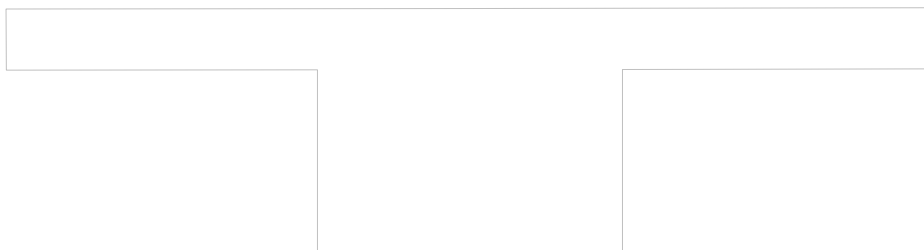

Status Signal Multi-Function Lines

The status lines (SS0 to SS4) have multi-functional capability and may be software configured for specific operation. All the lines may be used as digital input/outputs. SS0/SS1 and SS2/SS3 may be used as a second and third serial communications port respectively. SS2-SS3 may be used to measure analogue input voltages with 10-bit resolution. SS4 may be used as a Synchronous Peripheral Interface (SPI) port chip select signal (refer to LED Output section later).

Each Status line has a 100k Ω resistor to define default input status and a 33 Ω series resistor for protection. The electrical interface capability, equivalent circuit and operation of these lines is summarized in the tables below:

Status Signal Interface Definitions

| J1 Pin # | Signal | Description | Digital Capability | Alternate Function | Other |
|----------|--------|-----------------|--------------------|--------------------|-------|
| 16 | SS0 | Status Signal 0 | Input/ Output | - | RXD2 |
| 17 | SS1 | Status Signal 1 | Input/ Output | AD1 | TXD2 |
| 18 | SS2 | Status Signal 2 | Input/ Output | AD2 | RXD3 |
| 19 | SS3 | Status Signal 3 | Input/ Output | AD3 | TXD3 |
| 30 | SS4 | Status Signal 3 | Input/ Output | SPI_CS | - |

Status Signal Equivalent Circuits

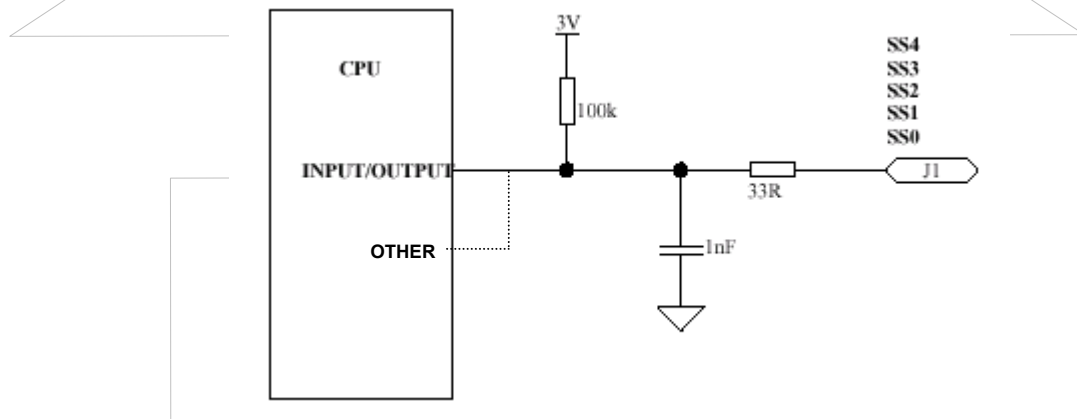

Status Signal Electrical Characteristics

| Parameter | Range | Low | High |
|----------------|--------------|--|--|
| Input Voltage | 0-3V OR 0-5V | Digital: 0.8 V (max) Analogue: 0V (min) | Digital: 2.0 V (min) Analogue: 3V (max) |
| Output Voltage | 0 – 3V | 0.4 V (max) | 2.5 V (min) |
| Input Current | | 100 μ A (max) | 100 μ A (max) |
| Output Current | | 4 mA (max) | 4 mA (min) |

LED Indicators

The modem provides three on-board indicators (LED's), for diagnostic monitoring purposes as well as three modem controllable LED outputs through the Data Interface Connector.

On-Board LED Indicators

The on-board LED's are visible through windows in the case of the modem and are defined as below.

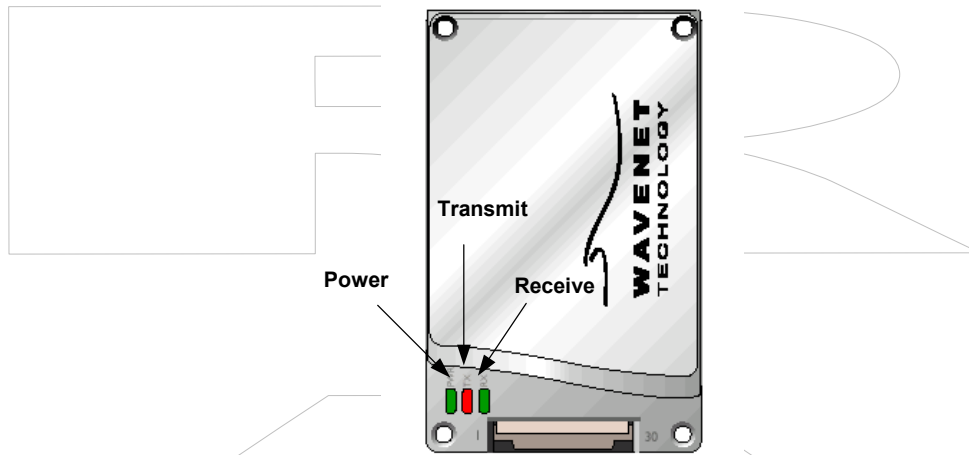

Position of On-Board LED Indicators

On-Board LED Indicator Definitions

| LED Indicator | Colour | Operating Mode | | |
|---------------|--------|----------------|------------------------------------|------------------------------------|
| | | Off | On | Flashing |
| POWER | Green | Power off | Power normal and locked on channel | Power normal and scanning channels |
| TRANSMIT DATA | Red | No activity | N/a | Data Transmitted |
| RECEIVE DATA | Green | No activity | N/a | Data Received |

Note: The LED's may be disabled to minimise power consumption. All LED's will flash on start-up and the Receive and Transmit LED's will flash on power down regardless of the state of the LED disable control.

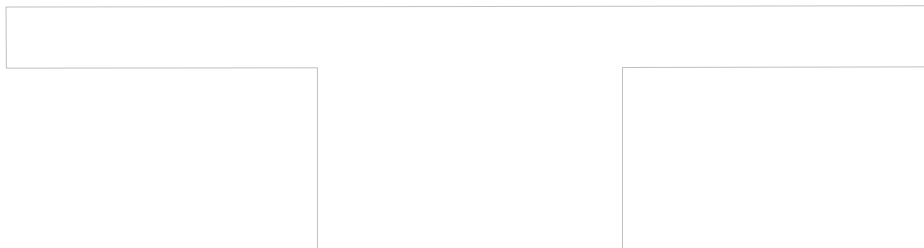

LED Output Lines

In addition to the on-board LED's there are three signal lines (Low Battery, Message Waiting, In-range), which are controllable by the modem for connection to an external LED. These lines also have multi-function capability through software configuration as digital input/outputs or as a Synchronous Peripheral Interface (SPI) port. SS4 may be used as a SPI chip select signal (refer to Status Signals section previously).

Each LED output line has a 33Ω series resistor for protection. It is recommended a series resistor be used with the external LED to limit current accordingly. The electrical interface capability, equivalent circuit and operation of these lines is summarized in the tables below:

LED Output Interface Definitions

| J1 Pin # | Signal | Description | Digital Capability | Alternate Function |
|----------|--------------|--------------|--------------------|--------------------|
| 13 | LED0_MSGWTG | LED Signal 0 | Input/ Output | SPI_CLK |
| 14 | LED1_INRANGE | LED Signal 1 | Input/ Output | SPI_MOSI |
| 15 | LED2_LOWBAT | LED Signal 2 | Input/ Output | SPI_MISO |

LED Output Lines Equivalent Circuit

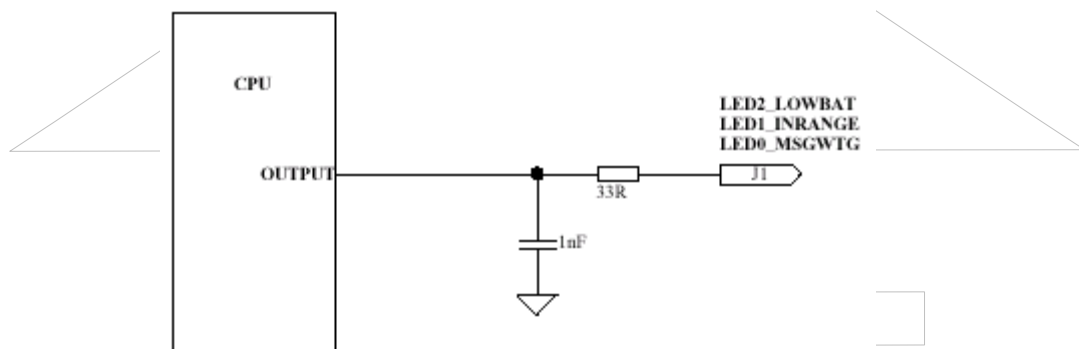

LED Interface Electrical Characteristics

| Parameter | Range | Low | High |
|----------------|--------|-------------|-------------|
| Output Voltage | 0 – 3V | 0.4 V (max) | 2.5 V (min) |
| Output Current | | 4 mA (max) | 4 mA (min) |

LED Interface Definitions

| J1 Pin # | Signal | Description | Signal | Active State |
|----------|--------------|-----------------|--------|---|
| 13 | LED0_MSGWTG | Message waiting | Output | Low when message waiting |
| 14 | LED1_INRANGE | In range | Output | Low when modem in-range |
| 15 | LED2_LOWBAT | Low battery | Output | Low when battery is <3.5V, High when battery is >3.6V |

Low Battery

The Low Battery signal is held active low whenever the supply voltage drops below an acceptable level and deactivated when the voltage level becomes acceptable again. The transitions will occur at the same time as the low battery event occurs (or would occur if the event was activated). Note that in the case of a very fast transition between voltages, it may take up to 20 seconds for the modem to confirm a change in battery status.

Message Waiting

The Message waiting signal is held active low whenever there is at least one complete message waiting in the outbound buffers (including the reread buffer).

In-Range

The In Range signal is held active low whenever the modem is in RF reception range.

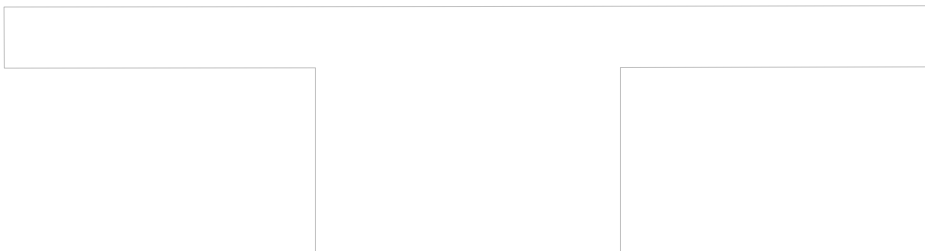
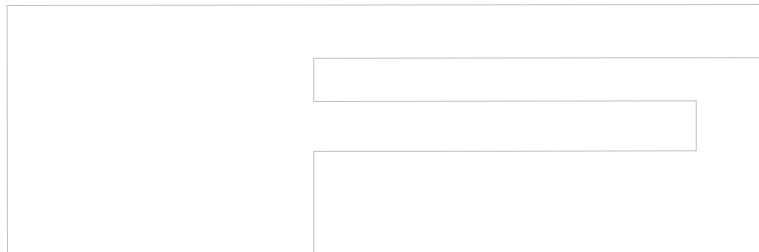

Selecting & Positioning the Antenna

Use this information to assist you in selecting the appropriate antenna to incorporate into your product package. For specific detailed information, Wavenet recommends that you use the expertise of an antenna design engineer to solve individual application concerns. Also always consult the appropriate technical representative of the target network operator prior to selecting and / or designing the antenna, so that it will pass network certification requirements.

Antenna Safety

The design of the integrated product must be such that the location used and other particulars of the antenna comply with the appropriate standards of the country in which the host/terminal is to be used.

The integrator should refer to the statement of Compliance on page 8 of this manual and Regulatory Requirements section on pages 19-23 for country requirements.

Mobile and Portable Devices

In the environment where portable devices are in use, many variables exist that can affect the transmission path. In this case, it would be preferable to use a vertically polarized, omni directional antenna. Antennas for portable devices include the following designs:

Internal antenna (invisible or pull-up)

An internal antenna must provide a gain sufficient to meet network specifications. Cable routing from the modem to the antenna needs to avoid RF sensitive circuits and high level, high-speed clock circuits. Consider:

- The location of the antenna to avoid RFI to a computing device.
- Good shielding to the display and other RF-sensitive components
- The most efficient method of cable routing

Otherwise, antenna gain can be offset by cable loss. A typical coaxial cable is very thin, such as RG178B used in portable devices, and cable loss can be 1dB or more per metre. Some coaxial cable manufacturers market relatively thin double braid coaxial cables. These cables show much better isolation than single braid cables, typically by 30 to 40dB. These double braid cables reduce radiation and RF pick-up when routed inside a portable device.

External antenna, removable and directly connected to the device

You can design a portable device that can use an off-the-shelf, plug-in antenna, such as a $\frac{1}{4}$ wave monopole or $\frac{1}{2}$ wave dipole antenna. Typical gain of these omni directional antennas is 0dBi and 2.14dBi, respectively.

Cabling demands the same consideration as an internal antenna application. In a typical laptop application, the antenna must be placed as far as possible from a display to avoid deflection. This usually causes a deep null in radiation patterns.

External, remote antenna

For remote antenna application use the same design approach as internal designs, including the RF cable routing of the external connector. You can choose an off-the-shelf mobile antenna of omni directional $\frac{1}{2}$ wave length.

A double braid coaxial cable such as RG223 from the device to the antenna is recommended if the cable length is more than a metre. The difference in cable loss between low cost RG58 and the more expensive RG223 is approximately 4.5dB per 30 metres. If the cable must be routed through noisy EMI/RFI environments, a double braid cable such as RG223 can reduce radiation and pick-up by 30 to 40dB.

Fixed Devices

Fixed data device applications use the same design recommendations as a portable device with a remote antenna.

As for the RF connector of an external antenna, whether it is a plug-in type or a remote type, the most economical and practical choice is a TNC threaded connector. TNC has a good frequency response to 7GHz, and leakage is low. A mini UHF threaded connector provides adequate performance and is an economical choice. If the size of the TNC and mini UHF connectors becomes critical, consider an SMA threaded connector or an SMB snap fit connector. (The SMB connector does not accept an RG58 or RG223 cable).

Selecting an Antenna

The requirements for the antenna used with the Boomer-III OEM Modem are:

| | |
|---------------------------|--|
| Antenna Gain: | 5dBi (isotropic) maximum average gain if modular FCC approvals are to be used without separate equipment approval for the host/terminal. |
| Impedance: | 50 Ω |
| Centre Frequency: | 833MHz \pm 5MHz (for 800MHz modem) |
| Frequencies of operation: | 806 to 825MHz (for 800MHz transmit) 851 to 870MHz (for 800MHz receive) |
| Acceptable return loss: | VSWR < 1.5 or RL < -14dB (recommended) VSWR < 2.0 or RL < -10dB (minimum) |

The power output of the Boomer-III OEM Modem is nominally 2W at the antenna port. The antenna gain or loss will affect the radiated value.

Connecting the Antenna

The Boomer-III OEM Modem Module provides an MMCX RF connector located at the top of the unit, to attach to the antenna cable.

The antenna does not plug directly into the modem but uses an antenna cable to interface between the device and the modem.

The antenna cable should be a low loss, 50Ω impedance and have a MMCX plug that can mate with the modem's MMCX socket. It is recommended that a Huber+Suhner connector be used to connect to the modem as below:

- 11 MMCX series — Straight Connector
- 16 MMCX series — Right Angle Connector

If an extension cable is required to the antenna, it should be low loss, as short as possible and an impedance of 50 ohms. Proper matching connectors should be used, as each connector introduces a return loss and reduces performance.

Positioning the Antenna

Positioning the antenna will affect the gain provided by the antenna.

The antenna should be orientated so that it provides vertical polarisation as the DataTAC network is based on vertically polarised radio-frequency transmission.

The antenna should be located as far from the active electronics of the computing device as possible. Typically, a metal case of a computing device and its internal components may attenuate the signal in certain directions. This is undesirable as the sensitivity and transmit performance of the Boomer-III would be reduced. However, careful use of metal used for the ground plane for an antenna can improve the antenna gain and the coverage area for the system.

If your device is designed to sit on a surface, the antenna should be positioned as far from the bottom of the device as possible. This is to reduce the radio frequency reflections if the device is placed on a metal surface.

If your device is hand held or is worn next to the body, the antenna should be positioned to radiate away from the body.

The integrator should refer to the statement of Compliance on page 8 of this manual and Regulatory Requirements section on pages 19-23 for country requirements.

Source Based Time Averaging Function

For portable or handheld applications the integrated host/terminal must comply with OET Bulletin 65 and Supplement C (June 2002) with respect to Specific Absorption Rate (SAR) requirements.

The Boomer-III modem module operates on a packet data network which sets the timing of most aspects of the RF signalling protocol.

The shortest transmit event over which the Boomer-III modem has control is a transmit transaction which is comprised of a series of transmit pulses.

For portable or handheld applications a source based time averaging function has been incorporated in the Boomer-III modem firmware. This function limits the transmit duty cycle by controlling the timing of when transmit transactions are initiated and the delay period between them.

When a data transmission occurs, the actual transmit time is recorded. Subsequent data transmissions are inhibited until a delay period (idle time) has elapsed to ensure the average duty cycle of transmissions is less than the preset "Duty Cycle" limit. Any delayed user data that is to be transmitted will be buffered until it is permitted to be sent.

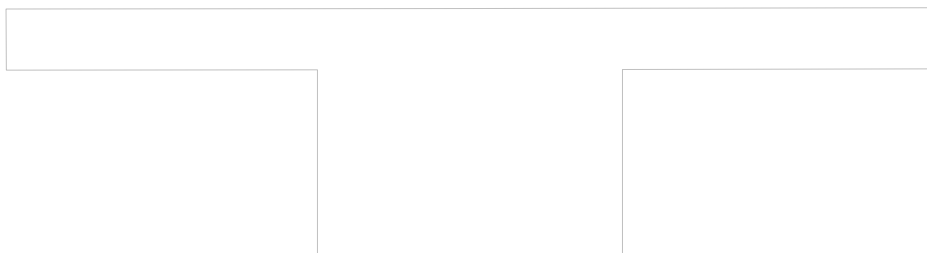
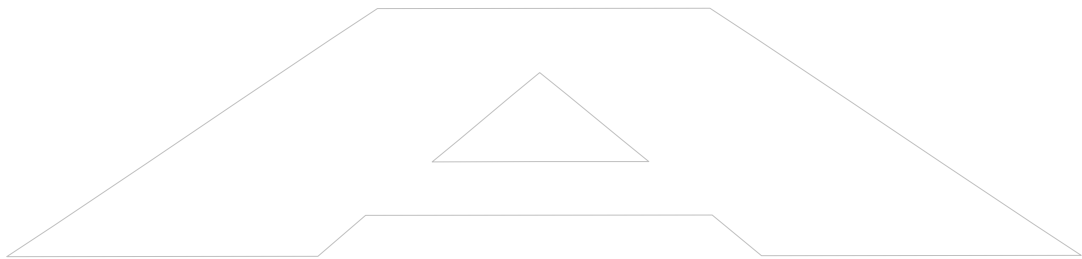
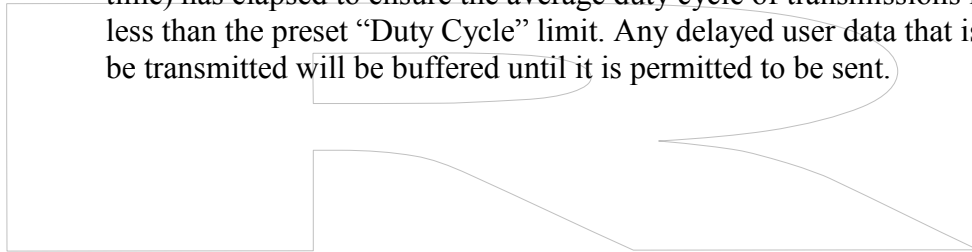

The algorithm for the Source Based Time Averaging transmit control and the relevant parameters are given below:

- $\text{Idle_Time} = \text{Duty_Factor} * \text{Transmit_Duration}$
- $\text{Duty Factor} = (100 - \text{Duty_Cycle}\%) / \text{Duty_Cycle}\%$
- $\text{Duty_Cycle}\% = \text{Preset limit for SAR compliance}$

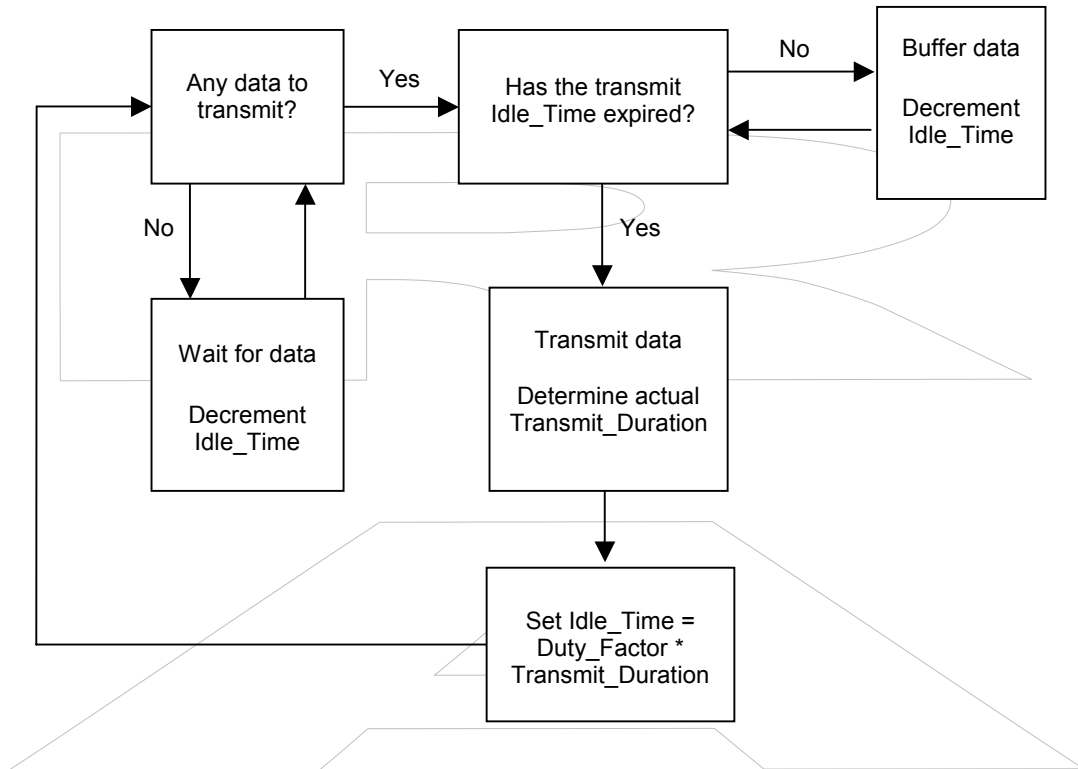

Source Based Time Averaging Transmit Algorithm

The Boomer-III modem module has an overall transmit Duty Cycle limitation of 30% (maximum) to physically protect the modem hardware.

The default Duty Cycle preset in the factory at the time of manufacture is 10%. Other duty factors and SAR evaluation must be addressed at the time of OEM integration into any final host/terminal product and is the responsibility of the OEM Integrator.

The algorithm and preset Duty Cycle is recorded in the module firmware at the time of manufacture and cannot be altered by the end user.

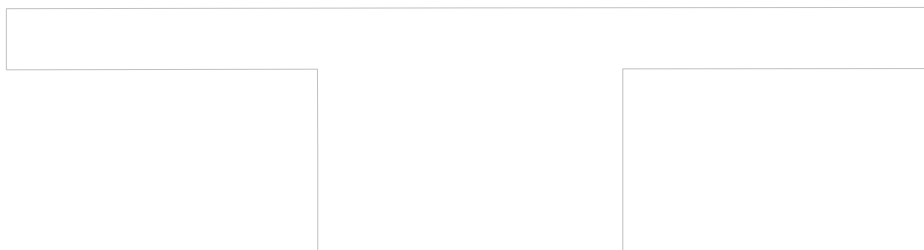

Supplying Power

The Boomer-III OEM Modem must be provided with a clean power source capable of delivering bursts of high current.

The modem draws its power in bursts. The power required changes rapidly depending on whether the modem is transmitting, receiving or on standby.

Ratings

The power supply requirements are:

| | |
|--------------------------|--|
| Voltage: | 3.8V (3.4 to 4.8V range) |
| Transmit Current: | 1.6A maximum (2.2A maximum if antenna mismatched) |
| Transmit Duration: | 32ms (minimum) 7s (maximum) |
| Duty Cycle | 30% (maximum) data dependant |
| Receive Current | TBD mA (typical) |
| Standby Current | TBD mA (typical) Add ~1.2mA if LED's enabled |
| Off current consumption: | TBD μ A (nominal) |
| Power Supply Ripple: | < 15mV peak to peak |

Design Considerations

The power supply is one of the key issues of design of wireless terminals.

Due to the burst nature of transmit periods the power supply must be able to deliver high current peaks for short periods of 32ms to a maximum of 7 seconds (RD-LAP 9600 bps) or for 20 seconds (MDC 4800 bps). During this time the drop in the supply at the module itself must not exceed 200mV (total at the module), such that at no time module shall module supply drop below 3.4V and ripple must not exceed 15mVp-p during transmit.

The maximum transmit current into a matched antenna is 1.6A, however, this can increase if antenna mismatch occurs.

Wavenet recommends designing a robust power supply that can provide adequate power under non-ideal conditions such as an improperly matched antenna, where current can be up to 2.2A.

It is recommended that for ensuring power supply margin the following be done:

- ❑ A short FPC cable (e.g < 100mm) is used to minimise power supply voltage drop during transmission.
- ❑ The power supply should be set above nominal 3.8V to accommodate worst case power supply drop. i.e. 4.0V.
- ❑ The power supply should have good regulation with < 200mV drop at 2.2A.
- ❑ Adequate supply decoupling (10,000uF min.) is added at terminal connector to reduce ripple and smooth supply voltage steps.
- ❑ The power supply be capable of supplying non-ideal current consumption conditions of up to 2.2A for up to 20 seconds and with a duty cycle (set by data usage) ~ 30% maximum.
- ❑ Multiple pins are assigned to both power and ground connections for the modem. Connection of all designated pins to the appropriate supply or ground in the host/terminal is necessary to accommodate modem current requirements.
- ❑ The host/terminal must provide a continuous supply.

The modem is fully compliant with the DataTAC Power Save Management system. The modem exists in the lowest power state possible while still providing uninterrupted service. By de-asserting the HOSTPWR_ON signal, the modem disconnects from the network then enters a near-zero power state. The modem resets if the power source is cycled. This can cause network service issues, since the modem might not have had a chance to de-register. The modem spends the majority of time in sleep mode.

Conservation

In installations requiring power conservation (such as, when the modem is powered from a battery or solar cell), you must monitor modem power consumption in various operating states. Even though the Boomer-III OEM modems are designed for minimal power consumption, by using the network Power Save protocol offered by DataTAC networks you can further reduce power consumption.

Another power saving idea is to activate the modem only when it is needed.

Note: The on-board LEDs may be disabled to minimise power consumption. Refer to Appendix A - NCL Interface. All LEDs will flash on start-up and the Receive and Transmit LEDs will flash on power down regardless of the state of the LED disable control.

Power Save Protocol

The modem typically uses current provided by the host/terminal battery. For the product to be usable for a reasonable period in portable applications, the host/terminal battery power must be conserved. To meet this requirement, the modem uses DataTAC Power Save protocol.

The Power Save Protocol defines the following four modem power consumption states:

| | |
|-----------------|---|
| Off | The modem is turned off or the host/terminal (battery) has failed. |
| Sleep | The processor is sleeping and wakes up to an interrupt, but the RF section is off. |
| Receive | The processor is actively processing information; the RF sections are on and demodulating data. |
| Transmit | The processor is actively processing information; the RF sections are on and transmitting data. |

Power Profile

The modem's power consumption profile depends on the usage and the network configuration of the Power Save protocol.

For example, the following numbers present a typical profile for the Boomer-III modem based on reasonably heavy usage and assuming a 3.8V supply current: (Power Save Mode = Maximum)

- ❑ 80 % Sleep @ 4.4 mA typical
- ❑ 19.9 % Receive @ 76 mA typical
- ❑ 0.1% Transmit @ 1.6A typical

The actual percentage of total time spent in each state (transmit, receive, sleep) is a function of the following variables.

Network configuration

On networks supporting Power Save operation, the network configuration impacts how long the modem must be in the sleep state.

Note: *Neither Wavenet nor any developer has any direct control over the network configuration. Networks supporting Power Save are typically configured to preserve the battery life of modems of their subscriber base.*

Message traffic model

The message traffic model defines how many messages are transmitted and received, and the average length of the messages sent and received in a given working day. For instance, a dispatch application could have a message traffic model as follows:

- ❑ Messages transmitted in 8 hour day: 25
- ❑ Average length of transmission: 120 bytes
- ❑ Messages received in 8 hour day: 10

- Average length of received message: 30 bytes

This analysis of message traffic allows the power consumption profile to be assessed in terms of percentage of time spent transmitting, receiving, and sleeping. (For more information, see *Develop a Message Model* on page 12.)

Usage of group LLIs

Some applications require the use of group LLIs, such as a stock quotation broadcast service. Each active group LLI (in addition to the modem's factory loaded individual LLI) increases the percentage of time the modem stays in the receive state, thereby increasing its overall current consumption.

Roaming Time

The amount of time the modem spends scanning a channel or roaming to a new channel will affect the current consumption. The current consumption is dependant on the Network type (Private or Public) and the System type (MFR or SFR).

Power Control

The host/terminal provides the supply rail (HOST 3.8V) to the modem through the Data Interface Connector.

The host/terminal turns the modem ON by asserting the HOSTPWR_ON signal.

The host/terminal may request the modem to turn OFF by de-asserting the HOSTPWR_ON or by sending a specific NCL command across the serial interface. For the modem to turn OFF after an NCL request the HOSTPWR_ON signal must be de-asserted.

ESD protection is provided on all power supply lines and on each I/O line.

Power-Up Sequence

Reference should be made to the Power-UP Timing Diagram below when reading the following Power-UP Sequence description.

To turn the modem ON, power must be applied (HOST 3.8V) and the host/terminal asserts the HOSTPWR_ON signal.

The modem contains an internal voltage detector and reset delay circuit to generate a reset signal for the CPU to ensure orderly and reliable software initialisation.

An externally controllable reset signal (HCRESET) is optionally available if the host/terminal wants reset synchronisation or to force a modem reset while power is still applied.

If the HCRESET signal is used, once it is de-asserted the modem CPU will be able to initialise.

Once out of reset the first operation is the boot-up of the modem CPU. At this time CTS is momentarily asserted, then de-asserted. After a

successful boot up, the CPU starts the modem initialisation sequence. After the initialisation sequence, the Native Mode interface and the serial interface are active.

Following successful initialisation, the modem asserts DSR and performs the initialisation protocols for both the NCL DTE interface and the RF network. After successfully initialising the NCL DTE interface, the modem asserts CTS. After the network ACK of the registration sequence, DCD is asserted.

The Boomer-III modem is fitted with a Real Time Clock that third party applications may utilise to wake-up the modem at a pre-programmed alarm time prior to turning the modem off. This facility may be utilised to further reduce current consumption in battery powered applications, but note that the modem will need to re-register on the network after wake-up

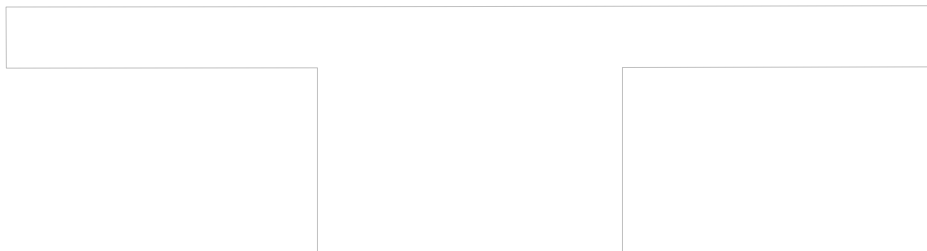
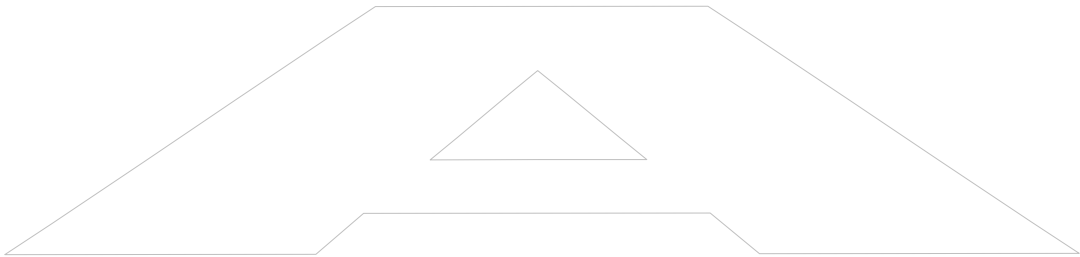

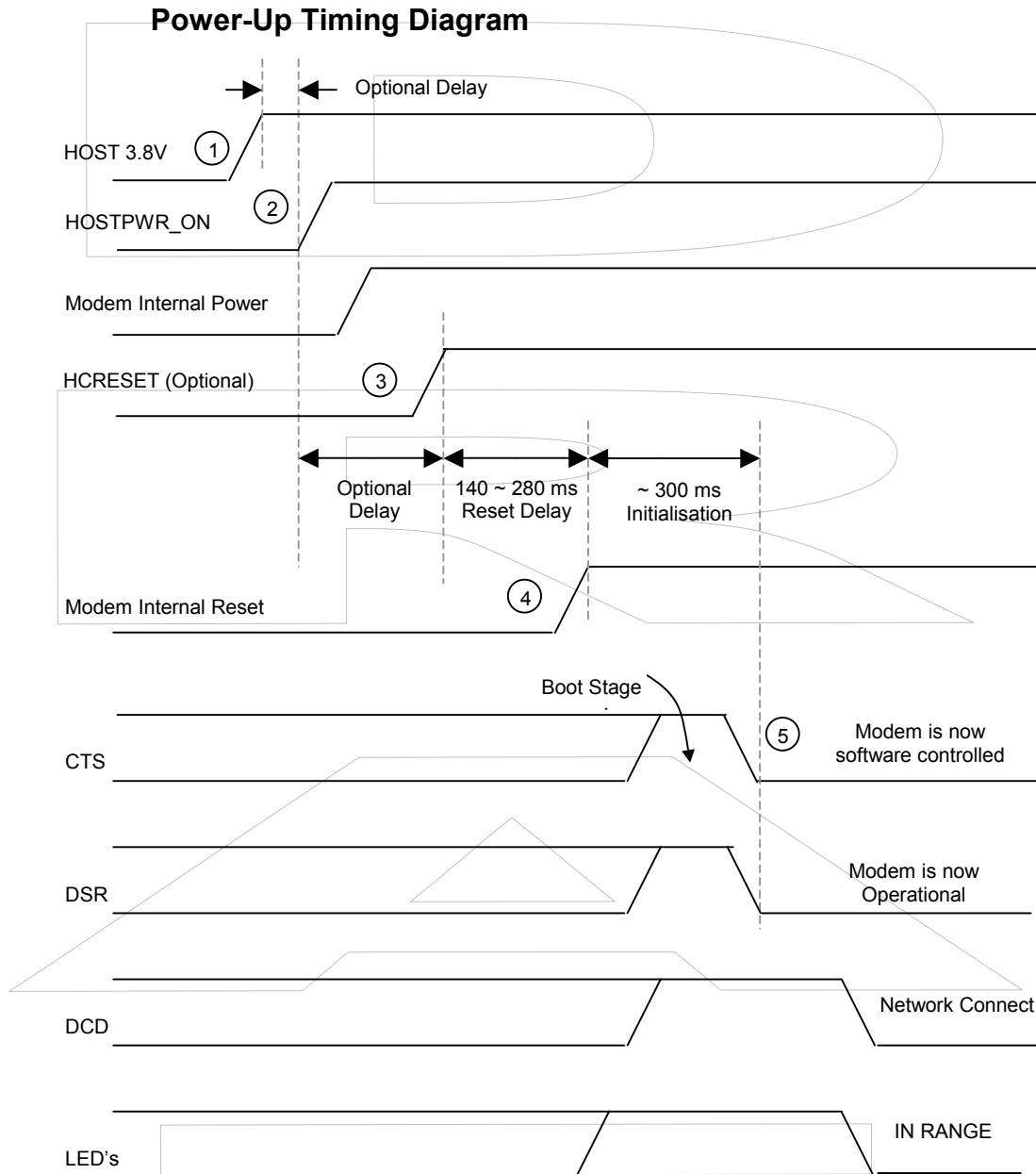

Note: HCRESET, CTS, DSR, DCD, the LED's and the internal modem reset are all active low signals.

Power Up Diagram Callouts

- 1 Power is supplied to the modem
- 2 The HOSTPWR_ON signal is asserted to turn on the modem.
- 3 The HCRESET signal is de-asserted.
- 4 The internal modem reset is released to allow the modem boot up sequence.
- 5 The modem exits the boot load state, is operational and is ready to communicate with the DTE.

Power Down Sequence

The host/terminal may request the modem to turn OFF by de-asserting the HOSTPWR_ON or by sending a specific NCL command across the serial interface. For the modem to turn OFF after an NCL request the HOSTPWR_ON signal must be de-asserted.

Warning: The power supply rail must be maintained during a power down sequence or else memory may be corrupted.

The soft shutdown process starts when the HOSTPWR_ON control line is de-asserted. The shutdown process consists of the modem first de-registering from the network and de-asserting the DCD line. Next, it saves the modem configuration and network channel information. The modem then de-asserts the DSR line, signalling the modem is no longer in a ready state. This process can take a few seconds to complete.

At this point, the host/terminal can remove the power from the modem and still maintain most of the modem settings and last registered network channel. The modem can be left with power applied and HOSTPWR_ON de-asserted.

The reset line HCRESET can be asserted at this time in preparation for the next power-up sequence. This is optional and is intended for rebooting the modem only. Resetting the modem causes a cold start and flushes the saved modem settings.

The following diagram shows the sequence for these actions.

Power-Down Timing Diagram

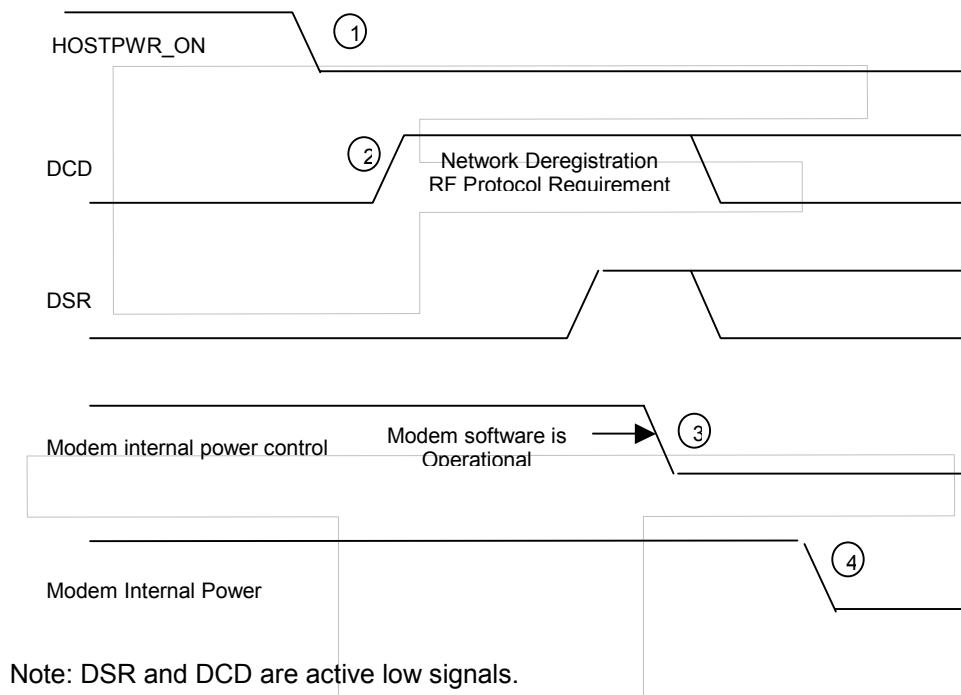

Power Down Diagram Callouts

- 1 HOSTPWR_ON is de-asserted from the host/terminal to the modem.
Important: *The power rail must be present for up to ten seconds (typically two seconds) after HOSTPWR_ON is de-asserted for the deregistration process to complete orderly.*
- 2 The modem starts the soft shutdown process. The battery status indicator pulses quickly until the shutdown steps are complete.

The modem initiates the deregistration process from the network and upon completion de-asserts DSR and DCD. DCD signifies network detachment, and DSR shows the modem's readiness state.
- 3 After deregistration, the internal modem CPU power-on signal is de-asserted. This deactivates the internal modem power rail to the radio.
- 4 At this point you can optionally de-asset HOSTPWR_ON signal to the modem and assert the HCRESET line to the modem.

Batteries

The Boomer-III OEM Modem may be powered by batteries if used with a handheld device.

For battery operated devices, battery selection is a critical decision, requiring consideration of many factors. These include cell size, internal impedance, charging requirements, and susceptibility to common battery phenomena, such as memory effect or overcharging. Each of these factors is discussed in detail in this section.

The selected battery must be able to meet the Boomer-III power requirements as mentioned previously.

Three prevailing battery technologies exist today:

- ❑ Nickel cadmium (NiCad) batteries may be used for devices requiring wide temperature ranges.
- ❑ Nickel metal hydride (NiMH) and
- ❑ Lithium ion (Li+) batteries may also be used for devices utilised above 0°C. Specifications for these batteries should be obtained from the manufacturer.

NiCad

- ❑ Most mature technology
- ❑ Lower energy density (energy/volume) than NiMH or Li-ion
- ❑ Available in all cell sizes, including AA, 2/3A, 4/5A, A, 4/3A, and so on. This represents the greatest number of packaging options.
- ❑ Exhibits a memory effect when not occasionally discharged below the lower extent of its operating voltage. The memory effect reduces the usable capacity of each battery cell.

- ❑ Internal impedance of 25-30 $\mu\Omega$ per 1.2V cell
- ❑ Typical cell voltages are 1.2V, with multiple cells used to obtain higher operating voltages
- ❑ Can withstand high current pulses, which are characteristic of packet data applications
- ❑ Typical charge method is $-\Delta V$ (known as negative delta voltage), which involves charging the battery while looking for the battery voltage to peak. Then enter a slight overcharge condition, where the voltage actually begins to decrease prior to terminating battery charging. NiCad is the most robust battery technology available today for non vehicular applications. NiCad can withstand over charging, over discharging, and harsh environments with reasonable resilience.
- ❑ Raw battery cells or battery packs can be purchased from suppliers

NiMH

- ❑ Mature technology with potential for improvements in battery chemistry and energy density over the next five years
- ❑ Higher energy density than NiCad, but lower than Li-ion
- ❑ Available in standard sizes AA, 2/3A, 4/5A, A and 4/3A and some prismatic (rectangular) configurations
- ❑ Exhibits the memory effect in a manner similar to NiCad technology, but at a less pronounced level
- ❑ Internal impedance of 35-49 $\mu\Omega$ per 1.2V cell
- ❑ Typical cell voltages are 1.2V, with multiple cells used to obtain higher operating voltages
- ❑ Earlier NiMH battery chemistry could be damaged by high current discharge pulses. Newer battery chemistry has eliminated this problem. When purchasing batteries of this type, determine if high current pulse discharging is an issue.
- ❑ Typical charge method is dT/dt , where T is temperature. As the battery reaches full charge, any further energy is dissipated as heat. A temperature threshold is used to terminate the charge cycle in conjunction with voltage monitoring. NiMH is more sensitive to overcharging than NiCad and exhibits decreased capacity if repetitively overcharged.
- ❑ Raw battery cells or battery packs can be purchased from suppliers.

Li-ion

- ❑ Reasonably mature technology leaving lots of potential for increased capacity
- ❑ Higher energy density than either NiCad or NiMH

- ❑ Availability is an issue, as most suppliers do not sell cells, but force customers into particular solutions through their battery pack designs. Purchasing cells in an effort to design your own battery pack may be problematic due to cell lead times.
- ❑ Li-ion does not exhibit the memory effect and is unaffected by partial discharging-charging cycles
- ❑ Internal impedance of 100-150m Ω per 3.6V cell. Li-ion batteries are very susceptible to damage due to over discharge and high current pulses. As a result, manufacturers recommend that a protection circuit be added to battery pack designs. The resultant internal impedance of a battery pack with protection circuitry can reach the 500m Ω level.
- ❑ Typical cell voltages are 3.6V with multiple cells used to obtain higher operating voltages.
- ❑ Li-ion batteries are very sensitive to over-discharge and represent a hazard if not properly designed with protection circuitry.
- ❑ Typical charge method is constant-voltage, constant-current.

Applying Battery Technologies

When reviewing different battery technologies, consider the following characteristics of OEM devices incorporating wireless data modems.

Current drain is not constant

Typically, battery manufacturers specify the battery discharge profiles by assuming a constant-current drain model. In a wireless data system, the constant current drain model no longer applies. There are three levels of current drain contributions that can be expected: sleep, receive, and transmit. The modem cycles through these different states throughout the time it is powered on and in contact with the wireless network. To determine the realistic battery life or capacity for your product, you must contact the battery manufacturer or experiment by transmitting for various durations.

Peak currents during transmissions

Since transmissions are typically short, the resultant current drain during transmissions can be viewed as current pulses. These pulses must be considered when selecting the proper battery technology, since not all technologies are equally tolerant of current pulses.

Additionally, the internal impedance of the battery must be taken into account at the peak currents during transmissions, since this is the time when the largest voltage drop occurs across the battery terminals.

Adequate supply guard-band must be designed in to ensure that the modem and any other circuitry in the final product are not reset during transmissions.

Messaging model

To determine the required battery capacity for your product, you need to define the messaging model for your target market. In regard to battery selection, the messaging model details the following information:

- ❑ Optimal number of hours per day of use prior to recharging the battery
- ❑ Number of messages transmitted per hour
- ❑ Number of messages received per hour
- ❑ Average length of transmitted messages

Using this information and the typical current drains of the modem and other circuitry present in your product, you can define the requirements for battery supply voltage and capacity.

Battery Recharging

Plug-in Supplies

A mains plug-in supply must be designed to ensure that voltage spikes, lightening and other power fluctuations cannot damage the Boomer-III. Transient voltage protection zener diodes or other spike arrestor circuits may be added to keep the inputs within the power requirements mentioned previously. These should have a value of 20V and be placed on the supply side of the regulator circuit.

Automotive Supplies

Extra protection is required from an automotive supply to protect the Boomer-III OEM Modem from power fluctuations when used in an automobile.

The electrical transient conditions (e.g. battery jump start), may damage the modem if not adequately clamped and filtered.

Environmental Considerations

The environmental requirements of the Boomer-III OEM Modem are as follows:

Operating Temperature: -30° to +60°C

Storage Temperature: -40° to +70°C

Relative Humidity 0 to 95% non-condensing

These limits should not be exceeded in the intended application.

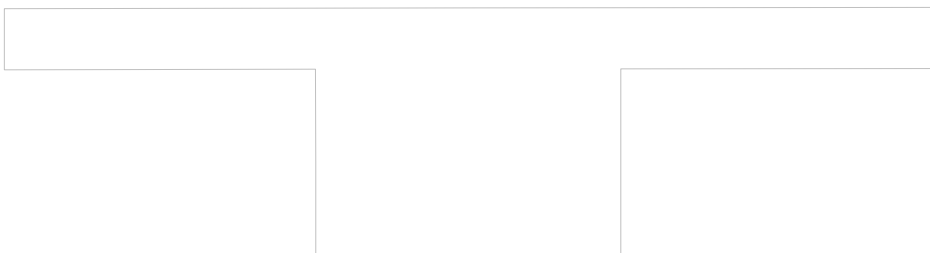
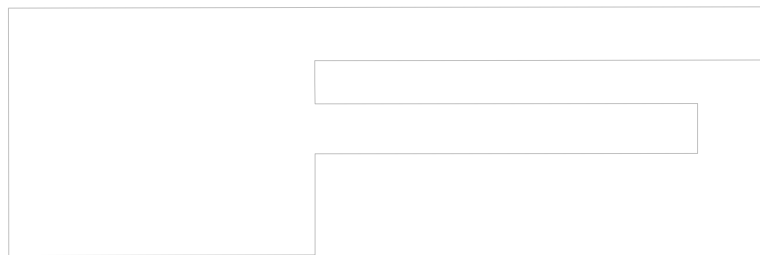
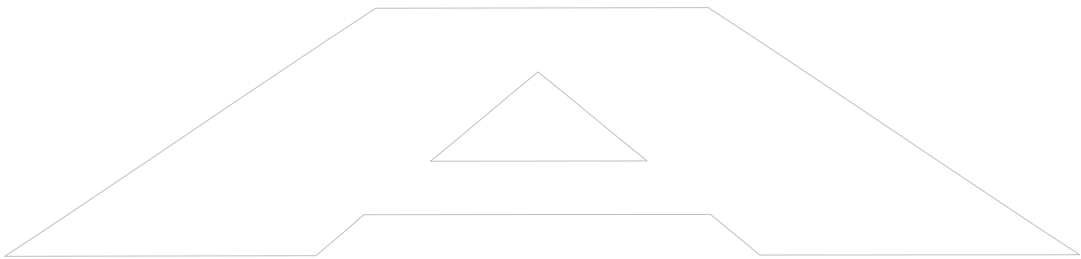
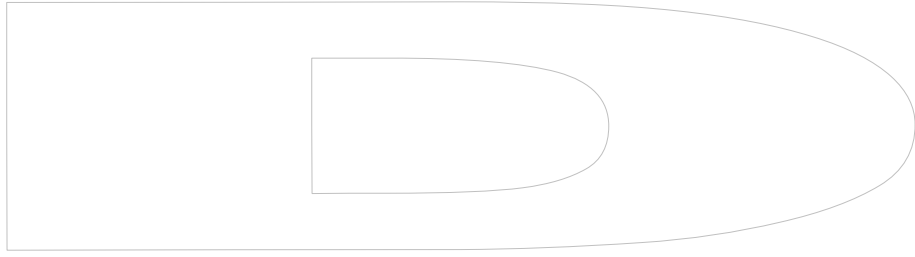

Using the Modem Test Jig

The Boomer-III Test Jig provides RS-232 serial interface ports between a PC and the modem. It is designed to enable you to quickly interface the Boomer-III to a standard PC (through a COM port) or a terminal device with an RS-232 serial port.

The test jig acts as a temporary host/terminal for the modem and provides access points to the radio's communication port, allowing you to monitor activity with a logic probe, multimeter or oscilloscope.

Features

- ❑ All Input/Output Lines configurable by jumpers and/or accessible through parallel FPC connector.
- ❑ On-board dual RS232 Serial Communication interface ports with DB9 connectors
- ❑ Through the SPY MODEM connector, you can monitor the data transmitted from the modem (RX, DSR, and CTS).
- ❑ Through the PORT 2/SPY PC connector, you can monitor the data transmitted from the PC (TX, RTS and DTR), or talk to the second serial port of the modem. You can make this choice by putting all five jumper links on the right or left side of the RDW header connector near the port.
- ❑ Switches and LED indicators on SS0 - SS3 modem I/O lines.
- ❑ On-board voltage regulator for Boomer-III OEM supply rail.
- ❑ On-board LEDs for three external signals:

Low battery

Message waiting

In range

- ❑ On-board antenna matching network allowing conversion from MMCX to SMA connectors.

Test Jig Updates

From time to time updates may be provided for the Boomer-III test jig and these should be implemented as per the Update Notice. If you are unsure if your test jig incorporates all the latest updates please contact Wavenet Technology.

Exploring the Boomer-III Test Jig

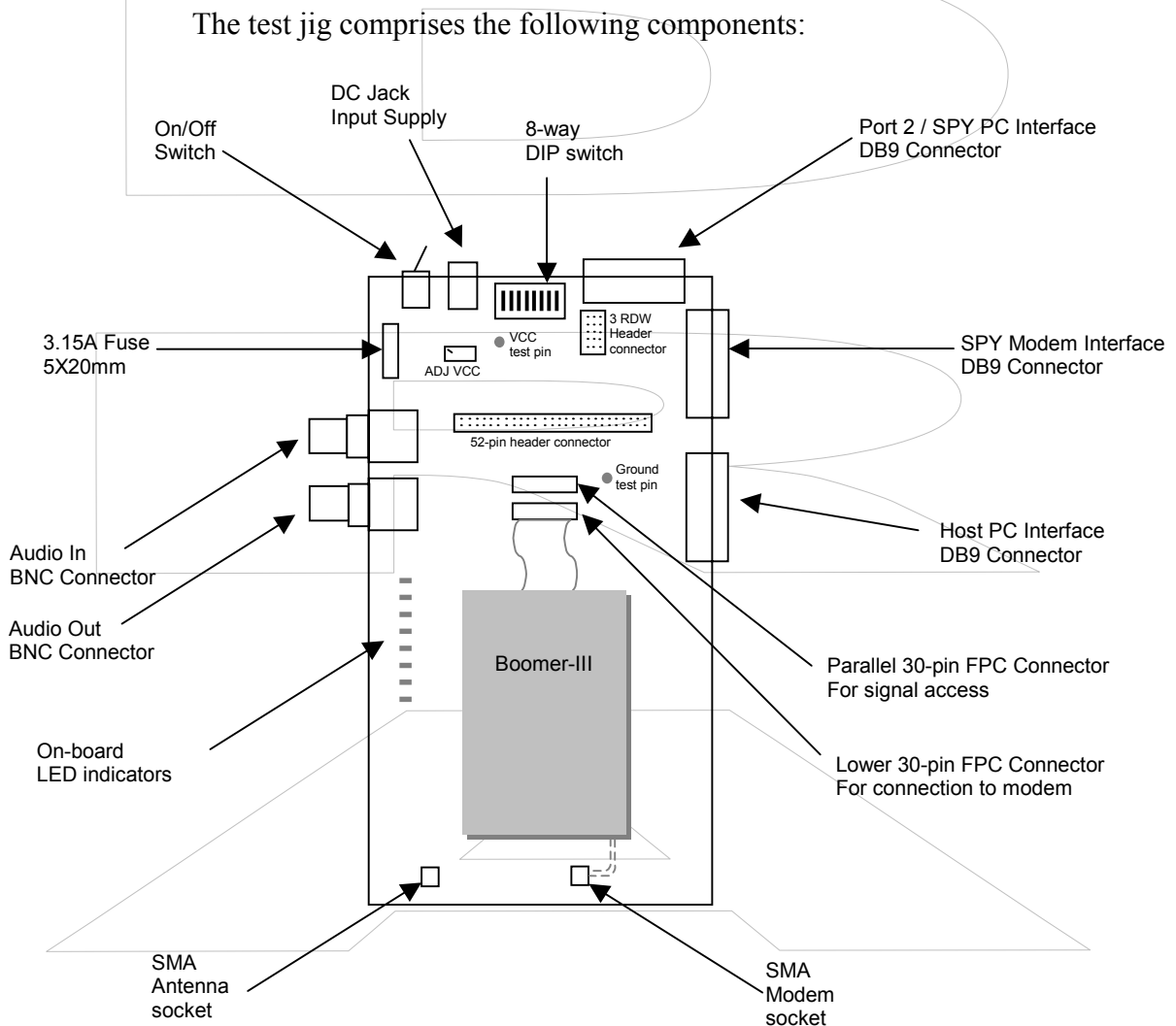

On / Off switch Switches the power to the test jig on or off.

DC Jack Provides power to the test jig. (3.8V)

DIP Switch 8-way DIP switch used to configure the test jig.

The following table shows the DIP switch configuration.

| Dip Switch # | Signal | On | Off | Default Position |
|--------------|---------|--|------------------------------|------------------|
| 1 | PA7 | Always leave this switch in the OFF position | | OFF |
| 2 | OSC OFF | Always leave this switch in the ON position | | ON |
| 3 | SS3 | 3V | 10k Pull down to GND | OFF |
| 4 | SS2 | 3V | 10k Pull down to GND | OFF |
| 5 | SS1 | 3V | 10k Pull down to GND | OFF |
| 6 | SS0 | 3V | 10k Pull down to GND | OFF |
| 7 | H-P-ON | Turn the modem off | Turn the modem on | OFF |
| 8 | RESET | Keep modem reset | Keep modem in working status | OFF |

Port 2 / SPY PC Connector

DB9 connector used for two purposes depending upon the settings of the jumper switches located just behind the connector on the PCB. If the jumpers are used to connect the centre column to the right hand outer column (TX, RTS etc), then the port acts as a spy connection for the data between the PC and the modem via the PC connector.

An analyser program such as "spy.exe" can be used to view the data.

SPY Modem Connector

DB9 connector, used to spy on the RS-232 data sent by the modem to the DTE (using DSR, RX, CTS and GND signals).

An analyser program such as "spy.exe" can be used to view the data. A communication program such as "HyperTerminal" can be of limited use if the data spied upon contains a lot of alpha-numeric ASCII characters.

Host PC Connector

DB9 connector, used to connect serial port 1 (of 2) of the modem to the DTE. The default values for this RS-232 connection is 9600bps, 8 bits, no parity, 1 stop bit.

This port can also be used to download new modem software to the Boomer-III.

Parallel FPC Connector

30-way FPC (Flexible Printed Circuit) connector used for signal access.

Lower FPC Connector

30-way FPC (Flexible Printed Circuit) connector used to connect the Boomer-III to the test jig.

Modem Connector

Used to connect the Boomer-III's antenna socket to the antenna connector.

Antenna Connector

Used to connect the external antenna.

LEDs

There are eight LEDs used to indicate the following:

- Power
- Low Battery
- In Range
- Message Waiting
- SS0
- SS1
- SS2
- SS3

Audio Out

Connector for monitoring an audio output. Used to monitor base band signal, BIT Error Rate (requires a PER test jig), receiver and demodulation.

Warning: *Must use a high impedance monitor, 100kΩ.*

Audio In

Connector for monitoring an audio input. Used to monitor modulation and transmission.

Warning: *Must use a high impedance monitor, 100kΩ.*

3 RDW Header Connector

Connectors used for jumpers (supplied).

For Port 2 use, all the jumpers are positioned from the centre column to the left hand column.

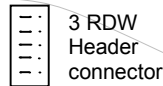

For Spy PC use, all the jumpers are positioned from the centre column to the right hand column.

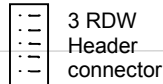

52-pin Header Connector

Connector used for jumpers (supplied). All the jumpers are connected as default.

- 1 DCD
- 2 RX
- 3 TX
- 4 DTR
- 5 GND
- 6 DSR
- 7 RTS
- 8 CTS
- 9 RI
- 10 RESET
- 11 H-P-ON
- 12 MSGWTG
- 13 INRANGE
- 14 LOWBAT
- 15 SSO/RX2
- 16 SS1/TX2
- 17 SS2/CTS2
- 18 SS3/RTS2
- 19 3.8V
- 20 3.8V
- 21 3.8V
- 22 3.8V
- 23 GND
- 24 GND
- 25 GND
- 26 GND

Initial Calibration

Without connecting a Boomer-III OEM Modem to the Test Jig, initially check the calibration of the on-board voltage regulator. (This regulator supplies the RS232 converter and other on-board circuitry only. It does not supply power to the modem).

1. Connect the centre pin of the DC jack to the +3.8V power supply with 2A capability and the external pin to the ground.
2. Adjust the trim pot marked ADJ VCC to make sure the voltage on the test pin next to the ADJ VCC is 3V.
3. Keep all of the switches on the dipswitch in the off position (except DIP switch 2) for normal modem operation.

Fitting the Boomer-III Modem

With the power off,

1. Connect the Boomer-III OEM modem to the lower FPC connector on the test jig using a 30-way FPC cable.

Use the following procedure to insert the cable into the FPC connector.

- a. Lift up the lock lever of the FPC connector by flipping it up with the nail of your thumb or index finger.

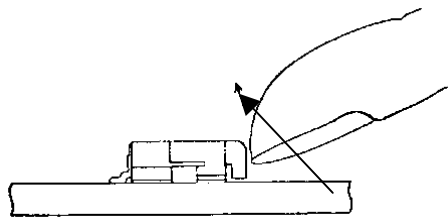

Lock Lever

- b. Ensure that the cable is inline with the connector and insert the FPC cable into the connector with the conducting surface of the cable facing downwards.



- c. Press down the lock lever.

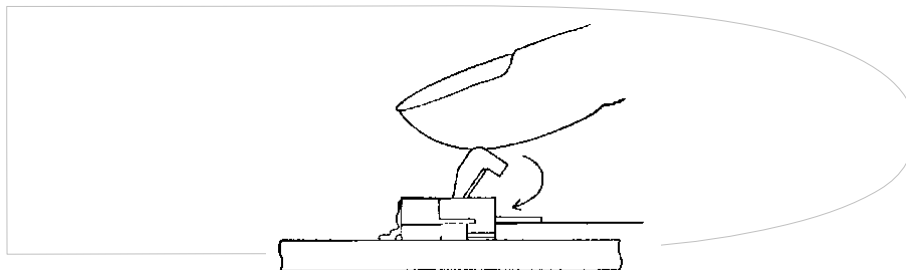

Note: If the cable has been partially inserted, or out of alignment, the lock lever will not engage. Should this occur, remove the cable (see below) and repeat steps a-c.

Use the following procedure to remove the cable from the FPC connector.

- a. Lift up the lock lever of the FPC connector by flipping it up with the nail of your thumb or index finger.

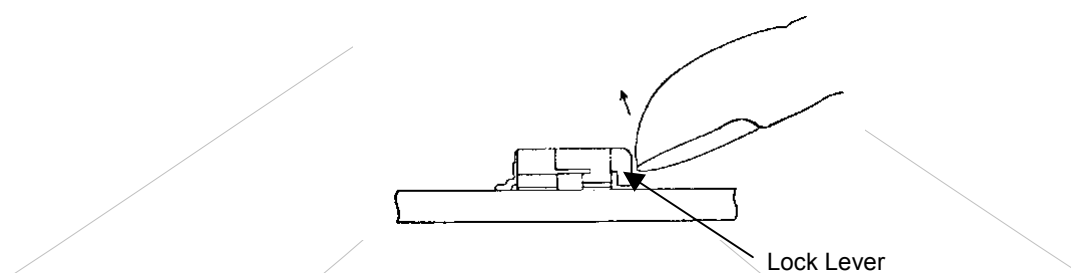

- b. Remove the cable after the lock is released.

2. Install an antenna to the modem. Use either the on-board SMA connection and an adapter cable between the modem MMCX connector and the test jig SMA connector, or connect directly to the modem itself.
3. Connect the PC serial cable to the DB9 connector marked "PC".
4. After making sure the power supply is set with the operating voltage range of the modem switch the power supply on.
5. Select the DIP switch labelled H-P-ON to the ON position. The green Power LED on the modem should illuminate.

You are now ready to communicate with the modem using the PC as a host/terminal. The modem should be able to talk to the PC by using Wavenet Commander software, or other NCL protocol software.

Software Development Tools

Wavenet SDK

DataTAC networks allow wireless communication and are installed in many different countries around the world.

The Wavenet Software Development Kit (SDK) has been developed to facilitate development of applications for these networks by providing a simple program interface for communicating with the network devices.

SDK Software Architecture

The SDK is built on a client-server architecture. The server application allows multiple client applications simultaneous access to the modem. The sample 'ModemInfo' application is an example of a client application. The 'PortServer' application acts as the server.

SDK Contents

The SDK contains the following components:

- Integrators Guide and Users Manual for Boomer-III OEM modem (This manual)

- "Wavenet Commander" software

Wavenet Commander is a modem application development and diagnostic communications tool that runs on a Windows PC and allows communication with the modem via the Boomer-III Test Jig. It provides a means for users to become familiar with the modem and uses NCL protocol to communicate with the modem.

- NCL Application Interface (API):

The NCL API is the wireless client component of the SDK. It provides routines for sending and receiving data using an NCL compliant Radio Packet Modem (RPM).

The NCL_API PortServer application allows multiple client applications simultaneous access to the modem via a single communications port. A sample client application 'ModemInfo' with full source code is included in the NCL_API directories.

- ModemInfo

A directory structure containing source files and executable for the sample ModemInfo Client application.

- PortServer

A directory structure containing a serial port sever. The serial port server runs as a service on your PC and allows multiple clients to access the modem via a serial port.

- Virtual Device Driver (VDD)

A directory structure for the VDD library containing functions required for client applications to communicate with the modem (i.e. Send, Receive etc) via MSMQ and the PortServer services. The VDD consists of the following files:

- VDD.dll: Dynamic Link Library. Ensure that a copy of this file is in the client's application path.
- VDD.lib: Library used by the linker when building client applications.
- Nclapi.h: Header file containing the function prototypes exported by the DLL.

System Requirements

The minimum system requirements of a host/terminal emulation PC in order to utilise the Software Developers Kit are:

Intel compatible Pentium computer or higher

Windows 2000 or later

Microsoft Message Queue (MSMQ)

16MB RAM (memory) minimum, 32MB recommended

1MB available hard disk space

9-pin serial Port using a 16550 UART

3.5-inch Disk Drive

CD-ROM drive

Wavenet Commander will run on Windows 98 and later revisions, however, the PortServer and ModemInfo requires the Microsoft Message Queue (MSMQ) service running on the target PC. MSMQ is included in Windows NT4, Windows 2000, and Windows XP. MSMQ is not available for WIN98, WINME, or WIN95. If you do not have Microsoft Message Queue installed on your machine, you might receive an error message indicating that a file, mqoa.dll, is missing when you try to compile code that uses the message queue.

Installing Message Queuing Services on Windows 2000 and XP

- ❑ For Windows 2000 users, on the Start menu, choose Settings and then choose Control Panel.
- ❑ For Windows XP and later, on the Start menu, choose Control Panel.
- ❑ In Control Panel, choose Add/Remove Programs and then choose Add/Remove Windows Components.
- ❑ In the Windows Component Wizard, choose Message Queuing Services from the Components list.
- ❑ Click Next, and then follow the remaining steps.

Installing Message Queuing Services on Windows NT4

- ❑ Download and install Windows NT4 Option Pack from the Internet at <http://www.microsoft.com/NTServer/nts/downloads/recommended/NT4OptPk/default.asp>.
- ❑ Be sure to select to install Microsoft Message Queue Server 1.0.

All code was developed using Microsoft Visual C++ Version 6.0, for Microsoft Windows WIN98/NT/2000.

Server Initialisation

The port server must be running for the Client applications to work. 'PortServer.exe' takes the desired serial port name as a command line parameter. If no command line parameter is specified, 'PortServer' assumes that 'com1' is desired. Start the server application by running 'PortServer.exe'. If com2 is connected to the modem, run the server as following: PortServer com2.

This server application does not have a user's interface. The only way to ensure that it is running is to view the active processes on the Windows Task Manager.

VDD Library

The VDD library contains all tools required for client-server communications by using the MSMQ service to deliver messages to the other party. All client applications are required to open a session with the server application if it wants to communicate with the modem. By using the VDD library this process message delivery is transparent for the client.

Please refer to Appendix B – SDK NCL-API and Port Server and Appendix C – SDK Sample programs for additional information on the Boomer-III SDK contents.

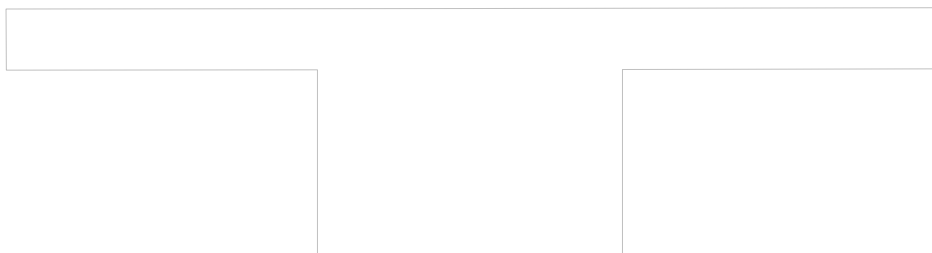
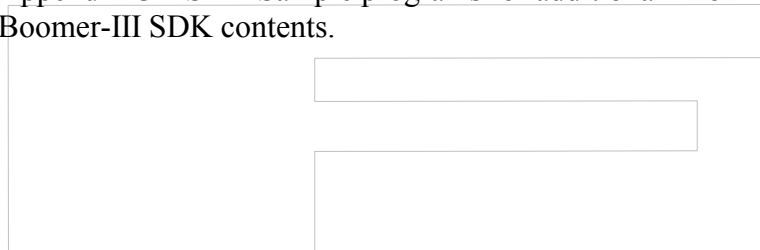

Wavenet Commander

The radio service utility software “Wavenet Commander” enables a user to exercise and configure Wavenet Modems. This software runs under Windows 95, 98, NT, or 2000.

Wavenet Commander interfaces with the Boomer-III OEM Modem via a PC’s communications port and the Test Jig’s PC port using an RS-232 cable.

Wavenet Commander is issued as an install shield and will create the following files in the user designated installation directory:

- ❑ WC_End_User.wcu The executable file
- ❑ user_defined.def Definition file for User Scripts
- ❑ ncl_generic.def Default NCL Commands.

Refer to Appendix A - NCL Interface for the NCL command list.

A typical screen shot from Wavenet Commander is shown below.

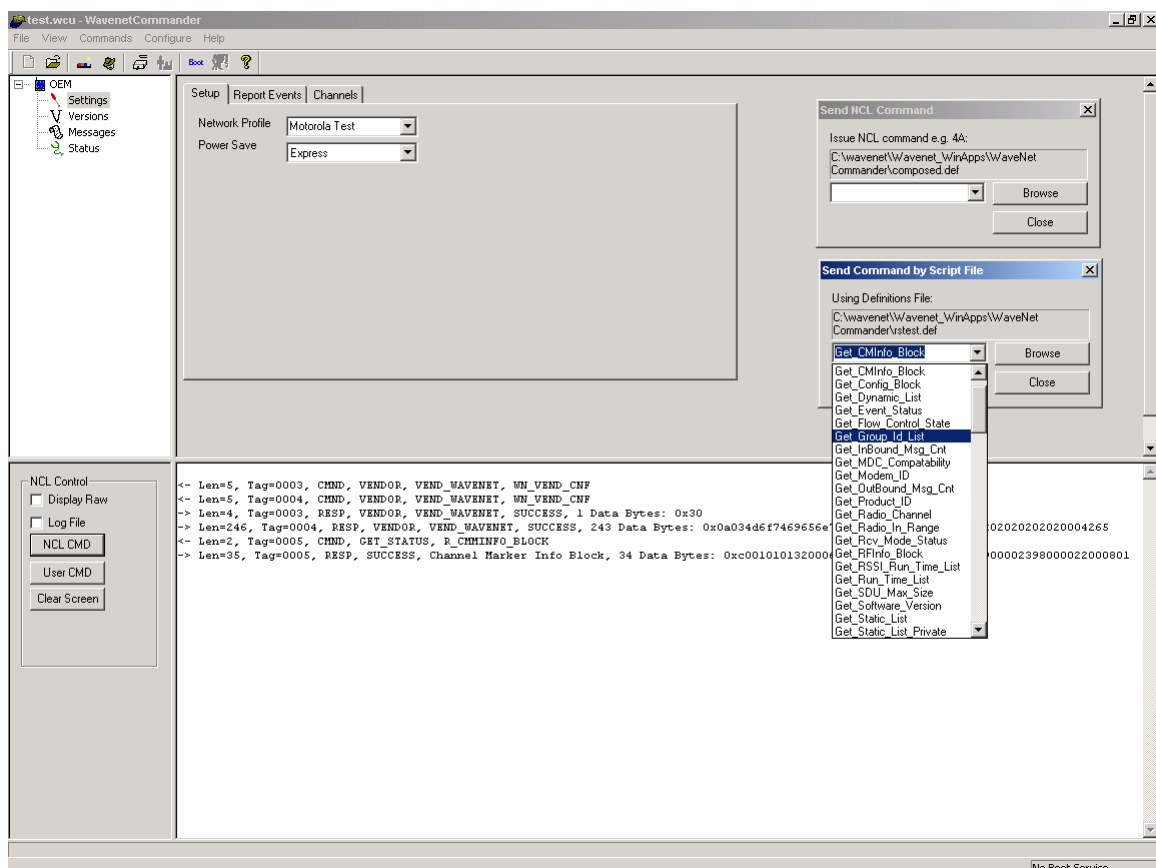

Operations

Wavenet Commander display is broken up to four quadrants as follows:

| | |
|--|---|
| <p>Upper-Left</p> <p>“Modem Info” Tree View</p> <p>The modem Type and display options are represented as Tree view. Use the mouse to select the following modem information views.</p> <p>Settings: Basic Modem settings</p> <p>Versions: Modems Versions</p> <p>Messages: Send / Receive Messages.</p> <p>Status: Modem Status.</p> <p>For each view there are various associated property pages</p> | <p>Upper-Right</p> <p>“Modem Info” Property View</p> <p>Displays the associated property pages as selected by the quick link in the tree view.</p> |
| <p>Lower-Left</p> <p>TTY Control View</p> <p>TTY setting control allowing users to choose what kind of information they want to see in the Lower-Right hand quadrant. Allows the user clear the window, Issue User defined and standard NCL commands.</p> | <p>Lower-Right</p> <p>Edit View</p> <p>Edit view displaying raw and/or interpreted data flowing between the modem and the PC.</p> |

On start-up the user is presented with an icon in the tree view representing the type of modem Wavenet Commander was last connected to. To check /adjust the communication port settings, press the Hot Key **F6** or click on the connect icon in the toolbar. Choose the modem communications port when prompted and following view will be displayed.

Note: The base station port is for Depot Test Mode, which is not available in the user version

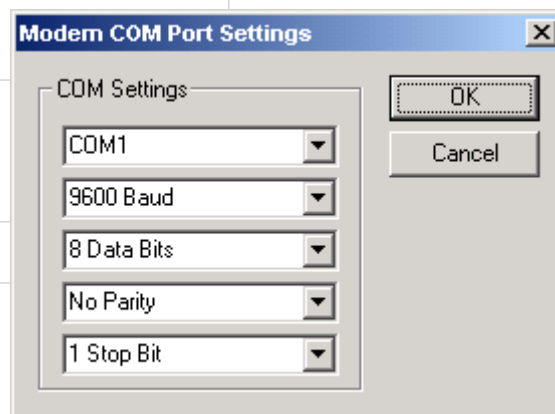

Ensure the test jig with the modem is powered up and connected (Serial cable from PC port of the Test Jig to your PC's Communication port) and the above the communication settings are correct for your set-up.

Modem Info Tree View

ModemInfo uses the NCL API to interface to the DataTAC[®] network. Modem Info allows the user to view the modem's current status, to send and receive messages on the current channel the device is registered to. The options displayed in the tree include the following:

Settings: Allows the user to select an operational profile (i.e. Channel list, RD -Lap version, etc), and the modems power save mode (if required). The user can also set the notification events, and adjust the channel list.

Versions: Displays the devices LLI, serial number, software version, modem configuration version and the hardware platform.

Messages: Allows a user to send and receive messages from the channel the device is currently registered on.

Status: Displays the modem's current channel (if registered) and its RSSI level. If the device is not registered, it will be in scan mode, scanning the channels from the channel list in its current profile.

Modem Info Property View

The property view is dependant on the tree view. The following property pages are displayed for each tree view.

Settings: The user can select, the network profile, and if required the modems power save mode.

- **Network Profile:** The current network profile is displayed. The user can select a profile via the profile display list when this field is selected. Note the device must be registered with the appropriate network provider for the device to log on.
- **Power Save:** The user can select the devices power save mode as required. Note in some networks power save mode is not supported.

Versions: Displays the devices LLI, serial number, hardware platform and software version.

Messages: Allows a user to send and receive messages from the channel the device is currently registered on. Type the required message in the send message window and then click on the <Send> button. Any received data messages will be displayed in both the received message window and the **Edit View** Window. Note your modem must be registered on a channel.

Status: Displays the modem's RF-Protocol, channel, RSSI, In Range Status, Base Station ID the modem is registered on, and the modems power source level.

TTY Control View

The TTY control View allows the user to perform the following:

- Display detailed commands and responses. The commands to the modem and the responses from the modem are displayed in Hex format. A maximum of 200 bytes is displayed per command or response.
- Allows the user to enable / disable the wc.log file. The log file will contain the information displayed in the Edit View window for future reference.
- Allows the user to run standard NCL command by selection of the <NCL CMD> button. The user can edit the ncl_generic.def file with an external editor as required.
- Allows the user to run a user defined NCL command by selection of the <User CMD> button. The user can modify the user_defined.def file using an external editor as required. Details on how to generate a user command are contained in the def file.
- Clear the Edit View screen by selection of the <Clear Screen> Button.

Edit View

The Edit View displays the commands issued to the modem and the modems responses. Wavenet Commander will where possible interpret the modem's response, and display the response in detail; otherwise the response will be displayed as hex bytes. From this window the user can issue some basic commands that include the underscore ' _ ' command which will get the modems status and the exclamation command "!" for the modem settings. Pressing "?" will display basic help.

Hot Keys

Wavenet Commander has the following Hot Keys.

- **F4** Standard NCL command Selection.
- **F5** User NCL Command Selection
- **F6** Communication port configuration.

Wavenet Application Loader

The Application Loader software is used to upgrade the resident software installed on your Wavenet OEM modem. For optimum performance ensure that you are using the latest application version.

This appendix explains the procedure for updating the Application Loader software and has a troubleshooting section to assist with any problems.

Updating Application Loader Software on Your Modem

The Application Loader software may be used for all Wavenet modems. The procedure is the same for all modems but some of the screens may differ in appearance.

Follow the procedure below to check the software version currently loaded on your modem and if necessary, to upload the modem application.

1. Connect the Boomer-III to the Test Jig as described on page 22.
2. Connect the Data Communications Modem connector to the Boomer-III Test Jig's PC connector.
3. Connect the Data Communications PC connector to a COM (serial) port on your computer. Note that the Data Comms PC connector is a 9-pin plug. If your computer has a 25-pin serial port you will need a 9-pin to 25-pin adapter.
4. Switch the modem on.
5. Switch your PC on.
6. From the PC, open the appropriate Application Loader (Apploader) file for your modem.

The letter(s) preceding the three numerical characters at the end of the Apploader file name denotes which modem the file is appropriate for, BM3 for the Boomer-III OEM modem.

The three numerical characters at the end of the file name show the version number of the application software, i.e.
408 is software version 4.08 and
233 is software version 2.33

If you select the incorrect Apploader file for your modem the following typical message will be displayed.

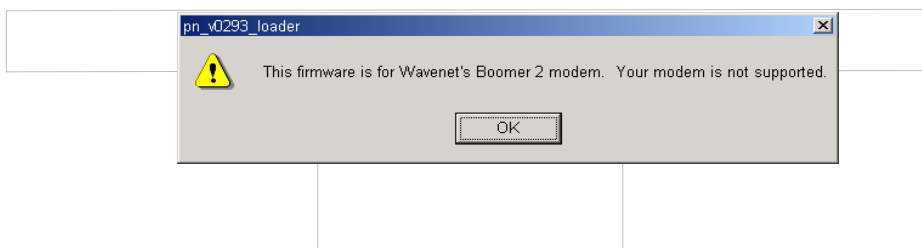

Note: The message shown above will appear if you are attempting to upgrade using ApploaderM408.exe with a BM3 modem.

7. The following screen is typically displayed.

Select the appropriate com port on your PC that the modem is connected to.

Click the Download Application button to download the latest version.

Displays the current version of Application software on your modem.

Displays the new application available.

Status bar.

8. Select the appropriate PC communications port to which the modem is connected.

9. If the program recognises that the version of Application you are attempting to install is later than the version currently installed, the Download Application button will become enabled. A message is displayed in the status bar advising that the application software versions differ and requesting that you press the Download Application button to update.

If the program recognises that the version of Application you are attempting to install is earlier than the version currently installed, the Download Application button will remain disabled. A message is displayed in the status bar advising that the application software version on the modem is up to date and requesting that you exit the program.

10. Click  to update the Application software.

A progress bar is displayed informing you of the progress of the update, and the modems TX led will flash as the modem is being loaded.

11. After the application has been updated, the modem is automatically switched off. A message is displayed prompting you to switch the modem on again.

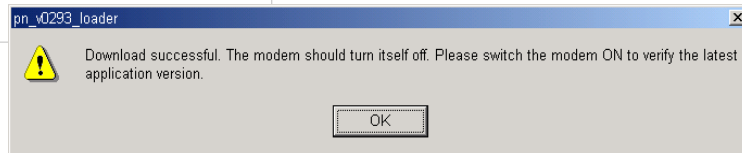

12. Click  and the download window will read the modems application version and redisplay it.

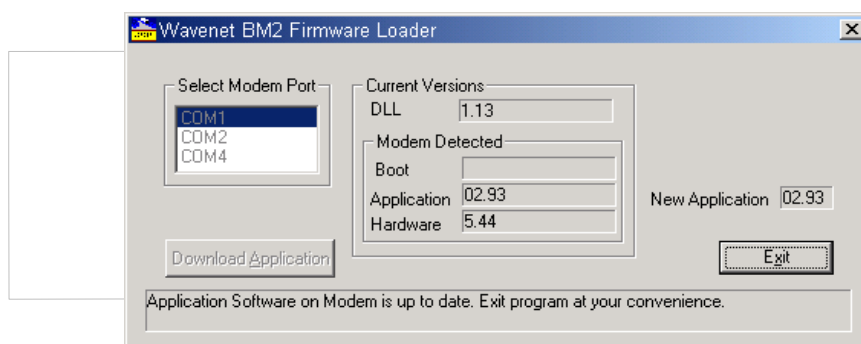

13. A message is then displayed in the status bar, informing you that that the application software on the modem is up to date.

14. Click  to exit the program. This will automatically reset the modem.

Troubleshooting

You shouldn't encounter any problems updating the Application Loader software, however the following messages may appear.

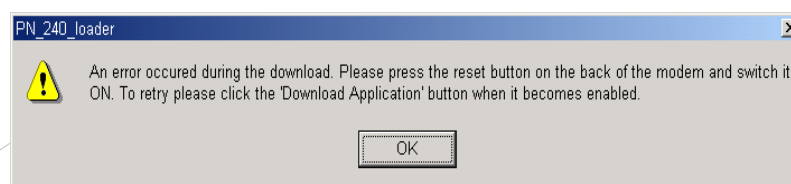

This message will appear if the modem is disconnected during the download. Ensure that all the connections between the PC and the modem are secure, check the battery connections, ensure the modem is switched on and follow the instructions in the message to try again.

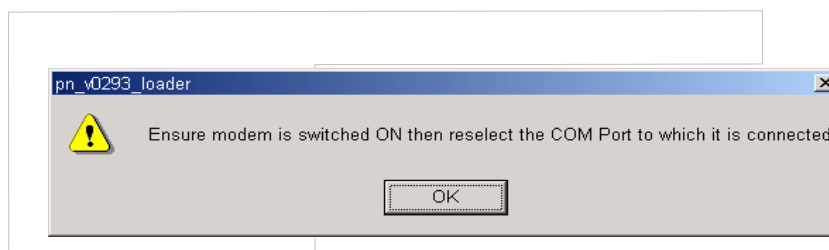

This message will appear if the modem is disconnected whilst running the Application Loader. Ensure that all the connections between the PC and the modem are secure, check the battery connections and ensure the modem is switched on.

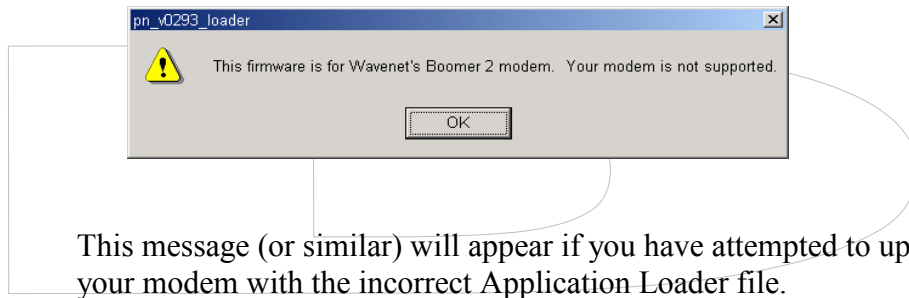

This message (or similar) will appear if you have attempted to upgrade your modem with the incorrect Application Loader file.

The letter preceding the three numerical characters at the end of the Application loader file name denotes which modem the file is appropriate for, i.e. BM3 for the Boomer-III OEM modem.

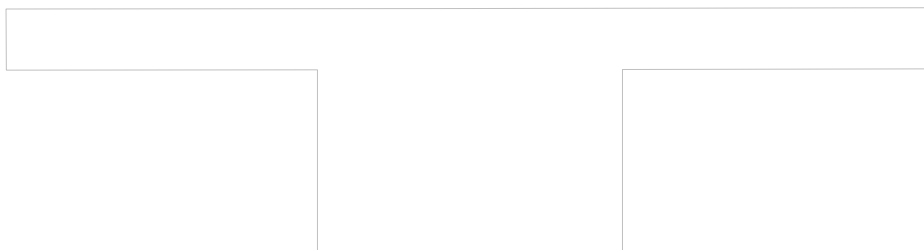
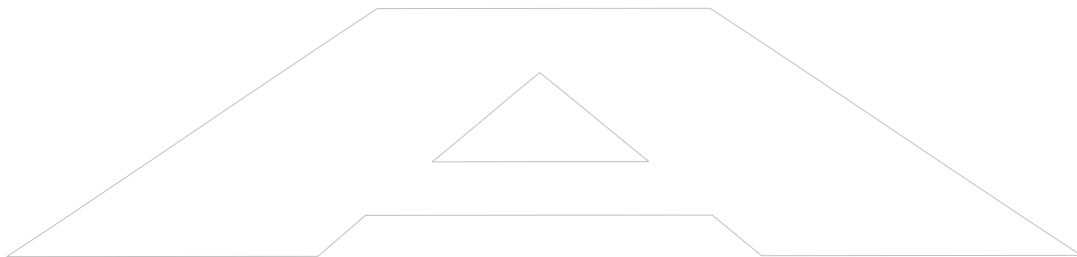

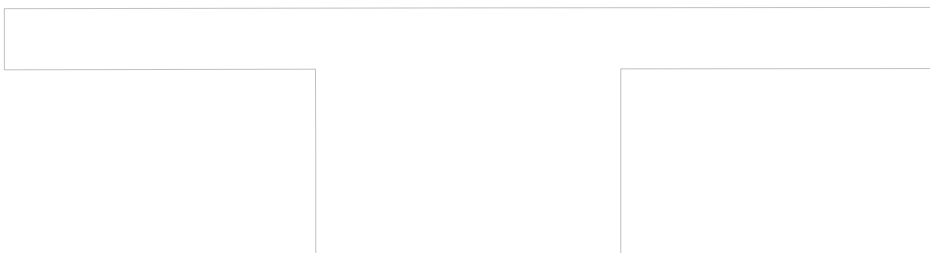
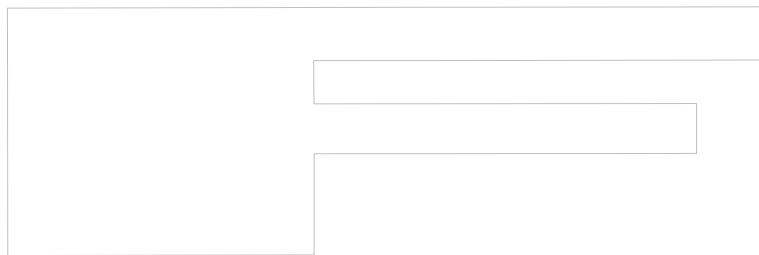
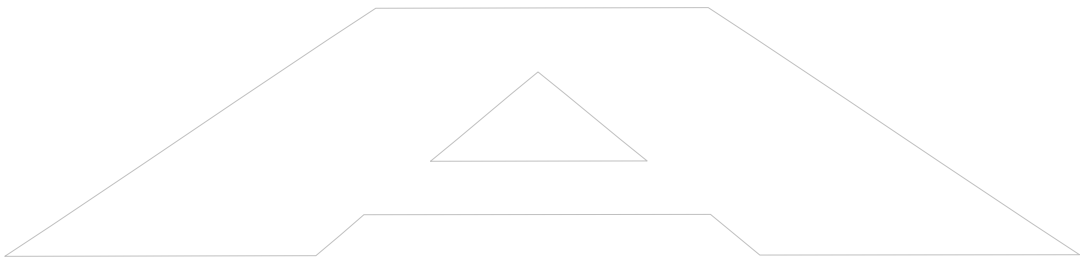
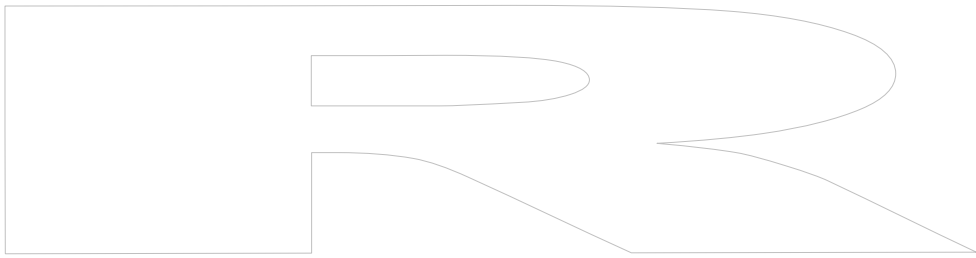
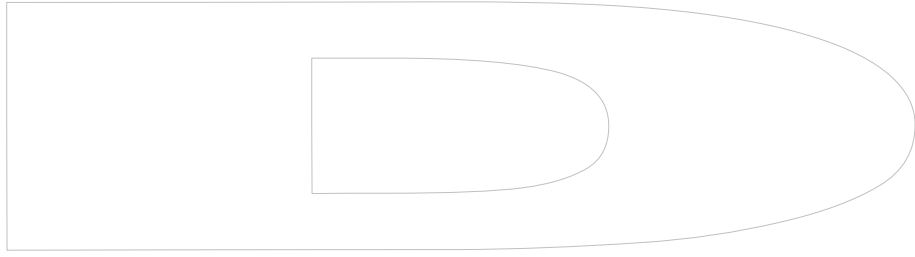

Integration Testing

This section contains a product development checklist of parameters to check, requirements to meet, and standards of performance to evaluate. You can use these process checks and functional test procedures to fully qualify that the Boomer-III OEM Modem has been integrated properly into the host/terminal.

Proper testing throughout the development and integration cycle ensures that the final product works in both normal and exceptional situations. These tests are provided in several stages as follows:

1. Hardware integration
2. Desense and EMI
3. Regulatory compliance
4. Application software
5. Final assembly
6. End user problem resolution
7. OEM service depot repair

Hardware Integration

To ensure that the integration effort is carried out properly, monitor all relevant engineering standards, requirements, and specifications. In addition, perform functional tests during product development to validate that the integrated package performs as designed.

Enabler Functions

To test the interaction between the modem and host/terminal, your product must be able to perform the following:

- ❑ Turn the various hardware components on and off. This capability helps to isolate possible desense and other emissions problems. (See “Desense and EMI” on page 75.)
- ❑ Pass data through the host/terminal between the modem and the test platform. This allows external programming and configuration software to communicate with the modem while it is integrated within the host/terminal. For microprocessor-based products, pass-through mode uses software emulation involving the host/terminal processor, which passes full-duplex serial port data to and from the integrated modem. Otherwise, pass-through mode is implemented in hardware by level shifting between the 3V CMOS levels and the 12V RS-232 levels generally found on PCs.

Specific Tests

In addition to the various tests that exercise your own circuitry, such as power-on self-test, design tests that ensure proper interaction between

the modem and host/terminal. Ensure that the following hardware integration issues are evaluated:

RF Immunity

RF transmissions of the modem do not interfere with operation of the host/terminal.

Electrical Signaling

Power sources and interface are functionally compatible between the host/terminal and the modem.

Physical Parameters

Physical configuration of the modem inside the host/terminal provides adequate ventilation, mounting, shielding, and grounding.

Antenna Performance

Integrated antenna system meets the required ERP specifications, VSWR specifications, antenna propagation patterns and any applicable network operator requirements.

ESD Requirements

Host/terminal design protects the modem from ESD.

RF Re-radiation

Host/terminal does not allow spurious emissions in excess of 60dBc, as caused by carrier re-radiation (for 3V/m fields).

Desense and EMI

Any host/terminal in which the modem is integrated generates some EMI (electromagnetic interference), which tends to desensitize the modem's ability to receive at certain frequencies.

Wavenet can provide a facility for testing the amount of desense that your modem experiences while in a host/terminal. Specifically, modem receiver sensitivity is recorded while operating with the host/terminal under test. For this test, you provide an integrated product, including antenna, power supply and any peripherals. Wavenet Technology then produces a test graph that reports the amount of desense. All desense testing is generally performed at Wavenet Technology's facilities.

To prepare for the desense test, provide Wavenet with hardware to generate EMI that is representative of the final product, including the cables, power supplies, and other peripheral devices. The host/terminal must supply the modem the appropriate power requirements. The host/terminal hardware must be running its CPU, LEDs, and serial ports, etc (if so configured).

You must supply either the pass-through mode functionality ("Enabler Functions" on page 74) or provide physical access the serial port of the

modem . The ability to turn on and off the various circuits in the host/terminal allows for the identification and analysis of the host/terminal components that are responsible for desense. This approach to desense troubleshooting can greatly speed up the OEM integration effort.

For more detailed information about desense, refer to “Guide to Desense” on page 132.

Regulatory Compliance

Most countries where the final product will be sold generally require approval from the local government regulatory body. In the US, the FCC requires that two individual requirements be met before the final product can be certified. The first test, the FCC Part 15 qualification, requires you to prove that the product electronics hardware does not yield local radiation capable of affecting other equipment, such as TVs, computer monitors, and so on.

The second test (FCC Part 90) requires you to prove when the modem transmits, it remains properly in its allocated channel spacing, and does not produce spikes or splatter in other frequencies. Wavenet undergoes FCC testing with the modem stand-alone to ensure compatibility with these requirements. But since the eventual transmit capability of the modem is highly integrated with the power supply and antenna system of the host/terminal, the fully integrated product must be submitted for final regulatory approval.

In addition, regulatory bodies can require the wireless modem to transmit random data patterns on specific frequencies while incorporated in the host/terminal. The Boomer-III OEM modem incorporates special debug modes to allow this kind of testing, provided the host/terminal application can issue the required commands to the modem.

The entire regulatory process can take many months to complete and should start early in the development cycle. The exact regulatory requirements of each country change from time to time. For efficient regulatory processing, it is recommend to use the services of specialized regulatory consultants to determine the specific requirements at the time of manufacture.

To prepare for regulatory testing, you need to integrate the pass-through mode into the product design (see “Enabler Functions” on page 74). Wavenet provides the ability to key and dekey the radio at the required frequencies and modulation levels from an external PC via the pass-through mode.

For further information about regulatory compliance, refer to “Regulatory Requirements” on page 19.

Application Software

Tests need to verify the communications links between the host/terminal and the modem and between the modem and the network, as follows:

Software Driver Configuration

Ensure that the host/terminal can enable the modem serial port to permit the host/terminal and modem to communicate. This test verifies that the driver software functions well and is configured properly.

Network Configuration

Determine if the host/terminal can use the modem to communicate with a DataTAC[®] network. This test uses existing network software in an attempt to communicate with a specific network.

The final application must be able to respond correctly under all adverse network conditions, not just the ideal case. To achieve this, the application software has to be systematically tested against all possible failure and exception conditions. Situations such as low battery, out of range, host/terminal down, unexpected data, maximum message size, maximum peak/sustained throughput, and other conditions must not cause the host/terminal application to fail. Each condition must have a specific remedial action to alleviate it.

Final Assembly

A final assembly test should be performed before shipment to ensure all components are working properly and issues such as crimped antenna cables, loose connections, and improper software load are resolved. During final assembly, the modem may send and receive a loopback message of maximum size. The successful return of the sent message proves the product can transmit and receive correctly.

Testing within areas lacking network coverage or for products shipped to another country requires a different approach. Wavenet can help you set up a closed loop final test system, using a base station and PC-based software to emulate a network.

End User Problem Resolution

When the final product is in the hands of the end user, testing must quickly isolate the cause of the problem in the field. For example, is the problem caused by the host/terminal, the modem, the network, the configuration or a user error? Can the problem be fixed locally or does the unit need to be returned for service?

It is very time consuming and expensive to send products to service, especially if the problem is caused by a temporary network or Enterprise Server Application outage. For this reason, you should design the application to allow for end-user problem determination.

Effective tests provide a systematic, positive acknowledgment from each of the network components. For example:

- Test 1 Is the OEM module able to pass its own self test?
- Test 2 Is the OEM module able to communicate with peripherals?
- Test 3 Is the OEM module able to communicate with the integrated modem?
- Test 4 Is the modem able to hear the network?
- Test 5 Is the modem registered and allowed to operate on the network?
- Test 6 Is the gateway (if present) up and running?
- Test 7 Is the Enterprise Server Application up and running?

OEM Service Depot Repair

When a host/terminal is returned for service, the first requirement is to determine whether the modem must be sent on to Wavenet for inspection and/or repair. To set up for this test, you need to have an evaluation board, a known-good Boomer-III OEM modem (for comparison), a power supply, Wavenet Commander software and an end-to-end test setup. The end-to-end test can employ either a live network or an over-the-air test involving a communications monitor that can transmit and receive at the appropriate frequencies. The objective is to test the suspect modem in a known-good environment, in which all other components are known to be operational.

If the modem has been determined to be faulty it should be returned to the place of purchase for inspection and repair.

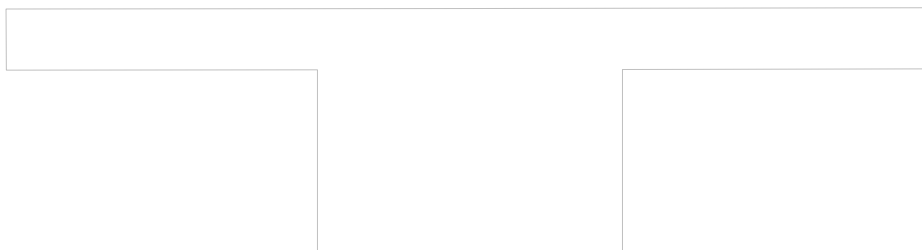
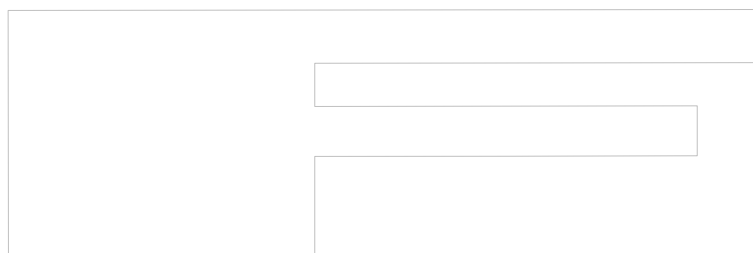

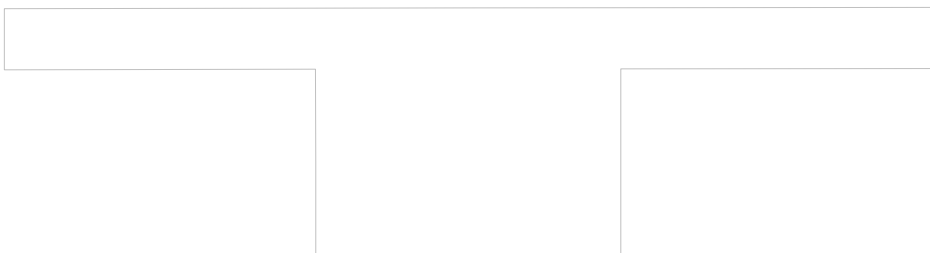
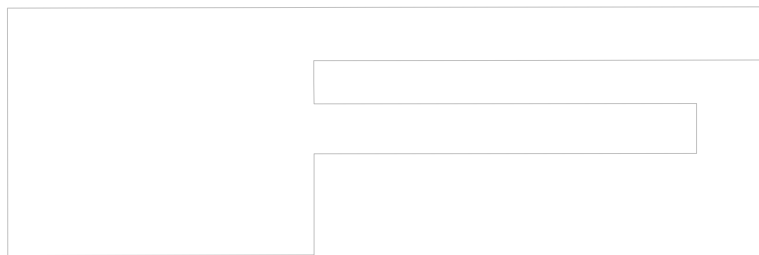
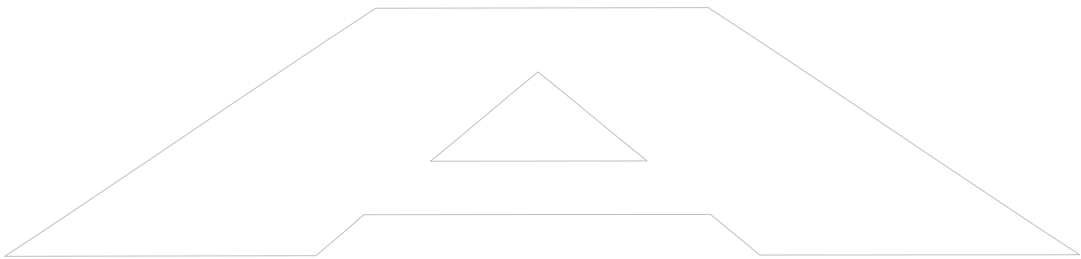
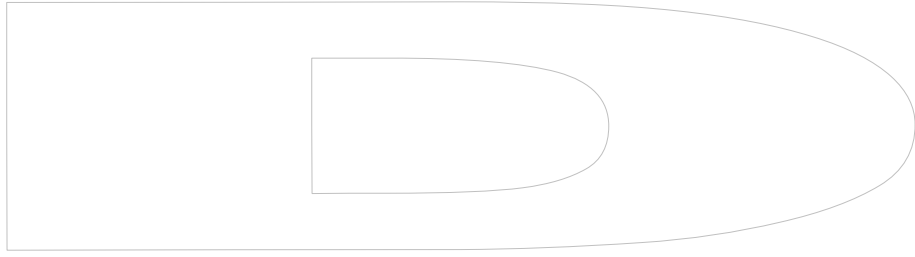

Appendix A - NCL Interface

The Boomer-III is compliant to Native Control Language (NCL) 1.2. Wavenet Vendor-specific extensions are also listed here.

The specification for the NCL protocol may be obtained in Adobe Acrobat format from the Motorola website at http://www.mot.com/MIMS/WDG/pdf_docs/8-.pdf

Generic NCL (Native Mode)

□ Command SDUs (CMND, ASCII A)

| Commands | Value | Parameters | Value | Sub-values and Descriptions |
|------------|------------------|--------------------|---------------|---|
| SEND | ASCII 1 | | | Send message. |
| READ_MSG | ASCII 2 | | | Read queued message in RPM. True only if confirmed delivery mode enabled. |
| CTL_EVENT | ASCII 3 | Event Report SDUs. | | Control event. |
| GET_STATUS | ASCII 4 | | | Get RPM status/configuration. |
| | R_CONFIG_BLOCK | | ASCII A | Get RPM configuration block. |
| | R_RF_BLOCK | | ASCII A | <i>Vendor-specific:</i> Get RF status block. |
| | R_STATUS_BLOCK | | ASCII B | Get RPM status block. |
| | R_PROD_ID | | ASCII C | Get RPM product ID: |
| | | | RF_RDLAP_9.6 | RF protocol is RD-LAP 9600. ASCII 0 |
| | | | RF_RDLAP_19.2 | RF protocol is RD-LAP 9200. ASCII 1 |
| | | | RF_MDC4800 | RF protocol is MDC 4800. ASCII 2 |
| | | | RF_DUAL | Dual RD-LAP 9.2/MDC4800. ASCII 3 |
| | | | NCL_PRE1.2 | NCL support is R1.0 or R1.1. ASCII 0 |
| | | | NCL_1.2 | NCL support is R1.2. ASCII 2 |
| | R_SYSID | | ASCII C | <i>Vendor-specific:</i> Get system ID of current RF system. |
| | R_SW_VERSION | | ASCII D | Get software version number. |
| | R_RPM_ID | | ASCII E | Get RPM address. |
| | R_RF_BLOCK_SHORT | | ASCII E | <i>Vendor-specific:</i> Get short form of RF status block. |
| | | | ASCII F | Reserved. |
| | R_MAX_DATA_SIZE | | ASCII G | Get SDU data limit. |
| | R_RPM_GID | | ASCII H | Get RPM group IDs. |
| | R_WAN_TYPE | | ASCII I | Get WAN Type Code. |
| | R_RF_VERSION | | ASCII J | Get RF protocol version number. |
| | R_VENDOR_ID | | ASCII K | Get vendor information: VEND_MOTOROLA Vendor is Motorola ASCII 0 |
| | | | ASCII L..Z | Reserved. |
| | R_RCV_MODE | | ASCII a | Get mode of notification to the DTE for received SDUs. |
| | R_RX_STATUS | | ASCII b | Get receiver enable status. |
| | R_TX_STATUS | | ASCII c | Get transmitter enable status. |
| | R_ANTENNA | | ASCII d | Get antenna selection status. |
| | R_RADIO_IN_RANGE | | ASCII e | Get radio in range status. |

| Commands | Value | Parameters | Value | Sub-values and Descriptions |
|----------|---------|----------------------|--------------|--|
| | | R_OB_MSG_COUNT | ASCII f | Count of outbound messages queued. |
| | | R_IB_MSG_COUNT | ASCII g | Count of inbound messages queued. |
| | | R_FLOW_CONTROL | ASCII h | Get flow control status. |
| | | R_EVENT_STATES | ASCII i | Get current event reporting enable/disable state. |
| | | R_RADIO_CHANNEL | ASCII j | Get current radio channel. |
| | | R_CHAN_BLOCK | ASCII k | Get RPM RF channel status block. |
| | | R_RF_STATISTICS | ASCII l | Get RPM RF statistics block. |
| | | R_BAT_LEVEL | ASCII m | Get battery status. |
| | | | ASCII n..x | Reserved. |
| | | R_DCHAN_TABLE | ASCII y | Read dynamic channel table. |
| | | R_CHAN_TABLE | ASCII z | Read static channel table. |
| SET_CNF | ASCII 5 | | | Set modem configuration. |
| | | S_RCV_MODE | ASCII A | Select the confirmed/unconfirmed Receive Data mode. |
| | | S_INACTIVITY_TIMEOUT | ASCII A | <i>Vendor-specific:</i> Set read time for outbound packet. |
| | | S_TX_CONTROL | ASCII B | Enable/disable the transmitter. |
| | | S_RX_CONTROL | ASCII C | Enable/disable the radio. |
| | | S_FLOW_CONTROL | ASCII D | Select the flow control method: |
| | | | FLOW_NONE | No flow control. ASCII 0 |
| | | | FLOW_XONXOFF | XON/XOFF ASCII 1 |
| | | | FLOW_RTSCS | RTS/CTS ASCII 2 |
| | | S_RADIO_CHANNEL | ASCII E | Select the radio channel. |
| | | S_CUR_CNF | ASCII F | Save the modem configuration |
| | | R_DEF_CNF | ASCII G | Restore the modem configuration |
| | | R_STO_CNF | ASCII H | Read the modem configuration: |
| | | CNF_EVENT_FLAGS | | Event control flag settings ASCII 0 |
| | | CNF_DELIVERY_MODE | | Outbound SDU del. mode ASCII 1 |
| | | CNF_RADIO_CONTROL | | Radio control settings: ASCII 2 |
| | | | S_RX_CONTROL | ASCII C |
| | | | S_TX_CONTROL | ASCII B |
| | | S_POWER_SAVE | ASCII I | Set the Power Save mode. |
| | | S_ROAM_MODE | ASCII J | Set the roaming mode: |
| | | | ROAM_MANUAL | Set to manual. ASCII 0 |
| | | | ROAM_AUTO | Set to automatic. ASCII 1 |

| Commands | Value | Parameters | Value | Sub-values and Descriptions |
|-----------|------------------|----------------|------------|--|
| | | S_BAUD | ASCII K | Set the baud rate for NCL communications: |
| | | | BAUD_1200 | 1200 baud ASCII 0 |
| | | | BAUD_2400 | 2400 baud ASCII 1 |
| | | | BAUD_4800 | 4800 baud ASCII 2 |
| | | | BAUD_9600 | 9600 baud ASCII 3 |
| | | | BAUD_19K2 | 19200 baud ASCII 4 |
| | | | BAUD_38K4 | 38400 baud ASCII 5 |
| | | S_ANTENNA | Undefined | Select the antenna |
| | | | ASCII L..Z | Reserved. |
| RESET_RPM | ASCII 6 | | | Reset RPM. |
| | | FLUSH_INBOUND | ASCII 1 | Flush inbound message queue. |
| | | FLUSH_OUTBOUND | ASCII 2 | Flush outbound message queue. |
| | | FLUSH_BOTH | ASCII 3 | Flush inbound and outbound message queues. |
| | | RESET_WARM | ASCII 4 | Warm start RPM. |
| | | RESET_TRANS | ASCII 5 | Reset to Transparent Mode, if Transparent Mode is supported. |
| | | RESET_FULL | ASCII 6 | Full reset of RPM. |
| | | RESET_NCL | ASCII 7 | Reset NCL interpreter only. |
| | | RESET_OFF | ASCII 8 | Power off the RPM. |
| | | RESET_DIAG | ASCII A | <i>Vendor-specific:</i> Cause DTE to enter diagnostic mode. |
| | ASCII A..Y, 7..9 | | | Reserved. |
| VENDOR | ASCII Z | | | Vendor-specific command. |

□ **Event Report SDUs (EVENT, ASCII B)**

| Events | Value | Event Report Enable | Bit | Parameters | Value | Descriptions |
|----------------------|---------|---------------------|------|----------------------|---------|--|
| RCV_MSG_DATA | ASCII A | RCV_MSG_DATA_BIT | \$10 | | | Received message data. |
| RCV_MSG_NOTIFICATION | ASCII B | RCV_MSG_NOTIFY_BIT | \$08 | | | Received message notification. True only if confirmed delivery mode enabled. |
| TX_EVENT | ASCII C | TX_EVENT_BIT | \$04 | | | Physical-level transmitter event. |
| | | | | TX_KEYED | ASCII 1 | Transmitter keyed. |
| | | | | TX_DEKEYED | ASCII 2 | Transmitter dekeyed. |
| RX_EVENT | ASCII D | RX_EVENT_BIT | \$02 | | | Physical-level receiver event. |
| | | | | RX_IN_RANGE | ASCII 1 | RF in range. |
| | | | | RX_OUT_OF_RANGE | ASCII 2 | RF out of range. |
| | | | | RX_PWR_SAVE_ENABLED | ASCII 3 | Power saving enabled. |
| | | | | RX_PWR_SAVE_DISABLED | ASCII 4 | Power saving disabled. |
| | | | | RX_ACTIVE | ASCII 5 | Device in active state on RF channel. |
| | | | | CHAN_DISALLOWED | ASCII 6 | Device disallowed on |

| | | | | channel. | | |
|----------|------------------|--------------|------|-----------------------------|---------|--|
| HW_EVENT | ASCII E | HW_EVENT_BIT | \$01 | RX_REG_DENIED | ASCII 7 | Flash LED for registration denial. |
| | | | | Hardware event. | | |
| | | | | HW_SELF_TEST | ASCII 1 | Self-test failed. |
| | | | | HW_LOW_BATT | ASCII 2 | Low battery. |
| | | | | HW_MEM_FULL | ASCII 3 | Memory full. |
| | | | | HW_BATT_OK | ASCII 4 | Battery level OK. |
| | | | | HW_MEM_OK | ASCII 5 | Memory OK. |
| | | | | HW_OFF | ASCII 6 | Device shutdown imminent. |
| RCV_ERR | ASCII F | | | HW_BATT_WARN | ASCII 7 | Battery at warning level. |
| | | | | Unreceivable message event. | | |
| RCV_ERR | ASCII F | | | RCV_TX_DISABLED | ASCII 1 | ACK required, PDU received. Cannot ACK, transmitter disabled. PDU discarded. |
| | | | | | | |
| CONTROL | ASCII G | CONTROL_BIT | \$20 | | | Control event. |
| | | | | CONNECT | ASCII 1 | NCL connect between RPM and DTE . |
| | ASCII H..Y, 1..9 | | | | | Reserved. |
| VENDOR | ASCII Z | | | | | Vendor-specific event. |

□ Response Status SDUs (RESP, ASCII C)

| Responses | Value | Parameters | Value | Description/Error Code |
|--------------|---------|--|---------|--|
| SUCCESS | ASCII 1 | | | Successful. |
| XFAIL | ASCII 2 | IBQ_FLUSHED | ASCII a | Error code. Pending SDUs in inbound queue flushed; transmitter disabled. Used only if the RPM cannot support message buffering while transmitter disabled. |
| | | Command execution error. Note the following error codes: | | |
| | | NO_RESPONSE | ASCII A | No response from network. |
| | | NO_ACK | ASCII B | Negative ACK received. |
| | | HOST_DOWN | ASCII C | Host access is down. |
| | | NOT_REGISTERED | ASCII D | RPM not registered. |
| | | LOW_BATTERY | ASCII E | Low battery—cannot transmit. |
| | | IBQ_FULL | ASCII F | RPM inbound queue is full. |
| | | TX_DISABLED | ASCII G | Radio transmitter is disabled. |
| | | BUSY | ASCII H | Resource is unavailable. |
| | | NOT_AVAILABLE | ASCII I | Unimplemented services. |
| | | HW_ERROR | ASCII J | Generic error. |
| | | INVALID_MODE | ASCII K | Invalid mode of operation. |
| | | NO_MESSAGES | ASCII L | No outbound messages available. |
| MSG_PENDING | ASCII M | Cannot execute command due to pending inbound messages. | | |
| SW_ERROR | ASCII N | Software error. | | |
| OUT_OF_RANGE | ASCII O | RF not in range. | | |
| PACKET_ERROR | ASCII Z | SDU data corruption. True only if confirmed delivery mode enabled. | | |

| | | ASCII P.Y, 1..9 | Reserved. |
|--------|----------|--------------------|---|
| SYNTAX | ASCII 3 | | Command SDU syntax error. Note the following error codes: |
| | INVALID | ASCII b | Invalid options. |
| | TOO_LONG | ASCII c | Data is too long. |
| VENDOR | ASCII Z | ASCII Z | Vendor-specific response. |

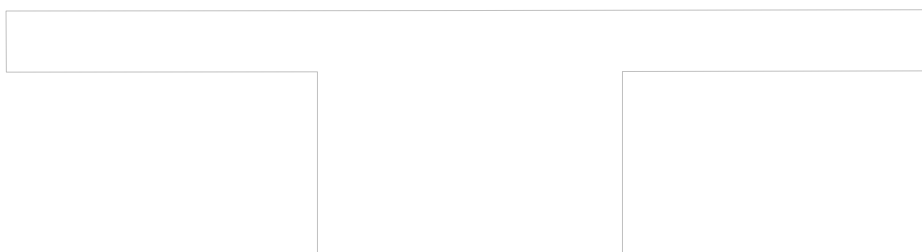
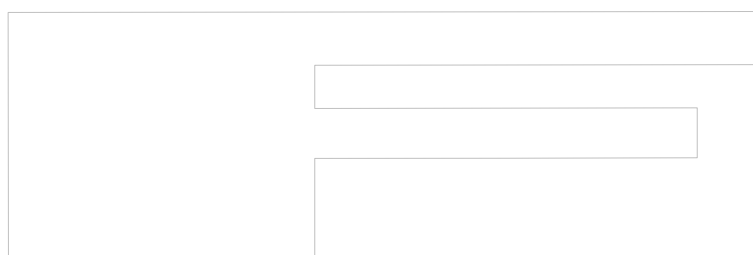
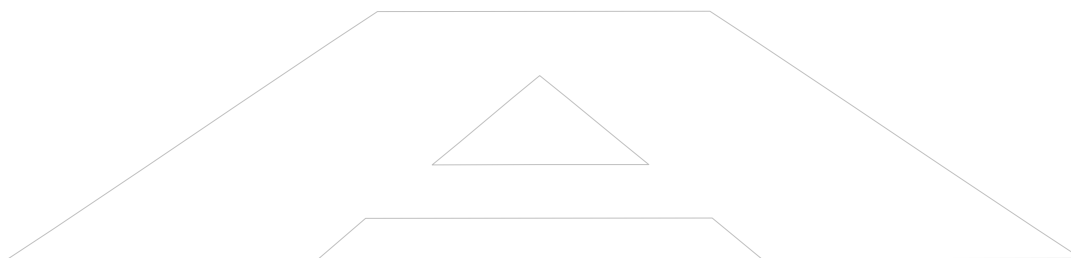
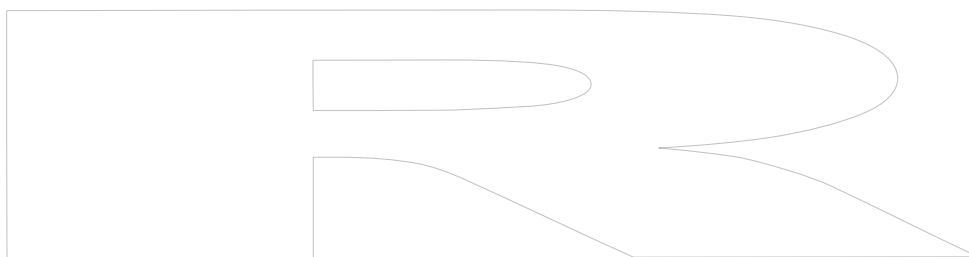

Wavenet Specific NCL Extensions

The following table describes Wavenet specific extensions to the NCL 1.2 specification. All SDUs include three VENDOR control byte and the vendor Id. (the ‘\’ character is used as an escape character for hexadecimal bytes below):

| Command Type | Command Description | Ncl String |
|--|--|---|
| 1. Get status commands | Get radio status | ZF?r |
| | Get modem battery status | ZF?v |
| | Get modem “on” time | ZF?t |
| | Get saved modem configuration settings | ZF?u |
| | Get modem serial number: | ZFts |
| 2. Generic “Set RPM configuration” command type 1. | Set modem configuration parameters, eg: * Power save mode. * Select new active profile. * NCL receive message notify timer. | ZF^[2 Byte ID][2 byte Length][Val] ZF^p\00\00\01[new mode (byte)] ZF^f\00\00\01[new profile (byte)] ZF^n\00\00\02[2-bytes time (msec)] |
| 3. Generic “Set RPM configuration” command type 2. | Set modem configuration parameters, eg: * LED disabling. | ZF5F[1 Byte ID][Val] ZF5F45\00[dis/enabled (byte)] |
| 4. Generic “Get RPM configuration” command. | Get modem configuration, eg: * Power save mode. * Get list of profiles, number of profiles and currently selected active profile. * NCL receive message notify timer. | ZF\$[2 Byte ID] ZF\$p\00 ZF\$f\00 ZF\$n\00 |

□ GET STATUS COMMANDS:

This command allows the DTE to request the current status and configuration settings of certain aspects of the modem.

FORMAT:

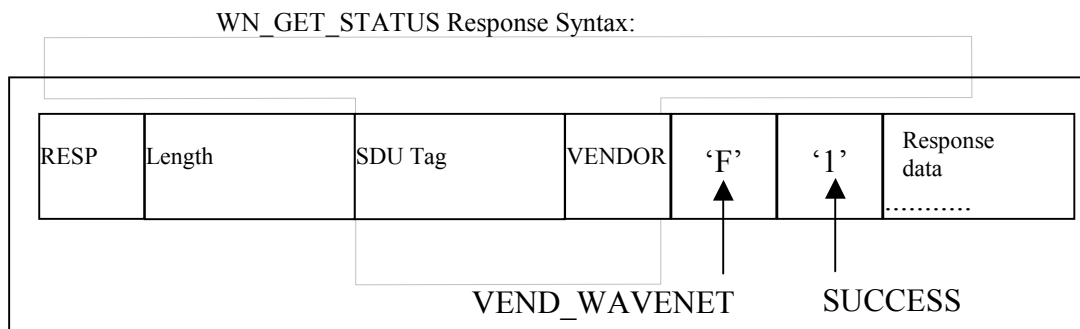
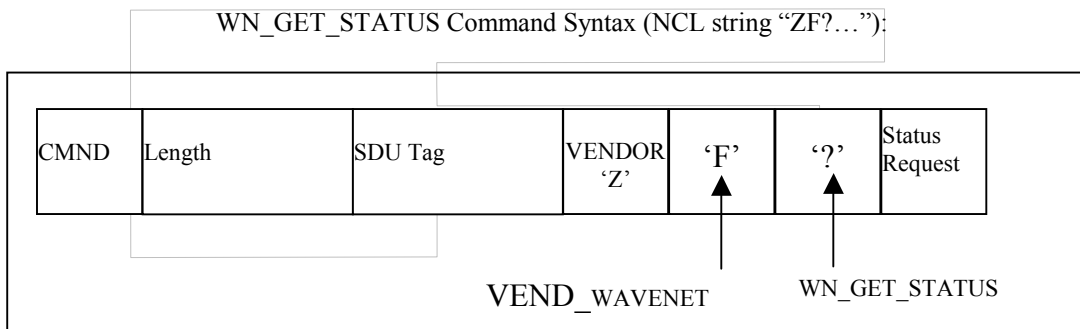

□ OPERAND DESCRIPTIONS AND RESPONSES:

The various Vendor Status Requests that can be made, and the format of their response information in the SUCCESS response SDU, are described as follows. Please note that all multiple byte fields are stored MSB first.

WN_GET_RADIO: Get radio status information (NCL string "ZF?r").

SUCCESS is followed by a block of status information as shown below:

WN_GET_RADIO Response Format:

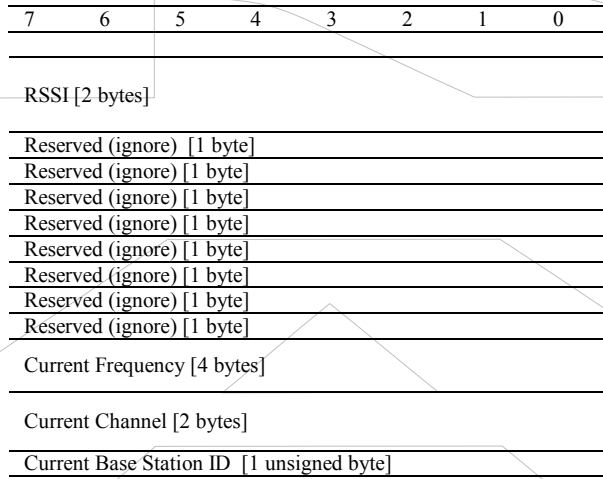

Where:

RSSI: Two byte signed integer representing the strength of the received signal from the base station measured in dBm. A typical value could be -90.

Current Frequency: Four byte unsigned integer representing the frequency of the inbound signal in Hz for the channel the modem is currently scanning or locked on to.

Current channel: Unsigned word (2 bytes) representing current channel.

Current Base Station ID: Unsigned byte representing current base station ID.

WN_GET_BATT_VOLT: Get modem battery status information (NCL string "ZF?v").

SUCCESS is followed by a block of status information in the format shown below:

WN_GET_BATT_VOLT Response Format:

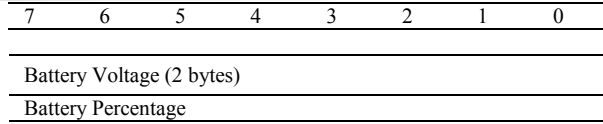

Where:

- Battery Voltage: Two byte unsigned integer representing the Voltage of the battery in mV.
- Battery Percentage: Estimate of the remaining capacity of the battery. This value ranges from 0 to 100 (unsigned byte).

WN_GET_TIME: Get modem time information (NCL string "ZF?t").

SUCCESS is followed by a block of status information in the format shown below:

WN_GET_TIME Response Format:

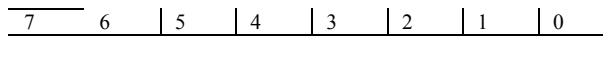

Elapsed Time [4 bytes]

Elapsed Time is a four byte unsigned integer, which represents the number of milliseconds, which have passed since the modem was last turned on or reset. It is accurate to within 50ms of when the last byte of the request message was received by the modem.

WN_GET_SETTINGS: Get configuration information (NCL string "ZF?u").

SUCCESS is followed by a block of status information in the format shown below:

WN_GET_SETTINGS Response Format:

| 7 | 6 | 5 | 4 | 3 | 2 | 1 | 0 |

| |
|---------------------------------------|
| LLI [4 bytes] |
| Serial Number [16 bytes] |
| Reserved (ignore) |
| Home System Prefix |
| Home System ID |
| Home Area ID |
| 5 Reserved bytes (ignore) |
| NCL Confirmation Mode |
| NCL Rx Control |
| NCL Tx Control |
| NCL Event Flags |
| Number of Group LLIs (n) |
| Group LLIs [4*n bytes] |
| Number of static channels (m) |
| Static channels [2*m bytes] |
| Reserved (ignore) [17 bytes] |

Where:

LLI: Four byte unsigned integer (the standard NCL command 4E also gives the LLI number back).

Serial Number: ASCII string containing the serial number of the modem. Unused bytes are zeros. The NCL command ZFTs also gives the serial number back.

NCL Confirmation Mode: Default start-up state for the confirmation mode of the NCL layer. It is a zero for unconfirmed mode, or a one for confirmed mode.

NCL Rx Control and NCL Tx Control: Indicate the start-up state for the NCL settings for RX_STATUS and TX_STATUS respectively. A zero

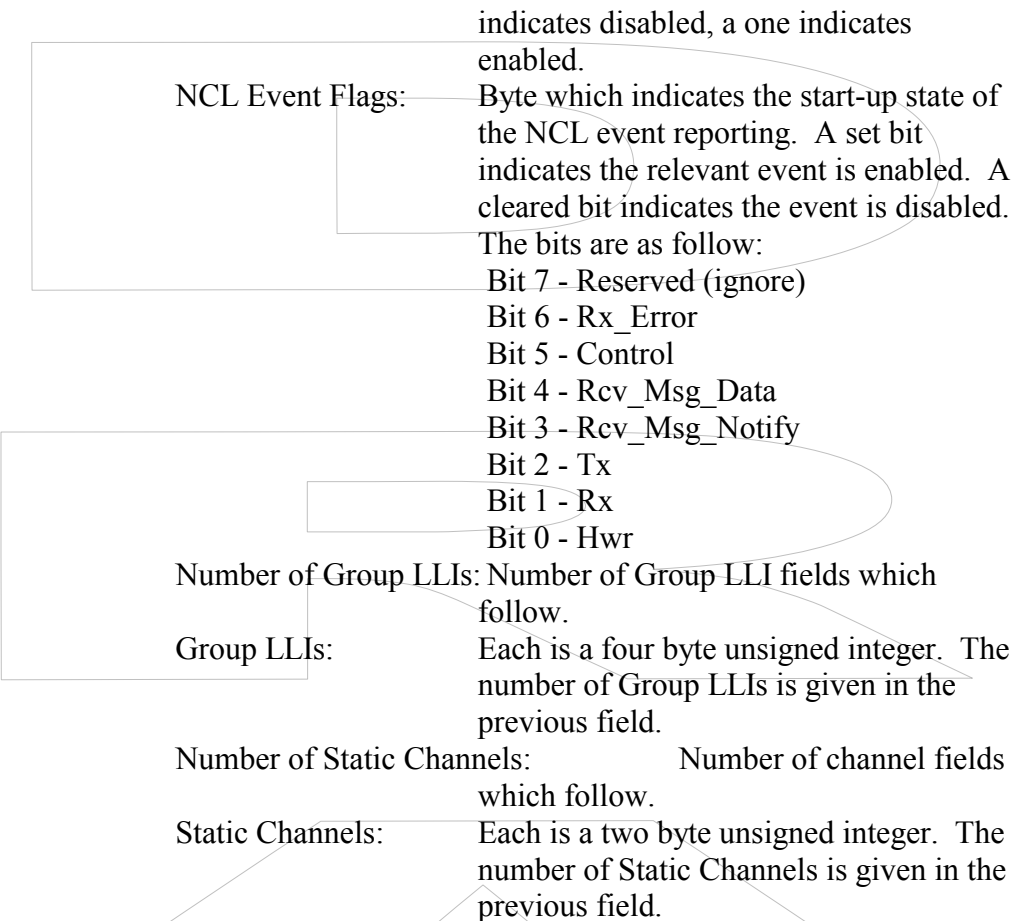

WN_GET_SERIAL: Get modem serial number (NCL string “ZFts”).

SUCCESS is followed by a block of status information in the format shown below:

WN_GET_SERIAL Response Format:

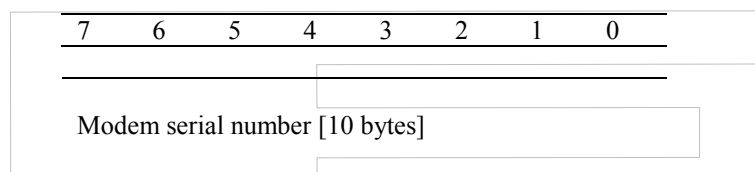

The modem serial number is unique to each modem and consists of ASCII characters. The tenth character is typically a null termination character.

□ **Generic set RPM Configuration command type 1 (WN_SET_PARAM):**

This command allows the DTE to set the configuration settings of certain aspects of the modem.

FORMAT:

WN_SET_PARAM Command Syntax (NCL string "ZF^..."):

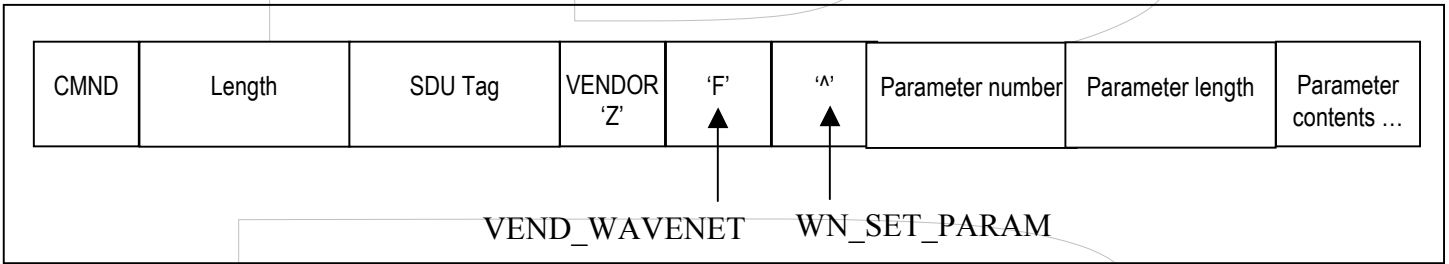

WN_SET_PARAM Response Syntax:

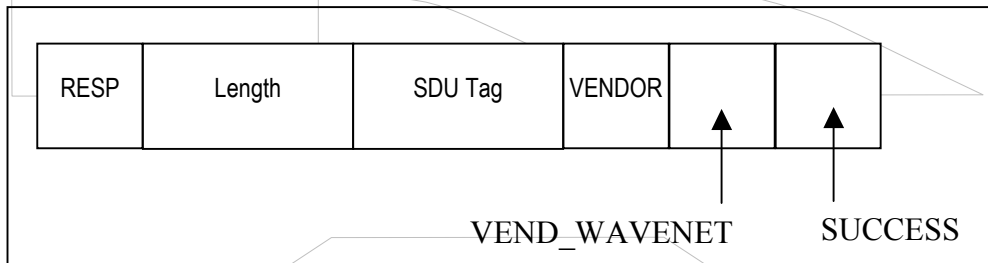

OPERAND DESCRIPTIONS AND RESPONSES:

The various Vendor Parameter settings that can be made are described as follows. Please note that all multiple byte fields are stored MSB first. Numbers prefixed with "0x" are expressed as hexadecimal. "Byte" (optionally followed by a sequence number) is used to indicate a single byte.

- Parameter Number** A 16-bit field, which is unique to each parameter, used to differentiate them.
- Parameter Length** A 16 bit field, which indicates the length of the following parameter, in bytes.
- Parameter Contents** The actual bytes set for the parameter. The format is parameter specific.

The **Parameter Name** is a label used to refer to particular parameters, and is used as a definition for the parameter number.

WN_SET_PARAM: Set Modem Configuration (NCL string "ZF^[2 byte parameter number][2 Byte parameter length][parameter block..]").

Parameter name : **WN_PWR_SAVE_MODE**
 Parameter number : 0x7000 ("Byte1Byte2") (ASCII 0x70 = 'p')

Parameter length : 0x0001 ("Byte3Byte4")
 Parameter contents : One unsigned byte ("Byte5") indicating the Power Save mode as follow:

| | |
|-------------|---|
| ASCII '0' : | EXPRESS (Disabled Power Save or "full awake" mode). |
| ASCII '1' : | MAXIMUM (4 windows). |
| ASCII '2' : | AVERAGE (8 windows). |
| ASCII '3' : | MINIMUM (16 windows). |

Parameter name: **WN_PROFILE**
 Parameter number : 0x6600 ("Byte1Byte2") (ASCII 0x66 = 'f')
 Parameter length : 0x0001 ("Byte3Byte4")
 Parameter contents: One unsigned byte with the number of the new active profile.

Parameter name: **WN_MSG_RX_NOTIF_TMR**
 Parameter number : 0x6E00 ("Byte1Byte2") (ASCII 0x6E = 'n')
 Parameter length : 0x0002 ("Byte3Byte4")
 Parameter contents: One unsigned word (2 bytes) containing the number of milliseconds between message notifications to the Palm. The maximum setting is 65 seconds (65000 milliseconds).

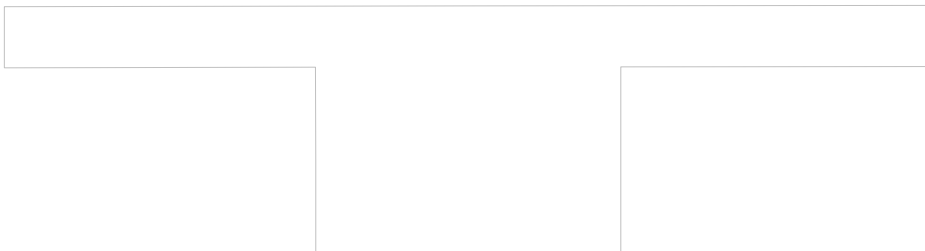
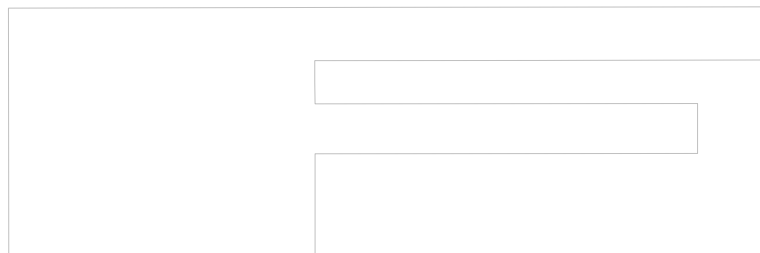

□ **Generic set RPM Configuration command type 2**

This command allows the DTE to set the configuration settings of certain aspects of the modem.

Command Format:

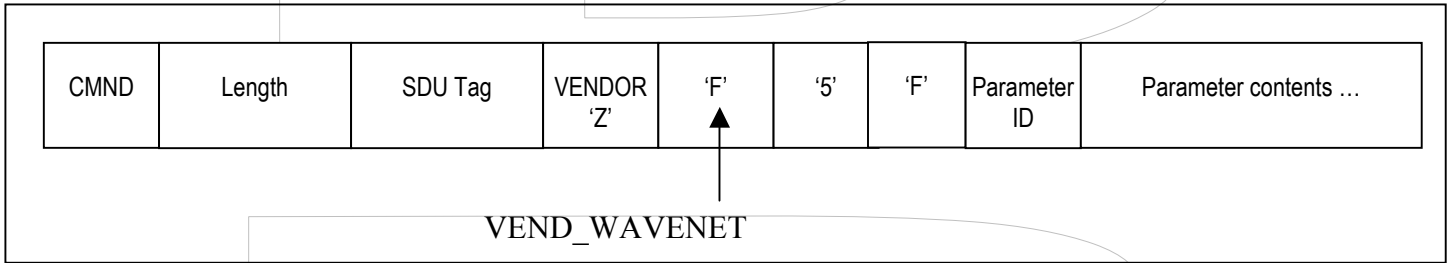

Response Syntax:

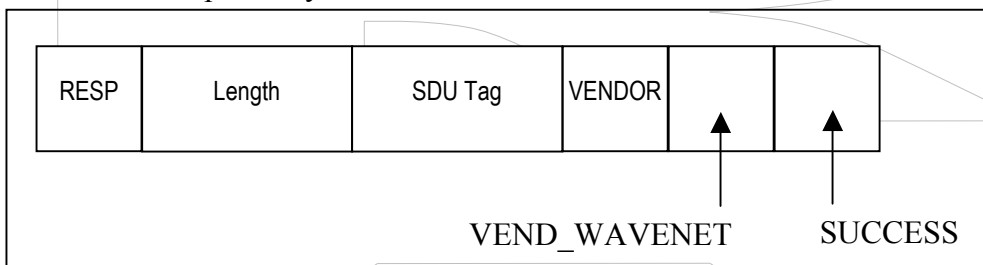

□ **OPERAND DESCRIPTIONS AND RESPONSES:**

There is currently only one such “Set configuration - type 2” command.

Parameter ID: **WN_LEDS_OFF**

Parameter contents: 16 bit (2 byte) field indicating a TRUE or FALSE condition. TRUE (0x0001) indicates the LEDs are disabled. FALSE (0x0000) indicates normal LED operation. The default is FALSE.

This command sets whether the modem’s LEDs are operational. If they are disabled with this command, then they still flash on powerup and powerdown, however they are inactive at all other times. This mode allows the modem to conserve about a milliamp of current, and is particularly suited for applications where the modem LEDs are not visible to the user.

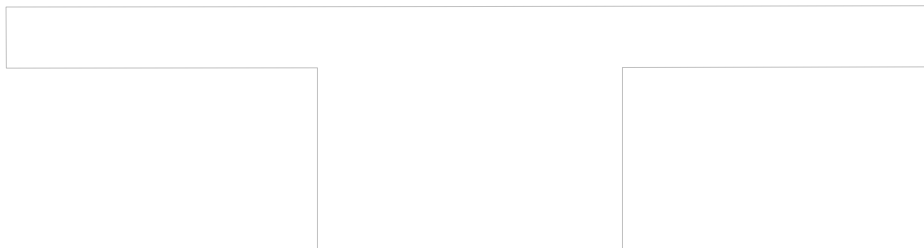

Generic get RPM Configuration command (WN_GET_PARAM):

This command allows the DTE to get the configuration settings of certain aspects of the modem. This section should be seen together with the previous section (“Generic GET RPM Configuration command”).

FORMAT:

WN_GET_PARAM Command Syntax (NCL string “ZF\$...”):

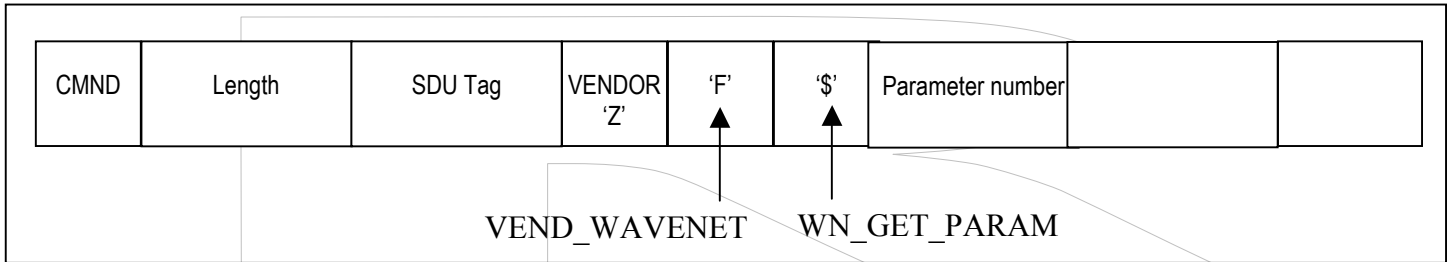

WN_GET_PARAM Response Syntax:

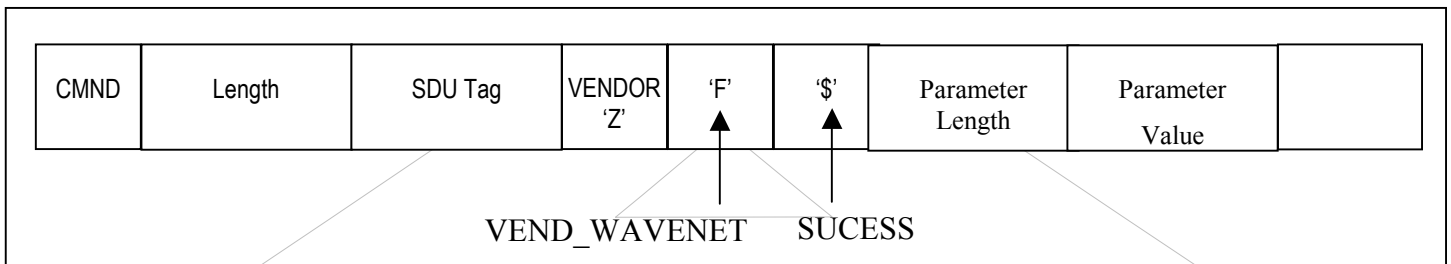

□ OPERAND DESCRIPTIONS AND RESPONSES:

The various Vendor Parameter values that can be requested are listed in the previous section (“Generic set RPM Configuration command”). The responses to these commands obey the WN_GET_PARAM response syntax as shown above. The one exception is the “Get Active Profile” command, which returns more than just the “active profile”:

Parameter Number A 16-bit field, which is unique to each parameter, used to differentiate them.

Parameter Length A 16 bit field, which indicates the length of the following parameter, in bytes.

Parameter Value The actual value of the parameter. The format is parameter specific.

WN_PROFILE Get list of profiles from modem (NCL string “ZF\$f00” with “\00” representing one byte with value of zero).

SUCCESS is followed by a block of information in the format shown below:

WN_GET_PROFILE_LIST Response Format:

| |
|---|
| Number of profiles (n) [1 byte] |
| Active profile number [1 byte] |
| Profile Name 1 (up to 24 byte null terminated string) |
| Profile Name 2 (up to 24 byte null terminated string) |
| . |
| . |
| . |
| Profile Name n (null terminated string) [24 bytes] |

Where:

Number of profiles: Unsigned byte giving the current number of profiles in configuration sector. The number of profiles may change.

Active profile number: Unsigned byte giving the number (or index) of the currently active profile.

Profile name: Null terminated string of 24 bytes of length (the string may be shorter than the 24 bytes as long as it is followed immediately by the null termination character). The 24 bytes do not include the null termination character.

□ NCL Label Values

Please note the following additions/clarifications to the NCL Label Values Table:

| | | |
|---------------------|------------|------------------------------------|
| CMND | ASCII 'A' | |
| RESP | ASCII 'C' | |
| SUCCESS | ASCII 'I' | |
| VENDOR | ASCII 'Z' | |
| VEND_MOTOROLA | ASCII '0' | |
| VEND_WAVENET | ASCII 'F' | |
| WN_GET_STATUS | ASCII '?' | |
| WN_GET_RADIO | ASCII 'r' | (eg NCL command ZF?r) |
| WN_GET_BATT_VOLT | ASCII 'v' | (eg NCL command ZF?v) |
| WN_GET_TIME | ASCII 't' | (eg NCL command ZF?t) |
| WN_GET_SETTINGS | ASCII 'u' | (eg NCL command ZF?u) |
| WN_GET_SERIAL | ASCII 's' | (eg NCL command ZF?s) |
| WN_SET_PARAM | ASCII '^' | (eg NCL cmd ZF^\04\00\00\01\09) |
| WN_GET_PARAM | ASCII '\$' | (eg NCL commands ZF\$..) |
| WN_PWR_SAVE_MODE | 0x7000 | (eg NCL cmd ZF\$\70\00 = ZF\$p\00) |
| WN_PROFILE | 0x6600 | (eg NCL cmd ZF\$\66\00 = ZF\$f\00) |
| WN_MSG_RX_NOTIF_TMR | 0x6E00 | (eg NCL cmd ZF\$\6E\00 = ZF\$n\00) |
| WN_CMD | ASCII '*' | (eg NCL commands ZF*..) |
| WN_LEDS_OFF | 0x45 | (eg NCL cmd ZF5F\45\00\00) |

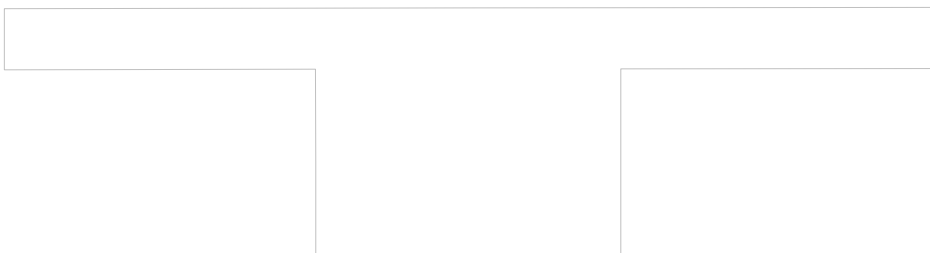
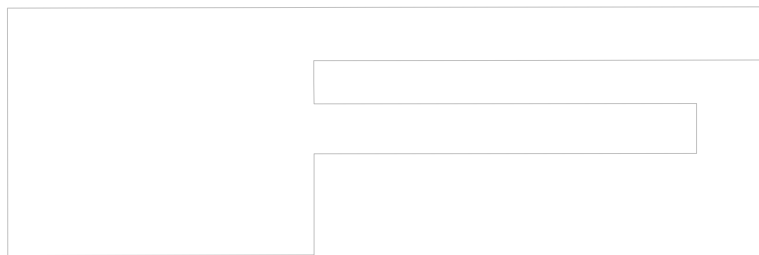
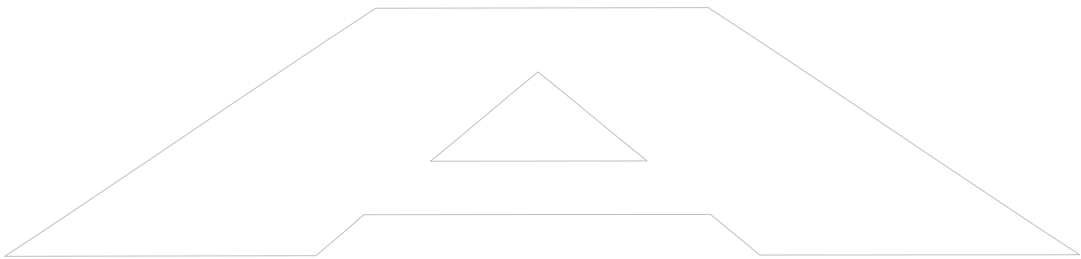
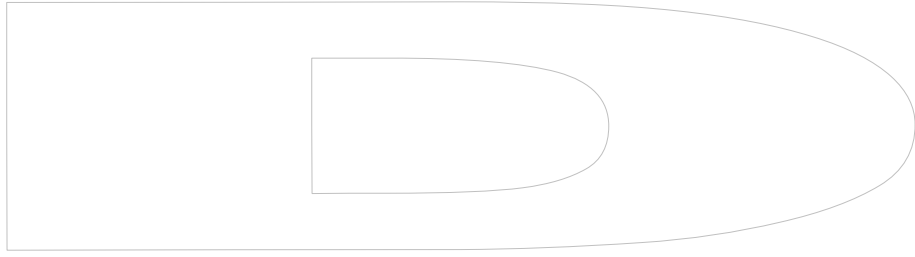

Appendix B – SDK NCL-API and Port Server

The Native Control Language Application Programmer's Interface (NCL API) is the client component of the SDK. The NCL API provides routines for sending and receiving data messages through the DataTAC wireless network, using a radio packet modem (RPM). It also allows the client application to control configuration parameters of the RPM and to retrieve status information from the RPM.

Implementation

The NCL API is implemented as a DLL library of written in C++ for windows using Microsoft Visual C++ Version 6.0.

The NCL API communicates with PC or Pocket PC applications based on the following model. The NCL API is supplied as a Virtual Device Driver (VDD) for a PC (Win 98 or better) or a Pocket PC (Win CE Version 3.0 or better). Multiple applications can access the RPM via NCL encoded messages.

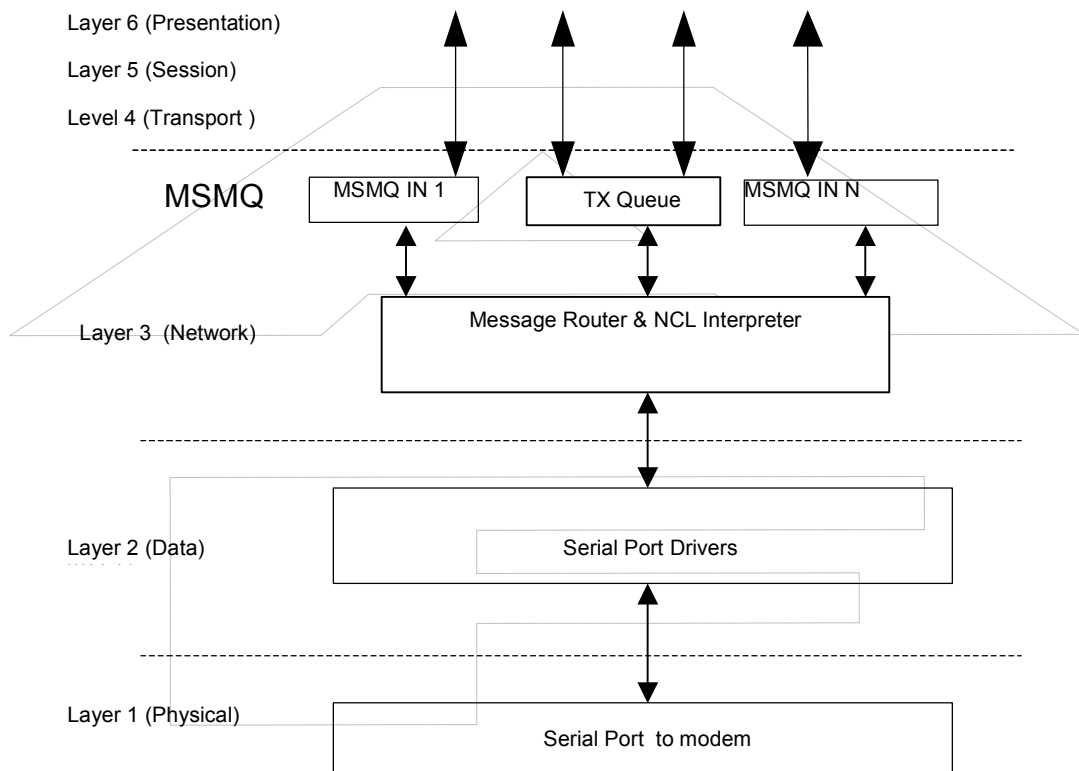

Wavenet NCL API Model

Logical Architecture

The following table lists the required functionality for the API per layer. The code forms a DLL, with only a subset of functions available for third party developers.

| LAYER NAME | CONTENT | FUNCTION |
|----------------------------------|--|--|
| 7. APPLICATION | Application specific data. | Applications are to initialise a RX MSMQ (Microsoft Message Queuing system) queue and open a session with the VDD by passing the RX queue handler. |
| 6. PRESENTATION LAYER | Unused | |
| 5. SESSION LAYER | Unused | |
| 4. TRANSPORT LAYER | Unused | |
| 3. NETWORK LAYER | Router | MSMQ is run as a device driver on the Pocket PC and is run from power up (i.e. Non-suspend mode). The VDD will post events (RCV messages etc) to all application RX queues enabled for that event. Responses to application requests will be posted to the calling application RX queue. The VDD process TX requests via a FIFO queue to the NCL Interpreter. The Host base routing or Peer-to-Peer routing SDU formatting is contained in the NCL interpreter. |
| 2. DATA LINK LAYER | NCL Interpreter & Extender port – Serial Driver. | Application NCL API function requests are processed via a FIFO queue. RPM responses or received data is tagged and encoded for the router as required Also the UART DLL that handles the extender port UART to modem communications resides in the link layer modules.. |
| 1. PHYSICAL / BIT TRANSFER LAYER | Extender Port to RPM. | 9600, 8, 1, N on serial port and a wakeup line. |

Wavenet's current NCL API protocol stack is implemented with the hierarchical structure. All DLLs including MSMQ files are included in the install cabinet files for the VDD.

Message Router

The PC or PPC loads MSMQ as a device driver. Applications using the modem must open a session with VDD by calling 'VDDOpen()' which will create a private Receive MSMQ queue for the instance of the application (client). The name of this private queue will be sent to the serial port server (VDD) along with an open session request. The port server will in turn create a private MSMQ queue to receive data from the client. All Modem Events and response messages to be communicated between the VDD and the application will be via the receive queues. Transmit function requests from the applications (clients) are queued by the VDD and are processed as a FIFO buffer by the NCL interpreter. On Wakeup the VDD will be activated, if any applications receive queues are open the RX event will be posted to those queues. If no receive queues are active, the VDD will buffer the RX events and start up the registered on_wakeup applications. After the applications have successfully opened a VDD session the VDD will pass the RX events to those applications.

NCL Interpreter

The NCL Interpreter strips NCL API function calls from application messages, queue the calls and execute the calls on a FIFO basis. Received messages will be queued and matched against an appropriate

request (if not an event), and passed to the router with the corresponding tags.

Link Layer

The RPM communicates with a PC via a standard communications port and a user supplied RS232 to CMOS level device. For the Pocket PC (PPC) the RPM communicates via the PPC extender port UART. The PPC performs an auto detect and wakeup when an attached modem receives some data and the PPC is in suspend mode.

Application Interface

□ Opening a Session

Applications are required to first open a session with the VDD by calling the API function 'VDDOpen()'. All other API functions will return an error unless an open session with the VDD was established. If successful this operation will result in the creation of two MSMQ queues for use by the client. One MSMQ will be used to send messages from the VDD to the client and the other for messages from the client to the VDD. Note that the client does not deal with MSMQ queues directly because all operations are wrapped in API calls.

Prototype:

```
int VDDOpen(void)
```

Description:

Opens a session with the VDD.

Input:

| | |
|---|------|
| ➤ | none |
|---|------|

Output:

| | | |
|---|------------------|--|
| < | Return value = 0 | Operation was successful |
| < | Return value ≠ 0 | Operation failed. Value specifies the error type |

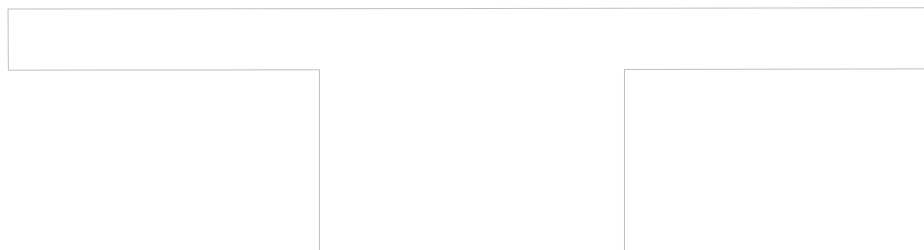

□ **Close Session**

Applications can call this function to close its session with the VDD. An application should call this function before it terminates if a session was earlier established with the VDD. The reason for this is to ensure that all created MSMQ queues for the client are deleted. This will prevent irrelevant/outdated messages from being posted to inactive MSMQ queues.

Prototype:

```
int VDDClose(void);
```

Description:

Close a session with the VDD.

Input:

| | | |
|---|------|--|
| ➤ | None | |
|---|------|--|

Output:

| | | |
|---|------------------|--|
| ◀ | Return value = 0 | Operation was successful |
| ◀ | Return value ≠ 0 | Operation failed. Value specifies the error type |

□ **Send Data to a Radio Host**

Applications can call this function to send data to a radio host. The Host ID will automatically be inserted into the data header of the SDU for message routing purposes.

Prototype:

```
int nclSendData(word *usSduTag, byte *szHostId, byte ucIdLen, byte *ucData, int iDatLen, bool bResend);
```

Response:

The VDD will track the response with the Host ID and SDU tag will post the response to the corresponding RX queue for that session. The application is responsible for reading and processing the response on the RX queue. By calling 'nclReceiveData()'.

Description:

Send application data to the radio host identified by the host ID.

Input:

| | | |
|---|----------|---|
| ➤ | usSduTag | Pointer to a word where the SDU tag can be stored |
| ➤ | szHostId | Pointer to a buffer specifying the Host identity. The Host ID is typically 3 bytes in length for DataTac systems. The NCL API will truncate Host ID's longer than NCL_MAX_UH_LEN (63) bytes in length. |
| ➤ | ucIdLen | Total length of the session ID |
| ➤ | ucData | Pointer to the data to be sent |
| ➤ | iDatLen | Length of the data to be sent |
| ➤ | bResend | Resend flag must be set to false, except if the packet of data is being re-sent due to a failure of the previous send. Setting the flag to true prevents the possibility of receiving duplicate packets at the server application. This flag cannot be used for resending data prior to the previous packet. |

Output:

| | | |
|---|------------------|---|
| < | Return value = 0 | Operation was successful |
| < | Return value ≠ 0 | Operation failed. Value specifies the error type |
| < | usSduTag | Pointer to a word containing a reference of the corresponding SDU tag which was generated by the NCL API for this command to the RPM. |

□ Receive Data From RPM

Applications can call this function to obtain data sent from the RPM. This applies to both event and response type data from the RPM. Note this is the only way to obtain response data originating from the RPM as a result of issuing commands to it by means of other API functions described in this document. The return code of all API functions issuing commands to the modem only provides feedback about the posted command. It does not guarantee delivery to the RPM. It is thus imperative for applications to use 'nclReceiveData()' to obtain feedback directly from the RPM on commands sent to it. Responses to commands are asynchronous meaning multiple commands can be issued to the RPM before the application needs to look at all the responses. This is the reason why every command provides the application with a copy of the unique SDU tag generated for the command. Every response message contains the same SDU tag of its associated command. The VDD uses the SDU tag to route response messages to the originating application (client). The 'nclReceiveData()' function provides the SDU tag of the response message. Applications can use these tags to tie up responses with previously sent commands. One notable exception exist when the SDU tag is equal to 65535 (FFFF hexadecimal). Only event messages contain an SDU tag equal to 65535. The received event/ response messages will be represented as an array of bytes which must be typed cast to a structure identified by returned structure ID.

The RCV_MSG_NOTIFICATION event will be handled by the VDD, which will read the messages from the RPM and pass the messages to all clients with open sessions.

Other Event types shall be posted to all clients with open sessions registered for that event. If no applications are registered for that event the event will be disabled in the modem.

Prototype:

```
int nclReceiveData(DWORD dwTimeOut, BYTE *ucStructId, WORD *usSduTag, int *iBufLen, BYTE *ucBuf);
```

Description:

Receive messages from the RPM.

Input:

| | |
|--------------|---|
| ➤ dwTimeOut | The time (in milliseconds) to wait for the next message. Use 0 to return immediately or FFFFFFFF (hexadecimal) to hang on indefinitely for a message. The calling thread will be suspended until a message arrive or the time-out period has elapsed, whichever occurs first. |
| ➤ ucStructId | Pointer to a byte where the structure ID can be stored. |
| ➤ usSduTag | Pointer to a word where the SDU tag can be stored |
| ➤ iBufLen | Pointer to a integer specifying the total size of ucBuf. |
| ➤ ucBuf | Pointer to the buffer (of size iBufLen) where receive data can be placed |

Output:

| | |
|--------------------|---|
| ⏪ Return value = 0 | Operation was successful |
| ⏪ Return value ≠ 0 | Operation failed. Value specifies the error type |
| ⏪ ucStructId | This value identifies the structure of the data in ucBuf. See the following paragraphs for details. |
| ⏪ usSduTag | Pointer to a word containing a reference of the corresponding SDU tag which was generated by the NCL API for this command to the RPM. |
| ⏪ iBufLen | Size (in bytes) of the data in ucBuf. Note: Buffer lengths of 0 is possible – rely solely on the return value in such cases |
| ⏪ ucBuf | Pointer to buffer containing the received data |

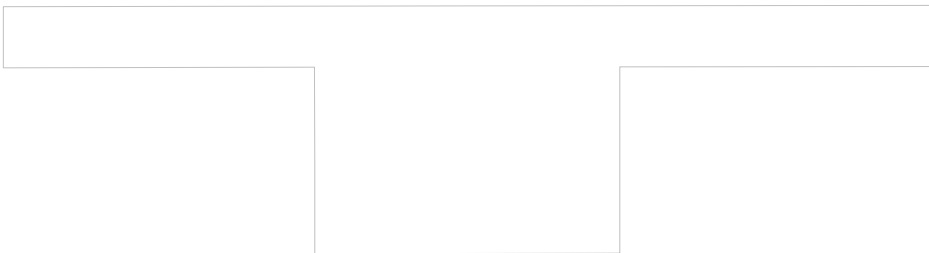

```

/** Define types for retrieving data from the RPM */

typedef unsigned char    BYTE;
typedef unsigned short  WORD;

/*Parameter Structure IDs - Do not alter sequence*/
enum
{
    NCLNone_ID = 0,
    NCLEvent_ID,
    NCLProdId_ID,
    NCLVersion_ID,
    NCLRpmId_ID,
    NCLConfigBlock_ID,
    NCLStatusBlock_ID,
    NCLChanBlock_ID,
    NCLGroupLis_ID,
    NCLChannelTable_ID,
    NCLWaveSettings_ID,
    NCLWaveRadio_ID,
    NCLWaveGen_ID,
    NCLByte_ID,
    NCLByte2_ID,
    NCLWord_ID,
    NCLMsg_ID,
    NCLRaw_ID
    /*additional structure IDs to be added here including vendor specific types */
};

/* Use 1 byte alignment for the following structures */
#pragma pack(1)

/* Product ID structure */
typedef struct NCLProdId
{
    BYTE hw_platform;
    BYTE rf_protocol;
    BYTE ncl_compliance;
    BYTE release_level;
}NCLProdId;

/* NCL version structure */
typedef struct NCLVersion
{
    char    major[2];
    char    minor[2];
}NCLVersion;

/* RPM ID structure */
typedef struct NCLRpmId
{
    BYTE    b_val[4];
}NCLRpmId;

/* Config block structure */
typedef struct NCLConfigBlock
{

```

```

NCLProdId      prod_id;
NCLVersion     sw_version;
NCLRpmId      rpm_id;
WORD           reserved;
WORD           max_data_size;
}NCLConfigBlock;

/* Status block structure */
typedef struct NCLStatusBlock
{
    BYTE        rx_status;
    BYTE        tx_status;
    BYTE        antenna;
    BYTE        radio_in_range;
    BYTE        flow_control;
    BYTE        rcv_mode;
    BYTE        event_states;
    WORD        ob_msg_count;
    WORD        ib_msg_count;
    WORD        radio_channel;
}NCLStatusBlock;

/* Channel block structure */
typedef struct NCLChanBlock
{
    BYTE        radio_in_range;
    WORD        radio_channel;
    BYTE        attribute;
    BYTE        protocol;
    BYTE        rssi;
}NCLChanBlock;

#define MAX_GROUP_LLIS      8
#define LLI_BYTE_WIDTH    8
#define NCL_NUM_CHANNELS  64

/* Group LLIs array */
typedef struct NCLGroupLlis
{
    BYTE lli[MAX_GROUP_LLIS][LLI_BYTE_WIDTH];
    BYTE num;
}NCLGroupLlis;

/* Channel Table */
typedef struct NCLChannelTable
{
    WORD        channel[NCL_NUM_CHANNELS];
    BYTE        num;
}NCLChannelTable;

/* Vendor Specific: Wavenet Get Settings*/
typedef struct NCLWaveSettings {
    BYTE        LLI[4];
    BYTE        SerNum[16];
} NCLWaveSettings;

/* Vendor Specific: Wavenet Get Radio Settings*/

```

```

typedef struct NCLWaveRadio {
    BYTE    rssi[2];
    BYTE    reserved1;
    BYTE    reserved2;
    BYTE    reserved3;
    BYTE    reserved4;
    BYTE    reserved5;
    BYTE    reserved6;
    BYTE    reserved7;
    BYTE    reserved8;
    BYTE    frequency[4];
    BYTE    channel[2];
    BYTE    base_id;
} NCLWaveRadio;

/* Vendor Specific: Wavenet Generic*/
typedef struct NCLWaveGen {
    BYTE    byte[100];
} NCLWaveGen;

/* NCL status information structure */
typedef union NCLStatus
{
    NCLProdId    prod_id;
    BYTE    vendor_id;
    NCLVersion    sw_version;
    NCLRpmlId    rpm_id;
    BYTE    rpm_vid[2];
    NCLGroupLlis    rpm_gid;
    WORD    max_data_size;
    BYTE    rx_status;
    BYTE    tx_status;
    BYTE    antenna;
    BYTE    radio_in_range;
    WORD    ob_msg_count;
    WORD    ib_msg_count;
    BYTE    flow_control;
    BYTE    rcv_mode;
    BYTE    event_states;
    WORD    radio_channel;
    NCLChannelTable    chan_table;
    NCLChannelTable    dchan_table;
    NCLConfigBlock    config_block;
    NCLStatusBlock    status_block;
    NCLChanBlock    chan_block;
    BYTE    bat_level;
    NCLWaveSettings    wave_set;
    NCLWaveRadio    wave_radio;
    NCLWaveGen    wave_generic;
}NCLStatus;

/* Event Type */
typedef struct NCLEventType
{
    BYTE    etype;
    /* NCL_RCV_MSG_DATA    'A'    Received message data    */
    /* NCL_MSG_NOTIFICATION    'B'    Received Message notification    */
    /* NCL_TX_EVENT    'C'    Transmitter event    */
    /* NCL_RX_EVENT    'D'    Receiver event    */
    /* NCL_HW_EVENT    'E'    Hardware event    */
}

```



```

        /* NCL_RCV_ERR_EVENT      'F'      Unreceivable Message Event      */
        /* NCL_CONTROL_EVENT     'G'      Control Event                      */
    BYTE EventCode;
        /* NCL_MSG_NOTIFICATION_LEN N- Number of buffered msgs to be read */
        /* NCL_TX_EVENT_KEYED     '1'      Transmitter keyed                */
        /* NCL_TX_EVENT_DEKEYED   '2'      Transmitter dekeyed              */
        /* NCL_RX_EVENT_INRANGE   '1'      RF in range                        */
        /* NCL_RX_EVENT_OUTRANGE  '2'      RF out of range                    */
        /* NCL_RX_EVENT_PSENAB    '3'      Power Save enabled                */
        /* NCL_RX_EVENT_PSDISAB   '4'      Power Save disabled               */
        /* NCL_HW_EVENT_STEST     '1'      Self Test Failed                  */
        /* NCL_HW_EVENT_LBATT     '2'      Low battery                       */
        /* NCL_HW_EVENT_MFULL     '3'      Memory Full                        */
        /* NCL_HW_EVENT_BATOK     '4'      Battery Level OK                  */
        /* NCL_HW_EVENT_MEMOK     '5'      Memory Ok                          */
        /* NCL_HW_EVENT_MEMOK     '6'      Device shutdown is imminent      */
        /* NCL_RCV_ERR_EVENT_RTD  '1'      ACK required PDU received but TX
disabled */
        /* NCL_CONTROL_EVENT_C    '1'      RPM / DTE connected                */
}NCLEventType;

```

```

/* RCV_MSG_Data */
#define NCL_MAX_DATA_SIZE      2048
#define NCL_MAX_UH_LEN        63 /* max length of user header */

typedef struct NCLMsg
{
    BYTE    is_message; /* If FALSE, only len and buf components are valid. */
    BYTE    sessionID[NCL_MAX_UH_LEN + 1]; /* NULL terminated */
    BYTE    msg_type; /* Used by NCL_DATATAC_5000 networks */
    WORD    len;
    BYTE    buf[NCL_MAX_DATA_SIZE];
} NCLMsg;

/* End of 1 byte alignment */
#pragma pack()

```

□ **Get RPM Status Information**

The application can call this function to obtain status information about the RPM. The following types of status information can be obtained:

| Status Request (non vendor specific) | Response Structure | Description |
|--------------------------------------|-------------------------|-----------------------------|
| NCL_R_CONFIG_BLOCK | NCLConfigBlock | Get RPM configuration block |
| NCL_R_STATUS_BLOCK | NCLStatusBlock | Get RPM status block |
| NCL_R_PROD_ID | NCLProdId | Get RPM product ID |
| NCL_R_SW_VERSION | NCLVersion | Get software version number |
| NCL_R_RPM_ID | NCLRpmId | Get RPM address |
| NCL_R_RPM_VID | NCLStatus.rpm_vid[2] | Get RPM VID address (MDC) |
| NCL_R_MAX_DATA_SIZE | NCLStatus.max_data_size | Get SDU data limit |
| NCL_R_RCV_MODE | NCLStatus.rcv_mode | Get mode of notification to |

| Status Request (non vendor specific) | Response Structure | Description |
|--------------------------------------|---|--|
| | | DTE for received SDUs. |
| NCL_R_RX_STATUS | NCLStatus.rx_status | Get receiver enable status |
| NCL_R_TX_STATUS | NCLStatus.tx_status | Get transmitter enable status |
| NCL_R_ANTENNA | NCLStatus.antenna | Get antenna selection status |
| NCL_R_RADIO_IN_RANGE | NCLStatus.radio_in_range | Get radio in range status |
| NCL_R_OB_MSG_COUNT | NCLStatus.ob_msg_count | Get count of outbound messages queued |
| NCL_R_IB_MSG_COUNT | NCLStatus.ib_msg_count | Get count of inbound |
| NCL_R_FLOW_CONTROL | NCLStatus.flow_control | Get flow control status |
| NCL_R_EVENT_STATES | NCLStatus.event_states | Get current event reporting (enable/disable) state |
| NCL_R_RADIO_CHANNEL | NCLStatus.radio_channel | Get current radio channel |
| NCL_R_CHAN_TABLE | NCLChannelTable | Read radio channel table |
| NCL_R_CHAN_BLOCK | NCLChanBlock | Read the channel block |
| NCL_R_BAT_LEVEL | NCLStatus.bat_level | Read the battery level |
| NCL_R_RPM_GID | NCLGroupLlis | Get RPM group IDs |
| NCL_R_VENDOR_ID | NCLStatus.vendor_id | Get vendor identification |
| NCL_R_DCHAN_TABLE | NCLChannelTable | Read the D-channel table |
| NCL_R_RF_STATISTICS | Specific to RF protocol used: RD-LAP [F] or MDC [G] | Read the RF statistics |

| Status Request (Wavenet Technology specific) | Response Structure | Description |
|--|--------------------|------------------------------|
| WN_GET_STATUS_RADIO | NCLWaveRadio | Get RPM Radio Status |
| WN_GET_STATUS_BATTERY | NCLWaveGen | Get RPM Battery Status |
| WN_GET_STATUS_ONTIME | NCLWaveGen | Get RPM on-time status |
| WN_GET_STATUS_CONFIG | NCLWaveGen | Get RPM configuration status |

Prototype:

```
int nclGetStatus (word *usSduTag, byte ucVendor, byte ucType, byte ucRequest);
```

Description:

Command the RPM to send the requested status information.

Input:

| | |
|------------|--|
| ➤ usSduTag | Pointer to a word where the SDU tag can be stored |
| ➤ ucVendor | Vendor identifier. Use: NCL_NO_VEND = 0 if not vendor specific or NCL_VEND_WAVENET = 'F' for Wavenet Technology specific |

| | |
|-------------|---|
| | requests |
| ➤ ucType | The type of status information to retrieve from the RPM (Used by Vendor specific requests). Set to zero for non-vendor requests or WN_GET_STATUS = '?' for Wavenet Technology specific requests |
| ➤ ucRequest | The requested status information, as listed in one of the appropriate tables above, to retrieve from the RPM. |

Output:

| | |
|--------------------|---|
| ← Return value = 0 | Operation was successful |
| ← Return value ≠ 0 | Operation failed. Value specifies the error type |
| ← usSduTag | Pointer to a word containing a reference of the corresponding SDU tag which was generated by the NCL API for this command to the RPM. |

The response is posted to the corresponding RX queue associated with the VDD session ID. If the session ID is not recognized all active RX queues will be posted the response.

❑ Set Configuration ITEMS Within the RPM

By default the modem will have the receiver and transmitter enabled and the RX notification event enabled. Modem Configuration items via NCL are TBA and will be restricted to service personnel.

❑ Reset RPM

The application can call this function to reset the RPM. There are several different levels of RPM reset commands that may be issued to the RPM, as listed below:

| Reset Level | Description |
|--------------------|--|
| NCL_RESET_INBOUND | Flush the Inbound queue |
| NCL_RESET_OUTBOUND | Flush the Outbound queue |
| NCL_RESET_BOTH | Flush both the Inbound and Outbound queues |
| NCL_RESET_WARM | Warm start: flush queues, default Native settings, remain in Native mode |
| NCL_RESET_TRANS | Not Supported |
| NCL_RESET_FULL | Full reset: Power-on reset |
| NCL_RESET_NCL | Reset NCL interpreter |
| NCL_RESET_OFF | Power off the RPM |

Prototype:

```
int nclResetRPM (word *usSduTag, byte ucResetLevel);
```

Description:

Command the RPM to perform a specified level reset

Input:

| | | |
|---|--------------|---|
| ➤ | usSduTag | Pointer to a word where the SDU tag can be stored |
| ➤ | ucResetLevel | The level of the Reset as listed in the above table |

Output:

| | | |
|---|------------------|---|
| ← | Return value = 0 | Operation was successful |
| ← | Return value ≠ 0 | Operation failed. Value specifies the error type |
| ← | usSduTag | Pointer to a word containing a reference of the corresponding SDU tag which was generated by the NCL API for this command to the RPM. |

The response is posted to the corresponding RX queue associated with the VDD session ID. If the session ID is not recognized all active RX queues will be posted the response.

❑ **Register Event Callback Function**

Since the RX events will be posted to private Receive MSMQ queues the VDD is not required to support callback functions. Applications can call the API function 'nclReceiveData()', to wait on response and event messages from the RPM on their on account. The API function 'nclReceiveData()' will return within the time-out period specified, so applications will not be hung-up indefinitely.

❑ **Enable / Disable Events**

The application can call this function to enable or disable individual event types being reported by the RPM. By default, only the Receive Message Data event is enabled (NCL_RCV_MSG_DATA). All other event types for an application are disabled unless they have been specifically enabled / disabled using this function. The NCL_RCV_MSG_NOTIF event is handled by the VDD, which will post the received messages to all active RX queues (that have NCL_RCV_MSG_DATA enabled) using the NCLRXDataID structure type.

Prototype:

```
int nclSetEvent (word *usSduTag, byte ucType, byte ucSetting);
```

Description:

Enable / Disable event reporting by the RPM for the specified event type.

Input:

| | | |
|---|------------|--|
| ➤ | iSessionID | VDD session ID |
| ➤ | usSduTag | Pointer to a word where the SDU tag can be stored |
| ➤ | ucType | The type of event to enable/disable: NCL_RCV_MSG_DATA (Received message data) NCL_TX_EVENT (Physical-level transmitter event) NCL_RX_EVENT (Physical-level receiver event) NCL_HW_EVENT (Hardware event) NCL_RCV_ERR (Un-receivable message event) NCL_CONTROL (Control event) NCL_VEND_EVENT (Vendor specific event) |
| ➤ | ucSetting | NCL_DISABLE (Disable event reporting) NCL_ENABLE (Enable event reporting) |

Output:

| | | |
|---|------------------|---|
| ← | Return value = 0 | Operation was successful |
| ← | Return value ≠ 0 | Operation failed. Value specifies the error type |
| ← | usSduTag | Pointer to a word containing a reference of the corresponding SDU tag which was generated by the NCL API for this command to the RPM. |

□ **Get Error Description**

The application can call this function to obtain a string representation for a specified error code.

| Error Code | Value | Description |
|---------------------------|-------|--|
| NCL_ERR_NONE | 0 | No error has occurred |
| NCL_ERR_SESSION_IS_CLOSED | -1 | NCL API: Session has not been opened |
| NCL_ERR_SESSION_IS_OPEN | -2 | NCL API: Session is already open |
| NCL_ERR_ENCODE | -3 | NCL API: NCL Frame encoding error |
| NCL_ERR_DECODE | -4 | NCL API: NCL Frame decoding error |
| NCL_ERR_PARAM | -5 | NCL API: Invalid parameter passed |
| NCL_ERR_TIMEOUT | -6 | NCL API: Time-out elapsed waiting for response |
| NCL_ERR_MSMQ_OPEN | -7 | NCL API: An error occurred opening a MSMQ |
| NCL_ERR_MSMQ_CLOSE | -8 | NCL API: An error occurred closing a MSMQ |
| NCL_ERR_MSMQ_SEND | -9 | NCL API: An error occurred sending a MSMQ |
| NCL_ERR_MSMQ_RECEIVE | -10 | NCL API: An error occurred receiving a MSMQ |
| NCL_ERR_MSMQ_CREATE | -11 | NCL API: An error occurred creating a MSMQ |
| NCL_ERR_MSMQ_DELETE | -12 | NCL API: An error occurred deleting a MSMQ |
| NCL_ERR_MSMQ_NAME | -13 | NCL API: An error occurred searching for a MSMQ |
| NCL_ERR_MAX_CLIENTS | -14 | NCL API: Maximum number of supported clients reached |

| Error Code | Value | Description |
|------------------------|------------------|--|
| NCL_ERR_INVALID | 'b' | NCL Syntax error: Invalid options |
| NCL_ERR_TOO_LONG | 'c' | NCL Syntax error: Data too long |
| NCL_ERR_ES_NAME | 'd' | NCL Syntax error: Invalid name |
| NCL_ERR_NO_RESPONSE | 'A' | Execution error: No response from network |
| NCL_ERR_NO_ACK | 'B' | Execution error: Negative ACK received |
| NCL_ERR_HOST_DOWN | 'C' | Execution error: Host down |
| NCL_ERR_NOT_REGISTERED | 'D' | Execution error: RPM not registered |
| NCL_ERR_LOW_BATTERY | 'E' | Execution error: Low battery - can't transmit |
| NCL_ERR_IBQ_FULL | 'F' | Execution error: RPM inbound queue full |
| NCL_ERR_TX_DISABLED | 'G' | Execution error: Radio transmitter disabled |
| NCL_ERR_BUSY | 'H' | Execution error: Resource unavailable |
| NCL_ERR_NOT_AVAILABLE | 'I' | Execution error: Unimplemented services |
| NCL_ERR_HW_ERROR | 'J' | Execution error: Generic |
| NCL_ERR_INVALID_MODE | 'K' | Execution error: Invalid mode of operation |
| NCL_ERR_NO_MESSAGES | 'L' | Execution error: No outbound messages available |
| NCL_ERR_MSGS_PENDING | 'M' | Execution error: Pending inbound messages |
| NCL_ERR_SW_ERROR | 'N' | Execution error: Software error has been encountered |
| NCL_ERR_OUT_OF_RANGE | 'O' | Execution error: Cannot send data when out of range |
| NCL_ERR_PACKET_ERROR | 'Z' | Execution error: SDU data corruption detected |
| Error Not Listed | All other values | Unknown error |

Prototype:

```
char * nclGetErrorDescription (int iErrorCode);
```

Description:

Return a pointer to a character string describing the specified error code.

Input:

| | |
|--------------|---|
| ➤ iErrorCode | Integer specifying the error code for which a string description is required. |
|--------------|---|

Output:

| | |
|-----------|---|
| ◀ WCHAR * | Pointer to a NULL terminated wide character (Unicode) string describing the error |
|-----------|---|

□ Register Wakeup Application

By default the VDD is executed on wakeup. In addition an application can register to be executed on wakeup via the VDD. On wakeup the VDD will post any Received data to the current active queues. If there are no active queues the VDD will execute the Registered applications. Once an application has initiated a successful VDD session (i.e. via 'VDDOpen ()') the VDD will post the Received data to the applications RX queue. A timeout (Wktm = 10 seconds) will be used to hold the data for an application to initialize and commence a VDD session before the data is discarded. The default application will be the Modem Information application as supplied as a sample application with the VDD.

Prototype:

```
int nclRegWakeupApp (WCHAR *usAppName, WORD usWakeupReason);
```

Description:

Register an application for wakeup when specified events occur.

Input:

| | |
|------------------|--|
| ➤ usAppName | Pointer to a buffer specifying the full path name (Null terminated) of the application to execute on a wakeup. |
| ➤ usWakeupReason | Logical OR the required reasons for wakeup from the following values (exclude unwanted reasons): WAKE_MODEM_INSERTION – Wakeup application when modem is attached WAKE_MESSAGE_RECEIVED – Wakeup application when a message is received but no client applications are running |

Output:

| | |
|--------------------|--|
| < Return value = 0 | Operation was successful |
| < Return value ≠ 0 | Operation failed. Value specifies the error type |

□ Deregister Wakeup Application

The application can call this function to deregister an application that was previously registered to wakeup.

Prototype:

```
int nclDeregWakeupApp (WCHAR *usAppName);
```

Description:

Deregister a wakeup application.

Input:

| | | |
|---|-----------|--|
| ➤ | usAppName | Pointer to a buffer specifying the full path name (Null terminated) of the application to execute on a wakeup. |
|---|-----------|--|

Output:

| | | |
|---|------------------|--|
| < | Return value = 0 | Operation was successful |
| < | Return value ≠ 0 | Operation failed. Value specifies the error type |

□ **Switch RPM On/Off**

The application can call this function to switch the RPM on or off.

Prototype:

int nclSwitchRMPower (word usSetting);

Description:

Switch the RPM power to the desired setting.

Input:

| | | |
|---|-----------|--|
| ➤ | usSetting | If this value is zero, the RPM should power down else it should power up |
|---|-----------|--|

Output:

| | | |
|---|------------------|--|
| < | Return value = 0 | Operation was successful |
| < | Return value ≠ 0 | Operation failed. Value specifies the error type |

□ **Send Generic NCL Command To RPM**

The application can call this function to send application specific commands to the RPM.

Prototype:

int nclSendGenericCommand (WORD *usSduTag, BYTE ucLength, BYTE *ucParam);

Description:

Send an NCL command to the RPM of which the payload contents consist of data from the specified buffer.

Input:

| | | |
|---|----------|--|
| ➤ | usSduTag | Pointer to a word where the SDU tag can be stored |
| ➤ | ucLength | Pointer to a byte specifying the total size of ucParam. |
| ➤ | ucParam | Pointer to the buffer (of size ucLength) containing the data to be send to the RPM |

Output:

| | | |
|---|------------------|--|
| ⏪ | Return value = 0 | Operation was successful |
| ⏪ | Return value ≠ 0 | Operation failed. Value specifies the error type |

❑ **Get Software Version**

The application can call this function obtain the software version of the server application or the VDD DLL.

Prototype:

int VDDgetVersion (WORD* usVersion);

Description:

Obtain the software version of the specified software entity.

Input:

| | | |
|---|-----------|---|
| ➤ | usVersion | Set this value to zero to request the VDD DLL version or to any other value to request the server application version |
|---|-----------|---|

Output:

| | | |
|---|------------------|--|
| ⏪ | Return value = 0 | Operation was successful |
| ⏪ | Return value ≠ 0 | Operation failed. Value specifies the error type |
| ⏪ | usVersion | The upper 8 bits contain the major version and the lower 8 bits contain the minor software version if the return value is zero |

Appendix C – SDK Sample programs

Sample programs are provided with the SDK. The purpose of the sample programs is to show how a complete working client server application can be built using the SDK NCL API with the client program.

The sample programs demonstrate how to write a simple application that allows a wireless client to send data to a central server application and receive responses back from the central server application. The sample programs are not intended to be a functional application, but are intended to serve as a guide to writing applications and can be used as a basis for developing more complex applications.

The information given in this section is intended to supplement the source code for the applications by providing a high-level overview of the source code.

The client application is called ModemInfo and uses the NCL API to interface to the DataTAC[®] network. The sample client program retrieves the modem's current status, and enables the user to send and receive messages on the current channel the device is registered to.

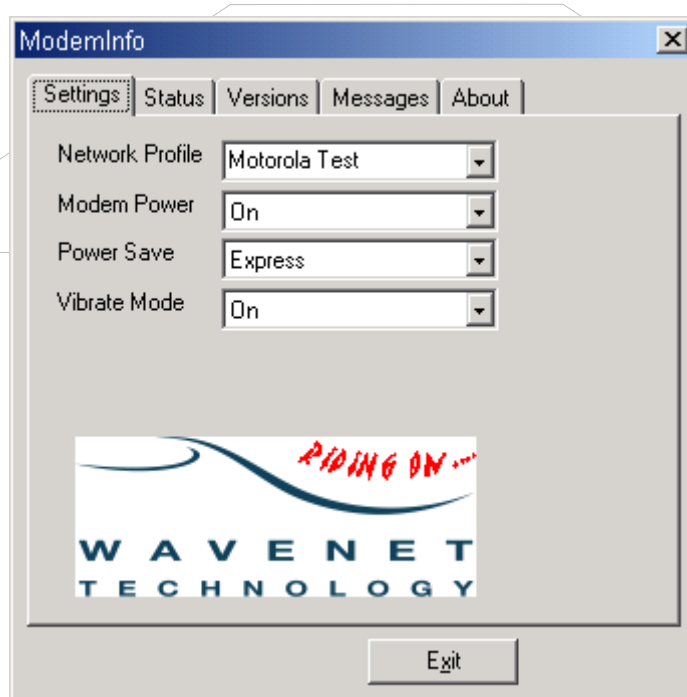

The Settings tab displays the modems current profile (i.e. Channel list, RD-LAP version, etc), whether the modem is on or off, the modems power save mode, and (if supported), its vibrator mode.

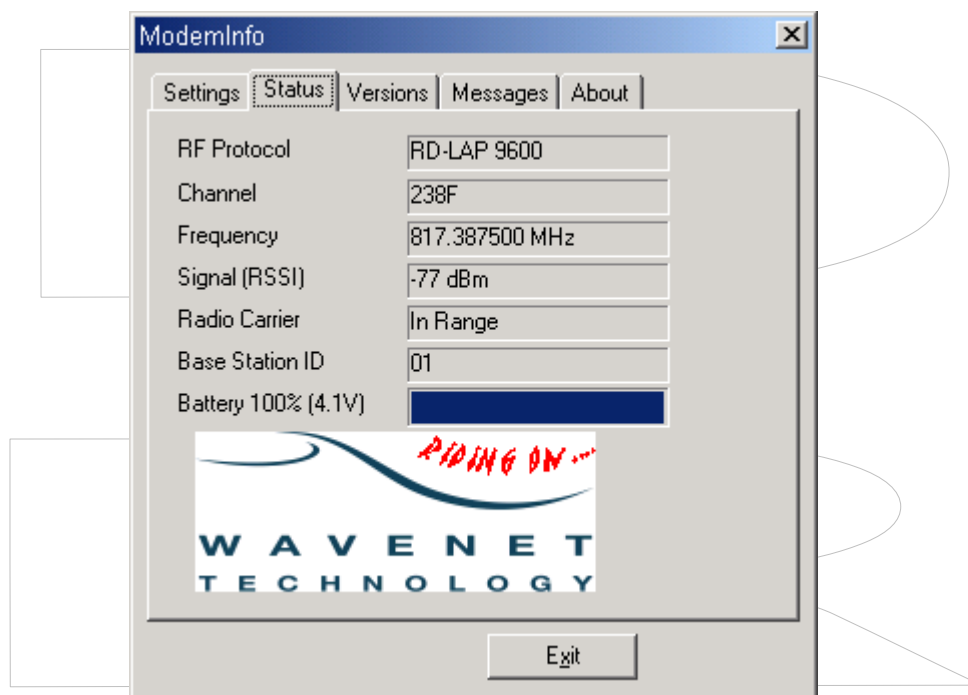

The Status tab displays the modem's current channel (if registered) and its RSSI level. If the device is not registered, it will be in scan mode, scanning the channels from the channel list in its current profile.

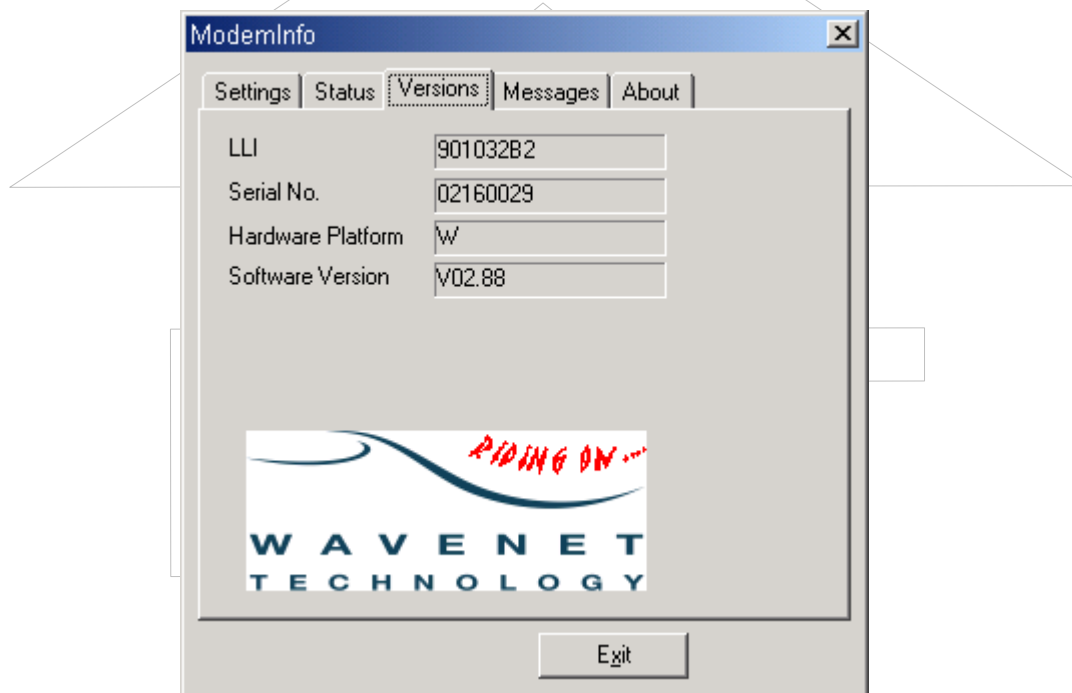

The Versions tab displays the devices LLI, serial number, hardware platform and software version.

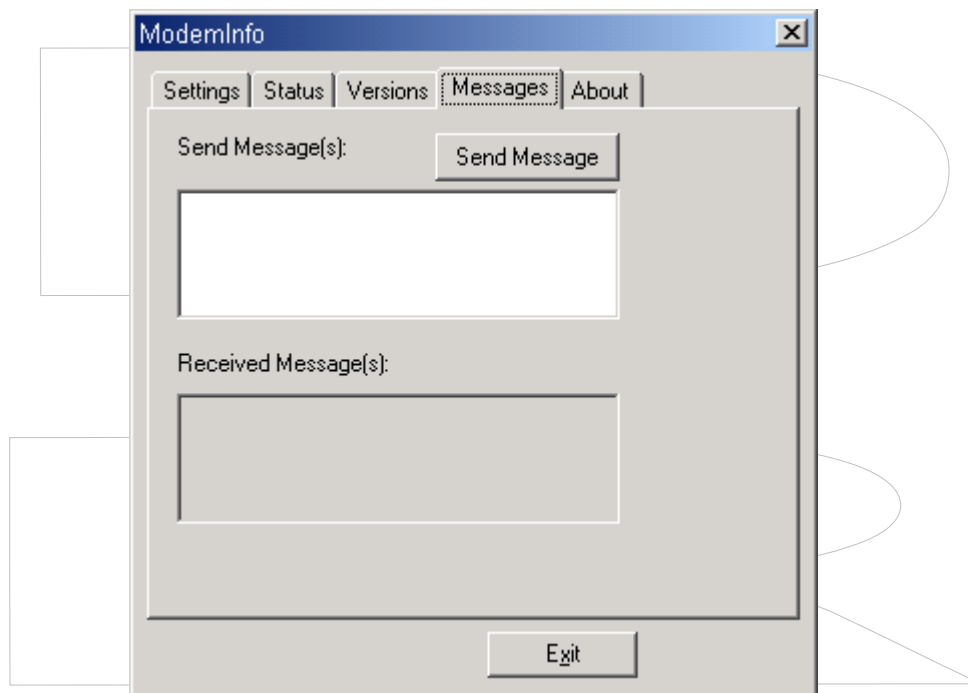

The Messages tab allows a user to send and receive messages from the channel the device is currently registered on.

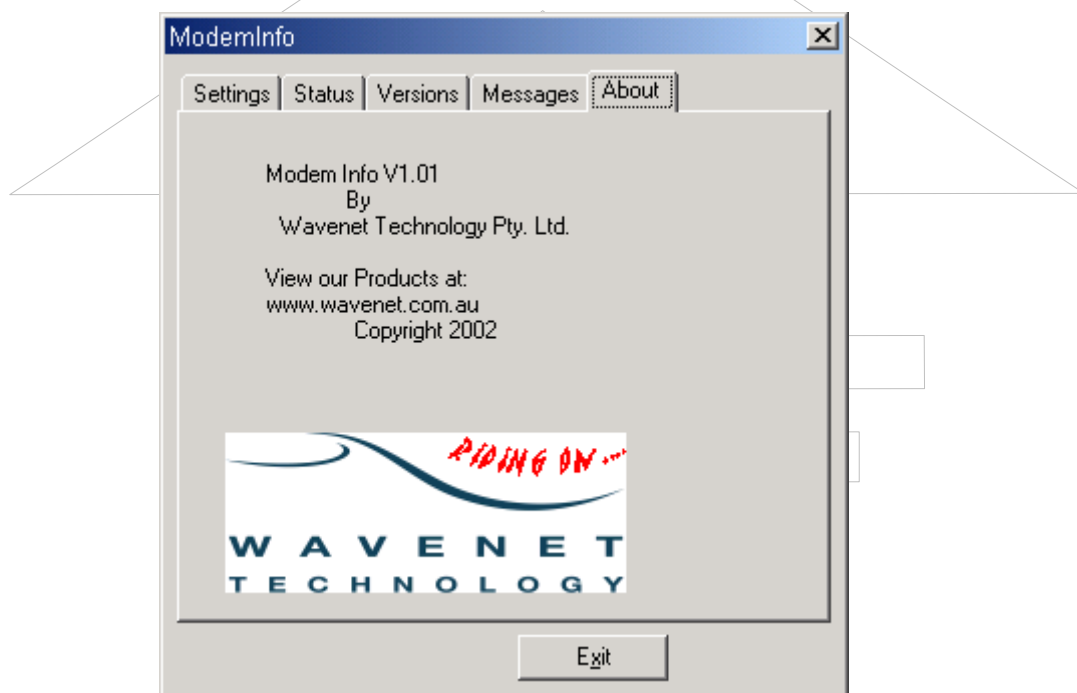

The About tab displays the version number of ModemInfo, copyright information, and the web address of Wavenet Technology.

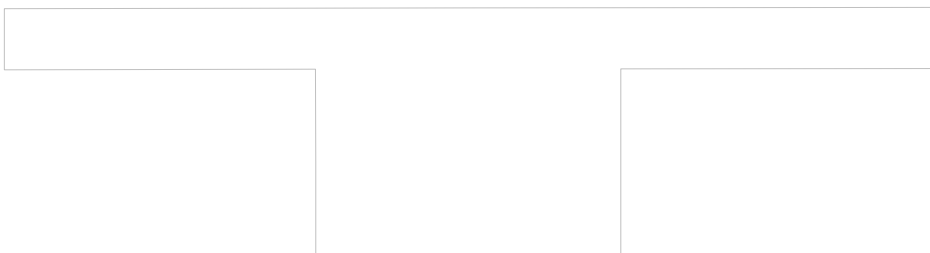
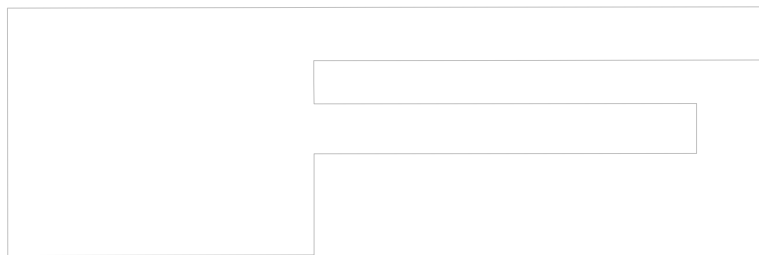
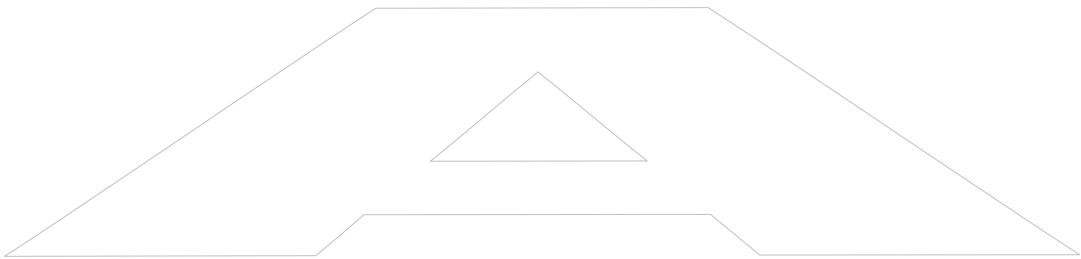
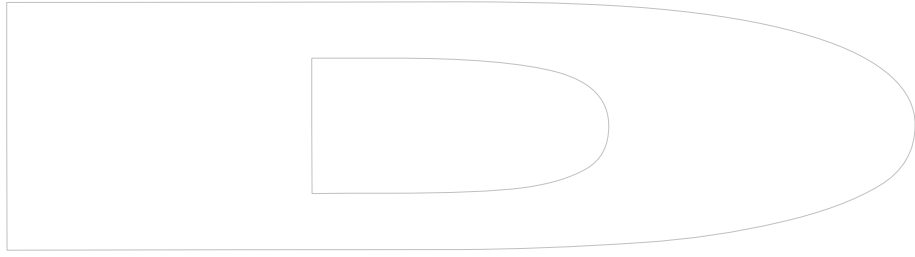

Appendix D - Application Development

This section provides comments and advice that can help you develop successful wireless enabled applications for DataTAC systems.

Application development for NCL-compliant wireless modem devices is a two-part process.

- The first step sets up the interface between the host/terminal and the wireless modem. In this step you must consider the interactions with the wireless modem, as established by the NCL 1.2 reference specification and the vendor specific extensions.
- The second step involves addressing message routing information to identify the message destination within the DataTAC network.

Use the following suggestions to help you develop wireless enabled applications.

- Use Power Save mode of operation to extend battery life and operational time for the user. We recommend that the application does not modify this mode dynamically.
- Use the Confirmed mode of operation to perform the following functions:
 - Check the SDU checksum for validity.
 - Re-read SDUs received in error.
 - Read past the last message in Confirmed mode to make sure the device buffer is fully flushed. If the buffer is not flushed, the last message is held, consuming valuable buffer space.
- Anticipate new NCL command, event, and response codes:
 - Perform exact matches on event and response codes.
 - Discard any unknown event type.
 - Map any unknown XFAIL code to be a NAK.
- Use SDU tags to uniquely identify application-generated SDUs.
- Anticipate the user will move between IN_RANGE and OUT_OF_RANGE conditions. This means you need to provide:
 - A user indicator that identifies the current operating status.
 - Recovery mechanisms when application transactions fail as a result of losing network contact.

Roaming Issues

During development, consider how the coverage for your wireless enabled application could be affected by a user moving in and out of the network coverage area. Coverage can be temporarily impacted by moving from one side of a building to another. Coverage can be lost for a longer time by moving beyond the network coverage boundary.

In application development, addressing this temporary or longer term gap in coverage, even in midst of an application transaction, is essential.

You can address this consideration by providing a transport level protocol that can account for the following roaming related situations when used with a DataTAC wire-less modem:

- ❑ Inbound SDU failure
- ❑ Outbound SDU failure
- ❑ Loss of network contact

These situations are discussed in detail from page 121.

In this case, the transport level protocol must have components both within the server and client application environment. This transport level protocol can be provided using existing third party software for DataTAC systems. Alternatively, you can develop a transport level protocol with your application in mind.

Roaming Requirements

The roaming algorithms for the wireless modem are described as follows:

Note: *In each case, re-establishing network contact requires the wireless modem to scan all likely channels and to handshake with the network.*

Send a quick (bounded) response to SDU transmit requests

When the wireless modem loses network contact, SDUs are returned with an out-of-range failure code. In this case, the wireless modem also indicates that it is out-of-range via an NCL event. When network contact is re-established, the wireless modem indicates an in-range event. The client application then resubmits any SDU last rejected with an out-of-range response.

Acquire the channel quickly

All channels are scanned quickly, starting with the dynamic channel list that contains the last used channel and its neighbours. (This list is broadcast periodically by the network.) If you cannot establish network contact using the dynamic channel list, the wireless modem scans quickly using the pre-programmed, network-specific static channel list. If network contact is not established using either list, this sequence is repeated after a delay interval. See "Conserve battery life when out of range" below.

Conserve battery life when out-of-range

When all channels (from both dynamic and static channel lists) are scanned and network contact is not established, the wireless modem enters a scan-delay state. The scan-delay starts at one second and doubles on each scan cycle failure, to a maximum of 255 seconds between scan cycles. This delay time is reset to one second by establishing a network connection or by power-cycling the device.

Re-establish network contact following inbound SDU failure (no response) and poor RF RSSI or signal quality

Any wireless modem experiencing a no-response inbound SDU failure and either with RSSI or quality below the exit threshold level must re-establish network contact. If unable to re-establish network contact, the modem indicates an out-of-range event. When network contact is re-established, the wireless modem indicates an in-range event. The client application then resubmits any queued inbound SDU last rejected with an out-of-range response.

Re-establish network contact due to loss of outbound channel

The wireless modem attempts to re-establishes network contact following loss of the outbound channel. If unable to re-establish network contact, the modem indicates an out-of-range event, and procedures to re-establish network contact are initiated. When network contact is re-established, the wireless modem indicates an in-range event. The client application then resubmits any queued inbound SDU last rejected with an out-of-range response.

Seek and locate the preferred alternate channel when the existing channel degrades to a marginal level

When the existing RF channel degrades to a marginal (but still usable) level, the device periodically listens to neighbouring channels to determine whether a preferred alternate channel exists. This action occurs when the device would otherwise be sleeping, to prevent impact to the device's synchronized-receive capability with the network.

To be considered, a preferred alternate channel must meet the minimum channel entry criteria and be 5 dBm better than the current channel. If located, a full channel acquisition is performed to verify all other aspects of the alternate channel before registering to the new channel. This preferred-channel pre-roam algorithm is performed at intervals that increase exponentially and with identical reset conditions. See "Conserve battery life when out-of-range" above.

Inbound SDU Failures

Potential SDU inbound failure codes are described below. The list identifies all likely SDU failure responses. The remaining SDU responses that appear in the NCL 1.2 reference manual are not expected to occur within the DataTAC wireless modem.

Inbound SDU failure, no response from network

The SDU was transmitted, but not acknowledged by the network. The SDU may have been delivered; the acknowledgment might have been the element that could not be successfully returned to the originating device.

Inbound SDU failure, host down

This failure indicates that the internal network connection to the application host computer is currently unavailable. Because DataTAC networks are designed with very high reliability, this failure is extremely rare.

Inbound SDU failure, low battery

The SDU could not be delivered due to a low battery condition. When a low battery condition is reached, the radio network connection is dropped until the low battery condition is corrected. (This can be addressed by replacing the battery or, if trickle charging is enabled, waiting for a sufficient charge level to be reached.)

Inbound SDU failure, inbound queue full

This response indicates that the maximum number (2) of SDUs are already queued within the wireless modem. Another SDU can be submitted when the NCL response for one of the pending SDUs has been returned.

Inbound SDU failure, out of range

The wireless modem has either lost network coverage or is in the process of re-establishing network contact. See "Loss of Network Contact" on the following page.

Inbound SDU failure, transmitter disabled

This SDU failure code indicates that the radio transmitter has been disabled, under application control, within the wireless modem. The transmitter must be enabled prior to submitting an SDU.

Note: This could be the result of transmitting a Receiver Disable command to the wireless modem. This command requires both Receiver Enable and Transmitter Enable commands to recover two-way communications.

Outbound SDU Failure

Due to the unreliable delivery of RF data packets (and their responses), a client application must consider the possibility of an outbound SDU being delivered to the client, with the transport confirmation of that data packet being lost (RF acknowledgment and/or transport level acknowledgment).

Note: When developing a centralized server and distributed-mobile client wireless enabled application, outbound SDU failure is primarily a server application issue.

When this occurs, the client and server transport levels must resynchronise to a common level before proceeding. Such an understanding might require retransmission of the transaction or retransmission of the transport confirmation.

Loss of Network Contact

When a wireless modem experiences a loss of network contact, queued SDUs are returned with the out-of-range response code and with out-of-range event indicated. A loss of contact can occur for the following reasons:

Moving beyond network coverage

When the device moves beyond the network boundary, network contact loss could occur for an extended period. Depending upon the user route and network coverage area, this interval could extend from a few minutes to several hours (or longer). Once network contact is re-established, the client and server application must be resynchronised if applications transactions have failed during the interval. After network contact has been announced, further delays should be minimised, as the user becomes acquainted with the coverage area.

Moving between areas of network coverage

Small movements within the area of network coverage can result in the loss and reacquisition of network contact, as a result of RF penetration difficulties with specific network topology and terrain. It might take from a few tenths of a second to a few minutes to recognize the channel has degraded to an unusable level, to qualify a new channel, and to re-establish network contact. Again, the client and server application must be resynchronised if application transactions failed during this interval.

Acquiring improved network coverage

A channel might originally have been marginal, or might have degraded from a good to a marginal level, or might be negatively impacted by the presence of other objects that influence its capability to send and receive data. Under such circumstances, the wireless modem seeks a preferred alternate channel, as previously described. Usually this situation does not produce notification of network contact and reacquisition.

Low battery

Network contact is dropped when a low battery condition is reached. This occurs at the same time as a battery alert notification event, but after the assertion of the LOWBAT LED that occurs while the battery still has some remaining usable capacity. The time between these events (the assertion of the LOWBAT LED and the loss of network contact) is much influenced by the battery technology and the level of transmit activity within the wireless modem. A relatively inactive device provides more warning time than an active device. Also, an alkaline battery provides more warning than a NiCad battery.

Low buffers

If outbound SDUs remain unread within the wireless modem, its outbound buffers are eventually filled. When this occurs, network contact is dropped. Network contact is re-established when the internal buffer pool within the wireless modem reaches a usable level, as a result of SDU reads by the application. This situation never occurs when the client application reads continuously to clear the wireless modem of received outbound SDUs.

Receiver disabled

The client application can disable the wireless modem transceiver by using the Receiver Disable NCL command. When this occurs, network contact is dropped and the radio is turned off. Network contact is re-established when the application issues the Receiver Enable, then the Transmitter Enable NCL commands.

Power Management

The following modem power management options can be included in an application to maximize battery life:

Power Save Mode

The wireless modem defaults to Power Save mode when turned on if the network supports the Power Save protocol. If you are concerned about latency of unsolicited outbound messages, you can turn off the Power Save mode, but at the expense of consuming more battery power. For details, refer to the NCL 1.2 command `S_POWER_SAVE_MODE`. See “Battery Life Considerations” and “Power Save Protocol” on the following page.

Dynamically modifying the Power Save mode of the device is not recommended.

On/Off upon User Demand

To extend battery life, design the application to switch the modem on and off as the usage need arises. This method is especially effective for session-based, user-initiated applications.

Radio On/Off on Application Command

The radio is the primary power-consuming component in the wireless modem card. Use `S_RX_CONTROL` for very effective control of session-based, user-initiated applications.

Battery Life Considerations

In addition to specific power management options, some application design decisions greatly affect battery life, as follows:

User traffic, amount and frequency

Commercially available compression techniques can significantly reduce traffic volume, which improves device battery life and reduces network usage costs. Power Save mode batches outbound traffic at a periodicity equal to the network-defined Power Save protocol frame size.

Data compression

Improve battery life by reducing and compressing the broadcast application data. Network usage costs can also be significantly reduced as a result.

Power Save Protocol

The following points describe unique operational characteristics of devices that are compliant with the Power Save protocol when operating on a network, as compared to those that are not. Specific Power Save timing parameters can vary by network, based on how the network operator sets up Power Save protocol parameters.

Under Power Save protocol, unsolicited outbound traffic to a non-awake device is delayed. The worst case delay until the first transmit opportunity is 128 seconds under DataTAC 4000 networks and 64 seconds under DataTAC 5000 networks. The average delay until the next delivery opportunity is one half of the worst case time, given the current network and device configuration.

In DataTAC 4000 systems, initial unsolicited outbound transmission attempts are actually “ping” messages used to locate the device.

In DataTAC 5000 systems, unsolicited outbound messages (or messages that have missed the previous transmit opportunity) are delivered in the “root” (that is, home) window for the recipient device. Once the device is thus awakened, it remains awake for about n seconds after each message or ACK transmission from the device.

During the wake time the network delivers messages to the device as it would to a device that is non-compliant with the Power Save protocol. (Default $n = 20$ seconds for DataTAC 4000 networks and 8 seconds for DataTAC 5000 networks.)

Roaming and location update reporting to the network happens more slowly because the Power Save protocol device takes longer to respond to changes in the RF environment. The infrequent worst case latency in responding to external stimuli (resulting in either a location update or

new channel scan) is about 9 minutes for DataTAC 4000 networks. DataTAC 5000 networks respond typically in 1.5 Power-Save protocol frame times, or about 96 seconds.

Wireless Data Systems Considerations

The wireless modems application developer must account for the limitations of a wireless data system to minimize their impact on the user.

Limited Data Capacity on Radio Frequency Channels

The channels available to wireless modems are narrow-band and have limited information carrying capacity (bandwidth) when compared to traditional wire line communications. Additional capacity can be gained only by increasing the number of channels, improving the hardware technology, or by developing more efficient applications. As a result of all these limitations, it is not surprising that wireless networks are often more expensive to operate on a per-packet basis than wire line Wide Area Networks (WAN). To address this concern, the NCL has been designed to provide the most efficient way of using the limited channel bandwidth.

Message Delivery Cannot Be Guaranteed

Because a wireless device can roam without restriction, it can exit the network RF coverage area, leaving it unable to receive or successfully transmit messages. When a device is outside the coverage area, the applications are informed of failed inbound delivery. The application is required to take appropriate recovery action.

Variation in Message Transit Times Across the Network

The time interval messages transit the network is affected by the RF protocol, the message load on the network, and the length of a message. These variations might need to be taken into account by the application.

The following sections address some of these shortcomings in more detail.

Application Efficiency

One goal of application development is to provide the required functionality with the least amount of messaging. The consideration here is to minimize the number of interactions in an information exchange. Doing so addresses the limited data capacity and increased costs of wireless messaging. In addition, the pricing structure of network operators encourages efficient application design. In fact, applications can be designed to use data compression or to apply techniques that send only data fields that change between transactions.

Large Message Transfer

Message size is a key factor affecting response times in wireless data systems. To efficiently accommodate typical data applications, the

DataTAC 5000 system is optimised for the transfer of short and medium length messages. Typically, messages up to 512 bytes are transferred across the network as a single data packet. Messages larger than 512 bytes are segmented into 512-byte packets by the DataTAC system before being transmitted over the air. The packets are reassembled before they are delivered to the application. For MDC 4800 operation on DataTAC 4000 systems, the segmentation size is 256 bytes.

For example, a 600-byte user message or service data unit (SDU) results in the delivery of two packets, or protocol data units (PDU), that are reassembled in the wireless device. Each PDU requires a Radio Data-Link Access Procedure (RD-LAP) acknowledgment from the device, which takes a few seconds to complete. The fewer PDUs in a message, the shorter the delivery time. If messages larger than 2 kB are to be sent across the system, the host and wireless device application must provide the segmentation and reconstruction functions.

Message Transit Time

The time required for an inbound or outbound message to travel across the network is primarily a function of the queuing delays associated with each product in the network infrastructure and the message load on the system. As system traffic builds, queuing delays increase for outbound traffic, while the average time to access the inbound channel increases, resulting in longer inbound message transit times.

Additional delays are encountered when the wireless terminal is in the process of roaming from one cell on one radio channel to a cell on another radio channel. If the cells are controlled by the same cell controller, the delay time is quite short. The delay time can increase if the cells are controlled by different cell controllers on different sub networks.

For a DataTAC 5000 fixed-end system operating at full rated capacity, the mean transit delay between a network host and a wireless device is typically no more than four seconds.

The application developer must develop operational scenarios to accommodate the variable transit time in the application design.

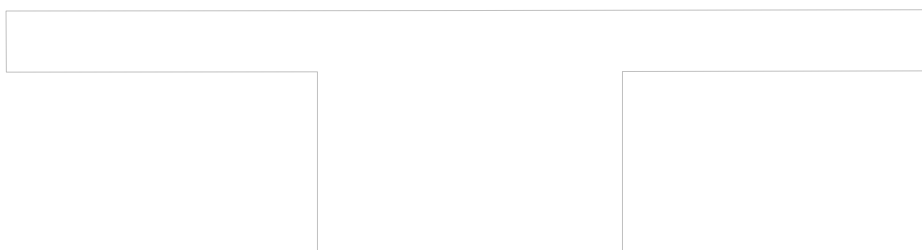

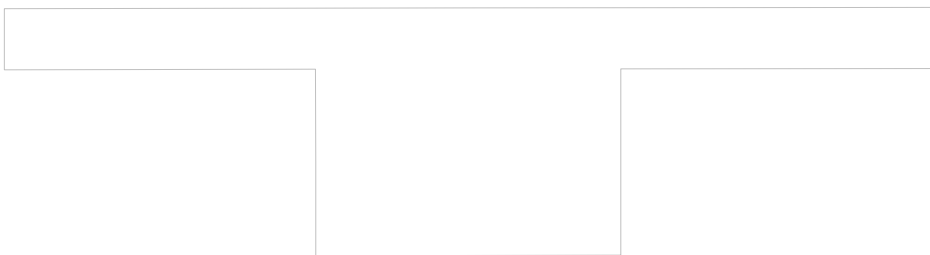
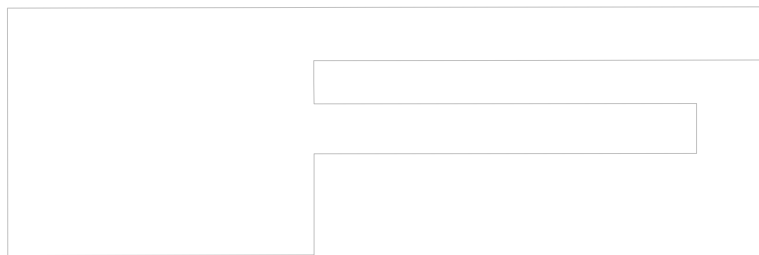
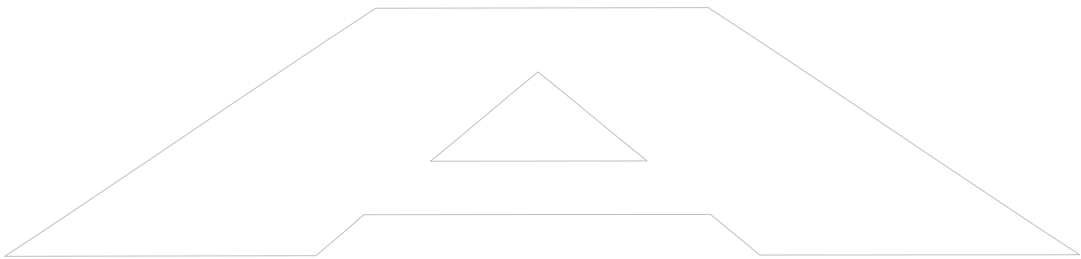
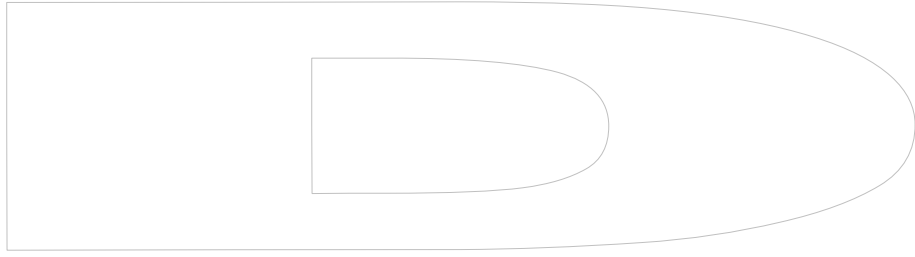

Appendix E - Message Routing and Migration

This section provides a brief overview to message routing across the various releases of DataTAC® systems. As the developer and user communities become more international in scope, successful applications will be distinguished by their portability across existing DataTAC networks.

Message Routing

Three versions of DataTAC systems are in operation worldwide, as noted by where they are currently implemented:

- ❑ DataTAC 4000 systems (North America)
- ❑ DataTAC 5000 systems (Asia-Pacific and Middle East)
- ❑ DataTAC 6000 systems (Europe)

The architectures of the three systems are basically alike. Although they support different link layer protocols, the systems differ mainly in their message header syntax.

The distinction between host communications and peer-to-peer messaging is also important. Separate DataTAC protocols support each of these application models. The primary host communications mode is Standard Context Routing (SCR), also known as fleet mode. Another application mode is DataTAC Messaging (DM), which handles messaging among terminals (subscriber units).

SCR and DM are the common sets of rules that describe how to format message headers on DataTAC systems. Although the header format differs slightly among DataTAC 4000, 5000, and 6000 systems, the functional concepts of operation are the same. The exact SCR and DM syntax for each system is available in their separate Host Application Programmer's Manuals.

Note: In this section "host" refers to the network fixed host. "Terminal" refers to a subscriber device.

Network Link Layers

Before a message can be routed, it must contain a header and be wrapped in a link layer protocol supported by the DataTAC network. Not all link layer protocols are supported by each DataTAC network.

The X.25 protocol is common to all three systems and supports both PVC and SVC host connection line types. X.25 is a popular choice for developers looking for a worldwide connectivity solution.

Other supported protocols include:

- | | |
|-----------------------|--|
| ❑ DataTAC 4000 system | X.25, TCP/IP, LU6.2, leased line, dial-up, RF-Loopback |
| ❑ DataTAC 5000 system | X.25, TCP/IP, SLIP |
| ❑ DataTAC 6000 system | X.25 |

Standard Context Routing (SCR)

SCR allows the central host to communicate with hundreds, even thousands of terminals across a single host connection. But the real advantage of using SCR is economic: The host only pays for a single connection to the network, significantly reducing communications cost.

When a terminal sends a message to the host, the message must contain a header that includes the sending terminal ID. This enables the host to identify which terminal sent the message and which terminal the host is to poll.

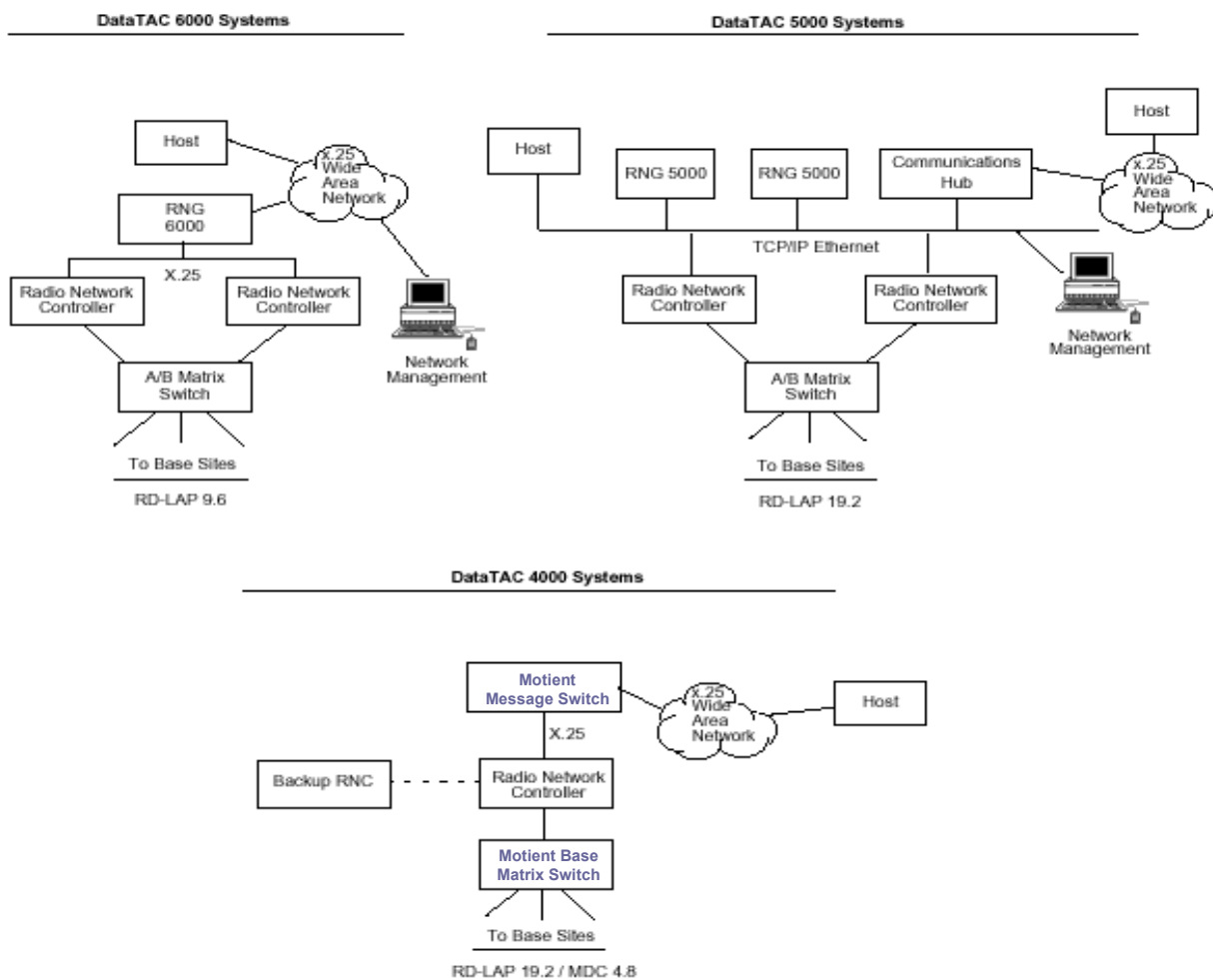

DataTAC System Architectures

Other header fields provide the host with options for instructing the network on handling undeliverable messages. For example, the host can ask the network to:

- Provide a delivery status of messages.
- Hold messages on the network for a later delivery.
- Discard messages.

This header and instruction information is the basis of the SCR protocol.

DataTAC Messaging (DM)

DM allows one terminal to communicate with up to ten other terminals by routing a message through the DataTAC system network. As such, DM provides the protocol for basic E-mail functionality. System differences with regard to DM appear mainly as differences in syntax.

Peer-to-peer communications uses two types of messages:

- ❑ Generate (originator-to-network)
- ❑ Receive (network-to-destination)

Each message type must include its own type of header. Within each system, each type of header has small differences in syntax.

Other Development Issues

Localizing and testing your applications are not issues related specifically to application migration. The following comments are provided as a helpful reminder only.

Localizing an Application

Whether you are preparing your application for sale internationally or developing it internally for an international company, consider designing in international characteristics from the beginning, such as character encoding, language enabling, and special text formatting. While such an effort can take longer up front, any eventual re-reporting of the application will be much easier to manage.

Character Encoding

If your application supports languages that use Latin-based characters (for example, English, Spanish, and German), design your application for compatibility with 7-bit ASCII/ISO 646 and Latin 1/ISO 8859-1, 8-bit display fonts.

If your application support dialects of non-Latin languages, such as Chinese, Japanese, Korean, or Thai, design your application to work with Unicode or another 16-bit character encoding standard. In addition, provide your application with flexible keyboard mapping.

Language Enabling

Isolate all translatable strings, icons, and menus from your program. Then the greater part of a localization effort will be translation, rather than re-engineering. Allow for expansion of text strings during localization. Most translations are longer than the original. Allow your program to accept variable-length strings or use the international language capabilities inherent in the application environment, such as Windows 2000, Windows 95, Windows NT, or Windows CE.

Special Text Formatting

The display of dates, numbers, and monetary values varies among locales. Support for these differences may be provided by your

programming environment to simplify the development of code. If your programming environment doesn't provide such support, include alternative tables or options for use when localizing.

Testing an Application

Virtually all public network operators have some testing or certification procedure available to help ensure that your new applications behave appropriately when brought onto the network. Many systems also have test nodes, which allow program testing without risk of interrupting the public network. Because each operator's procedures and requirements differ, check with the operator of your target network regarding their individual certification procedure.

With the proper documentation, writing an application that will operate on a wireless network anywhere in the world is not difficult. You don't have to develop an application on site in the region where it will operate. For example, if your local and target networks are the same, the logistics associated with testing the application are fairly minimal.

Testing an application for a distant target network requires a bit more planning, since the network is not directly accessible from your development site. In this case, two approaches are worth considering:

- If your application is designed for a DataTAC network in another country and your local network uses the same version of DataTAC system as the target network, sign up with your local network operator for service during development, test, and support. When the application is complete, it is likely that the target network operator will require validation or certification tests. After having used your local network for development tests, validation testing will probably be a straightforward process.
- If your local network is other than the target network, you might still want to develop a local version of the application to test the logic and performance of your program in a controlled environment. (Be sure to get advanced approval from the local operator to run your test version without it being validated.) In this case, the target network will not be tested directly and more verification testing will be required.

Appendix F – Guide to Desense

When you integrate wireless data radio technology into computing and telemetry devices, you must consider hardware issues related to RF emissions. For example, you must address the technical aspects of enabling a wireless RF device as an integrated peripheral in a host/terminal, such as RF performance and inter-operability with the host/terminal.

Specifically, this sections describes the following:

- The term “desense”
- Preferred test procedures
- Acceptable levels of electromagnetic interference (EMI)
- Approaches to solving desense problems
- Pertinent radio and antenna issues

Note: *This section considers, but does not attempt to resolve these technical issues for a particular platform. That is beyond the scope of this guide.*

Receiver desensitisation occurs when an unwanted signal is present at the radio receive frequency. The signal is usually the result of harmonic energy emanating from a high frequency, non-sinusoidal source. This noise desensitises or lowers the sensitivity threshold of the receiver.

The radio cannot differentiate between wanted and unwanted signals. In frequency-modulated systems, the radio receiver can capture the strongest signal present. If wanted and unwanted signals are present, and there is not a significant difference in level, the unwanted signal can overtake the receiver, effectively blocking the wanted signal see the following diagram.

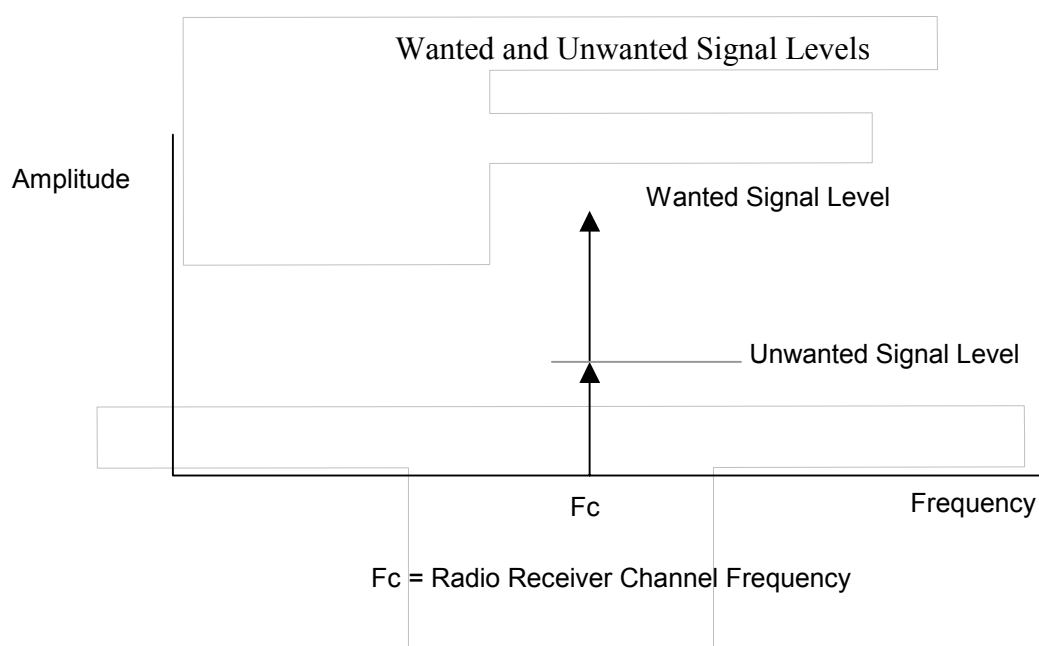

Consistent and reliable reception occurs when a safety margin dictated by co-channel rejection is maintained. For example, if the co-channel rejection is 10dB, all unwanted signals must be 10dB below the receiver's sensitivity level. Some modems and networks have different rejection levels. Use the rejection level appropriate for your modem (typically -10dB). This means an interference signal that is more than 10dB below the wanted signal has little impact on the data receiver's data recovery. Any interfering source above this level creates desense, reducing the radio's sensitivity for data reception. For every one dB above the threshold level, one dB of desense is created.

Noise Sources

CPU clocks, address and data buses, LCD refresh, switching power supplies, and peripheral drivers are the primary contributors of EMI. The frequencies of these emissions are often unstable. One reason for this instability is that high stability clock sources are not a requirement in host/terminal designs.

The frequency of sources drifts as a function of temperature, time, and aging. Other sources by nature move within the frequency spectrum as a function of time. The edges of clock signals create detectable harmonics well into the 1GHz band. This presents a challenge in measuring the effects of the emission, as one must first determine where the emission exists in the frequency spectrum.

Noise from the host/terminal can conduct through the electrical/mechanical interface or radiate electromagnetic fields that are received by the modem antenna and impact the modem. The Boomer-III OEM modem is specifically designed to minimize conducted noise.

Radiated electromagnetic fields emanating from the internal circuitry are incident on the modem antenna. These fields then are converted to noise power by the antenna and are incident on the receiver. The physical interface signalling connection has less impact on the receiver performance and can be electrically decoupled using passive components.

Receiver Susceptibilities

The receiver is susceptible to being desensed within the channel bandwidth and at intermediate frequencies used for down conversion. Excessive noise on power supply pins can also create sensitivity problems.

Measurement Techniques

Desense can be measured in one of the following ways:

- Indirectly by recording the emission level from the host/terminal and then calculating the effect on the modem.
- Directly by using packet error rate testing off air.

Testing directly is preferred method because it is more of a system test.

The test must be non-intrusive. Peripheral test cables or apparatus must not be connected to the unit under test, as they can have a significant effect on the receiver sensitivity results.

Indirect testing is essentially FCC Part 15 EMI testing that occurs today. Bear in mind that some assumptions have to be made to extrapolate the results and convert them to desense figures. Of course, these assumptions can create some error in the prediction.

Alternate Measurement Method

Wavenet can performed desense testing on an integrated host/terminal using a special facility. The best alternate methods for determining the desense is to measure the signal the receiver port sees by using a spectrum analyser (see below).

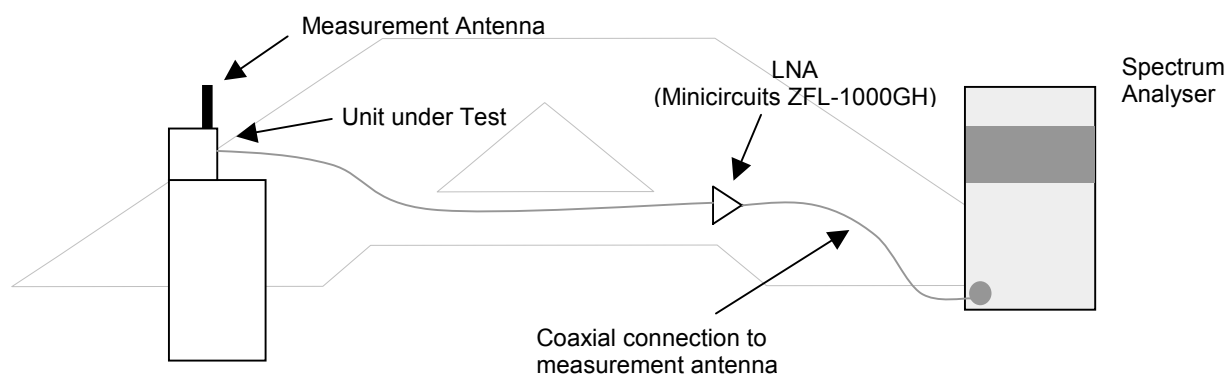

Spectrum Analyser Setup

Using a spectrum analyser with an input impedance of 50 W, connect the antenna of the product under test to the analyser. If an antenna is currently not developed, use a portable dipole antenna as a measurement antenna.

The measurement apparatus is capable of measuring signals as low as -120dBm. A preamplifier is required to allow the spectrum analyser to achieve these levels. Use the analyser's smallest possible resolution bandwidth, typically 1kHz, to improve the dynamic range of the measurement.

If the input impedance of the analyser is the same as that of the radio receiver, and the antenna, you can measure the noise to which the receiver will be subjected. The gain on the LNA will make low-level noise more visible. Ensure that the spectrum analyser's input is not

over driven by other RF signals, such as FM radio stations. Any spikes that appear might cause desense problems.

The indirect method cannot account for characteristics of the data protocol and is less effective. Also, the bandwidth of the noise source is important. If the source is narrow-band, it has less effect than one occupying the entire channel bandwidth. The method is not effective in determining desensitisation at IF frequencies or from less obvious sources such as mixed products. The method provides information on how much effort, if any, needs to occur to resolve desense problems.

This method is useful when connection of the wireless card is not yet facilitated by the platform. This measurement could be performed without the wireless card present. This method determines the magnitude of the emissions, without extensive test facility requirements.

Methods of Controlling Emissions

Preferred methods of controlling emissions observe that the emissions must be contained to a level 40dB less than the FCC Part 15 requirements. For WAN (Wide Area Network) products, the accepted method of achieving this is to shield.

Through past experience, it has become evident that standard techniques used to achieve FCC certification are not enough to satisfy wireless communications. Engineering teams logically attempt an array of decoupling, partial shielding, and PCB layout methods, which produce incremental improvements, but do not achieve the emission control requirements. Hybrid methods of shielding and source reduction are often a good approach.

Important: *Unless the host/terminal is already close to the goals set out in this document, source reduction efforts may only drive up the direct materials cost of the product and not increase return on that investment.*

If a compromise is chosen where the target levels are not the goal, standard EMI techniques can be of value. For narrowband emissions, some form of clock frequency “pulling” or control can be implemented.

Shielding Approach

The mechanical design of the host/terminal must allow the EMC engineers to create a Faraday Box shield design. This is an electrically continuous shielded enclosure. If designed properly, such an enclosure easily attenuates radiated signals from the host/terminal.

The shield approach appears to be a big step at first. The advantage is that the shield will minimise the possible redesign required of the host/terminal PCB platform and circuitry.

For a thorough discussion of shielded enclosure design, an excellent reference is *Electromagnetic Compatibility: Principles and*

Applications by David A Weston. The publisher is Marcel Dekker, Inc. 270 Madison Avenue, New York, NY 10016. Any well written text on EMI control should cover the design of shielded enclosures.

Components of the Shield Design

To be effective, the shield design must incorporate:

- ❑ A highly conductive shielded enclosure that encapsulates all of the active circuitry. This can be constructed of sheet metal or plated/sprayed plastic.
- ❑ Decoupling on all signals exiting the enclosure
- ❑ Control of aperture sizes in the shield to less than 1/10 of the frequency of interest. This would apply to keyboard and display apertures in the enclosure. Testing of aperture radiation at the frequencies of interest may prove larger apertures are acceptable to the particular scenario.

Benefits of the Shielding Approach

Emissions reduction can be achieved using shielding source reduction techniques, such as decoupling, or PCB layout and grounding, or a combination of the two. Once a shield is in place, any revisions to product circuitry have no effect on emissions levels. If a circuit level approach is used to control the emissions, a change in circuitry can bring a new unknown to the emissions performance.

Alternate EMI Reduction Methods

Although shielding is the brute-force method of reducing emission levels, other methods are available, such as:

- ❑ PCB layout modification using ground layers adjacent to high speed layers
- ❑ Capacitive or filter decoupling
- ❑ Redistribution of module interconnects
- ❑ Clock Pulling

Clock Pulling

Clock pulling is effective when the emission sources are narrowband. To implement clock pulling, a method must be devised for the modem to tell the host/terminal it is having difficulty receiving. Devising such a method is admittedly very difficult. The host/terminal provides “pulling” of its internal emission source, which is identified as a potential problem.

If this source is the cause of the interference, the pulling or slight shift of the source frequency moves the harmonic energy out of the receive channel. This is an inexpensive way of solving the problem, as no special shielding or decoupling is required.

The limitations of the clock pulling method are:

- ❑ Computing devices have many more than one source
- ❑ Each source must be identified and controlled. This identification is at times difficult.
- ❑ The host/terminal and modem must communicate the problem at hand to attempt to correct it. This capability is not supported by the Boomer-III OEM modem.

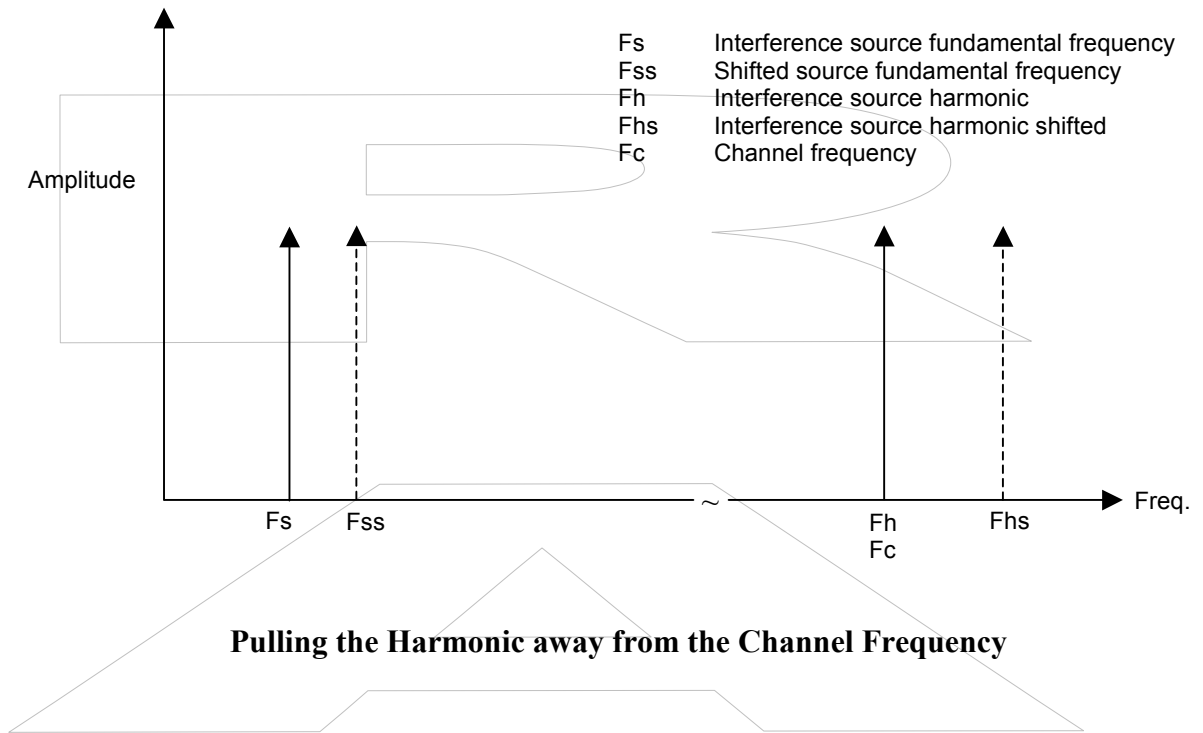

RF Network Issues

Each RF network has its own requirements for the subscriber device. Most networks implement a coverage equalization scheme. This consists of configuring the infrastructure sites such that their RF power output is equal to that of the subscriber device.

Since most portable devices are battery operated, the transmitter power of the portable units is relatively low. To compensate for this, the base site transmitter power is decreased to a level equal to that of the portable. The base site has a much larger and reliable power source, and is capable of putting out more power. This would help overcome desense problems that the portable unit incurs. Most network managers prefer not to increase their site power because of ERP licence limitations and cell overlap issues.

Network operators must consider ambient noise levels when designing their coverage plans. Once the wireless modem and host/terminal are engineered not to “self-desense”, other machines in the user’s environment can still impact radio performance. These machines are not usually within close proximity of the wireless modem antenna, and have less effect. An FCC Class B radiator can impact the wireless

device if it is within 30 meters of the device, assuming that an emission exists at the channel frequency of the radio.

Networks can assist in the desense problem by offering more than one channel frequency at which to operate. If the radio encounters interference on a channel, it can then roam to another.

WAN protocols include retry mechanisms that resend messages not acknowledged from the subscriber device. These protocols can correct problems from intermittent noise sources by retrying during a time slot that does not coincide with noise source interference.

At a certain point, desensitising a wireless modem receiver creates unacceptable coverage in the network. This usually is in the 10dB range, though it can vary with networks.

The integrator should consult the technical staff at their target network for any minimum RF desense performance levels and related measurement methods that may be required for the device to be accepted for customer use on that network.

Antenna

The Boomer-III OEM modem is not equipped with an on-board antenna and one must be provided externally in the host/terminal.

Field Strengths from the Antenna

Field strengths from the wireless modem transmitter can reach as high as 100 V/M for WAN products. Harden the host/terminal to withstand these levels. LCD displays and switching power supplies are particularly susceptible to RF. Capacitive decoupling of sensitive areas is required. Decouple the reference voltage points on power supplies, reset lines on processors, and keyboard scanning circuitry.

Antenna Interactions

There are two interactions that can impact the performance of the antenna. The user, by placing a hand near the antenna can detune the antenna and absorb energy. Accordingly, the antenna must be positioned such that interaction between the user and the card is minimized.

The host/terminal might also interact with the antenna. This is particularly true for WAN modems, which have higher output power. An imaginary sphere of real estate should be provided for the antenna to function. Cabling for other peripherals must not interfere with this region.

Desense Summary

Desense considerations fall into two categories when using a wireless device and computer as a system:

- The impact of the host/terminal EMI on system performance

- The impact of the RF fields from the wireless device transmitter on host/terminal operation

The latter consideration is not a significant problem. If RFI is assessed properly, it is usually corrected with little effort and cost.

Because of the need for system coverage, the host/terminal EMI interaction with the radio receiver can be a significant and often elusive problem to characterize and correct. Most host/terminal devices are very fast and include numerous high frequency radiators. These can interfere with the radio reception of the wireless modem.

The theoretical levels at which the receiver might be impacted are derived from system coverage requirements and the sensitivity of the radio. These goals are not set arbitrarily to improve product performance, but to maintain the RF performance the networks demand and the radios are designed to deliver.

Since each product is unique. The level of noise is very difficult to predict, as is the amount of effort needed to control it. Measuring the product in an early engineering phase is key to managing the situation.

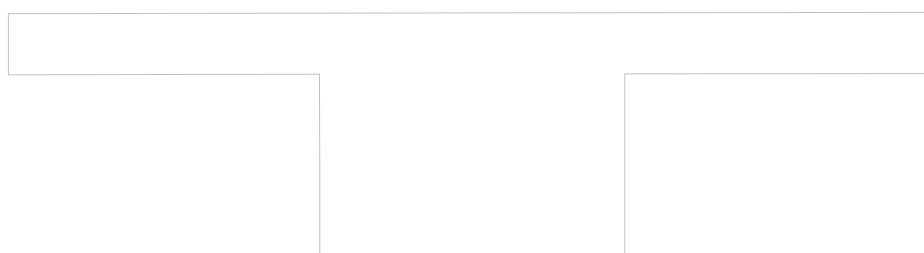
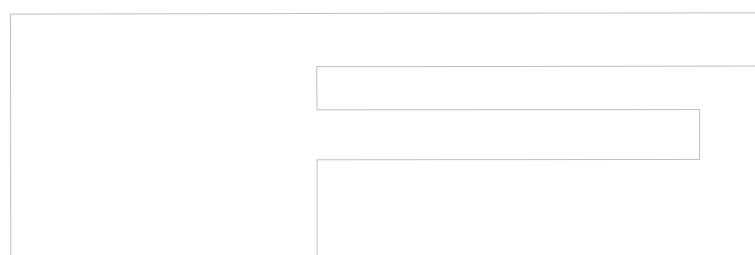
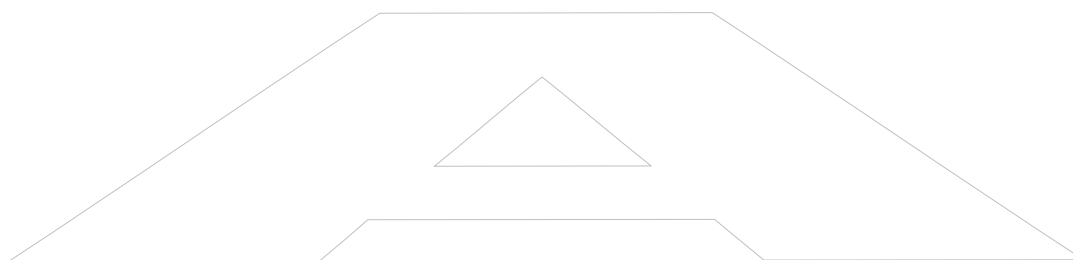

Appendix G - Numeric Conversion Chart

Binary/Octal/Decimal/Hex/C/ASCII Conversion Table

| Binary | Oct | Dec | Hex | C | ASCII | Definition | Binary | Oct | Dec | Hex | C | ASCII |
|----------|-----|-----|-----|----|-------|-------------------------|----------|-----|-----|-----|----|-------|
| 00000000 | 000 | 0 | 00 | C | NUL | Null, or all zeros | 01000000 | 100 | 64 | 40 | P | @ |
| 00000001 | 001 | 1 | 01 | C | SOH | Start of Heading | 01000001 | 101 | 65 | 41 | UX | A |
| 00000010 | 002 | 2 | 02 | C | STX | Start of Text | 01000010 | 102 | 66 | 42 | UX | B |
| 00000011 | 003 | 3 | 03 | C | ETX | End of Text | 01000011 | 103 | 67 | 43 | UX | C |
| 00000100 | 004 | 4 | 04 | C | EOT | End of Transmission | 01000100 | 104 | 68 | 44 | UX | D |
| 00000101 | 005 | 5 | 05 | C | ENQ | Enquiry | 01000101 | 105 | 69 | 45 | UX | E |
| 00000110 | 006 | 6 | 06 | C | ACK | Acknowledge | 01000110 | 106 | 70 | 46 | UX | F |
| 00000111 | 007 | 7 | 07 | C | BEL | Bell | 01000111 | 107 | 71 | 47 | U | G |
| 00001000 | 010 | 8 | 08 | C | BS | Backspace | 01001000 | 110 | 72 | 48 | U | H |
| 00001001 | 011 | 9 | 09 | CS | HT | Horizontal Tab | 01001001 | 111 | 73 | 49 | U | I |
| 00001010 | 012 | 10 | 0A | CS | LF | Line Feed | 01001010 | 112 | 74 | 4A | U | J |
| 00001011 | 013 | 11 | 0B | CS | VT | Vertical Tab | 01001011 | 113 | 75 | 4B | U | K |
| 00001100 | 014 | 12 | 0C | CS | FF | Form Feed | 01001100 | 114 | 76 | 4C | U | L |
| 00001101 | 015 | 13 | 0D | CS | CR | Carriage Return | 01001101 | 115 | 77 | 4D | U | M |
| 00001110 | 016 | 14 | 0E | C | SO | Shift Out | 01001110 | 116 | 78 | 4E | U | N |
| 00001111 | 017 | 15 | 0F | C | SI | Shift In | 01001111 | 117 | 79 | 4F | U | O |
| 00010000 | 020 | 16 | 10 | C | DLE | Data Link Escape | 01010000 | 120 | 80 | 50 | U | P |
| 00010001 | 021 | 17 | 11 | C | DC1 | Device Control 1 (XON) | 01010001 | 121 | 81 | 51 | U | Q |
| 00010010 | 022 | 18 | 12 | C | DC2 | Device Control 2 | 01010010 | 122 | 82 | 52 | U | R |
| 00010011 | 023 | 19 | 13 | C | DC3 | Device Control 3 (XOFF) | 01010011 | 123 | 83 | 53 | U | S |
| 00010100 | 024 | 20 | 14 | C | DC4 | Device Control 4 | 01010100 | 124 | 84 | 54 | U | T |
| 00010101 | 025 | 21 | 15 | C | NAK | Negative Acknowledge | 01010101 | 125 | 85 | 55 | U | U |
| 00010110 | 026 | 22 | 16 | C | SYN | Synchronous Idle | 01010110 | 126 | 86 | 56 | U | V |
| 00010111 | 027 | 23 | 17 | C | ETB | End Transmission Block | 01010111 | 127 | 87 | 57 | U | W |
| 00011000 | 030 | 24 | 18 | C | CAN | Cancel | 01011000 | 130 | 88 | 58 | U | X |
| 00011001 | 031 | 25 | 19 | C | EM | End of Medium | 01011001 | 131 | 89 | 59 | U | Y |
| 00011010 | 032 | 26 | 1A | C | SUB | Substitute | 01011010 | 132 | 90 | 5A | U | Z |
| 00011011 | 033 | 27 | 1B | C | ESC | Escape | 01011011 | 133 | 91 | 5B | P | [|
| 00011100 | 034 | 28 | 1C | C | FS | File Separator | 01011100 | 134 | 92 | 5C | P | \ |
| 00011101 | 035 | 29 | 1D | C | GS | Group Separator | 01011101 | 135 | 93 | 5D | P |] |
| 00011110 | 036 | 30 | 1E | C | RS | Record Separator | 01011110 | 136 | 94 | 5E | P | ^ |
| 00011111 | 037 | 31 | 1F | C | US | Unit Separator | 01011111 | 137 | 95 | 5F | P | ^ |
| 00100000 | 040 | 32 | 20 | S | SP | Space | 01100000 | 140 | 96 | 60 | P | ^ |
| 00100001 | 041 | 33 | 21 | P | ! | | 01100001 | 141 | 97 | 61 | LX | a |
| 00100010 | 042 | 34 | 22 | P | " | | 01100010 | 142 | 98 | 62 | LX | b |
| 00100011 | 043 | 35 | 23 | P | # | | 01100011 | 143 | 99 | 63 | LX | c |
| 00100100 | 044 | 36 | 24 | P | \$ | | 01100100 | 144 | 100 | 64 | LX | d |
| 00100101 | 045 | 37 | 25 | P | % | | 01100101 | 145 | 101 | 65 | LX | e |
| 00100110 | 046 | 38 | 26 | P | & | | 01100110 | 146 | 102 | 66 | LX | f |
| 00100111 | 047 | 39 | 27 | P | ' | | 01100111 | 147 | 103 | 67 | L | g |
| 00101000 | 050 | 40 | 28 | P | (| | 01101000 | 150 | 104 | 68 | L | h |
| 00101001 | 051 | 41 | 29 | P |) | | 01101001 | 151 | 105 | 69 | L | i |
| 00101010 | 052 | 42 | 2A | P | * | | 01101010 | 152 | 106 | 6A | L | j |
| 00101011 | 053 | 43 | 2B | P | + | | 01101011 | 153 | 107 | 6B | L | k |
| 00101100 | 054 | 44 | 2C | P | , | | 01101100 | 154 | 108 | 6C | L | l |
| 00101101 | 055 | 45 | 2D | P | - | | 01101101 | 155 | 109 | 6D | L | m |
| 00101110 | 056 | 46 | 2E | P | . | | 01101110 | 156 | 110 | 6E | L | n |
| 00101111 | 057 | 47 | 2F | P | / | | 01101111 | 157 | 111 | 6F | L | o |
| 00110000 | 060 | 48 | 30 | NX | 0 | | 01110000 | 160 | 112 | 70 | L | p |
| 00110001 | 061 | 49 | 31 | NX | 1 | | 01110001 | 161 | 113 | 71 | L | q |
| 00110010 | 062 | 50 | 32 | NX | 2 | | 01110010 | 162 | 114 | 72 | L | r |
| 00110011 | 063 | 51 | 33 | NX | 3 | | 01110011 | 163 | 115 | 73 | L | s |
| 00110100 | 064 | 52 | 34 | NX | 4 | | 01110100 | 164 | 116 | 74 | L | t |
| 00110101 | 065 | 53 | 35 | NX | 5 | | 01110101 | 165 | 117 | 75 | L | u |
| 00110110 | 066 | 54 | 36 | NX | 6 | | 01110110 | 166 | 118 | 76 | L | v |
| 00110111 | 067 | 55 | 37 | NX | 7 | | 01110111 | 167 | 119 | 77 | L | w |
| 00111000 | 070 | 56 | 38 | NX | 8 | | 01111000 | 170 | 120 | 78 | L | x |
| 00111001 | 071 | 57 | 39 | NX | 9 | | 01111001 | 171 | 121 | 79 | L | y |
| 00111010 | 072 | 58 | 3A | P | : | | 01111010 | 172 | 122 | 7A | L | z |
| 00111011 | 073 | 59 | 3B | P | ; | | 01111011 | 173 | 123 | 7B | P | { |
| 00111100 | 074 | 60 | 3C | P | < | | 01111100 | 174 | 124 | 7C | P | |
| 00111101 | 075 | 61 | 3D | P | = | | 01111101 | 175 | 125 | 7D | P | } |
| 00111110 | 076 | 62 | 3E | P | > | | 01111110 | 176 | 126 | 7E | P | ~ |
| 00111111 | 077 | 63 | 3F | P | ? | | 01111111 | 177 | 127 | 7F | C | DEL |

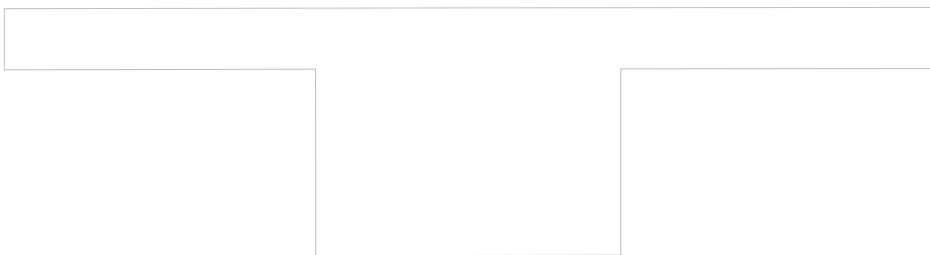
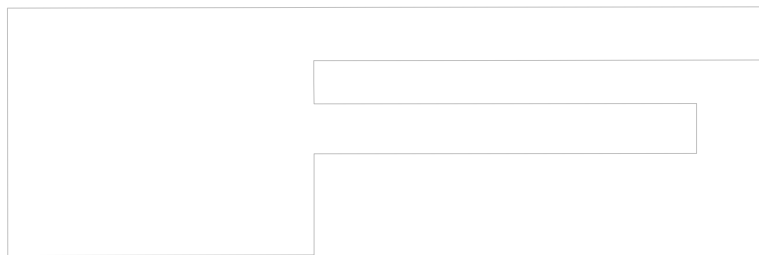
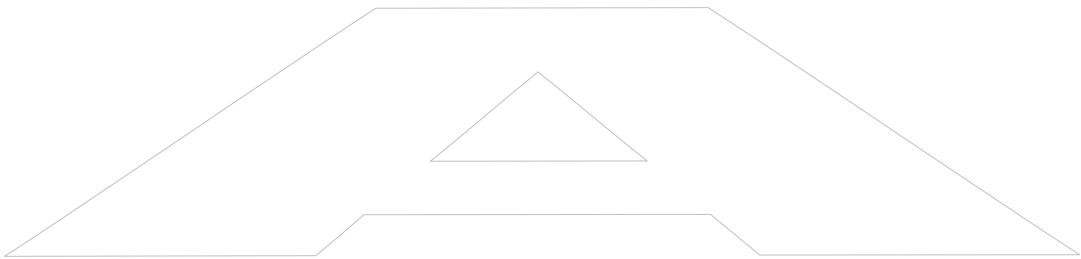
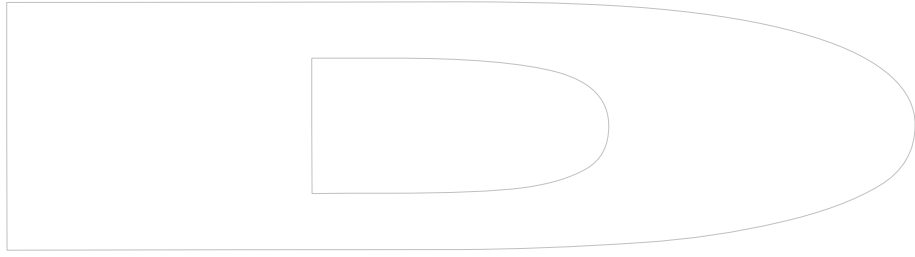

Appendix H - Specifications

Physical Properties

| | |
|------------------|-------------------|
| Weight | < 75g |
| Size (L x W x H) | 68mm x 42mm x 8mm |

Communication Protocols

| | |
|--|----------------------------------|
| Modem to radio network protocol | RD-LAP 3.1, 3.2, 3.3 and MDC 3.3 |
| Modem to terminal (e.g. handheld) protocol | NCL 1.2 |

Environmental Conditions

| | |
|-----------------------|----------------|
| Operating temperature | -30°C to +60°C |
| Storage temperature | -40°C to 70°C |
| Relative Humidity | 0 to 95% |

Ports

| | |
|---------------------|---|
| Data Interface Port | 3V logic serial port, 9600 baud |
| RF Connector | MMCX female, 50Ω. Straight connection or right angle |

LED Indicators

| | | |
|----------|-------|---|
| Power | Green | flashes when scanning On, when locked Off, when the Boomer-III is off |
| Transmit | Red | flashes when transmitting |
| Receive | Green | flashes when receiving |

Power

| | |
|-------------------------|---|
| Voltage | 3.8V nominal (3.4 to 4.8V range) |
| Transmit | < 1.6 A (2.2 A if mismatched antenna) |
| Receive | < 80 mA |
| Standby | < TBD mA (Add 1.2 mA if LED's enabled) |
| Off current consumption | 100 µA (nominal) |
| Transmit Duration | 32 ms (minimum) 7 seconds RD-LAP (maximum) 30% (maximum) Duty Cycle |
| Power Supply Ripple | < 15 mV peak to peak |

Synthesiser

| | |
|-----------------------------------|-------------------|
| Frequency range | 806 – 825MHz |
| Channel spacing | 25kHz |
| Frequency Error (-30° ~ +60°C) | ±1.5ppm (<1300Hz) |

Transmitter

| | |
|---------------------------------------|--|
| Frequency range | 806 – 825MHz |
| Channel spacing | 25kHz (19,2kbps data) 12.5kHz (9,6 kbps data) |
| Data rate | MDC 4.8kbps RDLAP 9.6kbps RDLAP 19.2kbps |
| Modulation | 2-Level FSK MDC 4.8 2.5kHz deviatio 4-Level FSK RDLAP 9.6 3.9kHz deviation 4-Level FSK RDLAP 19.2 5.6kHz deviation |
| RF output power (at 50Ω antenna port) | 2W nominal |
| Transmit Duty Cycle (over 5 min) | 10% default 30% (maximum) |
| Turn on time | < 5ms |
| Spurious emission | < - 30dBm |
| Adjacent channel power | < - 55dBc at 25kHz channels |

Receiver

| | |
|----------------------------------|--|
| Frequency range | 851 – 870MHz |
| Channel spacing | 25kHz (19,2kbps data) 12.5kHz (9,6 kbps data) |
| Sensitivity | < -113dBm at 5% PER RD-LAP 19.2 < -116dBm at 5% PER MDC |
| Spurious emission (receive mode) | < -57dBm |
| Channel selectivity | > 50dB (5kHz dev 1kHz tone) |
| Spurious rejection | > 70dB |
| Image rejection | > 60dB |
| RSSI Reading | -120dBm ~ -45dBm |

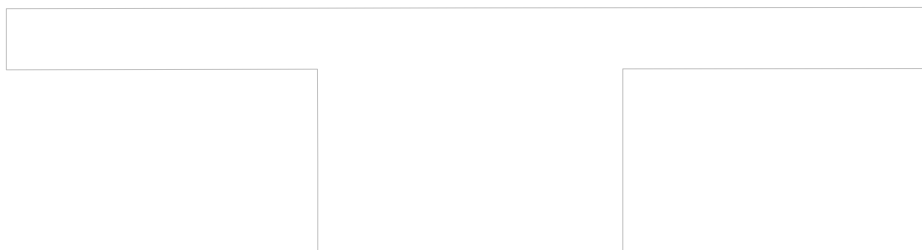

Appendix I - Glossary

| | |
|-----------------|--|
| ACK | Acknowledgment |
| ADC | Analog-to-digital converter |
| ALC | Automatic level control |
| ANSI | American National Standards Institute |
| AOC | Automatic output control |
| ASIC | Application-specific integrated circuit |
| ATE | Automatic test equipment |
| BGA | Ball grid array |
| BER | Bit error rate |
| BNC | A type of connector used with coaxial cable |
| Bps | Bits per second |
| BSC | Base station controller (for a network) |
| CCR | Type of miniature RF connector |
| CHRONOS | Enhanced pendulum IC |
| CLK | Clock |
| CMOS | Complementary metal oxide silicon |
| CNTL | Control |
| COM | Communications (port) |
| CPU | Central processing unit |
| CQA | Customer quality assurance |
| CNTL | Control (key) |
| CSA | California Safety Authority |
| DAC | Digital-to-analog converter |
| DB | Decibel |
| DBc | Decibels relative to carrier |
| DBm | Decibels mean; levels relative to 1 mW |
| DCD | Detailed circuit description |
| Debounce | Protection against feedback voltage |
| Desense | Loss of sensitivity from high ambient noise |
| DISC | Discriminator |
| DOS | Disc operating system |
| DTE | Data terminal equipment, the user device |
| DTR | Data terminal ready |
| DTU | Device under test |
| DVM | Digital volt meter |
| EEPROM | Electrically erasable, programmable read-only memory |
| EIA | Electronic Industries Association (U.S.) |
| EMA | Embedded memory access (mode) |
| EMI | Electromagnetic interference |
| EPC | File name suffix for modem configuration files |
| EPROM | Erasable, programmable, read-only memory |
| ERP | Effective radiated power |
| ESD | Electrostatic discharge |
| ESN | Electronic serial number |
| FCC | Federal Communications Commission (U.S.) |
| FET | Field effect transistor |
| FIFO | First in, first out |
| FNE | Fixed network equipment |
| FPC | Flexible printed circuit |

| | |
|---------------------|---|
| FracN | Fractional division synthesizer IC |
| FRU | Field-replaceable unit |
| FSK | Frequency shift keying |
| GaAs | Gallium arsenide, a semi-conducting material |
| GND | Ground |
| GPIB | A type of ATE interface |
| GTEM | Gigahertz transverse electromagnetic |
| HCT | High-speed CMOS technology |
| Host | The computer platform, or DTE directly connected to the modem |
| HP | Hewlett Packard |
| I/O | Input/Output |
| IB | Inbound |
| IC | Integrated circuit or Industry Canada |
| Inbound | Direction of wireless data originating from the host and/or modem to the fixed network equipment |
| IP | Internet protocol |
| IR | Infrared |
| LC | Inductor-capacitor |
| LED | Light-emitting diode |
| Li-ion | Lithium ion (battery technology) |
| LLI | Logical link identifier; unit ID |
| LNA | Low noise amplifier |
| MDC | Mobile data communications protocol (Motorola) |
| MFR | Multiple-frequency reuse |
| MPS | Maintenance Programming Software |
| NAK | Negative acknowledgment |
| NatSim | Native Mode Simulation (software utility) |
| NCL | Native Control Language (Motorola) |
| NiCad / NiCd | Nickel-cadmium (battery technology) |
| NiMH | Nickel-Metal-Hydride (battery technology) |
| NPN | Type of bipolar transistor |
| NSI | Network systems integration |
| OB | Outbound |
| OEM | Original Equipment Manufacturer |
| op-amp | Operational amplifier |
| OSMT | Type of miniature RF connector |
| Outbound | Direction of wireless data originating from the fixed network destined for either the host application(s) or the modem itself |
| PCA | Printed circuit assembly (populated board) |
| PCB | Printed circuit board (bare board) |
| PC Card | A PCMCIA product |
| PCMCIA | Personal Computer Memory Card International Association |
| PDA | Personal data assistant |
| PDU | Packet data unit |
| PIC | Personal information communicator |
| PLL | Phase-locked loop |
| p/n | Part number |
| PMIT | Packet modem integration test |
| POST | Power-on self test |
| Ppm | Parts per million |
| QFP | Quad flat pack |

| | |
|-----------------------|---|
| R&D | Research and development |
| RAM | Random-access memory |
| Rayleigh | A measure of multi-path fading depth of a signal |
| RC | Resistor-capacitor |
| RD-LAP | Radio Data-Link Access Procedure |
| RF | Radio frequency |
| RFI | Radio-frequency interference |
| RGxxx | Cabling designation number |
| RMA | Return material authorization |
| RNC | Radio network controller |
| RPM | Radio packet modem |
| RS-232 | The EIA standard for a serial data interface |
| RSSI | Received signal strength indicator |
| RTU | Radio Training Utility |
| Rx | Receive or reception |
| SAP0 | A specific service access point |
| SAR | Specific Absorption Rate |
| Schottky diode | A diode with low forward voltage drop and fast switching |
| SCR | Standard context routing |
| SDK | Software developer's kit |
| SDU | Service data unit |
| SFR | Single-frequency reuse |
| SINAD | Ratio (measured in dB) of signal to noise-plus-distortion |
| SMA | Sub-miniature connector |
| SMB | Sub-miniature connector |
| SNR | Signal-to-noise ratio |
| SPDT | Single pole, double throw (switch) |
| SPI | Serial peripheral interface |
| SRAM | Static random-access memory (static RAM) |
| TBD | To be determined |
| TNC | Industry standard connector type |
| Transorb | Transient absorber |
| TTO | Transmitter turn-on time |
| Tx | Transmit or transmission |
| UART | Universal asynchronous receiver / transmitter |
| UL | Underwriters Laboratories |
| VCC | Voltage common collector |
| VCO | Voltage controlled oscillator |
| VDD | Voltage direct drain |
| Vpp | Voltage peak to peak |
| VSWR | Voltage standing-wave ratio |
| WDG | Wireless Data Group (Motorola) |
| Wireline | Communications over a direct, physical link |
| XIP | Execute in place |
| ZIF | Zero insertion force |