

Waxess USA, Inc. DM1000



User Guide



Handset

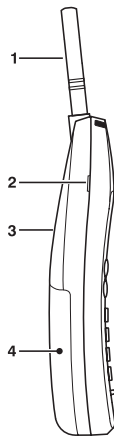

- 1 Antenna
- 2 Betclip attachment
- 3 Speaker for Ringer
- 4 Handset battery compartment

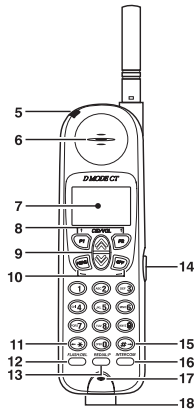
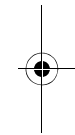
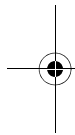

- 5 New Message LED
- 6 Handset Earpiece
- 7 LCD Display
- 8 Function Keys
- 9 Up/Down keys
- 10 Menu and Off keys
- 11 ← * Scroll Left
- 12 Flash/Delete key
- 13 Redial/Pause key
- 14 Headset Jack
- 15 # → Scroll Right
- 16 Intercom
- 17 Handset Microphone
- 18 Handset Charging Contacts



DM1000

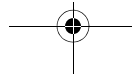

Base

- 19 Base Speaker/Ringer
- 20 LCD Display
- 21 Function Keys
- 22 Up/Down Keys
- 23 Menu and Off Keys
- 24 Intercom Key
- 25 Speaker Phone Key
- 26 Speaker Phone ON LED
- 27 Redial/Pause Key
- 28 New Message LED
- 29 Flash Key

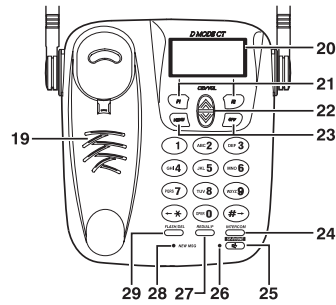

- 30 DC IN 9V Jack
- 31 TEL LINE Jack
- 32 Corded Handset Jack
- 33 Battery cover
- 34 Data Port Door (not for consumer use)

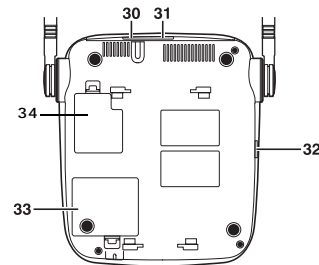

Contents

Get ready	1
Choose Location	1
Desk or Table	2
Wall mount	3
Base power on	4
Power backup batteries (Optional)	4
Standby Screen	6
Signal level meter	7
Optional antenna removal	7
Ready the cordless handset	8
Get set	11
Dialing mode	11
Time and date	12
Set the ringer tone	14
Set the ringer volume	15
Key beep	16
Area codes	16
Add/remove a 1	17
Add/remove area code	18
Language	18
LCD contrast	19
Name	19
Handset registration	19
Register	19
Deregister	20
GO!	21
CDMA Activation	21

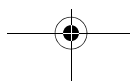
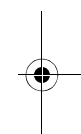
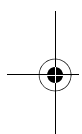

Make a wireless call 21

Make a landline call 22

Set earpiece volume 22

Calling options 23

Speed dial 23

Redial 23

Pause (for **TEL** line use only) 24

Answer a wireless call 24

Answer a landline call 25

In-Call operations 26

Place a call on Hold 26

Mute a call 26

Transfer a call 26

Set up a conference call 29

Phone book 29

Enter names and characters 30

Enter numbers directly 31

Edit names or numbers 32

Enter numbers from Caller ID 32

Call from phone book 34

Speed dial 34

Messages 34

Voice messages 34

Short Message Service (SMS) 36

More features 42

Caller ID 42

Caller ID information 42

Check the log 44

Dial a number 44

Save a number 44

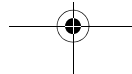
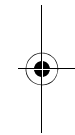
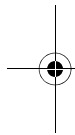

Delete a number 45

Call Forwarding 46

 Activate Call Forwarding 46

 Deactivate Call Forwarding 47

Page and Intercom 47

 Page 47

 Intercom 48

Two-line calling 49

Quick reference chart 50

Make two separate calls 51

Receive two separate calls 51

Call waiting with two calls 52

Barge-in 52

 Quick reference chart 54

 Set up Barge-In 55

 Use Barge-In 55

 Cellular only 56

 Set up Cellular only 56

 Turn off Cellular only 56

 CEL Phone Number 57

 Power back-up 57

Precautions 59

 Rechargeable Nickel-Metal-Hydride Battery Warn-
 ing 59

 Rechargeable Nickel-Metal-Hydride Batteries
 Must Be Recycled or Disposed of Properly . . . 60

 Important safety instructions 60

 Important Electrical Considerations 64

 The FCC Wants You To Know 64

 Range 65

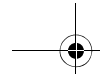

Telephone Line Problems 66
 Radio Interference 66
 More than One Cordless Telephone 67
 Cordless Telephone Privacy 68
 Installation Considerations 68
 Telephone Line Outlets 69
 Connecting the Telephone Cords 70
 Applying Power to the base 70
 I.C. Notice 71
 RADIO EQUIPMENT 72
 General information 73
 DM1000 Menu map 75

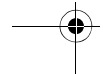
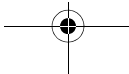
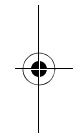
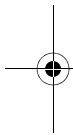

Get ready

1 Get ready

1

Included items

- Base
- Cordless handset
- AC adaptor for base
- AC adaptor for cordless handset
- Rechargeable battery for cordless handset
- Belt clip
- Wall mount bracket
- Telephone cord
- User guide

•Choose Location

Some important considerations:

- Charge the handset for 12–15 hours before use it.
- Locate the base near both a phone jack and a power outlet which is not controlled by a switch.
- Keep the base and handset away from sources of electrical noise, such as motors and fluorescent lighting.
- Leave enough room to raise both base antennas fully vertical.

1

Desk or Table

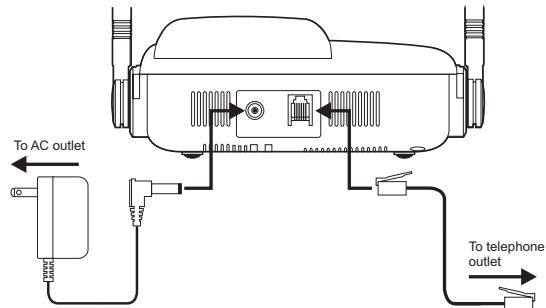

- 1 Connect the telephone line cord to the TEL LINE jack and to a telephone jack.
- 2 Set the base on a desk or table and place the handset on the base.
- 3 Connect the handset cord to the jacks on the handset and the base, then set the handset in the cradle.
- 4 Raise both antennas to a vertical position.
- 5 Find the base AC adaptor (the larger adaptor), and connect it to the DC IN 9V jack and to a standard 120V AC.

Get ready

Wall mount

- 1 Attach the wall mount adaptor to the base.

1

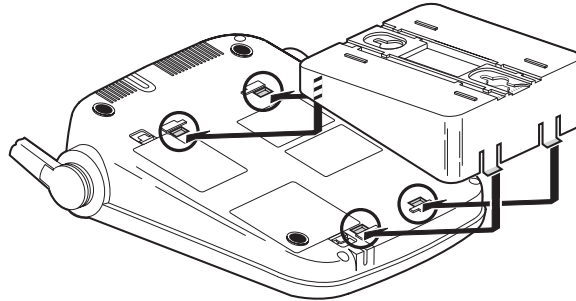

- 2 Find the base AC adaptor (the larger adaptor), plug the connector into the DC IN 9V jack, then plug the telephone line cord to the TEL LINE jack.
- 3 Wrap the AC adaptor inside the molded wiring channel, then wrap the cord around the strain relief notch.
- 4 Raise the antennas to a vertical position.
- 5 Align the mounting slots on the base with the mounting posts on the wall plate. Then push in and down until the phone is firmly seated.
- 6 Connect the handset cord to the jacks on the handset and base, then set the corded handset in the cradle.
- 7 On the base, remove the handset retainer, flip it over, then replace it.

1

Base power on

When powered on for the first time, the base goes through an initialization sequence.

Note: Do not use the phone until the initialization sequence is complete.

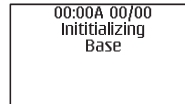

Power backup batteries (Optional)

The optional back-up batteries provide a reserve power supply so the base can operate for up to 30 minutes (depending on battery condition) in case of power outages or if power is cut off to the base for any reason. Backup power activates immediately when the normal power supply to the base is cut off.

- 1 Verify power is disconnected from the base.
- 2 Open the battery cover on the bottom of the base.

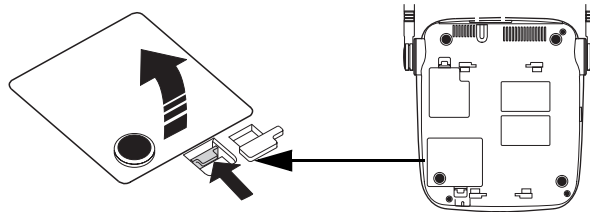

3 Insert five AA alkaline batteries with the polarity (+ and -) aligned as marked in the compartment.

4 Replace the cover.

Note:

- Batteries are not included
- Batteries are not required to operate the product
- There is no indication that shows when the base is operating with normal power or back-up power
- If you choose to install back-up batteries, check the power level frequently (see "Power back-up" on page 57). Replace the batteries when the power level is less than half of maximum
- After any power outage, check the battery power level and replace batteries as needed
- The battery power comes on automatically when current from the AC adaptor is interrupted; unplugging the AC adaptor does not turn off power to the phone
- Be sure to remove at least one battery when disconnecting power

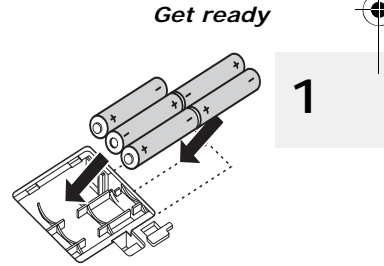

1

- The **Battery Level** indicator on the base menu screen may not show true battery condition unless all five batteries are installed

Caution: Use only AA alkaline batteries for power backup. Do not use rechargeable batteries. The battery compartment circuitry is not designed to recharge batteries.

Standby Screen

When the sequence is complete, the Standby Screen appears.

This screen appears on both the base and the handset, and is always visible when the phone is idle. At the bottom of the screen, the text indicates which service lines are active. **CEL** is wireless service, and **TEL** is landline service.



The **CEL** indicator may take up to two minutes to appear, depending on cellular signal conditions in your area.

If you have connected with your cellular service provider, the date and time may be set automatically. If not, see "Time and date" on page 12 to set the date and time manually.

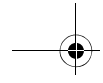

Get ready



Signal level meter

The Signal Level feature helps you find your strongest cellular service signal. Move the base around your location to find the strongest signal level.

MA 01/01
New: 00
Total: 00



Be sure the **CEL** indicator is shown in the display before checking the signal level.

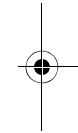
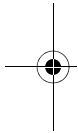

DM1000

7 Copyright © 2010 Waxess USA

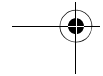
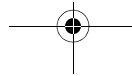

1

Ready the cordless handset

INSTALL THE BATTERY

1 Open the cover.

2 Verify that the connector is properly aligned with the jack and connect the battery.

Note: The connector is designed to easily fit the jack in only one direction. Do not use excessive force.

3 Close the cover.

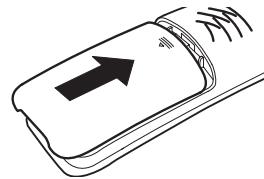
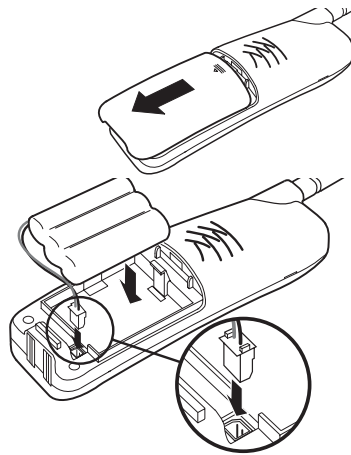

CHARGE THE BATTERY

- 1 Find the cordless handset AC Adaptor (the smaller adaptor, Model number HKD090050U).

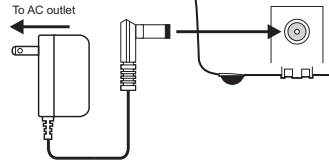

Get ready

1

Connect the AC adaptor to the DC 9V IN jack on the charger and to a standard 120V AC wall outlet.

- 2 Set the charger on a desk or table, then set the handset in the charger with the keypad facing forward.
- 3 Allow the battery to charge for 12–15 hours.

Note: Charge the battery frequently. Leaving the battery uncharged for a prolonged period can adversely affect battery charging capacity. If this happens, replace the battery.





A power indicator in the upper right corner of the LCD shows how much battery life remains.



2

Full charge



Low charge

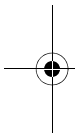

Note: Use only the rechargeable battery pack supplied with your cordless handset.

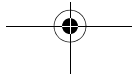
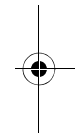

Get set

2 Get set

•Dialing mode

- 1 Press the **MENU** key on the base.

The Menu appears.



2

- 2 Press the **▼** key so the highlight bar moves to **Setup**.

This action is called "scrolling" throughout this guide.

- 3 Press **F1** to "select" this menu item.

This action is called "Press Select" throughout this guide.

Another menu list appears.

- 4 Press the **▼** key and scroll to **Tone/Pulse**.

- 5 Press **F1** to select this item and this screen appears.

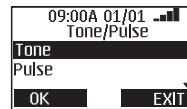

Highlight the correct setting for your phone system, then press **F1** to enter the setting in memory.

A beep confirms the setting, and the Setup menu appears.

- 6 Press **EXIT** to return to the main menu screen.
OR
Press **EXIT** twice or **OFF** to return to Standby.

2

The following steps apply to both the base and the handset.

•Time and date

The time and date automatically synchronizes with the cellular network once when the base is powered on (if supported by your service provider). If the time and date do not automatically synchronize with the network afterward it must be set manually.

- 1 Press **MENU**.
- 2 Use the **▲ / ▼** keys and scroll to **Time and Date**.
- 3 Press **Select**.
A cursor blinks on the hour number.
- 4 Use the keypad to enter the correct hour.
The cursor moves to the right for the minute numbers.
- 5 Enter the correct minutes, and press **OK**.
The AM/PM screen appears.
- 6 Use the **▲** or **▼** key to set AM or PM and press **OK**.

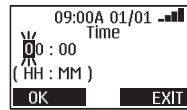

Get set

The time format setting appears.

- 7 Use the ▲ or ▼ key to set the time format and press **OK**.

The date screen appears with months showing.

- 8 Use the keypad to enter the correct month. After entering the month, the cursor moves to the day.
- 9 Enter the correct day then press **OK**. The cursor appears on the first digit of the current year setting.
- 10 Use the keypad to enter the four digits for the correct year and press **OK**. The date format appears.
- 11 Press ▼ or ▲ to select a format and press **OK**. You hear a confirmation tone and the Main menu appears.

2

When the time and date are set on the base or on one of the cordless handsets, the time and date for all other components (handset or base) automatically synchronize after a few minutes. If a new cordless handset is added and properly registered, the time and date for the new handset will automatically synchronize.

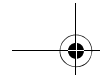

•Set the ringer tone

2

You can set different ring tones for CEL (wireless) calls and TEL (landline) calls.

- 1 Press **MENU**.
- 2 Scroll to **Ringer/Key Beep**, and press **Select**.
- 3 Scroll to **Ringer Tone**, and press **Select**.

The ringer tone menu for CEL calls appears first. The current ringer tone is highlighted.

The base has three ring tones available. The handset has six rings available—three tones and three melodies.

Note: Melodies are only available on the cordless handset.

- 4 Scroll through the list of tones. Pause on a tone name to hear a short sample of the tone. The sample plays two seconds for a ring tone and 10 seconds for a melody.
- 5 Press **Select**.
The **TEL Ring Tone** setting appears.
OR
Press **Exit** to cancel without saving changes.
- 6 Follow steps 1–4 above to choose a tone, and press **Select**.
A confirmation tone plays.

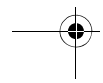
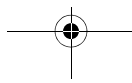
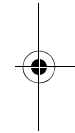
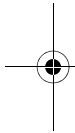

Get set

Set the ringer volume

You can set the ringer volume from menu. The choices are

Off-Low-Medium-High.

- 1 Press **MENU**, scroll to **Ringer/Key Beep**, and press **Select**.
- 2 Scroll to **Ringer volume**, and press **Select**.
The current ring volume setting is highlighted.
- 3 Scroll to a volume setting. Each time you stop on a setting a sample plays briefly.
- 4 Scroll to the ring volume you want and press **Select**.
A confirmation tone plays and the Ringer/Key beep menu appears.
- 5 Press **Exit** or **OFF** to return to the Standby screen.

2

NIGHT VOLUME

You can set the volume for the ringer to a lower level for night time between 9 p.m. and 6 a.m. based on the phone's internal clock.

- 1 Press **MENU**, scroll to **Ringer/Key Beep**, and press **Select**.
- 2 Scroll to **Night Volume** and press **Select**.
- 3 Use the **▲** or **▼** key to change the volume setting.

2

A sample of the volume level plays when you move the cursor. The sample plays two seconds for each ringer tone and 10 seconds for each melody.

- 4 Press **Select** to set the ringer.
A tone confirms the setting.

•Key beep

Set the phone so that you hear a beep each time you press a button, or turn off the beep feature.

- 1 Press **MENU**, scroll to **Ringer/Key Beep**, and press **Select**.
- 2 Scroll to **Key beep**, press **Select**, then choose **On** or **Off**.
- 3 Press **OK** to enter the setting.

A tone confirms the setting and the Ringer/Key beep menu appears.

•Area codes

Enter up to three area codes. With local area codes stored, the phone can distinguish between local and long distance calls.

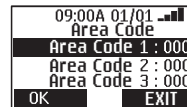

- 1 Press **MENU**.
- 2 Scroll to **Setup**, then press **Select**.
- 3 Scroll to **Area Code**, and press **Select**.

Get set

- 4 Use the keypad to enter the area code number, then press **OK**.
If you make a mistake, press **FLASH/DEL** to erase the last digit entered.
- 5 Press **OK** to set the code.
A beep confirms the setting and the Setup menu appears.
- 6 Press **Exit** or **OFF** to return to the Standby screen.

2

Add/remove a 1

With area codes stored in memory, the ***** and **#** keys have a unique function in phone memory dialing.

If you need to add a 1 to a 10-digit phone number for proper dialing in your area, press *****. Press ***** again to remove the number 1. When retrieving a number from the Caller ID log, use the ***** key to add or remove a 1. This feature is not available when using Redial.

Add/remove area code

2

If you need to add the area code to a 7-digit number, press **#** to display the area code list. Scroll to the correct area code, and press **OK**. At this point you can also press ***** to add the number 1, if needed.

To remove the area code, press ***** to remove the number 1 (if present), then press **#**.

Note: When dialing numbers from the Caller ID log, area codes stored in the phone are not accessible. Press **#** and use the keypad to add the area code. This feature is not available when using Redial.

•Language

1 Press **MENU**, scroll to **Setup**, and press **Select**.

2 Scroll to **Language**, and press **Select**.

The highlight bar shows the current language setting.

3 Scroll to the language you want, and press **Select**.

A beep confirms the setting and the Setup menu appears. The menu appears in the language you selected.

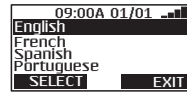

Get set

•LCD contrast

- 1 Press **MENU**, scroll to **Setup**, and press **Select**.
- 2 Scroll to **LCD Contrast**, and press **Select**.
- 3 Press **▲** to darken the display or **▼** to lighten the display.
- 4 Press **OK** to set the contrast.

2

•Name

Your phone arrives with the name "Base" preassigned to the base. Each handset receives a number (1–4) in the order of registration. You can assign a unique name to the base and even change the number and name assigned to a handset.

- 1 Press **MENU**, scroll to **Setup**, and press **Select**.
- 2 Scroll to **Name the Unit** and press **Select**.
- 3 Enter the name and press **Select**. See "Enter names and characters" on page 30.

A tone confirms the setting.

•Handset registration

Register

You can register up to three more handsets with the base. Each new cordless handset must be electronically registered with the base. The cordless handset included in this package is preregistered at the factory with the base. If it somehow becomes deregistered, use this procedure to reregister the handset.

2

- 1 On the handset, press **MENU**, scroll to **Setup** and press **Select**.
- 2 Scroll to **Register** and press **Select**.
The display shows "**Press and hold Intercom on base, then OK.**"
- 3 Press and hold **Intercom** (at least two seconds) on the base until you hear a beep.
- 4 Then, press **OK** on the handset.
Registration takes only a few seconds.

When registration completes, you hear a tone and this message appears on the LCD screen.

Registration
is
completed

Deregister

- 1 Press **MENU**, scroll to **Setup**, and press **Select**.
- 2 Scroll to **Deregister** and press **Select**.
A list of registered cordless handsets appears.
- 3 Scroll to the handset you want to deregister and press **Select**.
The confirmation message "**Delete registration?**" appears.
- 4 Press **YES** to confirm, or press **NO** to return to the previous screen.
When deregistration is complete, the confirmation message "**Handset 1 is deregistered**" appears.

GO!

3 GO!

•CDMA Activation

Please refer to the enclosed sheet for details on activating service with your cellular service provider.

2

•Make a wireless call

Cordless handset	Speakerphone on base	Corded handset on base
<ul style="list-style-type: none">•Press CEL•Enter number•Press CELOR•Enter number•Press CEL	<ul style="list-style-type: none">•Enter number•Press CEL	<ul style="list-style-type: none">•Lift handset off base•Enter number•Press CEL
<ul style="list-style-type: none">•To end the call, Press OFF	<ul style="list-style-type: none">•To end the call, press SP-PHONE or OFF	<ul style="list-style-type: none">•To end the call, replace the handset

Note: When making a wireless call, no dial tone is generated until the phone connects to the cellular network.

•Make a landline call

3

Cordless handset	Speakerphone on base	Corded handset on base
<ul style="list-style-type: none"> •Press TEL •Enter number OR <ul style="list-style-type: none"> •Enter number •Press TEL 	<ul style="list-style-type: none"> •Enter number •Press TEL 	<ul style="list-style-type: none"> •Lift handset off base •Enter number •Press TEL
<ul style="list-style-type: none"> •To end the call, Press OFF 	<ul style="list-style-type: none"> •To end the call, press SP-PHONE or OFF 	<ul style="list-style-type: none"> •To end the call, replace the handset

Set earpiece volume

ON CORDED HANDSET

During a call, move the selector switch to *L*, *M*, or *H*.

ON BASE SPEAKER PHONE

During a call, press ▲ for louder or ▼ for softer.

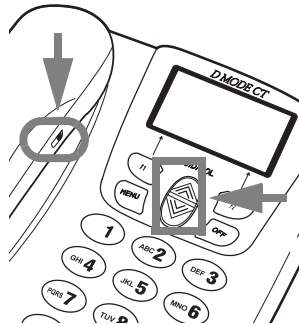

ON CORDLESS HANDSET DURING A CALL

Press ▲ for louder or ▼ for softer.

• Calling options

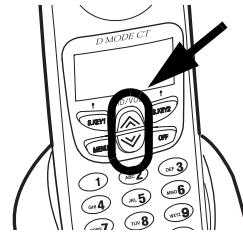

3

Speed dial

- 1 Set up keys 0–9 with numbers in the phone book for speed dial. See “Enter numbers directly” on page 31.
- 2 Press and hold the appropriate number key, then press **CEL** or **TEL**.

If you need to add or remove the number 1 or the area code for proper dialing in your area, see “Add/remove a 1” on page 17, or “Add/remove area code” on page 18.

Redial

The phone memory holds the last five numbers dialed. Each number can have up to 32 digits.

- 1 Press **REDIAL/P** to search through the numbers. In the upper left corner, the LCD shows a **C** if the call was on the cellular line or a **T** if the call was on the landline.
- 2 Press **CEL** or **TEL** to redial the number.

Pause (for TEL line use only)

While entering a phone number, press **REDIAL/P** to add a two second pause. The pause is added as the digits are transmitted when dialing. Press **REDIAL/P** again to make the pause longer. The letter **P** appears in the number each time you enter the pause.

3

Note:

- Pause is available only when using the **TEL** line. Pause may not be recognized as a valid number on the cellular network and calls may not connect.
- Pause is disabled when dialing on the **TEL** line as a second line, such as while the cellular line is connected to another call. Pause is also disabled during conference calls.

• Answer a wireless call

When the phone receives a wireless call:

- The base and all registered cordless handsets ring.
- The caller ID, if available, appears on the LCD screen.

GO!

Cordless handset	Speakerphone on base	Corded handset on base
•Press CEL	•Press CEL OR •Press SP-PHONE	•Lift handset off base
•To end the call, press OFF twice	•To end the call, press SP-PHONE or OFF	•To end the call, replace the handset

3

•Answer a landline call

- When the phone receives a landline call
- The base and all registered cordless handsets ring.
 - Caller ID, if available, appears on the LCD screen.

Cordless handset	Speakerphone on base	Corded handset on base
•Press TEL	•Press TEL OR •Press SP-PHONE	•Lift handset off base
•To end the call, press OFF twice	•To end the call, press SP-PHONE or OFF	•To end the call, replace the handset

• In-Call operations

Place a call on Hold

- Press **Hold** to place a call on hold.
- Press **Exit** to return to the call.

3

Mute a call

- Press **Mute** to temporarily cut off the microphone.
- Press **Unmute** to return to the call

Transfer a call

You can transfer calls between the base and the handsets, and from handset to handset. This function works for both cellular and landline calls.

BASE TO HANDSET TRANSFER

- 1 Press **Intercom**, scroll to the handset (or base) that you want and press **Page**.

The base and the handset involved in the transfer operation begin beeping (a different tone than with the Intercom function), and a message appears on the LCD.

If there is no answer within 60 seconds, the



GO!

page and the transfer are cancelled and you return to the call. You can press **Exit** to return to the call immediately.

- 2 Press **Answer** to take the transfer, or press **Exit** to reject the transfer.

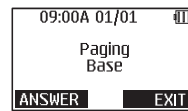

The call returns to the device that started the transfer - handset or base.

3

Note: When transferring between base and a handset, the caller is transferred immediately and is not put on hold.

- 3 Press **OFF** to end the call.

OR

Follow the steps above to transfer the call back to the base.

You can also use the HOLD function to start a transfer. During a call, press **HOLD**, select **Transfer**, then follow the steps above.

HANDSET TO HANDSET TRANSFER

- 1 During a call, press **Intercom**, scroll to the handset you want, and press **Page**.

The handset involved in the transfer operation begins beeping (a different tone than with the Intercom

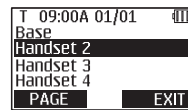

function) and a message appears on the LCD. If there is no answer within 60 seconds, the page and the transfer are cancelled and you return to the call. You can press **Exit** to return to the call immediately.

3

- 2 Press **Answer** on the handset receiving the page.

The call is now on hold, and the parties with the handsets can speak.

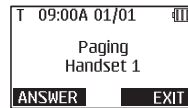

- 3 Press **Exit** on the handset that started the transfer.

The call is now transferred to the receiving handset.

On the receiving handset, you can press **OFF** or **Exit** to reject the transfer. Then, the call returns to the handset that started the transfer.

- 4 Press **OFF** to end the call.

You can also use the **HOLD** function to start a transfer. During a call, press **HOLD**, select **Transfer**, then follow the steps above.

GO!

Set up a conference call

Conference calling lets you make a call with two other participants. The phone places the third call with the service (cellular or landline) that is not being used. The Conference feature is available only with the cordless handset.

- 1 Make a normal call to the first participant.
- 2 Press **Hold**, scroll to **Initiate a call**, and press **Select**.
- 3 Enter the number of the next participant, and press **CEL** (or **TEL**).

3

When the other participant answers, you can speak privately without the other participant. Press **FLIP** to change between the participants. The LCD shows which line (**CEL** or **TEL**) is in use.

- 4 Press **CONF** to connect all participants.
- 5 To drop a participant from the conference call press **CEL DROP** or **TEL DROP**.
Press **OFF** to drop all participants and end the call.

•Phone book

Use the phone book to store up to 50 names and numbers.



Enter names and characters

Use the keypad to choose the characters you want. Each time you press a key, the letters on that key appear first as capital letters, then as lower case letters, then the number corresponding to that key.

3

keys	Number of times key pressed								
	1	2	3	4	5	6	7	8	9
①	1	!	“	*	#	\$	%	&	‘
	()	<	>	+	,	-	.	/
	:	;	?	@	\	=	^	_	‘
	~								
ABC 2	A	B	C	a	b	c	2		
DEF 3	D	E	F	d	e	f	3		
GHI 4	G	H	I	g	h	i	4		
JKL 5	J	K	L	j	k	l	5		
MNO 6	M	N	O	m	n	o	6		
PNR 7	P	Q	R	S	p	q	r	s	7
TUV 8	T	U	V	t	u	v	8		
WXYZ 9	W	X	Y	Z	w	x	y	z	9
SPACE 0	0	Space							

GO!

- Use  and  to scroll left or right.
- Press **Clear** to erase a character.

Enter numbers directly

- 1 Press **MENU**, scroll to **Memory**, and press **Select**.
- 2 Scroll to **Phone book**, and press **Select**.
- 3 Scroll to **Add new entry**, and press **Select**.
"Name?" appears in the display.
- 4 Use the letters on the keypad to enter the name (up to 16 characters) and press **OK**.
Press **OK** to leave **Name** blank.
"Number?" appears in the display.
- 5 Use the keypad to enter the number with area code and press **OK**.
The **Distinctive ring** setting appears.
This feature lets you add a special ring tone to phone numbers that you store in memory. During an incoming call, the phone compares the number to the distinctive ring list, and when it finds a match, the distinctive ring plays. Then, you can recognize a caller just from the type of ring tone you hear.
- 6 Scroll to **Ringer 1, 2, or 3, Melody 1, 2, or 3, or No setting** and press **OK**.
Melody tones are only available on the handset.
The **Speed Dial** screen appears.

3

- 7 Choose an empty Speed Dial key number and press **OK**.

A beep confirms the entry and the Standby screen appears.

Press **Skip** to complete the entry without registering it in Speed Dial.

3

Edit names or numbers

- 1 While in the phone book, scroll to **Find name** and press **Select**.
- 2 Scroll to the name you want to edit and press **Select**.
Call/Dial, **Edit**, **Delete**, and **Delete all** appear.
- 3 Use the **▲** or **▼** key to highlight **Edit** and press **Select**.
- 4 Edit the name.
OR, Press **OK** to skip to the number.
- 5 Edit the number if needed and press **OK**.
You hear a tone, **Complete** appears in the LCD and the list of names appears.

Enter numbers from Caller ID

- 1 While in the Caller ID log, scroll to the name/number you want to enter in the phone book and press **Select**.
Call/Dial, **Save**, **Edit**, and **Delete** appear.
- 2 Scroll to **Save** and press **Select**. "Name?" appears.

GO!

3 If the Caller ID shows a name, press **OK** to continue, or use the keypad to enter the name, then press **OK** to continue.

4 If the Caller ID shows a number, press **OK**. You can also use the keypad to enter a number, then press **OK**.

The **Distinctive ring** settings appear.

5 Scroll to the ringer tone or melody you want, and press **OK**.

The **Speed dial** setting appears.

6 Choose an empty Speed Dial key number, and press **OK**.

A beep confirms the entry and the Standby screen appears.

OR

7 Press **Skip** to complete the entry without registering it in Speed Dial.

A tone confirms the entry and **Complete** appears in the LCD. After a brief pause, the name and number you just entered appears.

8 Press **CEL** or **TEL** to make the call.

Press **OFF** to return to Standby.

Use the ***** and **#** keys to enter a 1 or area codes if needed for proper dialing in your area. See "Add/remove a 1" on page 17. Or "Add/remove area code" on page 18.

3

Call from phone book

- 1 Press **MENU**, scroll to **Memory**, and press **Select**.
- 2 Scroll to **Phone Book**, and press **Select**.
- 3 Scroll to **Find Name**, and press **Select**.
- 4 Scroll to the name you want to dial and press **Select**.
Four options appear on the LCD.
- 5 Scroll to **Call/Dial** and press **Select**.
The name and number appear in the LCD.
- 6 Press **CEL** or **TEL** to make the call.

3

Speed dial

For quick, one-button dialing, you can store up to 10 numbers in Speed Dial memory. See "Speed dial" on page 23.

•Messages

Note: You must have a subscription to use these message services. Check with your service provider for details.

Voice messages

The DM1000 works with both cellular and landline voicemail.

GO!

SET UP VOICEMAIL

- 1 Press **MENU**, scroll to **Setup**, and press **Select**.
- 2 Scroll to **Messages**, and press **Select**.
- 3 Scroll to **VoiceMail** setup, and press **Select**.
The message **VM Number (CEL)?** appears.
- 4 Use the keypad to enter the voicemail number for your cellular service provider, then press **OK**.
The message **VM number (TEL)?** appears.
- 5 Use the keypad to enter the voicemail number for your landline service, then press **OK**.
A beep confirms your entry.

3

CHECK VOICEMAIL MESSAGES

When new messages are waiting, the message LEDs on the base and the handset blink.

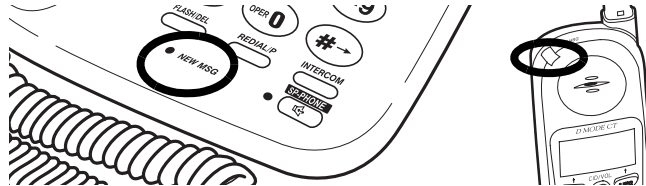

The LED blinks faster for a landline voicemail, slower for a cellular voicemail, and equally if there are messages for both landline and cellular.

- 1 Press **MENU**, scroll to **Messages**, and press **Select**.
- 2 Scroll to **VoiceMail** and press **Select**.

3 Scroll to the voicemail—**CEL Voicemail** or **TEL Voicemail**—with the message waiting and press **Select**.

To manage messages (such as saving, deleting, or forwarding), follow the commands for your specific voicemail system.

3 Short Message Service (SMS)

This feature—available only with cellular service—lets you send and receive text messages to other SMS enabled cellular phones through the CEL connection at the base or the cordless handset. Check with your service provider for availability.

The options available in SMS are:

- Write new
- Saved
- In Box
- Storage status

Note: Due to the data access process in the DM1000, the phone may not respond instantly when keys are pressed. This is normal operation, and any delay is no more than one or two seconds.

GO!

WRITE A NEW MESSAGE

- 1 Press **MENU**, scroll to **Messages**, and press **Select**.
- 2 Scroll to **SMS**, and press **Select**.
Write new is highlighted.
- 3 Press **Select**.
- 4 Use the keypad to write a message up to 160 characters long, including spaces and special characters. See "Enter names and characters" on page 30.)
- 5 When you finish writing, press **OK**.
The new message submenu appears with **Send**, **Edit**, **Save**.

3

If the phone receives a call or someone initiates a call on another handset while you are writing a message, the message is automatically stored in Saved messages. You can access the message later, edit the message, if needed, then send the message by following the steps below.

SEND A NEW MESSAGE

- 1 Write a message, then press **OK**.
Send, **Edit**, and **Save** appear.
- 2 Scroll to **Send**, and press **Select**.
Recipient No.? appears.
- 3 Enter the phone number of the recipient and press **OK**.



To send a message to a number that is stored in the phone book, press **MENU**, scroll to the entry you want, and press **Select**.

Note: Verify that the CEL line is not in use before sending the message.

A confirmation message appears. Then, the SMS menu appears. Press **EXIT** to return to the SMS main menu.

3

4 To save the message before exiting, follow the steps in "Save a new message."

The message is stored in Saved messages for easy viewing later.

OR

Press **No** to exit.

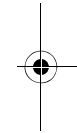
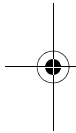

SAVE A NEW MESSAGE

- 1 After writing a message, press **OK**.
- 2 Scroll to **Save**, and press **Select**.

The message is stored in Saved messages for easy viewing later. Press **EXIT** to return to the SMS main menu.

VIEW SAVED MESSAGES

- 1 Press **MENU**, scroll to **Messages**, press **Select**.
- 2 Scroll to **SMS**, and press **Select**.
- 3 Scroll to **Saved**, and press **Select**.
- 4 Scroll to the message you want to read, and press **Select**.

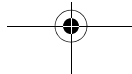

GO!

RECEIVE A MESSAGE

When the DM1000 receives a text message, you hear a distinctive ring tone and an envelope icon appears in the display. The message goes to the Inbox.

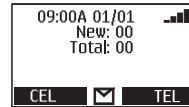

CHECK THE INBOX FOR READ AND UNREAD (NEW) MESSAGES

3

- 1 Press **MENU**, scroll to **Messages**, and press **Select**.
- 2 Scroll to **SMS**, and press **Select**.
- 3 Scroll to **Inbox**, and press **Select**.
- 4 Scroll to **UnRead Messages**, and press **Select**.
The phone number from which the message originated displays.
- 5 Press **Select** again to read the message.
If you have no unread messages, an error tone sounds.
OR
- 6 Scroll to **Read messages**, and press **Select**.
The phone number from which the message originated displays.
- 7 Scroll to the message you want to read, and press **Select**.

When you exit the Unread Messages list, any messages that have not been viewed are automatically stored in the Read Messages list. Be sure to view all unread messages before exiting the Unread Message list.

REPLY TO A MESSAGE

3

- 1 While reading a message, press **Select**.
- 2 Scroll to **Reply**, and press **Select**.

Write a reply the same way as you write a new message, press **OK**, then **Select** to send the message.

FORWARD A MESSAGE

- 1 While reading a message, press **Select**.
- 2 Scroll to **Forward** and press **Select**.
- 3 Enter the recipient's number and press **OK**.

To send to a number from the phone book, press **MENU**, scroll to the entry you want, and press **Select**.

Note: Forwarding a message can only be done through a CEL connection.

DELETE A MESSAGE

While reading a message, press **Select**, scroll to **Delete**, and press **OK**.

GO!

CALL THE MESSAGE SENDER

While viewing a message, press **Select**, scroll to **Call**, and press **Select**. The phone dials the number automatically on the cellular service.

CHECK SMS STORAGE STATUS

- 1 Press **MENU**, scroll to **Messages**, and press **Select**.
- 2 Scroll to **SMS**, and press **Select**.
- 3 Scroll to **Storage Status** and press **Select**.
The storage status appears.

3

The Storage status feature shows how many SMS messages are saved in memory or stored in the inbox. Storage capacity is limited, and there is no indication that the memory is full. When the message memory gets full, no more SMS messages can be received, so it is important to clear the memory frequently.

4 More features

•Caller ID

3

This feature helps identify incoming calls and requires subscription through your service provider. When Caller ID is active, your phone may display the caller's name and phone number if the landline or cellular service supports it.

Note: Caller ID and Call Waiting are usually included with cellular calling plans, but landlines may require a separate subscription. Check with your service provider for details.

Caller ID information

SINGLE CEL OR TEL CALL

In Standby, the Caller ID normally shows new and total calls received.

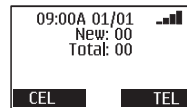

On a single incoming call, Caller ID shows the time and date, the caller's name, and the number. CEL or TEL blinks depending on the type of call—cellular service or landline.

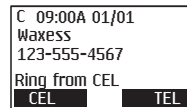

More features

SIMULTANEOUS CEL AND TEL CALL

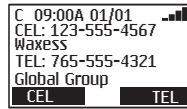

When both landline and cellular services are active, the phone can receive both types of calls at the same time or very close together. When that happens, Caller ID information for both calls appears in the display and the call arriving first is on top.

CALL WAITING

If you receive another call during a call in progress, information for both calls appears in the displays

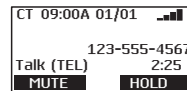

4

Call in progress

Press **FLASH/DEL** to answer the new call. Press **FLASH/DEL** again to return to the first call.

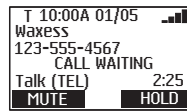

New call

If the current call is on the CEL line and another call arrives also on the CEL line, a "C" blinks in the display.

If the current call is on a CEL line and the new call is on the TEL line, the "C" remains solid, and the "T" indicator blinks.

If you receive a call waiting signal during the conference call, press **FLASH** to answer the call.

Check the log

The Caller ID log lists the name associated with the Caller ID data. If the data received does not have proper name data, the phone number is listed instead.

Press \blacktriangledown to scroll through the log from newest to oldest. Press \blacktriangle to scroll through the log from oldest to newest. The log holds up to 50 entries.

4 Dial a number

- 1 Scroll to a name/number displayed, and press **Select** twice.

The number appears in the display.

If the number's area code is the same as an area code stored in the phone memory (see "Area codes" on page 16), the area code may not appear. If the area code is required for dialing, press **#** to add the area code to the number. If the number 1 is also required for dialing, press ***** to add 1 to the beginning of the number.

- 2 Press **CEL** or **TEL** to make the call.

Save a number

- 1 Scroll to a name/number displayed, and press **Select**.

More features

- 2 Scroll to **Save**, and press **Select**.
- 3 Enter a name if needed (see "Enter names and characters" on page 30) and press **OK**.
- 4 Edit the number if needed and press **OK**.
The **Distinctive Ring** menu appears.
- 5 Scroll to the setting you want and press **OK**.
The **Speed Dial** menu appears.
- 6 Scroll to the speed dial number that you want for this new entry and press **OK**.
OR
Press **Skip** to exit. A tone confirms that the entry is stored in the phone book, and the name and number appear in the display.
- 7 Press **OFF** twice to return to Standby.

4

Delete a number

ONE BY ONE

- 1 Press ▼ to scroll through the log from newest to oldest. Press ▲ to scroll through the log from oldest to newest.
- 2 Stop on the number you want, press **Select**.
- 3 Scroll to **Delete**, and press **Select**.
A confirmation message appears.
- 4 Press **Yes** to delete the number.
A tone confirms your choice and the Caller ID log appears.

OR
Press **NO** and the Caller ID menu appears.

DELETE ALL

- 1 Press **▼**, then press **Select**.
- 2 Scroll to **Delete ALL** and press **Select**.
A confirmation message appears.
- 3 Press **YES** to delete all data from the Caller ID log.

OR
Press **NO** and the Caller ID menu appears.

4

•Call Forwarding

This feature lets you redirect an incoming call to another telephone number.

Activate Call Forwarding

- 1 Press **Menu**, scroll to **Set Up** and press **Select**.
- 2 Scroll to **Call Forwarding** and press **Select**.

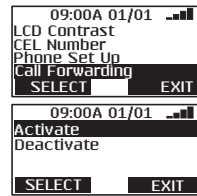

- 3 Select **Activate**.

More features

- 4 Enter the telephone number to which you want to direct the call and press **OK**, or press **Clear** to erase the number. **Complete** appears to confirm your selection.

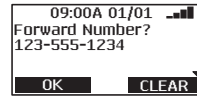

- 5 **Forward FCN ON** displays in the LCD.

NOTE: To avoid missing calls, follow the steps below to deactivate Call Forwarding when no longer needed.

Deactivate Call Forwarding

- 1 Press **Menu**, scroll to **Set Up** and press **Select**.
- 2 Scroll to **Call Forwarding** and press **Select**.
- 3 Select **Deactivate**. **Complete** appears to confirm your selection.

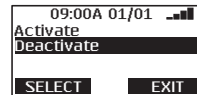
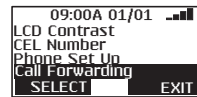

4

•Page and Intercom

Page

The Page feature lets you locate the handset if it is misplaced, but it also can be answered by the handset. Page can be initiated by the base or the cordless handset.

- 1 Press **INTERCOM** on the base, scroll to the handset you want to page, and press **PAGE**.

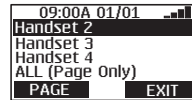

OR

To send a page to all registered handsets, select **All** and press **PAGE**. The Page All feature is only available at the base.

The handset beeps up to 60 seconds, and **Paging Base** appears in the display.

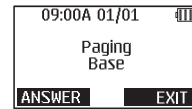

4

- 2 On the handset receiving the page, press **ANSWER** to connect with the base.
On Intercom appears in the display.
- 3 Press **Exit** to stop the page without connecting to the paging party through the Intercom.
For Page All, the page stops when any handset responds to the page. Intercom is not available for Page All.

Intercom

The Intercom feature is available on the handset and the base.

- 1 Press **INTERCOM**, scroll to the handset you want (or base), and press **PAGE**.

The handset or base beeps up to 60 seconds

More features

and **Paging Handset 1** (or **2**, **3**, or **4**) appears in the display.

2 To answer:

- On the handset, press **ANSWER** to connect with Intercom.
- On the base, lift the corded handset, press **ANSWER**, or press **SP-PHONE** to connect with the Intercom.

During an Intercom connection, use Mute to turn off the microphone at the base or on the handset.

Note: While using **INTERCOM**, an incoming call from the **CEL** line automatically terminates the **INTERCOM** connection. An incoming call from the **TEL** line will not terminate the **INTERCOM** connection unless the call is answered by the base or any handset.

4

• **Two-line calling**

The Dual Mode Communication Terminal is a two-line phone that offers unique calling features because it can be used to make or receive two separate calls at the same time; one call on the landline (TEL) service and the other on the cellular (CEL) service.

Quick reference chart

4

When calling on:	Line	Second call can be made:	
		Using	Line:
Base	Cellular	Any cordless handset	Landline
Cordless handset	Cellular	Base	Landline
Cordless handset	Cellular	Any remaining cordless handset	Landline
Base	Landline	Any remaining cordless handset	Cellular
Cordless handset	Landline	Base	Cellular
Cordless handset	Landline	Any remaining cordless handset	Cellular

More features

Make two separate calls

- 1 Use the base (corded handset or speakerphone) to place a call—for example, a landline (TEL) call (see “Make a landline call” on page 22).
- 2 Place a cellular (CEL) call, for example, with a handset that is not in use (see “Make a wireless call” on page 21).

- The display on any handset or base not in use shows **XXX in use**; XXX means base or handset in this case.

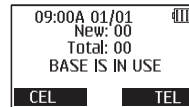

4

- The two calls are completely separate and cannot be conferenced.
- If Barge-In is on (see “Barge-in” on page 52), and the first call is made from a cordless handset on a landline, other handsets can join the call by pressing TEL; but the base can not join the call.

Receive two separate calls

- 1 When a call comes in—for example, a landline (TEL) call, answer it normally. In this example, use the corded handset on the base. See “Answer a landline call” on page 25.
- 2 If a cellular (CEL) call comes in, use a cordless handset and press CEL to answer it.

Remember that the corded handset and the speakerphone on the base cannot be used at the same time.

Call waiting with two calls

4

- 1 While a call is in progress (as in the above example) and the landline (TEL) receives another call, **Call waiting** appears in the display and any other cordless handsets not in use will ring.
- 2 To answer the call, press **FLASH/DEL** on the base, or **TEL** on any handset not in use.
If the new call comes in on a different line, press the appropriate key (CEL or TEL) regardless of whether you are using the base or a handset.

•Barge-in

After placing a landline (TEL) call with a cordless handset, this feature allows up to three other registered cordless handsets to join the call. Before using the Barge-In feature, read the following information.

- The D-Mode CT comes with the Barge-In feature set to off—it must be activated before use.
- If power to the base is interrupted, Barge-In must be reactivated.
- The first cordless handset to place the call is the

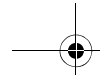

More features



“master” and fully controls the call. Other registered handsets that join the call are “slaves” and can only join or exit the call.

- Barge-In works only for cordless handsets during a landline (TEL) call and is not operable on the base.

Note: Remember that with Barge-In activated, privacy may be compromised. Any registered handset can join the call, but there is no indication that another handset joined the call.

4

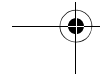
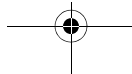
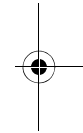
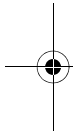

Quick reference chart

4

When calling on:	Line	Second call can be made: Using: Line:	
Base ¹	Cellular	• 1 or more cordless handsets	Landline ^{2,4}
1 cordless handset	Cellular	• Up to 3 cordless handsets • base	Landline ^{2,3,4}
2 or more cordless handsets	Cellular	Not available ⁵	
Base	Landline	• 1 cordless handset	Cellular ^{2,4}
1 cordless handset	Landline	• 1 cordless handset • base	Cellular ^{2,4}
2 or more cordless handsets	Landline	• 1 cordless handset • base	Cellular ^{2,4}

Notes: See next page.

More features

- 1 Base includes the speakerphone and corded handset.
- 2 In Barge-In mode, Page/Intercom between base and cordless is disabled during a call.
- 3 Conference call feature disabled for CEL and TEL
- 4 Call transfer disabled
- 5 Use of two or more cordless handsets on cellular line is only available in Cellular Only mode.

Set up Barge-In

4

- 1 Press **MENU**, scroll to **Setup**, and press **Select**.
- 2 Scroll to **Barge-In** and press **Select**.
- 3 Scroll to **ON**, and press **OK**.
A tone confirms the choice and the Setup menu appears.
- 4 Press **Exit** twice to return to Standby.

Use Barge-In

- 1 Verify that Barge-In is activated, then use one handset to place a call.
- 2 After the call is answered, press **TEL** on any handset to join the call.

•Cellular only

When activated on the base, the Cellular Only mode enables up to four cordless handsets to join in a conference call on the cellular line (CEL) call. Activating Cellular Only automatically deactivates the landline, so the TEL icon on the LCD does not appear.

4

- 1 Disconnect the telephone cord from the base.
- 2 Press **MENU**, scroll to **Setup**, and press **Select**.
- 3 Scroll to **Cellular Only**, and press **Select**.
- 4 Scroll to **On**, and press **Select**.

A tone confirms the choice, and the Setup menu appears.

Note: With Cellular Only activated, privacy may be compromised. Any registered cordless handset can join the call, but there is no indication that another handset has joined the call.

Turn off Cellular only

If landline services are needed, deactivate this feature first.

- 1 Press **MENU**, scroll to **Setup**, and press **Select**.

More features

- 2 Scroll to **Cellular Only**, and press **Select**.
- 3 Scroll to **Off**, and press **Select**.
A tone confirms the choice, and the **Setup** menu appears.
- 4 Connect the telephone cord.

• **CEL Phone Number**

Use this feature to see your **CEL** telephone number.

- 1 From the Stand-by mode, check the display to ensure that the **CEL** mode is active.
CEL should appear in the lower left corner of the display.
- 2 Press **MENU**, scroll to **Setup**, and press **Select**.
- 3 Scroll to **CEL Phone Number** and press **Select**.
The cellular number appears on the screen.
- 4 To exit, press **Exit** or **Off**.

4

• **Power back-up**

Power back-up for the base is an optional feature (not required to operate this product) that allows the base to operate for up 30 minutes even (depending on battery condition) if AC power is disrupted. If you install batteries for the Power Back-up feature you can check the condition of the batteries while they are installed.

- 1 On the base, press **MENU**, scroll to **Setup**, and press **Select**.
- 2 Scroll to **Battery Level**, and press **Select**.
Current power level for the batteries appears.
If no batteries are installed, the level indicates "Replace."

OK



Replace



4

- 3 Press **Exit** to return to the Setup menu.

Notes about Power Back-up

- Use new batteries.
- There are no indicators to inform you when the phone is operating under regular power or backup power.
- If you disconnect the AC power adaptor, Power Back-up starts automatically.
- Check battery levels frequently, and replace the batteries if the charge level drops below one half of fully charged.
- After every power outage, check the batteries and replace them as needed.
- Actual operating time using Power Back-up varies depending on the condition of the batteries.



Precautions



5 Precautions

Before you read anything else, please observe the following precautions.

Warning!

Waxess USA, Inc. DOES NOT represent this unit to be waterproof. To reduce the risk of fire, electrical shock, or damage to the unit, DO NOT expose this unit to rain or moisture.

Rechargeable Nickel-Metal-Hydride Battery Warning

- This equipment contains a rechargeable Nickel-Metal-Hydride battery.
- Nickel is a chemical known to state of California to cause cancer.
- The rechargeable Nickel-Metal-Hydride battery contained in this equipment may explode if disposed of in a fire.
- Do not short-circuit the battery.
- Do not charge the rechargeable Nickel-Metal-Hydride battery used in his equipment in any charger other than the one designed to charge this battery as specified in the owner's manual. Using another charger may damage the battery or cause the battery to explode.

5

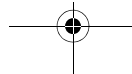
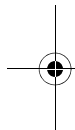

Rechargeable Nickel-Metal-Hydrate Batteries Must Be Recycled or Disposed of Properly



The exclamation point within an equilateral triangle is intended to alert the user to the presence of important and maintenance (servicing) instructions in the literature accompanying the appliance.

5

• Important safety instructions

When using your telephone equipment, these basic safety precautions should always be followed to reduce the risk of fire, electrical shock, and injury to persons:

- 1 Read and understand all instructions.
- 2 Follow all warnings and instructions marked on the product.
- 3 Unplug this product from the wall outlet before cleaning. Use a dry cloth for cleaning without liquid or aerosol cleaners.
- 4 Do not use this product near water; for example, near a bathtub, wash bowl, kitchen sink or laundry tub, in a wet basement, or near a swimming pool.
- 5 Do not place this product on an unstable cart,

Precautions

- stand, or table. The telephone may fall, causing serious damage to the unit.
- 6 Slots and openings in the cabinet and the back or bottom are provided for ventilation. To protect the product from overheating, these openings must not be blocked or covered. This product should never be placed near or over a radiator or heat register. This product should not be placed in a built-in installation unless proper ventilation is provided.
 - 7 This product should be operated only from the type of power source indicated on the marking label. If you are not sure of the type of power supply to your home, consult your dealer or local power company.
 - 8 Do not allow anything to rest on the power cord. Do not locate this product where the cord will be damaged by persons walking on it.
 - 9 Do not overload wall outlets and extension cords, as this can result in the risk of fire or electrical shock.
 - 10 Never push objects of any kind into this product through cabinet slots, as they may touch dangerous voltage points or short out parts that could result in a risk of fire or electric shock. Never spill liquid of any kind on the product.
 - 11 To reduce the risk of electric shock, do not disassemble this product. Take it to qualified service personnel when service or repair work is required. Opening or removing covers may

5



expose you to dangerous voltages or other risks. Incorrect reassembly can cause electric shock when the appliance is subsequently used.

12 Unplug this product from the wall outlet and refer servicing to qualified service personnel under the following conditions:

- A When the power supply cord is damaged or frayed.
- B If liquid has been spilled into the product.
- C If the product has been exposed to rain or water.
- D If the product does not operate normally when following the operating instructions. (Adjust only those controls that are covered by the operating instructions. Improper adjustment of other controls may result in damage and will often require extensive repair work by a qualified technician.)
- E If the product has been dropped or the cabinet has been damaged.
- F If the product exhibits a distinct change in performance.

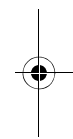
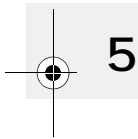

13 Do not use the telephone to report a gas leak in the vicinity of the leak.

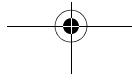

Precautions

ADDITIONAL BATTERY SAFETY PRECAUTIONS

Caution: To reduce the risk of fire or injury to persons by the battery, read and follow these instructions:

- 1 Use only the battery pack specified in the owner's manual.
- 2 Do not dispose of the battery pack in a fire. The cell may explode. Check the Nickel Metal Hydride battery disposal package insert for disposal instructions.
- 3 Do not open or mutilate the battery pack. Released electrolyte is corrosive and may cause damage to the eyes or skin. It may be toxic if swallowed.
- 4 Exercise care in handling the battery in order not to short the battery with conducting materials such as rings, bracelets, and keys. The battery or conductor may overheat and cause burns.
- 5 Charge the battery pack provided with or identified for use with this product only in accordance with the instructions and limitations specified in the owners manual provided for this product.
- 6 Observe proper polarity orientation between the battery pack and battery charger.

5

SAVE THESE INSTRUCTIONS!



Important Electrical Considerations

Unplug all electrical appliances when you know an electrical storm is approaching. Lightning can pass through your household wiring and damage any device connected to it. This phone is no exception.

The FCC Wants You To Know

Changes or modifications to this product not expressly approved by Waxess, or operation of this product in any way other than as detailed by the owner's manual, could void your authority to operate this product. our telephone complies with Part 68 of FCC Rules. You must, upon request, provide the FCC registration number and the REN to your telephone company. Both numbers are on the base unit.

5

Note: You must not connect your phone to:

- coin-operated systems
- most electronic key telephone systems

This device complies with FCC rules for operating in the CDMA band. Operation is subject to the following two conditions: (1) This device may not cause harmful interference, and (2) This device must accept any interference received, including

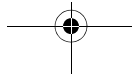

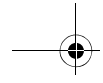

Precautions



interference that may cause undesired operation. Privacy of communications, may not be ensured when using this phone.

To insure the safety of users, the FCC has established criteria for the amount of radio frequency energy various products may produce depending on their intended usage. This product has been tested and found to comply with the FCC's exposure criteria. For body worn operation, the FCC RF exposure guidelines were also met when used with the accessories supplied or designed for this product. Use of other accessories may not ensure compliance with FCC RF exposure guidelines and should be avoided.

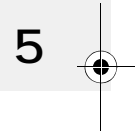
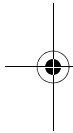

Range

Your new phone is designed to achieve the maximum possible range by transmitting and receiving according to the highest specifications set forth by the FCC. We have rated this phone to operate at a maximum distance with the qualification that the range depends upon the environment in which the telephone is used. Many factors limit range, and it would be impossible to include all the variables in our rating. The Maximum Range rating of this phone is meant to be used as a means of comparison against other range claims.

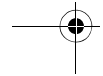
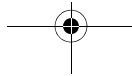



Telephone Line Problems

The FCC has granted the telephone company the right to disconnect service in the event that your phone causes problems on the telephone line. Also, the telephone company may make changes in facilities and services which may affect the operation of your unit. However, your telephone company must give adequate notice in writing prior to such actions to allow you time for making necessary arrangements to continue uninterrupted service. If you are having trouble with your telephone service, you must first disconnect your phone to determine if it is the cause of your problem. If you determine that it is the cause, you must leave it disconnected until the trouble has been corrected.

5

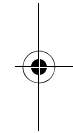

Radio Interference

Radio interference may occasionally cause buzzing and humming in your cordless handset, or clicking noises in the base. This interference is caused by external sources such as TV, refrigerator, vacuum cleaner, fluorescent lighting, or electrical storm. Your unit is NOT DEFECTIVE. If these noises continue and are too distracting, please check around your home to see what appliances may be causing the problem. In addition, we recommend that the base not be plugged into a circuit that also

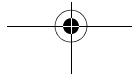

Precautions

powers a major appliance because of the potential for interference. Be certain that the antenna on the unit is fully extended when needed. In the unlikely event that you consistently hear other voices or distracting transmissions on your phone, you may be receiving radio signals from another cordless telephone or other source of interference. If you cannot eliminate this type of interference, you need to change to a different channel. Finally, it should be noted that some cordless telephones operate at frequencies that may cause interference to nearby TVs and VCRs. To minimize or prevent such interference, the base of the cordless telephone should not be placed near or on top of a TV or VCR. If interference is experienced, moving the cordless telephone farther away from the TV or VCR will often reduce or eliminate the interference.

5

Cordless Telephone Privacy

Cordless telephones are radio devices. Communications between the handset and base of your cordless telephone are accomplished by means of radio waves which are broadcast over the open airways. Because of the inherent physical properties of radio waves, your communications can be received by radio receiving devices other than your own cordless telephone unit. Consequently, any communications using your cordless telephone may not be private.

Installation Considerations

SELECTING A LOCATION

Before choosing a location for your new phone, there are some important guidelines you should consider:

- The location should be close to both a phone jack and continuous power outlet. (A continuous power outlet is an AC outlet which does not have a switch to interrupt its power.)
- Keep the base and handset away from sources of electrical noise such as motors or fluorescent lighting.
- Be sure there is sufficient space to fully extend the base antenna.
- The base can be placed on a desk or tabletop or mounted on a standard telephone wall plate.
- You should charge your new phone for 12–15 hours before completing the installation or using the handset.

5

Telephone Line Outlets

There are two types of phone outlets:

Modular Jack

Most phone equipment available now uses modular jacks. Phone cords are fitted with a molded plastic connector which plugs into this type of jack. If you

Precautions

do not have modular phone jacks, contact your local telephone company for information about their installation.

Hardwired Jack

Some equipment is wired directly to a phone jack, and these types of installations require a modular jack converter. This type of installation is not difficult; however, you should contact your telephone dealer or a telephone supply store for advice about the proper adapter or converter for your particular situation.

Connecting the Telephone Cords

5

Consider these safety guidelines before connecting the telephone cords:

Caution:

- Never install telephone wiring during a lightning storm.
- Never touch uninsulated telephone wires or terminals unless the telephone line has been disconnected.
- Use caution when installing or modifying telephone lines.



Applying Power to the base

This phone requires an AC outlet, without a switch to interrupt power, and the included AC adapter. To relieve strain on the DC plug when the phone is placed on a desk or table, wrap the power cord around the strain relief notch on the bottom of the base.

Note: Place the power cord so that it does not create a trip hazard, or where it could become chafed and create a fire or other electrical hazards.

5

•I.C. Notice

TERMINAL EQUIPMENT

Notice: This equipment meets the applicable Industry Canada Terminal Equipment Technical Specifications. This is confirmed by the registration number. The abbreviation, IC, before the registration number signifies that registration was performed based on a Declaration of Conformity indicating that Industry Canada technical specifications were met. It does not imply that Industry Canada approved the equipment.

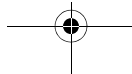

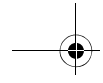

Precautions

Notice: The Ringer Equivalence Number (REN) for this terminal equipment is marked on the equipment itself. The REN assigned to each terminal equipment provides an indication of the maximum number of terminals allowed to be connected to a telephone interface. The termination on an interface may consist of any combination of devices subject only to the requirement that the sum of the Ringer Equivalence Numbers of all the devices does not exceed five.

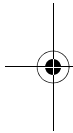

RADIO EQUIPMENT

5

The term "IC" before the radio certification number only signifies that Industry Canada technical specifications were met.

Operation is subject to the following two conditions: (1) this device may not cause interference, and (2) this device must accept any interference, including interference that may cause undesired operation of the device. "Privacy of communications may not be ensured when using this telephone."

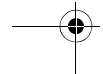
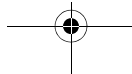

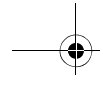

Notes:

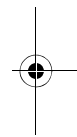
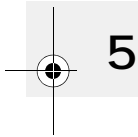

DM1000

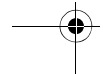
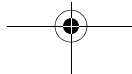

General information

6 General information

This phone complies with FCC Parts 15 and 68.

AC Adaptor Information:

Base: Input voltage 120V AC, 60Hz. 0.3A
Output voltage 9V DC, 1000 mA

Charger Handset Charging Cradle
Input voltage 120V AC, 60 Hz, 0.15A
Output voltage 9V DC, 500 mA

Battery Information: Ni-MH, 3.6V, 1300mA

Frequency: CDMA 800/1900 MHz

Handset/ Base 2.4GHz

Weight: Handset 4.9 oz. (without battery)
7.3 oz. (with battery)

Base 1 lb., 13.7 oz. with corded handset

Dimensions:

Handset 6-3/4" x 2" x 1-1/4" (height, width, depth)

Base 3-1/4" x 7-3/4" x 7-7/8" (height, width, depth)

FCC ID Number SNBDM1000CE/SNBDM100HS

Specifications, features, and availability of optional accessories are all subject to change without prior notice.

Approved patents: 6,766,175/6,987,988/7,072,675/7,010,311/7,146,180

Patents pending: 11/234.297, 11/542.804, 11/593.725, 11/141.819

Notes

DM1000

73 Copyright © 2010 Waxess USA

6

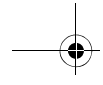

Notes



6

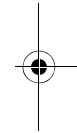

DM1000

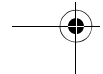
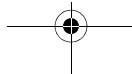

DM1000 Menu map

7 DM1000 Menu map

BASE

Messages

- Vicemail
- Vicemail Setup
- SMS
 - Write New
 - Saved
 - In Box
 - Storage Status

Memory

- Phone book
 - Find name
 - Add new entry
- Caller ID

Ringer/Key Beep

- Ringer tone
- Ringer Volume
- Night Volume
- Key Beep

Setup

- Distinctive Ring
- Area Code
- Language
- Name the Unit
- Tone/Pulse
- Barge-In
- Battery Level
- Cellular Only
- LCD Contrast
- CEL Phone Number
- Phone Set Up
- Enter SPC

Call Forwarding

- Activate
- Reactivate

Time and Date

CORDLESS HANDSET

Messages

- Vicemail
- Vicemail Setup
- SMS
 - Write New
 - Saved
 - In Box
 - Storage Status

Memory

- Phone book
 - Find name
 - Add new entry
- Caller ID

Ringer/Key Beep

- Ringer tone
- Ringer Volume
- Night Volume
- Key Beep

Setup

- Distinctive Ring
- Area Code
- Language
- Name the Unit
- Register
- Deregister
- LCD Contrast
- TTY

7



Notes

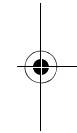
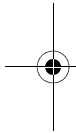

7



DM1000

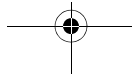

Index

A		battery indicator 10	
Call Forwarding		charge the battery 9	
Activate	46	install batteries 8	
B		D	
barge-in	52	Call Forwarding	
quick reference		Deactivate	47
chart.....	54	distinctive ring 31, 33	
set up	55	H	
use	55	hold	26
base unit batteries	4	I	
C		included items	1
call		intercom	48
answer landline	25	L	
answer wireless	24	location	1
conference call	29	desk or tabletop	2
make landline call	22	wall mount	3
make wireless call ...	21	M	
Call Forwarding	46	Menu Map	75
caller ID	42	messages	
delete number	45	SMS	34
dial number	44	check inbox	39
information	42	delete a message .	40
save number	44	forward	40
CEL phone number	57	memory status	41
cellular only	56	receive	39
set up	56	reply	40
turn off	56		
cordless handset	8		

save a new message 38
send 37
send a new message 37
write 37
voice messages 34
check voicemail ... 35
set up 35
mute 26

P
page 47
pause 24
phone book 29
call from phonebook 34
enter characters 30
enter numbers 31
phonebook distinctive ring 31
edit names and numbers 32
enter Caller ID numbers 32
enter speed dial number 34
power on 4
precautions 59

R
redial 23

S
safety instructions 60
set area codes 16
dialing mode 11
earpiece volume 22
corded handset 22
cordless handset ... 23
speaker phone 22
handset registration 19
deregister 20
register 19
language 18
ringer tone 14
night volume 15
volume 15
time and date 12
unit name 19
signal level 7
specifications 73
speed dial 23
standby screen 6

T
text messages 34
transfer 26
two-line calling 49
call waiting 52
make calls 51
quick reference chart 50
receive calls 51

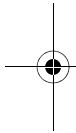
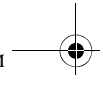

DM1000 User Guide
Copyright © 2010 Waxess USA, Inc.

