



Excellence in Compliance Testing

---

## **Certification Exhibit**

**FCC ID: KJ8-0001543  
IC: 3540A-0001543**

**FCC Rule Part: 15.231  
IC Radio Standards Specification: RSS-210**

**ACS Report Number: 08-0038**

**Manufacturer: Wayne Dalton Corp  
Model: KEP-IV**

## **Manual**



# Wireless Keyless Entry

## Model KEP-IV

Operating Instructions and Owner's Manual

Control Garage Door Opener and HomeSettings Home Controls System with a secure Personal Identification code (PIN)

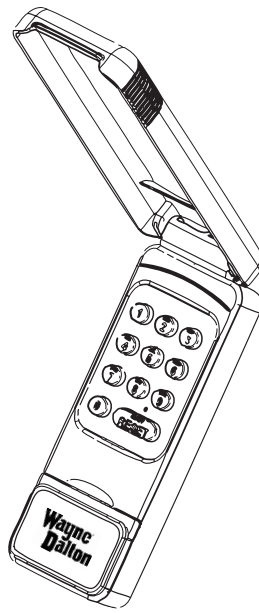

Thank you for purchasing the Wireless Keyless Entry (KEP-IV). The Wireless Keyless entry, uses a state of the art rolling code radio frequency (RF) transmitter to control compatible peripherals.

Your new Wireless Keyless Entry can open and close your garage door when used with a Wayne-Dalton idrive® or prodrive®, garage door opener. In addition, The Wireless Keyless Entry can control any brand garage door opener when used in conjunction with the Wayne-Dalton Garage Door Opener Conversion Module (model# WDRR-372R).

For added functionality, The Wireless Keyless Entry can control scenes in a Z-Wave® enabled network when used in conjunction with a Wayne-Dalton Wireless Gateway (model# WDHA-12R). A Z-Wave® enabled network is made of modules which are capable of controlling indoor and outdoor lighting, security systems, thermostats, door locks etc. Go to [www.wayne-dalton.com/access](http://www.wayne-dalton.com/access) for more information.

### PACKAGE CONTENTS:

User Manual



Model # KEP-IV  
Wireless Keyless Entry



Mounting Screws



### Table of Contents

Introduction/Package Content .....	1
Warnings and Glossary .....	2
Programming to Opener.....	3
Mounting .....	4
Operation/Battery Replacement .....	5
Programming/Operation/Examples of use with Wireless Gateway.....	6-7
Warranty/Compliance.....	8

Look for the **Quick Start** symbol for basic instructions.



### Installation Safety Precautions



Never let children operate or play with door controls. Keep remote controls away from children. Fatal injury could result should a child become trapped between the door and the floor.



Always keep moving door in sight and keep people and objects away until it is completely closed. To prevent serious injury or death, avoid standing in the open doorway or walking through the doorway while door is moving.

### Glossary

**Copy** – See Replicate.

**Delete** – Erase transmitter or SCENE information from Controller. Also known as Exclude.

**Device** – Any item that is connected to a Z-Wave® module (for example, lamps).

**Exclude** – Remove a module from the controller.

**Include** – Add a module to the controller.

**LED** – Light emitting diode.

**Module** – Any HomeSettings or Z-Wave® product that is controlled with a HomeSettings or Z-Wave® remote controller. A module can be part of more than one scene.

**Network** – A collection of devices controlled by primary or secondary controllers operating on the same system. A network has its own unique identification code so that no one else can control the system.

**Opener** – Garage Door Opener

**Primary Controller** – The first controller used to set up your modules and network. **NOTE:** *Only the Primary Controller can be used to include or delete modules from a network. It is recommended that you mark the primary controller for ease in modifying your network.*

**Replicate** – Copy from one controller to another.

**PIN** – Personal Identification Number set by person programming the KEP-IV.

**Scene** – A scene is a series of Z-Wave® modules programmed to activate a specific level (on, off, dim) with the push of a button on a controller.

**Transmitter** – Garage Door Opener transmitter

**Programming KEP-IV to Opener**

**To program the KEP-IV to an Opener or to change an existing PIN:**

1. With new installations, it is recommended to program the KEP-IV before mounting to wall, otherwise proceed to Step 2.
2. Unit can be programmed with garage door in either up or down position.
3. Press the transmitter PROGRAM BUTTON on DoorMaster® light fixture, *idrive*®, *prodrive*®, Quantum® or Classicdrive® opener. LED will light or *idrive*® opener will beep once indicating that it is ready to learn a transmitter. (See Illustration on right)

The *idrive*® and *idrive*® Torsion opener will remain in the learn mode for 30 seconds. The DoorMaster® light fixture will remain in the learn mode for 30 seconds. The *prodrive*®, Quantum® or Classicdrive® opener will remain in learn mode for 60 seconds.

4. Open the cover of the KEP-IV, then push the ON/OFF/RESET button of the keyless entry. The Keyless Entry keypad will light indicating it has been activated and is waiting for commands (illumination may not be visible in direct sunlight.)

5. Press the desired four digit PIN number, then hold the "0" key until the door moves. (example:1-2-3-4-0). Release the "0" key. Programming is now complete.

**NOTE:** *If at any time, an error was made in entering the codes, simply press the ON/OFF/RESET button and repeat the above procedures.*

**NOTE:** *One KEP-IV can be programmed to open multiple garage door openers. To program for additional openers, repeat steps 1 through 5 above except input a different four digit PIN number for each additional opener.*

*Only 1 PIN can be programmed to each garage door opener.*

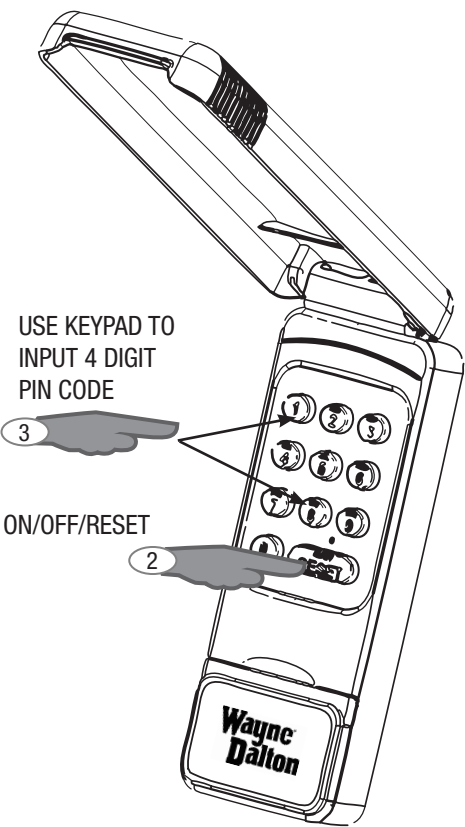
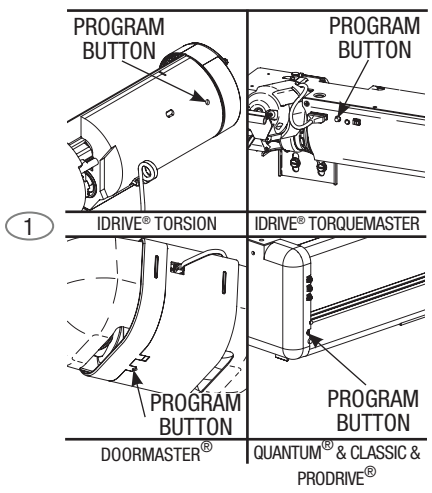

## Mounting the KEP-IV

Quick   
Start 

**CAUTION:** MOUNT THE KEP-IV A MINIMUM OF 5 FEET FROM THE FLOOR TO KEEP IT OUT OF THE REACH OF SMALL CHILDREN.

With new installations, the KEP-IV should be programmed before mounting to wall.

1. Choose a convenient location that does not interfere with the normal opening and closing operation of the door, such as the door jamb, but is within sight of the door.
2. Two screws are included for proper mounting into wood or other similar material. A  $5/64" \times 3/4"$  pilot hole may need to be drilled for the mounting screws. If mounting to other materials consult a qualified building or hardware specialist for the proper hardware to insure secure mounting.
3. Insert Upper screw into upper pilot hole leaving head of screw  $1/16"$  away from wall as shown in the illustration to the right.
4. Slide and lock back keyhole slot over exposed screw and position unit vertically.
5. Remove battery door to expose lower screw mounting hole.
6. Insert lower screw and tighten.
7. Replace battery door.

KEP-IV  
WIRELESS  
KEYLESS  
ENTRY

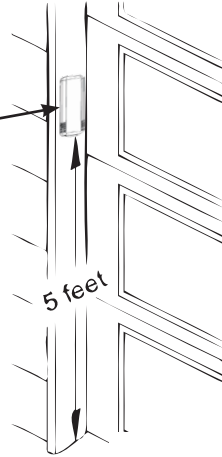

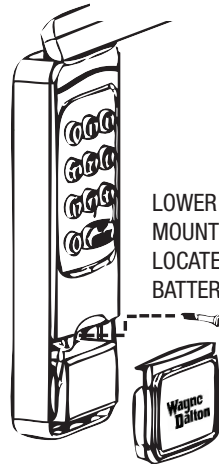
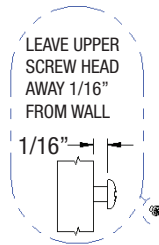

LEAVE UPPER  
SCREW HEAD  
AWAY  $1/16"$   
FROM WALL

$1/16"$



LOWER SCREW  
MOUNTING HOLE  
LOCATED BEHIND  
BATTERY COVER

Quick   
 Start

**KEP-IV Operation with Opener**

**To OPEN, CLOSE, START, and STOP your garage door opener:**

1. Activate your keypad by pressing the ON/OFF/RESET button. The keypad will illuminate.
2. Enter the 4 digit PIN (personal identification number) for the garage door opener you want to operate. The opener will begin to move the door.

**NOTE:** *The opener will not move the door if the incorrect PIN is entered. Reset the KEP-IV by pressing the ON/OFF/RESET button and enter the correct PIN.*

3. The KEP-IV will remain active for 15 seconds, pressing any key, except the ON/OFF/RESET button will stop the opener from opening the door if it is opening, and will stop and reverse the door direction if it is closing.

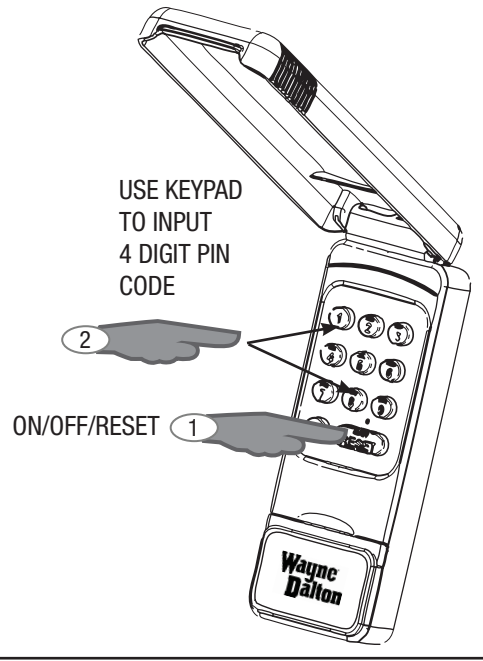

**KEP-IV Battery Replacement**

**WARNING!** IF BATTERY IS SWALLOWED, CONTACT PHYSICIAN IMMEDIATELY.

**WARNING!** FIRE AND BURN HAZARD. DO NOT RECHARGE, DISASSEMBLE, HEAT, OR INCINERATE. KEEP BATTERY OUT OF THE REACH OF SMALL CHILDREN. INSTALL BATTERY CORRECTLY. DISPOSE OF USED BATTERIES PROMPTLY.

**NOTE:** *Replace the 9 volt battery when keypad light becomes dim or does not light up.*

1. Raise Keyless Entry Cover to expose battery cover.
2. Snap open battery cover with a coin and remove old battery.
3. Replace 9V battery, then replace battery cover.

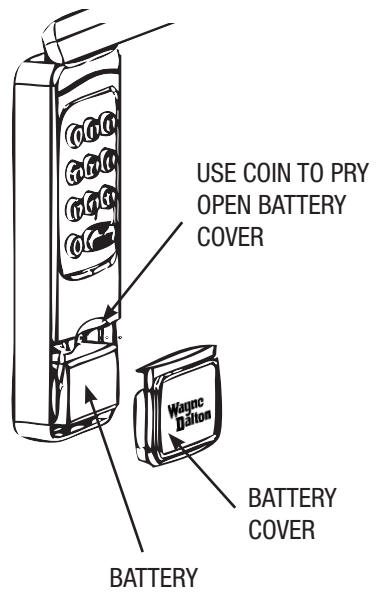

## Programming KEP-IV to Wireless Gateway

**To program a PIN to a Scene button on the Wireless Gateway, WDHA-12R, or to reassign a PIN to a Scene button:**

1. Press and Hold the Scene button you wish to program on the Wireless Gateway, either Scene 1, 2 or 3, until the LED turns off, then immediately release the Scene button (before the LED turns on again.)
2. Open the cover of the KEP-IV, then push the ON/OFF/RESET button of the keyless entry. The Keyless Entry keypad will light indicating it has been activated and is waiting for commands (illumination may not be visible in direct sunlight.)

3. Press the desired four digit PIN number. (example:1-2-3-4). Programming to the Scene is now complete.

The LED on the Wireless Gateway will flash three (3) times quickly to indicate the programming is successful.

**Note:** Your KEP-IV cannot directly operate Z-Wave® modules, the Z-Wave® modules must be programmed to the Gateway Scene to which you have programmed your KEP-IV PIN code. See the Gateway User Manual for instructions on programming Z-Wave® modules.

**Note:** Each Scene on the Gateway must be programmed with a different PIN.

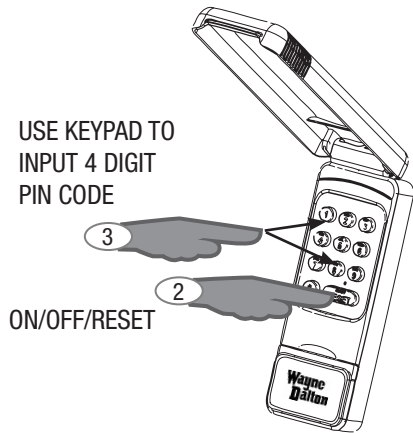
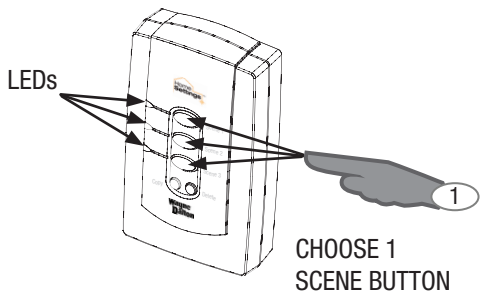

## KEP-IV Operation with Gateway

**To operate a Wireless Gateway Scene:**

1. Activate your keypad by pressing the ON/OFF/RESET button and the keypad will illuminate.
2. Enter the 4 digit PIN (personal identification number) for the specific Scene you want to activate.
3. Your Keypad will turn off automatically in 15 seconds, or you may manually turn it off.

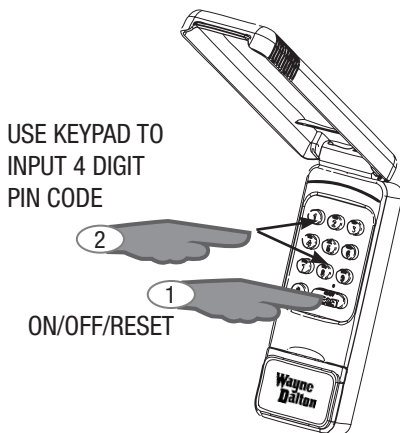

## Examples of KEP-IV / Gateway Use

**Examples of how your KEP-IV can be used with the Wireless Gateway, WDHA-12R are described below. For further ideas, please visit our website at [www.wayne-dalton.com/access](http://www.wayne-dalton.com/access).**

**1. Deck/Patio/Barbecue Area:** Mount the KEP-IV in a convenient location and pair it with the Gateway to control outside lighting. Use it to turn on or off your flood lights and landscape lighting and control pre-configured dimmed mood Scenes.

**NOTE:** *One KEP-IV may be used with multiple Gateway's to achieve the desired number of Scenes.*

**2. Pool/Hot Tub Area:** Use the battery powered KEP-IV paired to the Gateway to safely control outdoor and landscape lights from a pool/hot tub area. Create pre-configured dimmed mood Scenes on the Gateway and activate them using the KEP-IV.

**3. Outbuildings:** Turn on/off the lighting of your outbuildings from your back door for convenience and safety.

**4. Yard/Landscape Lighting:** Turn on/off your yard flood lights or landscape lighting from outside. Save time and extra effort by mounting a KEP-IV near your garden tools to control your outdoor lighting.

**Examples require the following modules:**

X = Number required for your particular application

1 - Wireless Gateway, WDHA-12R  
 1 - Wireless Keypad Entry, KEP-IV  
 X - Dimmer Switch Module HA-06WD (for each in-wall mounted light switch)  
 X - Outdoor Module, HA-04WD (for outside landscape lighting)

1 - Wireless Gateway, WDHA-12R  
 1 - Wireless Keypad Entry, KEP-IV  
 X - Dimmer Switch Module HA-06WD (for each in-wall mounted light switch)  
 X - Outdoor Module, HA-04WD (for outside landscape or pathway lighting)

1 - Wireless Gateway, WDHA-12R  
 1 - Wireless Keypad Entry, KEP-IV  
 X - Dimmer Switch Module HA-06WD (for each in-wall mounted light switch)  
 X - Appliance Module, HA-02WD (for power equipment or lighting)

1 - Wireless Gateway, WDHA-12R  
 1 - Wireless Keypad Entry, KEP-IV  
 X - Dimmer Switch Module HA-06WD (for each in-wall mounted light switch)  
 X - Outdoor Module, HA-04WD (for outside landscape or pathway lighting)

Covered by one or more of the following Patents D413,579; 6,903,650; 7,173,514; 7,327,107. Other US and Foreign Patents pending.



## Limited Warranty Wireless Keyless Entry Model: KEP-IV

Subject to the terms and conditions contained in this Limited Warranty, Wayne-Dalton Corp. ("Manufacturer") warrants the Wireless Keyless Entry, including electronic components (Batteries are not warranted), which is described at the top of this page, for a period of ONE (1) YEAR from the date of installation against:

(i) Any defects in material or workmanship.

This Limited Warranty is extended only to the person who purchased the product and continues to own the premises (where the product is installed) as his/her primary residence ("Buyer"). This Limited Warranty does not apply to residences other than primary, or to commercial or industrial installations, or to installations on rental property (even when used by a tenant as a residence). This Limited Warranty is not transferable to any other person (even when the premises is sold), nor does it extend benefits to any other person. As a result this Limited Warranty does NOT apply to any person who purchases the product from someone other than an authorized Wayne-Dalton dealer or distributor.

The Manufacturer will not be responsible for any damage attributable to improper storage, improper installation, or any alteration of the product or its components, abuse, fire, Acts of God, failure to properly maintain the product, or attempt to use the product, its components or related products for other than its intended purpose and its customary usage. This Limited Warranty does not cover ordinary wear.

THIS LIMITED WARRANTY COVERS A CONSUMER PRODUCT AS DEFINED BY THE MAGNUSON-MOSS ACT. NO WARRANTIES, EXPRESS OR IMPLIED (INCLUDING BUT NOT LIMITED TO THE WARRANTY OF MERCHANTABILITY OR FITNESS FOR A PARTICULAR PURPOSE) WILL EXTEND BEYOND THE TIME PERIOD SET FORTH IN UNDERScoreD BOLD FACE TYPE IN THIS LIMITED WARRANTY, ABOVE.

• Some States do not allow limitations on how long an implied warranty lasts, so the above limitations may not apply to you.

Any claim under this Limited Warranty must be made in writing, within the applicable warranty period, to the dealer from which the product was purchased. Unless the dealer is no longer in business, a written claim to the Manufacturer will be the same as if no claim had been made at all.

At the Manufacturer's option, pursuant to the dealer having notified the Manufacturer of a warranty claim, a service representative may inspect the product on site, or Buyer may be required to return the product to the Manufacturer at Buyer's expense. Buyer agrees to cooperate with any representative of the Manufacturer and to give such representative full access to the product with the claimed defect and full access to the location of its installation.

If the Manufacturer determines that the claim is valid under the terms of this Limited Warranty, the Manufacturer will cause the defective product to be repaired or replaced. The decision about the manner in which the defect will be remedied will be at the discretion of the Manufacturer, subject to applicable law. THE REMEDY WILL COVER ONLY MATERIAL. THIS LIMITED WARRANTY DOES NOT COVER OTHER CHARGES, SUCH AS FIELD SERVICE LABOR FOR REMOVAL, INSTALLATION, SHIPPING, ETC.

Any repairs or replacements arranged by Manufacturer will be covered by (and subject to) the terms, conditions, limitations and exceptions of this Limited Warranty; provided, however, that the installation date for the repaired or replaced product will be deemed to be the date the original product was installed, and this Limited Warranty will expire at the same time as if there had been no defect. If a claim under this Limited Warranty is resolved in a manner other than described in the immediately preceding paragraph, then neither this Limited Warranty nor any other warranty from the Manufacturer will cover the repaired or replaced portion of the product.

THE REMEDIES FOR THE BUYER DESCRIBED IN THIS LIMITED WARRANTY ARE EXCLUSIVE and take the place of any other remedy. The liability of the Manufacturer, whether in contract or tort, under warranty, product liability, or otherwise, will not go beyond the Manufacturer's obligation to repair or replace, at its option, as described above. THE MANUFACTURER WILL NOT UNDER ANY CIRCUMSTANCES BE LIABLE FOR SPECIAL, INCIDENTAL, OR CONSEQUENTIAL DAMAGES, including (but not limited to) damage or loss of other property or equipment, personal injury, loss of profits or revenues, business or service interruptions, cost of capital, cost of purchase or replacement of other goods, or claims of third parties for any of the foregoing.

• Some States do not allow the exclusion or limitation of incidental or consequential damages, so the above limitation or exclusion may not apply to you.

No employee, distributor, dealer, representative, or other person has the authority to modify any term or condition contained in this Limited Warranty or to grant any other warranty on behalf of or binding on the Manufacturer, and anyone's attempt to do so will be null and void.

Buyer should be prepared to verify the date of installation to the satisfaction of the Manufacturer.

The rights and obligations of the Manufacturer and Buyer under this Limited Warranty will be governed by the laws of the State of Ohio, USA, to the extent permitted by law.

• This Limited Warranty gives you specific legal rights and you may also have other rights, which may vary from State to State.

## FCC and IC Statement

### FCC Regulatory Information:

**NOTE:** This equipment has been tested and found to comply with the limits for a Class B digital device, pursuant to Part 15 of the FCC Rules. These limits are designed to provide reasonable protection against harmful interference in a residential installation. This equipment generates, uses, and can radiate radio frequency energy and, if not installed and used in accordance with the instruction, may cause harmful interference to radio communications. However, there is no guarantee that interference will not occur in a particular installation. If this equipment does cause harmful interference to radio or television reception, which can be determined by turning the equipment off and on, the user is encouraged to try and correct the interference by one or more of the following measures:

- reorient or relocate the receiving antenna,
- increase the separation between the equipment and receiver,
- connect the equipment into an outlet on a circuit different from that to which the receiver is connected.

Consult the dealer or an experienced radio/TV technician for help.

### IC Regulatory Information:

This Class B digital apparatus meets all requirements of the Canadian Interference Causing Equipment Regulations. Operation is subject to the following two conditions: (1) this device may not cause harmful interference, and (2) this device must accept any interference received, including interference that may cause undesired operation of the device.

Cet appareillage numérique de la classe B répond a toutes les exigences de l'interférence canadienne causant des règlements d'équipement. L'opération est sujette aux deux conditions suivantes: (1) ce dispositif peut ne pas causer l'interférence nocive, et (2) ce dispositif doit accepter n'importe quelle interférence reçue, y compris l'interférence qui peut causer l'opération peu désirée.

**WARNING:** Changes or modifications not expressly approved by the party responsible for compliance could void the user's authority to operate the equipment. The term "IC:" before the radio certification number only signifies that Industry Canada technical specifications were met.