



premium wrist blood pressure monitor



instruction manual

Model: MD 1010 WBPM10 Series / MD 13400

Contents

Introduction	5
Safety Information	6
General	6
Safe handling of batteries.....	7
Service & Repairs.....	8
About this device	9
Proper use.....	9
Frequently Asked Questions	10
What is blood pressure?	10
What are systolic and diastolic values?	10
What is High Blood Pressure and how is it controlled?	11
How does the blood pressure monitor work?	12
Measuring range	13
About your measurement results	16
Before taking your blood pressure measurement	17
Initial operation	19
Device overview.....	19
Display	20
Inserting batteries	21

Setting the date & time	22
Putting on the wrist cuff	24
Correct position for measurement.....	25
Automatic measurement.....	28
Arrhythmia detection	28
User settings	29
Selecting user.....	29
Retrieving stored measurement results	30
Deleting memory values.....	31
Caring for your blood pressure monitor.....	34
Cleaning/storage	34
Waste disposal	35
Troubleshooting	36
Technical data	38
FCC Statement	40
Blood pressure reading log	42
Limited Warranty	44

Introduction

Thank you for purchasing the Welby® Wrist Blood Pressure Monitor. This fully automatic device measures blood pressure and pulse rate and checks detects irregular heart beat fast and easily and then displays the results on the LCD screen. It works using the oscillometric method of blood pressure measurement. This means the monitor detects your blood's movement through your brachial artery and converts the movements into a digital reading. An oscillometric monitor does not need a stethoscope so the monitor is simple to use by oneself. Please read this manual thoroughly before use and save them for future reference. We also highly recommend that you consult with your physician or licensed healthcare professional if you have any questions about your blood pressure either before or as a result of using this monitor.

Please also save your original receipt as proof of purchase. It may be required to validate your warranty in case you need service for this device.

Safety Information

General

- This device is intended for home use only.
- Do not use this device for self-diagnosis or self-treatment. Contact your physician or other licensed health care provider for specific information about your blood pressure.
- Keep plastic packaging out of the reach of children. There is a risk of suffocation.
- Keep the device and its accessories out of reach of children.
- Do not inflate (with the  button) until the device is attached correctly to the wrist.
- Do not drop the device and do not place objects on top of it.
- Avoid contact with water or moisture!
- Do not use or store the device in extreme temperature conditions.
- Do not bend or fold the fixed part of the cuff!

Safe handling of batteries

Batteries may contain combustible materials. If not handled correctly, batteries can leak, become very hot, ignite or even explode, which could damage your device and/or your health. It is very important that you follow the instructions below:

- Keep batteries away from children. If batteries are mistakenly swallowed, call poison control or 911 immediately.
- Before inserting the batteries, check that the contacts in the device and on the batteries are clean and, if necessary, clean them.
- Never charge batteries (unless it is expressly specified). Risk of explosion!
- Never short-circuit the batteries.
- Do not dismantle or deform the batteries. You could injure your hands or fingers or battery fluid could come into contact with your eyes or skin. If this happens, rinse the affected areas immediately with a large amount of clean water and contact your doctor immediately.
- Never expose the batteries to excessive heat (such as direct sunlight, fire or similar).
- Always observe the correct polarity. Make sure that the plus (+) and minus (-) poles are correctly

inserted to avoid short circuits.

- Remove discharged batteries from the device immediately.
- Remove the batteries from the device if you do not intend to use it for an extended period.
- Replace all of the old batteries in device with new batteries of the same type.

Service & Repairs

Please contact the the Customer Care line if you have questions about the device or experience technical problems.

Never try to open or repair the device yourself. There are no user serviceable parts inside and it will void your warranty.

About this device

The device is used to measure blood pressure at the wrist and can save 60 measurement values in each of two memory spaces.

Proper use

This device is intended for use in dry, indoor areas only. The device is only intended for private use and not for clinical or commercial use. Using the device under extreme environmental conditions may damage it.

Frequently Asked Questions

What is blood pressure?

Blood pressure is the force exerted by blood against the walls of the arteries as blood is pumped through the circulatory system and is measured in millimeters of mercury (mmHg). The higher the pressure, the harder the heart has to work to supply blood to the vital organs in the body.

What are systolic and diastolic values?

With every heartbeat, blood pressure fluctuates between a maximum value (systolic), when the heart contracts and pumps blood into the circulatory system, and a minimum value when the heart expands and fills up with blood again (diastolic).

What is High Blood Pressure and how is it controlled?

High Blood Pressure, also called by its medical term Hypertension, is an abnormally high arterial blood pressure. If left unattended, it can cause many health problems including stroke and heart attack.

Blood pressure can be higher than usual if parts of the circulatory system are restricted, diseased or abnormal in other ways High Blood Pressure can be controlled by altering one's lifestyle, avoiding stress, and with medication under a doctor's supervision. To prevent hypertension or to keep it under control:

- Do not smoke
- Exercise regularly
- Reduce salt and fat intake
- Have regular physical checkups
- Maintain proper weight

How does the blood pressure monitor work?

Your blood pressure monitor contains high quality components for measuring and to display the results on the display using the oscillometric method of blood pressure measurement. It also measures and displays your pulse.

The device measures blood pressure indirectly using a cuff around the wrist. Inflating the cuff presses the arteries together so that no more blood can flow through them. If the pressure in the cuff is then reduced, this creates a relationship between the sleeve pressure and the blood pressure.

The device has electronic step valves that can detect even slight changes during the measurement, which can be evened out using the cuff pressure. By reducing the pressure step-by-step, fluctuations in the cuff are recorded by the device and included in the assessment. If no fluctuations are recorded for a step, the air pressure is reduced. Existing fluctuations are assessed at the corresponding step level until they can be determined precisely.

Measuring range

The blood pressure monitor shows your blood pressure (SYS. = systolic and DIA. = diastolic value), pulse and the time and date on the display. Blood pressure is measured in mmHg (millimetres of mercury).

This device classifies blood pressure measurements based on the definition and standards set by the World Health Organisation (WHO). WHO defines high blood pressure as any measurements above 140 mmHg (systolic) and 90 mmHg (diastolic).

Your blood pressure monitor is fitted with a color indicator that makes it easier to assess your measurements.

The following summary can further help you to assess the values of your own results:

Blood pressure classification according to WHO in mmHg

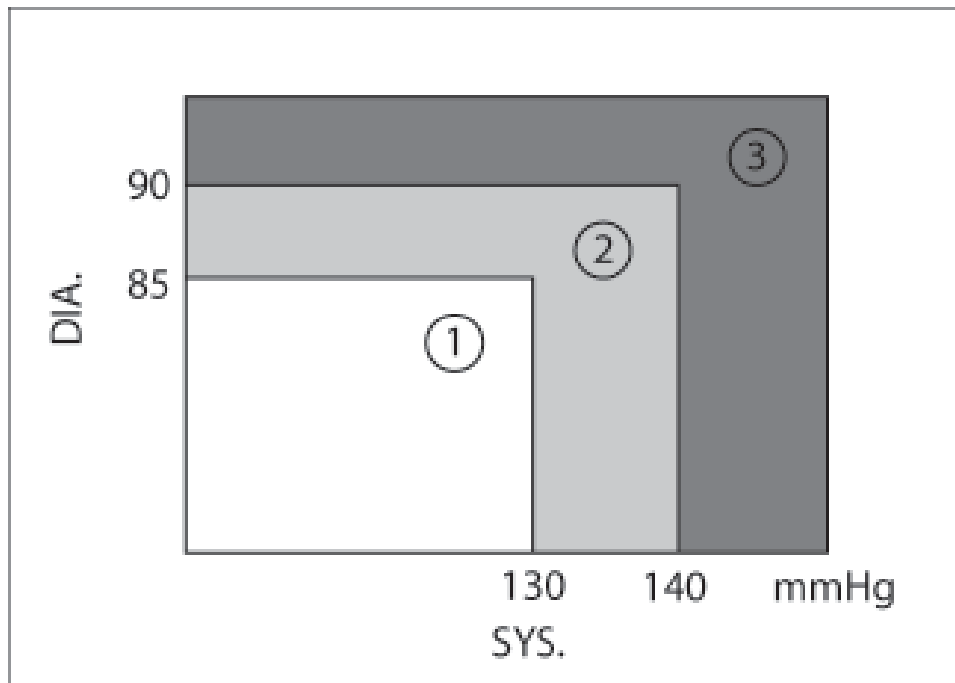

- 1 Normal range
- 2 Borderline high
- 3 High blood pressure range

Range	Systolic mmHg	Diastolic mmHg	Indicator
Low blood pressure	Under 90	Under 50	Green
Normal blood pressure	91–129	51–84	Green
Borderline high blood pressure	130–139	85–89	Green
Mild high blood pressure	140–159	90–99	Yellow
Moderate high blood pressure	160–179	100–109	Orange
Severe high blood pressure	Over 180	Over 110	Red

About your measurement results

If the measurements obtained give you cause to be concerned about your health, consult with your physician or licensed health care professional. Do not change your current treatments and/or dosages of medication(s) as a result of your measurements unless you have discussed this first with your doctor!

By using your device regularly and recording your results, you can get a clear overview of your blood pressure. Everybody's blood pressure changes constantly. Fluctuations may be caused by mental and physical factors such as stress, exertion, smoking, caffeine and diet. Blood pressure can also be affected by the time of day, time of year and temperature.

In addition, arrhythmia (irregular heartbeat) can lead to imprecise results. In this case, discuss with your physician whether you should be using this device.

Before taking your blood pressure measurement

Note the following points so that the measurement results give a realistic representation of your blood pressure:

- Always measure your blood pressure at the same time of the day.
- Measure your blood pressure when you are relaxed. Try to rest for fifteen minutes before measuring your blood pressure.
- You should not eat, drink, smoke or exercise for at least 60 minutes before taking a measurement.
- Do not measure your blood pressure if you feel stressed or tense.
- Measure your blood pressure at normal body temperature, but not if you are too hot or cold.
- Wait for approximately 5 minutes between measurements.



- Please ensure that you always measure your blood pressure under the same conditions! Also note the information about maintaining the correct posture during measurement on page 25. Different measurement conditions can lead to markedly different results.

If you have a result that differs greatly from your normal blood pressure measurement, you should take measurement again after a short period of time in order to exclude the factors listed above that can lead to an incorrect measurement.

Initial operation

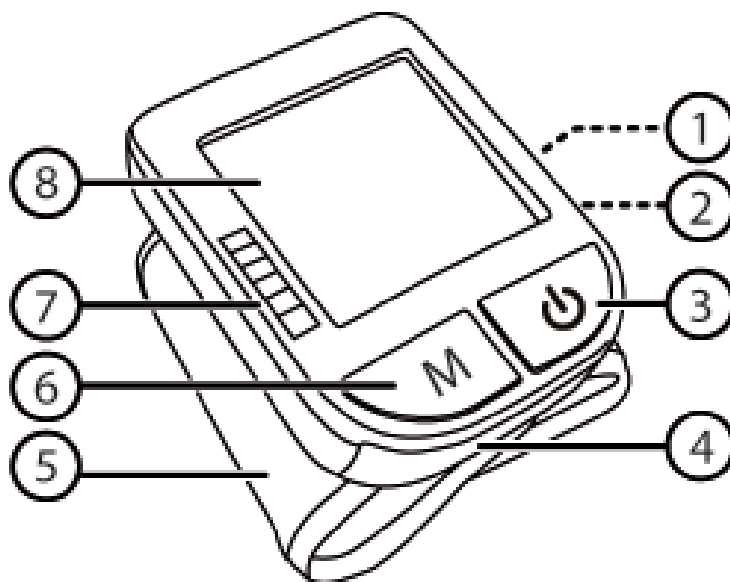
Device overview



- 1** User button 
- 2** Clock button 
- 3** ON/OFF button
- 4** Battery compartment
- 5** Cuff
- 6** Save button
- 7** WHO color indicator
- 8** Display

Display

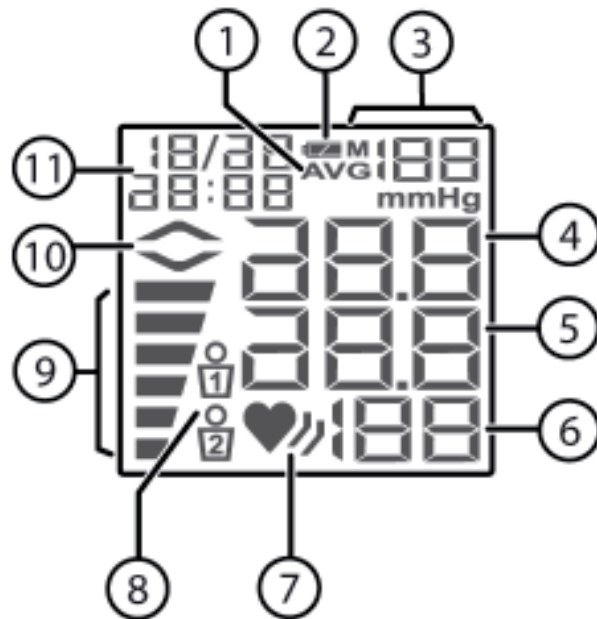

- 1 AVG: Average blood pressure
- 2 Battery indicator
- 3 M: Display of stored measurement results
- 4 Systolic blood pressure
- 5 Diastolic blood pressure
- 6 Pulse measurement
- 7 Pulse display with arrhythmia detection indicator
- 8 User selection
- 9 Blood pressure range indicator
- 10 Cuff inflation symbol
- 11 Date and time

Inserting batteries

- ▶ Remove the cover of the battery compartment at the notch in the direction of the arrow.
- ▶ Insert two 1.5 V R03/LR03/AAA alkaline batteries.
- ▶ Replace the cover of the battery compartment.

It is time to replace the batteries:

- when the battery symbol on the display is only half shown and the error message E6 is displayed, or
- when the display remains blank after pressing the  button.

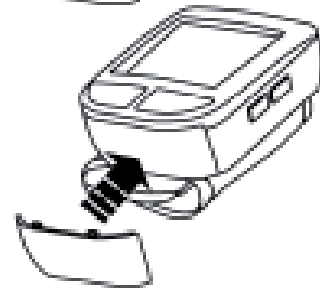
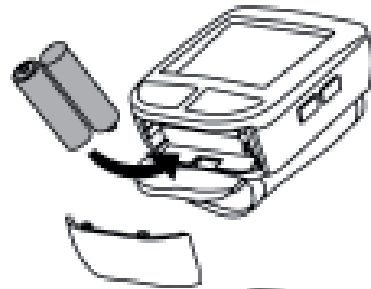
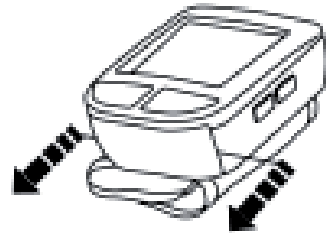



Always change both batteries! Never use new and old batteries together or different types of batteries.





Do not use rechargeable batteries for operating this device.

Setting the date & time



After you have inserted the batteries, the device will change into settings mode.

The year flashes on the display.

- ▶ Press the **M** button until the correct year is displayed.
- ▶ Confirm your selection by pressing the clock button . The display will then change to the month setting.
- ▶ Press the **M** button until the correct month is displayed.
- ▶ Confirm your selection by pressing the clock button  and the display will change to the day setting.
- ▶ Press the **M** button until the correct day is displayed.

- ▶ Confirm your selection by pressing the clock button  and the display will change to the hour setting.
- ▶ Press the **M** button until the current time is displayed.
- ▶ Confirm your selection by pressing the clock button  and the display will change to the minute setting.
- ▶ Press the **M** button until the correct time is displayed.
- ▶ Confirm your selection by pressing the clock button  and now the current time and date will appear on the display.
- ▶ Switch off the device by pressing the ON/OFF button .

You can call up the setting mode at any time.

- ▶ Press the clock button , the current time and date will appear on the display.
- ▶ Press the clock button  and hold it down for 3 seconds.
- ▶ The year flashes on the display.

Putting on the wrist cuff

- ▶ Remove clothing from left arm or roll up sleeve making sure it is not too tight on your arm.
- ▶ Attach the wrist cuff in such a way that it is approx. 1/2" away from the palm of your hand.
- ▶ Wrap the cuff tightly around your wrist so that there is no gap between the cuff and your wrist. Do not put over clothing.

Wrap the cuff according to the shape of your wrist. If the cuff is not firmly attached, the pressure will increase and the wrist will become numb. Correct measurement is then no longer possible.

If the cuff cannot be attached to your left wrist and therefore it is not possible to measure your left arm, use your right one instead.

Correct position for measurement

To measure your blood pressure, sit comfortably on a chair, take 5 or 6 deep breaths and relax.

Place your left elbow on a table or other supporting surface so that the the wrist cuff is at heart height.

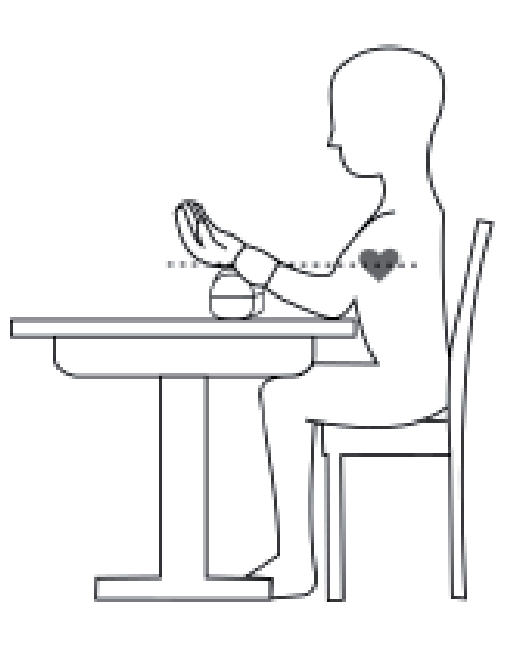

You can also hold your left arm at heart height in front of your chest and support it using your right arm.

It is important to measure your blood pressure at home and at the same time each day so that the blood pressure, which can change over the course of a day, is recorded properly.

Record your measurements in the chart at the end of this instruction manual and discuss with your physician so that you can receive medical advice based on an evaluation of these measurements.

Blood pressure measured at the wrist can vary from that measured at the upper arm. The values may be slightly different because of the different measurement positions and the strength of the blood vessels in the wrist and upper arm.

In many cases, the difference for healthy people can be ± 10 mmHg of the systolic and diastolic blood pressure.

If you already have high blood pressure, diabetes, liver disease, hardening of the arteries or poor circulation consult your doctor before using this device to monitor your blood pressure.

- ▶ Attach the wrist cuff to your wrist as described above.
- ▶ Press the clock button .

The battery symbol, the blinking cuff inflation symbol and the selected user are shown on the display.

Do not move the cuff, your arm or hand muscles during measurement.

After a few seconds, the cuff will inflate. When the cuff pressure is stable, the device will start measuring automatically.

- ▶ If you want to stop the measurement, press the ON/OFF button  and the cuff will deflate.

If you want to repeat a measurement, you should wait at least five minutes. The cuff must be fully deflated.

Automatic measurement

If the cuff pressure is too low, the device stops measuring and inflates the cuff again. Measurement starts when the correct cuff pressure has been reached. The device also measures your pulse. The value displayed will fall during measurement.

When the measurement is complete, the cuff will deflate by itself and the systolic and diastolic blood pressure as well as the pulse and the pulse symbol will appear on the display.

The data is automatically saved to the memory bank of the selected user.

Arrhythmia detection

Normally, the pulse beats with a regular rhythm (rhythmically). When the device detects an abnormal pulse rhythm, the  symbol appears on the display.





In this case, repeat the measurement.

Abnormal pulse rhythms can have different causes. If the pulse is constantly arrhythmic, please consult your physician or healthcare provider.

User settings

The blood pressure monitor has two memory banks, which allow two different users to save up to 60 measurements each. The device calculates the average value from the last three measurements.

Selecting user



- ▶ Press the clock button  or user button  to switch the device on. The current time and date, as well as the current selected user, will appear on the display.
- ▶ If necessary, press the user button  again to switch between the two memory banks.
- ▶ Press the ON/OFF button  to switch off the device.



Note



Please be aware that when there are two users the most recently selected user will remain active until a new user has been selected.

Retrieving stored measurement results

- ▶ Press the user button  to switch on the device.
- ▶ Press the user button  again to select the desired user.
- ▶ Press the **M** button, the average measurement will be shown on the display. This is indicated on the display with **AVG**.
- ▶ Press the **M** button repeatedly in order to display the results of the last measurements.
- ▶ Press the ON/OFF button  to switch off the device.

Deleting memory values

You can delete individually saved measurements or all of the measurements for each user.

- ▶ Press the ON/OFF button  to switch on the device.
- ▶ Press the user button  again to select the desired user.
- ▶ Press the **M** button, the average measurement will be shown on the display.
- ▶ Select the measurement to be deleted with the **M** button.
- ▶ Press and hold down the **M** button for approx. 3 seconds. CL and two lines will be shown on the display.

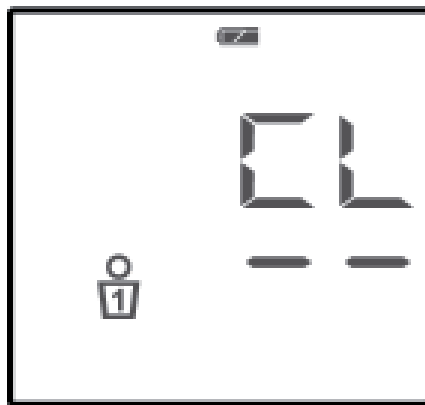

- ▶ Press the user button , CL and 00 will be shown on the display. The value has now been deleted.

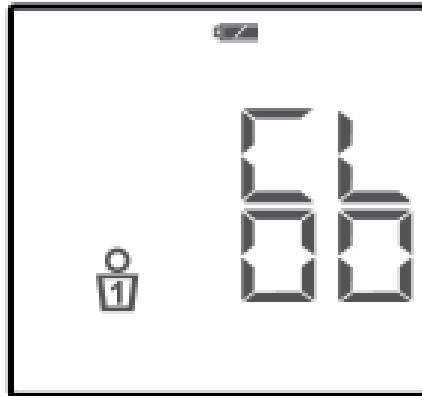

- ▶ In order to delete all of the saved measurements for the selected user, repeat the first three steps until the average measurement is shown on the display. This is indicated on the display by **AVG**.
- ▶ Press and hold down the **M** button for approximately 3 seconds. CL and two lines will be shown on the display.

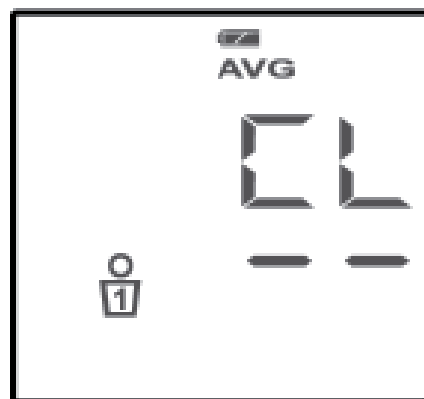

▶

- ▶ Press the user button , CL and 00 will be shown on the display. All of the saved measurements for the selected user have now been deleted.

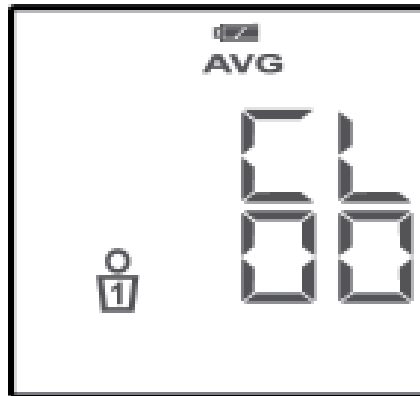

Caring for your blood pressure monitor

Cleaning/storage

Only use a dry, soft cloth to clean the device. Do not use chemical solutions or cleaning products because these may damage the device's surface or markings.

Store the device in the supplied case when not in use.

Do not bend the preshaped cuff outwards. The cuff should neither be washed nor dry cleaned.

If the device is not going to be used for long periods, remove the batteries.

Waste disposal

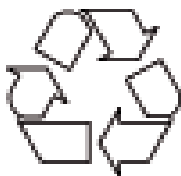

Packaging

Your device has been packaged to protect it from damage in transit. The packaging is made of environmentally friendly material which can be recycled.

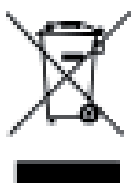

Device

At the end of its service life, the device should not be disposed of with the household trash. Please enquire about options for environmentally friendly disposal.



Batteries

Do not dispose of used batteries in the household trash! They should be disposed of in an environmentally appropriate way.

Troubleshooting

If there are error messages or incorrect measurements displayed, remove the batteries and insert them again after about one minute.

Error	Possible causes	Solutions
Display is blank	The batteries are dead.	Replace both batteries with new 1.5 V R03/LR03/AAA batteries.
E 1	The cuff is not worn correctly	Make sure cuff is worn properly and take a new measurement.
E 2	You moved while a measurement was being taken.	Sit still and take a new measurement.

Error	Possible causes and	solutions
E 3	The cuff is not attached correctly.	Fit the cuff correctly and take a new measurement.
E 4	An error has occurred in the measurement	Take a new measurement.
E 5	Cuff pressure above 300 mmHg	Check the fitting of the cuff and take a new measurement.
E 6	Batteries are too weak	Replace both batteries with new 1.5 V R03/LR03/AAA batteries.

Technical data

Measurement method: Oscillometric

Measuring range

Blood pressure: 30 ~ 280 mmHg

Pulse: 40 ~ 180 beats/min.

Power supply: 2 x 1.5 V alkaline batteries
R03/LR03/AAA

Display: LCD

Memory spaces: 2 x 60 measurement results

Inflation: Automatically by pump

Air release: Automatically via a
one-way valve

Measuring accuracy

Blood pressure: +/- 3mmHg
pressure indicator

Pulse: +/- 5% of value displayed

Temperatures

Operating temperature: +50 ~ +104 °F,

at humidity

30–85%

Storage temperature: –4 ~ +140 °F,

at humidity

10–95%

Cuff size: 5.3" ~ 7.68"

Specifications subject to change without notice.

FCC Statement

NOTE:

POTENTIAL FOR RADIO/TELEVISION INTERFERENCE
(for U.S.A. only)

This product has been tested and found to comply with the limits for a Class B digital device, pursuant to Part 15 of the FCC rules.

These limits are designed to provide reasonable protection against harmful interference in a residential installation. This equipment generates, uses and can radiate radio interference energy and, if not installed and used in accordance with the instructions, may cause harmful interference to radio communications. However, there is no guarantee that interference will not occur in a particular installation. If this equipment does cause harmful interference to radio or television reception, which can be determined by turning the equipment off and on, the user is encouraged to try to correct the interference by one or more of the following measures:

- Reorient or relocate the receiving antenna.
- Increase the separation between the equipment and the receiver.
- Connect the equipment into an outlet or on a

circuit different from that to which the receiver is connected.

- Consult the dealer or an experienced radio/TV technician for help.

You may also find helpful the following booklet, prepared by the FCC: "How to Identify and Resolve Radio-TV Interference Problems." This booklet is available from the U.S. Government Printing Office, Washington D. C. 20402.

Changes or modifications not expressly approved by the manufacturer or registrant of this equipment can void your authority to operate this equipment under Federal Communications Commissions rules.

Status: 04/2011

Limited Warranty

PLEASE READ THIS LIMITED WARRANTY CAREFULLY TO UNDERSTAND YOUR RIGHTS AND OBLIGATIONS.

MEDION warrants that the Welby® Premium Wrist Blood Pressure Monitor (MD 13400, Item 1990) accompanied by this limited warranty is free from manufacturing defects in material or workmanship for a period of 36 months from the date of original purchase. Please save your original cash register receipt as it may be required to validate original date of purchase. The limited warranty period also applies to any implied warranties that may exist under applicable law. Some States do not allow limitations on how long an implied warranty lasts, so the above limitation may not apply to you.

This limited warranty does not apply to products that have been opened, repaired (except by MEDION or its authorized Service representatives), or otherwise altered. This limited warranty does also not apply to defects resulting from misuse, abuse, accident, neglect, improper maintenance or handling.

If you believe the product is defective please return it to MEDION in the manner described below within the limited warranty period. If MEDION determines a defect covered by this limited warranty, MEDION will, at its option, repair or replace the product. This

limited warranty extends to repaired products and replacement products only through the end of the original limited warranty period.

In no event shall MEDION or any of its distributors or resellers be liable for incidental, indirect or consequential damages relating to the product (including any repaired product or replacement product) or its use. Some States do not allow the exclusion or limitation of incidental or consequential damages, so the above limitation and exclusion may not apply to you.

This limited warranty gives you specific legal rights, and you may have other rights which vary from State to State.

To make a claim under this limited warranty you must first contact MEDION Customer Care using one of the options below to obtain a return merchandise authorization (RMA) number. Once you have received the RMA, please return the product as instructed by the RMA. This warranty does not apply to any products returned to MEDION without a RMA.

To obtain a RMA please contact MEDION Toll Free
Customer Care at:

866-633-4660

Daily 8:00 am - 12:00 am CST

except holidays

Email Support (Available 24 x 7, with response in 24
hours or less)

Toll Free Customer Support Line
(866) 633-4660
Daily 8:00 am - 12:00 am CST
except holidays