

# west elm : modular storage collection - open cube

assembly instructions

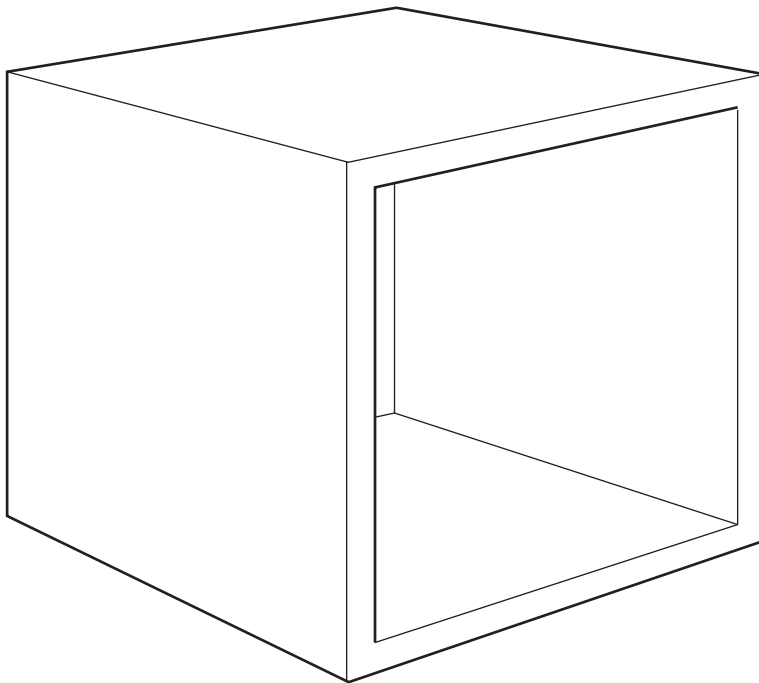

! Tools required: 

! Do not throw away packaging materials until assembly is complete.

! Assemble this item on a soft surface, such as cardboard or carpet, to protect the finish.

! Use mounting hardware to secure unit(s) to base and units together when placed beside or on top of each other.

! Use overbalance protection hardware (included with base) when stacking 3 units high.

! Do NOT stack more than 3 units high.

MOUNTING HARDWARE (included with each modular unit):

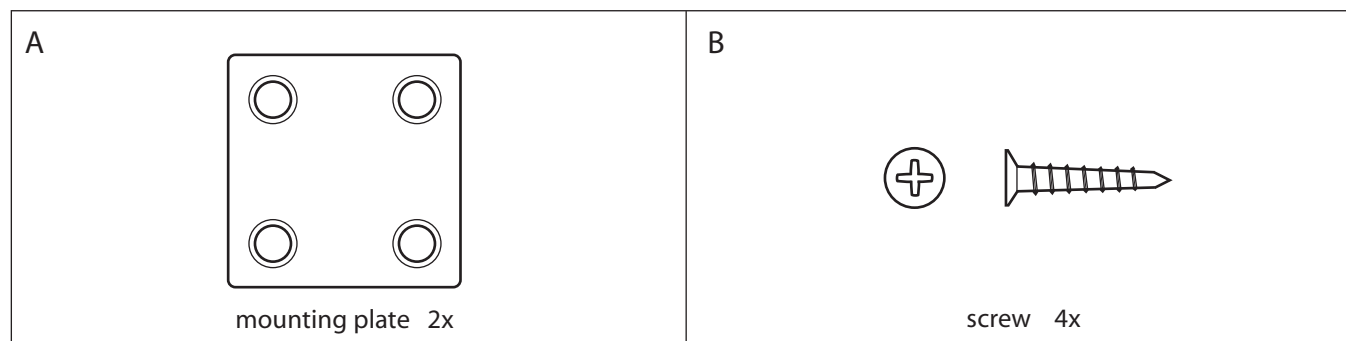

# west elm: modular storage collection - open cube

## assembly instructions

1. Connect unit to base or units together with mounting plates (A) and screws (B). Insert screws into pre-drilled holes as shown. Tighten with a Philip's head screwdriver.

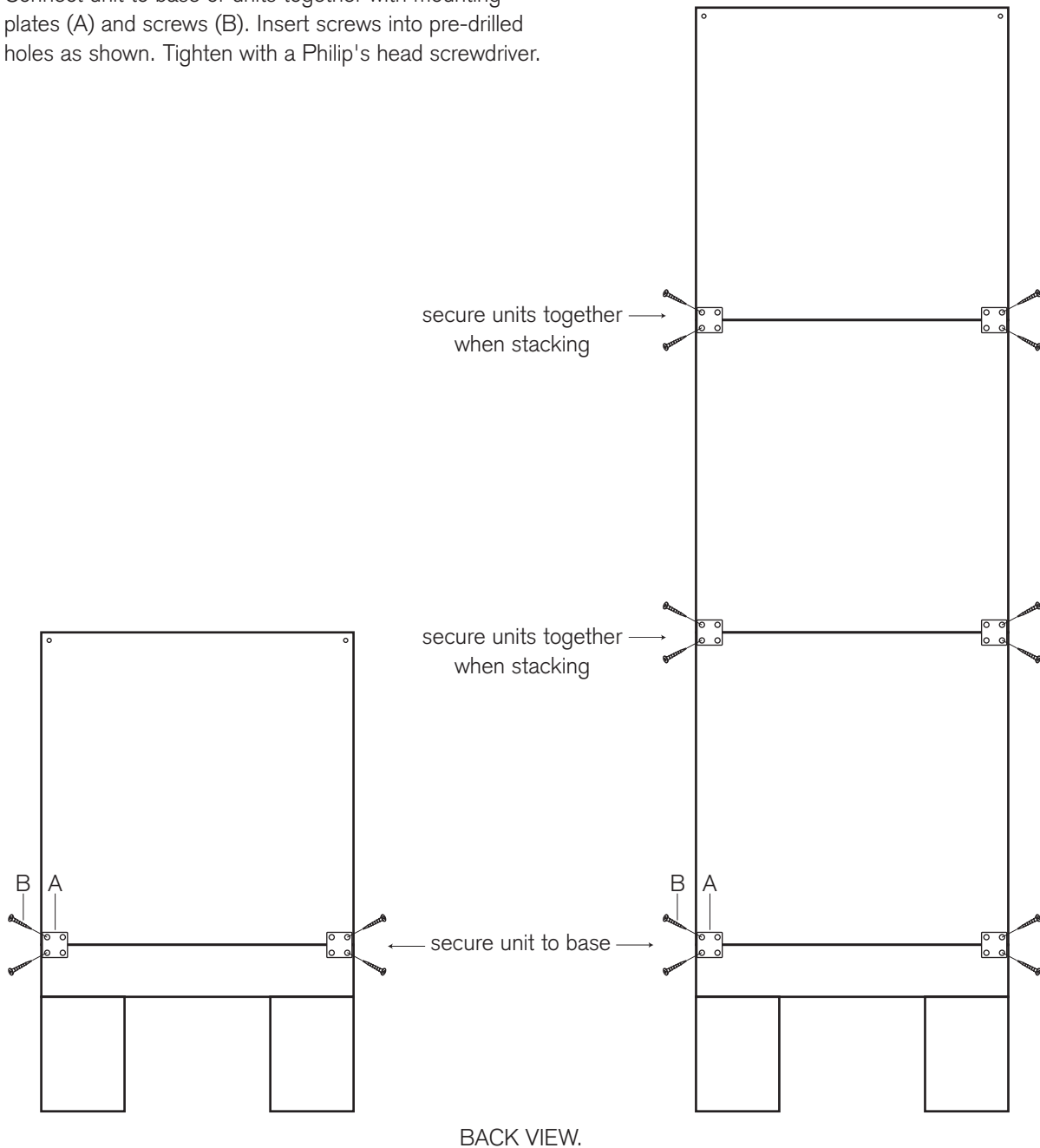

### CARE INSTRUCTIONS:

Wipe with a soft, dry cloth. To protect the finish, avoid the use of all chemicals and household cleaners.

# west elm: modular storage collection - open cube

assembly instructions

Examples of how units can be placed on bases (back view):

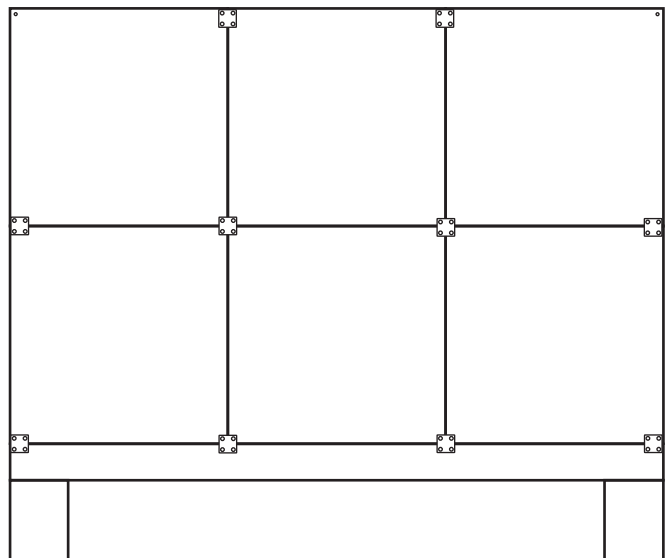
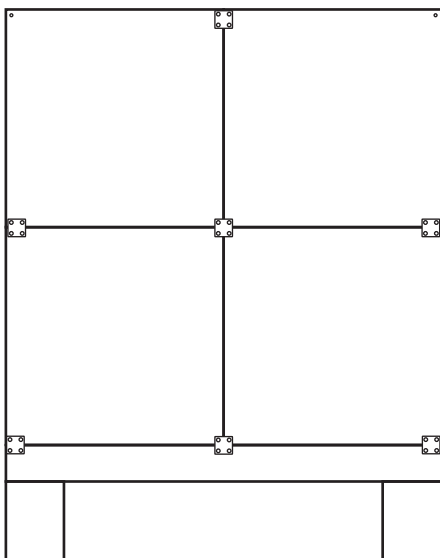
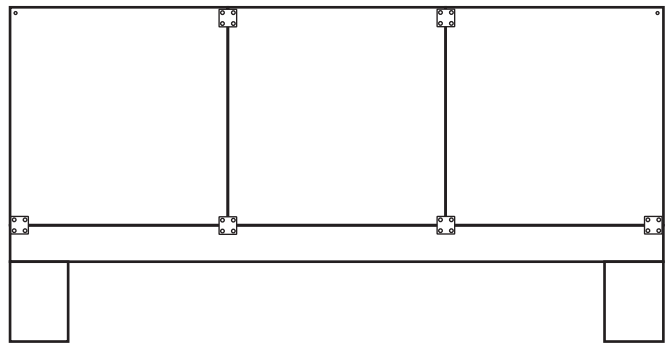
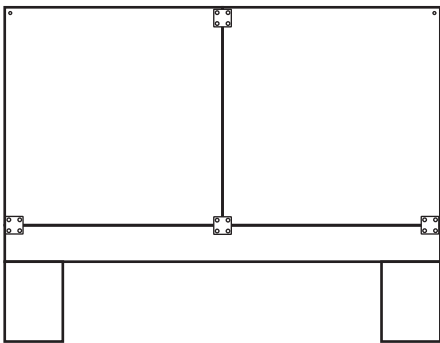

# west elm: modular storage collection - open cube

assembly instructions

Examples of how units can be placed on bases (back view):

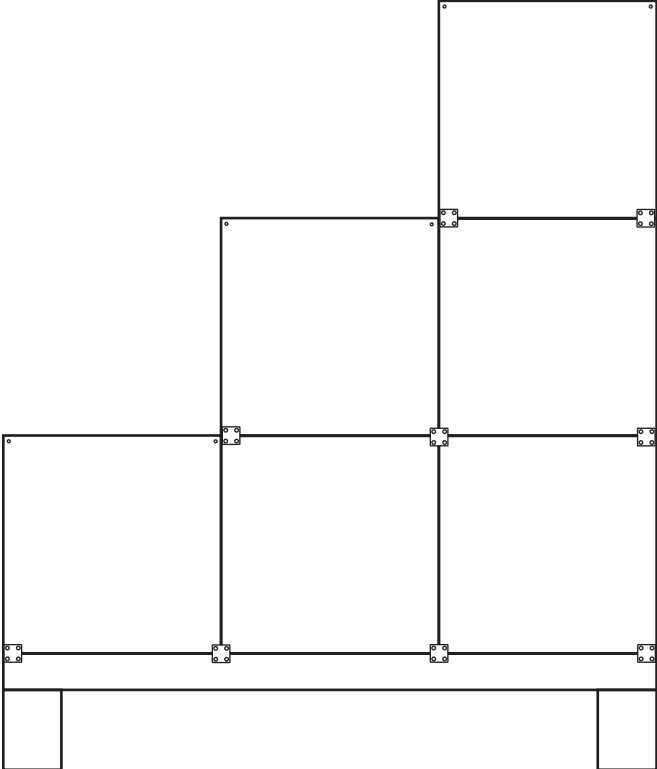
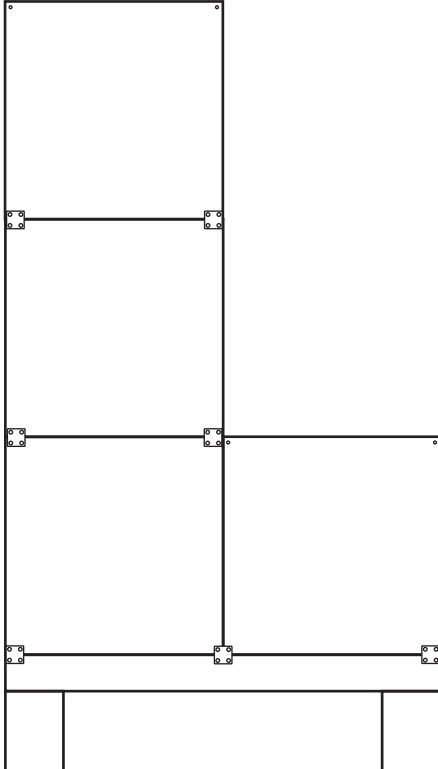
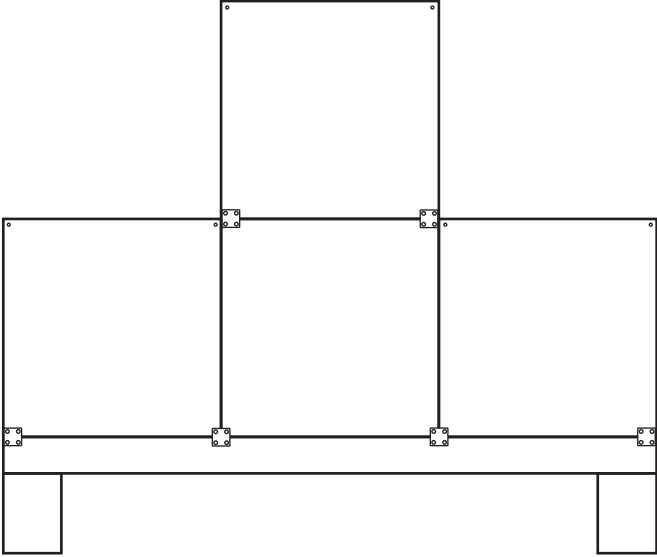
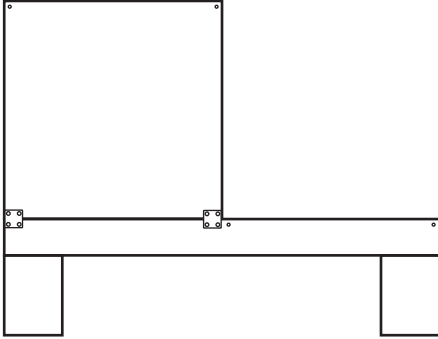

# west elm: modular storage collection - open cube

## assembly instructions

**OVER BALANCE.** To prevent injury and property damage from unexpected tipping of furniture, we highly recommend installation of the overbalance protection hardware included with this product.

1. Attach the mounting brackets horizontally to the top back edge of the furniture. Insert the short screws through the holes in the bracket and tighten securely using screwdriver.
2. Determine where the furniture is to be placed and mark location on the wall for the other mounting bracket screw holes. It should be placed approximately 2" below the bracket mounted to the furniture.
3. Attach the mounting brackets vertically to the wall by inserting the long screws provided through the holes in the bracket and tightening securely using screwdriver.
4. Place the furniture so the brackets on the back edge are in line with the brackets on the wall.
5. Lace an end of the nylon restraint strap down through each bracket. Bring both ends together and slide the thin end of the strap through the receiving end of the strap until snug.
6. Check to make sure the strap is securely laced and locked to the brackets.

