



Bi-directional Amplifiers

510 and 610 Series

PRODUCT MANUAL

Disclaimer

All information and statements contained herein are accurate to the best of the knowledge of Westell, but Westell makes no warranty with respect thereto, including without limitation any results that may be obtained from the products described herein or the infringement by such products of any proprietary rights of any persons. Use or application of such information or statements is at the users' sole risk, without any liability on the part of Westell. Nothing herein shall be construed as license or recommendation for use, which infringes upon any proprietary rights of any person. Product material and specifications are subject to change without notice. Westell's standard terms of sale and the specific terms of any particular sale apply.

WARNING. This is NOT a CONSUMER device. It is designed for installation by **FCC LICENSEES and QUALIFIED INSTALLERS**. You must have an **FCC LICENSE** or express consent of an FCC Licensee to operate this device. Unauthorized use may result in significant forfeiture penalties, including penalties in excess of \$100,000 for Each continuing violation."

WARNING! Changes and Modifications not expressly approved by Westell can void your authority to operate this equipment under Federal Communications Commission's rules.

WARNING! The Manufacturer's rated output power of this equipment is for single carrier operation. For situations when multiple carrier signals are present, the rating would have to be reduced by 3.5 dB, especially where the output signal is re-radiated and can cause interference to adjacent band users. This power reduction is to be by means of input power or gain reduction and not by an attenuator at the output of the device.



TABLE OF CONTENTS

Disclaimer	2
Preface	6
Purpose.....	6
Application.....	6
Product Registration Information	6
Safety Guidelines	6
Important Safety Information.....	7
1 Overview	9
1.1 Product Information.....	9
1.1.1 Bi-Directional Amplifier Mechanical and Electrical Specifications, 510 and 610 Series.....	10
1.2 LED Indicators.....	11
1.3 Pin-Out Chart.....	11
2 Product Appearance.....	12
2.1 Mechanical Drawing, Dual-band BDA	12
3 Installation Tips.....	14
3.1 Important Installation Tips	14
3.2 Multiple Internal Antenna System Design	14
3.3 Troubleshooting	15
3.4 Optional Accessories	15
4 LCD Command Interface.....	16
4.1 Command Interface Overview	16
4.2 The View Menu Series.....	16
4.2.1 Screen Saver Display.....	18
4.2.2 Power Readings Display	18
4.2.3 Event Readout Displays	19
4.2.4 Peak Power Readout Display.....	20
4.2.5 Gain Display	20
4.2.6 BDA Name and Address Display.....	20
4.3 The Edit Menu Series	22
4.3.1 Edit Events Display.....	23



4.3.2	Edit Peak Power Readout Display.....	23
4.3.3	Edit Downlink Gain Display	23
4.3.4	Edit Uplink Gain Display	24
4.3.5	Edit BDA Name Display	24
4.3.6	Edit BDA Address Display	25
4.3.7	Software Shutdown Display.....	26
4.3.8	Create New Password Display	26
5	Registration Numbers.....	28
Appendix A	Glossary	A

TABLE OF FIGURES

Figure 1-1:	Product Registration Information	6
Figure 2-1:	Mechanical Drawing of the Dual-band BDA, including the FCC label	12
Figure 2-2:	Mechanical Drawing of a Single-band BDA, including FCC label	13
Figure 4-1:	View Menu Series.....	17
Figure 4-2:	Screen Saver Display	18
Figure 4-3:	Power Readings Display	18
Figure 4-4:	Events Readout Displays	19
Figure 4-5:	Peak Power Readout Display	20
Figure 4-6:	Gain Display.....	20
Figure 4-7:	BDA Name and Address Display	21
Figure 4-8:	Password entry display.....	21
Figure 4-9:	Edit Menu Series.....	22
Figure 4-10:	Edit Events Display	23
Figure 4-11:	Edit Peak Power Readout Display	23
Figure 4-12:	Edit Downlink Gain Display	24
Figure 4-13:	Edit Uplink Gain Display	24
Figure 4-14:	Edit BDA name display menu.....	25



Figure 4-15: Example display when editing the BDA Name.....25

Figure 4-16: Another display when editing the BDA Name25

Figure 4-17: Edit BDA Address Display25

Figure 4-18: Software shutdown display.....26

Figure 4-19: Old password display26

Figure 4-20: New password display27

TABLE OF TABLES

Table 1-1: Model Type/Band Combinations/ Gain Values.....10

Table 1-2: Maximum Power Output (dBm) by Model.....10

Table 1-3: General Specifications*10

Table 1-4: Pin-Out Descriptions11

Table A-1: Acronyms and Abbreviations.....A



Preface

Purpose

The purpose of this document is to provide instructions to help the experienced technician/engineer install and commission an in-building wireless enhancement system using Westell Technologies Bi-Directional Amplifiers. Following the procedures outlined will minimize risks associated with modifying a live system and preclude service interruptions. This document assumes the technician/engineer understands the basic principles and functionality involved with repeater and in-building systems and addresses the practical concerns of the installation procedure.

Application

Apply this guide whenever a need exists to add enhanced signal capability to an existing system or when the repeater is being included in a new installation.

Product Registration Information

The serial number is located on the label on the bottom panel, near the power connectors. Write this number in the boxes shown in Figure 1-1. Retain this manual, along with proof of purchase, to serve as a permanent record of your purchase.

MODEL NUMBER	SERIAL NUMBER	PURCHASE DATE
<input type="text"/>	<input type="text"/>	<input type="text"/>
POINT OF SALE COMPANY		
<input type="text"/>		

Figure 1-1: Product Registration Information

Safety Guidelines

The general safety information in this guideline applies to both operating and service personnel. Specific warnings and cautions are located in other parts of this manual where they apply, but may not appear in this summary. Failure to comply with these precautions or specific warnings elsewhere in the manual violates safety standards of design, manufacture, and intended use of equipment. Westell assumes no liability for the customer's failure to comply with these requirements:

Grounding: This bi-directional amplifier is designed to operate from 100-240 VAC and should always be operated with the ground wire properly connected. Do not remove or otherwise alter the grounding lug on the power cord.

Explosive atmospheres: To avoid explosion or fire, do not operate this product in the presence of flammable gases or fumes.

Lightning danger: Do not install or adjust this unit during an electrical storm. Use of a suitable lightning arrester, such as Westell's model number CSI-CAP, is strongly recommended.



There are no user-serviceable parts inside. Hazardous voltages are present when the cover is removed. Opening the chassis will void your warranty. If you suspect a malfunction with this product, call your dealer or Westell's Technical Support line at 1-877-844-4274. It is recommended that the unit be powered down when connecting and disconnecting cables.

Important Safety Information

WARNING! Changes and Modifications not expressly approved by Westell can void your authority to operate this equipment under Federal Communications Commission's rules.

An omni-directional antenna with a maximum gain of 3 dBi is authorized for indoor use with these units. The maximum rated mean output power is 30dBm for the Cell band models therefore the maximum ERP is 2 watts or less for all units. Inside antennas must be positioned to observe minimum separation of 20 cm (~8 in) from all users and bystanders. For the protection of personnel working in the vicinity of inside (downlink) antennas, the following guidelines for minimum distances between the human body and the antenna must be observed.

Under normal conditions, no personnel can come within 20 cm (~ 8 in) from any inside antenna during the installation of an indoor antenna. This minimum separation will ensure that the employee or bystander does not receive RF-exposure beyond the maximum permissible exposure according to section 1.1310 i.e. limits for general population/uncontrolled exposure.

For outdoor use, a directional antenna up to a maximum gain of 7.5 dBi is authorized for use with this unit. The outside antenna must be positioned to observe minimum separation of 120 cm (~4 ft) from all users and bystanders. For the protection of personnel working in the vicinity of outside (uplink) antennas, the following guidelines for minimum distances between the human body and the antenna must be observed.

The installation of an outdoor antenna must be such that, under normal conditions, no personnel can come within 120 cm (~ 4 ft) from the outside antenna. In all installations, the antenna should never be mounted such that the main beam is directed toward an area where workers or bystanders may be present. Exceeding this minimum separation will ensure that the worker or bystander does not receive RF-exposure beyond the maximum permissible exposure according to section 1.1310 i.e. limits for general population/uncontrolled exposure.

The guidelines for the uplink outdoor antenna are not applicable to the P9 paging model since it is not bi-directional. The P9 only amplifies the downlink in a nominal bandwidth of 2 mhz from 929-931 mhz.



Renseignements importants en matière

Avertissement ! Changements et Modifications non expressément approuvées par Westell peuvent annuler votre droit d'utiliser cet appareil en vertu des règles de la Federal Communications Commission.

Une antenne omnidirectionnelle avec un gain maximum de 3 dBi est autorisée pour un usage intérieur avec ces unités. La puissance de sortie moyenne nominale maximale est 30dBm pour la bande cellulaire des modèles donc la P.A.R. maximale est de 2 watts ou moins pour toutes les unités. À l'intérieur d'antennes doivent être positionnés pour observer une distance minimale de 20 cm (8 po) de tous les utilisateurs et les passants. Pour la protection du personnel travaillant à proximité de l'intérieur (liaison descendante) antennes, les lignes directrices suivantes pour des distances minimales entre le corps humain et de l'antenne doivent être respectées.

Dans des conditions normales, aucuns personnel ne peuvent venir en moins de 20 cm (~ 8 in) de l'un à l'intérieur de l'antenne lors de l'installation d'une antenne intérieure. Cette séparation minimale veillera à ce que l'employé ou le spectateur ne reçoit pas de RF-exposition au-delà de l'exposition maximale admissible conformément à l'article 1.1310 c'est-à-dire limite pour exposition population générale/non contrôlée.

Pour l'extérieur, une antenne directionnelle jusqu'à un gain maximum de 11 dBi est autorisée pour une utilisation avec cet appareil. L'antenne extérieure doit être placée pour observer une distance minimale de 1,20 mètre (4 pi) de tous les utilisateurs et les passants. Pour la protection du personnel travaillant à proximité d'antennes extérieures de (liaison montante), respecter les directives suivantes pour des distances minimales entre le corps humain et l'antenne.

L'installation d'une antenne extérieure doit être telle que, dans des conditions normales, aucuns personnel ne peuvent venir moins de 120 cm (~ 4 pi) de l'antenne extérieure. Dans toutes les installations, l'antenne ne doit jamais être monté tel que le faisceau principal est dirigé vers une zone où les travailleurs ou les spectateurs peuvent être présents. Dépassant cette séparation minimale veillera à ce que le travailleur ou le spectateur ne reçoit pas de RF-exposition au-delà de l'exposition maximale admissible conformément à l'article 1.1310 c'est-à-dire limite pour exposition population générale/non contrôlée.

Les lignes directrices pour l'antenne extérieure de liaison montante ne sont pas applicables au modèle P9 pagination puisqu'il n'est pas bidirectionnelle. Le P9 ne fait qu'amplifier la liaison descendante dans une largeur de bande nominale de 2 mhz à partir de 929-931 mhz.



1 Overview

1.1 Product Information

Westell developed the Bi-Directional Amplifier (BDA) for use in enclosed structures where sufficient signal from local cell sites to operate cell phones was unavailable within the building. Sufficient signal must be available on the roof of the structure. The BDA is connected to an external antenna, usually on the roof, and to one or more internal antennas placed strategically throughout the area where phone service is desired.

The external antenna is usually a directional type such as a yagi. Internal antennas are usually omnidirectional, although various other types may be used for certain installations. The BDA amplifies both the uplink (phone to tower) and downlink (tower to phone) signals thus facilitating communications to and from the local cell site.

There are seven amplification stages on the downlink and seven on the uplink for a total of 65 to 80 dB nominal gain for each link. Gain can be set using the LCD display and pressing the up and down buttons. There are also LED indicators on the top cover for power overload and gain reduction to prevent oscillation.

WARNING FOR PUBLIC SAFETY MODELS

The bi-directional amplifier (BDA) is not a consumer device. This product is designed for installation by FCC licensees and qualified users. You must have an FCC LICENSE or express consent of an FCC Licensee to operate this device. You must register class B signal boosters (as defined in 47 CFR 90.219) online at www.fcc.gov/signal-boosters/registration. Unauthorized use may result in significant forfeiture penalties, including penalties in excess of \$100,000 for each continuing violation.



1.1.1 Bi-Directional Amplifier Mechanical and Electrical Specifications, 510 and 610 Series

Table 1-1: Model Type/Band Combinations/ Gain Values

Model	51062/51065	51075	51080	61080
Single Band	C, PS7, PS8, P, P9	C, PS7, PS8, P, P9	PS8	C, PS8,P, P9
Dual Band	C/P, PS8 /S9	C/P, PS8 /S9	-	C/P, P/P, P/S9
Gain (Db)	65	75	80	80

Table 1-2: Maximum Power Output (dBm) by Model

Band Designation*	Frequency Band	Maximum Power Output (dBm)		
		51062/065/075	51080	61080
C	Cell	27	-	29
PS7	SMR 700	27	26	29
PS8	SMR 800	27	-	29
P	PCS	22	-	-
S9	SMR 900	27	-	-
P9	929-931MHz**	27	-	29

*Refers to available band combinations by model (**Table 1-1**).

** Amplifies downlink for paging only. Not bi-directional.

Table 1-3: General Specifications*

Noise Figure, Typical (dB)	5.5
AGC (dB)	25
Gain Adjustment Range (dB)	0-30, 1 dB steps
Propagation Delay (nS)	<250
Maximum Input Power (dBm)	+10
Connectors	N-Female
Temperature (F)	-22 to +118
Dimension (Inches) (Single Band)	12.38 x 12.6 x 6.21
Dimension (Inches) (Dual Band)	16.6 x 17.88 x 7.67
Weight (lbs) (Single Band)	15.5 nominal
Weight (lbs) (Dual Band)	19. nominal
Power Required	120 VAC @ 1.3 A

*Applicable to models listed in **Table 1-1** and **Table 1-2**.



1.2 LED Indicators

Warning: The unit has sensed instability due to insufficient isolation between the inside antenna and the outside antenna, and has reduced the gain of the amplifier. This action prevents oscillation, which can interfere with the handsets in the covered area and/or the wireless service provider's base station.

Fault: The gain of the unit has been reduced to a minimum (red) to prevent very strong input signals from overloading the amplifier. The amplifier will attempt to recover from this condition, initially at 15 second intervals and then at four-minute intervals.

1.3 Pin-Out Chart

Alarm wiring for public safety. The connector used is an RJ-14, 6 pin.

Table 1-4: Pin-Out Descriptions

Pin	Description
1	5 volts
2	Center contact alarm relay
3	Alarm contact-open (Normally Open =N.O.)
4	Alarm contact-closed (Normally Closed =N.C.)
5	Shut down
6	Ground



2 Product Appearance

2.1 Mechanical Drawing, Dual-band BDA

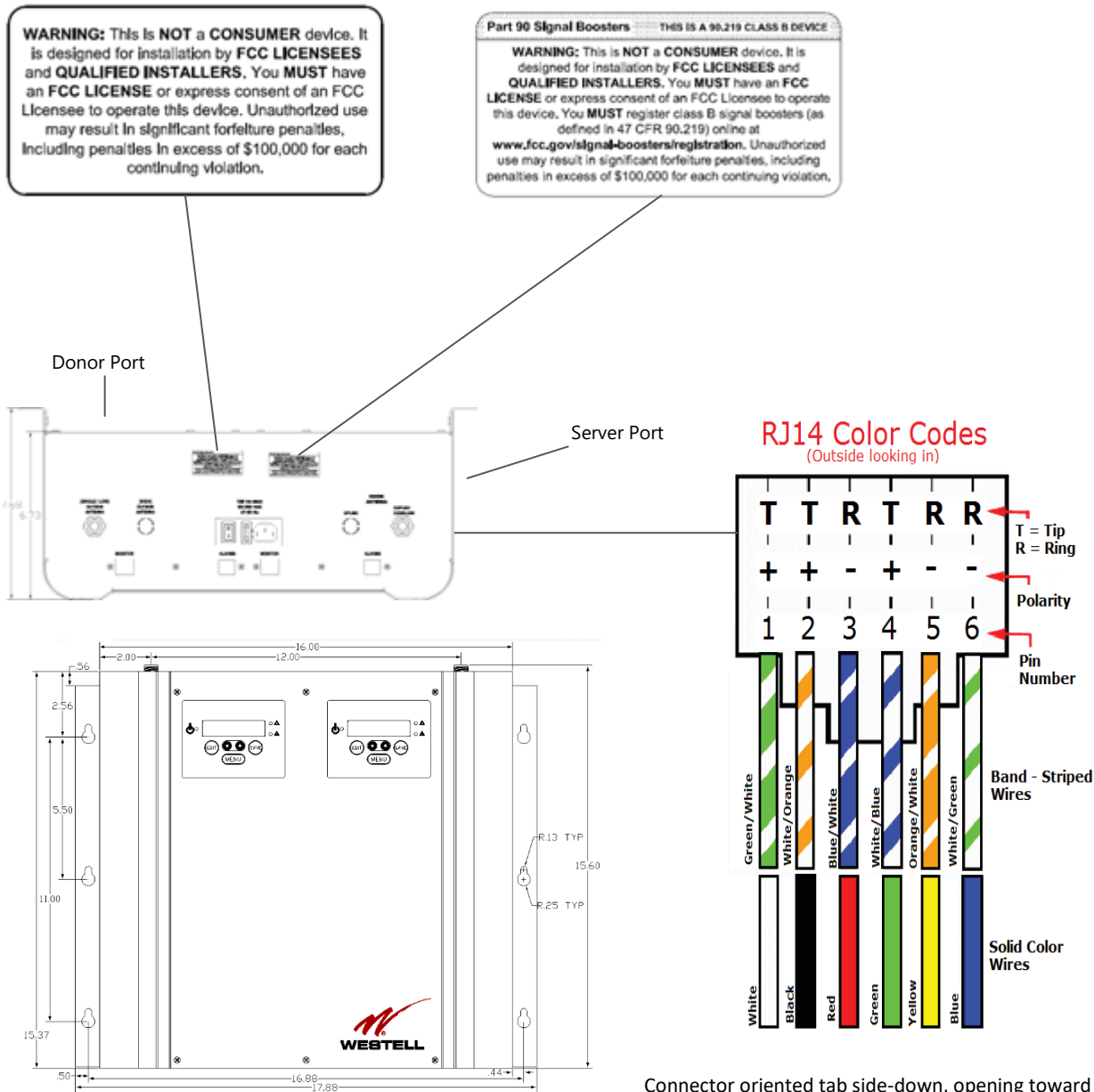

Mechanical Drawing, Single-band BDA

Figure 2-1: Mechanical Drawing of the Dual-band BDA, including the FCC label

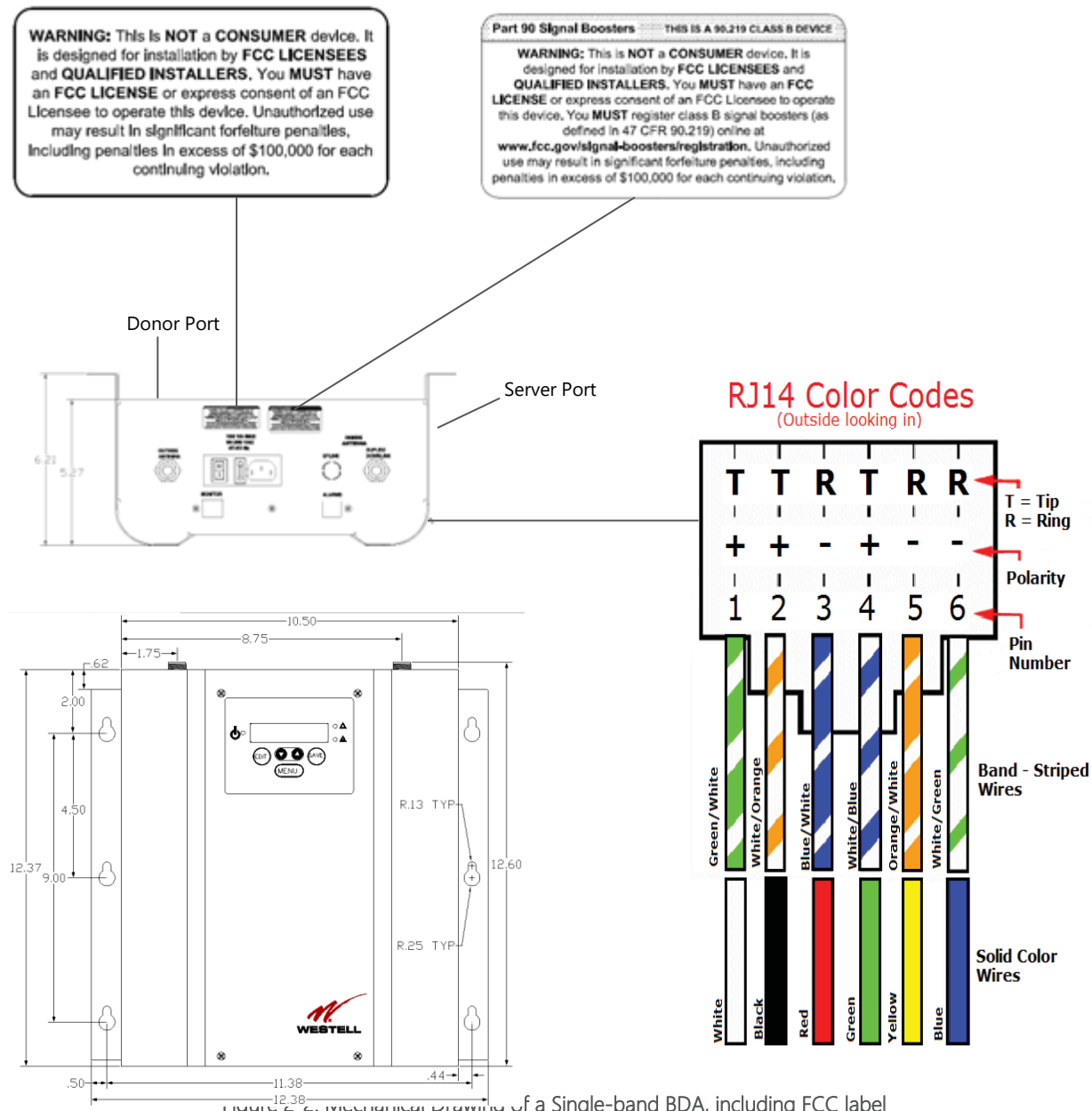

Figure 2-2: Mechanical Drawing of a Single-band BDA, including FCC label

Connector oriented tab side-down, opening toward you.



3 Installation Tips

3.1 Important Installation Tips

A high degree of isolation must be afforded to prevent any re-generative feedback in the system. Feedback of this kind causes the amplifier to emit a continuous signal of maximum amplitude and could, in some cases, interfere with normal operation of the cell site. Avoid the use of window mounts or other non-rooftop mountings.

WARNING

Amplifier or handset damage may occur if a handset is connected directly to the BDA or the coax that leads to the BDA. It is recommended that the BDA be powered down when cables are connected or disconnected.

3.2 Multiple Internal Antenna System Design

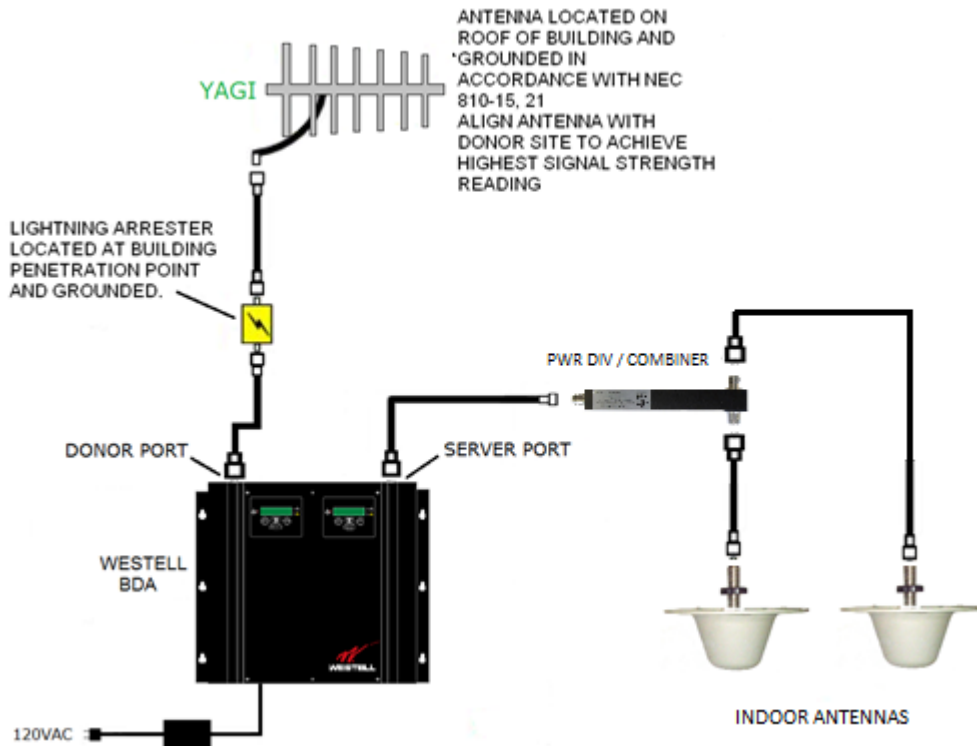

Figure 3-1: Multiple Internal Antenna System Design

Figure 3-1 shows one example of multiple internal antennas implemented using Westell passive devices (listed in section 3.5 Optional Accessories) for models or in building coverage requiring a distributed antenna system design. See the FCC ID grant notes associated with the model for additional booster installation requirements.

3.3 Troubleshooting

Carefully check all cables for shorts and opens.

Check the rooftop antenna, if directional, for proper alignment along the calculated compass heading. Typically, the directional antenna should be aimed at the same site that your handset uses in the area where the outside antenna is placed.

If cables and alignment are acceptable, it may be necessary to use a spectrum analyzer to examine the signal environment in which the BDA is operating. The existence of strong analog signals within the frequency bands can cause the AGC to reduce the amplifier's gain, particularly on the downlink. In some cases, additional filtering is required to reject these unwanted signals. The directional outside antenna can be reoriented horizontally, to place the interfering source in an antenna pattern null. At a site containing significant interference from outside signals that require expensive and possibly prohibitive measures to filter, reduce, or eliminate interference, it may not be practical to use the BDA to provide coverage.

3.4 Optional Accessories

A complete line of accessories is available from Westell. Check with your Westell distributor for any additional items needed. The following products suitable for most in-building needs.

Outside high gain yagi antenna

PCS - model number CSI-AY/1.85-1.99/10

SMR 800 and Cellular - model number CSI-AY/806-960/11 and CSI-AY/806-960/14

SMR 700 - model number CSI-AY/700-806/11



Inside omnidirectional antenna

ClearLink-O/698-2.7K/N

Power dividers

ClearLink – SPD2/698-2.7K-LP/N

ClearLink – SPD3/698-2.7K-LP/N

ClearLink – SPD4/698-2.7K-LP/N

Grounding kit - model number CSI-GKIT

Lightning arrestor - model number CSI-CAP

Directional couplers and cross band couplers are also available.

4 LCD Command Interface

4.1 Command Interface Overview

The menu system can be navigated with five buttons: **Up**, **Down**, **Edit**, **Save** and **Menu**. Feedback is given to the operator through the LCD panel.

The LCD command interface offers two distinct series of menus: the **View** menu series, which allow a user to view, but not alter, the data maintained by the unit. The **Edit** menu series permits the alteration of this information. The **Edit** menu series may be kept secure from general use by a password. If password control is enabled, an added level of security is provided; however, this unit is shipped with this feature disabled.

In both menu systems the **Menu** button is used to maneuver between menus in a sequential fashion. **Edit** is generally used to enter the **Edit** menu series, and **Save** is generally used to exit it. Pressing **Save** in all menus except the one that allows you to alter the Edit BDA Name menu (explained below) will force any changes made while in the **Edit** menu series to be saved in non-volatile memory. The BDA will then exit the **Edit** menu series; if the user needs to edit more information, they will need to press **Edit** and enter a password again. The **Up** and **Down** buttons are usually used to scroll through options within a given menu, if several options exist.

Each menu series and the way each menu represents and interprets data is explored later in detail.

4.2 The View Menu Series

Figure 4-1 depicts the series of menus that will allow the user to view, but not alter, the information stored in the BDA. Pressing the **Edit** button will cause the BDA to ask for a password if password control is enabled. Password control is enabled by pressing **Edit** and **Menu** simultaneously. The password is a five-button sequence that secures the ability to change the information within the BDA. Keys in this password can consist of any button except **Menu**.

This password defaults to the following sequence until changed by the user: Up, Down, Down, Up, Up.



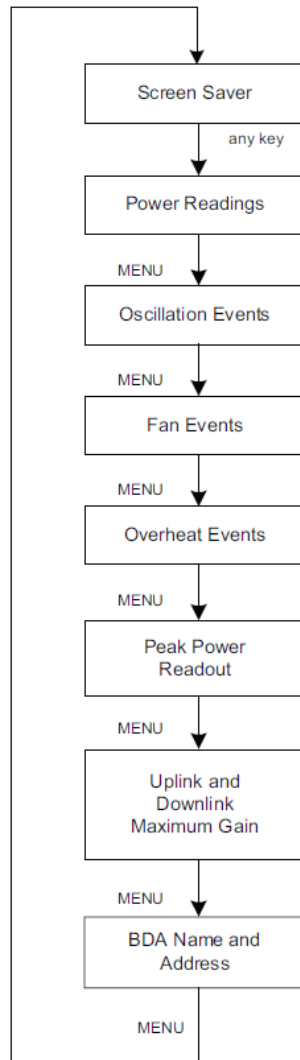

Figure 4-1: View Menu Series

4.2.1 Screen Saver Display

Upon powering up the BDA, a display resembling Figure 4-2 appears on the LCD panel:



Figure 4-2: Screen Saver Display

The first row contains the network name of the BDA; this allows the user to determine which BDA they are viewing. This name can be changed to whatever the user desires and can contain blank spaces, capital letters, lowercase letters, and numerals. It is limited to seven characters to facilitate communication with a web monitor, should one be desired.

This screen is known as the **Screen Saver** display because it is the screen that the BDA will revert to showing if there has been no activity detected on the keypad for at least ten minutes. If this occurs, the LCD backlight shuts off to save power and prevent the backlight from burning out. Pressing any key other than **Edit** while in the Screen Saver display will turn the backlight back on, and advance the menu to the Power Readout display. Pressing the **Edit** key will advance you to the Edit menu series.

4.2.2 Power Readings Display

This menu shows the instantaneous **Power Readings** in the BDA, as well as whether or not the gain is being actively attenuated by automatic gain control.

Figure 4-3 illustrates a typical Power Readings display:

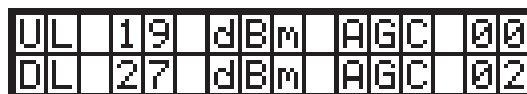

Figure 4-3: Power Readings Display

The power reading display in Figure 4-3 shows that the composite power is currently 19 dBm on the output of the uplink pass band, 27 dBm on the output of the downlink pass band, and automatic gain control has attenuated the signal 2 dB on the downlink pass band.

Note that when the power through a channel is less than 0 dBm, the display will show <00 in the location where the reading usually appears. This prevents spurious power readings from occurring because of random noise.

The **Up**, **Down**, and **Save** buttons have no effect in this menu, but pressing the **Menu** button will advance the user to the event readout displays.



4.2.3 Event Readout Displays

Within the BDA, three performance measures are tracked, recorded, and displayed as events. Up to 999 of each type of event is recorded. If more than this number of events are detected, the menu system will continue to display 999. Figure 4-4 shows a typical display:



Figure 4-4: Events Readout Displays

Three types of service-affecting events that the BDA records can be viewed within separate windows. Pressing the **Menu** button will sequence through these displays. The first window in the sequence displays isolation control events, the next window displays fan performance events, and the last window displays abnormal temperature events. A fourth menu press displays a recording of the UL and DL peak power.

After a window has been bypassed, all windows selectable through menu presses must be viewed in order to return to the last viewed display.

Any event will cause a yellow (warning) LED to illuminate. The warning LED can be extinguished by resetting the appropriate event counter(s) via the Edit menu or by cycling the primary power. Cycling primary power will reset the counters as well. Events capable of being recorded are:

Isolation control/Offset: This event is recorded whenever insufficient isolation exists between the donor and server antennae. When that condition occurs, the oscillation event counter will be incremented. Oscillation control is implemented in the BDA control system. If an oscillation condition is detected, the BDA control circuitry will attempt to stabilize the system by immediately reducing the gain 3 dB (offset). A warning will also be immediately displayed that shows the accumulated change on the affected link(s) e.g. UL (003 dB attn). After a period of time, the system will recheck itself and continue to reduce the gain in 3 dB increments until the oscillation conditions no longer exist. Each gain reduction is counted as an event. At some point, if stability cannot be reached, the BDA amplifier on the affected link will be shut down. After shutdown, or at any point after stability is reached, the system will attempt to fully recover lost gain. Until the system can recover to the original gain setting, the warning LED will remain illuminated.

Fan limits: The BDA system firmware monitors fan performance. If either fan speed exceeds specified limitations, a fan event will be recorded for each instance. A yellow LED will remain illuminated until the event counter is reset to zero. This feature is not available in firmware version 1.1.0 and prior releases.

Over temperature limit: Amplifier junction temperature is monitored continuously. If the temperature rises above a factory determined limit, an overheat event will be recorded. If the event is transitory, each excursion above the limit will increment the overheat counter. A yellow LED will remain illuminated until the counter is reset to zero.

Event counters serve as diagnostic tools for maintenance and system health assessments. Only isolation control will alter the intended performance of the system. Fan and overheat events have no effect on the BDA.

Pressing **Menu** within at this display will advance the user to the Peak Power display.



4.2.4 Peak Power Readout Display

The **Peak Power** Readout display shows the highest readings that have registered on the BDA since power-up or reset. Figure 4-5 shows a typical display.

UL	Pk	Pwr:	25		
DL	Pk	Pwr:	27		

Figure 4-5: Peak Power Readout Display

NOTE

Because the AGC cannot act instantaneously, the peak power seen on the output might be higher than the power the unit is capable of sustaining. This is not an error, but an indication that the power level was detected—briefly—at the output port. This is meant to aid in diagnostics, if necessary.

Pressing the **Menu** button will advance the user to the Downlink Gain display.

4.2.5 Gain Display

The **Gain Display** shown in Figure 4-6 indicates the gain applied to the uplink or downlink pass band. These values may differ if an offset has been applied.

UL	Gain:	67	dB		
DL	Gain:	67	dB		

Figure 4-6: Gain Display

Pressing the **Menu** button advances to the BDA Name display.

4.2.6 BDA Name and Address Display

In addition to its name, a BDA can be uniquely identified on a network with a web monitor by its network name. The network name is identical to the one in the screen saver display. The BDA name is limited to seven characters. Each BDA is accessible by a single web monitor on the network and must have a unique address, between one and seven, inclusive, within that network. This display also shows the current BDA's network address.



Figure 4-7 shows a typical BDA name and address display.



Figure 4-7: BDA Name and Address Display

Pressing the **Menu** button returns to the screen saver display.

NOTE

Pressing the **Edit** button in any of these displays causes the BDA to enter the Edit menu series. A password is requested from the user if password control has been enabled. Successful password entries permit the user to enter the Edit Menu Series; unsuccessful entries cause the BDA to revert to the screen saver display. The password menu does not belong to either the View menu series or the Edit menu series.

Figure 4-8 shows a typical password entry display.



Figure 4-8: Password entry display

NOTE

Each password consists of a series of five button presses. None of the buttons can be **Menu**. Pressing the **Menu** button or entering an invalid key in the password key sequence causes an immediate exit to the screen saver. To keep the password masked as it is entered, the bottom row reveals how many keys have been entered in the password thus far. In Figure 4-8 three of the five-key presses have been received and validated. Regardless of which display the user was viewing before entering password mode, successful password entry takes the user to the **Edit Oscillation Events** display.

4.3 The Edit Menu Series

The Edit Menu Series depicted in Figure 4-9 allows the user to alter the information stored in the BDA. These menus are only accessible if the user has a password and if password control is enabled. After entering this sequence of menus, the user can save changes by pressing **Save**. Pressing this button exits the **Edit Menu** series, so it is advisable to make desired changes beforehand. The **Edit BDA Name** menu is an exception; refer to the documentation for details. If no button is pressed within ten minutes of the last press, these menus will be exited and no changes will be saved.

The documentation to determine the function of the buttons in each of the menus. The password to enter the **Edit** menu series defaults to the following sequence until changed by the user: **Up, Down, Down, Up, Up**.

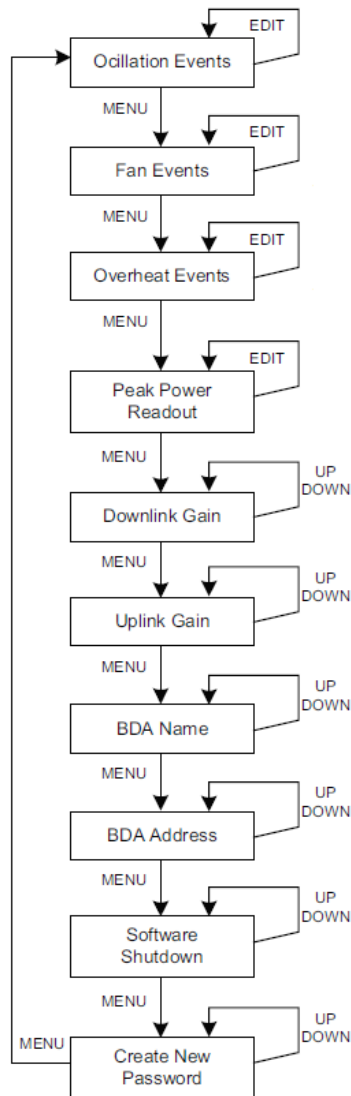

Figure 4-9: Edit Menu Series



4.3.1 Edit Events Display

Edit Events displays show the number of events recorded in each of three categories: oscillation, fans, and overheat. Each Menu button press moves to the next display. At any event category, pressing **Edit** will clear the counter and reset the number of events to zero.

To indicate that you are currently in the Edit series, the first word in the top line of the display is Edit, followed by the display name.

Figure 4-10 shows a typical Edit Events display.

EDIT	EVENTS:			
Overheat:	008			

Figure 4-10: Edit Events Display

4.3.2 Edit Peak Power Readout Display

The **Edit Peak Power** Readout display will show the same information indicated in the View menu series, however, pressing **Edit** clears the peak power readings and captures the current values.

Figure 4-11 shows a typical Edit Peak Power Readout display.

Edit	UL	Pk:	25	
Edit	DL	Pk:	27	

Figure 4-11: Edit Peak Power Readout Display

Pressing **Menu** at this point will cause the BDA to enter the Edit Downlink Gain display.

4.3.3 Edit Downlink Gain Display

In the **Edit Downlink Gain** Display window, the downlink gain can be altered, but it cannot be adjusted lower than the difference between the calibrated maximum output minus 30 dB (max gain -30 dB). The range of the attenuators in either the uplink or the downlink imposes this constraint. The values can be changed, within the permissible range, in 1 dB increments by pressing the up or down keys. If an attempt is made to change the gain value beyond a 30 dB range, the value increments to the highest or lowest acceptable value depending on which end of the constraint the attempt is initiated. By example, for an 80 dB gain amplifier the minimum gain setting is 50 dB. Pressing the down key when 50 dB of gain is currently being displayed will return gain setting to 80 dB. Likewise, if the gain setting is at 80 dB, pressing the up key will change the gain to 50 dB. Using another illustration, an amplifier having a maximum gain of 65 dB will have a minimum gain setting of 35 dB.



Figure 4-12 shows a typical Edit Downlink Gain display.



Figure 4-12: Edit Downlink Gain Display

The **Menu** button takes the user to the Edit Uplink Gain display.

4.3.4 Edit Uplink Gain Display

This display is functionally identical to the **Edit Downlink Gain** display, but alters the gain through the uplink pass band instead of the downlink pass band.

Figure 4-13 shows a typical uplink Edit Display.

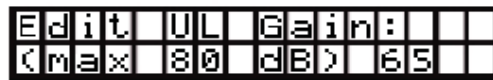

Figure 4-13: Edit Uplink Gain Display

Pressing the **Menu** key here will take the user to the Edit BDA Name display.

4.3.5 Edit BDA Name Display

The **Edit BDA Name** Display lets the user set a new name for the BDA for identification purposes on a web monitor network. This also changes the name shown on the screen saver display and the BDA Name display. A name can consist of uppercase letters, lowercase letters, numerals, and/or blank spaces.

A blinking cursor indicates which letter the user is editing; the edit process is executed from left to right. In any cursor position, characters are selected by using the **Up** and **Down** buttons. After the user has selected the letter for that position, pressing **Save** locks that letter into that position and advances the cursor to the right. Pressing **Edit** backs the cursor up one space and permits the user to edit that letter again using the same process. It is not possible to back up beyond the first character. Pressing **Save** on the seventh character causes the BDA to advance to the Edit BDA Address display, as will pressing **Menu** at any time. Pressing **Menu** will cancel any changes that the user has made to the BDA name.

Figure 4-14 shows a typical display for the Edit BDA Name Display menu.



Figure 4-14: Edit BDA name display menu

In Figure 4-14, the cursor shows that the user is at the fourth character position. In Figure 4-15, the user has pressed the **Up** and **Down** buttons to select **S**. The cursor at that position blinks intermittently, alternating with the character currently stored at that position, as shown in Figure 4-15:

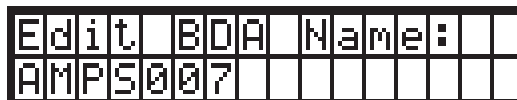

Figure 4-15: Example display when editing the BDA Name

Continuing the example, pressing **Up** at this point illustrates the advancement of the character at the current position to **T** as shown in Figure 4-16.

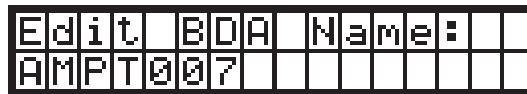

Figure 4-16: Another display when editing the BDA Name

4.3.6 Edit BDA Address Display

The **Edit BDA Address** Display permits the setting of a new address for a BDA on a web monitor network. Valid values are one to seven, inclusive. In this menu, take care not to set the address to that of another BDA on the same Web monitor network. The permissible addresses are presented in cyclical fashion.

Figure 4-17 shows a typical Edit BDA Address display.



Figure 4-17: Edit BDA Address Display

Pressing **Up** and **Down** will scroll through the different valid addresses. Pressing **Menu** will exit to the next screen (Software Shutdown display).



4.3.7 Software Shutdown Display

A **Software Shutdown** will prevent the BDA from functioning and will cease data acquisition by the BDA processor. By pressing **Up** and **Down**, the user can select one of two available modes: normal, which is the regular form of BDA operation, and shutdown, which performs a software shutdown of the BDA.

Figure 4-18 shows a typical Software Shutdown display.



Figure 4-18: Software shutdown display

After the BDA is shut down through software, the fault (red) LED glows.

When the BDA operation mode has been restored to normal, the fault LED extinguishes.

Pressing the **Menu** button at this point will cause the BDA to display the Create New Password display

4.3.8 Create New Password Display

The **Create New Password** Display allows the user to enter a new password. The display will not be viewable until password control is enabled by first pressing the proper keys simultaneously (**Save** and **Menu**). This operation will either enable the default password (**Up, Down, Down, Up, Up**) if no password change has ever been implemented, or the current password. Either password sequence is required to authorize a new password. Pressing **Edit** and **Menu** again will toggle the password off. This process requires the current password to complete the action.

Pressing any button after a new sequence has been entered will cause that sequence to be stored. Pressing **Menu** at any time during the sequence will abort the process and revert to the most recent password. If a change is successful, the new password will be required for future changes to be enabled.

Password control cannot be disabled without authorizing the mode change using the current password. The change password process is much the same as the password entry process described earlier. Figure 4-19 shows the display that asks for the current password:

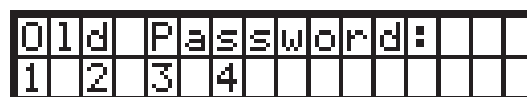

Figure 4-19: Old password display

Figure 4-20 shows the request for the new password.



Figure 4-20: New password display

A password can only consist of **Up**, **Down**, and **Save**, since **Edit** and **Menu** have global functionality.

Pressing **Menu** will abort this and return to the Edit Events display.

No changes take effect unless the user presses **Save**. After pressing save, all changes are saved to non-volatile memory and the BDA returns to the screen saver display. If the BDA does not detect any key presses within ten minutes of the last key press, the BDA discards all changes made in the Edit Menu series since the last password entry and reverts to the screen saver display.

NOTE

If the BDA becomes unstable and none of these menu commands are operable, reset the processor to factory defaults by pressing and holding the **Up**, **Down**, and **Menu** buttons simultaneously for one second. This is a catastrophic recovery measure, which should not be performed unless all other procedures have failed.

5 Registration Numbers

FCC

- NVRC510-S9, NVRC510-S89, NVRC610-S9, NVRC610-S89, NVRC510-P7, NVRC510-AP, NVRC610-AP, NVRBDA510-S8, NVRBDA510-P9, NVRBDA610-P9, NVBDA610-S8
- UL approved Power Supply: UL/C - UL/TUV/CE/RoHS Compliant



Appendix A Glossary

Table A-1 is a list of acronyms and abbreviations used in this manual.

Table A-1: Acronyms and Abbreviations

Acronym/Abbreviation	Meaning
AGC	Automatic Gain Control
APC	Automatic Power Control
AUI	Attachment Unit Interface
BDA	Bi-Directional Amplifier
DAS	Distributed Antenna System
Donor	Outside Antenna to feed BDA
ERP	Effective Radiated Power
FCC	Federal Communications Commission
FPGA	Field Programmable Gate Array
LED	Light Emitting Diode
OIP3	Third-Order Intercept Point
RF	Radio Frequency
USB	Universal Serial Bus