



***CSI-DSP85-250-PS7, CSI-DSP85-251-PS7
&
CSI-DSP85-250-PS8, CSI-DSP85-251-PSS8***

Table of Contents

Document Purpose / Intended Users	4
Application	4
Product Registration Information	4
Safety Guidelines	4
Important Safety Information	5
Product Introduction	5
Terms used in this manual	5
700 MHz Filter Naming Convention and Band Plan	6
800 MHz Filter Naming Convention and Band Plan	7
LED Indicator	8
Functional Overview	8
Local Communication Interface Ports	9
Monitoring & Alarms	9
Ethernet	9
USB Interface	9
Selection of external attenuators to be used in line with the Antenna Port(s):	10
System Set-Up Considerations	10
DONOR PORT	10
Attenuator Selection Guidelines	11
SERVER PORT	11
Mounting the Digital Repeater	12
Optional Accessories	13
Dry Contact Terminal	13
Circuit Operational Description	14
Important Installation Notes	14
Functional Block Diagram	14
AC Power Specifications	15
Environmental Requirements	15
Mechanical Specifications	15
Operating Power Parameters	16
Mechanical Drawing	17
System Status:	18
Web based GUI Session	18
Local Network:	19
Program a Filter:	20
RF Configuration:	20
Remote Network:	21
SNMP Configuration:	21
Install & Upload:	22
System Health:	22
Reboot:	23
Email Configuration:	23
Alarm Configuration:	23
Change Password:	24
Log Configuration:	24
Terminal Emulation Program	25
Text Menu Interface (Local Access)	25
Terminal Emulation Set-up	26
TMI Login	27
Telnet Session (Remote Access)	29
Telnet Session Login	30
Modem Interface (Remote Access with login)	31
Additional Tips	32
Suggested spectrum analyzer setting:	34
RF Notes:	34
Industry Certifications/Registration Numbers:	35
Index	36

Product Registration Information

The serial number may be found on the label on the bottom panel near the power connectors. Note this number below. Retain this manual, along with proof of purchase, to serve as a permanent record of your purchase.

MODEL NUMBER

SERIAL NUMBER

DATE OF PURCHASE

POINT OF SALE COMPANY

DISCLAIMER: All information and statements contained herein are accurate to the best of the knowledge of Cellular Specialties, Inc. (CSI), but Cellular Specialties makes no warranty with respect thereto, including without limitation any results that may be obtained from the products described herein or the infringement by such products of any proprietary rights of any persons. Use or application of such information or statements is at the users sole risk, without any liability on the part of Cellular Specialties, Inc. Nothing herein shall be construed as licence or recommendation for use, which infringes upon any proprietary rights of any person. Product material and specifications are subject to change without notice. Cellular Specialties' standard terms of sale and the specific terms of any particular sale apply.

Document Purpose / Intended Users

The purpose of this document is to provide a step-by-step procedure to help the experienced technician/engineer install and commission an in-building wireless enhancement repeater system using CSI's Digital Repeater. Following the procedures outlined will minimize risks associated with modifying a live system and prevent service interruptions. This document assumes the technician/engineer understands the basic principles and functionality involved with Repeater and in-building systems. It is geared to the practical concerns of the installer.

Application

This guide should be applied whenever a need exists to add Digital Repeater capability to an existing system or when this capability is being included with a new installation.

Safety Guidelines

The general safety information in this guideline applies to both operating and service personnel. Specific warnings and cautions will be found in other parts of this manual where they apply, but may not appear in this summary. Failure to comply with these precautions or specific warnings elsewhere in the manual violates safety standards of design, manufacture, and intended use of equipment. Cellular Specialties, Inc. assumes no liability for the customer's failure to comply with these requirements:

Grounding

This Digital Repeater system is designed to operate from 100-240 VAC and should always be operated with the ground wire properly connected. Do not remove or otherwise alter the grounding lug on the power cord.

Explosive Atmospheres

To avoid explosion or fire, do not operate this product in the presence of flammable gases or fumes.

Lightning Danger

Do not install or make adjustments to this unit during an electrical storm. Use of a suitable lightning arrester, such as CSI's model number CSI-CAP, is very strongly recommended.

No User Serviceable Parts Inside

HAZARDOUS VOLTAGES ARE PRESENT WHEN THE COVER IS REMOVED. Opening the chassis will void your warranty. If you suspect a malfunction with this product, call your dealer or the Cellular Specialties Support Line at: **(603) 626-6677, Toll Free (USA) 1-877-844-4274.**

Important Safety Information

Antennas used for the purpose of radiating signals indoors are limited to a *maximum* gain of 3 dBi. The outdoor antenna used for the purpose of communicating to the wireless infrastructure is limited to 14dBi gain, or any combination of gain and loss that equates to 14dB at input. Each antenna must be positioned to observe minimum separation requirements from all users and bystanders. The following guidelines should be used when considering separation distances.

INDOOR antennas must be placed such that, under normal conditions, personnel cannot come within 60 cm (~2.0 ft) from any inside antenna. Adhering to this minimum separation will ensure that the employee or bystander cannot exceed RF exposures beyond the maximum permissible limit as defined by section 1.1310 i.e. limits for General Population/Uncontrolled Exposure.

OUTDOOR antenna must be positioned such that, under normal conditions, personnel cannot approach closer than 183 cm. (~6 ft.). A directional antenna having a maximum gain of 14 dBi is used, precautions should be taken to prevent personnel from routinely passing through the main radiation beam at a distance closer than specified.

Terms used in this manual

AGC = Automatic Gain Control	ERP = Effective Radiated Power
APC = Automatic Power Control	FPGA = Field Programmable Gate Array
AUI = Attachment Unit Interface	LED = Light Emitting Diode
CPU = Central Processing Unit	OIP3 = Third-Order Intercept Point
CSI = Cellular Specialties, Inc.	RF = Radio Frequency
DAS = Distributed Antenna System	SBC = Single board Computer
DHCP = Dynamic Host Configuration Protocol	SNMP = Simple Network Management Protocol
DSP = Digital Signal Processing	TMI = Text Menu Interface
EEPROM = Electrically Erasable Programmable read-only Memory	USB = Universal Serial Bus
	UHCI = Universal Host Controller Interface

Product Introduction

Cellular Specialties, Inc. (CSI) developed the DSP85 digital repeater for use within enclosed structures where signal from local dispatch sites is insufficient to operate on scene communication equipment. Adequate signal must be available outside the structure as a prerequisite to achieving in-building coverage. The Digital Repeater is connected to an external antenna, usually on the roof, and to one or more internal antennas placed strategically throughout the area where wireless service is desired.

The external antenna typically is directional, such as a "yagi". Internal antennas are typically omnidirectional, although various other types may be used depending on the coverage application. The CSI DSP Repeater amplifies both the "uplink" (Transceiver to tower) & "downlink"(tower to Transceiver) signals thus facilitating communications to and from the intended wireless infrastructure.

With a maximum total of +85dB nominal gain on both the up and down links, gain can be adjusted over a range from +53.5dB to +85dB in 0.5dB steps. Control of the repeater is achieved utilizing a computer connected to comm. port 1 or 2 or via a Crossover Ethernet cable connected to the Ethernet port. There are also LED indicators near the display to indicate ALARM status, AGC status, UL PWR, DL PWR, OSC, SHUT DWN and a D/L SIGNAL STRENGTH bargraph.

A specific filtering process modifies each amplification chain. This process digitally converts the assigned spectrum and then applies digital signal processing (DSP) techniques. DSP is used to create passbands that selects the RF energy passing through either the uplink or downlink paths. After the digital processing is complete, the information is converted back to an analog signal that is applied to the remaining stages of amplification. The resulting signals emitted by the repeater are specific to the network service providers' requirements. If these requirements change, only the DSP configuration parameters need change in order to adapt. Configuration parameters are created at the factory and supplied as files that may be downloaded to the repeater. The filter set configurations stored in memory determine the unit's adaptability to various field applications. The following pages describe the public safety band plan as well as the convention CSI uses to identify and store the files that make up the filter set. All DSP85 repeaters are shipped with an active filter set that is programmed according to the ordering parties' specifications. In most cases, the installer will not have to program a filter.

700 MHz Filter Naming Convention and Band Plan

CSI Public Safety 700 MHz Band Filter File Naming Convention

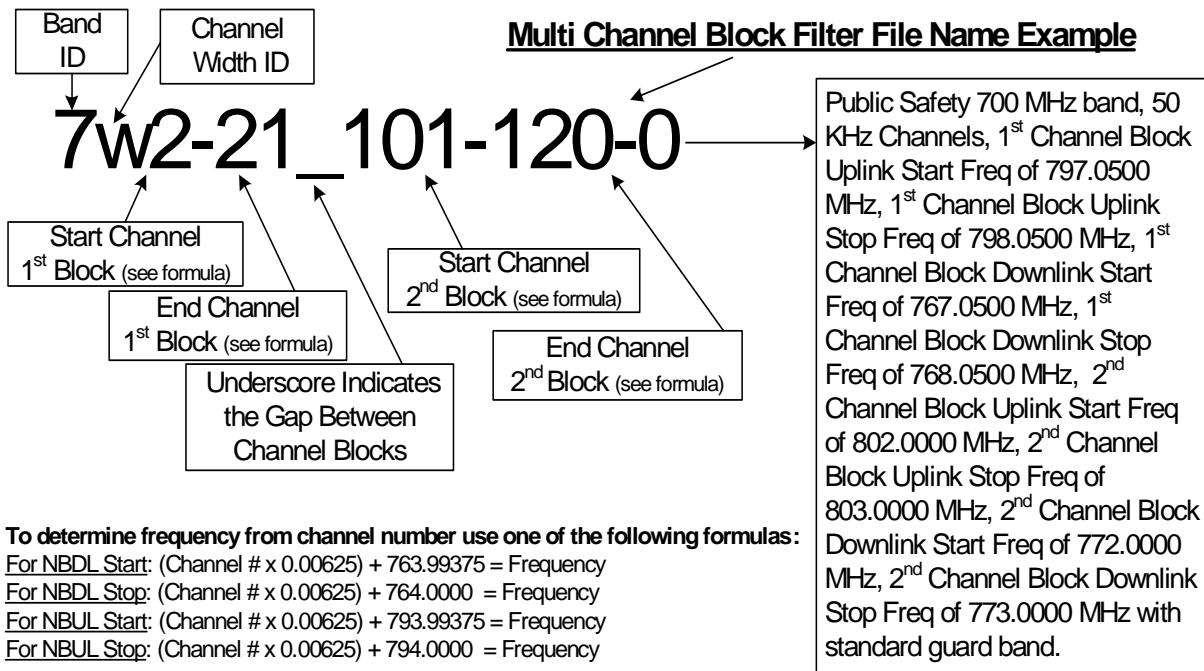
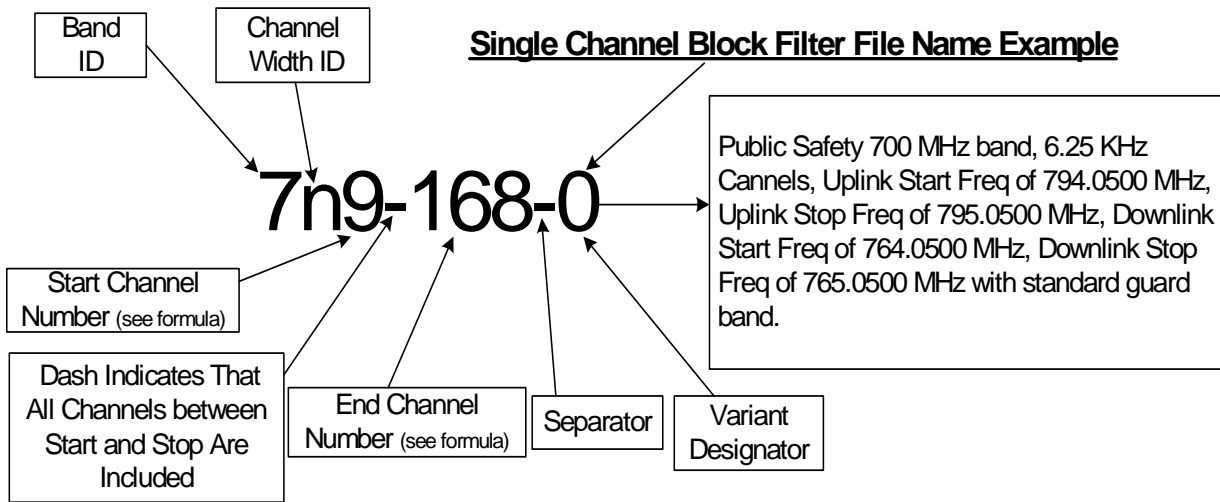

To determine frequency from channel number use one of the following formulas:

- For NBDL Start: $(\text{Channel \#} \times 0.00625) + 763.99375 = \text{Frequency}$
- For NBDL Stop: $(\text{Channel \#} \times 0.00625) + 764.0000 = \text{Frequency}$
- For NBUL Start: $(\text{Channel \#} \times 0.00625) + 793.99375 = \text{Frequency}$
- For NBUL Stop: $(\text{Channel \#} \times 0.00625) + 794.0000 = \text{Frequency}$

- For WBDL Start: $(\text{Channel \#} \times 0.05) + 766.95 = \text{Frequency}$
- For WBDL Stop: $(\text{Channel \#} \times 0.05) + 767.0000 = \text{Frequency}$
- For WBUL Start: $(\text{Channel \#} \times 0.05) + 796.95 = \text{Frequency}$
- For WBUL Stop: $(\text{Channel \#} \times 0.05) + 797.0000 = \text{Frequency}$

Notes:

- 7 = Public Safety Band 700 MHz
- n = 6.25 KHz Channels, w= 50 KHz Channels
- See the formulas to correlate frequencies to the channel numbers used in this file name convention.
- CSI DSP II repeaters are capable of up to four channel blocks in one file configuration.

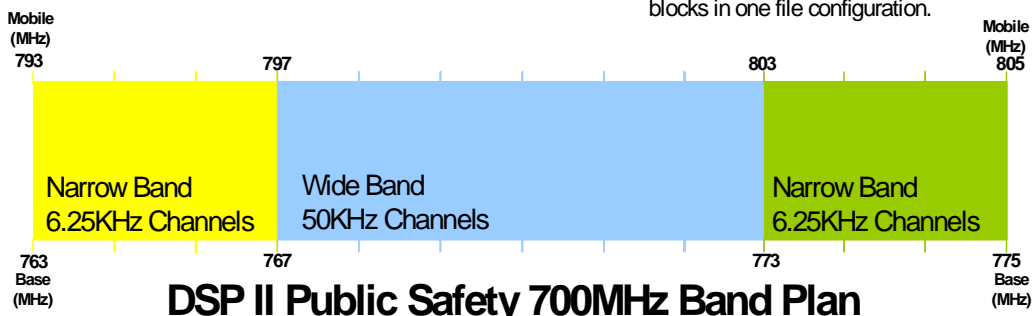

DSP II Public Safety 700MHz Band Plan

800 MHz Filter Naming Convention and Band Plan

CSI SMR 800 Filter File Naming Convention

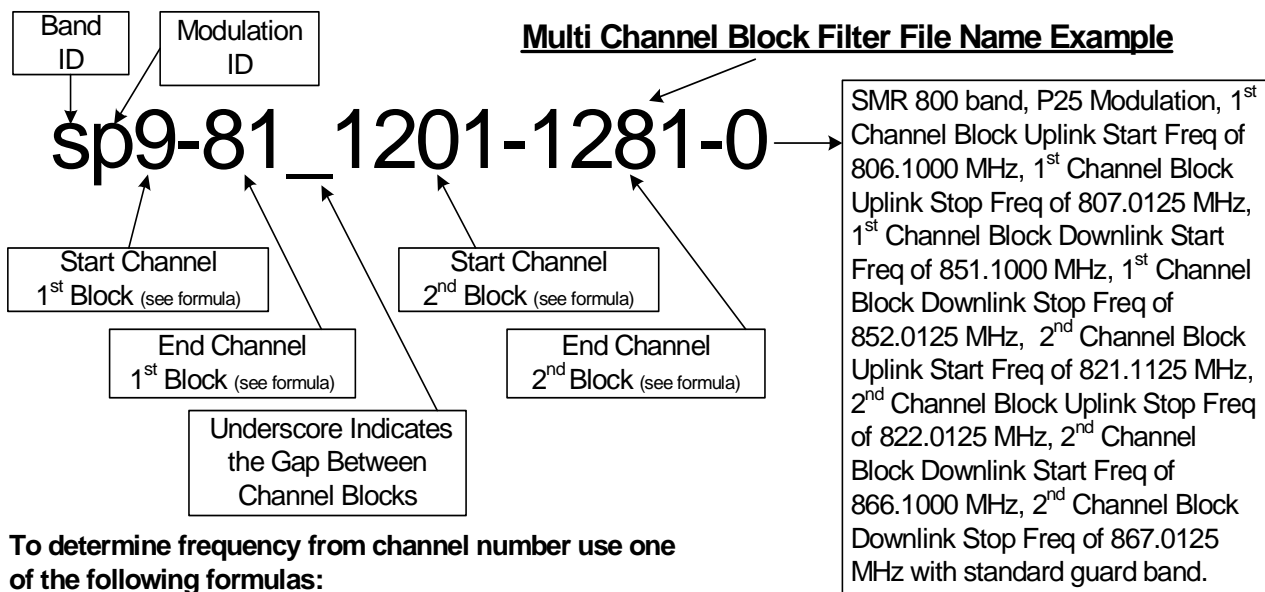
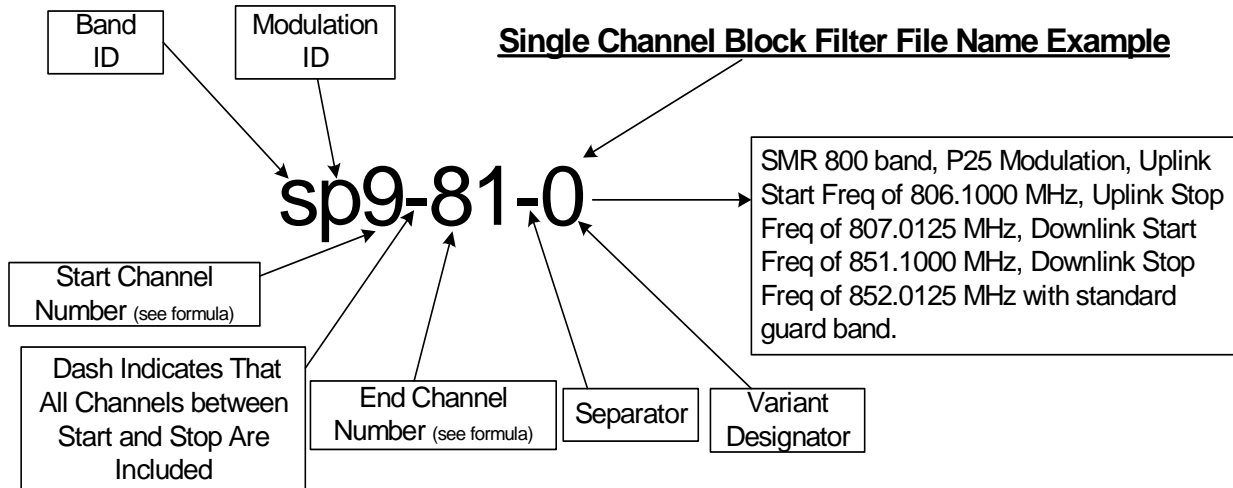

To determine frequency from channel number use one of the following formulas:

- For DL Start: $(\text{Channel \#} \times 0.0125) + 850.9875 = \text{Frequency}$
- For DL Stop: $(\text{Channel \#} \times 0.0125) + 851.0000 = \text{Frequency}$
- For UL Start: $(\text{Channel \#} \times 0.0125) + 805.9875 = \text{Frequency}$
- For UL Stop: $(\text{Channel \#} \times 0.0125) + 806.0000 = \text{Frequency}$

Notes:

1. s = SMR 800 Public Safety Band
2. p = P25 Modulation
3. See the formulas to correlate frequencies to the channel numbers used in this file name convention.
4. CSI DSP II repeaters are capable of up to four channel blocks in one file configuration.

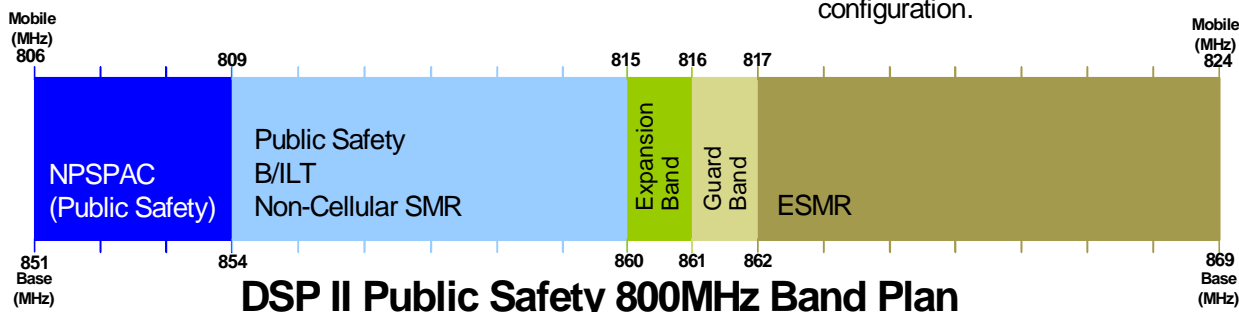

Functional Overview

CSI digital repeaters incorporates the following features for convenient operation, access, protection, and control.

- Network Configuration and Control using either a webpage style GUI through any standard browser or a menu driven user interface using the serial port.
Note: GUI does not require Internet access.
- User Gain Control (affects all passbands)
- Automatic Gain Control
- Automatic Power Control
- Oscillation Protection
- Over Drive Protection (P.A. limiting)
- Under/Over Voltage Protection
- Fault Protection
- Alarm Notification - Local/Remote
- Upgrade Support - Local/Remote
- External Interfaces - USB/Ethernet/Serial
- Re-loadable filters - Local/Remote
- Web-based monitoring and control - Local/Remote
- Persistent Status and Error information

LED Indicator

Automatic safety precautions are built into the amplifier system. In the case of a catastrophic system event, a shutdown circuit is incorporated that will disable all emissions should the uplink input or downlink input be over driven or should an oscillation or output overpower event occur. The amplifier will periodically attempt to recover from the detected condition automatically. Warning light indicators are as follows:

When a boot up is complete and no alarm conditions exist, the LED indicator will be illuminated green. Should a fault condition develop the LED will illuminate red and the user may check the status page of the GUI for the nature of the fault.*

* Note: During Power up, the repeater will require a approximately three minutes for the internal computer to boot up. During this time the LED on the front panel may light and go out several times.

Do not unplug the unit while it is in the boot up process!

Local Communication Interface Ports

To allow monitoring and control, the repeater is equipped with four ports that provide external communication access (1 Ethernet CAT-5, 2 DB-9 serial, and 1 USB). The Ethernet, CAT-5 port is provided as a primary communications port to the PC. One serial interface provides communications to local PC and the second to an external modem when provided. The USB interface provides a means to download files from a memory device and may also be used by an external modem. The DB-9 pin assignments conform to the standard Electronic Industries Association (EIA232) specification. A diagram of the pin descriptions is provided on this page for reference.

Connecting a null modem cable to one of the COM ports and using a terminal emulation program with a PC will allow communication to the control processor's Text Menu Interface (TMI). See command line interface section for further detail.

EIA232 Pin Specifications

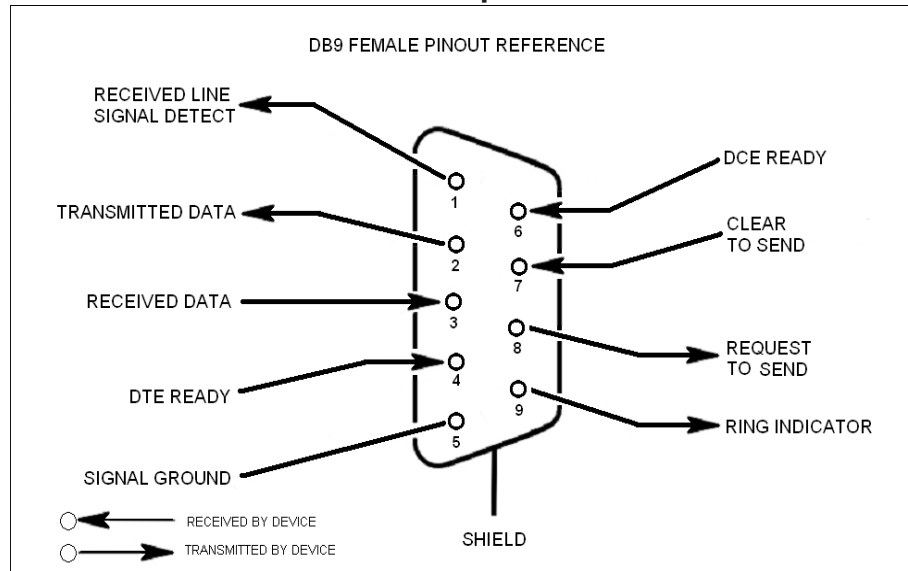

The diagram above is for reference only, it's intended to provide a quick source for pinout information in the event it should be necessary to adapt your serial cable because of an unusual connector configuration. In the vast majority of cases this information will not be needed.

USB Interface

The Universal Serial Bus (USB) interface conforms to Intel's Universal Host Controller Interface (UHCI) version 1.1 dated March 21, 1996. This interface will support data transfer rates up to 12 Mbps and can be used for software updates and filter file uploads.

Ethernet

The Ethernet AUI conforms to IEEE 802.3 and is capable of supporting 10/100 Mbps communications speeds. This port is used to provide access to the GUI.

Monitoring & Alarms

There are no physical connections provided to specifically communicate system or alarm status. This information is embedded in the information accessible via the communication ports described earlier.

System Set-Up Considerations

All cables should be checked for shorts and opens. Also verify that there are no cables with loose or poor connections. RF leakage could cause oscillation to occur under some conditions.

The rooftop antenna (Donor Antenna), if directional, should be checked for proper alignment along the calculated compass heading. Typically, the directional antenna would be aimed at the same site that your handset uses, but it may not always be so. **It is critical the installer contact the service provider for information on, and approval of the cell site he or she has selected before the system is turned on.**

If cables and alignment are acceptable and a problem persists, it may be necessary to use a spectrum analyzer to examine the signal environment in which the repeater is operating. The existence of strong adjacent channel signals within the frequency band(s) can cause the AGC to reduce the amplifier's gain or cause alarms. In some cases additional filtering or attenuation might be required to reject these unwanted signals. In some instances, the donor antenna can be reoriented horizontally, to place the interference source in an antenna pattern "null". There also may be some cases where the interference from outside signals is so great that they cannot be filtered or otherwise reduced or eliminated without expensive and possibly prohibitive measures. In these cases it may not be practical to use the repeater for providing coverage to these sites.

Selection of external attenuators to be used in line with the Antenna Port(s):

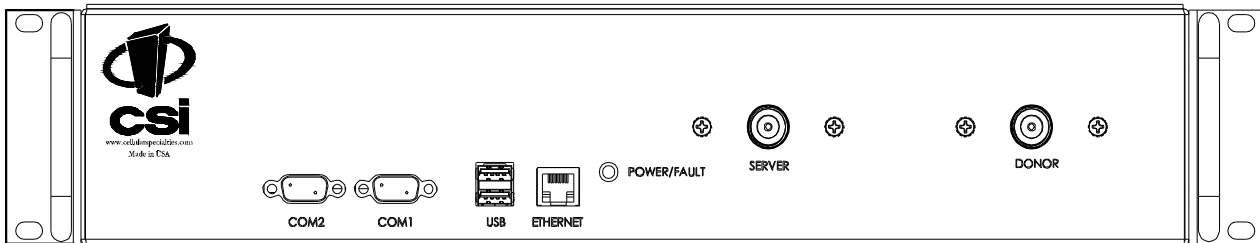

1:1 PORT CONFIGURATION

Input: One single band duplex port, from the dual band donor.

Output: One single band duplex port to the DAS.

DONOR PORT

If a CSI-DSP85 is installed in an area with very strong desired and/or undesired signals, it is important to ensure that the overall signal levels are optimized to be within the best operating range of the repeater. Additionally, de-sensing of a nearby base station site must be avoided. These goals can be accomplished by properly attenuating the antenna port(s) in the path of the donor antenna(s). In effect, one can imagine that the particular repeater deployment is electrically moved farther from the base station using attenuators that are equivalent to increasing the path loss from the donor antenna to the base station. The following potential outcomes result from the use of attenuators on the donor port(s) of the CSI-DSP85: Uplink output power, as reported by the CSI-DSP85, is reduced by the value of the attenuation, protecting nearby base stations. Downlink signal to noise ratio is high at the point of the attenuator, resulting in slight but negligible reduction in downlink performance. Other performance is essentially unchanged.

SERVER PORT

Server port attenuation may also be necessary, particularly where a powered DAS is present. The selection guidelines below apply to both server and donor ports. In order to properly measure uplink signal strength, a signal generator should be used. If a signal generator is not available, placing a test call while under the server antenna with the least path loss to the repeater should provide reasonable data.

The following potential outcomes result from the use of attenuators on the server port(s) of the CSI-DSP85: Downlink output power, as reported by the CSI-DSP85, is reduced by the value of the attenuation. Uplink incoming power from the DAS is reduced, along with potentially strong and/or harmful out-of-band signals (including noise) that are generated by the DAS.

Attenuator Selection Guidelines

Accurate attenuator values need to be chosen to ensure that the maximum total power (higher of Composite or In-Band Input) applied to the donor and server port(s) does not exceed the following thresholds:

<u>Input Signal</u>	<u>Max Gain</u>	<u>Input Signal</u>	<u>Max Gain</u>
≤-45 dBm	85 dB	-32.2 dBm	69 dB
-44.3 dBm	84 dB	-31.4 dBm	68 dB
-43.6 dBm	83 dB	-30.6 dBm	67 dB
-42.9 dBm	82 dB	-29.8 dBm	66 dB
-42.2 dBm	81 dB	-29 dBm	65 dB
-41.5 dBm	80 dB	-28.2 dBm	64 dB
-40.6 dBm	79 dB	-27.4 dBm	63 dB
-39.7 dBm	78 dB	-26.6 dBm	62 dB
-38.8 dBm	77 dB	-25.8 dBm	61 dB
-37.9 dBm	76 dB	-25 dBm	60 dB
-37 dBm	75 dB	-24.4 dBm	59 dB*
-36.2 dBm	74 dB	-23.8 dBm	58 dB*
-35.4 dBm	73 dB	-23.2 dBm	57 dB*
-34.6 dBm	72 dB	-22.6 dBm	56 dB*
-33.8 dBm	71 dB	-22 dBm	≤ 55 dB*
-33 dBm	70 dB		

***We recommend padding this level due to potential for fluctuating signal.**

-25 dBm is the maximum input signal level that should be applied to the repeater, even if the gain is lower than 55 dB.

Input signals exceeding these thresholds will result in composite input attenuation, called “**ADC Protect**” (Analog to **D**igital **C**onverter **P**rotection). Output power is reduced whenever the above thresholds are exceeded by reducing the gain by 1dB for each 1 dB that the threshold is exceeded. ADC Protect should not be confused with **AGC** (**A**utomatic **G**ain **C**ontrol), which reduces gain to prevent **In-Band** (measured) output power from exceeding the specified maximum output level. To determine the total power applied to the donor and server ports, please reference the “Composite Input” values as reported in the Web (“System Status”) or Menu (“Link Status”) interfaces (depicted and explained later in this manual).

Large delta’s between in-band and composite input signals:

Care should be taken to isolate the best donor site to ensure the least possible delta between in-band and composite downlink signals. If the (downlink) composite input exceeds the in-band input by more than 3 dB for the SMR band the maximum output power will be reduced.

Mounting the Digital Repeater

The following diagrams illustrates the methods for mounting the repeater(s) in a typical wall or rack installation. Brackets are provided for both options.

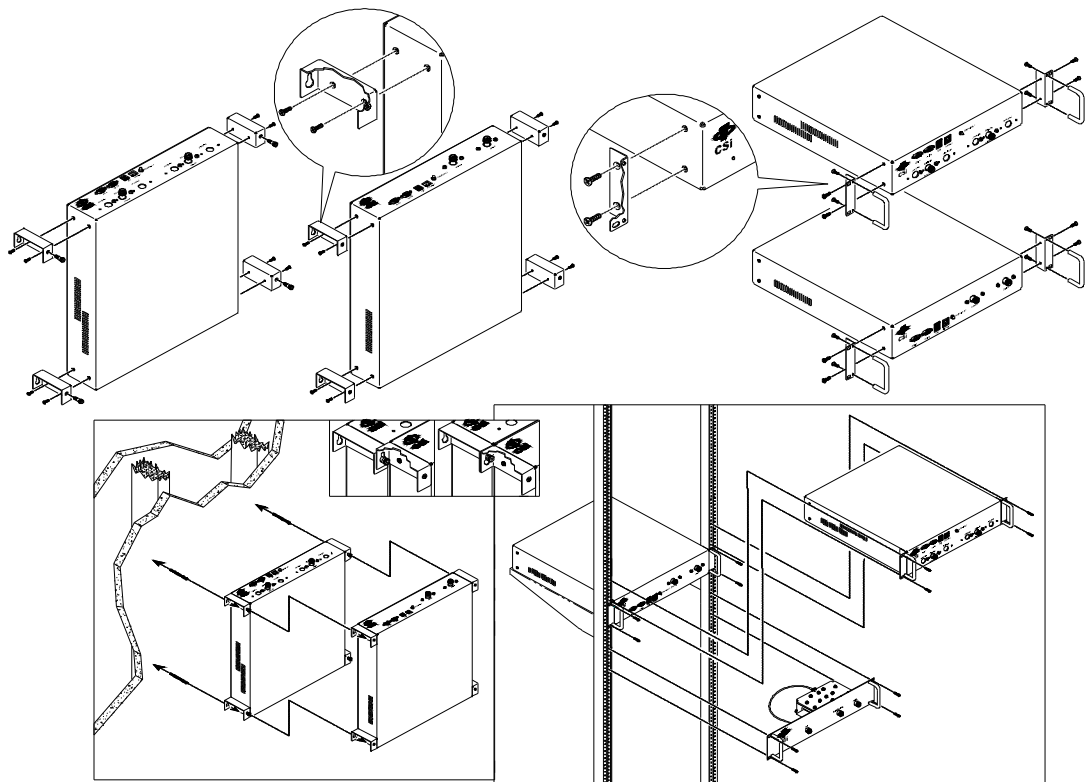

Rack mount of the repeaters requires just two brackets mounted to the front corners of each module. Note: the CSI digital repeaters must be supported in the rack system with a shelf or slide rail. **Do not rely on the brackets exclusively to support all the weight of the modules.**

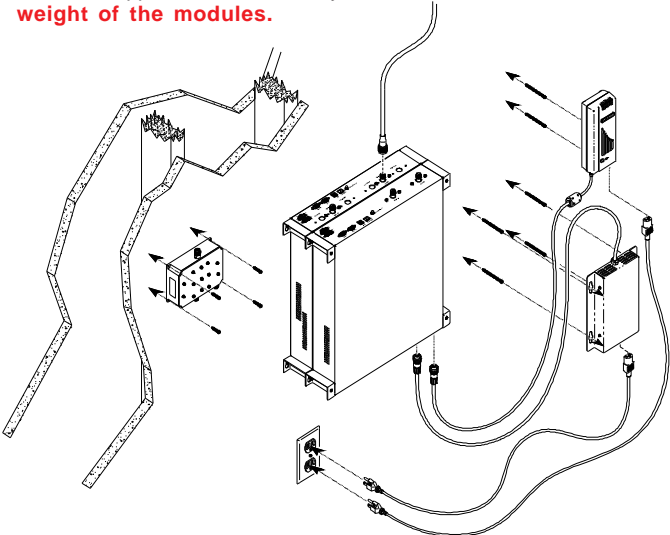

Mount the Cross Band Coupler on the wall close enough to the repeater modules to allow the RF jumpers to reach from the CBC to the repeaters. The attachment system used to anchor the CBC to the wall must be able to support at least 4.2 lbs / 1.9 kg.

The wall anchoring system you use for the repeaters will need to be able to support at least 19.6 lbs/ 8.9 kg for each dual band module and 11.6 lbs/ 5.3 kg for each single band add on module. The power supplies are mounted approximately as shown.

Interconnection of the repeaters in the rack or wall mount configuration requires the short RF Jumpers supplied with the CBC Module. The actual interconnections will depend on the bands and cross band coupler module being used. Contact Cellular Specialties Support Line at: **(603) 626-6677, Toll Free (USA) 1-877-844-4274** should you have questions about you specific application.

Warning: On the standard model, power supply cable connectors are keyed for proper orientation, but if forced can be inserted incorrectly. Great care should be taken to avoid this as it may damage the connectors and/or the repeater. This does not apply to the weather resistant model, which uses an internal power supply

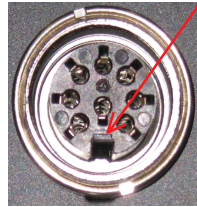
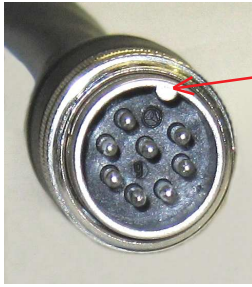

Keyed for proper alignment, do not force connector into place.

Dry Contact Terminal

This CSI Digital Repeater is equipped with an automatic amplifier safety shutdown circuit that will disable the transmitter, to prevent excessive intermodulation and oscillation, should the uplink or downlink overloads be reached. The amplifier will periodically attempt to recover from this condition.

In order to provide an indication of this shutdown, a terminal block mounted externally is provided for remote monitoring. Terminals 1 and 2, labeled NO and NC respectively, will toggle from open to close with major faults.

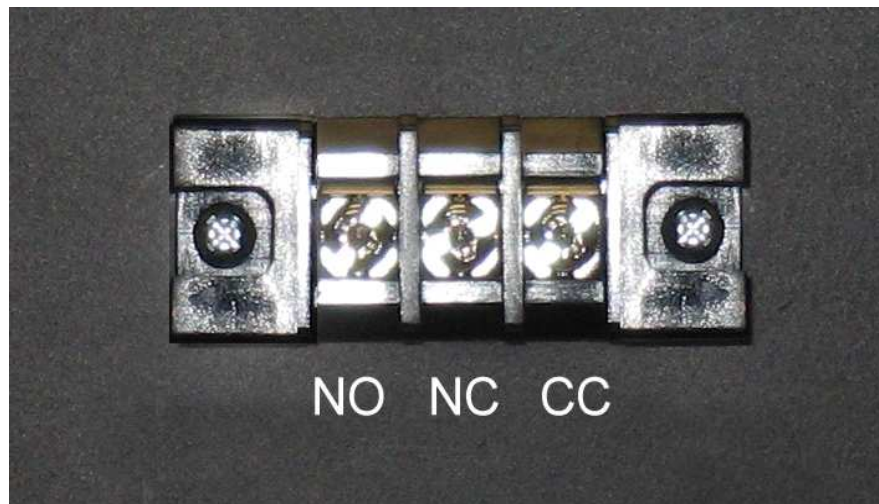

Optional Accessories

A complete line of accessories is available from Cellular Specialties, Inc. Check with your CSI distributor for any additional items needed. Below are just a few examples suitable for most in-building needs.

•Outside Donor Antenna

Yagi - model number: **CSI-AY/806-960/14**

Panel - model number: **CSI-AP/698/2.2K/7-10**

•Inside Omnidirectional Antenna

Quad-band - model number: **CSI-AO/700/2.7K/3**

•Directional Couplers

6dB - model number: **CSI-DC6/700-2.5K/N**

10dB - model number: **CSI-DC10/700-2.5K/N**

15dB - model number: **CSI-DC15/700-2.5K/N**

20dB - model number: **CSI-DC20/700-2.5K/N**

30dB - model number: **CSI-DC30/700-2.5K/N**

•UPS

Battery backup, 2 hr Single band

1 hour dual band - model number: **CS48-985-600**

Battery backup, 4 hr Single band

2 hour dual band - model number: **CS48-985-601**

•Power Dividers

2:1 - model number: **CSI-SPD2/700-2.5K/N**

3:1 - model number: **CSI-SPD3/700-2.5K/N**

4:1 - model number: **CSI-SPD4/700-2.5K/N**

•Grounding Kit - model number: **CSI-GKIT**

•Lightning Arrestor - model number: **CSI-CAP**

•Mounting Kit

19" rack or wall mountable -

model number: **CSI-RWM-DSP85**

Important Installation Notes

- Inadequate isolation between the outside and inside antennas may cause regenerative feedback in the system. This feedback can cause the amplifier to emit a continuous signal at maximum amplitude and, in some cases, interfere with normal operation of the dispatch site. Careful consideration of the layout and placement of the system is imperative.
- The installer should refer to the Safety Guidelines section on page 4 and the Important Safety Information section on page 5 for proper antenna selection and installation. To avoid serious injury or death and damage to the repeater, do not install donor or server antennas near overhead power lines or high power components. Allow enough distance so that if antennas should fall they will not come in contact with those components.
- Close proximity to the donor or server antennas with the repeater in operation may expose the user or installer to RF fields that exceed FCC limits for human exposure.

WARNING! AMPLIFIER OR HANDSET DAMAGE MAY OCCUR IF A HANDSET IS CONNECTED DIRECTLY TO THE REPEATER OR THE COAX THAT LEADS TO THE REPEATER.

Circuit Operational Description

The repeater uses a single down-conversion/up-conversion scheme. There are multiple RF amplifier stages prior to each down-converting mixer. The down-converting mixers are followed by a single IF amplifier. A Digital Signal Processor block then processes the resultant digitized IF signal that was previously generated by an Analog-to-Digital Converter. The processed (filtered) digital signal is fed to a Digital-to-Analog converter and then up-converted to RF. A driver amplifier and a final power amplifier make up the final gain stages before application to the diplexer. The maximum total system gain (diplexer input to diplexer output) is nominally 85 dB for either the downlink or the uplink paths with both links having independent manual and automatic gain controls (AGC).

AGC reacts to analog power detection on both the input and output of the uplink and downlink RF chains. A control algorithm continuously monitors these detected values and dynamically adjusts various gain stages such that the net system gain value, entered manually, is maintained without either exceeding FCC parameters or overdriving the A/D converters.

LEDs on the front panel display provide immediate visual indications of the unit's primary power and major or minor alarm status. The repeater features automatic shutdown protection, as a safety measure, should excessive drive be applied to the input or an oscillation condition occur. When in a protected mode, a control algorithm determines the appropriate method of recovery to a normal, previously defined state, or maintains the protection until manually reset. If recovery has been established, the associated LED(s) will either be extinguished or available to be reset. The events that trigger the error will be saved in the event log.

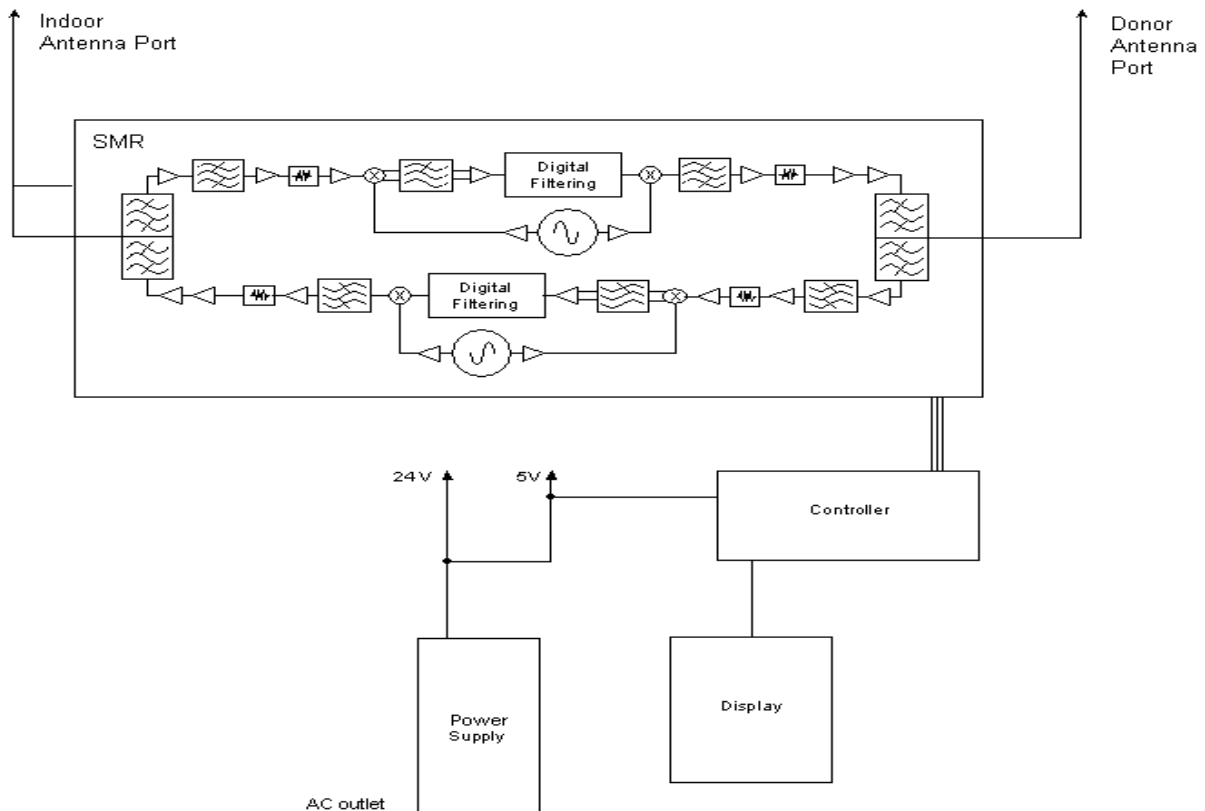

Functional Block Diagram

Mechanical Specifications

Parameter	Specification	Notes
Repeater Size		
Height	3.48 in.	
Width	19.00 in.	
Depth	18.00 in.	
Box Weight	11.6lbs / 5.3 kg	
Box Thermal Management	Fan cooled	
Surface Coating	Powder Coat	
Color	Satin Black	

Environmental Requirements

Parameter	Specification	Notes
Temperature Range	0° to +50° C (32° to +122° F)	
Relative Humidity	5% to 95%	Non-condensing

AC Power Specifications

Parameter	Specification	Notes
AC Voltage	100 - 240 VAC	External Power Supply
AC Current	1.7 Amps 0.9 Amps	@ 120 VAC @ 230 VAC
AC Power Frequency	47 - 63 Hz	
Heat Output	500 BTU/Hr	

Operating Power Parameters

Parameter	Specification	Notes
Maximum RF input Power without damage	+10 dBm	
Linear Gain	85 dB	Factory Calibrated Gain
Pass Band Ripple	+/-1.5 dB	
Automatic Gain Control (AGC)	30 dB max range	In 0.5 dB steps
Manual Gain Control	53.5-85 dB max	In 0.5 dB steps
Linear Output Power CSI-DSP85-250-PS7 and CSI-DSP85-250-PS8 CSI-DSP85-251-PS7 and CSI-DSP85-251-PS8	+ 27dBm max + 30dBm max	Uplink and Downlink
OIP3	+ 43 dBm	Measured with 2 CW tones at 14 dBm/tone
Noise Figure (Avg)	5.0 dB	At Maximum Gain
1dB Compression	+ 33 dBm	Uplink and Downlink
Input VSWR (Typ)	<1.5:1	
Propagation Delay	<2.5 usec	
RMS Vector Error (EVM)	3% max	TDMA, EDGE, W-CDMA, CDMA2000, P25
CDMA RHO	0.98 min	CDMA2000, 1x-EVDO
Connectors	N-Female (2)	
Spurious Emissions & Applicable Documents FCC Industry Canada	-13 dBm max -13 dBm max	Per FCC part 2 and 90

Mechanical Drawing

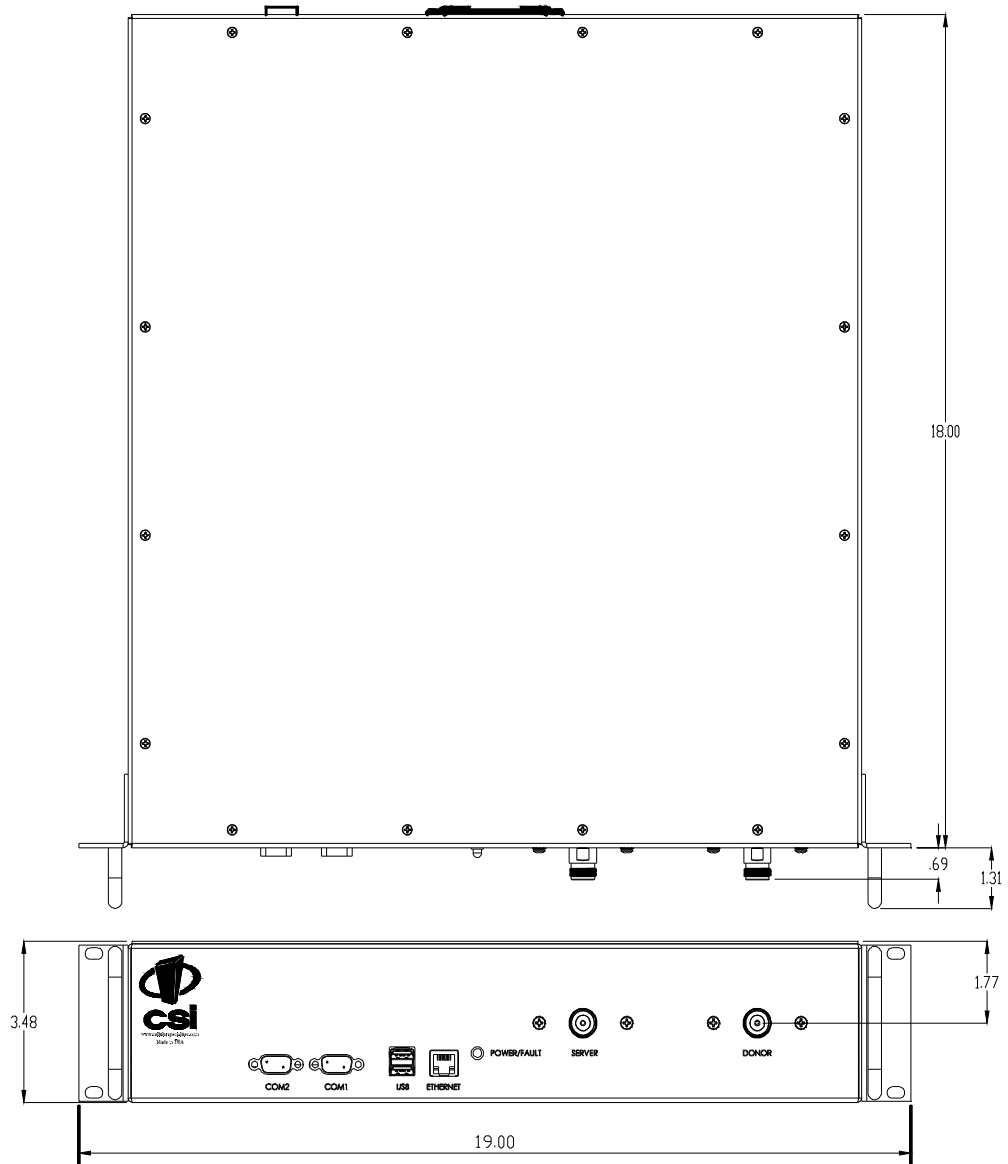

Web based GUI Session

Primary access to the repeater is gained using a LAN connection and a web browser program such as Firefox by Mozilla, or Internet Explorer from Microsoft. The repeater ships with the default IP address of 192.168.1.100, but it can be changed later if required.

If connecting directly to the repeater from a laptop or PC **with a crossover CAT-5E cable** or over a LAN the user types the IP address of the repeater into the browser address line to connect. (Note: Most users will need to update the TCP/IP settings on their computer to enable connection to a host that has a static IP. Select "Use the following IP Address" and enter the IP Address as follows: 192.168.1.x, where "x" = any number from 2 to 254 inclusive other than 100. The subnet mask is 255.255.255.0. Questions pertaining to these settings should be referred to the user's IT department or you may refer to the Additional Tips section at the end of this manual.) When connection is made the user will be prompted for a user name and password. For the purpose of the GUI session, the default user name is **webuser** and the password is **csi1234**. This can also be changed as required. Internet access is not required to use the GUI. (Note: If you are connecting using a laptop, verify that your Ethernet port is powered. Some laptops will not allow Ethernet connection when on battery power. If this is the case with the laptop you are using you will need to plug it in or update the power settings.)

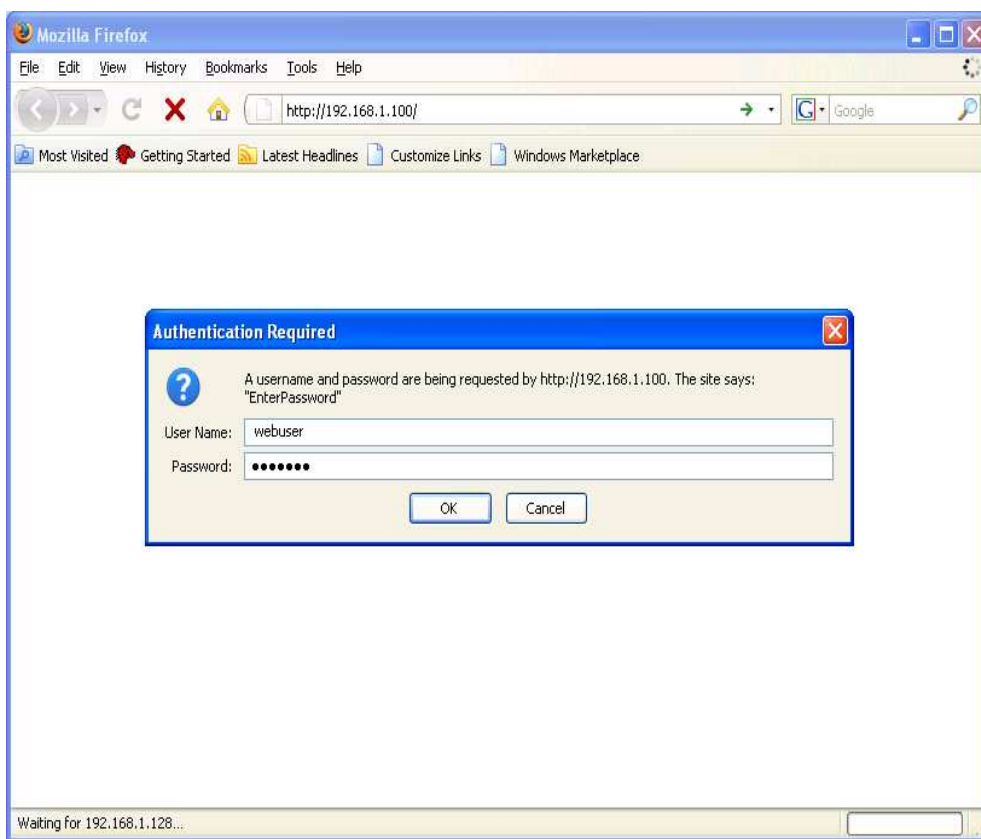

System Status:

When login is complete the user is brought to the system status page. The links shown in the navigation box on the left are activated by clicking on them.

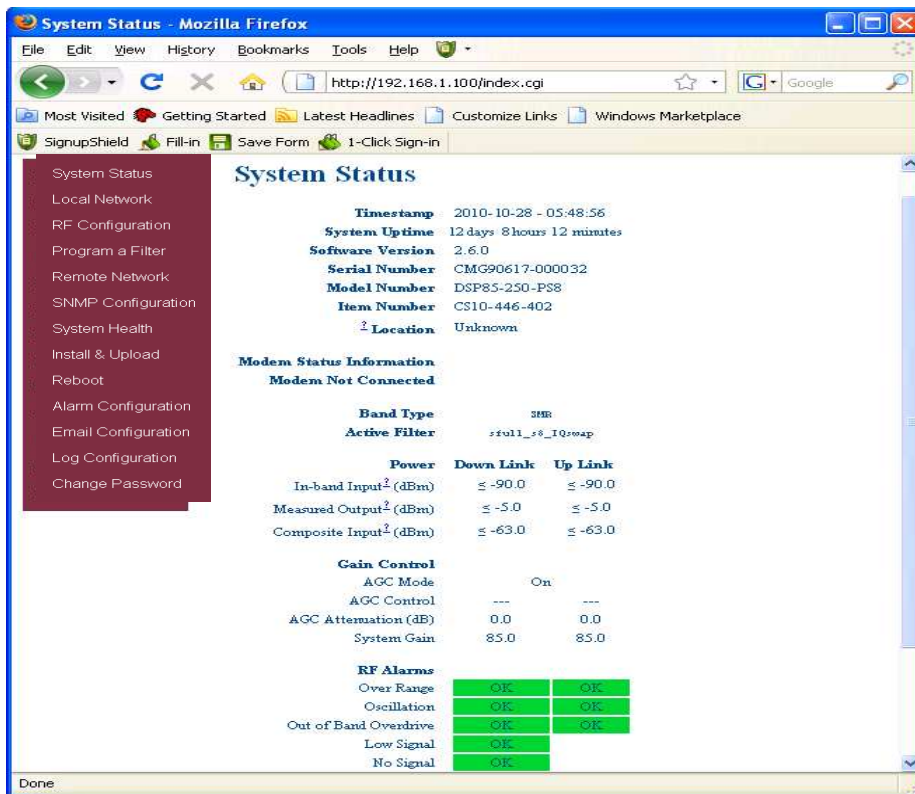

Local Network:

If the user selects Local Network from the System Status page, the following screen is displayed and from here network configuration can be modified as required. The default is set to Static. Check with your IT department for explanation and approval of the DHCP and DHCP Server options you plan to use before you select them. *NOTE: In units with software version 2.2.4 or prior, only letters, numbers and underscores are acceptable nomenclature. In units with software version 2.3.0 and up, Underscores are not acceptable; however, hyphens are acceptable.

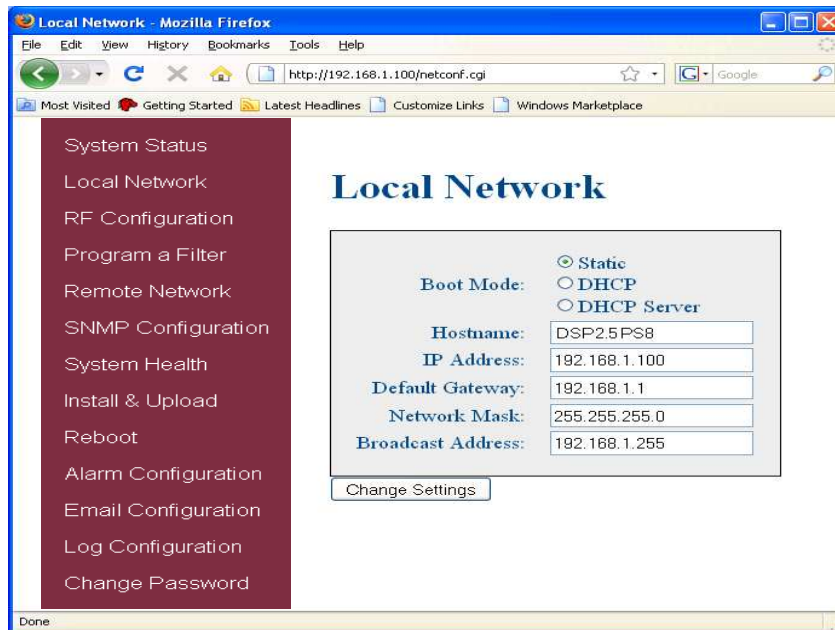

After any changes are made press the refresh button to review the fields and ensure the change made is correct. Note: changing network settings will cause the current TCP/IP connection to fail because the change will take effect immediately. From here the user may return to the System Status screen or click on the other options.

RF Configuration:

If the user would like to modify RF configuration select RF Configuration in the navigation box and the screen below is displayed.

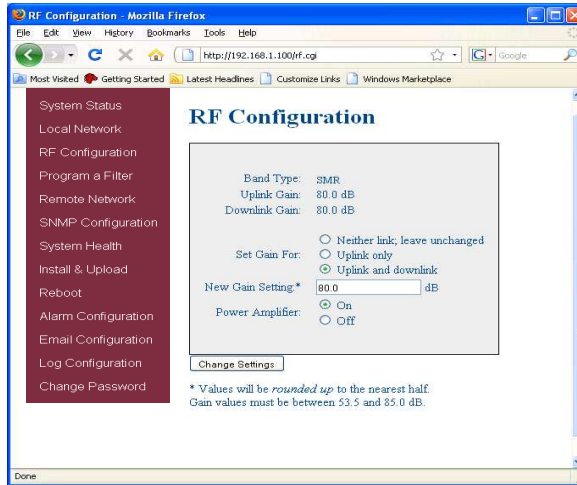

The user inputs the gain value desired. Gain values from 53.5 dB to 85.0 dB may be selected. The repeater will not allow the user to set values outside this range. If a new filter set is required, the new filter may be selected from the “Program a Filter” page below.

Program a Filter:

The user may select the desired filter by pressing the band/sub-band and modulation selection buttons. Undesired bands/sub-bands if lit will require the user to manually “deselect” them before programming. Pressing the Program button will complete the selection and load the desired filter. The time required to complete this process will take just a few moments. Note: If the filter desired is not currently in the unit, additional filters along with instructions on how to load them are available by contacting CSI.

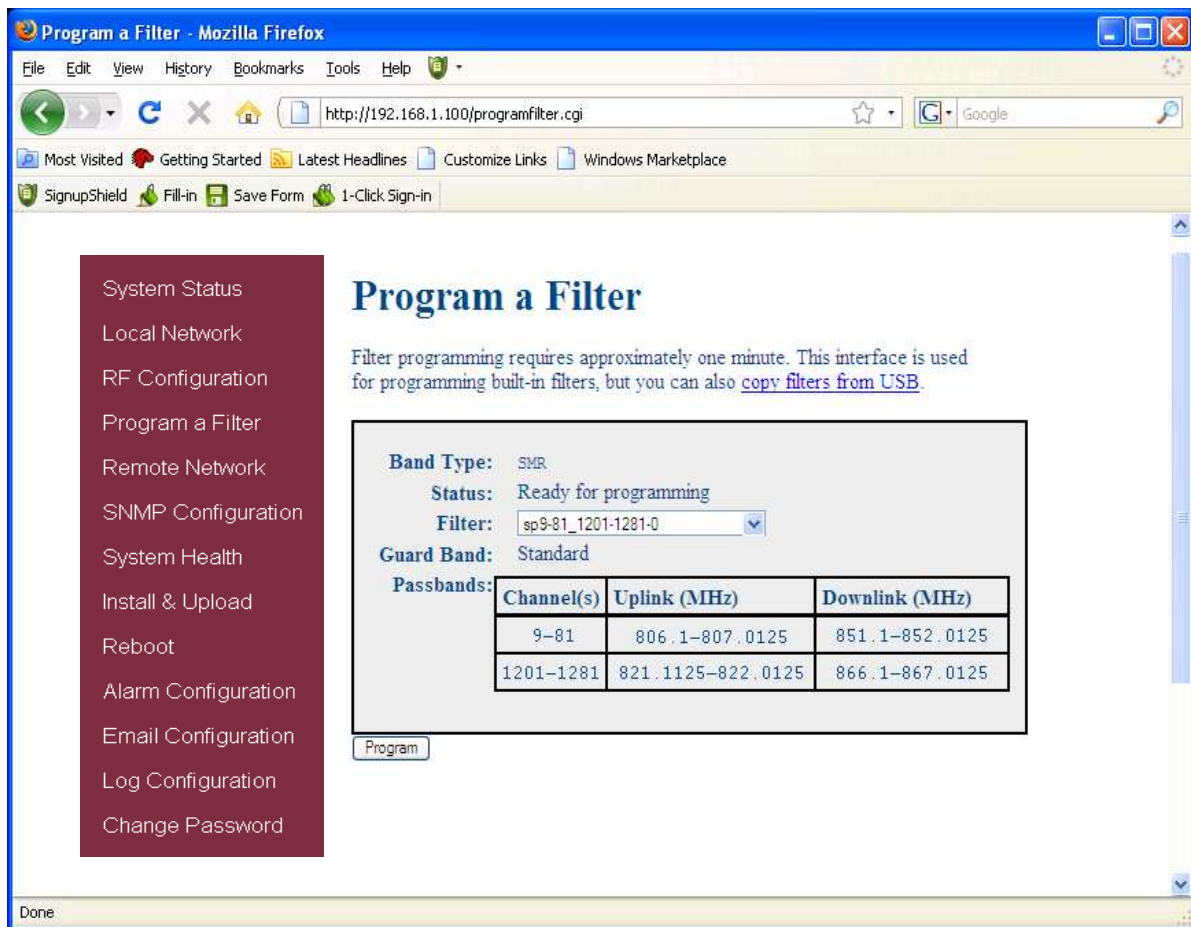

Remote Network:

If the repeater includes a USB modem kit, click on Remote Network in the navigation box and the screen below is displayed. Highlight the carrier on whose network the repeater and modem will be configured and click the Change Settings button. Refer to the documentation included with the modem kit for additional information on configuring the modem. If the repeater is connected to an ethernet device for remote access and/or monitoring, this feature must be disabled.

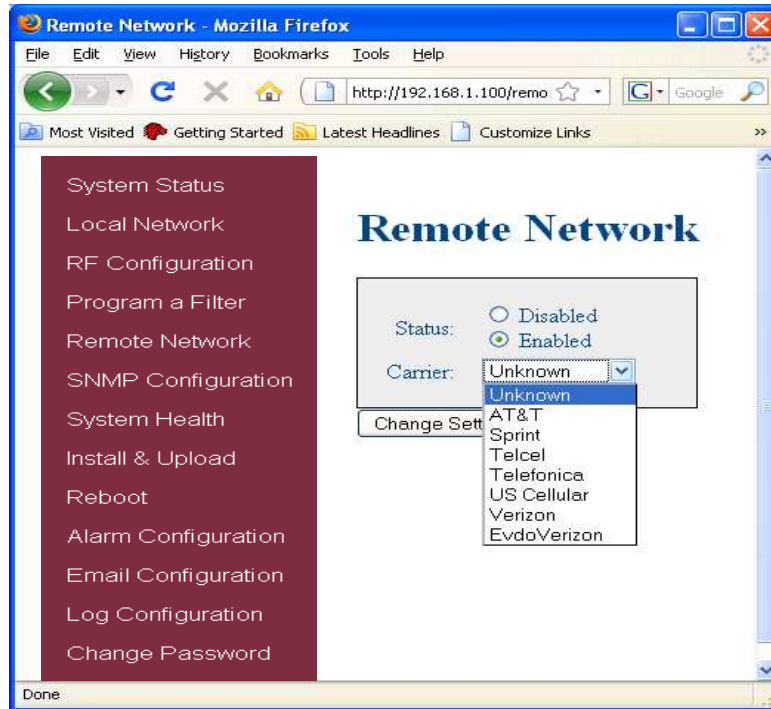

SNMP Configuration:

To change SNMP settings click SNMP Configuration in the navigation box, the screen below will be displayed. If the user is not well versed in Simple Network Management Protocol he or she should check with their IT professional for proper setting requirements.

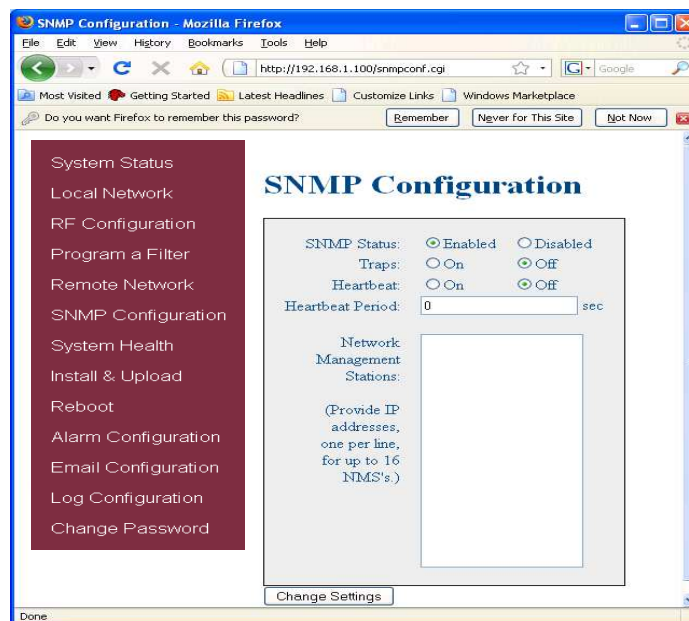

System Health:

By clicking System Health the current state of the repeater can be reviewed.

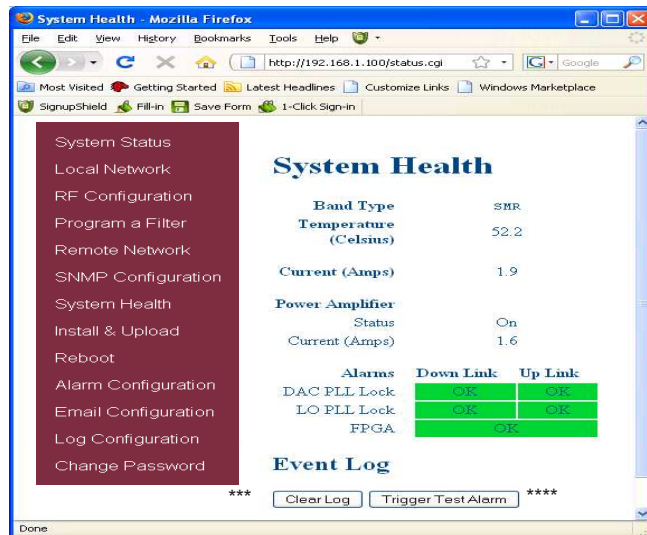

***The user may clear LED indicators, alarms and the Event Log by clicking the Clear Log button.

**** If required in your municipality, visit the "System Health" screen and click on "Trigger Test Alarm" and wait for confirmation that the Service Provider representative that is responsible for monitoring the repeater has been notified of the alarm. Be sure to "Clear All Logs" prior to logging out of the Web Interface.

Install & Upload:

Should a software install or upgrade be needed it can be done from the Install & Upload screen shown below. As with the other screens it can be reached by clicking the words in the navigation box. Contact CSI for updates and instructions.

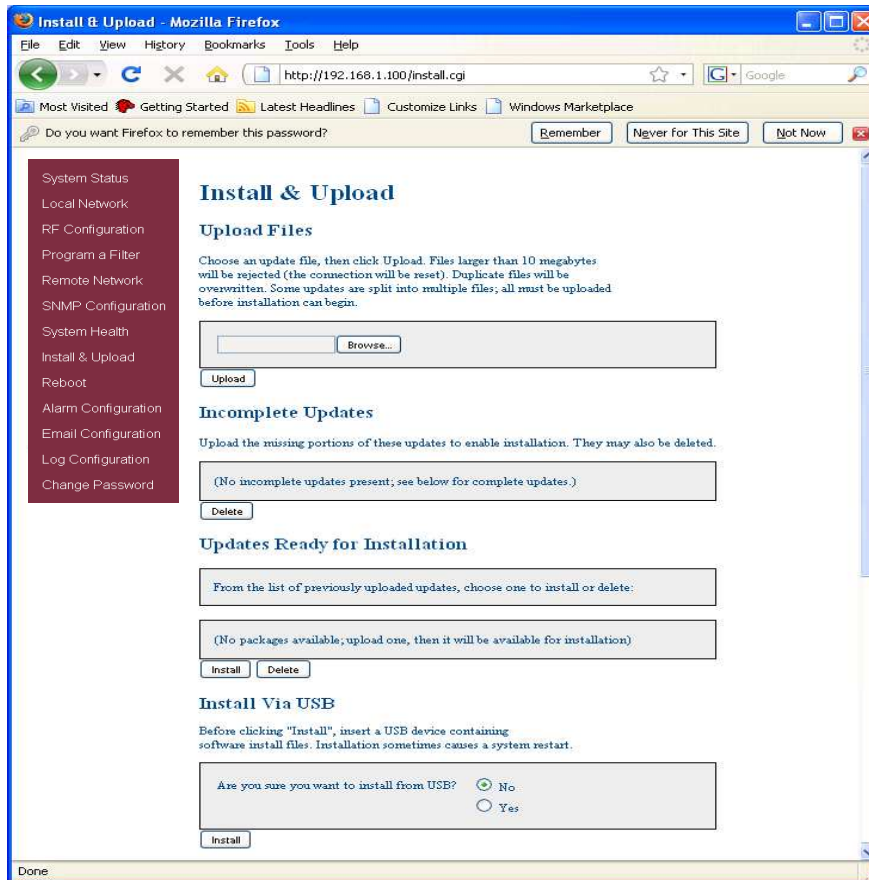

Reboot:

If a reboot of the repeater becomes necessary click on the Reboot option in the navigation box and the Reboot page is displayed.

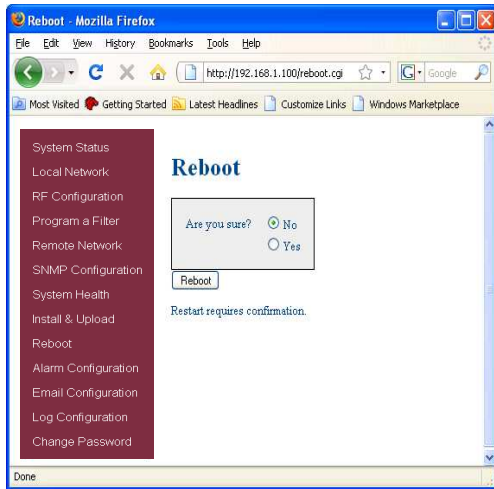

Alarm Configuration:

The Alarm Configuration page allows the user to specify what events will trigger an alarm.

***NOTE: Letters, numbers & hyphens are the only acceptable nomenclature for the Location field and hyphens may not be used as the first or last character.**

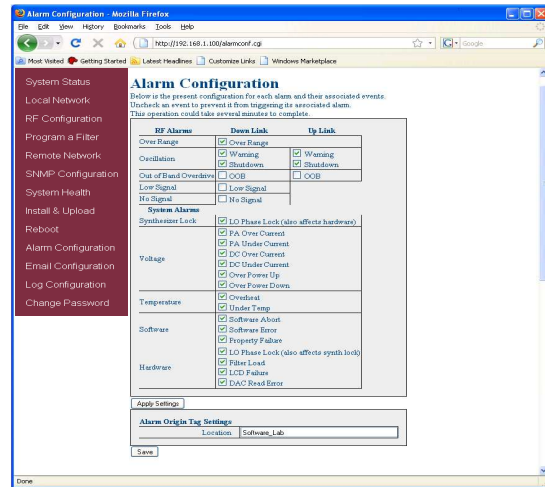

Email Configuration:

Email Configuration page allows the user to enter up to five Email addresses to which the repeater can send specified alarm messages when Email Alarm Notification and Remote Networking are enabled, and the repeater is equipped with an active wireless modem. ***NOTE: In all fields the software will not allow the user to enter invalid characters.**

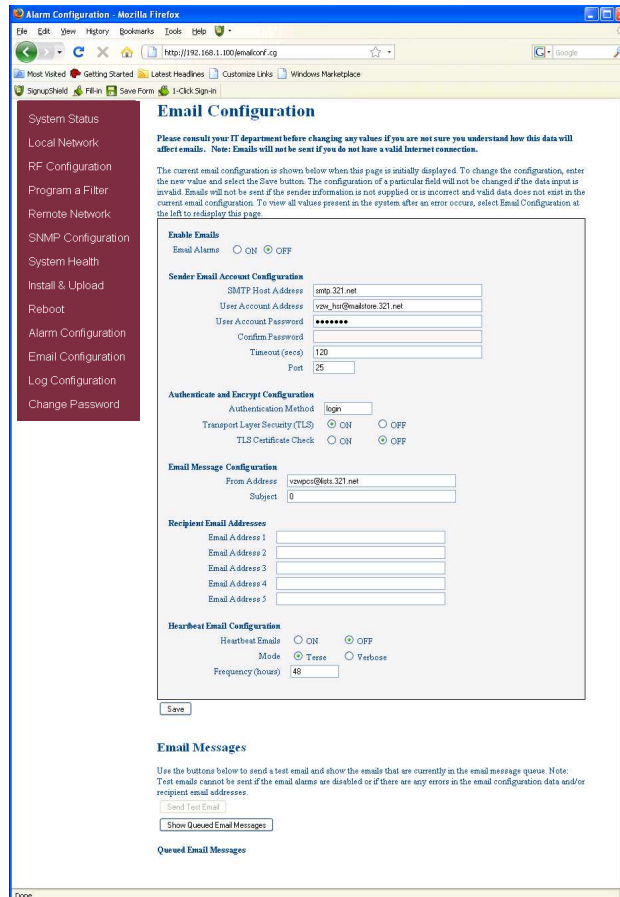

Log Configuration:

The Log Configuration page provides the user with the means to modify three aspects of how log files are created and stored as shown below.

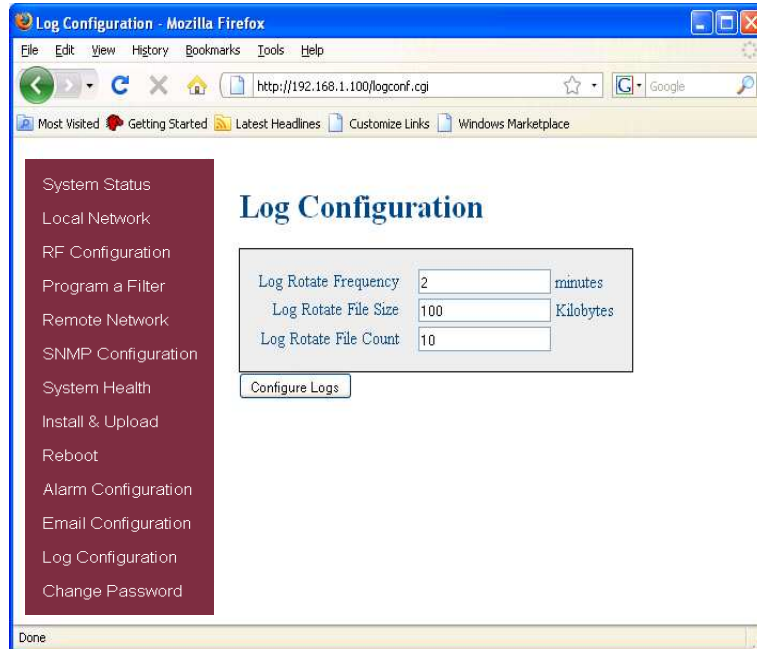

Change Password:

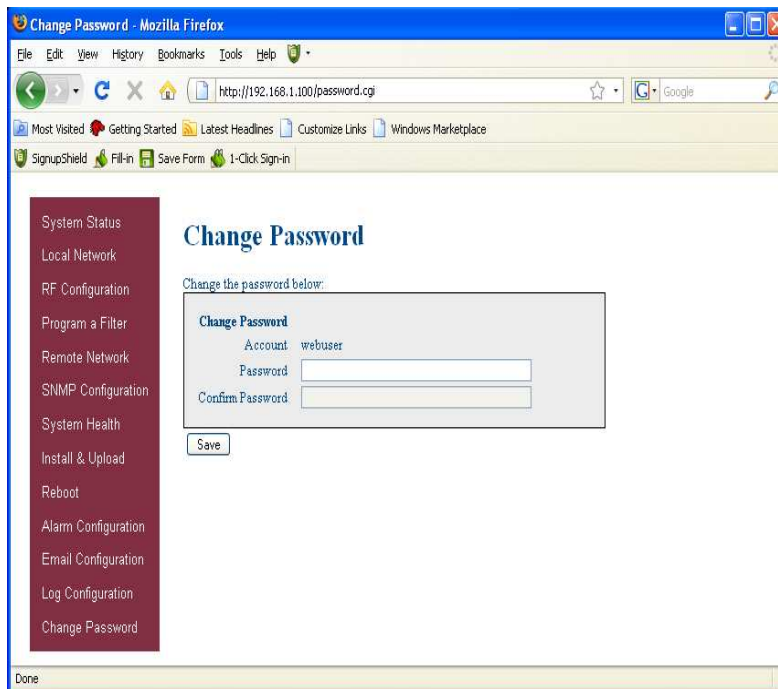

To end the session exit the browser, the user will be automatically logged out.

Text Menu Interface (Local Access)

Local access to the repeater TMI, also known as the console interface, is made by connecting a serial cable (optional), as shown in figure 1, from the serial connector of the laptop to either of the serial ports on the bottom end panel of the repeater. These connectors are labeled COM 1 and COM 2. In some cases, if the gender of the connector is not the same as shown in figure 1, a null modem adapter (optional) as shown in figure 2 may also be required.



Figure 1



Figure 2

Terminal Emulation Program

Many terminal emulation programs will work if properly configured. In the following description, "TeraTerm" is used to establish the TMI session. This program is readily available via the Internet and is free from Ayera Technologies at:

<http://www.ayera.com/teraterm/>

TeraTerm Pro Web works on Windows 95/98, 2000, XP. Here is the latest TeraTerm Pro Web release:
Version 3.1.3, October 8, 2002. tpro313.zip

When the program is started, the following screen is displayed.



Select the Serial radio button and press OK as shown below.

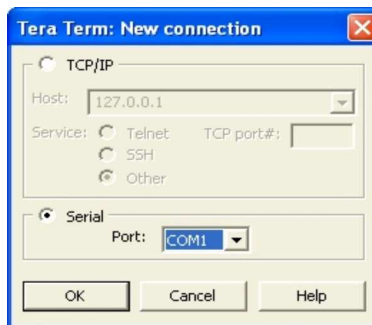

Note: It may be necessary, in the System Properties section of the control panel; using Device Manager to determine what COM port your computer uses for the communications port. In this case it is COM 1. This is not to be confused with the serial port on the bottom panel of the repeater labeled COM 1.

Terminal Emulation Set-up

Pressing “OK” will open up a blank dialog screen. Go to the setup dropdown menu and select Serial port to make changes to the serial port setup.



Configure the terminal program for the correct COM port, in this case COM 1 and 115200 baud rate as shown below.

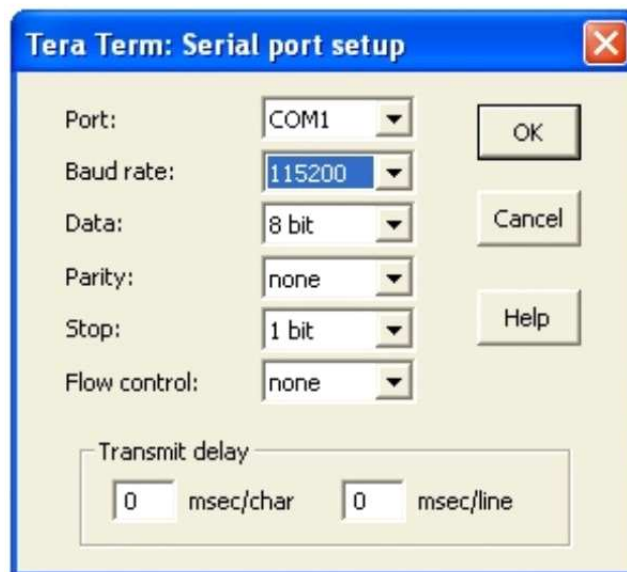

TMI Login

After completing the serial port changes (pressing the enter key will be required to complete the action) the user will be prompted for a user name and password. The default user name is "smrband". The password is "csi1234". After entering the password and pressing return the TMI main menu will appear. Note: by default the Set Parameters option is disabled. To re-enable the user will press 1 and will be prompted for a username and password. The default user name is **csi** and the password is **csi1234**.

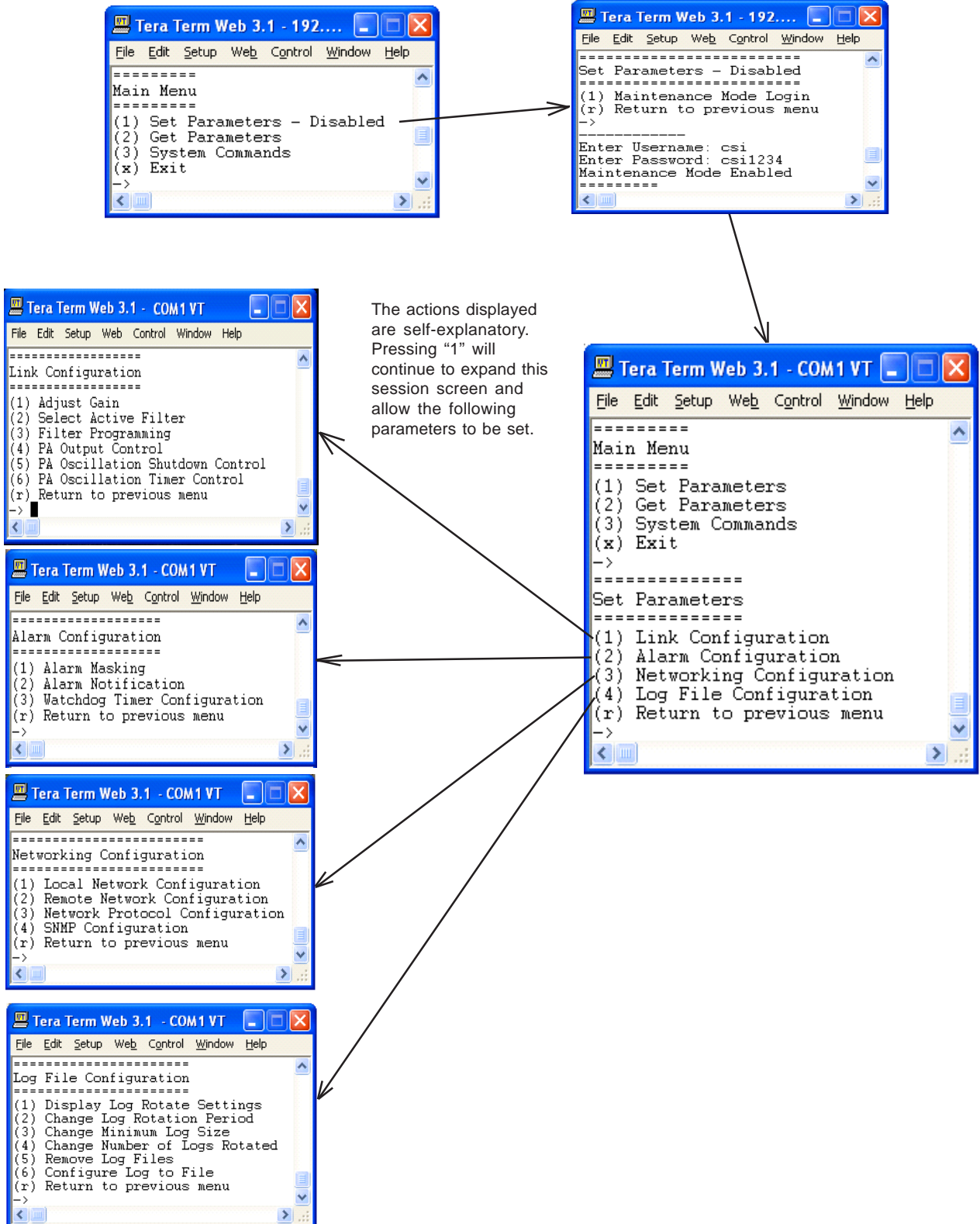

Each "Set Parameter" selection, when chosen will be expanded to allow changing or setting of that parameter. For example from the Link Configuration menu on the previous page, selecting 1 - Adjust Gain will display the menu shown below.

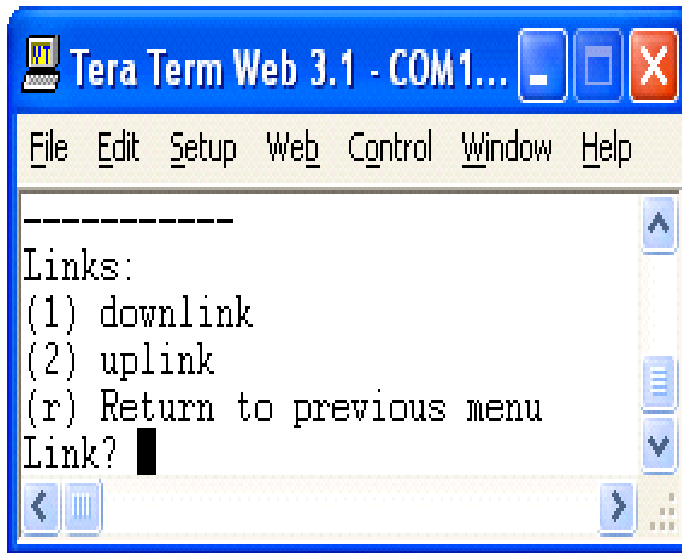

After selecting option 1, downlink, the current user gain is displayed and the option to change it is accomplished by typing the desired gain at the prompt. The user is then returned to the previous menu.

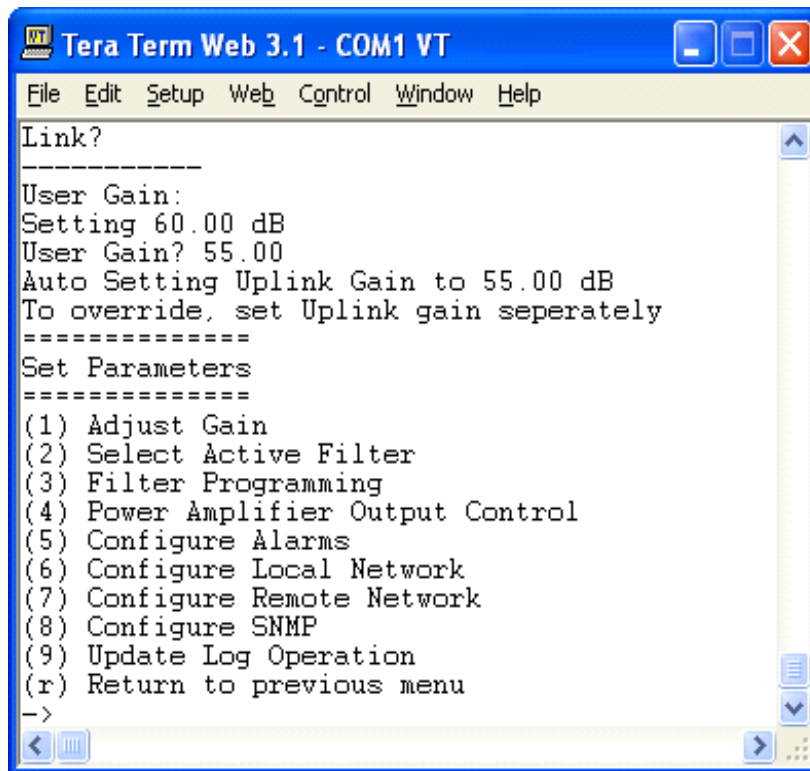

All the other options operate in much the same way. Some of the options will offer the user additional selections and will be self-explanatory. Below is one example of these additional options, the one shown below is the result of selecting (3) Filter Programming.

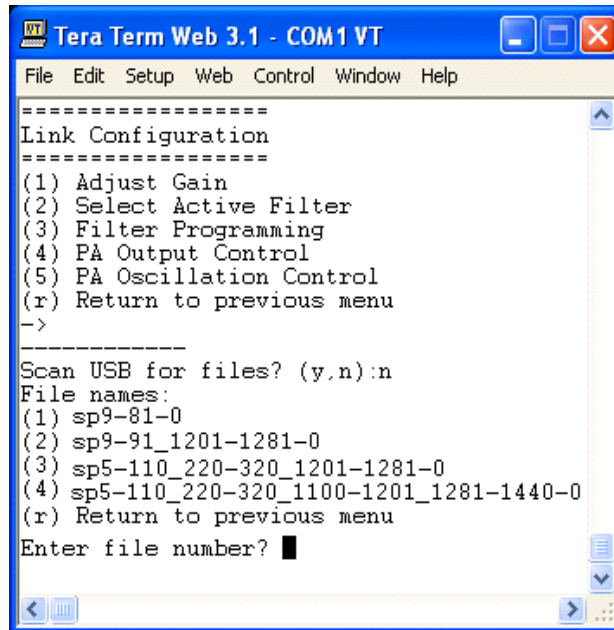

Note: Graceful session termination is important. Use Disconnect under the file dropdown menu to terminate a session, otherwise the port may become disabled and force the system to be rebooted.

Telnet Session (Remote Access)

Remote access to the repeater may be gained through a LAN connection and a terminal emulation program for TCP/IP. As with the serial connection, many terminal emulation programs will work, if properly configured. In the following description, "TeraTerm" is used to establish the Telnet session. Also, it will be required that the network configuration of the computer and the repeater being controlled be set up with the same Sub Net and Sub Net Mask in order to establish a link. In other words, the IP addresses of both the computer used and the repeater must use the same group of IP address number sets. For example, the repeater ships with the default IP address of 192.168.1.100 and a Sub Net Mask of 255.255.255.0. In order to connect, the computer to be used for the link would normally need an IP address of something like 192.168.1.12 with a Sub Net Mask of 255.255.255.0, the same Sub Net Mask as the repeater. In this example note: the last digit of the IP address may be any number except 1,100 and 255. Configuring your PC is normally fairly straight forward but it does vary somewhat with the operating system involved. If you require assistance, contact your IT department and they will be able to set up your PC for you or you may review the Additional Tips Section at the end of the manual.

When the TeraTerm program is started, the following screen is displayed. Change the default host IP address to the IP address of the repeater to be controlled. In the case of a new install, the default address is 192.168.1.100 and has been assigned at the factory. Select the service Telnet. The TCP Port must be 23.

Telnet Session Login

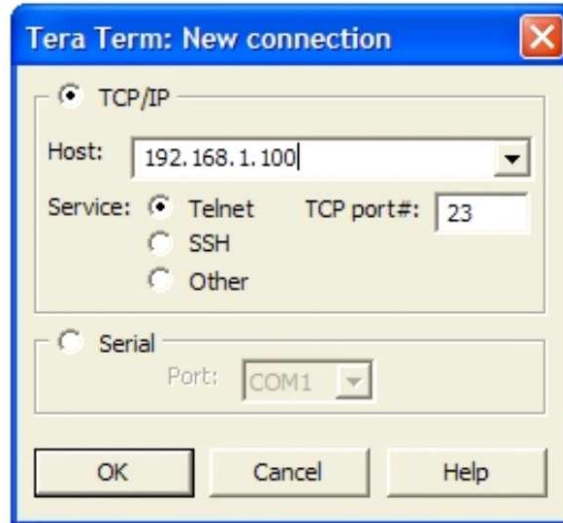

Pressing the "OK" button will bring the user to the following screen, which will require the user to log in. The default user name is "user". The default password is "csi1234".

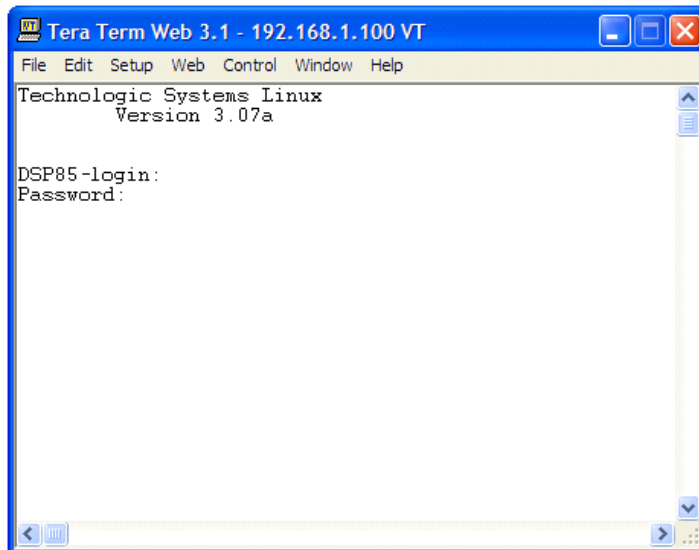

In the field after the prompt, type the user name and password. After typing the password press the enter key and the main menu will be displayed as shown next.

```

Tera Term Web 3.1 - 192.168.1.100 VT
File Edit Setup Web Control Window Help
Waiting for Configuration Update.....Complete

Waiting for Link initialization.....

Status          DNLINK          UPLINK
-----
Configuration   OK              OK
Attenuator 1    OK              OK
Attenuator 2    OK              OK
Attenuator 3    OK              OK
DAC 1           OK              OK
DAC 2           OK              OK
PLL 1           OK              OK
PLL 2           OK              OK
DPD 1           OK              OK
DPD 2           OK              OK
FPGA 1         OK              OK
FPGA 2         OK              OK
PRECOMP 1      OK              OK
PRECOMP 2      OK              OK

Link Initialization Complete

=====
Main Menu
=====
(1) Set Parameters - Disabled
(2) Get Parameters
(3) System Commands
(x) Exit
->

```

Telnet and serial sessions both provide access to the same Text Menu Interface. We have already shown many of the options available and all are self explanatory, so they will not be repeated.

Modem Interface (Remote Access with login)

A modem can also be used to gain remote access to the unit provided the repeater has been properly equipped. A selection of modems is available as an option. If the modem requires a SIM card for activation, special requirements must be met for the SIM card to become fully functional, contact the service provider. In addition, an IP address must be obtained and entered into the CSI-DSP85-PSS8.

Once the modem has been installed and activated, it can be accessed from any terminal emulation program just as in the serial and Telnet examples provided earlier. Access response time will depend on many factors, some of which are:

- Quality of the connection (RF signal in the case of wireless modems)
- Technology (CDMA, EDGE, GPRS, etc.)
- Network congestion (Throughput)

When a connection has been established, the same login screen shown in both the serial and Telnet examples is presented.

Additional Tips

Instructions to change TCP/IP settings on your Windows computer.

Click in the Network Connections Icon in the Control Panel. See below.

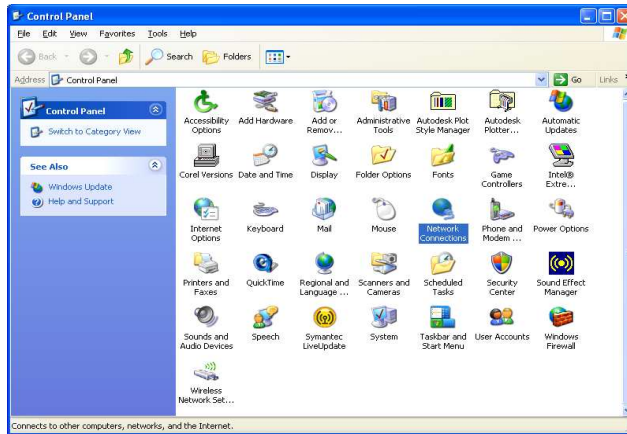

Right click on Local Area Connection - and select "Properties".



Scroll down to "Internet Protocol (TCP/IP)" and click on the "Properties" button.



If you are set up to use DHCP, the window shown below will be displayed.



Select "Use the following IP address:" and enter "192.168.1.2." The subnet mask should automatically populate to "255.255.255.0".

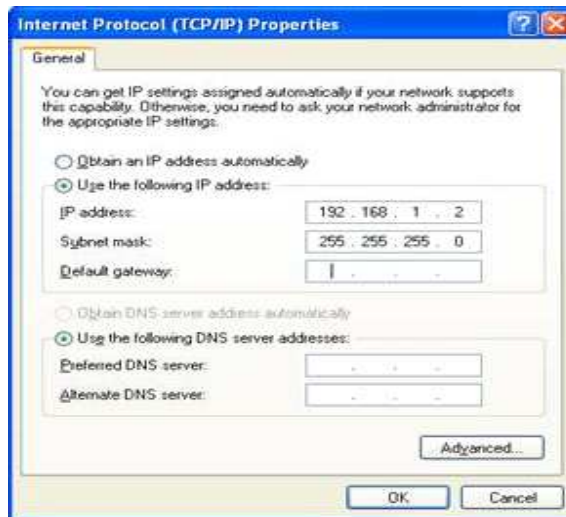

Nothing else will need to be chosen or entered. Click "OK", then "OK again and retry connection.

A crossover Ethernet cable (supplied) must be used for Web Interface access. As a reminder, you must verify the Ethernet port on your laptop is powered. If your laptop is on battery power, the Ethernet port may be inactive by default. If this is the case simply plug in the laptop to a 110vac source or change the power settings to enable the Ethernet port when the laptop is using battery power.

Suggested spectrum analyzer setting:

When troubleshooting RF issues, and when surveying challenging RF environments, it's important to have a spectrum analyzer capable of measuring the frequency that you are working with. An attenuator should be used to protect the input, when connected to a source of RF power such as the repeater or a powered DAS.

Both Uplink and Downlink should be measured. Downlink should be measured on the donor cable and at the output (server) port of the powered up repeater, and Uplink at the lead from the DAS (on fiber/ powered DAS's, where the lead would connect to the server port on the repeater) and at the donor port with the repeater powered up. Measurements may also be necessary at server antenna locations. Your spectrum analyzer will need to be equipped with a whip antenna for this.

Resolution Bandwidth (RBW) should be set at 200 kHz for GSM and 1 MHz for CDMA. If you cannot select these values, the closest available values should be used. Video filter should be about one tenth of RBW. Other settings like span are whatever is appropriate. One should also make sure that there are no signals above the top of the screen.

If you cannot see an adjacent out of band signal when using the 1 MHz RBW filter, you can decrease the RBW, to see the close-in-frequency signals. Be sure to set the RBW back when you want to measure the power level.

RF Notes:

To prevent overload of the DSP input stages, the maximum measured level of in-band or out of band signals should be less than -50 dBm when the DSP gain is set to 85 dB, -40 dBm when set to 75 dB, etc. This applies when there is one dominant signal and applies TO BOTH THE DOWNLINK AND UPLINK. If there are two dominant signals, and the gain is set to 85 dB, then the level of each signal should be kept to less than -53 dBm. With three signals, each should be less than -55 dBm. With ten signals each should be less than -60 dBm. This latter reduction prevents the composite power of the multiple signals from exceeding an acceptable level. Add fixed attenuators in line with the donor antenna line/DAS feed to keep signals below the levels indicated above.

One Year Limited Warranty

Seller warrants that its products are transferred rightfully and with good title; that its products are free from any lawful security interest or other lien or encumbrance unknown to Buyer; and that for a period of one year from the date of installation or fifteen months from the date of original shipment, whichever period expires first, such products will be free from defects in material and workmanship which arise under proper and normal use and service. Buyer's exclusive remedy hereunder is limited to Seller's correction (either at its plant or at such other place as may be agreed upon between Seller and Buyer) of such defects by repair or replacement at no cost to Buyer. Transportation costs in connection with the return of products to Seller's plant or designated facility shall be paid by Buyer. The provisions of this warranty shall be applicable with respect to any product which Seller replaces pursuant to it. SELLER MAKES NO WARRANTY, EXPRESS OR IMPLIED, OTHER THAN AS SPECIFICALLY STATED ABOVE. EXPRESSLY EXCLUDED ARE THE IMPLIED WARRANTIES OF MERCHANTABILITY AND FITNESS FOR PURPOSE. THE FOREGOING SHALL CONSTITUTE ALL OF SELLER'S LIABILITY (EXCEPT AS TO PATENT INFRINGEMENT) WITH RESPECT TO THE PRODUCTS. IN NO EVENT SHALL SELLER BE LIABLE FOR SPECIAL, CONSEQUENTIAL OR INCIDENTAL DAMAGES, INSTALLATION COSTS, LOST REVENUE OR PROFITS, OR ANY OTHER COSTS OF ANY NATURE AS A RESULT OF THE USE OF PRODUCTS MANUFACTURED BY THE SELLER, WHETHER USED IN ACCORDANCE WITH INSTRUCTIONS OR NOT. UNDER NO CIRCUMSTANCES SHALL SELLER'S LIABILITY TO BUYER EXCEED THE ACTUAL SALES PRICE OF THE PRODUCTS PROVIDED HEREUNDER. No representative is authorized to assume for Seller any other liability in connection with the products.

Industry Certifications/Registration Numbers:

FCC: NVRCSI-DSP85-PS8 , NVRCSI-DSP85-PS7 IC: 4307A-DSP85-PS8 4307A-DSP85-PS7

Index

A

AC Current 15
AC Power Frequency 15
AC Power Specifications 15
AC Voltage 15
Additional Tips 32
AGC 5
Alarm Configuration 23
APC 5
Application 4
AUI 5
Automatic Gain Control 16

B

Box Thermal Management 15
Box Weight 15

C

CDMA RHO 16
Change Password 24
Circuit Operational Description
14, 19, 20, 21, 22, 23
Color 15
Connectors 16
CPU 5
CSI 5

D

DAS 5
Depth 15
DHCP 5
Document Purpose / Intended
Users 4
DSP 5

E

EEPROM 5
Email Configuration: 23
Environmental Requirements 15
ERP 5
Ethernet 9
Event Log 22
Explosive Atmospheres 4

F

FPGA 5
Functional Block Diagram 14, 15
Functional Overview 8

G

Grounding 4

H

Height 15

I

Important Installation Notes 14
Important Safety Information 5
Inadequate isolation 14
Industrial Dust 15
Industry Certifications/Registration
Numbers 35
Input VSWR 16
Install Software 22

L

LED 5
LED Indicators 8
Lightning Danger 4
Linear Gain 16
Liner Output Power 16
Local Communication Interface Ports
9
Local Network 19
Log Configuration 24
login 18

M

Manual Gain Control 16
Maximum RF input Power 16
Mechanical Drawing 17
Modem Interface 31
modulation selection 20
Monitoring & Alarms 9

N

Noise Figure 16
null modem adapter 25

O

OIP3 16

P

Pass Band Ripple 16
Power supply cable connectors 13
Product Registration Information 4
Program a Filter 20
Propagation Delay 16

R

Reboot 23
Relative Humidity 15
Remote Network 21
Resolution Bandwidth 34
RF Notes 34

RMS Vector Error 16

S

SBC 5
serial cable 25
SNMP 5
SNMP Configuration 21
Spurious Emissions 16
Suggested spectrum analyzer
setting 34
Surface Coating 15
System Health 22
System Set-Up Considerations 10
System Status 19

T

TCP/IP settings 32
Telnet Session 29, 30
Temperature Range 15
terminal emulation programs 25
Terms used in this manual 5
TMI 5
troubleshooting RF issues 34

U

UHCI 5
USB 5
USB Interface 9

W

Wall Mounting 12
Warranty 35
Web based GUI Session 18
Width 15

Notes

Notes

Notes



960-1041-055 rev 002



670 North Commercial Street
Manchester, NH 03101

Toll Free: 1.877.844.4274
Phone: 603.626.6677
Fax: 603.626.6042

www.cellularspecialties.com