



DSP85 Series Digital Repeater
User's Guide

PRODUCT MANUAL

DISCLAIMER

All information and statements contained herein are accurate to the best of Westell Technologies knowledge. Westell Technologies makes no warranty with respect there to, including without limitation any results that may be obtained from the products described herein or the infringement by such products of any property rights of any persons. Use or application of such information or statements is at the users' sole risk, without any liability on the part of Westell Technologies. Nothing herein shall be construed as license or recommendation for use, which infringes upon any propriety rights of any person. Product material and specifications are subject to change without notice. Westell Technologies standard terms of sale and the specific terms of any particular sale apply.

WARNING. This is NOT a CONSUMER device. It is designed for installation by **FCC LICENSEES and QUALIFIED INSTALLERS.** You must have an **FCC LICENSE** or express consent of an FCC Licensee to operate this device. Unauthorized use may result in significant forfeiture penalties, including penalties in excess of \$100,000 for Each continuing violation."

WARNING! Changes and Modifications not expressly approved by Westell can void your authority to operate this equipment under Federal Communications Commission's rules.

WARNING! The Manufacturer's rated output power of this equipment is for single carrier operation. For situations when multiple carrier signals are present, the rating would have to be reduced by 3.5 dB, especially where the output signal is re-radiated and can cause interference to adjacent band users. This power reduction is to be by means of input power or gain reduction and not by an attenuator at the output of the device.



TABLE OF CONTENTS

Preface	ix
Purpose.....	ix
Application.....	ix
Document Organization	ix
Document Conventions	x
Product Registration Information.....	xi
Safety Guidelines.....	xi
Important Safety Information.....	xi
Industry Certifications/Registration Numbers	xii
Canadian Compliance Information.....	xii
Technical Support.....	xiii
Acronyms and Abbreviations.....	xiii
1 Product Overview	13
1.1 Product Information.....	13
1.2 Functional Overview.....	13
1.3 LED Indicator.....	14
1.4 Local Communication Interface Ports.....	15
1.5 EIA232 Pin Specifications	15
1.6 USB Interface	15
1.7 Ethernet.....	16
1.8 Monitoring and Alarms.....	16
1.9 Circuit Operational Description.....	16
1.10 Functional Block Diagrams.....	16
2 Optimizing the System during Installation	19
2.1 System Setup Considerations	19
2.2 Suggested Spectrum Analyzer Setting.....	19
2.3 Important Installation Notes	20
2.4 Installation Guidelines.....	20
2.4.1 Donor Antenna	20
2.4.2 Antennas.....	21
2.5 Optional Accessories	21
2.5.1 Outside Donor Antenna	21
2.5.2 Inside Omnidirectional Antenna	21



2.5.3	Power Dividers	21
2.5.4	Grounding Kit	21
2.5.5	Directional Couplers	22
2.5.6	19" Rack Shelf	22
2.5.7	UPS.....	22
2.5.8	Cross Band Couplers.....	22
3	Web-based GUI.....	23
3.1	Web-based GUI Session	23
3.2	System Status	24
3.3	Local Network.....	25
3.4	RF Configuration	26
3.5	Program a Filter	27
3.6	Remote Network	28
3.7	SNMP Configuration.....	29
3.8	Time Configuration	29
3.9	System Health.....	30
3.10	Install and Upload.....	31
3.11	Reboot.....	32
3.12	Alarm Configuration	33
3.13	Email Configuration.....	34
3.14	Log Configuration.....	35
3.15	Account Credentials.....	36
4	Console Interface.....	37
4.1	Text Menu Interface (Local Access).....	37
4.2	Telnet Session (Remote Access).....	42
4.3	Modem Interface (Remote Access with Login)	44
4.4	Additional Tips	45
Appendix A	Attenuation and Dynamic Range Guidelines.....	49
A.1	Donor Port	49
A.2	Server Port	49
A.3	Dynamic Range Thresholds	50
A.4	Large Deltas between In-band and Composite Input Signals	50
Appendix B	Band Plans and Filter File Naming Conventions	51
B.1	Frequency Band Plans	51
B.1.1	700 MHz Lower A, B and C Band Plan	51



B.1.2	700 MHz Upper C Band Plan.....	52
B.1.3	Cellular Frequency Band Plan.....	52
B.1.4	AWS Frequency Band Plan	53
B.1.5	Canadian PCS Frequency Band Plan.....	53
B.1.6	US PCS Frequency Band Plan.....	54
B.1.7	Public Safety Bands	54
B.2	Filter File Naming Conventions	55
B.2.1	700 MHz Filter Naming Convention.....	55
B.2.2	Cellular Filter File Naming Convention.....	56
B.2.3	Canadian PCS Filter File Naming Convention.....	57
B.2.4	US PCS Filter File Naming Convention.....	58
B.2.5	AWS Filter Naming Convention.....	60
Appendix C LTE Attenuator and Installation Notes.....		61
C.1	Important LTE Attenuator and Installation Notes - Donor and Server Isolation	61
C.1.1	Line of Sight Propagation Path Loss Table.....	61
Appendix D Mechanical and Electrical Specifications		62
D.1	Digital Repeater Mechanical and Electrical Specifications	62
D.1.1	Mechanical Specifications	62
D.1.2	Electrical Specifications.....	63
D.1.3	Power Requirements	63
D.1.4	Environmental Requirements.....	63
D.1.5	Operating Power Parameters.....	64
Appendix E Port Configurations		65
E.1	Digital Repeater Port Configurations, Original Series	65
E.1.1	Dual-band D2:D1 Port Configuration	65
E.1.2	Dual-band D1:D2 Port Configuration	65
E.1.3	Dual-band D2: D2 Port Configuration	66
E.1.4	Dual-band D1:D1 Port Configuration	66
E.1.5	Single-band D1:D1 Port Configuration.....	67
E.1.6	Dual-band D2:S4 Port Configuration	67
E.1.7	Dual-band D1:S4 Port Configuration	68
E.1.8	Single-band D1:S2 Port Configuration.....	68
E.2	Digital Repeater Port Configurations.....	69
E.2.1	Dual-band D2:D1 Port Configuration	69
E.2.2	Dual-band D1:D2 Port Configuration	69
E.2.3	Dual-band D2:D2 Port Configuration	70



E.2.4	Dual-band D1:D1 Port Configuration	70
E.2.5	MIMO Port Configuration.....	70
E.2.6	Single-band D1:D1 Port Configuration	71
E.2.7	Dual-band D2:S4 Port Configuration	71
E.2.8	Dual-band D1:S4 Port Configuration	72
E.2.9	Single-band D1:S2 Port Configuration	72
Appendix F	Mechanical Configurations.....	73
F.1	DSP85-250 and DSP85-251 Series Mechanical Drawing	73
F.2	DSP85-250 and DSP85-251 Series Mounting.....	74
Appendix G	Acronyms and Abbreviations.....	76

TABLE OF FIGURES

Figure P-1: Product Registration Information.....	xi
Figure 1-1: DB-9 Pin Descriptions	15
Figure 1-2: Dual Band Functional Block Diagram.....	17
Figure 1-3: Single Band Functional Block Diagram.....	18
Figure 3-1: User Connection Login.....	23
Figure 3-2: System Status.....	24
Figure 3-3: Local Network.....	25
Figure 3-4: RF Configuration.....	26
Figure 3-5: Program a Filter	27
Figure 3-6: Remote Network.....	28
Figure 3-7: SNMP Configuration	29
Figure 3-8: Time Configuration.....	29
Figure 3-9: System Health.....	30
Figure 3-10: Install & Upload.....	31
Figure 3-11: Reboot.....	32
Figure 3-12: Alarm Configuration	33
Figure 3-13: Email Configuration	34
Figure 3-14: Log Configuration.....	35
Figure 3-15: Account Credentials.....	36
Figure 4-1: Null Modem Cable.....	37



Figure 4-2: Gender Adapter	37
Figure 4-3: Tera Term Pro Web Start Up.....	37
Figure 4-4: Serial Radio Button	38
Figure 4-5: Setup	38
Figure 4-6: Serial Port Setup	39
Figure 4-7: TMI Menus	40
Figure 4-8: Adjust Gain.....	41
Figure 4-9: User Gain	41
Figure 4-10: Selecting Filter Programs.....	42
Figure 4-11: Default IP Address	43
Figure 4-12: Login Screen	43
Figure 4-13: Main Menu	44
Figure 4-14: Control Panel.....	45
Figure 4-15: View Network Status and Tasks	45
Figure 4-16: Change Adapter Settings.....	46
Figure 4-17: Local Area Network.....	46
Figure 4-18: Internet Protocol Version 4 (TCP/IPv4)	47
Figure 4-19: Enter IP Address	47

TABLE OF TABLES

Table P-1: Document Conventions.....	x
Table A-1: Dynamic Range Thresholds	50
Table B-1: 700 MHz Filter Naming Convention	55
Table B-2: Cellular Filter File Naming Convention.....	56
Table B-3: Canadian PCS Filter File Naming Convention	57
Table B-4: US PCS Filter File Naming Convention.....	58
Table C-1: Line of Sight Propagation Path Loss Table	61
Table D-1: Mechanical Specifications.....	62
Table D-2: Electrical Specifications.....	63
Table D-3: Power Requirements.....	63
Table D-4: Environmental Requirements	63



Table D-5: Operating Power Parameters64
Table G-1: Acronyms and Abbreviations 76



Preface

This Preface includes the following:

- **Purpose**
- **Application**
- **Document Organization**
- **Document Conventions**
- **Product Registration Information**
- **Safety Guidelines**
- **Important Safety Information**
- **Industry Certifications/Registration Numbers**
- **Technical Support**
- **Acronyms and Abbreviations**

Purpose

The purpose of this document is to provide a procedure to help experienced technicians/engineers install and commission an in-building wireless enhancement repeater system using Westell Technologies digital repeaters. This document was written to address the practical concerns of the installer. Following the procedures in this manual will minimize risks associated with modifying a live system and will prevent service interruptions. This document assumes the technician/engineer understands the basic principles and functionality involved with repeater and in-building systems.

Application

Apply this guide when adding digital repeater capability to an existing system or as part of a new installation.

Document Organization

This manual includes the following chapters:

Chapter 1: Product Overview – Provides an overview of the DSP85 Repeater Series

Chapter 2: Optimizing the System during Installation – Provides information for optimization of the system

Chapter 3: Web-Based GUI – Provides information about using the system through a web-based graphical user interface

Chapter 4: Console Interface – Provides information about local access to the repeater through console interface

Appendix A: Attenuation and Dynamic Range Guidelines – Provides information about attenuation and dynamic range guidelines

Appendix B: Band Plans and Filter File Naming Conventions – Provides information about the band plans and filter file naming conventions



Appendix C: LTE Attenuator and Installation Notes – Provides the LTE Attenuator and installation notes including donor and server isolation

Appendix D: Mechanical and Electrical Specifications– Provides mechanical and electrical specifications for this product

Appendix E: Port Configurations – Details and illustrates the port configurations for each repeater type

Appendix F: Mechanical Configurations – Details and illustrates the mechanical configuration for each repeater type

Appendix G: Acronyms and Abbreviations – Provides a table of acronyms and abbreviations used in this manual and a definition for each

Document Conventions

Table P-1 lists the conventions used throughout this document.

Table P-1: Document Conventions

Convention	Description
DANGER!	Description of an imminent hazard that, if not avoided, may result in severe injury or death.
WARNING!	Description of an imminent hazard that, if not avoided, may result in injury or serious equipment damage.
CAUTION	Description of an imminent hazard that, if not avoided, could result in equipment damage.
IMPORTANT	Additional information that is very important for the user to know. More critical than a note, but does not contain a Danger!, Warning! or Caution.
NOTE	Additional information or comments that may be beneficial for the user to know.
Bold	Bold typeface indicates commands, buttons, keyboard keys, user interface elements, and provides emphasis.
Command1 > Command2	The > symbol between commands indicates a succession of commands. For example, select Start > Settings .
Key1+Key2	A plus sign between key names indicates simultaneous keyboard commands. Press and hold down the first key while pressing the second key. For example, Ctrl+X .



Product Registration Information

The product serial number is located on the label on the bottom panel, near the power connectors. Record the serial number, model number, purchase date and point-of-sale company in the boxes in Figure P-1 below. Retain this manual, along with proof of purchase, to serve as a permanent record of your purchase.

MODEL NUMBER	SERIAL NUMBER	PURCHASE DATE
<input type="text"/>	<input type="text"/>	<input type="text"/>
POINT OF SALE COMPANY		
<input type="text"/>		

Figure P-1: Product Registration Information

Safety Guidelines

The general safety information in this section applies to both operating and service personnel. Specific warnings and cautions are located in other parts of this manual to which they apply, but may not appear in this summary. Failure to comply with these precautions or specific warnings elsewhere in the manual violates safety standards of design, manufacture, and intended use of equipment. Westell Technologies assumes no liability for the customer's failure to comply with these requirements:

Grounding: This digital repeater system is designed to operate from 100 - 240 VAC and must always be operated with the ground wire properly connected. Do not remove or otherwise alter the grounding lug on the power cord.

Explosive atmospheres: To avoid explosion or fire, do not operate this product in the presence of flammable gases or fumes.

Lightning danger: Do not install or adjust this unit during an electrical storm. We strongly recommend the use of a suitable lightning arrester.

There are no user-serviceable parts inside the repeater.

DANGER!

Hazardous voltages are present when the cover is removed. Do not open the repeater enclosure. If you suspect a malfunction with this product, call your dealer or call Westell Technologies technical support line at 1.877.844.4274.

WARNING!

Disconnect/remove power before connecting or disconnecting cables.

Important Safety Information

Antennas used to radiate signals indoors are limited to a maximum gain of 3 dBi. The outdoor antenna used to communicate to the wireless infrastructure is limited to 14dBi gain, or any combination of gain and loss that equals 14 dB at input. Position each antenna to observe minimum separation requirements from all users and bystanders.



Use the following guidelines when considering separation distances.

- Place indoor antennas such that, under normal conditions, personnel cannot come within 20 cm (~8 in) from any inside antenna. Adhering to this minimum separation ensures that bystanders cannot exceed RF exposures beyond the maximum permissible limit for uncontrolled exposure.
- Position outdoor antennas such that, under normal conditions, personnel cannot approach closer than 183 cm (~6 ft.). If a directional antenna that has a maximum gain of 14 dBi is used, take precautions to prevent personnel from routinely passing through the main radiation beam at a distance closer than specified.

WARNING. This is NOT a CONSUMER device. It is designed for installation by **FCC LICENSEES and QUALIFIED INSTALLERS.** You must have an **FCC LICENSE** or express consent of an FCC Licensee to operate this device. Unauthorized use may result in significant forfeiture penalties, including penalties in excess of \$100,000 for each continuing violation.”

WARNING! Changes and Modifications not expressly approved by Westell can void your authority to operate this equipment under Federal Communications Commission’s rules.

Industry Certifications/Registration Numbers

FCC

- NVRCSE-DSP85-C/P, NVRCSE-DSP85201CP, NVRCSE-DSP85-U7C, NVRCSE-DSP85-PS7, NVRCSE-DSP85-PSS8, NVRCSE-DSP25XCP, NVR-DSP251AWS, NVRCSE-DSP25XAWS, NVRCSE-DSP25XS8, NVRCSE-DSP25XL7, NVRDSP-PCSGAWS3, NVRDSP-PCSG, and NVRDSP-AWS3

IC

- 4307A-DSP25XHCP, 4307A-DSP25XS8, 4307A-DSP251AWS

UL

- Power supply: UL60950-1

Canadian Compliance Information

This device complies with Industry Canada license-exempt RSS standard(s). Operation is subject to the following two conditions: (1) this device may not cause interference, and (2) this device must accept any interference, including interference that may cause undesired operation of the device.

Le présent appareil est conforme aux CNR d'Industrie Canada applicables aux appareils radio exempts de licence. L'exploitation est autorisée aux deux conditions suivantes : (1) l'appareil ne doit pas produire de brouillage, et (2) l'utilisateur de l'appareil doit accepter tout brouillage radioélectrique subi, même si le brouillage est susceptible d'en compromettre le fonctionnement.



Technical Support

If you suspect a malfunction with this product or if you have a technical question, call your dealer or the Westell Technologies In-Building Wireless Support Line at (603) 626-6677, Toll Free (USA) 1-877-844-4274, press option 2 then option 1, or email us at ibwsupport@westell.com.

Acronyms and Abbreviations

Refer to the Appendix G at the end of this manual for definitions of the acronyms and abbreviations used in this manual.

1 Product Overview

1.1 Product Information

Westell Technologies digital repeaters were developed for use within enclosed structures where sufficient signal strength from local cell sites to operate cell phones is unavailable. Adequate signal strength must be available outside the structure as a prerequisite to achieving in-building coverage. The digital repeater is connected to an external antenna, usually on the roof, and to one or more internal antennas placed strategically throughout the area where wireless service is desired.

The external antenna is typically a directional type, such as a Yagi antenna. Internal antennas are typically omnidirectional, though various other types may be used, depending on the coverage application. The Westell DSP repeater amplifies both the uplink (phone to tower) and downlink (tower to phone) signals, facilitating communications to and from the intended wireless infrastructure.

With a maximum total of 85 dB nominal gain on both the uplink and downlink, gain can be adjusted over a range from 53.5 dB to 85 dB in 0.5 dB steps. The repeater is controlled with a computer connected to COM port 1 or 2 or via a crossover ethernet cable connected to the ethernet port.

A specific filtering process modifies each amplification chain. This process digitally converts the assigned spectrum and then applies digital signal processing (DSP) techniques. DSP is used to create passbands that selects the RF energy passing through either the uplink or downlink paths. After the digital processing is complete, the information is converted back to an analog signal that is applied to the remaining stages of amplification. The resulting signals emitted by the repeater are specific to the network service providers' requirements. If these requirements change, only the DSP configuration parameters must change. Configuration parameters are created at the factory and supplied as files to be downloaded to the repeater. The filter set configurations stored in memory determine the unit's adaptability to various field applications. Appendix B describes the band plans and the convention Westell uses to identify and store the files that make up the filter set. All Westell repeaters are shipped with an active filter set that is programmed according to customer specifications. In most cases, the installer will not be required to program a filter.

1.2 Functional Overview

Westell Technologies digital repeaters incorporate the following features for convenient operation, access, protection, and control:

- Network configuration and control using either a web GUI accessed using a web browser or a menu driven user interface using the serial port. The GUI does not require Internet access.



- User gain control (affects all passbands)
- Automatic gain control
- Automatic power control
- Overdrive protection (PA limiting)
- Under/Over voltage protection
- Fault protection
- Alarm notification - local/remote
- Upgrade support - local/remote
- External interfaces - USB/ethernet/Serial
- Re-loadable filters - local/remote
- Web-based monitoring and control - local/remote
- Persistent status and error information

1.3 LED Indicator

Westell Technologies automatic safety precautions are built into the amplifier system. In the case of a catastrophic system event, a shutdown circuit will disable all emissions if the uplink input or downlink input is overdriven or if an oscillation or output overpower event occurs. The amplifier will periodically attempt to recover from the detected condition.

Status LED states are:

- Blinking yellow: Unit is migrating the database after an upgrade
- Blinking red: Unit is programming the filter(s) and there is an error condition
- Blinking green: Boot up or unit is programming the filter(s) and no error condition exists
- Solid green: Unit is operational, PA is on
- Solid yellow: Unit is operational, but AGC is on
- Solid red: Unit has an error condition or PA is off
- Dark: Unit is not powered

Check the GUI status page for the nature of the fault.

NOTE

On power up, the repeater requires approximately three minutes for the internal computer to boot. During this time, the LED labeled Power/Fault or Status will slowly blink green on and off at a rate of approximately 1 Hz. This will indicate that the unit



is in the boot up process. A blinking green LED (two seconds on/three seconds off) indicates a filter configuration file is loading.

IMPORTANT

Do not unplug the repeater while it is in the boot-up process.

1.4 Local Communication Interface Ports

To allow monitoring and control, Westell repeaters are equipped with four ports that provide external communication access: one ethernet, one DB-9 serial, and two USB ports. The ethernet port is a primary communications port to the PC. The serial interface provides communications to a local PC. The USB interface provides a means to download files from a memory device. The DB-9 pin assignments conform to the standard Electronic Industries Association (EIA232) specification. A diagram of the pin descriptions is shown in Figure 1-1.

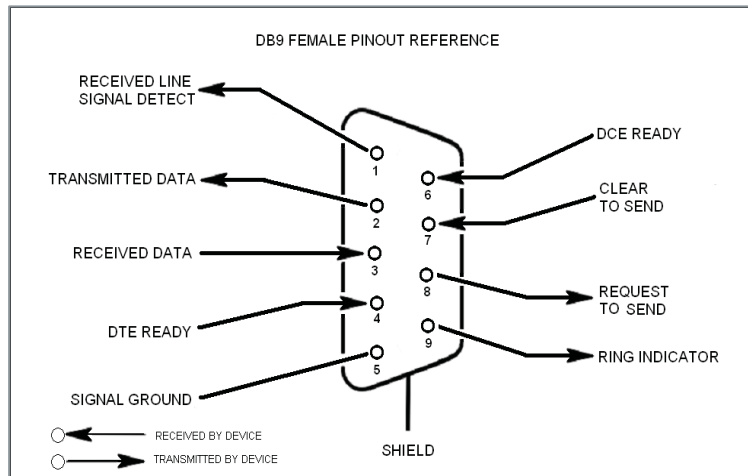

Figure 1-1: DB-9 Pin Descriptions

Connecting a serial cable to the COM port and using a terminal emulation program with a PC will allow communication to the control processor's Text Menu Interface (TMI).

1.5 EIA232 Pin Specifications

The connection diagram shown in Figure 1-1 is for reference only. It is intended as a resource for pinout information if it is necessary to adapt your serial cable because of an unusual connector configuration. In the majority of cases, this information is not needed.

1.6 USB Interface

This port is used for software updates and filter file uploads.



1.7 Ethernet

This port is used to provide local or remote access to the GUI.

1.8 Monitoring and Alarms

The DSP85 Series can be monitored via an ethernet connection using SNMP, SSH and/or HTTP protocols. Public safety DSP models have dry contacts for traditional alarm panel monitoring as well.

1.9 Circuit Operational Description

The repeater uses a single down-conversion/up-conversion scheme. There are multiple RF amplifier stages before each down-converting mixer. The down-converting mixers are followed by a single IF amplifier. A digital signal processor block processes the resultant digitized IF signal generated by an analog-to-digital converter. The filtered digital signal is fed to a digital-to-analog converter and then up-converted to RF. A driver amplifier and power amplifier make up the final gain stages before application to the diplexer. The maximum total system gain (diplexer input to diplexer output) is nominally 85 dB for either the downlink or the uplink paths, with both links having independent manual and Automatic Gain Controls (AGC).

AGC reacts to analog power detection on both the input and output of the uplink and downlink RF chains. A control algorithm continuously monitors these detected values and dynamically adjusts various gain stages. The net system gain value, entered manually, is optimally maintained without exceeding FCC parameters or overdriving the A/D converters.

The Status or Power/Fault LED provides immediate visual indication of the unit's primary power alarm status. The repeater features automatic shutdown protection as a safety measure if excessive drive is applied to the input or an oscillation condition occurs. When in a protected mode, a control algorithm determines the appropriate method of recovery to a normal, previously defined state, or maintains the protection until it is manually reset. If recovery is established, the LED is illuminated green or available to be reset. Events that trigger errors are saved in the event log.

1.10 Functional Block Diagrams



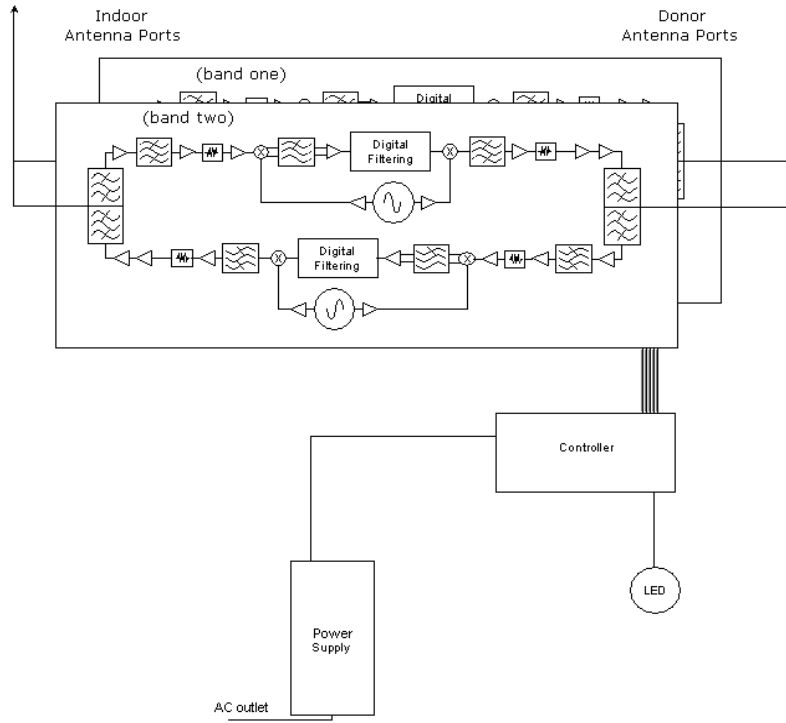
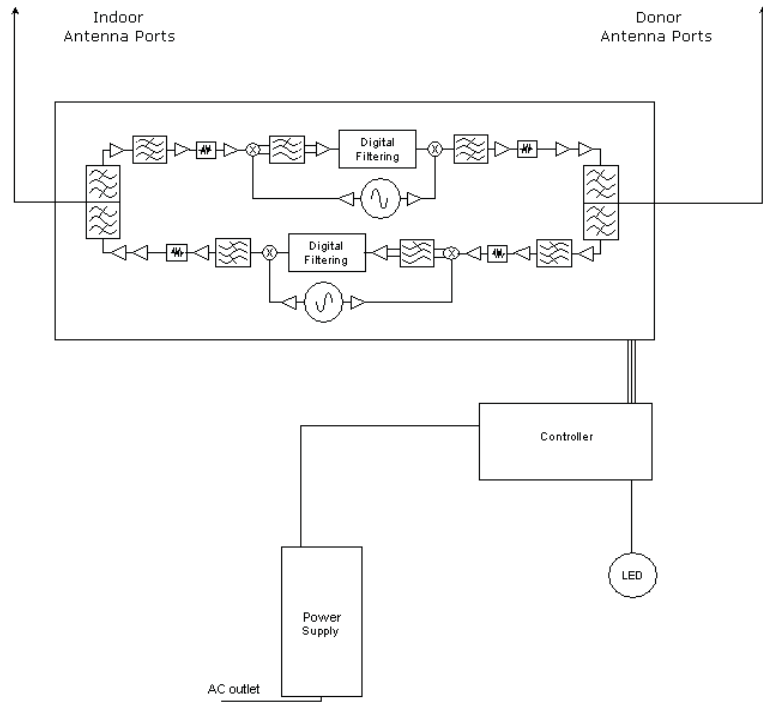

Figure 1-2: Dual Band Functional Block Diagram



Diagram

Figure 1-3: Single Band Functional Block

2 Optimizing the System during Installation

2.1 System Setup Considerations

Check all cables for shorts and opens. Verify that there are no cables with loose or poor connections. RF leakage could cause oscillation to occur under some conditions.

Check the rooftop antenna (donor antenna), if directional, for proper alignment along the calculated compass heading. Typically, the directional antenna is aimed at the same site that your handset uses, but it may not always be. It is critical that the installer contact the service provider for information about, and approval of, the selected cell site before the system is activated.

IMPORTANT

The installation height of the antenna for AWS band (1700/2100 MHz) operations is limited to 10 meters above ground for compliance with Section 27.50.

If cables and alignment are acceptable and a problem persists, it may be necessary to use a spectrum analyzer to examine the signal environment in which the repeater is operating. The existence of strong adjacent channel signals within the frequency band(s) can cause the AGC to reduce the amplifier's gain or cause alarms. In some cases, additional filtering or attenuation may be required to reject these unwanted signals. In some instances, the donor antenna can be repositioned horizontally, to place the interference source in an antenna pattern null. There also may be some cases where the interference from outside signals is so great that they cannot be filtered, reduced or eliminated without expensive (and possibly prohibitive) measures. In these cases, it may not be practical to use the repeater for providing coverage to these sites.

2.2 Suggested Spectrum Analyzer Setting

When troubleshooting RF issues and surveying challenging RF environments, it is important to have a spectrum analyzer that is capable of measuring the frequency you are using. Use an attenuator to protect the input when connected to a source of RF power, such as a repeater or a powered DAS.

Measure both uplink and downlink.

Measure downlink on the donor cable and at the output (server) port of the powered repeater.

Measure uplink at the lead from the DAS (on fiber-powered DAS, where the lead would connect to the server port on the repeater) and at the donor port with the repeater power on.

Measurements may also be necessary at server antenna locations. The spectrum analyzer must be equipped with a whip antenna.

Set the resolution bandwidth (RBW) to 200 kHz for GSM and 1 MHz for CDMA. If you cannot select these values, use the closest available values. Set the video filter to about one-tenth of RBW. Set other settings, such as span, to the appropriate values. Ensure that there are no signals above the top of the screen.

If you cannot see an adjacent out-of-band signal when using the 1 MHz RBW filter, decrease the RBW to see the close-in-frequency signals. Set the RBW back when you want to measure the power level.



2.3 Important Installation Notes

Inadequate isolation between the outside and inside antennas may cause regenerative feedback in the system. This feedback can cause the amplifier to emit a continuous signal at maximum amplitude and, in some cases, interfere with normal operation of the cell site. It is important to consider the layout and placement of the system carefully.

Refer to the **Preface Safety Guidelines** and **Important Safety Information** for proper antenna selection and installation.

DANGER!

To avoid serious injury or death and repeater damage, do not install donor or server antennas near overhead power lines or high power components. Allow enough distance so that, if antennas fall, they will not contact those components.

WARNING!

Close proximity to the donor or server antennas with the repeater in operation may expose the user or installer to RF fields that exceed FCC limits for human exposure.

CAUTION

Amplifier or handset damage may occur if a handset is connected directly to the repeater or to the coax that leads to the repeater.

2.4 Installation Guidelines

2.4.1 Donor Antenna

- Accurately determine the azimuth to the donor cell site.
- Obtain the donor site information and approval from the service provider/carrier.
- Ensure that the radiation path to the donor cell site is as unobstructed as possible.
- Mount the donor antenna at or toward the edge of the roof, in the direction of the donor site. Try to avoid having the RF signal from the donor pass above the location(s) of the service antennas. Normally, service antennas are located behind and below the donor antenna (as viewed from above). This approach will help avoid interference and feedback to and from the service antennas.
- Normally, mounting the donor antenna higher will allow a less obstructed path to the donor site. However, in high traffic metro areas avoid mounting the donor antenna any higher than necessary as the quality of the donor signal may start to become less stable and it is more likely to encounter adjacent channel interference.
- When possible, shield the donor antenna's rear by locating it so that HVAC units and/or penthouse structures are behind the antenna, relative to the donor cell site location.
- Ground system components in accordance with NEC 810-15, 21 as required.



2.4.2 Antennas

- Use omnidirectional antennas indoors, and locate them centrally with respect to the intended coverage area to minimize signal leakage to the outside. Use directional antennas indoors only in special cases when higher gain and directionality would be helpful and RF exposure limits will not be exceeded.
- To avoid repeater uplink overload and gain limiting, mount the indoor antennas away from areas where mobile subscribers frequently use their phones such as desks or dispatch areas.
- To determine the quantity and locations of indoor antennas, use an appropriate phone's signal meter to determine areas of weak signals. These are the approximate areas where indoor antennas may be needed. Be aware the signal from an indoor antenna, in most cases, can be expected to penetrate about two standard office sheetrock-type walls to reach users. After two walls, or if the walls are made of other materials, it may be necessary to split the available signal and add more antennas.

2.5 Optional Accessories

A complete line of accessories is available from Westell. Check with your Westell distributor for any additional items needed. Below are just a few examples suitable for most in-building needs:

2.5.1 Outside Donor Antenna

- PCS - model number CSI-AY/1.85-1.99/10
- Cellular - model number CSI-AY/806-960/14

2.5.2 Inside Omnidirectional Antenna

- Quad-band - model number ClearLink-O/698-2.7K/N

2.5.3 Power Dividers

- 2:1 - model number ClearLink -SPD2/698-2.7K-LP/N
- 3:1 - model number ClearLink -SPD3/698-2.7K-LP/N
- 4:1 - model number ClearLink -SPD4/698-2.7K-LP/N

2.5.4 Grounding Kit

- Model number CSI-GKIT



2.5.5 Directional Couplers

- 6 dB - model number ClearLink-DC6/698-2.7K/N
- 10 dB - model number ClearLink -DC10/698-2.7K/N
- 15 dB - model number ClearLink -DC15/698-2.7K/N
- 20 dB - model number ClearLink -DC20/698-2.7K/N
- 30 dB - model number ClearLink -DC30/698-2.7K/N

2.5.6 19" Rack Shelf

- Model number CSI-RMS-250

2.5.7 UPS

- Battery backup, two hour single-band, one hour dual-band - model number CS48-985-600
- Battery backup, four hour single-band, two hour dual-band - model number CS48-985-601

2.5.8 Cross Band Couplers

- Quad-band Rack Mount - model number CSI-CM250-7/C/AW/P (700 LTE, Cellular, PCS and AWS)
- Quad-band Wall Mount - model number CSI-CBC/QUAD/N (700 LTE, Cellular, PCS and ASW)
- Tri-band Rack Mount - model number CSI-CM250-U7C/C/P (700 Upper C LTE, Cellular and PCS)
- Tri-band Wall Mount - model number CSI-CBC21/740-1990/N (700 Upper C LTE, Cellular and PCS)
- Tri-band Rack Mount - model number CSI-CM250-L7/C/P (700 Lower A/B/C LTE, Cellular and PCS)
- Tri-band Wall Mount - model number CSI-CBC21/696-1990/N (700 Lower A/B/C LTE, Cellular and PCS)



3 Web-based GUI

3.1 Web-based GUI Session

You may access the repeater using a LAN connection and a web browser program such as Internet Explorer, Figure 3-1.

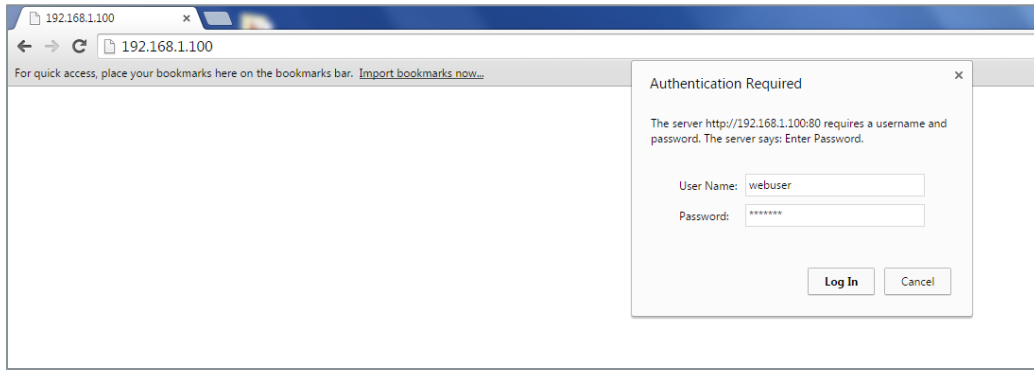

Figure 3-1: User Connection Login

The repeater ships with the default IP address of 192.168.1.100, but you can change it later if you need to.

1. If connecting directly to the repeater from a laptop or PC with a crossover CAT-5e cable or over a LAN, enter the IP address of the repeater into the browser address line to connect.
2. Most users will need to update the TCP/IP settings on their computer to enable connection to a host that has a static IP. Refer to section 4.4 Additional Tips for more information.
 - a. Select **Use the following IP Address** and enter the IP address as follows: **192.168.1.x**, where 'x' is any number from 2 to 254, inclusive, except 100. The subnet mask is 255.255.255.0. Refer questions pertaining to these settings to your IT department, or review section **4.4 Additional Tips**.
3. When connection is made, you will be prompted for a user name and password. For the purpose of the GUI session, enter the default user name **webuser** and the password is **csi1234**, shown in Figure 3-1. Username and password can be changed as required.

Internet access is not required to use the GUI. If you are connecting using a laptop, verify that your ethernet port has power. Some laptops will not allow ethernet connection when on battery power. If this occurs, connect to AC line power or update the power settings.

NOTE

The GUI screens shown throughout this manual show a dual-band Cell/PCS configuration. They are for illustration purposes only. The actual screen you see will depend on the individual configuration.



3.2 System Status

After login, the **System Status** page displays, Figure 3-2. The Navigation Menu on the left side of the page (highlighted in Figure 3-2) shows available operations. Clicking a menu item displays the page for that operation.

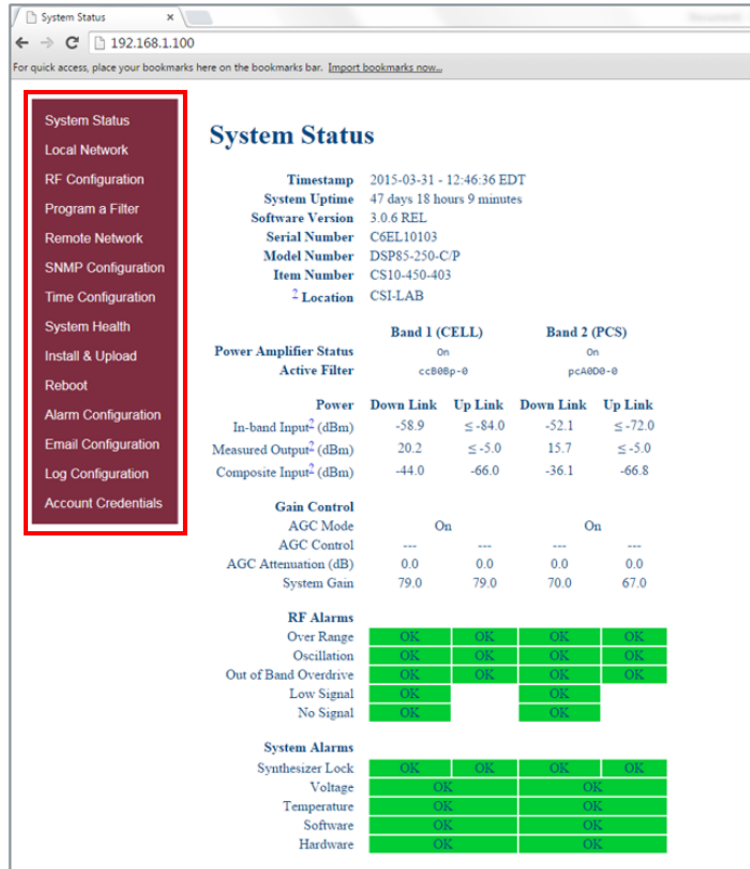

Figure 3-2: System Status

3.3 Local Network

Click **Local Network** in the **System Status** left page menu to display the Local Network screen, Figure 3-3, displays. This page allows you to modify the network configuration. The default Boot Mode is **Static**. Check with your IT department for explanation and approval of the DHCP and DHCP server options you plan to use before you select them.

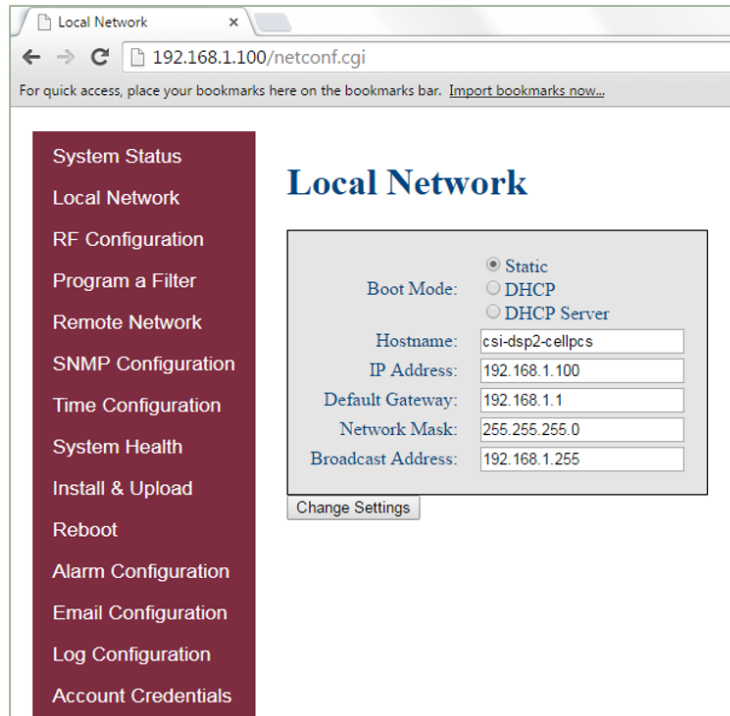

Figure 3-3: Local Network

NOTE

In repeaters with software version 2.2.4 or older, only letters, numbers and underscores are acceptable in the text fields. In repeaters with software version 2.3.0 and newer, underscores are unacceptable. Hyphens are acceptable.

After you have made the necessary changes, refresh the page to review the fields and ensure the information is correct.

NOTE

Changing network settings causes the current TCP/IP connection to fail because changes take effect immediately.



3.4 RF Configuration

Click **RF Configuration** in the left page to display and modify the RF Configuration page, Figure 3-4.

To change gain settings, select the **Uplink only** or **Uplink and downlink** radio buttons. Enter the desired gain value between 53.5 dB and 85 dB. The repeater will not allow values outside this range. Implement change in gain by clicking the **Change Settings** button at the bottom of the page.

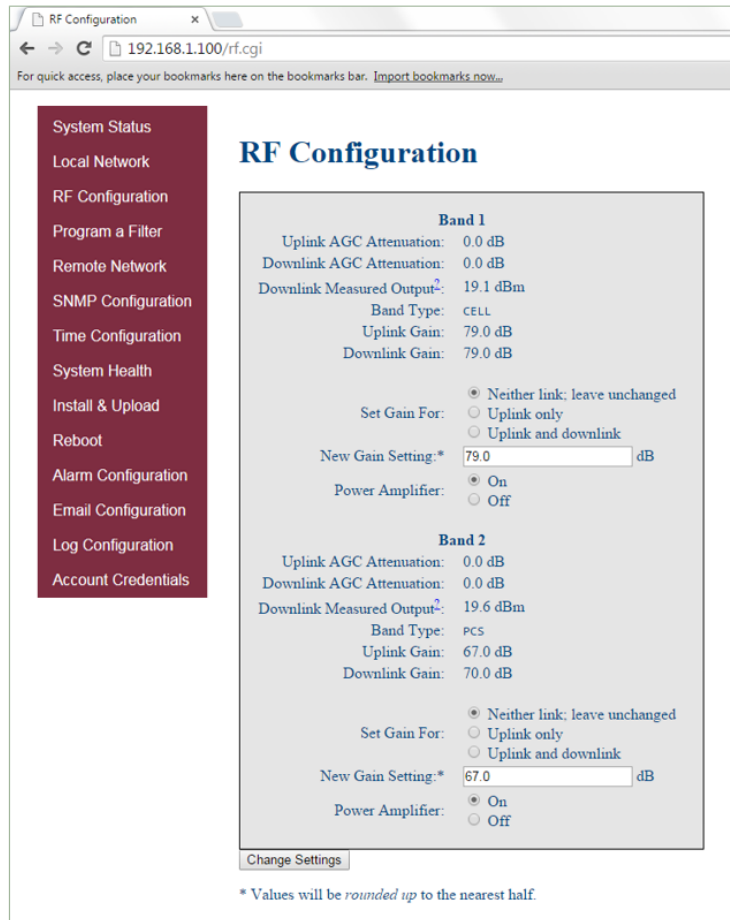

Figure 3-4: RF Configuration



3.5 Program a Filter

Click **Program a Filter** in the left page menu. The **Program a Filter** page, Figure 3-5, displays. Change the selected filter in the band/sub-band and modulation options.

Deselect undesired bands/sub-bands if they are selected (highlighted). The **Clear All** button on the selected band deselects all band and sub-bands simultaneously. Clicking the **Program** button completes the selection and loads the desired filter. This process may take several minutes. If the desired filter is not currently in the repeater, additional filters, along with instructions on how to load them, are available by contacting Westell Technologies.

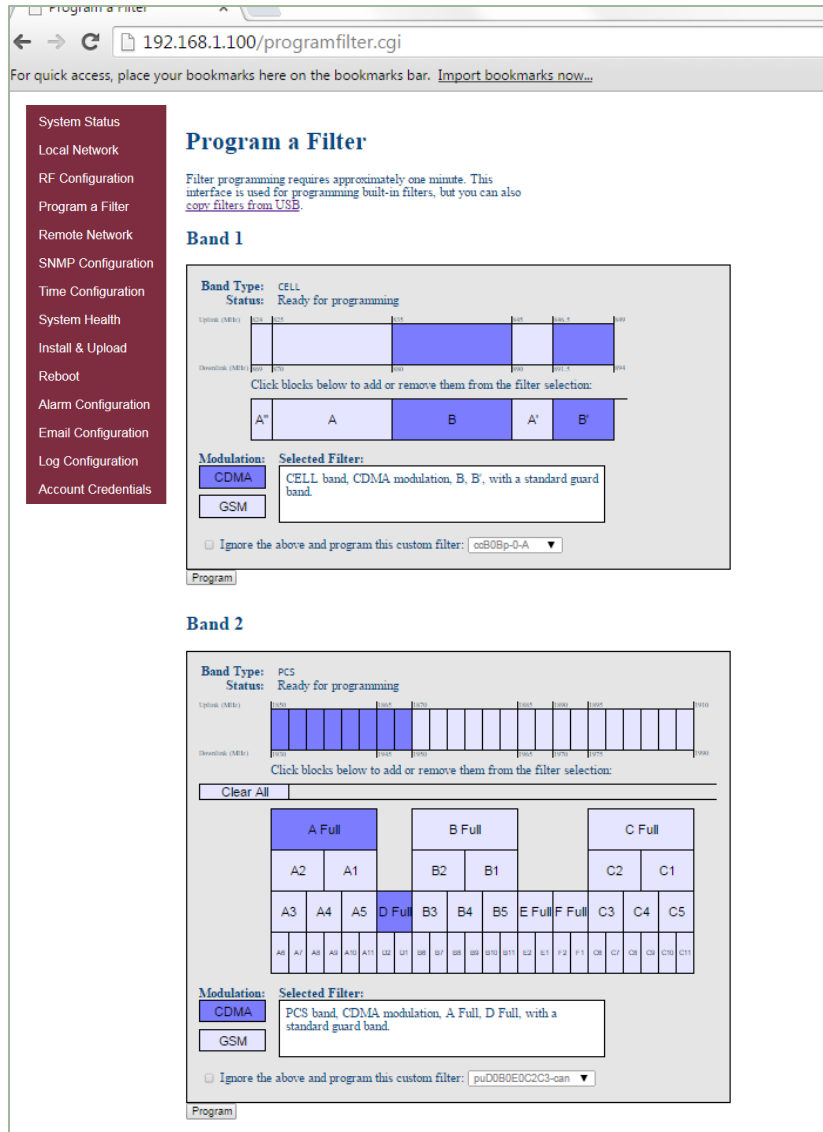

Figure 3-5: Program a Filter



3.6 Remote Network

If the repeater includes a USB modem kit, click **Remote Network** in the left page menu. The Remote Network page displays, Figure 3-6. Highlight the carrier on whose network the repeater and modem will be configured and click the **Change Settings** button. Refer to the documentation included with the modem kit for additional information about modem configuration. If the repeater is connected to an ethernet device for remote access and/or monitoring, this feature must be disabled.

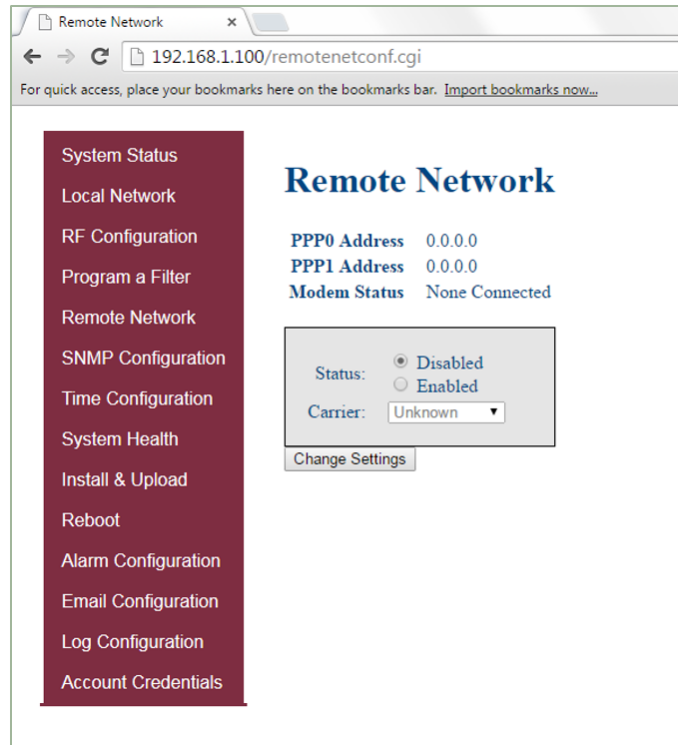

Figure 3-6: Remote Network

3.7 SNMP Configuration

To change SNMP settings, click **SNMP Configuration** in the left page menu. The SNMP Configuration page, Figure 3-7, displays. Check with an IT professional for proper SNMP setting requirements.

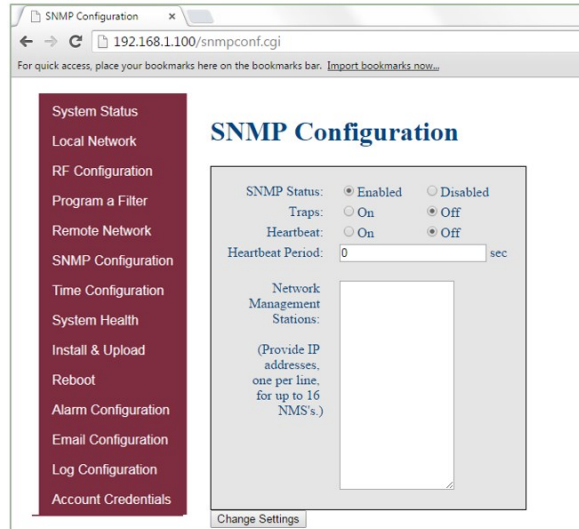

Figure 3-7: SNMP Configuration

3.8 Time Configuration

Click **Time Configuration** in the left page menu to display the **Time Configuration** page, Figure 3-8. This page allows you to set the current system time and time zone.

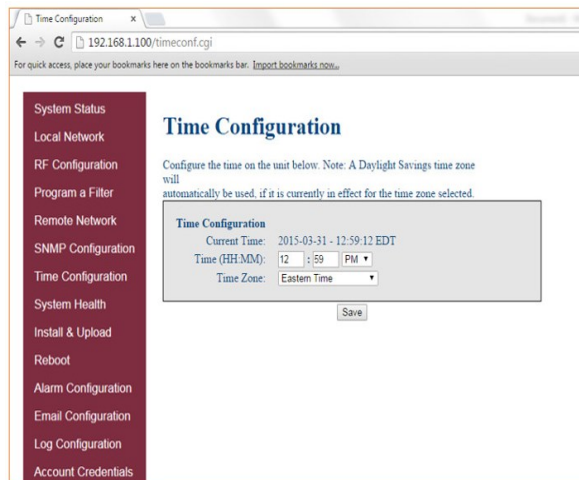

Figure 3-8: Time Configuration



3.9 System Health

Click **System Health** in the left page menu to display the System Health page, Figure 3-9. This page displays the current repeater status. Click the **Clear Log** button to clear LED indicators, alarms and the event log. If required, display the **System Health** screen, click **Trigger Test Alarm** and wait for confirmation that the WSP representative that is responsible for monitoring the repeater has been notified of the alarm.

Be sure to click **Clear All Logs** before logging out of the Web interface.

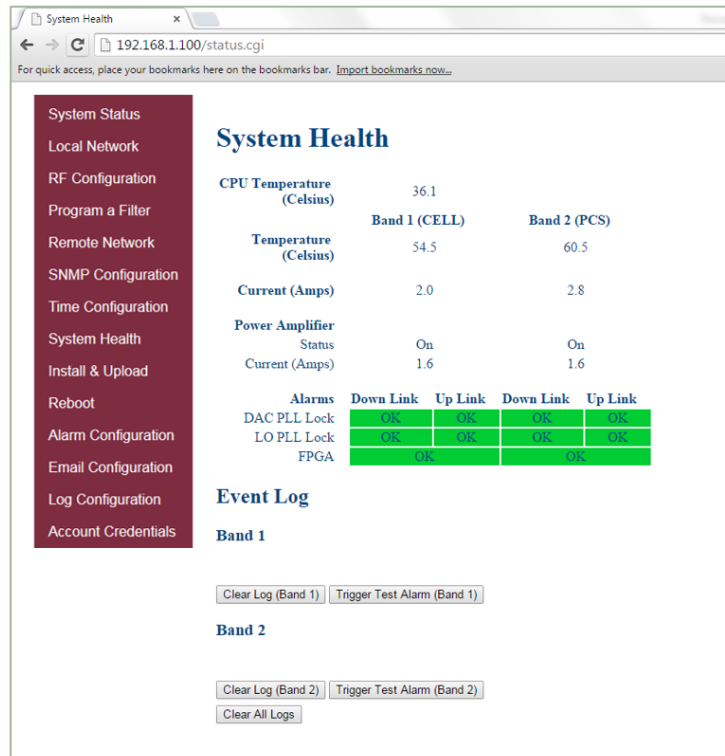

Figure 3-9: System Health

3.10 Install and Upload

Click **Install & Upload** in the left page menu to display the Install & Upload page, Figure 3-10. Use this page to perform a software installation or upgrade. Contact Westell Technologies for new software versions.

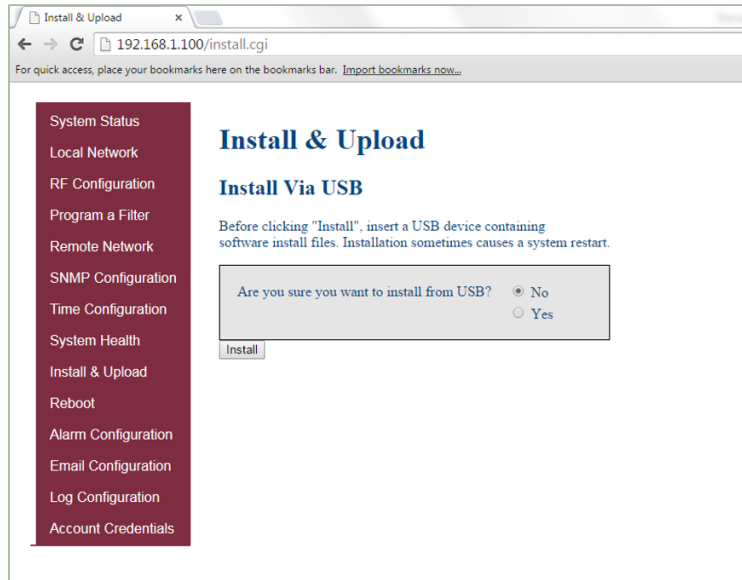

Figure 3-10: Install & Upload

IMPORTANT

You must click to select the **Yes** radio button before you click the **Install** button.

If you do not, the installation will not be performed and an error message will display.

3.11 Reboot

Click **Reboot** in the left menu to display the Reboot page, Figure 3-11, which allows you to reboot the repeater. A reboot takes approximately three to five minutes to complete.

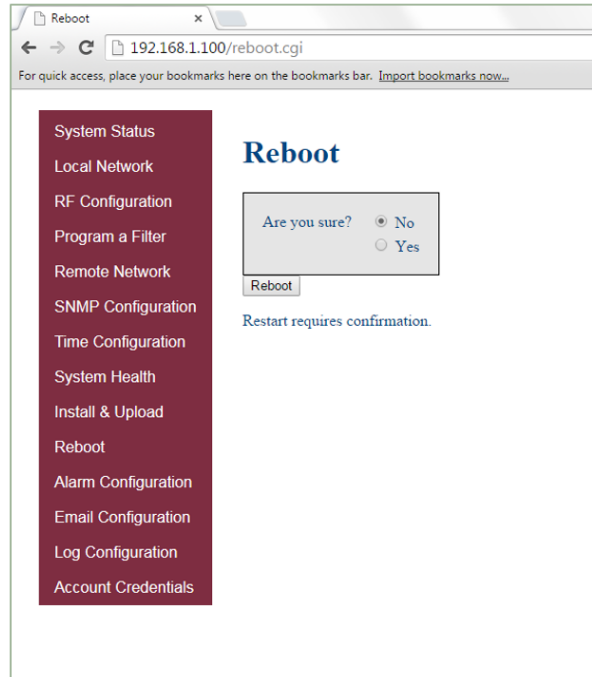

Figure 3-11: Reboot

3.12 Alarm Configuration

Click **Alarm Configuration** in the left page menu to display the Alarm Configuration page, Figure 3-12. This page displays the current alarm configurations for each band and allows you to make changes by editing alarm settings and the clicking the **Apply Settings** button. Letters, numbers and hyphens are the only acceptable nomenclature for the location field. Hyphens may not be used as the first or last character.

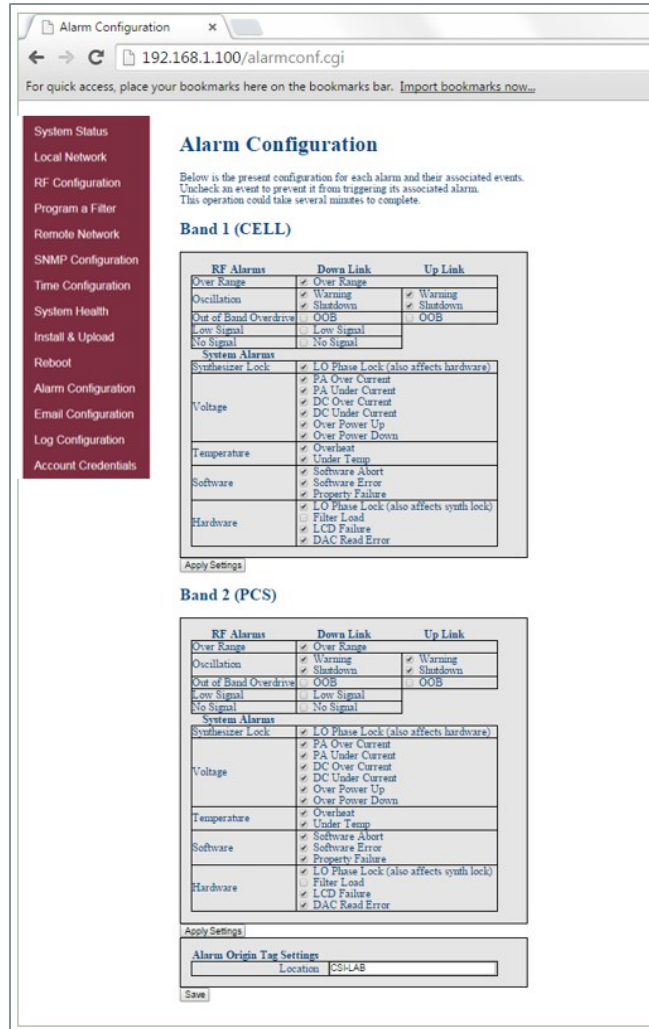

Figure 3-12: Alarm Configuration



3.13 Email Configuration

Clicking **Email Configuration** in the left page menu displays the Email Configuration page, Figure 3-13. This page allows you to enter up to five e-mail addresses to which the repeater can send specified alarm messages. Alarm messages can be sent only when the repeater is connected via ethernet or wireless modem, and e-mail alarm notification or remote networking are enabled. The software will not allow you to enter invalid characters in any field.

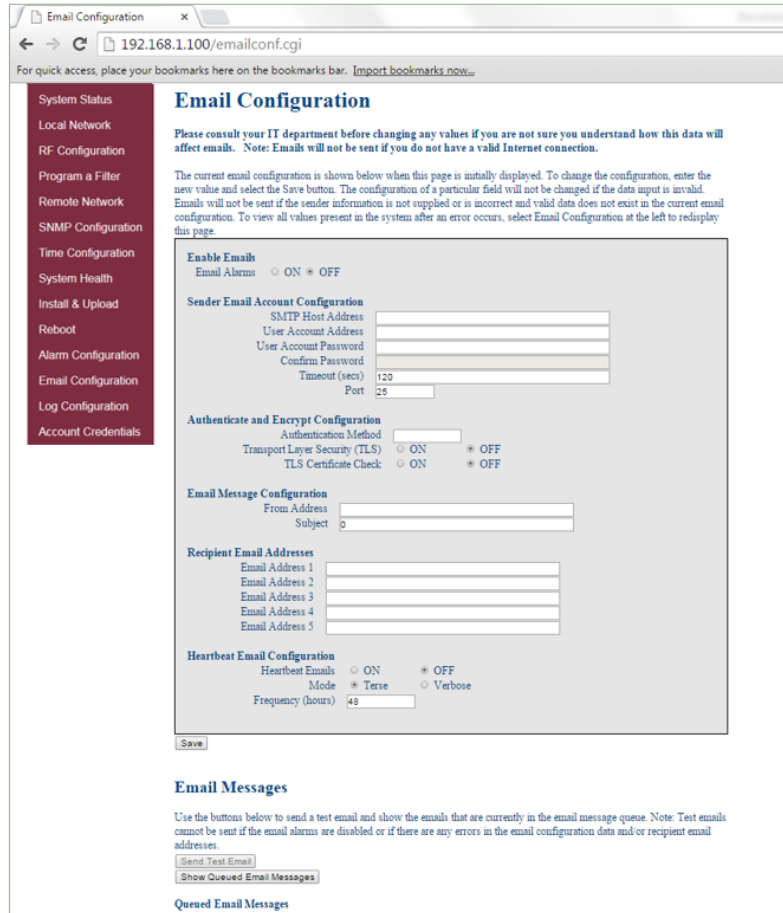

Figure 3-13: Email Configuration



3.14 Log Configuration

Click **Log Configuration** to display the Log Configuration page, Figure 3-14. This page provides you with the ability to change three aspects of the way log files are created and stored: Log Rotate Frequency, Log Rotate File Size and Log Rotate File Count. Enter the desired settings for each and click the **Configure Logs** button to save the settings.

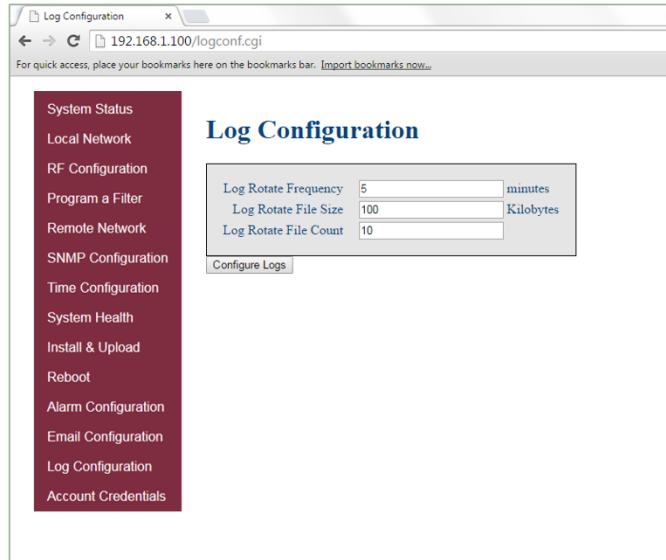
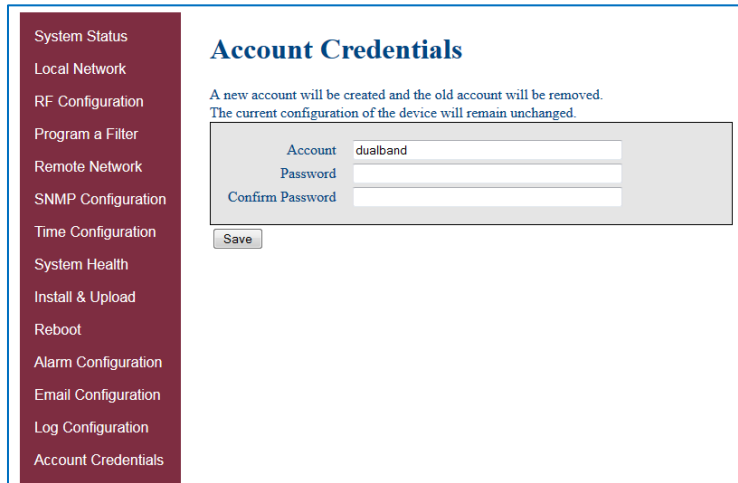

Figure 3-14: Log Configuration

3.15 Account Credentials

Clicking **Account Credentials** in the left page menu displays the Account Credentials page, Figure 3-15. On this page, you can create a new account or reset the repeater password. The old account is removed when the new account is created. If you need to recover a password you have set, contact Westell Technologies technical support line at 1.877.844.4274, Option 2, then Option 1 for assistance.



Account Credentials

A new account will be created and the old account will be removed.
The current configuration of the device will remain unchanged.

Account	dualband
Password	
Confirm Password	

Save

Figure 3-15: Account Credentials

4 Console Interface

4.1 Text Menu Interface (Local Access)

To gain local access to the repeater TMI, also known as the console interface, connect a null modem serial cable as shown in Figure 4-1, from the serial connector of the laptop to the serial port on the repeater. This connector is labeled COM. In some cases, if the gender of the connector is not the same as the connectors shown in Figure 4-1, a gender adapter (optional), Figure 4-2 may also be required.



Figure 4-1: Null Modem Cable



Figure 4-2: Gender Adapter

Many terminal emulation programs will work if properly configured. In this section, Tera Term is used to establish the TMI session.

Figure 4-3 displays when the application opens.

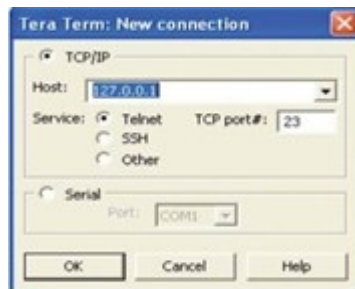

Figure 4-3: Tera Term Pro Web Start Up

1. Select the **Serial** radio button and click **OK**, Figure 4-4.

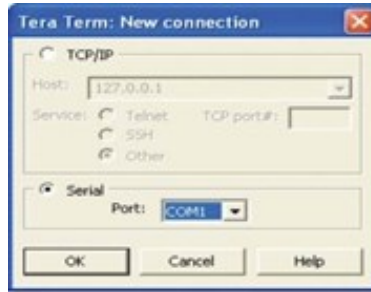

Figure 4-4: Serial Radio Button

NOTE

It may be necessary, to determine which COM port your computer uses for the communications port. Do this in by viewing the system properties section of the control panel using device manager. In this case, the communications port is COM 1. This is not to be confused with the serial port on the bottom panel of the repeater that is also labeled COM 1.

2. Click **OK**. A blank dialog screen, Figure 4-5 displays.
3. Click **Setup** to expand the drop-down menu, Figure 4-5 and select **Serial port**. The Serial Port Setup window, Figure 4-6, displays. In this window, you can make changes to the serial port setup.

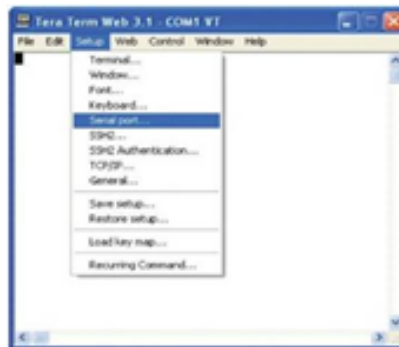

Figure 4-5: Setup

4. Configure the terminal program for the correct COM port, Figure 4-6.
 - a. Under the Port drop-down list, select **COM 1**.
 - b. Under the Baud rate drop-down list, select **115200**.

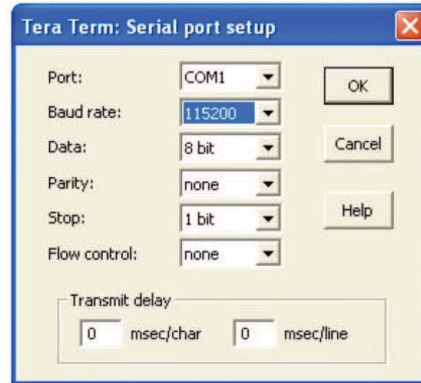

Figure 4-6: Serial Port Setup

5. After completing the serial port changes, click **OK**. A dialog displays, prompting you to enter a user name and password.
6. Enter a username and password and press the **Enter** key. The TMI Main Menu displays, Figure 4-7.

IMPORTANT

In dual-band units, each band is changed independently and requires an independent login. The default user name for the first band is **bandone**. The default user name for the second band is **bandtwo**.

The password for both bands is **csi1234**.

7. The **set parameters** option is disabled by default. To enable it, press **1**. A dialog displays, prompting you to enter a user name and password.
8. Enter the default user name **csi** and the password **csi1234**.

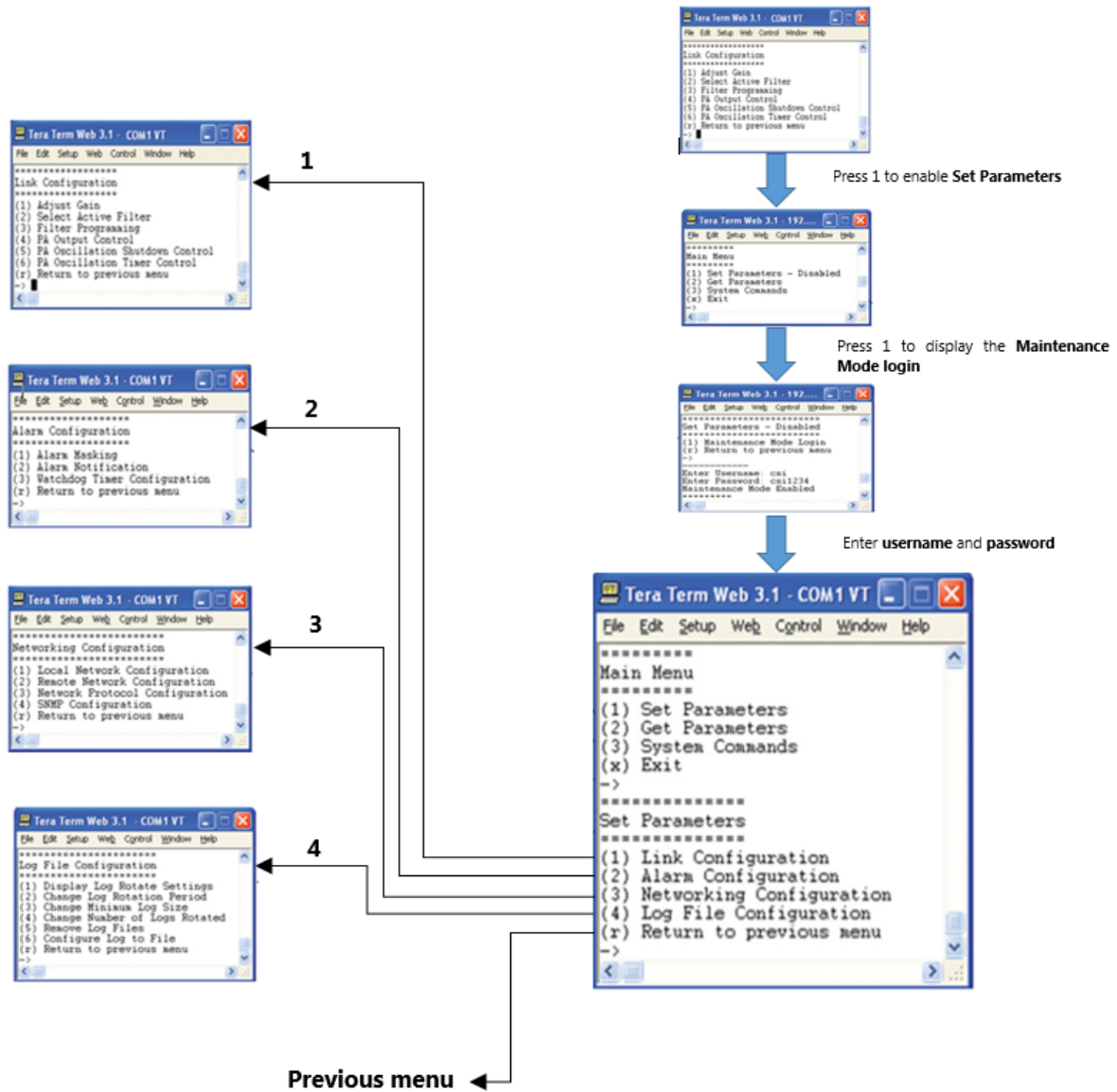

Figure 4-7: TMI Menus

When you select an item in the **Set Parameter** menu, a sub-menu expands to allow configuration of the selected parameter.

For example, Selecting **1 - Adjust Gain** in the **Link Configuration** menu, displays the **Links:** menu shown in Figure 4-8.

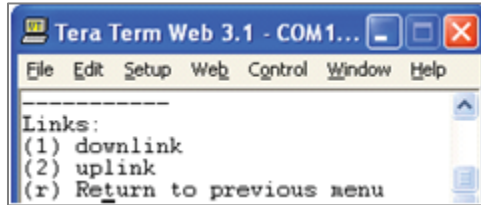

Figure 4-8: Adjust Gain

Selecting option **(1) downlink** in the **Links:** menu displays the current user gain, Figure 4-9.

Change the gain value by entering the desired gain value at the prompt. You may return to the previous menu by selecting **r**.

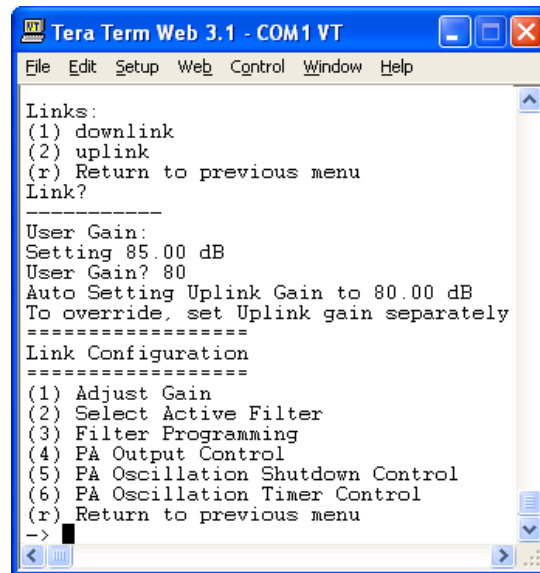

Figure 4-9: User Gain

All other sub-menu items function in much the same way as the Adjust Gain item. Some of the items will offer additional selections and will be self-explanatory. Figure 4-10 is one example of these additional options. This menu displays when **(3) Filter Programming** is selected.

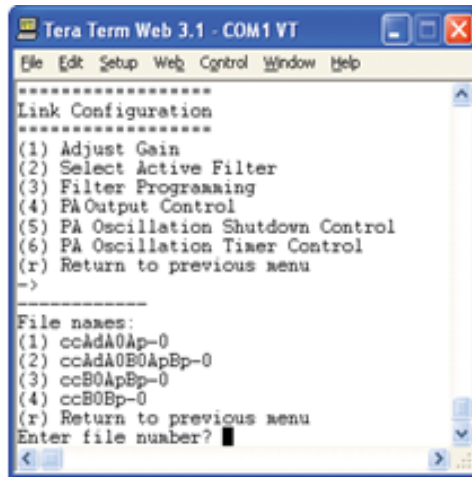

Figure 4-10: Selecting Filter Programs

IMPORTANT

Navigate to **File>Disconnect** to terminate a session. If you do not, the port may become disabled and the system will need to be rebooted.

4.2 Telnet Session (Remote Access)

You may access the repeater using a LAN connection and a terminal emulation program for TCP/IP. As with the serial connection, many terminal emulation programs will work, if properly configured.

In the following section, Tera Term is used to establish the Telnet session. The network configuration of the computer and the repeater that is being controlled must be set up with the same subnet and subnet mask to establish a link. In other words, the IP addresses of both the computer and the repeater must use the same group of IP address number sets.

For example, the repeater ships with a default IP address of 192.168.1.100 and a subnet mask of 255.255.255.0, as shown in Figure 4-11. To connect, the computer used for the link would normally need an IP address of, for example, 192.168.1.2 with a subnet mask of 255.255.255.0, the same subnet mask as the repeater.

In this example, the last digit of the IP address may be any number except 1,100 and 255. Configuring your PC is straight forward, but it varies according to the operating system used. If you require assistance, contact your IT department or you may review the **4.4 Additional Tips** section.



When the Tera Term application opens, the window in Figure 4-11 displays.

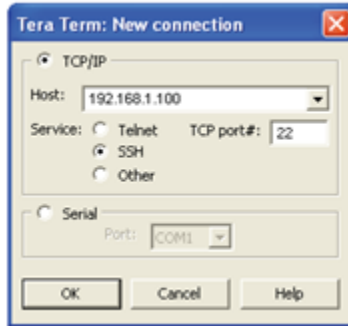

Figure 4-11: Default IP Address

1. Change the default host IP address to the IP address of the repeater to be controlled. In the case of a new install, the default address is 192.168.1.100 and has been assigned at the factory.
 - a. Select **Service>Telnet**. The TCP port must be **23**.
2. Click **OK**. The login screen, Figure 4-12, displays.



Figure 4-12: Login Screen

3. Enter the username and password.

IMPORTANT

In dual-band units, each band is changed independently and requires an independent login. The low band default username is **bandone**. The high band default username is **bandtwo**. In the field after the prompt, enter the user name for the band to be changed. The default password is **csi1234** for both bands.



4. After you enter the password, press **Enter**. The main menu, Figure 4-13, displays. Telnet and serial sessions both provide access to the same TMI.

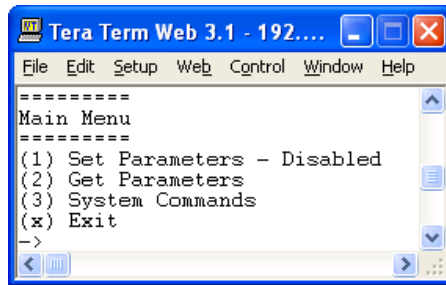

Figure 4-13: Main Menu

4.3 Modem Interface (Remote Access with Login)

If the repeater is properly equipped, you may use a modem to gain remote access to the repeater. A selection of modems are available as options.

After you have installed and activated the modem, you can access it from any web browser. Access response time depends on many factors, some of which are:

- Quality of the connection (RF signal in the case of wireless modems)
- Technology (CDMA, LTE, GPRS, etc.)
- Network congestion (throughput)

When a connection has been established, the login screen shown in both the GUI Serial and Telnet examples displays.

4.4 Additional Tips

Follow the steps in this section to change the TCP/IP settings on your Windows computer.

1. Open your computer's **Control Panel** as shown in Figure 4-14.

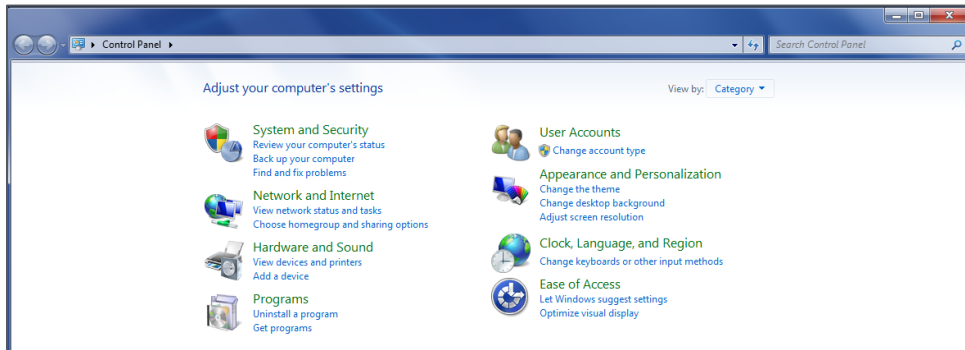

Figure 4-14: Control Panel

2. Click on **View network status and tasks**, under Network and Internet as shown in Figure 4-15.

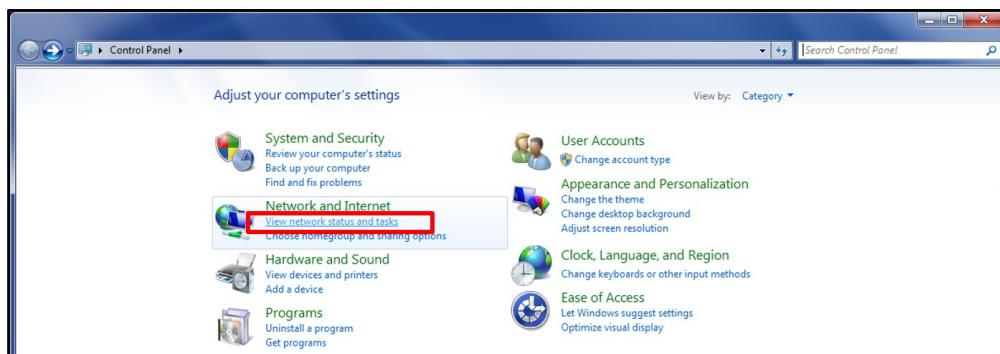

Figure 4-15: View Network Status and Tasks

3. On the left side, click **Change adapter settings** as shown in Figure 4-16.

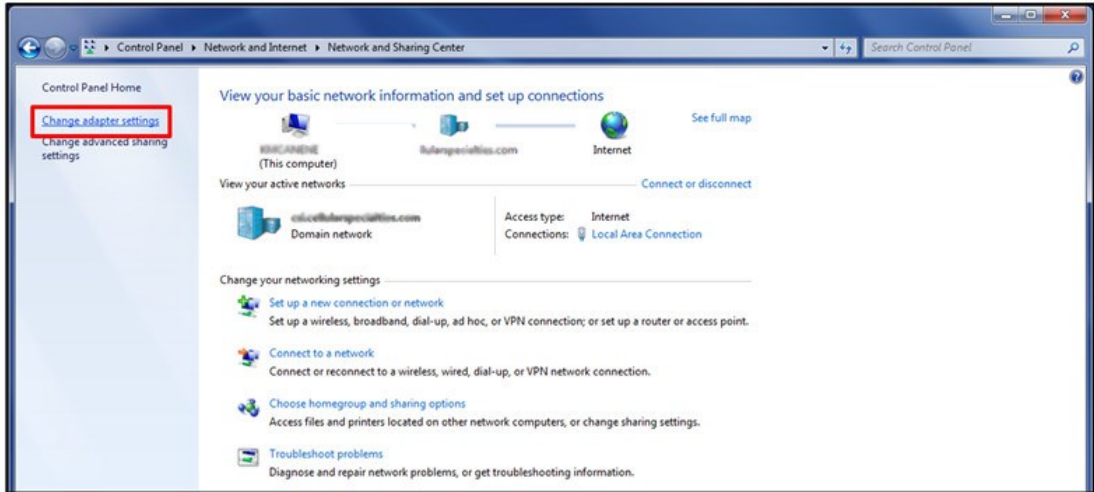

Figure 4-16: Change Adapter Settings

4. Right click **Local Area Connections** and select **Properties** as shown in Figure 4-17.

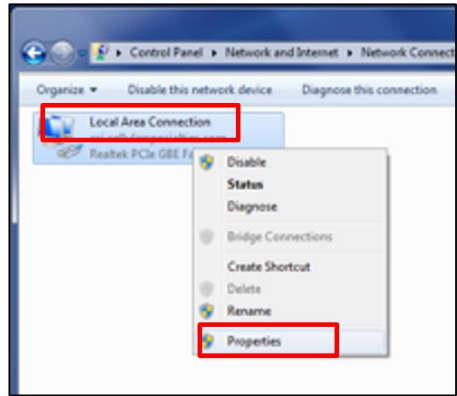

Figure 4-17: Local Area Network

5. Double click **Internet Protocol Version 4 (TCP/IPv4)**, or highlight **Internet Protocol Version 4 (TCP/IPv4)** and select **Properties**, Figure 4-18.

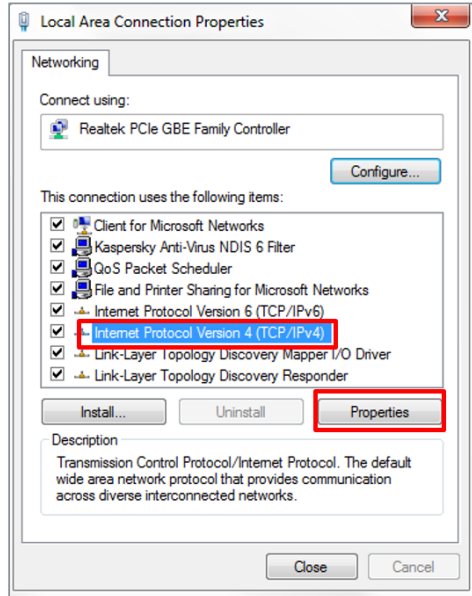

Figure 4-18: Internet Protocol Version 4 (TCP/IPv4)

- Click to select the radio button next to **Use the following IP address**, which will allow you to populate the IP address and Subnet mask fields. In the **IP address** enter **192.168.1.2**, and click **OK**, Figure 4-19.

NOTE

The Subnet mask will automatically populate to 255.255.255.0.

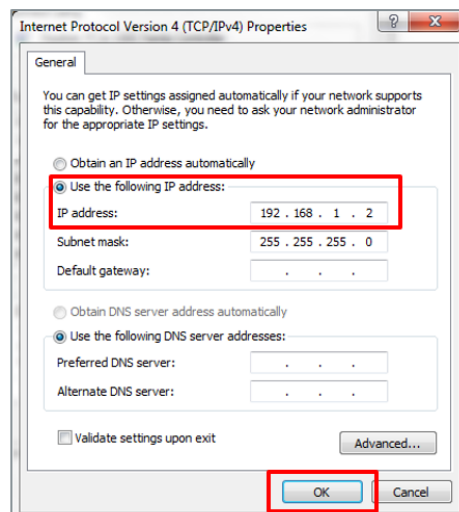

Figure 4-19: Enter IP Address



7. Click **OK**, then click **OK** again.
8. Retry the connection.

Use a crossover ethernet cable (supplied) for web interface access. You must verify that the ethernet port on your laptop is powered. If your laptop is on battery power, the ethernet port may be inactive by default. If this is the case, plug the laptop into a 110 VAC source or change the power settings to enable the ethernet port when the laptop is using battery power.

In some cases, DNS Server setup is required. To do this, log in as **bandone** through a SSH or serial connection. After you have logged in, follow the setup instructions. The **DNS Address** is the IP address of the modem (enter it in twice).



Appendix A Attenuation and Dynamic Range Guidelines

A.1 Donor Port

If a repeater is installed in an area with very strong wanted and/or unwanted signals, ensure that the overall signal levels are optimized to be within the best operating range of the repeater. Avoid de-sensing of a nearby base station site. You can accomplish these goals by properly attenuating the antenna port(s) in the path of the donor antenna(s). Imagine that the particular repeater deployment is electrically moved farther from the base station using attenuators that are equivalent to increasing the path loss from the donor antenna to the base station.

The following outcomes may result from the use of attenuators on the donor port(s) of the repeater:

- Uplink output power, as reported by the unit, is reduced by the value of the attenuation, protecting nearby base stations.
- Downlink signal-to-noise ratio is high at the point of the attenuator, resulting in slight but negligible reduction in downlink performance.
- Other performance is essentially unchanged.

A.2 Server Port

Server port attenuation may also be necessary, particularly where a powered DAS is present. The selection guidelines below apply to both server and donor ports. Use a signal generator to measure uplink signal strength properly.

If a signal generator is unavailable, place a test call while under the server antenna with the least path loss to the repeater. This method should provide reasonable data.

The following potential outcomes result from the use of attenuators on the server port(s) of the repeater:

- downlink output power, as reported by the unit, is reduced by the value of the attenuation.
- Uplink incoming power from the DAS is reduced, along with potentially strong and/or harmful out-of-band signals (including noise) that are generated by the DAS.

Choose accurate attenuator values to ensure that the maximum total power (higher of composite or in-band input) applied to the donor and server port(s) does not exceed -25 dBm.

A.3 Dynamic Range Thresholds

Table A-1: Dynamic Range Thresholds

Input Signal	Max Gain	Input Signal	Max Gain
<-45 dBm	85 dB	-32.2 dBm	69 dB
-44.3 dBm	84 dB	-31.4 dBm	68 dB
-43.6 dBm	83 dB	-30.6 dBm	67 dB
-42.9 dBm	82 dB	-29.8 dBm	66 dB
-42.2 dBm	81 dB	-29 dBm	65 dB
-41.5 dBm	80 dB	-28.2 dBm	64 dB
-40.6 dBm	79 dB	-27.4 dBm	63 dB
-39.7 dBm	78 dB	-26.6 dBm	62 dB
-38.8 dBm	77 dB	-25.8 dBm	61 dB
-37.9 dBm	76 dB	-25 dBm	60 dB
-37 dBm	75 dB	-24.4 dBm	59 dB*
-36.2 dBm	74 dB	-23.8 dBm	58 dB*
-35.4 dBm	73 dB	-23.2 dBm	57 dB*
-34.6 dBm	72 dB	-22.6 dBm	56 dB*
-33.8 dBm	71 dB	-22 dBm	≤55 dB*
-33 dBm	70 dB		

*We recommend padding this level, due to potential for fluctuating signal.

-25 dBm is the maximum input signal level that can be applied to the repeater, even if the gain is set to 53.5 dB. Input signals exceeding these thresholds will result in composite input attenuation, or analog-to-digital converter protection (ADC protect). Output power is reduced whenever the above thresholds are exceeded by reducing the gain by 1 dB for each 1 dB that the threshold is exceeded. Do not confuse ADC protect with AGC (automatic gain control), which reduces gain to prevent in-band (measured) output power from exceeding the specified maximum output level.

Gain levels that would result in exceeding the rated output power of the repeater, e.g. 65dB of gain applied to an input signal of -30dBm, will not result in ADC protection, but will result in AGC. Avoid continually operating the repeater in AGC.

To determine the total power applied to the donor and server ports, reference the composite input values as listed on the System Status page in the web GUI.

A.4 Large Deltas between In-band and Composite Input Signals

Isolate the best donor site to ensure the least possible delta between in-band and composite downlink signals.

If the (downlink) composite input exceeds the in-band input by more than 3 dB Cellular, or more than 5 dB PCS, the maximum output power will be reduced.



Appendix B Band Plans and Filter File Naming Conventions

B.1 Frequency Band Plans

B.1.1 700 MHz Lower A, B and C Band Plan

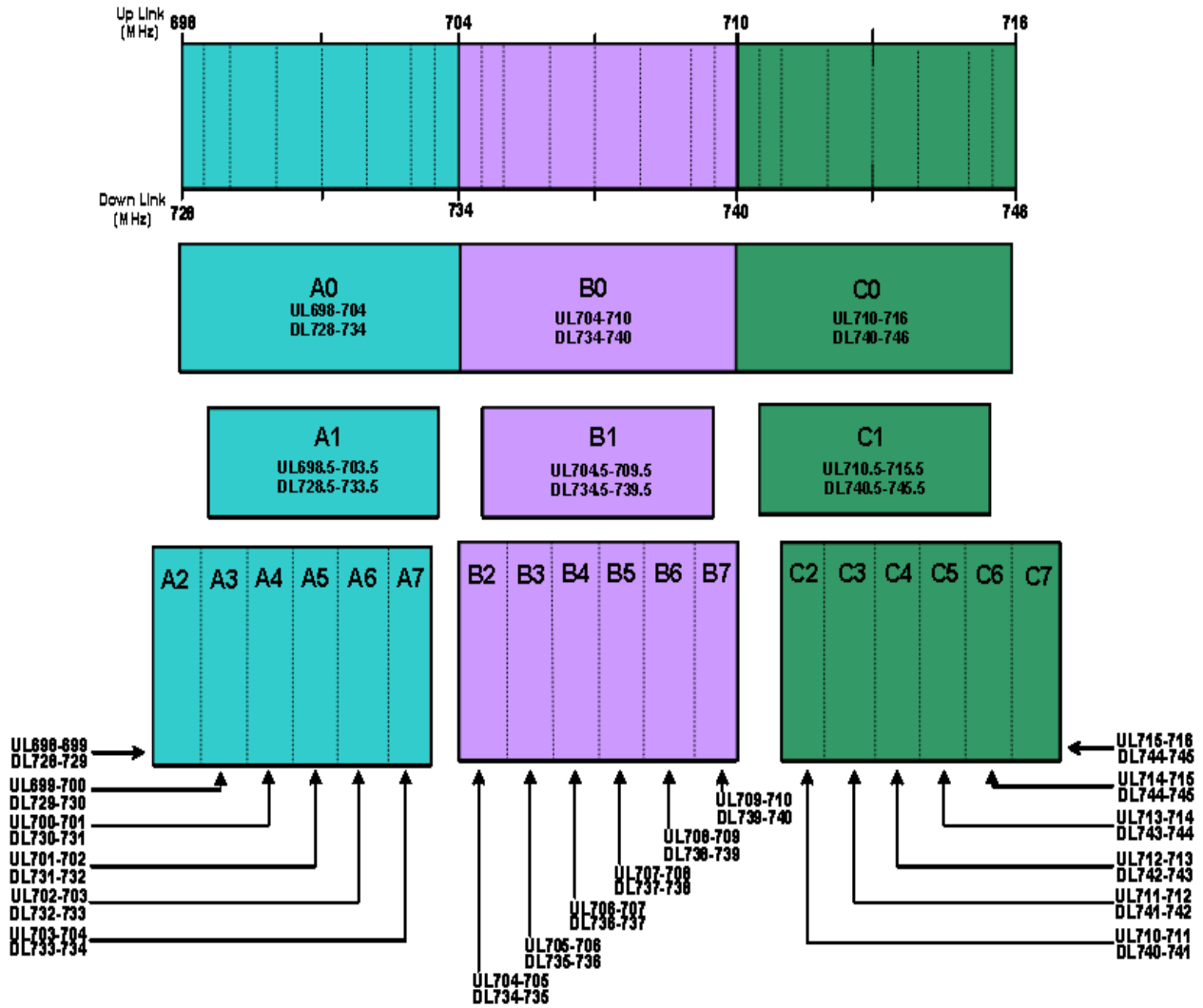

Figure B-1: 700 MHz Lower A, B and C Band Plan

B.1.2 700 MHz Upper C Band Plan

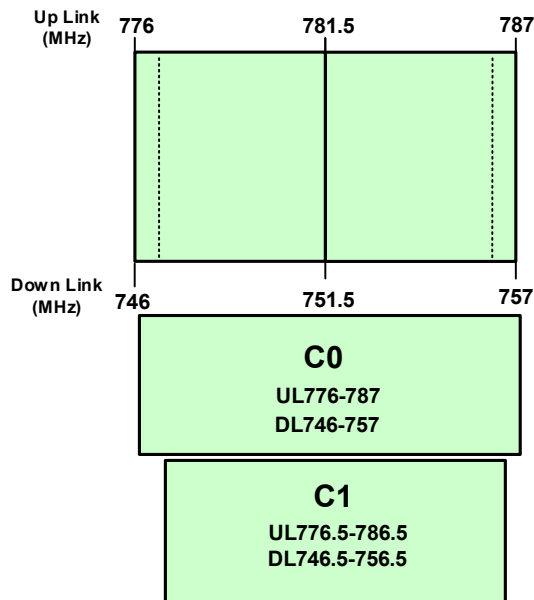

Figure B-2: 700 MHz Upper C Band Plan

B.1.3 Cellular Frequency Band Plan

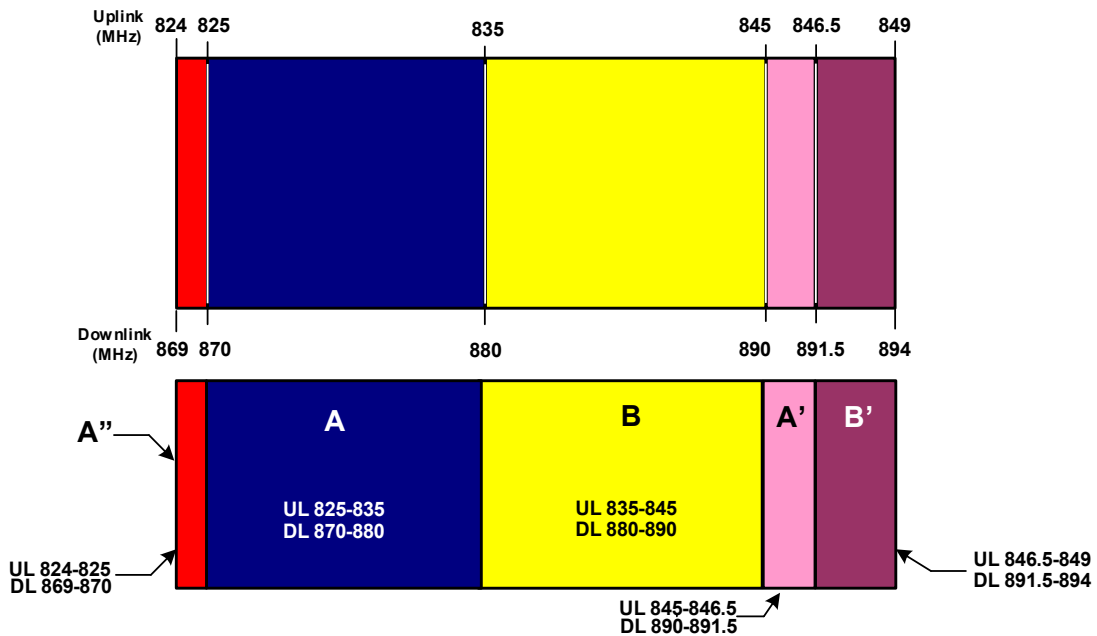

Figure B-3: Cellular Frequency Band Plan



B.1.4 AWS Frequency Band Plan

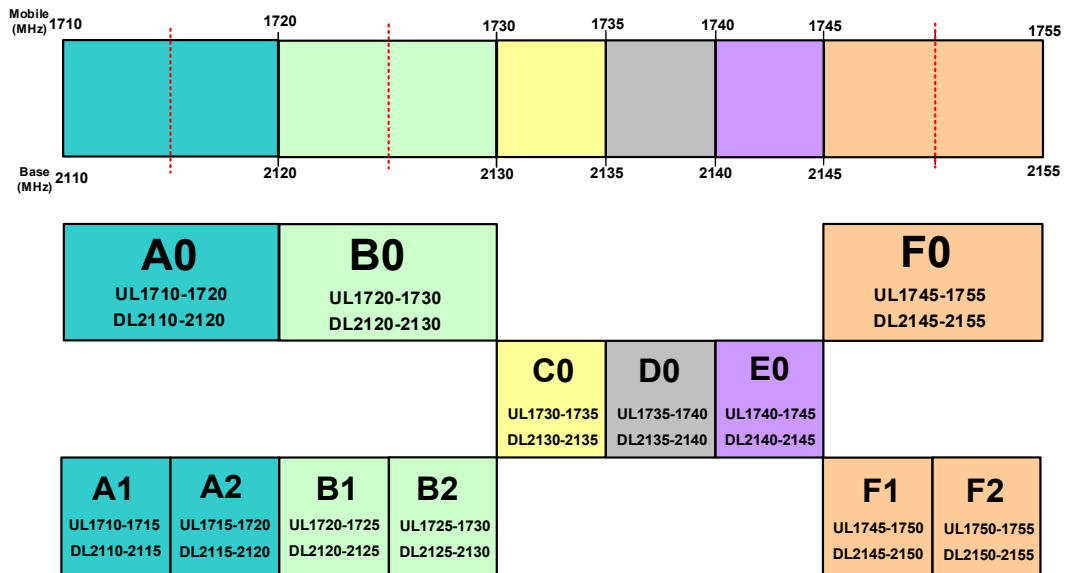

Figure B-4: AWS Frequency Band Plan

B.1.5 Canadian PCS Frequency Band Plan

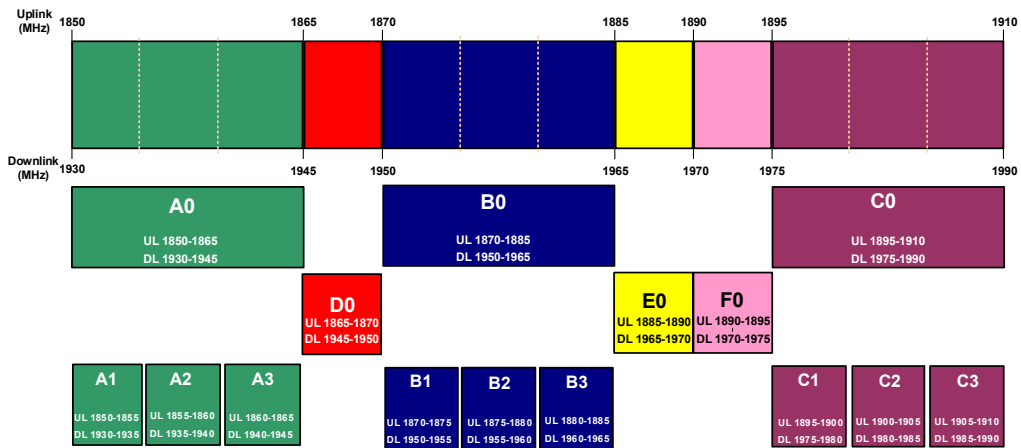

Figure B-5: Canadian PCS Frequency Band Plan



B.1.6 US PCS Frequency Band Plan

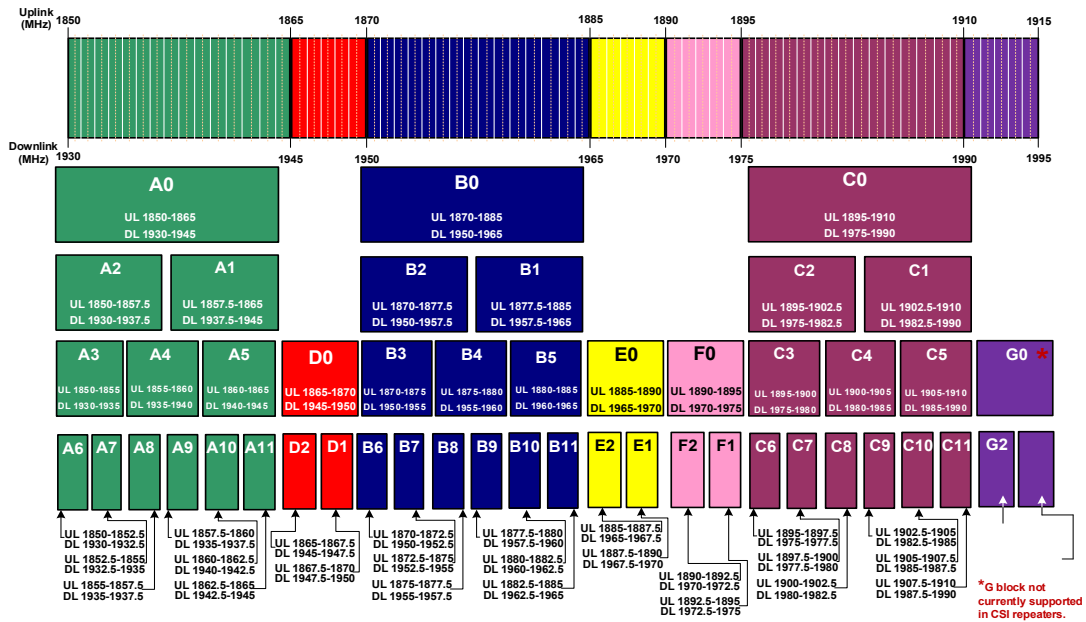

Figure B-6: US PCS Frequency Band Plan

B.1.7 Public Safety Bands

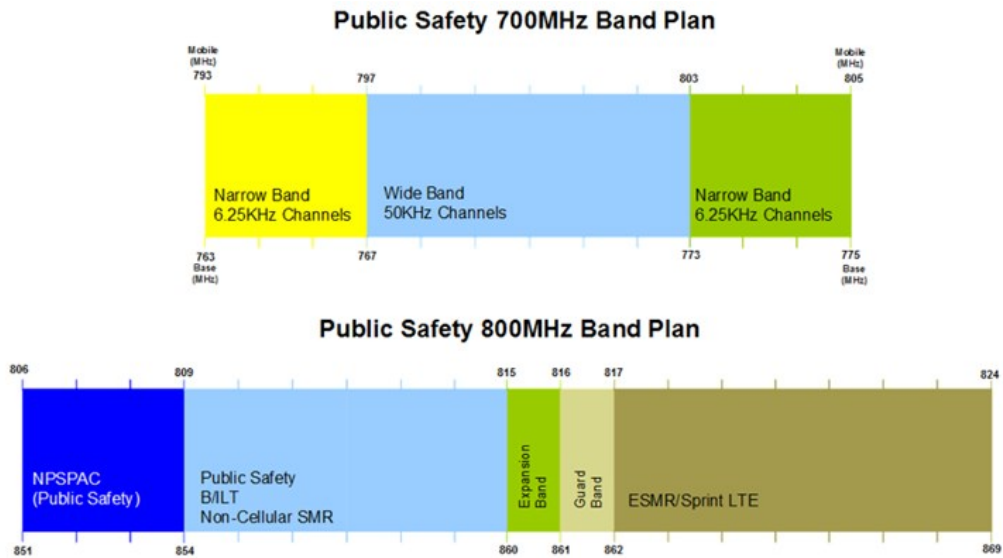

Figure B-7: Public Safety Bands



B.2 Filter File Naming Conventions

B.2.1 700 MHz Filter Naming Convention

Westell Technologies digital repeaters use an alphanumeric file naming convention for its filter files. The descriptions below will allow you to understand the methodology to determine the desired file for your application.

Table B-1: 700 MHz Filter Naming Convention

Column:	1	2	3	4	5	6	7	8	9	10	11	12
Definition:	Band	Mod type	Block 1	Sub-block	Block 2	Sub-block	Block 3	Sub-block	Block 4	Sub -	Separator	Variant
	I= 700MHZ	e= E-UTRA (Upper) I= E-UTRA (Lower)	A - C	0=Full 1- 7=Sub	A - C	0=Full 1-7=Sub	A - C	0=Full 1-7=Sub	A - C	0=Full 1- 7=Sub	-	0=Standard

NOTE

Modulation type determines the guard band at the edges of each passband. The modulation type field will also be used to indicate a carrier who has a unique sub-block designation.

Up to four sub-blocks may be defined, resulting in a maximum filename length.

All variant/guard band designators other than 0 (zero) and F are user-defined custom filters.

700 MHz examples

IIA1B1-0 = (700 MHz band, E-UTRA mod type, Lower A1, B1, with standard guard band). IeC0-0 = (700MHz band, E-UTRA mod type, Upper C, with standard guard band).

IIC1-0 = (700 MHz band, E-UTRA mod type, Lower C1, with standard guard band).

700 MHz upper block

Uplink	Downlink
C0 776-787	746-757

700 MHz upper sub-block

Uplink	Downlink
C1 776.5-786.5	746.5-756.5



B.2.2 Cellular Filter File Naming Convention

Table B-2: Cellular Filter File Naming Convention

Column:	1	2	3	4	5	6	7	8	9	10	11	12
Definition:	Band	Mod type	Block 1	Sub-block 1	Block 2	Sub-block 2	Block 3	Sub-block 3	Block 4	Sub-block 4	Separator	Variant
	c=Cell	g=GSM c=CDMA	A - B	0=Full p=Prime d=Double	A - B	0=Full p=Prime d=Double	A - B	0=Full p=Prime d=Double	A - B	0=Full p=Prime d=Double	-	0=Standard

Cell example

ccAdAp-0 = (Cellular band, CDMA mod type, A" and A' with standard guard band).

Cellular blocks

Uplink	Downlink
A0 825-835	870-880
B0 835-845	880-890

Cellular sub-blocks

Uplink	Downlink
A' 845-846.5	890-891.5
A" 824-825	869-870
B' 846.5-849	891.5-894



B.2.3 Canadian PCS Filter File Naming Convention

Table B-3: Canadian PCS Filter File Naming Convention

Column:	1	2	3	4	5	6	7	8	9	10	11	12
Definition:	Band	Mod type	Block 1	Sub-block 1	Block 2	Sub-block 2	Block 3	Sub-block 3	Block 4	Sub-block 4	Separator	Variant
	p=PCS	u=UMTS See note	A - F	0=Full 1-3=Sub	A - F	0=Full 1-3=Sub	A - F	0=Full 1-3=Sub	A - F	0=Full 1-3=Sub	-	can= Custom Canadian

Canadian PCS example

puE0F0-can = (PCS band, UMTS mod type, E full, F full, Canadian Custom filter).

Canadian PCS blocks

Uplink	Downlink
A0 1850-1865	1930-1945
D0 1865-1870	1945-1950
B0 1870-1885	1950-1965
E0 1885-1890	1965-1970
F0 1890-1895	1970-1975
C0 1895-1910	1975-1990

Canadian PCS sub-blocks

Uplink	Downlink
A1 1850-1855	1930-1935
A2 1855-1860	1935-1940
A3 1860-1865	1940-1945
B1 1870-1875	1950-1955
B2 1875-1880	1955-1960
B3 1880-1885	1960-1965
C1 1895-1900	1975-1980
C2 1900-1905	1980-1985
C3 1905-1910	1985-1990



B.2.4 US PCS Filter File Naming Convention

Table B-4: US PCS Filter File Naming Convention

Column:	1	2	3	4	5	6	7	8	9	10	11	12
Definition:	Band	Mod type	Block 1	Sub-block 1	Block 2	Sub-block 2	Block 3	Sub-block 3	Block 4	Sub-block 4	Separator	Variant
	p=PCS	g=gsm	A - F	0=Full 1-11=Sub	A - F	0=Full 1-11=Sub	A - F	0=Full 1-11=Sub	A - F	0=Full 1-11=Sub	-	0=Standard

US PCS example

pcA1C0E0F2-0 = (PCS band, CDMA mod type, A1, C full, E full, F2 with standard guard band).

US PCS blocks

Uplink	Downlink
A0 1850-1865	1930-1945
D0 1865-1870	1945-1950
B0 1870-1885	1950-1965
E0 1885-1890	1965-1970
F0 1890-1895	1970-1975
C0 1895-1910	1975-1990



US PCS sub-blocks

Uplink	Downlink
A2 1850-1857.5	1930-1937.5
A1 1857.5-1865	1937.5-1945
A3 1850-1855	1930-1935
A4 1855-1860	1935-1940
A5 1860-1865	1940-1945
D2 1865-1867.5	1945-1947.5
D1 1867.5-1870	1947.5-1950
B2 1870-1877.5	1950-1957.5
B1 1877.5-1885	1957.5-1965
B3 1870-1875	1950-1955
B4 1875-1880	1955-1960
B5 1880-1885	1960-1965
E2 1885-1887.5	1965-1967.5
E1 1887.5-1890	1967.5-1970
F2 1890-1892.5	1970-1972.5
F1 1892.5-1895	1972.5-1975
C2 1895-1902.5	1975-1982.5
C1 1902.5-1910	1982.5-1990
C3 1895-1900	1975-1980
C4 1900-1905	1980-1985
C5 1905-1910	1985-1990

NOTE

Modulation type determines the guard band at the edges of each passband. The modulation type field will also be used to indicate a carrier who has a unique sub-block designation.

Up to four sub-blocks may be defined, resulting in a maximum filename length.

All variant/guard band designators other than 0 (zero) and F are user-defined custom filters.



B.2.5 AWS Filter Naming Convention

Column:	1	2	3	4	5	6	7	8	9	10	11	12
Definition:	Band	Mod type	Block 1	Sub-block 1	Block 2	Sub-block 2	Block 3	Sub-block 3	Block 4	Sub-block 4	Separator	Variant
	a=AWS	g=gsm c=CDMA w=WCDMA e=E-UTRA l=LTE	A - F	0=Full 1-2=Sub	A - F	0=Full 1-2=Sub	A - F	0=Full 1-2=Sub	A - F	0=Full 1-2=Sub	-	0=Standard

AWS example

acA1C0E0F2-0 = (AWS band, CDMA mod type, A1, C full, E full, F2 with standard guard band).

AWS blocks

Uplink	Downlink
A0 1710-1720	2110-2120
B0 1720-1730	2120-2130
C0 1730-1735	2130-2135
D0 1735-1740	2135-2140
E0 1740-1745	2140-2145
F0 1745-1755	2145-2155

AWS sub-blocks

Uplink	Downlink
A1 1710-1715	2110-2115
A2 1715-1720	2115-2120
B1 1720-1725	2120-2125
B2 1725-1730	2125-2130
F1 1745-1750	2145-2150
F2 1750-1755	2150-2155

NOTE

Modulation type determines the guard band at the edges of each passband. The modulation type field will also be used to indicate a carrier who has a unique sub-block designation.

Up to four sub-blocks may be defined, resulting in a maximum filename length of 12 characters. All variant/guard band designators other than 0 (zero) are user defined custom filters.



Appendix C LTE Attenuator and Installation Notes

C.1 Important LTE Attenuator and Installation Notes - Donor and Server Isolation

Inadequate isolation between the outside and inside antennas may cause regenerative feedback in the system. Carefully consider the layout and placement of the system. Set repeater gain well below line of sight donor path loss, as shown in C.1.1 Line of Sight Propagation Path Loss Table. Higher gain settings may be possible if the internal building structure and system layout adds additional attenuation and the installer is confident about the values of that attenuation.

C.1.1 Line of Sight Propagation Path Loss Table

Table C-1: Line of Sight Propagation Path Loss Table

Distance between donor and server antenna	Free space path loss	Max gain ²	Max gain with 20 dB attenuation from building structure ²
10 m ¹	50 dB ¹	55 dB ¹	55 dB ¹
40 m ¹	62 dB ¹	55 dB ¹	67 dB ¹
60 m ¹	65.5 dB ¹	55 dB ¹	70.5 dB ¹
100 m	70 dB	55 dB	75 dB
120 m	71.5 dB	56.5 dB	76.5 dB
143 m	73 dB	58 dB	78 dB
160 m	74 dB	59 dB	79 dB
180 m	75 dB	60 dB	80 dB
200 m	76 dB	61 dB	81 dB
239 m	77.5 dB	62.5 dB	82.5 dB
268 m	78.5 dB	63.5 dB	83.5 dB
284 m	79 dB	64 dB	84 dB
300 m	79.5 dB	64.5 dB	84.5 dB
318 m	80 dB	65 dB	85 dB

NOTE¹

Antenna separation under 100 meters requires additional attenuation greater than 20 dB.

NOTE²

Maximum gain assumes no loss or gain in donor seen, coax distribution, or active DAS.



Appendix D Mechanical and Electrical Specifications

D.1 Digital Repeater Mechanical and Electrical Specifications

D.1.1 Mechanical Specifications

Table D-1: Mechanical Specifications

Parameters	Single Band	Dual Band
Repeater Dimensions		
DSP85/DSP85-201	18.5 x 10 x 4.7 in (approx.)	19.25 x 18.6 x 4.7 in (approx.)
DSP85N	20 x 16 x 6 in (approx.)	-
DSP85-250 and 251	19 x 18 x 3.5 in (2U) (approx.)	19 x 18 x 3.5 in (2U) (approx.)
DSP95-255	18.63 x 19.25 x 5.25 in (3U) (approx.)	18.63 x 19.25 x 5.25 in (3U) (approx.)
Weight/Shipping Weight		
DSP85/DSP85-201	23 lbs / 28 lbs (approx.)	42 lbs / 50 lbs (approx.)
DSP85N	23 lbs / 28 lbs (approx.)	-
DSP85-250 and 251	17 lbs / 27 lbs (approx.)	21 lbs / 31 lbs (approx.)
DSP95-255	24 lbs / 28 lbs (approx.)	34 lbs / 38 lbs (approx.)
Connectors	N-female or 4.3-10	N-female or 4.3-10
Thermal management	Convection cooled	Convection cooled
Surface coating	Powder coat	Powder coat
Color	Satin black	Satin black

D.1.2 Electrical Specifications

Table D-2: Electrical Specifications

Parameters	Single Band	Dual Band
Passband Options	1 MHZ – full band	1 MHZ – full band
Linear output power (typical)		
½ Watt	27dBm	27dBm
1 Watt	30dBm	30dBm
5 Watts	37dBm	37dBm
Noise figure @ max. gain	5.0 dB	5.0 dB
Propagation Delay	<2.5 microseconds	<2.5 microseconds
Gain Adjustment Range	30dB, 0.5 dB steps	30dB, 0.5 dB steps
VSWR	<1.5:1	<1.5:1
Spurious emissions	<-13dBm	<-13dBm
Input/output impedance	50 ohms	50 ohms

D.1.3 Power Requirements

Table D-3: Power Requirements

Parameters	Single Band	Dual Band
½ Watt	0.9 Amps @ 120 VAC / 0.5 Amps @	1.5 Amps @ 120 VAC / 0.8 Amps @
1 Watt	0.7 Amps @ 120 VAC / 0.6 Amps @ 230 VAC	1.7 Amps @ 120 VAC / 0.9 Amps @ 230 VAC
5 Watt	1.2 Amps @ 120 VAC / 0.7 Amps @ 230 VAC	2.0 Amps @ 120 VAC / 1.1 Amps @ 230 VAC

D.1.4 Environmental Requirements

Table D-4: Environmental Requirements

Parameters	Single Band	Dual Band
Operating Temperature	10°C to 50° C (50° F to 122° F)	10°C to 50° C (50° F to 122° F)



D.1.5 Operating Power Parameters

Table D-5: Operating Power Parameters

Parameters	Specifications	Notes
Maximum RF input power without damage	10 dBm	
Linear gain	85 dB	Factory calibrated gain
Pass band ripple	±1.5 dB	
Automatic gain control (AGC)	30 dB max range	In 0.5 dB steps
Manual gain control	53.5 dB to 85 dB	In 0.5 dB steps
OIP3	41 dBm	Measured with two CW tones at 14 dBm/ tone
RMS vector error (EVM)	3% max	TDMA, EDGE, W-CDMA, CDMA2000
CDMA RHO	0.98 min	CDMA2000, 1x-EVD0

Appendix E Port Configurations

E.1 Digital Repeater Port Configurations, Original Series

E.1.1 Dual-band D2:D1 Port Configuration

Input: Two single-band duplex ports, one from the low-band donor antenna and one from the high-band donor antenna.

Output: One dual-band duplex port to the server antennas.

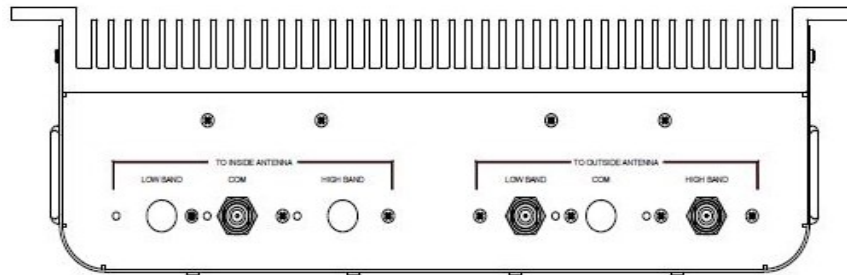

Figure E-1: Dual-band D2:D1 Port Configuration

E.1.2 Dual-band D1:D2 Port Configuration

Input: One dual-band duplex port from dual-band donor antenna.

Output: Two single-band duplex ports, one to the low-band server antennas and one to the high-band server antennas.

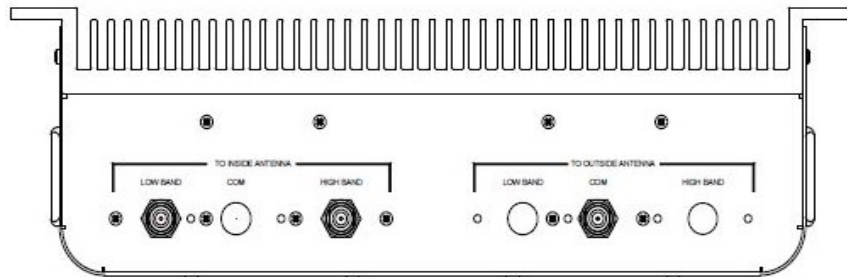

Figure E-2: Dual-band D1:D2 Port Configuration



E.1.3 Dual-band D2: D2 Port Configuration

Input: Two single-band duplex ports, one from the low-band donor antenna and one from the high-band donor antenna.

Output: Two single-band duplex ports, one to the low-band server antennas and one to the high-band server antennas.

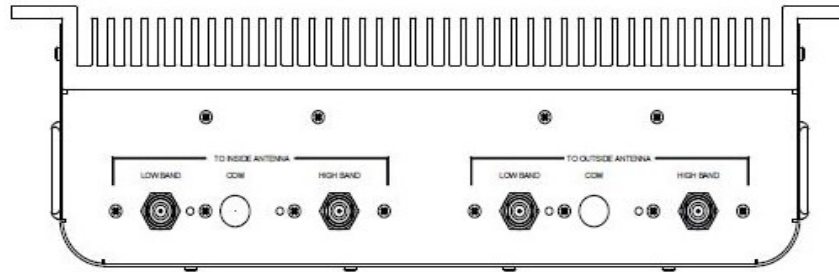

Figure E-3: Dual-band D2: D2 Port Configuration

E.1.4 Dual-band D1:D1 Port Configuration

Input: One dual-band duplex port from dual-band donor antenna.

Output: One dual-band duplex port to dual-band server antennas.

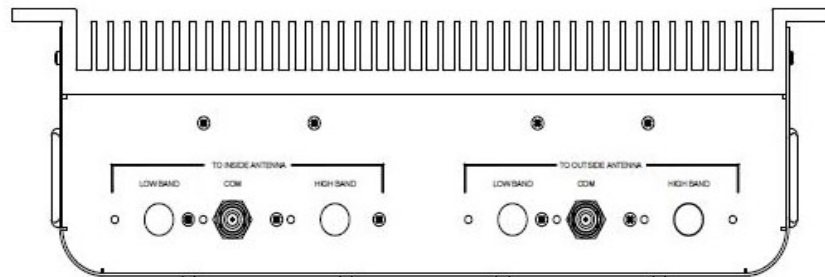

Figure E-4: Dual-band D1:D1 Port Configuration

E.1.5 Single-band D1:D1 Port Configuration

Input: One single-band duplex port from donor antenna.

Output: One single-band duplex port to server antennas.

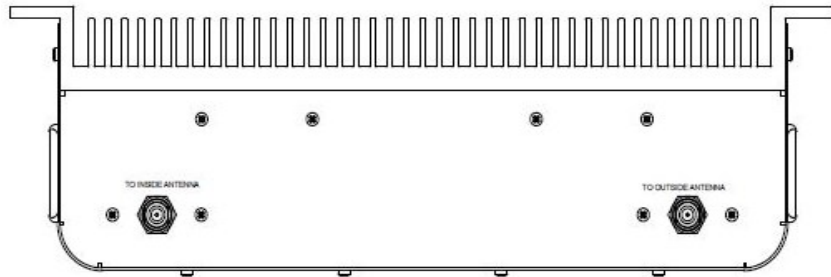

Figure E-5: Single-band D1:D1 Port Configuration

E.1.6 Dual-band D2:S4 Port Configuration

Input: Two single-band duplex ports from the donor antenna, one from the high-band, one from the low-band.

Output: Four single-band simplex ports, two uplink, two downlink, one uplink and one downlink for each band.

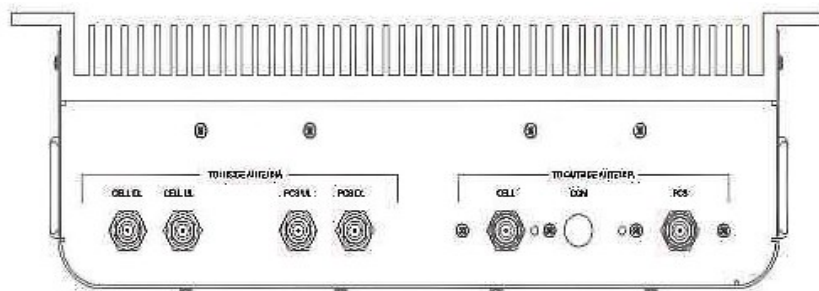

Figure E-6: Dual-band D2:S4 Port Configuration

E.1.7 Dual-band D1:S4 Port Configuration

Input: One dual-band duplex port from dual-band donor antenna.

Output: Four single-band simplex ports, two uplink, two downlink, one uplink and one downlink for each band.

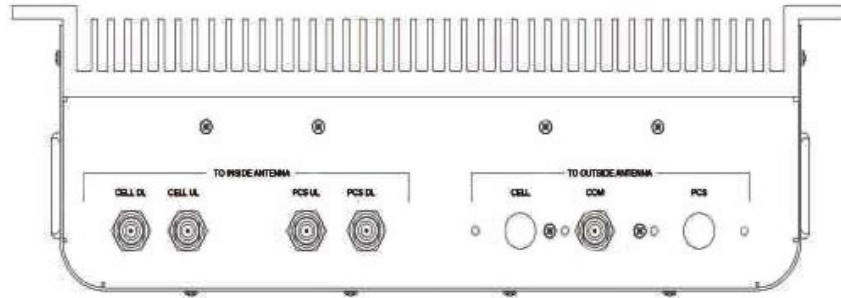

Figure E-7: Dual-band D1:S4 Port Configuration

E.1.8 Single-band D1:S2 Port Configuration

Input: One single-band duplex port from donor antenna.

Output: Two single-band simplex ports, one for uplink and one for downlink.

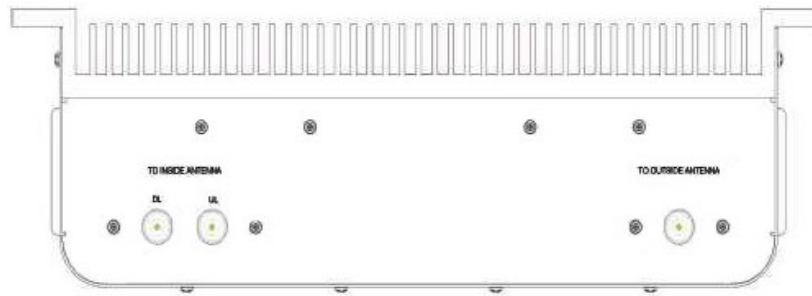

Figure E-8: Single-band D1:S2 Port Configuration

E.2 Digital Repeater Port Configurations

E.2.1 Dual-band D2:D1 Port Configuration

Input: Two single-band duplex ports, one from the low-band donor antenna and one from the high-band donor antenna.

Output: One dual-band duplex port to the server antennas.



Figure E-9: Dual-band D2:D1 Port Configuration

E.2.2 Dual-band D1:D2 Port Configuration

Input: One dual-band duplex port from dual-band donor antenna.

Output: Two single-band duplex ports, one to the low-band server antennas and one to the high-band server antennas.



Figure E-10: Dual-band D1:D2 Port Configuration

E.2.3 Dual-band D2:D2 Port Configuration

Input: Two single-band duplex ports, one from the low-band donor antenna and one from the high-band donor antenna.

Output: Two single-band duplex ports, one to the low-band server antennas and one to the high-band server antennas.



Figure E-11: Dual-band D2:D2 Port Configuration

E.2.4 Dual-band D1:D1 Port Configuration

Input: One dual-band duplex port from dual-band donor antenna.

Output: One dual-band duplex port to dual-band server antennas.



Figure E-12: Dual-band D1:D1 Port Configuration

E.2.5 MIMO Port Configuration

Input: Two single-band duplex ports, one from the first band donor antenna and one from the second band donor antenna.

Output: Two single-band simplex ports, one for uplink and one for downlink.



Figure E-13: MIMO Port Configuration

E.2.6 Single-band D1:D1 Port Configuration

Input: One single-band duplex port from donor antenna.

Output: One single-band duplex port to server antennas.



Figure E-14: Single-band D1:D1 Port Configuration

E.2.7 Dual-band D2:S4 Port Configuration

Input: Two single-band duplex ports from the donor antenna, one from the high-band, one from the low-band.

Output: Four dingle-band simplex ports, two uplink, two downlink, one uplink and one downlink for each band.

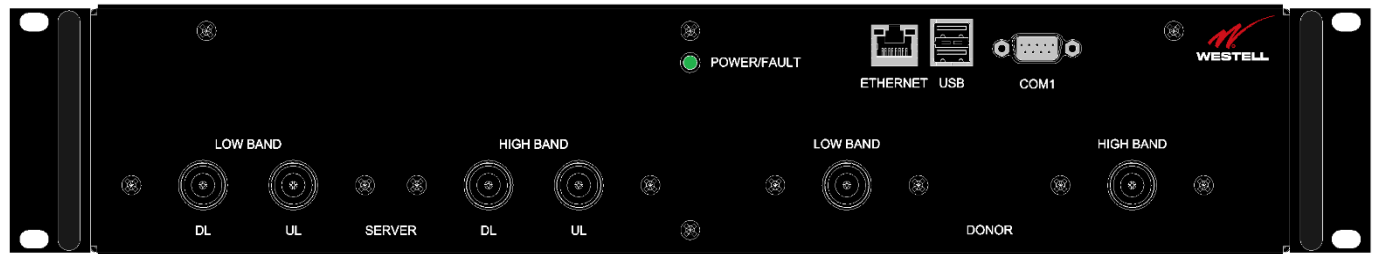

Figure E-15: Dual-band D2:S4 Port Configuration

E.2.8 Dual-band D1:S4 Port Configuration

Input: One dual-band duplex port from dual-band donor antenna.

Output: Four single-band simplex ports, two uplink, two downlink, one uplink and one downlink for each band.



Figure E-16: Dual-band D1:S4 Port Configuration

E.2.9 Single-band D1:S2 Port Configuration

Input: One single-band duplex port from donor antenna.

Output: Two single-band simplex ports, one for uplink and one for downlink.



Figure E-17: Single-band D1:S2 Port Configuration

Appendix F Mechanical Configurations

F.1 DSP85-250 and DSP85-251 Series Mechanical Drawing

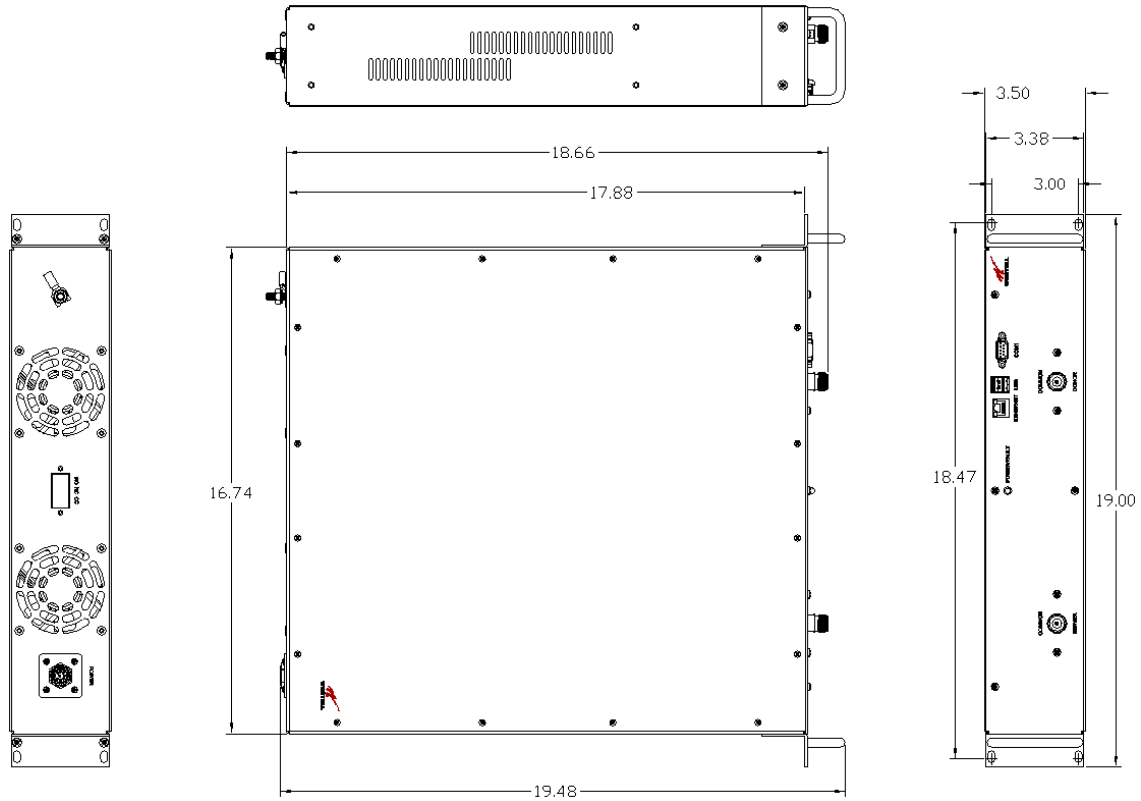

Figure F-1: DSP85-250 and DSP85-251 Series Mechanical Drawing

F.2 DSP85-250 and DSP85-251 Series Mounting

The following diagrams illustrate the methods for mounting the repeater(s) in a typical wall or rack installation. Brackets are provided for both options.

Rack mounting a repeater requires two brackets mounted to the front corners of each module, Figure F-2.

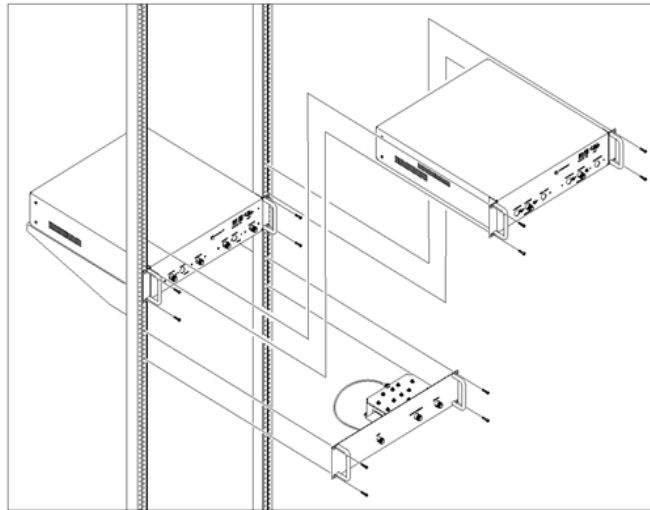

Figure F-2: Rack Mounting

Wall mounting uses four brackets, one at each corner.

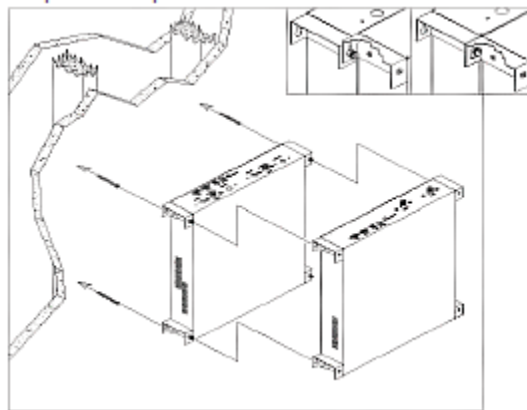

Figure F-3: Wall Mounting

NOTE

Westell digital repeaters must be supported in the rack system with a shelf or slide rail. **Do not rely on the brackets exclusively to support all the weight of the modules.**

Mount the cross band coupler on the wall close enough to the repeater modules to allow the RF jumpers to reach from the CBC to the repeaters. The attachment system used to anchor the CBC to the wall must be able to support at least 8.4 lbs (3.8 kg).

Use a wall anchoring system for the repeaters that can support at least 42.lbs (19.05 kg) for each dual band module and 23 lbs (10.43 kg) for each single band add on module. The power supplies are mounted approximately as shown.

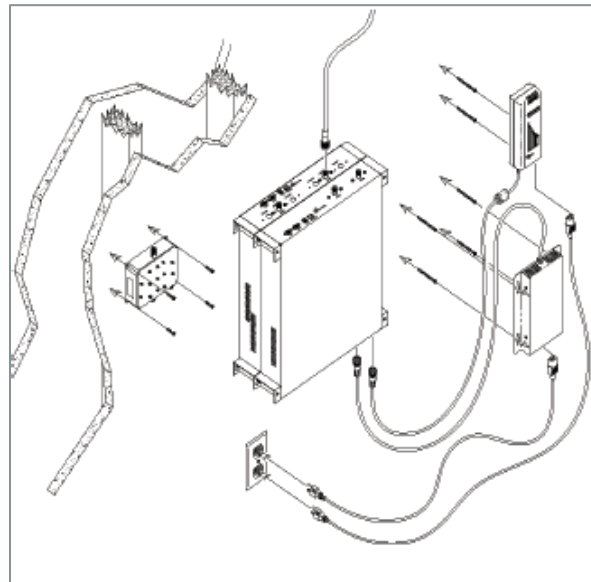

Figure F-4: System Interconnect

Interconnection of the repeaters in the rack or wall mount configuration requires the short RF jumpers supplied with the CBC Module. The actual interconnections will depend on the bands and cross band coupler module being used.

Contact Westell's technical support line at 1.877.844.4274 should you have questions about your specific application.

Appendix G Acronyms and Abbreviations

Table G-1 is a list of acronyms and abbreviations used in this manual.

Table G-1: Acronyms and Abbreviations

Acronym/Abbreviation	Definition
AGC	Automatic Gain Control
APC	Automatic Power Control
AUI	Attachment Unit Interface
CPU	Central Processing Unit
DAS	Distributed Antenna System
DHCP	Dynamic Host Configuration Protocol
DSP	Digital Signal Processing
EEPROM	Electrically Erasable Programmable Read-Only Memory
ERP	Effective Radiated Power
FCS	Feedback
FPGA	Field Programmable Gate Array
LED	Light Emitting Diode
OIP3	Third-order Intercept Point
RF	Radio Frequency
SBC	Single Board Computer
SNMP	Simple Network Management Protocol
TMI	Text Menu Interface
UHCI	Universal Host Controller Interface
USB	Universal Serial Bus

