



My Passport® Wireless

Portable Hard Drive

User Manual



WD Service and Support

Should you encounter any problem, please give us an opportunity to address it before returning this product. Most technical support questions can be answered through our knowledge base or email support service at <http://support.wd.com>. If the answer is not available or if you prefer, please contact WD at the best telephone number shown below.

Your product includes 30 days of free telephone support during the warranty period. This 30-day period starts on the date of your first telephone contact with WD Technical Support. Email support is free for the entire warranty period and our extensive knowledge base is available 24/7. To help us keep you informed of new features and services, remember to register your product online at <http://register.wd.com>.

Accessing Online Support

Visit our product support website at <http://support.wd.com> and choose from these topics:

- **Downloads**—Download drivers, software, and updates for your WD product.
- **Registration**—Register your WD product to get the latest updates and special offers.
- **Warranty & RMA Services**—Get warranty, product replacement (RMA), RMA status, and data recovery information.
- **Knowledge Base**—Search by keyword, phrase, or answer ID.
- **Installation**—Get online installation help for your WD product or software.
- **WD Community**—Share your thoughts and connect with other WD users.
- **Online Learning Center** — Start here to get the most out of your WD product. (<http://www.wd.com/setup>).

Contacting WD Technical Support

When contacting WD for support have your WD product serial number, system hardware, and system software versions available.

North America		Europe (toll free)*	00800 ASK4 WDEU (00800 27549338)
English	800.ASK.4WDC (800.275.4932)	Europe	+31 880062100
Spanish	800.832.4778	Middle East	+31 880062100
		Africa	+31 880062100
Mexico	001 8002754932	Russia	8 10 8002 335 5011
South America		Asia Pacific	
Chile	1230 020 5871	Australia	1800 429 861 / 0011 800 2275 4932
Colombia	009 800 83247788	China	800 820 6682 / 400 627 6682
Venezuela	0800 100 2855	Hong Kong	3057 9031
Peru	0800 54003	India	1800 200 5789 / 1800 419 5591
Uruguay	000 413 598 3787	Indonesia	001 803 852 3993
Argentina	0800 4440839	Japan	0800 805 7293
Brazil	0800 7704932 0021 800 83247788	Korea	02 2120 3415
		Malaysia	1800 817 477
		New Zealand	0508 555 639 / 00800 2275 4932
		Philippines	1800 1855 0277
		Singapore	1800 608 6008
		Taiwan	0800 225 593
		Thailand	00 1800 852 5913
		Other countries	+86 21 2603 7560

* Toll free number available in the following countries: Austria, Belgium, Czech Republic, Denmark, France, Germany, Ireland, Italy, Netherlands, Norway, Poland, Slovakia, Spain, Sweden, Switzerland, United Kingdom.

Registering Your WD Product

Register your WD product to get the latest updates and special offers. You can easily register your drive online at <http://register.wd.com>.

Table of Contents

WD Service and Support	ii
Registering Your WD Product	ii

1 About Your WD Storage Device. 1

Features.	1
Handling Precautions.	2
Kit Contents.	2
Optional Accessories	2
About the Online Learning Center	3
Compatibility	3
Physical Description.	4

2 Understanding the LEDs and Buttons. 5

Power and Battery Status LED.	5
Wi-Fi LED.	6
Other LED Behavior	6
Buttons	6

3 Setting up the Wireless Drive. 7

Turning the Drive On	7
Setting up the Drive the First Time	7

4 Using the Dashboard 15

Accessing the Dashboard	15
Dashboard Home Page	15
Icons	16
Viewing Drive Status	17

5	Connecting the Drive	18
	Ways to Connect the Drive	18
	Making a Direct Connection	21
	Connecting to a Public Wi-Fi Network/Internet	23
	Connecting to Your Home Wi-Fi Network	25
	Viewing or Changing the Drive's Advanced Wi-Fi Settings	27
	Removing a Connection	29
6	Loading Content on Your Drive	30
	Loading Content	30
	Using a Compatible Wireless Camera	32
	Backing up a Computer to the Drive	33
7	Using an SD Card with the Drive	36
	Moving or Copying Content from an SD Card	36
	Viewing Content Imported from an SD Card	37
	Viewing Content on an SD Card	38
8	Playing/Streaming Videos, Photos, & Music	39
	Using the Drive as a Media Server	39
	Enabling Media Streaming	39
	Accessing Your Content Using Media Players	40
	Using the Drive with a DLNA-Enabled Mobile App	41
9	Using the Battery	42
	Improving Battery Life or Performance	42
	Charging the Battery	43
	Viewing Battery Status When Drive is Off	43

10	Performing Administrative Functions	44
	Changing the Password and Device Name	44
	Changing the Language	45
	Specifying Types of Access	45
	Locking the Drive	46
	Rebooting and Shutting Down	46
11	Resetting Your Drive and Password	47
	Manually Resetting the Drive	47
	Restoring Factory Settings Using the Dashboard	47
12	Updating Firmware	49
	Updating with Available Firmware	49
	Performing a Manual Update	50
13	Using WD Quick View with the Drive	51
	Installing WD Quick View	51
	Accessing WD Quick View Shortcut Options	53
14	Getting Support	54
	Support Page	54
15	Problems and Solutions	56
	Appendix A. Technical Specifications	59
	Appendix B: Compatible Media Formats	61
	DLNA File Formats	61
	Formats Compatible with WD My Cloud App	61
	Appendix C. Compliance and Warranty Information	62
	Regulatory Compliance	62
	Battery Safety	65
	Warranty Information	66
	GNU General Public License (“GPL”)	67

1

About Your WD Storage Device

This chapter includes the following topics:

- Features
- Handling Precautions
- Kit Contents
- Optional Accessories
- About the Online Learning Center
- Compatibility
- Physical Description

Welcome to your My Passport Wireless Wi-Fi mobile storage. Now you have the freedom to save, access and share your content using tablets, smartphones, and computers instantly and without the need of an Internet connection. Plus, transfer or back up photos and videos from your SD card on the go for instant access and sharing. My Passport Wireless is the one drive for all your devices.

Features

You're more attached with no attachments – Free of wires and the Internet, My Passport Wireless lets you save, access and share files, and an Internet connection, with multiple devices at the same time.

Built-in SD card slot – Transfer or back up photos and videos from your SD card in the field so that you can keep on shooting. Plus, with your creative magic stored on your My Passport Wireless, you can instantly share your creations using any device connected to the drive.

Rechargeable battery to keep you going – Stay mobile with the long-lasting, built-in, rechargeable battery. Get up to 6 hours of continuous video streaming and up to 20 hours of standby time.

Save, share, access with your mobile devices – Interact with your media files using your tablet and smartphone with WD's My Cloud mobile app. Share and access your files securely from anywhere, on any iOS or Android device.

Keep your private stuff private – Feel secure from unauthorized access with Wi-Fi password protection for every photo, video, music and important file you save. Plus, protect your drive from USB access using DAS mode lock in the device dashboard.

You're in control – Configure, manage and diagnose your drive using the intuitive dashboard. Run drive diagnostics, erase and format your drive, register your drive and more.

Ultra-fast USB 3.0 – Use the USB 3.0 port to quickly transfer large amounts of data to the drive.

WD Reliability – WD knows your data is important, so we build our drives to demanding requirements for durability, shock tolerance and long-term reliability. And for peace-of-mind, we back up our reliability with a 2-year limited warranty.

Important: For the latest WD product information and news, visit our website at <http://www.westerndigital.com>. For the latest software, firmware, and product documentation and information, go to <http://support.wd.com/downloads>.

Handling Precautions

WD products are precision instruments and must be handled with care during unpacking and installation. Rough handling, shock, or vibration can damage drives. Always observe the following precautions when unpacking and installing your external storage product:

- Do not drop or jolt the drive.
- Do not move the drive during activity.
- Do not place the drive on carpeting. Make sure the drive is on a clean, firm, and stable surface.

Kit Contents

Your My Passport Wireless storage drive kit includes:

- My Passport Wireless storage drive
- USB 3.0 cable
- USB AC Power Adapter
- Quick Install Guide

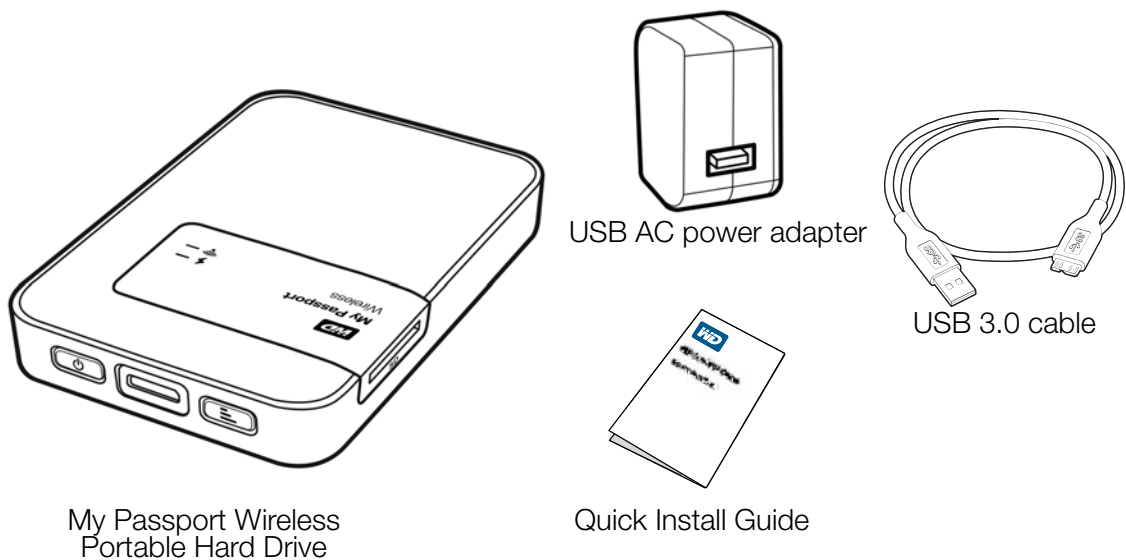

Optional Accessories

For information about optional accessories for this product, visit:

US	http://www.shopwd.com or http://www.wdstore.com
Canada	http://www.shopwd.ca or http://www.wdstore.ca
Europe	http://www.shopwd.eu or http://www.wdstore.eu
All others	Contact WD Technical Support in your region. For a list of Technical Support contacts, visit http://support.wd.com and see Knowledge Base Answer ID 1048.

About the Online Learning Center

WD's online Learning Center provides the latest information, instructions, and software to help users get the most out of their personal cloud storage. This web-based guide is an interactive resource to walk users through installing and using their My Passport Wireless drive. The online Learning Center allows you to:

- Learn about your new product.
- Download the latest software for your product.
- Find in-depth, interactive information on how to explore each of your product's features.
- Access an always-available resource online, without a manual or CD.

Compatibility

Operating Systems

Windows®

- Windows 8.1 or earlier
- Windows 7
- Windows Vista®

Mac OS X®

- Mavericks (Mac OS 10.9)
- Mountain Lion (Mac OS 10.8)
- Lion (Mac OS 10.7)
- Snow Leopard (Mac OS 10.6)

Note: Compatibility may vary depending on your computer's hardware configuration and operating system.

For highest performance and reliability, always install the latest software update.

Web Browsers

- Internet Explorer 8.0 and later on supported Windows computers
- Safari 6.0 and later on supported Mac computers
- Firefox 21 and later on supported Windows and Mac computers
- Google Chrome 27 and later on supported Windows and Mac computers

Physical Description

The drive has two LEDs: Power/Battery Status and Wi-Fi.

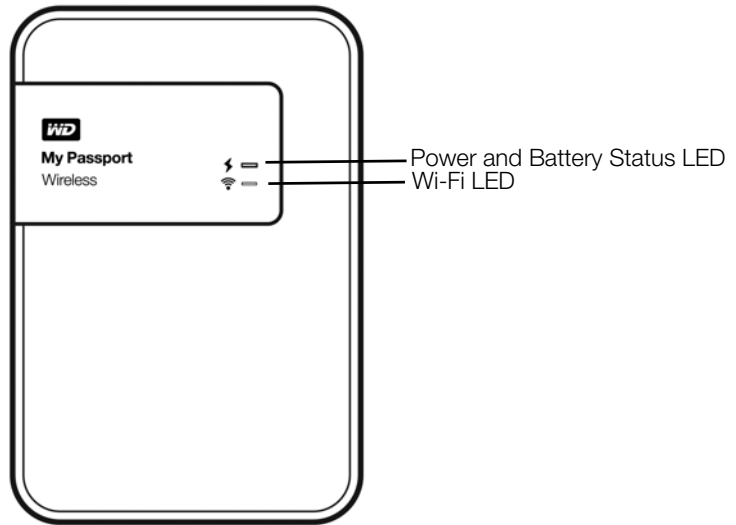

The drive has two buttons, Power and WPS, and a USB 3.0 port.

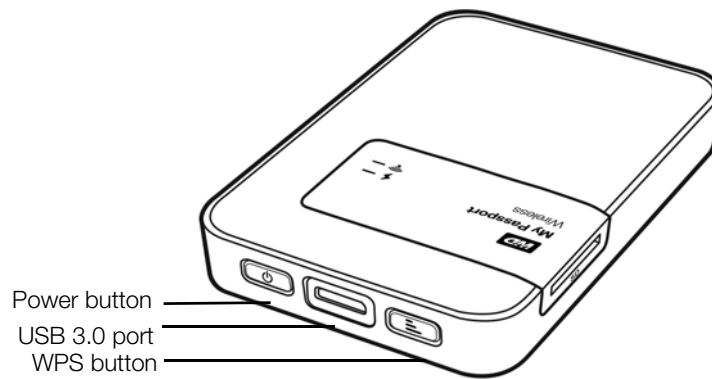

The drive contains a slot for an SD (secure digital) card.

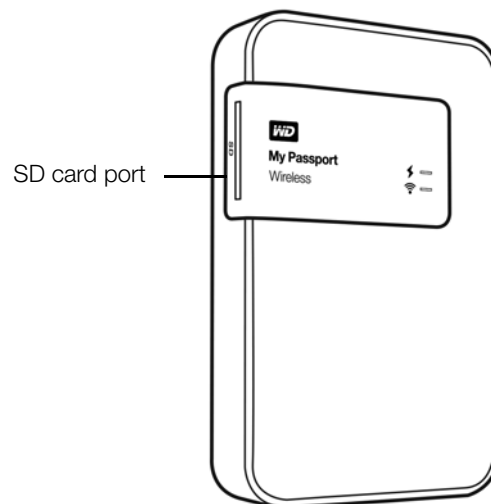

2

Understanding the LEDs and Buttons

This chapter includes the following topics:

- [Power and Battery Status LED](#)
- [Wi-Fi LED](#)
- [Other LED Behavior](#)
- [Buttons](#)

Power and Battery Status LED

The drive is pre-charged at the factory. However, the battery level may be lower when you take it out of the box as it may have been in transit or on the shelf for a significant length of time.

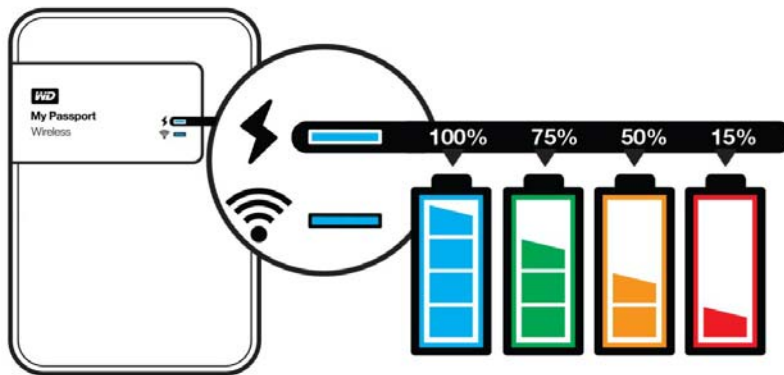

The following table describes the Power and Battery Status LED behavior.

Power/Battery Status LED Behavior/Color	Indicates...
Blue	90% or above
Green	50-89%
Orange	20-49%
Red	8-19%
Blinking white	Boot-up or USB mode activity SD card transfer activity
Pulsing white	USB mode standby
Pulses in the color of the correlating charge state (for example, pulses orange when charging between 20 and 49%).	Battery charging

Wi-Fi LED



The Wi-Fi LED is off when you take the My Passport Wireless drive out of the box.

Wi-Fi LED Behavior/Color	Indicates ...
Off	Wi-Fi not active
Solid blue	Wireless network connected or active (all modes)
Solid orange	Wireless network connected to access point (AP) but no Internet connection (shared connection mode)
Solid red	Wireless network failed or no network connection (all modes)
Blinks blue for a set period (1 minute)	WPS initiated and in progress
Blinks white	Device in use, for example: <ul style="list-style-type: none"> Firmware update Reset

Other LED Behavior

LED Behavior	Indicates
Blinking red with Power and Battery Status and Wi-Fi LEDs alternating	Drive has a problem. Contact WD Support.
Blinking red in one long (3 sec) and 3 short blinks.	Device in recovery mode
Wi-Fi LED off and Power/Battery Status LED blinking white	Device shutting down

Buttons

Power button		<p>Turns the drive on and off and wakes the drive from standby mode:</p> <ul style="list-style-type: none"> To turn on from standby, momentarily push until lights start blinking To turn off, push for about 3 seconds.
WPS button		<ul style="list-style-type: none"> Connects to a router using WPS. Press and hold about 5 seconds to start WPS. When the drive is off, press to show battery status briefly. Press momentarily for other devices to connect to the My Passport Wireless network in Home mode. With SD card inserted in the slot, press momentarily to start SD card transfer.

3

Setting up the Wireless Drive

This chapter includes the following topics:

- Turning the Drive On
- Setting up the Drive the First Time

Turning the Drive On

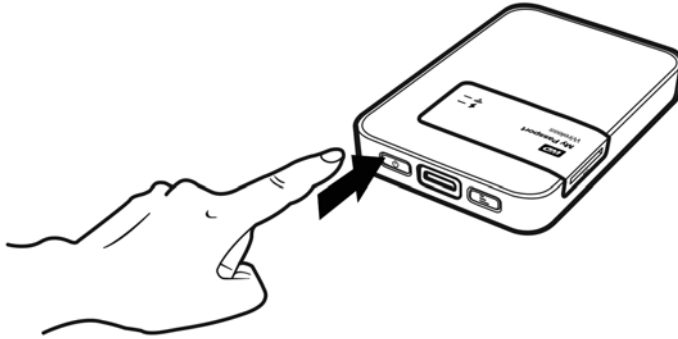

Important: It is best to charge the battery before using the My Passport Wireless drive the first time as the factory charge may have decreased during shipping. (See “Charging the Battery” on page 43.)

- To turn the drive on whether connected to AC power or not, push the power button until the Power and Battery Status LED blinks. When the Wi-Fi LED is solid blue, the drive is ready to connect.

Note: To turn the drive off, hold the power button for about three seconds until the Power and Battery Status LED goes off.

Setting up the Drive the First Time

To connect and set up the drive for wireless use, do one of the following:

- Use a computer and a web browser.
- Download and use the WD My Cloud app on your smartphone or tablet.

Using a Computer and Web Browser

Note: The computer must be wireless enabled.



1. Make sure the My Passport Wireless drive is turned on and both LEDs are lit.
2. Do one of the following:
 - On your Windows computer, open the list of available networks.

Windows 7



Windows 8

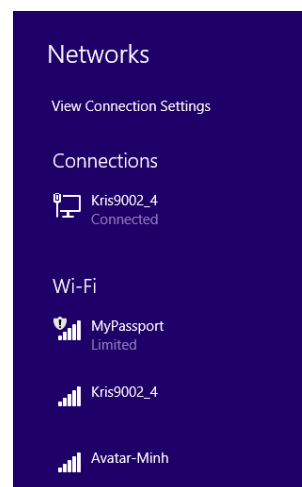

- On a Mac computer, click **System Preferences > Network > Wi-Fi**.



3. Select **MyPassport**.

4. Open a browser and type one of the following:

Note: For a list of compatible browsers, see “Compatibility” on page 3.

- Windows computer: **http://mypassport**
- Mac computer: **http://mypassport.local**
- Windows or Mac computer: **http://192.168.60.1** (the drive’s default IP address)

5. Read the agreement and click **I accept**:

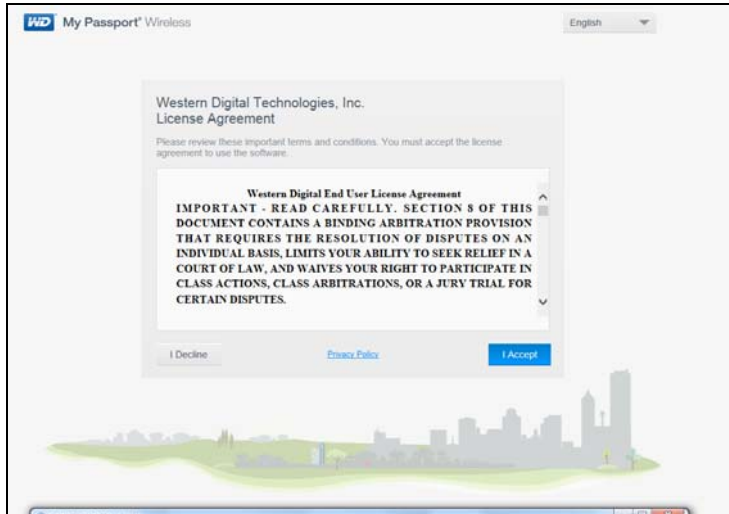

The Secure My Passport Wireless screen displays:

Record network information

Wi-Fi Name:

Password:

Important: If you enter a new name, you will have to select the new name on the list of available networks the next time you use the drive. **Be sure to record the new Wi-Fi name and password.**

6. (Optional) The drive’s default Wi-Fi name is MyPassport. To add security and to differentiate the drive from similar drives, enter a new name.

Note: The default name MyPassport is used in the examples in this User Guide.

You have the following options:

- To go to the next screen without entering credentials, click the **Skip** check box. The My Passport Wireless dashboard appears. (See “Dashboard Home Page” on page 15.)
- To secure the drive with a password, enter and confirm a password of at least 8 characters. The password is case sensitive and may not contain double quotes.

Note: To display the password, click the **Show Password** check box.

7. Click **Next**.
8. If you changed the name of the drive or your password, the drive reboots and the Reconnect to Network screen displays:



Follow the on-screen steps. If you changed drive name, in step 2, select the new name instead of MyPassport from the Wi-Fi list.

9. When the My Passport Wireless dashboard displays, you are ready to use your wireless drive.

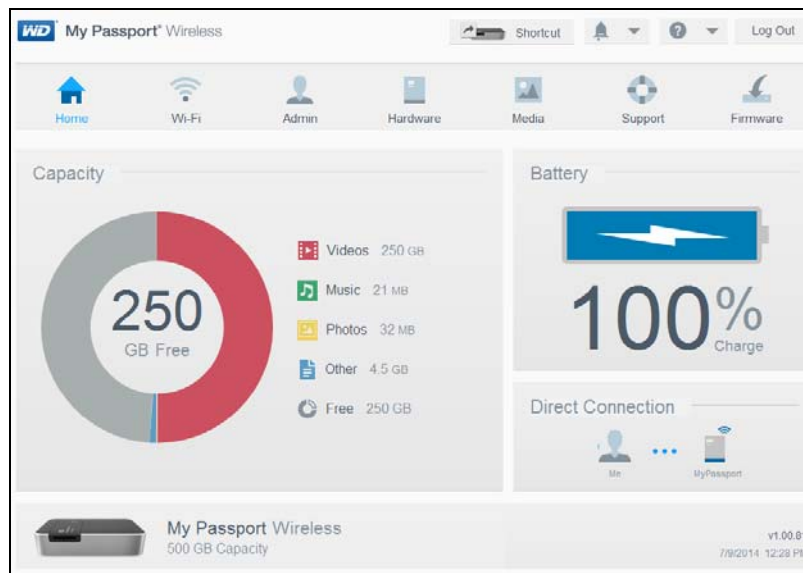

About the Dashboard

The dashboard is where you can see the status of your drive and customize it as you want. For more information about the dashboard, see “Using the Dashboard” on page 15.

Using WD My Cloud App on a Mobile Device

1. On your mobile device, go to **Settings** and connect to the My Passport Wireless **using the new name of your drive and/or your new password.**
2. Download the WD My Cloud app to your mobile device from the App Store, Android App for Google Play store, or Amazon Apps (for Android).
3. Tap the **My Cloud** icon to display the My Passport Wireless Western Digital Technologies, Inc. License Agreement.

Note: In this chapter, the images on the left show an iOS device and the ones on the right show an Android device.

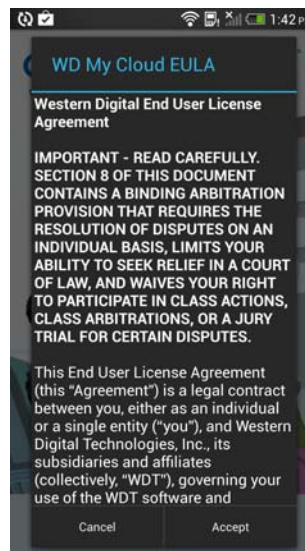
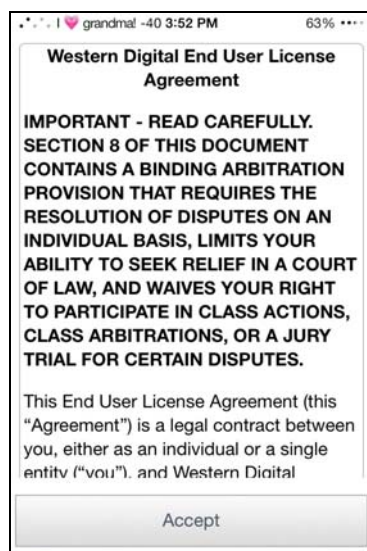

4. Read the agreement and tap **Accept** to display the WD My Cloud Welcome screen.

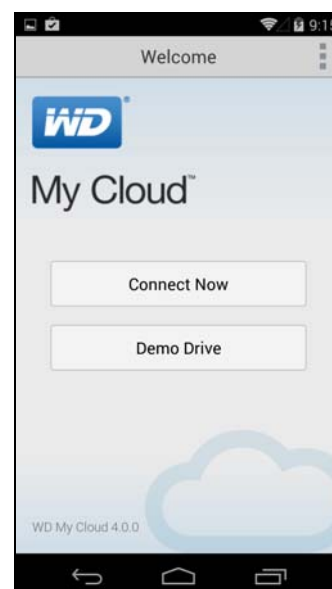
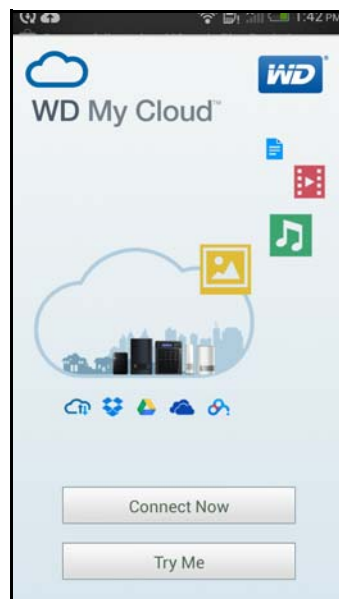

5. Tap **Connect Now** to display a list of available WD network devices:

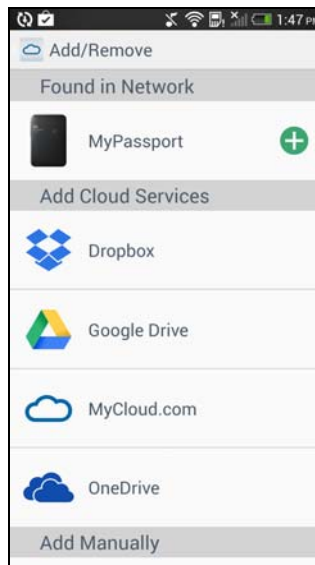
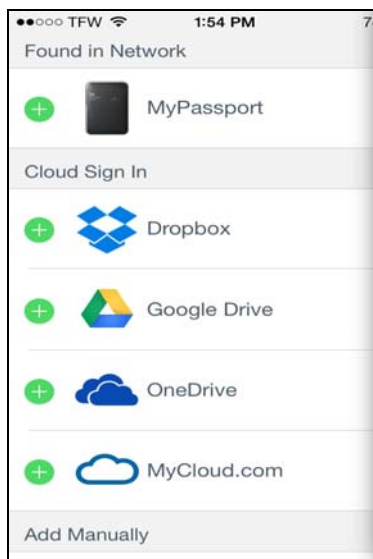

6. Tap **MyPassport** and then tap **Next** to display the Secure Your Device screen:

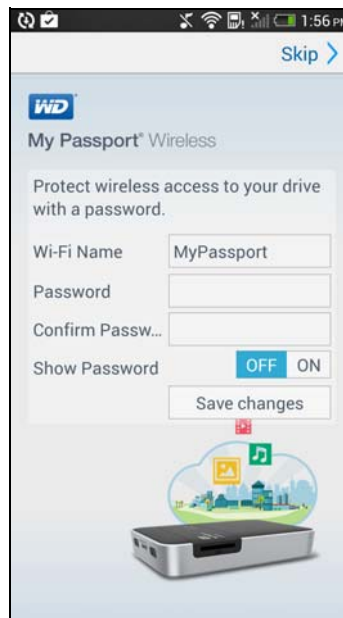
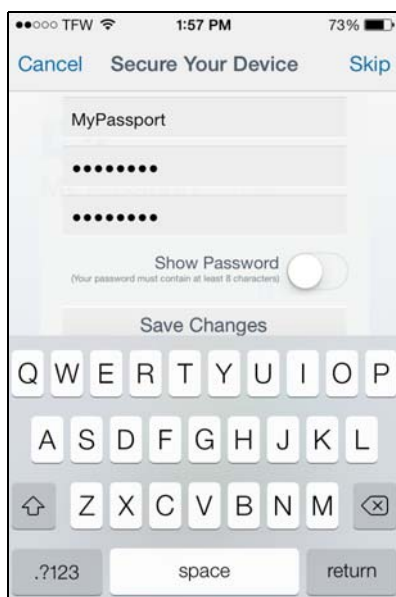

7. (Optional) Enter or change the Wi-Fi name of your My Passport Wireless drive.
8. (Optional) If you want to assign or change a password, enter it in both password fields.

Note: WD My Cloud for Android devices has a few more security screens to be completed.

9. Tap **Save Changes**. The following page displays:.



10. On your mobile device, go to **Settings** and connect to the My Passport Wireless using the new name of your drive and/or your new password.

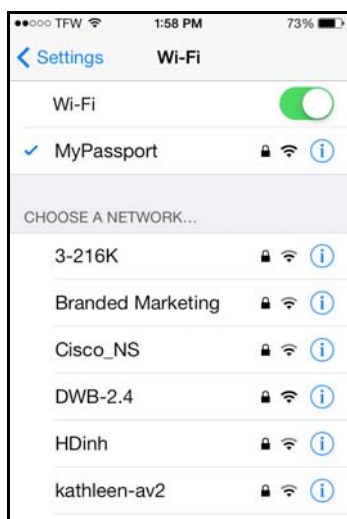

11. Tap the **My Cloud** icon on your mobile device and tap **MyPassport** (or whatever you named your drive) to display the following confirmation screen:



12. Click Continue Using WD My Cloud App to display your folders.

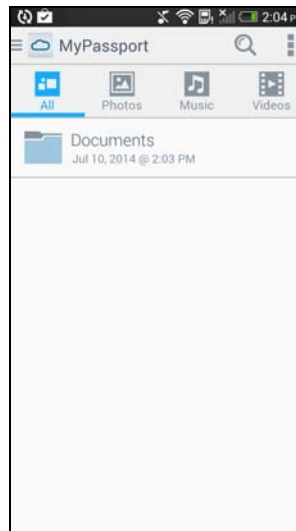
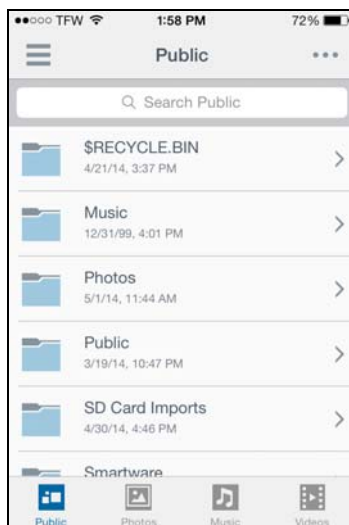

13. You can now open any of the folders to view its contents:

4

Using the Dashboard

- [Accessing the Dashboard](#)
- [Dashboard Home Page](#)
- [Icons](#)
- [Viewing Drive Status](#)

The My Passport Wireless dashboard is where you can customize settings and manage the drive as you prefer. This chapter provides an overview of the dashboard.

Accessing the Dashboard

After you connected the My Passport Wireless drive, any time you want to see the dashboard, open a browser and type one of the following:

- Windows computer: **http://mypassport** (or assigned name)
- Mac computer: **http://mypassport** (or assigned name).**local**
- Windows or Mac computer: **http://192.168.60.1** (default IP address)



Dashboard Home Page

The Home page has an information bar at the top right, a navigation icon bar across the page, and an instant overview of the status of the drive's main functions with links for updating settings.

The screenshot shows the My Passport Wireless dashboard interface. At the top right, there is a bar with 'Information icons' including a shortcut, notification, help, and log out. Below this is a 'Navigation Icons' bar with links for Home, Wi-Fi, Admin, Hardware, Media, Support, and Firmware. The main content area features 'Status and update panels' such as Capacity (250 GB Free), Battery (100% Charge), and Direct Connection. The footer displays the device name 'My Passport Wireless', capacity '500 GB Capacity', version 'v1.00.81', and date/time '7/9/2014 12:28 PM'.







Icons

Information Icons

Icon	Name	Actions
	Alerts	Displays recent alerts about new firmware and network issues.
	Critical alerts	Displays a severe warning: such as over temperature, under temperature, drive SMART failure, or failure of the data volume to mount.
	Help	Click to connect to WD Learning Center, online Help, Technical Support, and information about the drive.

Navigation Icons

Use the navigation icons to open screens where you can configure settings as you please.

Icon	Name	Actions
	Home Page	The dashboard displays an instant overview of the status of the drive's main functions and links for updating settings.
	Wi-Fi	Displays the Wi-Fi page so you can view and change connection types.
	Admin	Displays the Admin page so you can change device name and password, select the language in which the screens appears, specify the type of access the drive provides, and restore factory settings.
	Hardware	Click to extend battery life or improve performance, lock the drive, view the current time, and reboot the drive.
	Media	Click to enable or disable DLNA streaming, refresh or rebuild the DLNA database, view a media count, and copy or move files from an SD Card.
	Support	Click to create system reports, test and diagnose problems, and join the Product Improvement Program.
	Firmware	Click to view current version information, update new firmware, or perform a manual update from a file.

Viewing Drive Status

The main body of the Home page shows the status of the device and provides shortcuts to two important tasks.

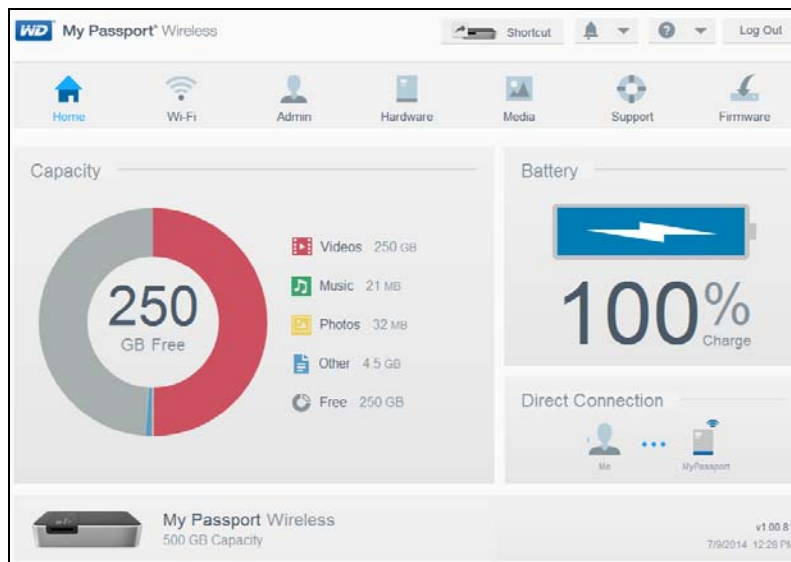

Capacity Panel

Displays the amount of storage taken up by various types of media files and the amount of free storage left on your drive. If you click the panel, it shows the number of files in each category.

Battery Panel

Displays the current percentage of total charge the battery currently holds. Click the panel to display the Hardware page, where you can view more detailed battery information.

Connection Type Panel

Illustrates the current connection type: Direct, Hotspot, or Home Network. Click the panel to display the Wi-Fi page, where you can change how the drive is connected.

5

Connecting the Drive

- [Ways to Connect the Drive](#)
- [Making a Direct Connection](#)
- [Connecting to a Public Wi-Fi Network/Internet](#)
- [Connecting to Your Home Wi-Fi Network](#)
- [Viewing or Changing the Drive's Advanced Wi-Fi Settings](#)
- [Removing a Connection](#)

Ways to Connect the Drive

You can connect to the My Passport Wireless drive using the following methods:

Direct Connection

Connect the wireless drive directly to your computer – Set up a direct connection from your computer or a mobile device to the drive by joining the My Passport Wireless drive's Wi-Fi network. Referred to as Direct or AP mode.



Note: The drive is not connected to your wireless network or the Internet under this connection. However, this direct connection between your drive and the computer provides the best throughput performance.

Public Wireless Network Connection

Connect the wireless drive to a public Wi-Fi network and the Internet – Set up the My Passport Wireless drive to join a public wireless network and share the Internet. Any other computers or devices connected to the public wireless network are unable to see your data. Referred to as Hotspot or Shared Connection mode.



Home Network Connection

Connect the wireless drive to your home's Wi-Fi network – Connect the wireless drive to your home's Wi-Fi network to share content and Internet connection. All devices on the drive's network and on the home Wi-Fi network can access the content stored on the wireless drive and attached devices.



USB Connection

Plug the drive into your computer (USB mode) – Connect your computer and your My Passport Wireless drive with a USB cable, essentially turning the drive into a Direct-Attached Storage (DAS) drive. In this case, there is no wireless connectivity so you don't get Internet access and are unable to display the My Passport Wireless web interface.

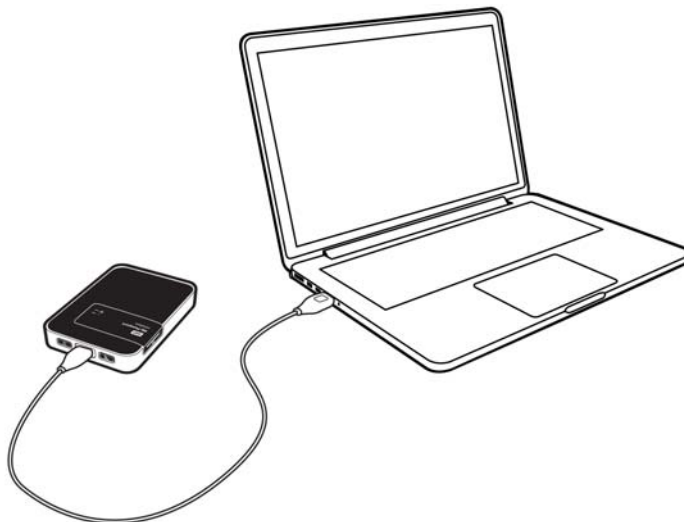

Note: See “Using a USB Connection to Load Content” on page 30 for information about USB connections.



Making a Direct Connection

Making a Direct Connection Using a Web Browser

After setup, when you want to connect to your computer (if not already connected), follow these steps:

1. Make sure the My Passport Wireless device is on, the Power and Battery Status LED is lit, and the Wi-Fi LED is solid blue.
2. On your computer, open the list of available networks.

Windows 7



Windows 8

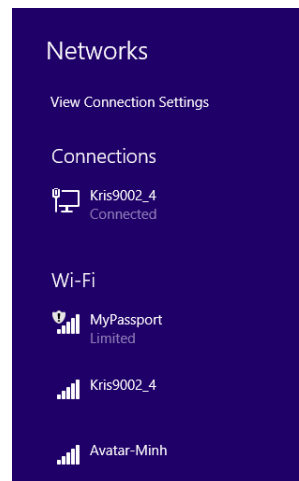

3. Select **MyPassport**.
4. Open a browser and type one of the following:
 - Windows computer: **http://mypassport** (or assigned name)
 - Mac computer: **http://mypassport** (or assigned name).**local**
 - Windows or Mac computer: **http://192.168.60.1** (drive's default IP address)
5. Press **Enter** to display the My Passport Wireless dashboard.

You can now move content between the drive and the computer. (See "Using a Wi-Fi Connection to Load Content" on page 31.)

Making a Direct Connection to a Mobile Device via WD My Cloud

This procedure assumes you have already downloaded the WD My Cloud app on a mobile device and connected wirelessly to the My Passport Wireless drive at least once. (See “Using WD My Cloud App on a Mobile Device” on page 11.)

Note: iOS images are on the left and Android images are on the right.

- 1. Open WD My Cloud on your mobile device and click **Connect Now..**

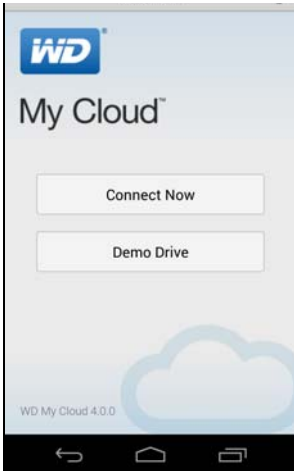
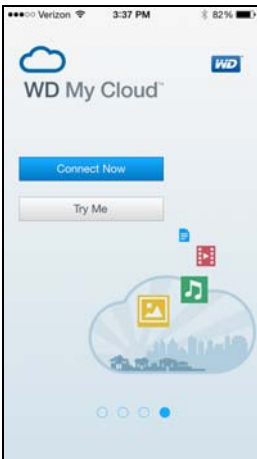

A list of available devices/networks displays:

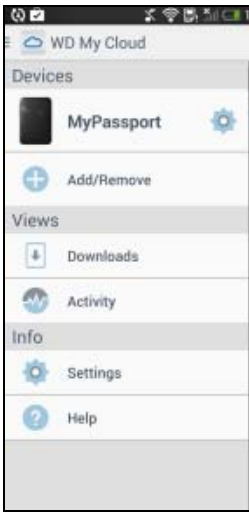

- 2. Tap to select your My Passport Wireless drive.
You can now move content to and from the drive and configure it as desired. (See the My Cloud Help or the online Learning Center for instructions.)



Connecting to a Public Wi-Fi Network/Internet

A public Wi-Fi network (also called a hotspot) provides network and Internet access to mobile devices such as laptops or mobile phones. These networks are typically in public locations like coffee shops, airports, and hotels. For example, if you connect your My Passport Wireless drive to the Wi-Fi network in a hotel and then connect numerous other devices to the drive, all devices can securely connect to each other and to the Internet.

Connecting the My Passport Wireless drive to a public Wi-Fi Network gives you access to your files as well as to the Internet. If you set up a password for your drive during setup, when you are connected to a public Wi-Fi Network, others are not be able to see the content of the drive.

To connect to a public Wi-Fi Network:

1. On the My Passport Wireless dashboard, click **Wi-Fi** to display the current connection, in this case, a direct connection.

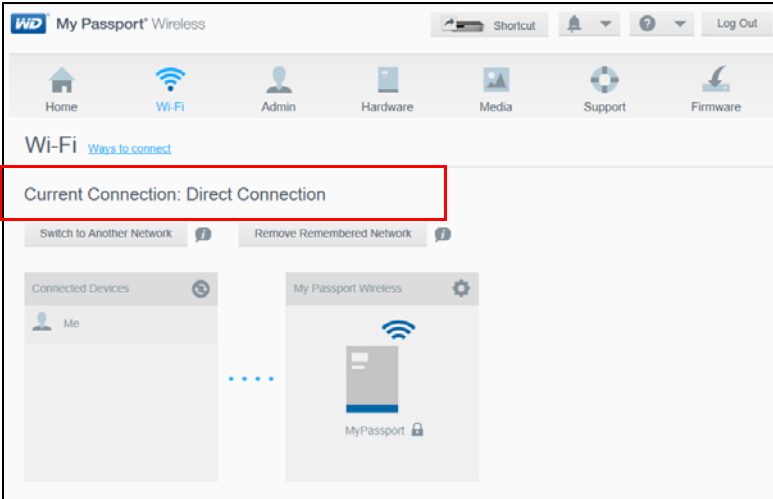

2. Click **Switch to Another Network** and in the list of available Wi-Fi networks that displays, select one.

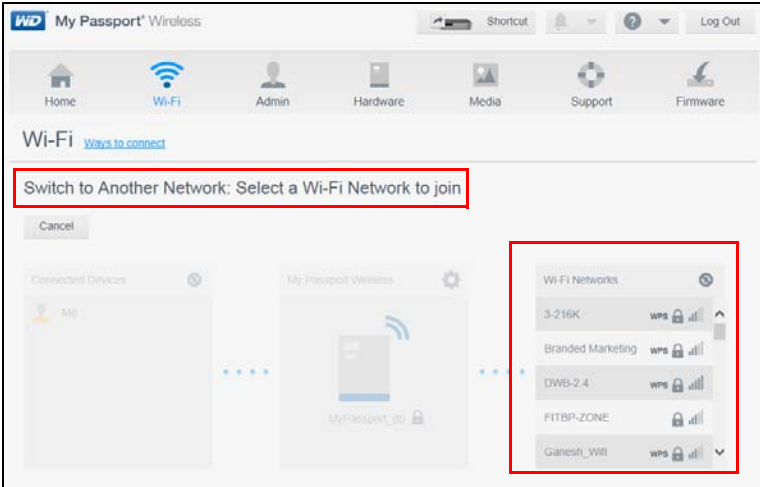

The Connect to screen displays:

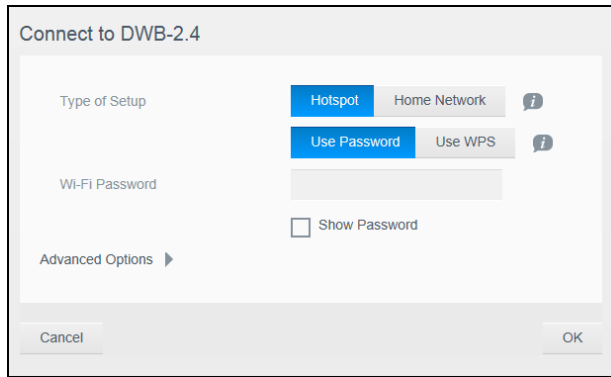

3. Click **Hotspot** and do one of the following:
 - Click **Use Password** and enter the password for the Wi-Fi network.
 - Click **Use WPS** and enter the WPS PIN.

Note: The WPS option is not available if your network doesn't have WPS functionality.
4. (Optional) Click the **Advanced Options** arrow to display more Wi-Fi settings for the hotspot. View or change the settings:

Hotspot Advanced Options

Clone MAC Address	Toggle to On to copy the MAC address of the computer that are you using into the MAC address field on the Passport Wireless drive. This allows the drive to present your computer's MAC address to the Public Wi-Fi network and not use another MAC address (sometimes avoiding additional charges, in hotels and other connection limited services).
SSID Broadcast	Your wireless clients identify and connect to your Wi-Fi network, using the Wi-Fi name or SSID (Service Set Identifier). The SSID broadcast is On by default. For additional security, you can turn SSID broadcast to Off .
MAC Address	Unique identifier of the My Passport Wireless drive's interface.
Device Name	Name that will be shown for the drive on the network as a storage device and by DLNA players.
Network Mode	Select the DHCP or Static method of assigning the IP addresses for devices connected to the My Passport Wireless network. If you select DHCP, addresses will automatically be assigned to devices that connect to the My Passport Wireless network. If you select Static, you must assign static addresses to clients on the network.
IP Address	IP address of the My Passport Wireless drive.
DHCP Service	Service that assigns IP addresses to devices on the My Passport Wireless network. On by default. If you turn the service Off , you must assign static addresses to clients on the network.

5. Click **OK** to display the Wi-Fi screen showing the hotspot connection:

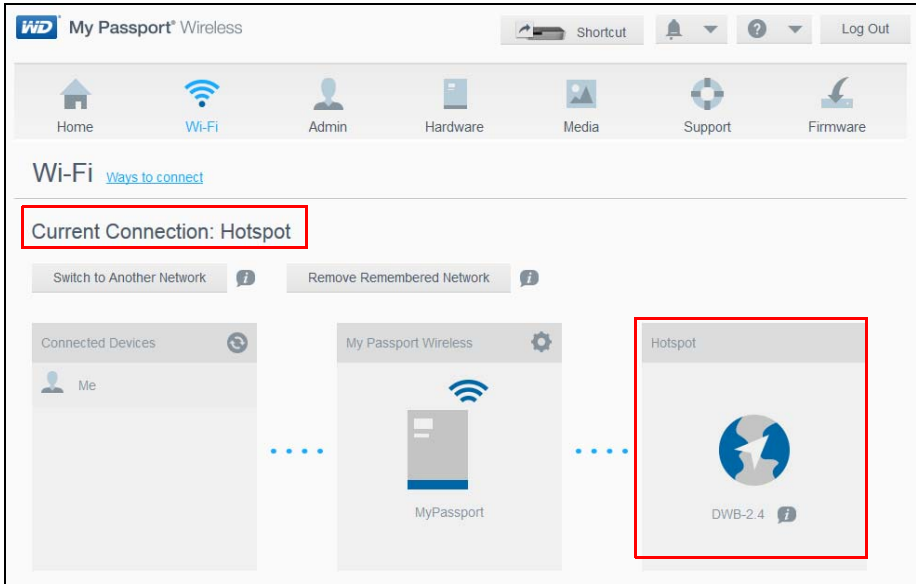

If the network you joined has Internet connectivity, you now have Internet access. And if other computing devices join the My Passport Wireless drive's Wi-Fi network, they will also have Internet access and access to the drive's content. If you've set a password for the drive, no computer or device on the public Wi-Fi network can access your drive.

Note: Some hotspots require you to log in when you first open a browser window.



Connecting to Your Home Wi-Fi Network

When your drive is connected wirelessly to your computer or to a mobile device with a direct connection, you can change the connection so that the drive has access to your home Wi-Fi network. All devices on the home Wi-Fi network can access the drive.

1. On the dashboard, click **Wi-Fi** in the navigation bar to display the Wi-Fi screen showing the current connection, in this case, a direct connection:

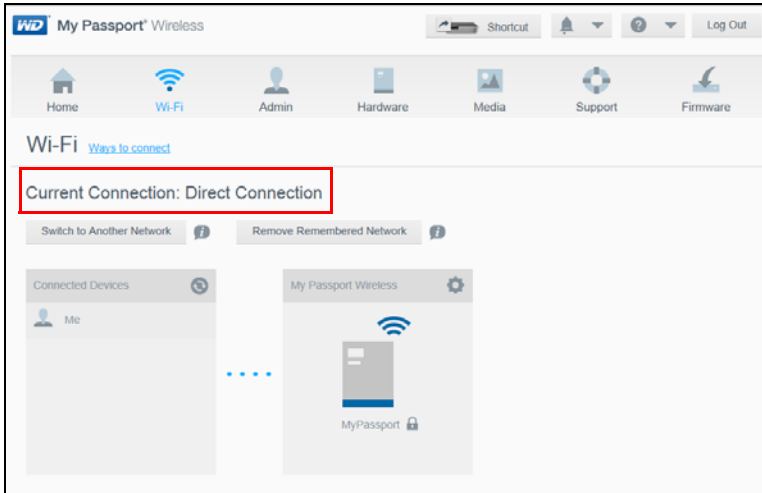

- Click **Switch to Another Network** and from the list of networks that displays, select your home Wi-Fi network.

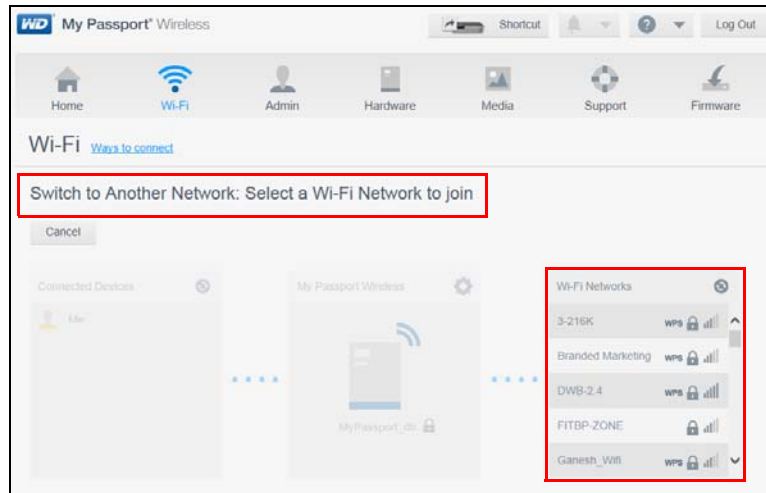

The Connect to screen displays:

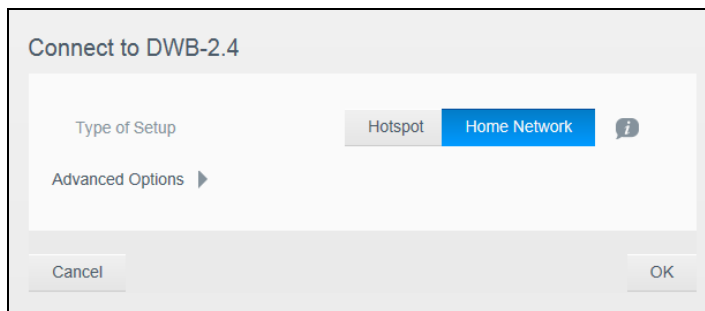

- Click **Home Network** (default setting) and do one of the following:
 - Click **Use Password**, and enter the password for your home Wi-Fi network.
 - Click **Use WPS** and enter your router's WPS PIN. To generate a WPS PIN, see the documentation that comes with your router.

Note: You cannot connect a device to your My Passport Wireless using WPS, but you can connect your My Passport Wireless to a Wi-Fi router using WPS.

Note: The WPS option may not be available to you depending on your home Wi-Fi network.
- (Optional) Click the **Advanced Options** arrow and view or change the settings:

Home Network Advanced Options

MAC Address	Unique identifier of the My Passport Wireless drive's external network interface.
Device Name	Name of the My Passport Wireless drive when connected as a wireless Network Attached Storage.
Network Mode	Select DHCP to automatically receive and use an IP address from the DHCP server on the network, when in Home Mode. If you select Static, you must manually assign an IP address for the My Passport Wireless on the home network.

- Click **OK** to display the Current Connection: Home Network screen:

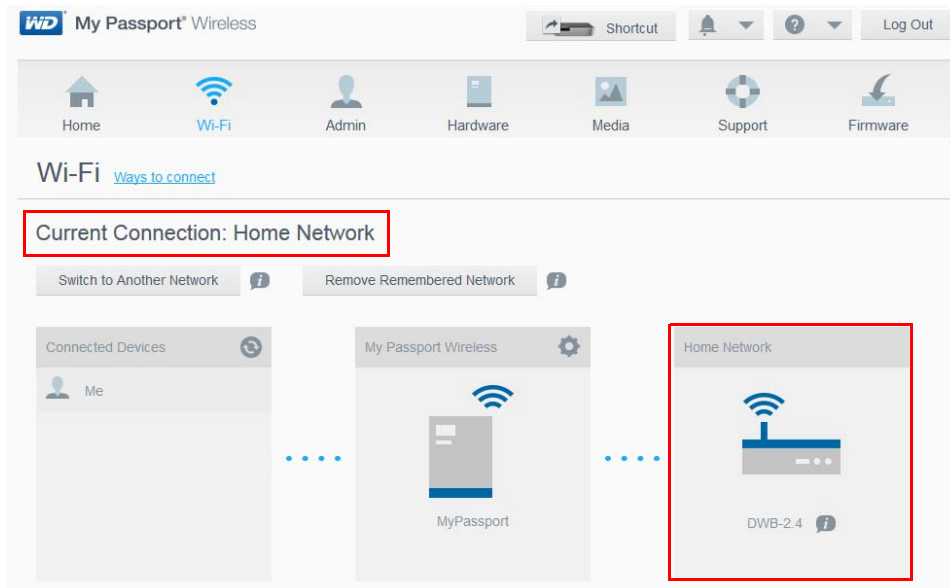

If not already connected, connect your computer to your home Wi-Fi network. After you join your computer with your home Wi-Fi network, you have access to the media (by DLNA) on your My Passport Wireless drive as well as Internet access (provided your home Wi-Fi network has Internet connectivity). Other devices that connect to your home Wi-Fi network have the same kind of access.

Viewing or Changing the Drive's Advanced Wi-Fi Settings

You can change the drive name, security, and other settings on the Wi-Fi page.

- On the My Passport Wireless dashboard, click **Wi-Fi** to display the current connection, in this case, a Home network connection.

Note: The settings are the same for all of the connection modes.

- 2. Click the settings icon in the upper right of the My Passport Wireless box to display the current Wi-Fi settings:

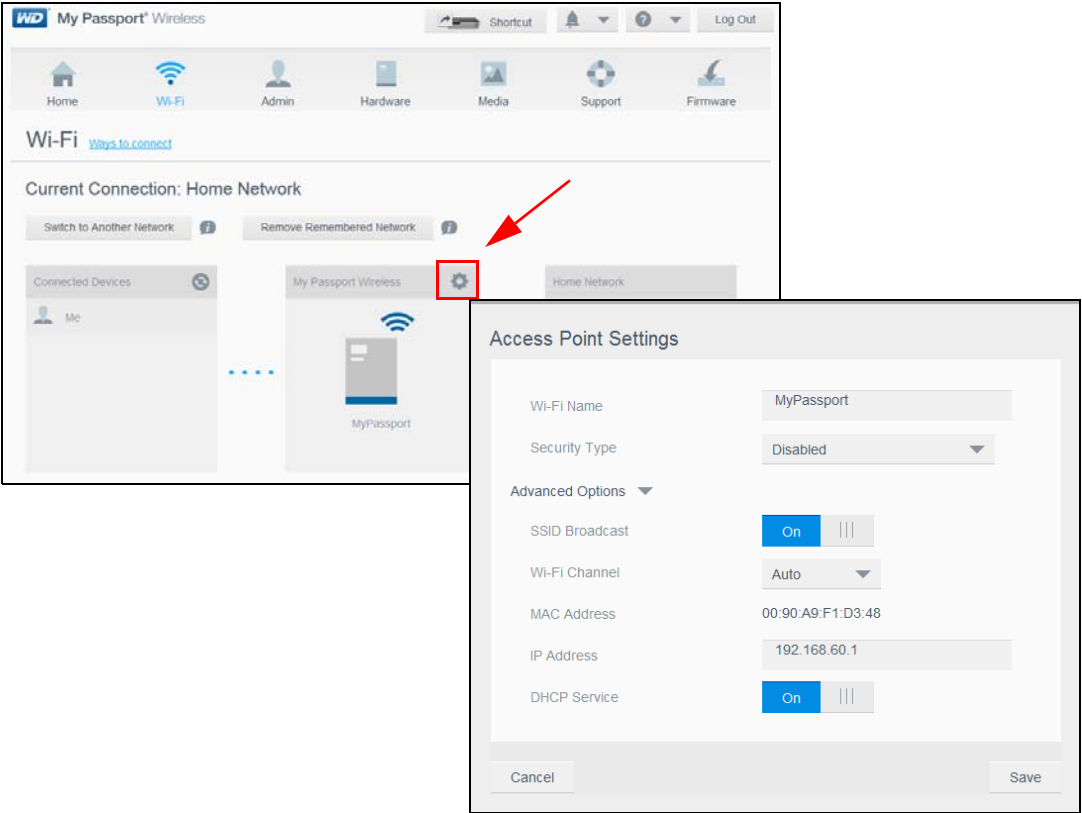

- 3. View or change the settings.

Wi-Fi Name	Wireless network name.
Security Type	<p>Select the type of security to be applied to the drive's Wi-Fi network:</p> <ul style="list-style-type: none"> • Disabled (no security) is the default • WPA2 Personal • WPA/WPA2 Personal Mixed <p>WPA (Wi-Fi Protected Access) and WPA2 are security protocols that use a dynamically changing key. WPA2 is the second generation protocol that uses stronger AES (Advanced) Encryption Standard) encryption.</p> <p>WPA/WPA2 mixed security mode provides better compatibility with older devices. However, for better performance and higher security, WPA2 security mode is highly recommended.</p>
Advanced Options	
SSID Broadcast	Your wireless clients identify and connect to your Wi-Fi network, using the Wi-Fi name or SSID. SSID broadcast is On by default. For additional security, you can turn SSID broadcast to Off .
Wi-Fi Channel	Accept the default (Auto) or select a channel from the drop-down list.

MAC Address	Unique identifier of the My Passport Wireless drive's network interface.
IP Address	IP address of your My Passport Wireless drive.
DHCP Service	Service that assigns IP addresses to devices on the My Passport Wireless network. On by default. If you turn the service Off , you must assign static addresses to clients on the network.

4. Click **Save**.

Removing a Connection

1. To remove a connection, click **Remove Remembered Network** on the Wi-Fi page.

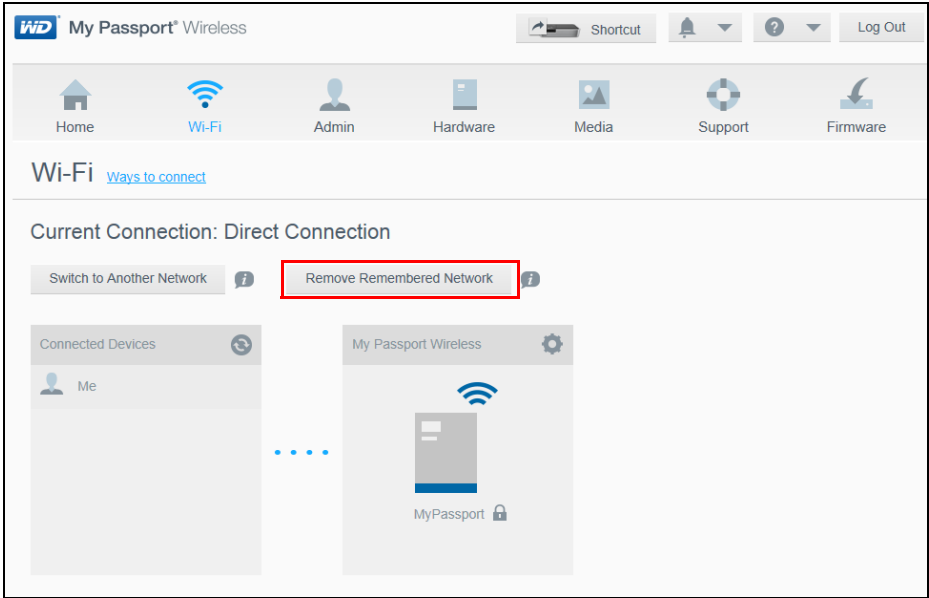

The Remembered Connections screen displays:

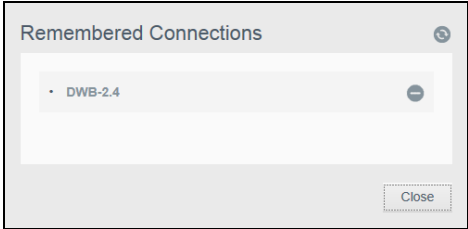

2. Click the minus sign (-) next to the connection you want to remove, and then click **Close**. You can set up a new connection when you want to use it again. If you remove all connections, a *No connections found* message displays.

6

Loading Content on Your Drive

This chapter includes the following topics:

- [Loading Content](#)
- [Using a Compatible Wireless Camera](#)
- [Backing up a Computer to the Drive](#)

One of the first things to do with your drive is to load content to it using a USB connection, a wireless connection, an Android/iOS mobile device with WD My Cloud, or a compatible wireless camera. Another way to load content is to back up a computer to the drive.

Note: To load content from an SD card, see “Moving or Copying Content from an SD Card” on page 36.

Loading Content

Using a USB Connection to Load Content

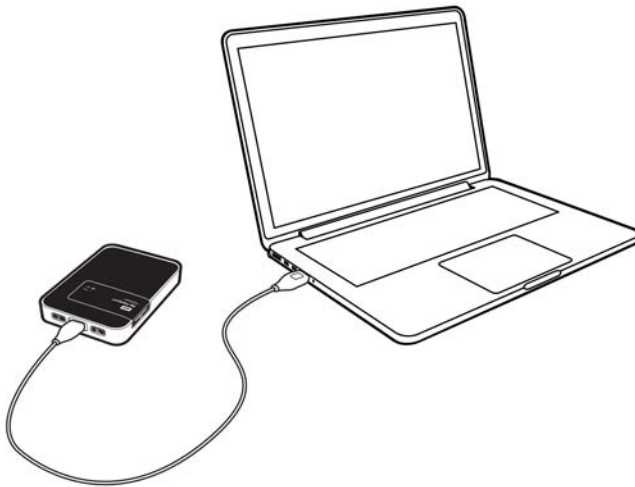

If you want to copy over a lot of files, use the USB port on your computer, which is faster than using the My Passport Wireless Wi-Fi network.

1. Plug one end of the USB cable into the drive and the other end into your computer's USB port.

Note: When you connect your computer and drive this way, the drive's wireless network is disabled.

2. On your computer, open the File Explorer (Windows PC) or Finder (Mac) window.
3. Do one of the following:
 - For a Windows PC: In the left pane of the File Explorer window, click **Computer** and double-click the My Passport Wireless drive.
 - For a Mac computer: In the left pane of the Finder window in the DEVICES section, double-click the My Passport Wireless drive.
4. Drag and drop files from your computer to the drive and a copy of the files is saved on the drive.

Using a Wi-Fi Connection to Load Content

When you first connect to the My Passport Wireless Wi-Fi network, none of your media is on the drive. You can start copying files from your computer or other devices on the network to the drive using Wi-Fi.

From your computer or computers and devices on the same network

1. Check your settings and make sure your computer is connected to your My Passport Wireless drive or the same wireless network your drive is connected to. The drive can act as a wireless client device on your Wi-Fi network so everyone on the network can access it (like a regular network attached storage device).
2. On your computer, open the File Explorer (PC) window or Finder (Mac).
3. Do one of the following:
 - For a Windows PC, in the left pane of the File Explorer window, click **Network > MyPassport** (or name you assigned) **> Public**.
 - For a Mac computer, in the left pane of the Finder window in the SHARED section, double-click **MyPassport** (or name you assigned) **> Public**.

The drive's Public folder opens.
4. Drag and drop files from your computer or other computers and devices on the network to the drive's Public folder.

From a mobile device with WD My Cloud

1. Go to Settings on your mobile device and make sure your mobile device is connected to your My Passport Wireless drive.
2. Tap the **My Cloud** icon on your device.
3. Tap the **Public** folder.
4. In the top right corner of the Public pane, tap the omni menu icon (three horizontal dots) and then tap **Add Photo**.
5. Tap **Camera Roll**.
6. Select your items.
7. In the bottom right corner of the dialog, tap the upload icon.

The files have been uploaded to the My Passport Wireless drive. Now you can delete them from your mobile device if you are trying to save space, or leave them on the mobile device for backup.

Using a Compatible Wireless Camera

File Transfer Protocol (FTP) enables the transfer of content to and from your drive's Public folder through FTP. The drive supports default Anonymous login and takes advantage of Wi-Fi security for protection. The My Passport Wireless drive is compatible with wireless cameras that support FTP, such as Nikon WT-2 and Canon WFT. See Knowledge Base Answer ID 11737 for information on compatible cameras. FTP is disabled by default.

To enable FTP Access,:

1. Click **Admin** on the navigation bar to display the Admin page:

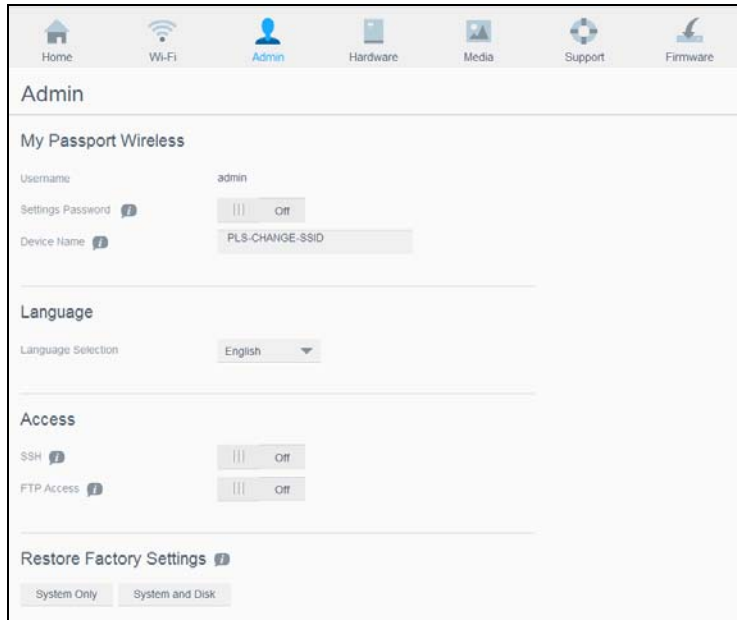

2. In the Access section, click the FTP toggle button to **On**.
3. Use the FTP settings below for your camera or other device using the FTP connection on the My Passport Wireless drive:
 - **FTP Server Address:** 192.168.60.1 (unless changed from default)
 - **FTP Server Port Address:** 21 (not changeable)
 - **Passive Mode:** Should be Disabled
 - **Proxy Server:** Should be Disabled
 - **Login Method/Name:** Anonymous (no password required)
 - **Target Folder:** Public/<folder> (case sensitive)

Note: Check your camera's documentation on how to work with FTP.

Backing up a Computer to the Drive

Following is a brief overview of using your My Passport Wireless drive as a backup destination. To back up files, the drive must be connected to the computer physically with a USB connection.

Using WD SmartWare™ (Windows Only)

WD SmartWare software is an easy-to-use tool that gives you the power to protect your data automatically with automatic, continuous backup and the ability to retrieve lost files.

Note: Automatic backup protection is continuous as long as your My Passport Wireless drive is connected to your computer by a USB connection. If you disconnect the drive from your computer, backup temporarily stops. Once you reconnect, the WD SmartWare software automatically scans your computer for new or changed files and resumes backup protection.

Installing WD SmartWare Software

1. Access the online Learning Center Welcome page for the My Passport Wireless:
www.wd.com/setup/mypassportwireless

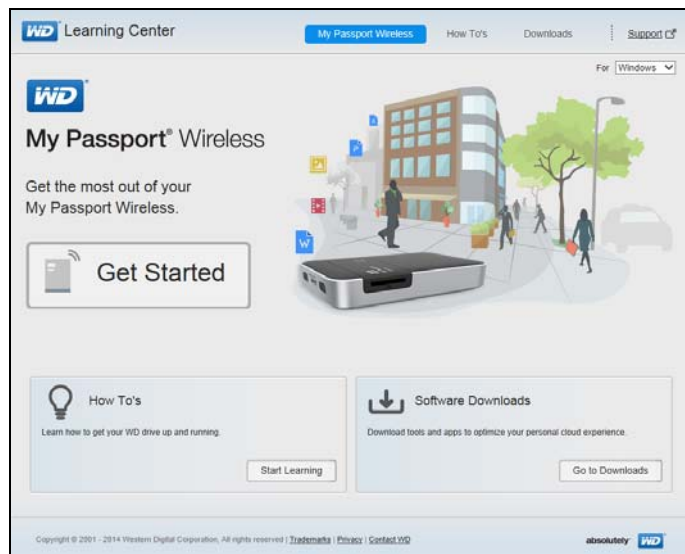

2. Click **Go to Downloads** to display the Downloads page:

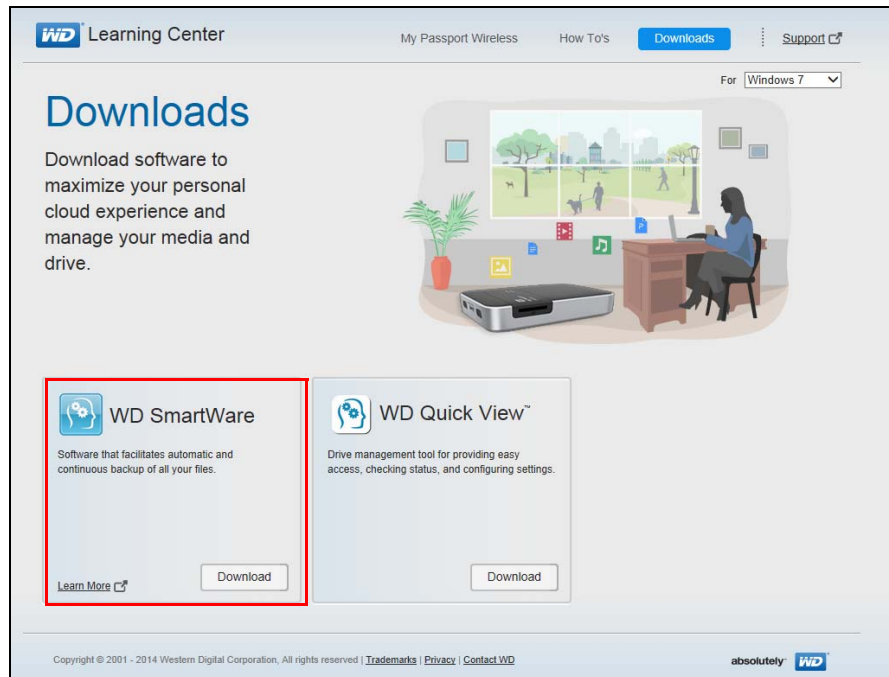

3. In the WD SmartWare box, click **Download**.
4. Access your downloaded files and extract the contents of the zip file to your computer.
5. Double-click the **WD SmartWare Setup** file.
6. Follow the online instructions to complete the installation.

Launching WD SmartWare Software After Installation

Use one of the following options for WD SmartWare software once you have installed it:

- **Windows 7:** From the **Start** menu, click **Programs > WD SmartWare > WD SmartWare**.
- **Windows 8:** From the **Start** menu, click **WD SmartWare**.
- **WD Quick View Icon:** Left- or right-click the **WD Quick View**  icon in the Windows system tray to display the menu, and then select **WD SmartWare**. The icon is automatically installed when you download WD SmartWare. (For more information about WD Quick View, see “Using WD Quick View with the Drive” on page 51.)

Viewing the Info/Online Help Topics

WD SmartWare software provides two kinds of Help:

- **Help icon**  — Each WD SmartWare page provides easy access to online help information to quickly guide you through your backup, retrieval, and settings tasks. Whenever you are uncertain about what to do, just click the info/online Help icon in the upper-right corner of any page.

To close the info/help page after reading the online Help, click the **X** button in the upper-right corner of the page.

- **Help tab** — This tab on the WD SmartWare pages provides more detailed Help.

Please refer to the WD SmartWare online Help for further instructions.

Backing up a Mac Computer

Note: To use Time Machine, reformat your drive to HFS+ Journal. For more information see Knowledge Base Answer ID 11742.

The Apple Time Machine is a built-in feature on Mac OS X Mavericks, Mountain Lion, Lion, and Snow Leopard computers that can back up everything on your computer: music, photos, documents, applications, emails, and system files. Your My Passport Wireless drive must be in USB mode to use Apple Time Machine.

The My Passport Wireless drive can store these backups, so that if your hard drive or operating system should crash, or you lose a file, you can easily restore it to your computer. You can specify the maximum amount of space you'd like to use on your drive to back up your files. Consult Apple Time Machine documentation.

7

Using an SD Card with the Drive

This chapter includes the following topics:

- [Moving or Copying Content from an SD Card](#)
- [Viewing Content Imported from an SD Card](#)
- [Viewing Content on an SD Card](#)

It is easy to move or copy content from an SD card to your My Passport Wireless drive.

Moving or Copying Content from an SD Card

1. Insert the SD card containing your media files into the drive's SD card slot.
2. Click **Media** in the Navigation bar to display the Media page:

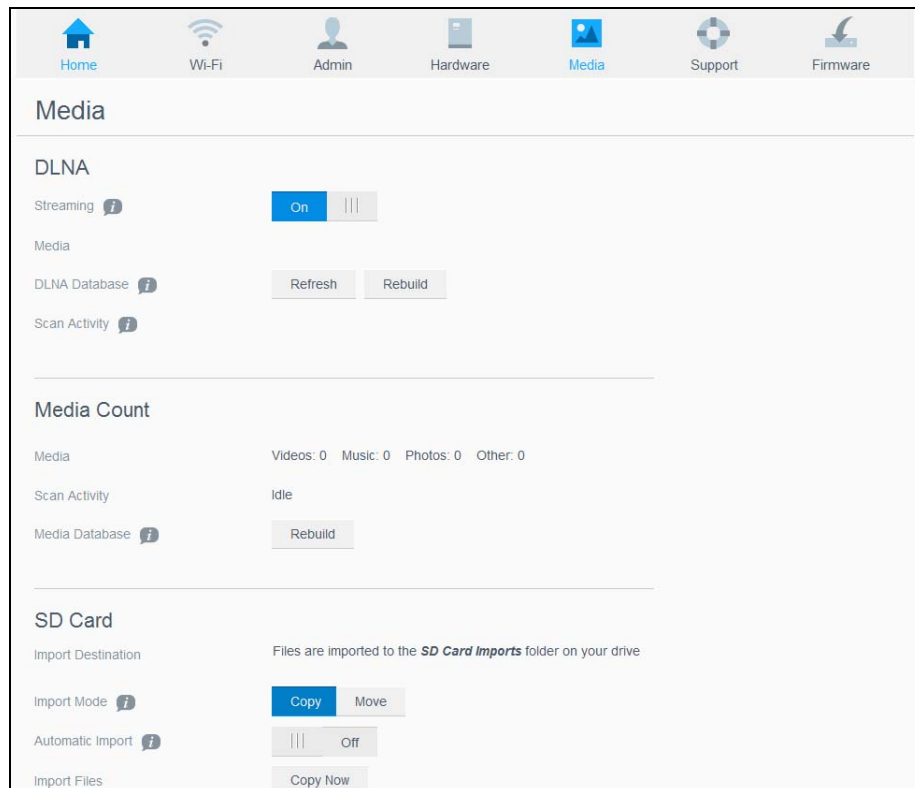

3. To copy files from the SD card, do one of the following:
 - To copy your files immediately, click **Copy** and then **Copy Now**.
 - To automatically copy new files as soon as you insert the card, click **Copy** and then turn the **Automatic Import** switch to **On**.
4. To move files from the SD card, do one of the following:

CAUTION! When you move the files, they are removed from the SD card.

- To move your files immediately, click **Move** and then **Move Now**.
 - To automatically move new files as soon as you insert the card, click **Move**, and then turn the **Automatic Import** switch to **On**.
5. To manually sync the SD card and drive, press the **WPS** button quickly.

Viewing Content Imported from an SD Card

Note: Besides using the computer to check the files from an SD card, you can also do it with the WD My Cloud mobile app. To use the mobile app, you must sync the content onto the My Passport Wireless drive first.

1. On your computer, open the File Explorer (PC) window Finder (Mac).
2. Do one of the following:
 - For a Windows PC, in the left pane of the File Explorer window, click **Network > MYPASSPORT > Public > SD Card Imports**.

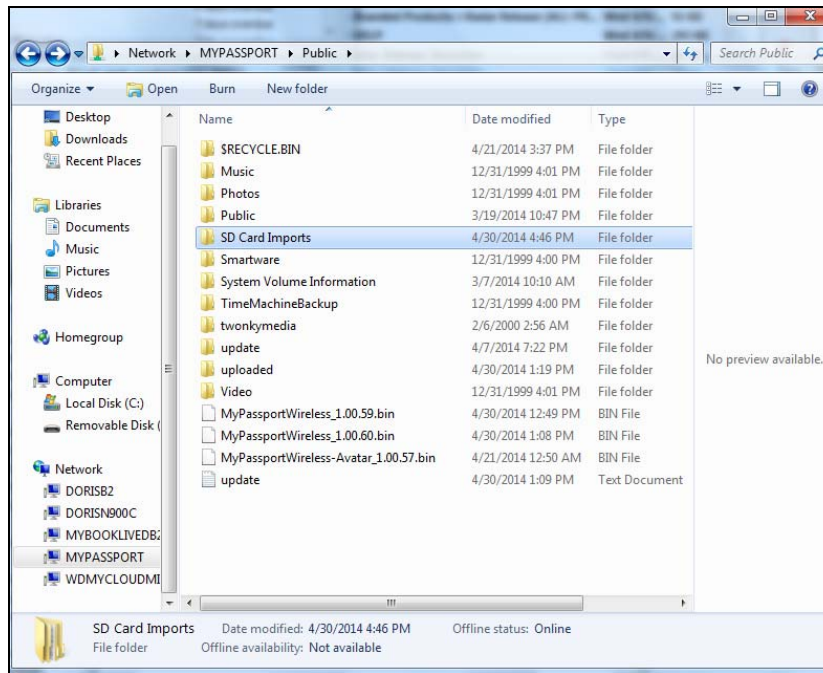

- For a Mac computer, in the left pane of the Finder window in the SHARED section, double-click **MYPASSPORT > Public > SD Card Imports**.

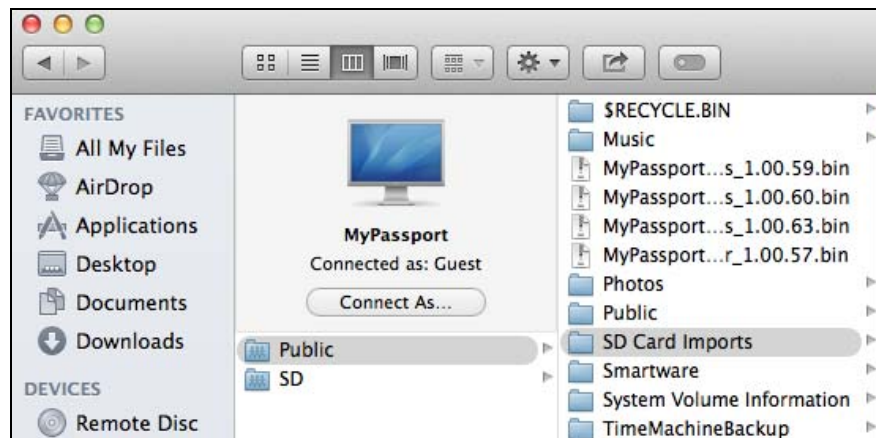

Viewing Content on an SD Card

1. On your computer, open the File Explorer (PC) window or Finder (Mac).
2. Do one of the following:
 - For a Windows PC, in the left pane of the File Explorer window, click **Network > MYPASSPORT > SD**.

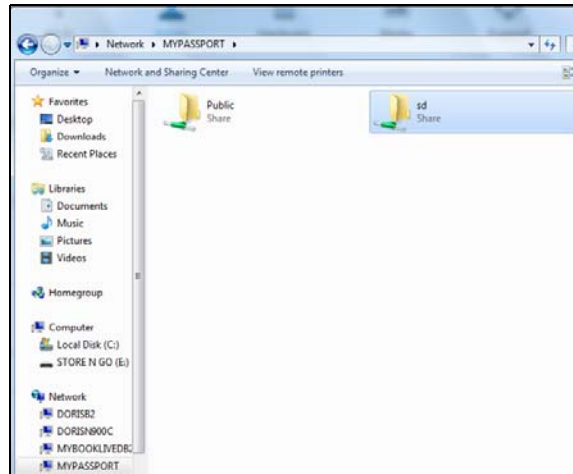

- For a Mac computer, in the left pane of the Finder window in the SHARED section, double-click **MYPASSPORT > SD**.

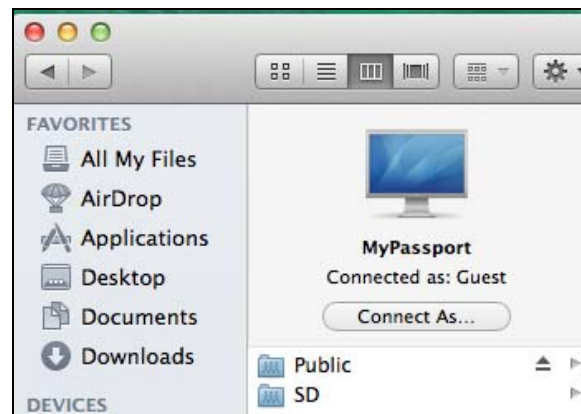

Playing/Streaming Videos, Photos, & Music

- [Using the Drive as a Media Server](#)
- [Enabling Media Streaming](#)
- [Using the Drive with a DLNA-Enabled Mobile App](#)

Using the Drive as a Media Server

Note: See specific DLNA media device user manuals for instructions on connecting a DLNA device to your local area network so you can access content on the My Passport Wireless device. Go to <http://www.dlna.org> for a list of DLNA-certified devices and for further information.

The My Passport Wireless drive can be enabled to serve as your home's DLNA media server. It streams photos, music, and videos to your DLNA-compatible devices so you can play media on a compatible device easily. DLNA-compatible devices search for media stored on the drive if streaming is enabled on the Media page. Streaming is enabled by default.

With streaming enabled, just transfer your multimedia content to your My Passport Wireless drive, and you are ready to stream and view content on your home entertainment center, game consoles (for example, Xbox 360® or PlayStation® 3), WD TV Live® media player, or DLNA® 2.0 digital media adapters), and other PC computers on your home or office network.

If you have a DLNA server or media player (e.g., VidOn or Skifta) on your phone or other mobile device, the My Passport Wireless drive can stream media to it. Visit <http://www.dlna.org> for further information about DLNA.

Enabling Media Streaming

On the Media page you can enable or disable media streaming, refresh or rebuild your media database on the My Passport Wireless drive, and see a count of the photo, video, and music files on the drive.

- To display the Media page, click **Media** on the Navigation bar.

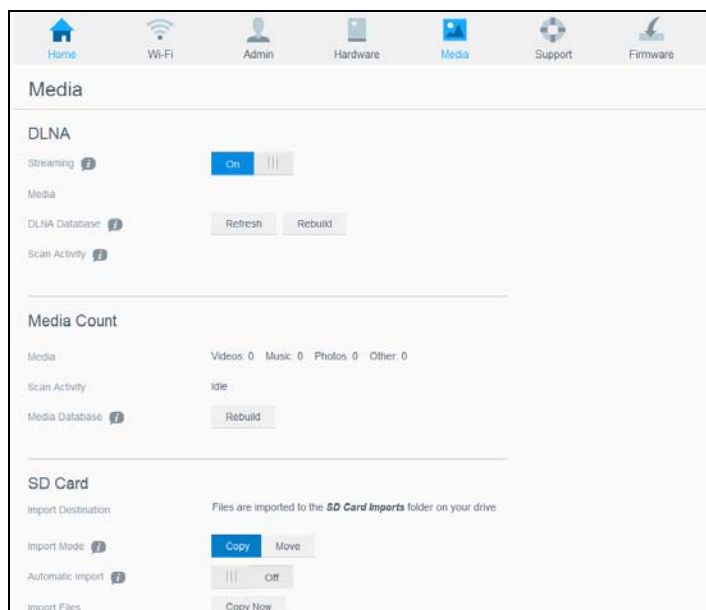

DLNA

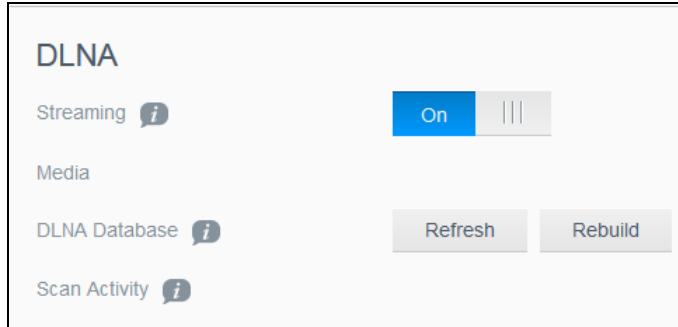

The DLNA section of the page allows you to enable or disable media streaming and rebuild the DLNA data base. The drive automatically refreshes and rebuilds the DLNA database; however, you can do so manually if you suspect that your database is corrupted.

1. In the DLNA Server section, make sure the **Streaming** toggle button is **On**.
2. Click one of the following to either refresh or rebuild your DLNA database:
 - **Refresh:** Searches for changes made to your media libraries.
 - **Rebuild:** Rebuilds the DLNA database from scratch. Rebuilding the DLNA server database could take a considerable amount of time, depending on the number and size of the files involved.

Media Count

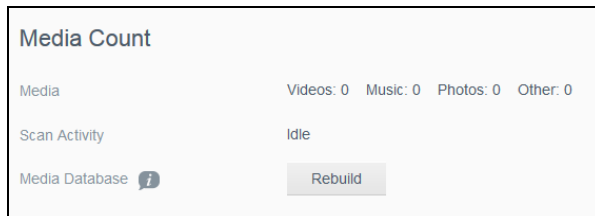

This section of the screen displays the number of video, music, photo, and other files available on the My Passport Wireless drive. The status is helpful if you are copying files to the drive--you can see the total number of files transferred.

Note: For information about using SD Cards, see “Moving or Copying Content from an SD Card” on page 36.

Accessing Your Content Using Media Players

Once you have copied your files to the My Passport Wireless drive, connect the drive to your home network or directly to the media player. You can use a variety of media players to stream media. Refer to Knowledge Base Answer ID 11737 for information about devices that have been tested for compatibility with the drive.

WD Media Players

You can connect the various WD TV and WD Media Players to the My Passport Wireless drive or to your home network for access to media content stored in the My Passport Wireless drive. For details on using a WD Media Player to access files on your drive, see Knowledge Base Answer ID 2676 or refer to your WD Media Player User Guide.

Other Media Players

Following are general steps for setting up devices such as digital picture frames, Blu Ray players, network-connected TVs, and digital media adapters:

1. Make sure that your My Passport Wireless drive is connected to your home's Wi-Fi network or to a hotspot, or is shared.
2. Make sure the drive is powered on.
3. Follow the user instructions provided with your media player to proceed through any initial setup or installation of drivers.
4. Using the navigation feature on your player, scan and detect your My Passport Wireless drive on your network.
5. Depending on the player you have, you may need to access a Settings/Network Setup page in the user interface to establish connection so that your player can link to your My Passport Wireless drive. Please refer to your player's user guide for specific instructions.

Using the Drive with a DLNA-Enabled Mobile App

The My Passport Wireless drive has a DLNA media server built in. Mobile apps with DLNA support from the Apple App store or Google Play can see and access the content stored in the drive.

1. Connect to the My Passport Wireless drive.
2. Open a third party application. (See Knowledge Base Article ID 11736 for a list of apps.)
3. Search for media servers and select.
4. Stream the media.

9

Using the Battery

This chapter includes the following topics:

- [Improving Battery Life or Performance](#)
- [Charging the Battery](#)
- [Viewing Battery Status When Drive is Off](#)

Improving Battery Life or Performance

The Hardware screen allows you to extend the life of the battery or improve the performance of the drive.

- To display the Hardware page, click **Hardware** on the navigation bar:

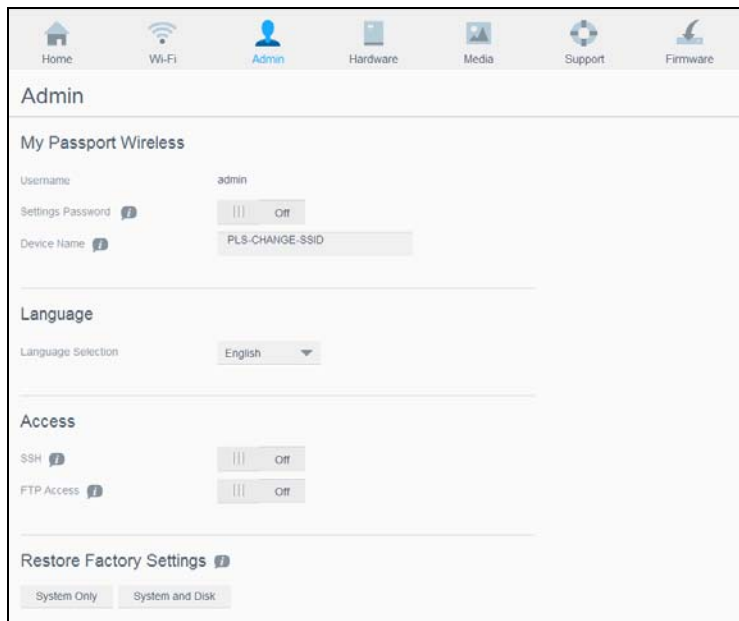

- In the Battery section, you have two options. You can either make the battery charge last longer but sacrifice how quickly media processing takes place, or make media processing faster but use up the battery more quickly:

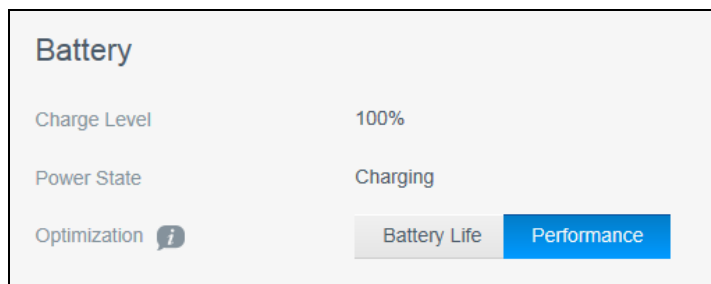

- To optimize how long the battery will keep sufficient charge, click **Battery Life**.
- To optimize media processing, click **Performance**.

There is no difference between the two options if your My Passport Wireless drive is plugged into an outlet and running on AC Power.

Charging the Battery

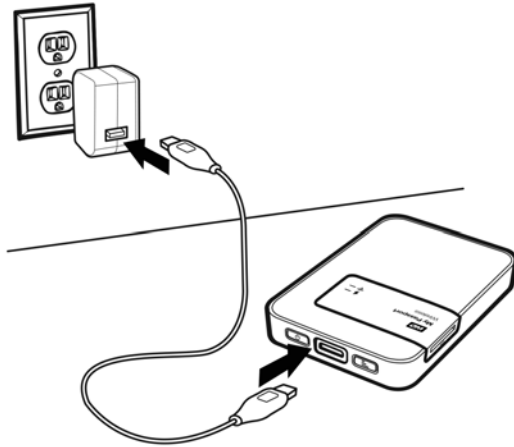

Important: It is best to charge the battery before using the My Passport Wireless drive the first time as the factory charge may have decreased during shipping. If you plan to store the drive, charge the battery before and after you store it.

1. Connect one end of the cable (included in the box) into the drive's USB port and the other end into the adapter (included in the box).
2. Plug the adapter into a wall socket.
3. The LEDs start to pulse. As the drive charges, the Power and Battery Status LED pulses and changes color. The LED color indicates the amount of battery charge. When the Power and Battery Status LED is solid blue, the drive is fully charged. (See "Understanding the LEDs and Buttons" on page 5.)

Other ways to tell if the drive is charging:

- On the Home page, a lightning bolt is added to the Battery panel.
- On the Hardware page, the Power State changes to **Charging**.

Viewing Battery Status When Drive is Off

1. Press the WPS button for one second. The Power and Battery Status LED lights in a color briefly.

10

Performing Administrative Functions

This chapter includes the following topics:

- [Changing the Password and Device Name](#)
- [Changing the Language](#)
- [Specifying Types of Access](#)
- [Locking the Drive](#)
- [Rebooting and Shutting Down](#)

The Admin page is where you can change or set a password to access the dashboard and perform other basic administrative functions.

1. Click the **Admin** icon on the navigation bar to display the Admin screen.

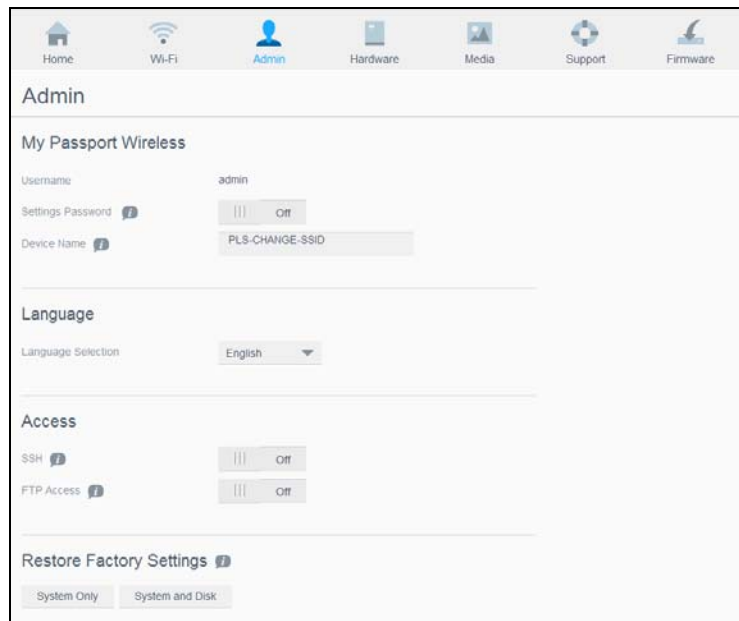

Changing the Password and Device Name

1. In the My Passport Wireless section of the screen, view or modify the following basic device settings:

User Name	The administrator's user name is Admin .
Settings Password	To set or change a password for accessing the dashboard: <ol style="list-style-type: none"> 1. To set a password, click the toggle button to On. 2. Enter a password in New Password and Confirm Password. 3. Click Save.
Device Name	If desired, enter a new name for your My Passport Wireless drive. This is the name you see on the network identifying the My Passport Wireless drive for connections and for accessing content stored on the drive.

Changing the Language



1. In the Language section select the language in which you want the dashboard screens to appear.
2. Click **Save**.

Specifying Types of Access

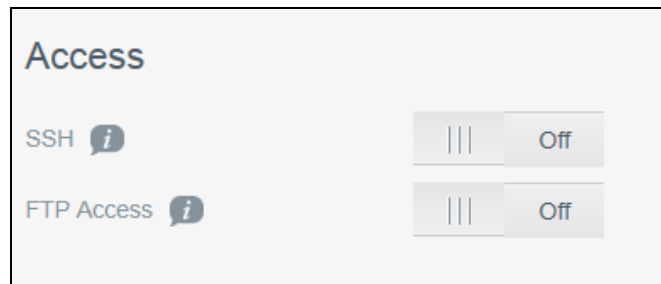

1. In the Access section, view or modify the following security access settings:

SSH	<p>Secured Shell protocol. SSH is a troubleshooting and analysis interface. Turn this option On to securely access your drive and perform command-line operations. It is disabled by default.</p> <p>WARNING! Do not use this option unless you have knowledge and experience using SSH.</p> <p>WARNING! Please note that modifying or attempting to modify this device outside the normal operation of the product voids your WD warranty.</p> <ol style="list-style-type: none"> 1. To enable SSH, click the toggle button to On. 2. In the SSH screen that displays, note the User Name and Password, click the I Accept check box, and click OK. <p><i>Note:</i> The SSH login User Name is root and the default password is welc0me (number 0, not letter O)</p>
FTP Access	<p>File Transfer Protocol (FTP) enables the transfer of content to and from your drive's Public folder through FTP. The drive supports default Anonymous login and takes advantage of Wi-Fi security for protection. The drive is compatible with wireless cameras that support FTP, such as Nikon WT-2 and Canon WFT. See Knowledge Base Answer ID 11737 for information on compatible cameras. FTP is disabled by default.</p> <ol style="list-style-type: none"> 1. To enable FTP Access, click the toggle button to On. <p><i>Note:</i> See "Using a Compatible Wireless Camera" on page 32.</p>

Locking the Drive

You can lock the drive on the Hardware page:

1. Click the **Hardware** icon on the navigation bar to display the Hardware screen.

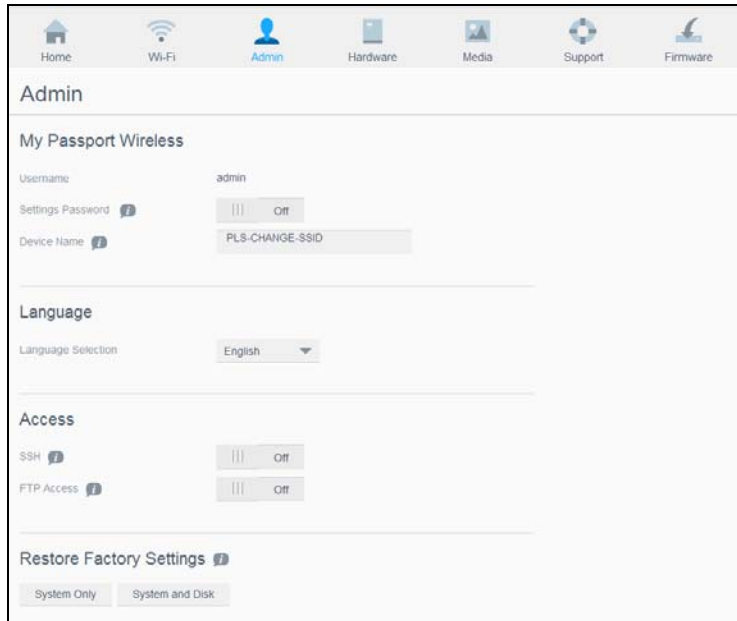

2. Toggle **Drive lock** to **On** to lock the drive so that it is inaccessible when connected to your computer through the USB port. The lock is not due to encryption; it is just a USB lock. Although locked, the drive is still accessible with a Wi-Fi connection. The default is **Off**.

Rebooting and Shutting Down

On the Hardware page, you can reboot or shut down the drive.

1. Click the **Hardware** icon on the navigation bar to display the Hardware screen (shown above).
2. In the Power section, you have two options:
 - To shut down the My Password Wireless drive, click **Shut Down**.
 - To reboot the drive, click **Reboot**.

11

Resetting Your Drive and Password

This chapter includes the following topics:

- [Manually Resetting the Drive](#)
- [Restoring Factory Settings Using the Dashboard](#)

You can perform a system-only reset of your drive two ways: manually and on the dashboard's Admin page. When the drive resets, your data remains but settings such as your password return to default values. You can perform a system and disk reset on the Admin page.

Manually Resetting the Drive

For a system only reset, the battery has to have at least a 25% charge.

1. With the power **ON**, hold down the **Power** and **WPS** buttons at the same time for around 10 seconds until the drive reboots and the Power and Battery Status LED flashes white.
2. Wait until the Wi-Fi LED is blue before reconnecting.

Restoring Factory Settings Using the Dashboard

1. Click the **Admin** icon on the navigation bar to display the Admin screen.

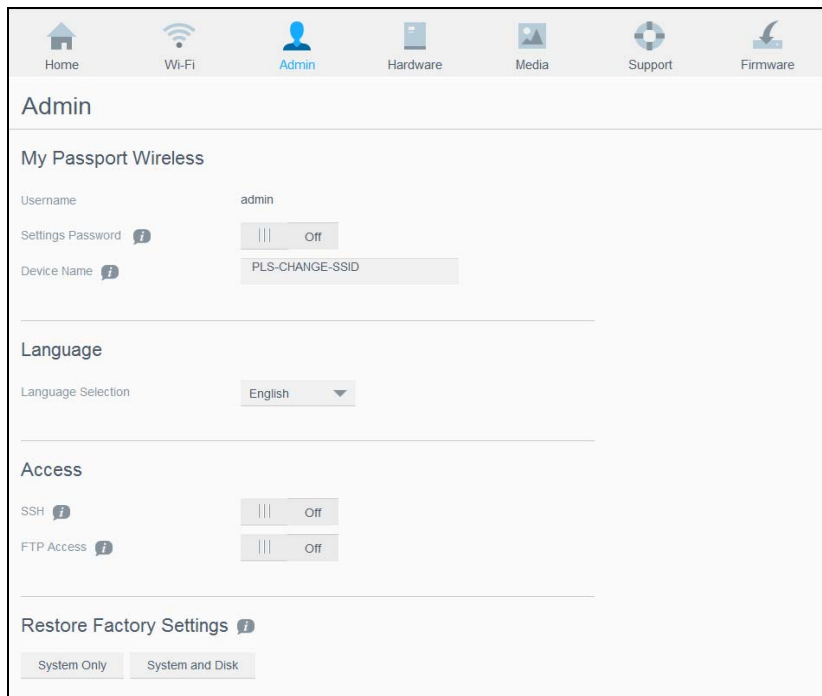

WARNING! Interrupting the factory restore process may damage the My Passport Wireless drive. Wait until after the reboot to use the drive again.

1. In the Restore Factory Settings section, you have the following options:

- **System Only:**

Note: To perform a system and disk restore, the battery level must be at least 25%.

Changes all administrative settings back to their default values, returns the administrator password to none, and renames the drive to MyPassport. Your content remains intact.

- **System and Disk:**

Note: To perform a system and disk restore, the drive must be plugged into AC power and the battery level must be at least 25%.

Reverts all settings to their factory default values and deletes data on the drive. You need to reload all of your data after this type of restore.

2. When the restore is complete, the Reconnect to Network screen displays.

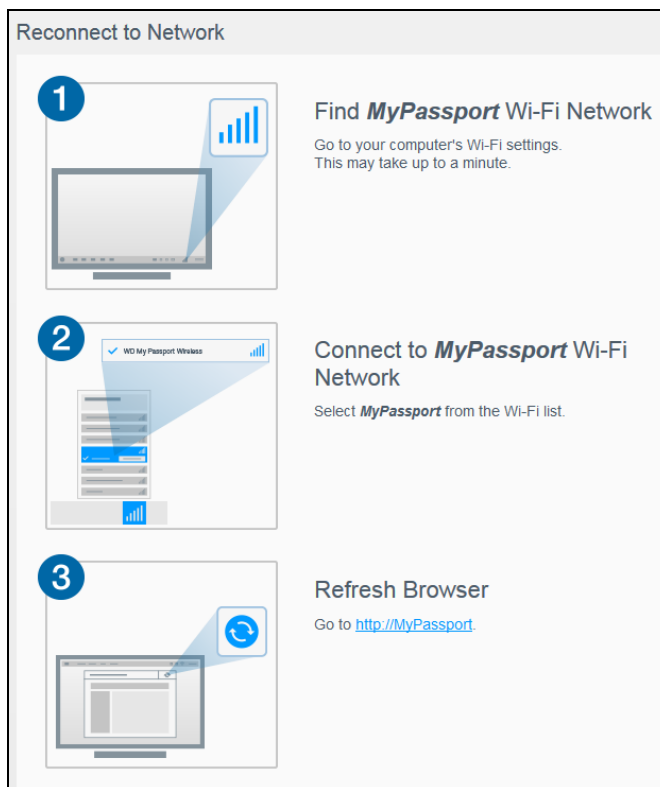

3. When the restore is complete, the Reconnect screen displays.

4. Follow the on-screen instructions to reconnect your drive.

12

Updating Firmware

This chapter includes the following topics

- Updating with Available Firmware
- Performing a Manual Update

The Firmware page allows you to automatically or manually check for an update file and then install it. To check automatically and install an available file, the drive must be connected to the Internet.

1. Click **Firmware** on the navigation bar to display the Firmware page.

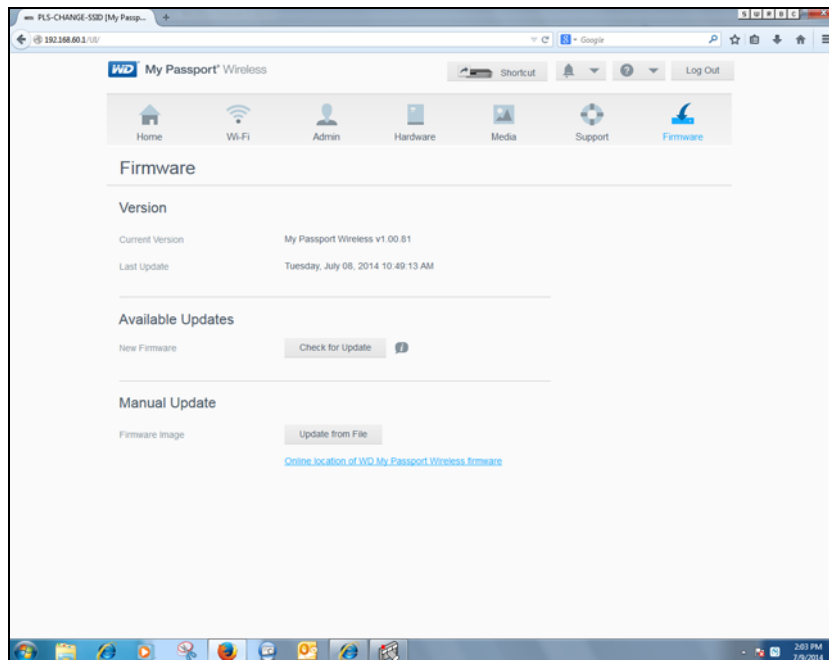

The current version and last update display in the Version section.

WARNING! Do not power off your drive during the installation. When the installation is finished, your drive will automatically reboot.

Important: You can only update if the battery is more than 50 percent charged and the charger is plugged in to power.

Updating with Available Firmware

Note: To look for available updates, **the drive must be connected to the Internet** via a home network or hotspot connection. You can check for available updates at any time in the Available Updates area.

1. Click **Check for Update**.
2. Review the Update Firmware screen that displays.
3. If an update is available, click **Install and Reboot**.
When the update is complete, your drive reboots.

Performing a Manual Update

1. Go to <http://support.wdc.com/product/download.asp> to locate and download an available file to your computer, or click the [Online location of the WD My Passport Wireless](#) firmware link at the bottom of the screen.
2. Download the latest firmware file.
3. Connect to the drive's Wi-Fi network (direct connection).
4. In the Manual Update section, click **Update from File**.
5. Navigate to the firmware update file and click **Open**.
6. Review the confirmation message and click **Install and Reboot**. The update takes about five minutes to install on your drive. It is critical to leave the device on until the installation is complete.

When the update is complete, your drive reboots. Reconnect the wireless link from your computer directly to the drive.

13

Using WD Quick View with the Drive

This chapter includes the following topics:

- [Installing WD Quick View](#)
- [Accessing WD Quick View Shortcut Options](#)

Note: Windows computers support WD Quick View on the My Passport Wireless drive by a USB connection or on your network in home or hotspot mode. Mac computers only support WD Quick View when the My Passport Wireless drive is connected to your network. It does not support WD Quick View when the drive is connected to a Mac computer by a USB.

The My Passport Wireless drive comes with the WD Quick View app. WD Quick View allows you to perform the following functions quickly and efficiently:

- **Open**—Opens the drive's Public folder
- **Dashboard** — Opens the drive's dashboard
- **Learning Center**—Opens the online Learning Center so you can get information and download apps
- **Map**—Maps the drive's Public folder
- **Create Shortcut**—Creates a shortcut to the drive's Public folder
- **Shut Down**—Shuts down the drive. Any backup or file activity is interrupted
- **Alerts**—Displays a list of alerts you have received
- **Properties**—Displays the properties of the drive as a network device
- **WD SmartWare** —Launches WD SmartWare if installed (Windows)
- **Exit WD SmartWare**—Exits WD SmartWare if installed and running

Installing WD Quick View

WD Quick View comes on the drive, and you can also install it from the online Learning Center.

To install it from the drive:

1. Do one of the following:
 - For a Windows PC: In the left pane of the File Explorer window, click **Network > MyPassport > Public > Quick View > setup**.
 - For a Mac computer: In the left pane of the Finder window in the SHARED section, click **MyPassport > Public > QuickView > setup**.

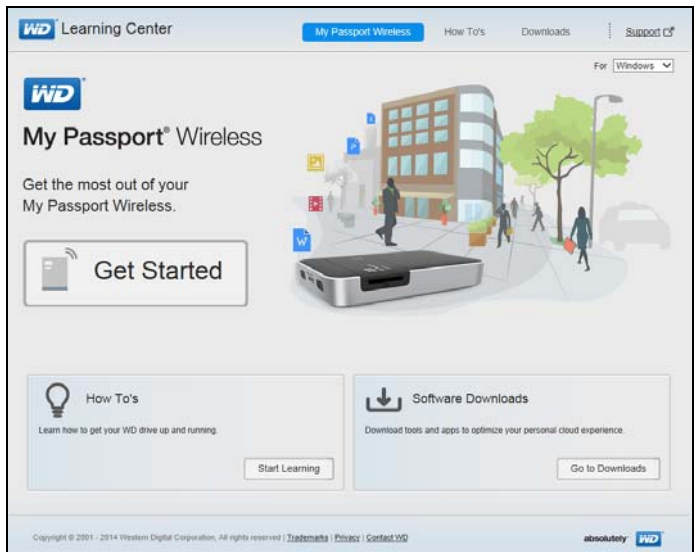

2. Access the online Learning Center Welcome page for My Passport Wireless:
www.wd.com/setup/mypassportwireless:

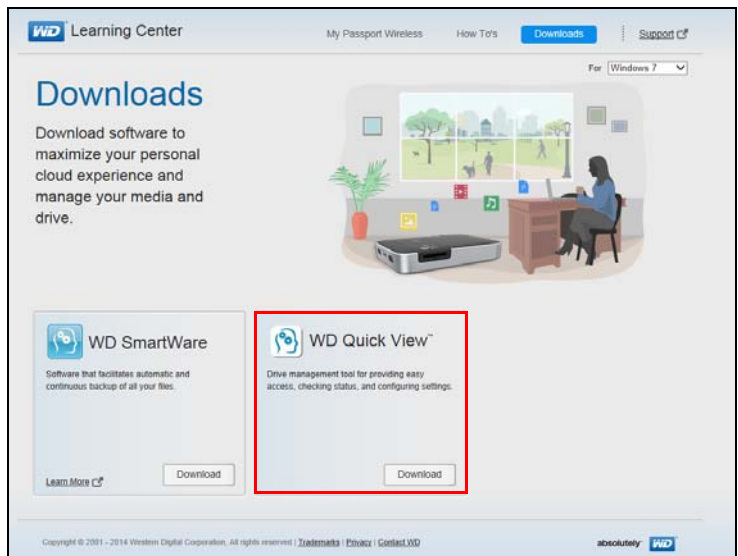

3. Click **Go to Downloads** to display the Downloads page:



4. In the WD Quick View box, click **Download**.

WD Quick View software installs the WD Quick View icon  in the Mac OS X menu bar or the WD Quick View icon  in the Windows task bar so that you can perform important tasks quickly and conveniently.

5. Access your downloaded file, and extract the contents of the zip file to your Mac.
6. Double-click the **WD Quick View Setup** file.
7. Complete the Quick View installer, following the directions on the page.

Accessing WD Quick View Shortcut Options

Windows

1. Right- or left-click the WD Quick View icon  in the system tray to display a menu.
2. Move the pointer over or click to select your My Passport Wireless drive and display a sub-menu

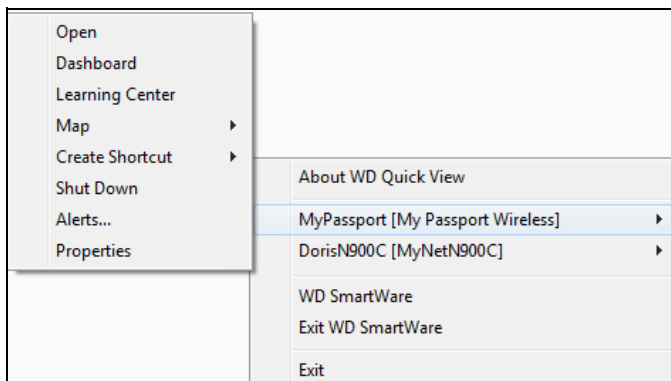

3. Select the desired option.

Mac OS X

Note: The My Passport Wireless drive has to be on the network for the drive to support Quick View.

1. Click the WD Quick View icon  on the menu bar to display a menu.
2. Move the pointer over the name of your My Passport Wireless drive to display a sub-menu:

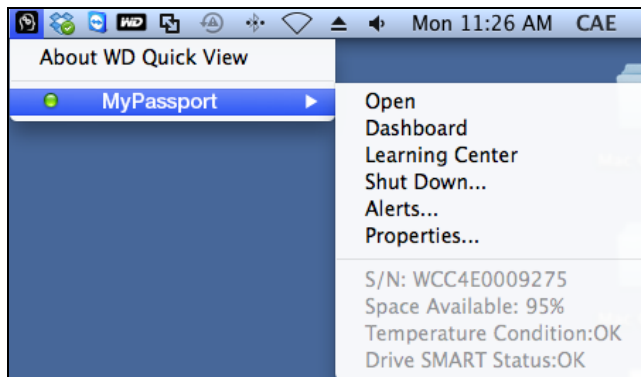

3. Select the desired option.

14

Getting Support

Support Page

The Support page enables you run diagnostic tests and generate system reports to send to Customer Support and gives you the opportunity to join WD's Product Improvement Program.

To display the Support Page, click **Support** on the navigation bar.

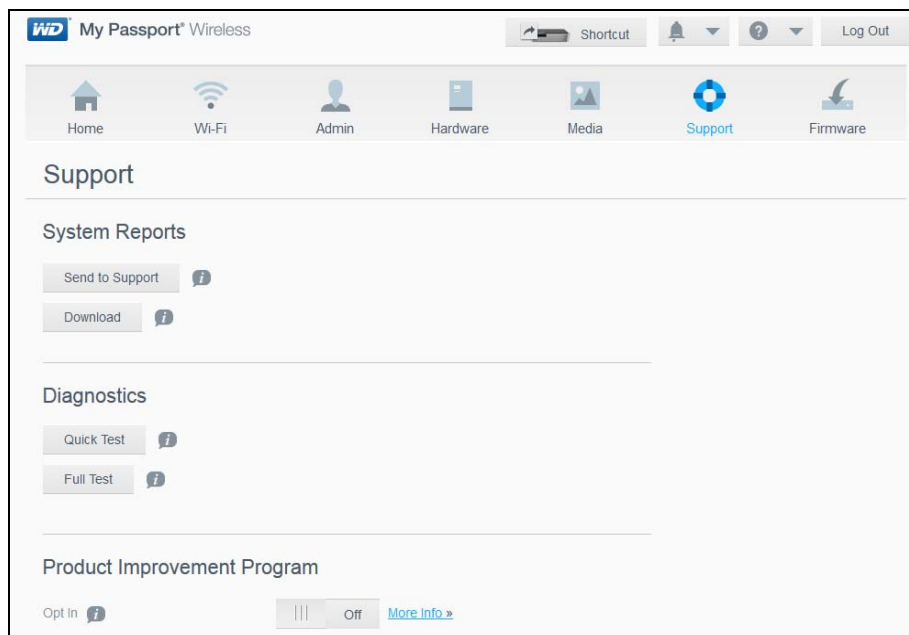

System Reports

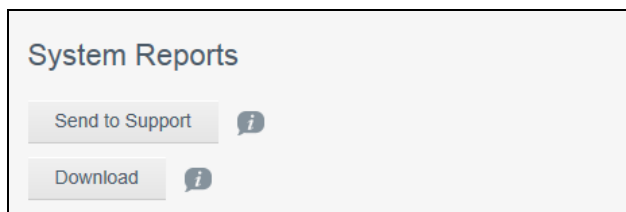

In the System Reports section, you can generate a report and automatically send it to Customer Support or download it to your computer.

Click one of the following:

- **Send to Support:** Generates a diagnostic report and automatically sends it to Customer Support. The report includes your drive's serial number, Mac number, and status information. You must have a hotspot or home (with Internet) connection.
- **Download:** Generates a diagnostic report and saves it to your computer.

Diagnostics

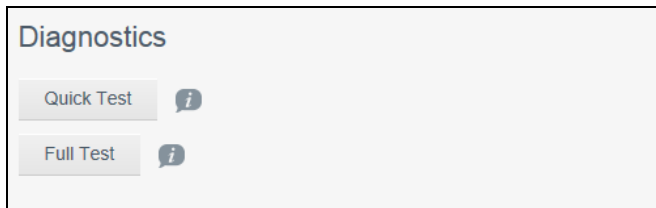

Run diagnostic tests if you are having problems with your drive. There are two types of diagnostic tests:

- **Quick Test:** Checks the hard drive for major performance problems. The result of a quick test is a pass or fail evaluation of the hard drive's condition. The quick test can take several minutes to complete.
- **Full Test:** Is a more comprehensive drive diagnostic. It methodically tests each and every sector of the hard drive. Once the test is performed, the condition of the hard drive displays.

Note: To complete the test, make sure the drive is plugged into AC power.

Product Improvement Program

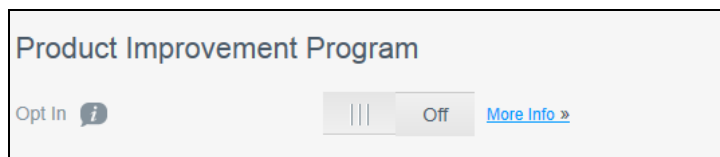

If you join the program, your drive periodically sends its serial number to WD along with basic drive information. The benefit is that you help improve future product updates and enable the Western Digital Support team to help you more efficiently. Participating does not affect your drive's performance.

To join the program, switch the toggle button to **On**.

15

Problems and Solutions

Password

I forgot the Wi-Fi password of my drive.

Reset the drive to its default settings by powering on the drive, pressing the **Power** and **WPS** buttons at the same time for around 10 seconds until the Power LED blinks white.

Once the drive has powered up completely and the Wi-Fi LED turns blue, you can connect to the drive's default wireless name of MyPassport and set up the Wi-Fi password.

Connections

I disconnected the drive from WD My Cloud Mobile app. Do I have to set up the connection to the mobile app next time?

No, as long as you set up the connection previously, and your mobile device is wirelessly connected to the drive.

I took my drive out of range and the connection was lost.

If the drive is configured for home or hotspot mode, when you bring the drive back into range, it will automatically reconnect to the same wireless network. If the drive was configured in direct connection mode, make sure the Wi-Fi LED is blue and your device can reconnect to it.

I want to share content on my drive to other wireless devices in my house.

Connect the drive in home network mode to your home Wi-Fi network. Devices already connected to the drive may automatically connect to your home network (if previously connected to it), or you can manually connect them. Once all the devices are connected to the Wi-Fi network, the drive acts as a wireless NAS device.

When I connect the drive to my computer via USB, the drive won't connect wirelessly to other devices.

When the drive is connected to a computer with a USB connection, wireless capability is turned off.

The wireless speed is slower than normal.

There may be interference in your environment that is conflicting with the drive's Wi-Fi channel or Wi-Fi bandwidth as the drive supports 2.4Ghz band. Interference may come from Wi-Fi devices, microwaves, or other wireless appliances. Advanced users may want to set a different channel on the Settings screen.

I am experiencing the following symptoms:

- **The dashboard's capacity panel is not showing a value even after long time.**
- **When I connect the drive to my computer's USB port, Windows tells me to run scandisk.**
- **My drive does not show any media on my media player.**
- **The Public share is not accessible from a client computer.**

This is most likely because the My Passport Wireless drive was disconnected from the USB port without safe removal. To solve this problem, you can run scandisk from a Windows computer. See Knowledge Base Answer 11742 for more information.

Battery and Performance

My drive is not charging.

- If the drive is connected to your computer with a USB connection, the USB port doesn't provide enough power to charge the battery. Plug the drive into an outlet through the USB power adapter to recharge it.
- If the temperature is too high or too low, the battery will not charge. Allow the unit to cool or warm as necessary.
- If the drive is in use, the battery will not charge.

I want to extend the battery's life.

Switch to Battery Life mode on the Hardware page to extend the battery life of your drive if you do not need the maximum performance. Then reboot the drive for the change to take effect.

My drive keeps turning off its wireless network.

To help save battery life, after a minute of inactivity, the drive automatically turns off the wireless connection and changes into standby mode. Press the **Power** button to re-enable the wireless connection. When the Wi-Fi LED turns blue, the drive is ready for a connection.

I want to get the maximum streaming performance from my drive?

- Set up the drive in Performance mode on the Hardware page to give priority to the streaming performance.
- Connect the drive to a power source to make sure it has enough battery power for streaming.
- Since the drive has Wireless-N with MIMO (2x2) built-in, make sure the wireless network or device you are connecting to supports MIMO.
- Connect directly to the wireless drive in Direct connection mode to avoid any unknown network traffic or interference.

The wireless speed is slower than normal.

- The device may be in Battery Life mode. In this mode, the performance is reduced to extend the battery life.
- The charge on the battery may be too low.
- There may be interference in the drive's Wi-Fi channel or Wi-Fi bandwidth as the drive operates within the 2.4GHz band. Interference may come from Wi-Fi devices, microwaves, or other wireless appliances. Advanced users may want to set a different channel on the Settings screen.
- You may be using clients or networks without a Wireless-N MIMO connection or a slower wireless network (e.g 802.11g or 802.11b).

I can't power on my drive.

Make sure the battery is charged. If left unused a long time, the battery may be too low and require charging before it can be powered on.

Drive Format

Can I reformat this drive to another file system?

Yes, you can reformat it to NTFS, FAT32, and HFS+.

My drive cannot be detected by another device when connected via USB port.

My Passport Wireless is preformatted as an exFAT file system. Some devices (such as computers running Windows XP or WD TV media player) may not support this file system. For more information see Knowledge Base Answer ID 11742.

Appendix A. Technical Specifications

Capacity	500 GB, 1 TB, 2 TB
Wi-Fi protocol	Compliant with 802.11b/g/n (20 MHz band) Receives/transmits in 2.4 GHz band
Supported protocols	SMB, AFP, UPnP, FTP
Interface	USB 3.0 up to 5 Gb/s USB 2.0 up to 480 MB/s SD 2.0 up to 25 MB/s <i>*A USB 3.0 host and USB 3.0 certified cable are required to obtain USB 3.0 performance. USB 3.0 18-inch cable</i>
Compatibility Note: Compatibility may vary depending on user's hardware configuration and operating system.	<p>Operating systems:</p> <ul style="list-style-type: none"> • Windows 8 • Windows 7 • Windows Vista • Mac OS X Mavericks • Mac OS X Mountain Lion • Mac OS X Lion • Mac OS X Snow Leopard <p>Browsers:</p> <ul style="list-style-type: none"> • Internet Explorer 8.0 or higher on supported Windows computers • Safari 6.0 or higher on supported Mac computers • Firefox 21 or higher on supported Windows and Mac computers • Google Chrome 27 or higher on supported Windows and Mac computer <p>DLNA®/UPnP® devices for streaming Internet connection</p>
Physical dimensions	
Width	
500 GB	3.39 in (86 mm)
1 TB	3.39 in (86 mm)
2 TB	3.39 in (86 mm)
Length	
500 GB	3.39 in (86 mm)
1 TB	3.39 in (86 mm)
2 TB	3.39 in (86 mm)
Height	
500 GB	0.86 in (21.8 mm)
1 TB	0.96 in (24.4 mm)
2 TB	1.17 in (29.8 mm)

Weight	
500 GB	0.55 lb (0.25 kg)
1 TB	0.60 lb (0.27 kg)
2 TB	0.77 lb (0.35 kg)
Power supply	
AC input voltage (AC adapter)	Input voltage: 90V to 260 VAC
AC input frequency	Input frequency: 47 to 63 Hz
Temperature	Operating temperature: 0°C to 35°C (32°F to 95°F) Non-operating temperature: -20°C to 60°C (-4.0°F to 140°F)
Humidity	Operating humidity: 10%-80% (non-condensing) Non-operating humidity: 5%-90%
Altitude	Up to 10,000 MSL
Drive format	exFAT
RoHs compliant	Yes

Appendix B. Compatible Media Formats

DLNA File Formats

Audio	<ul style="list-style-type: none"> ▪ MP3, WMA, WAV, LPCM, OGG vorbis ▪ FLAC, M4A, M4B, 3GP, AAC ▪ MP2, AC3, MPA, MP1, AIF
Video	<ul style="list-style-type: none"> ▪ 3GP, 3GP/H.263, 3GP/H.264, 3GP/MPEG-4 ▪ ASF, ASF/WMV ▪ AVI, AVI/DivX, AVI/Full Frame, AVI/MPEG-1, AVI/MPEG-2, AVI/MPEG-4, AVI/WMV, AVI/XviD ▪ DivX, DV ▪ DVR-MS, DVR-MS/AC-3 Audio, DVR-MS/MP1 Audio ▪ FLV ▪ M1V, M2TS, M4P, M4V ▪ MKV, MKV/DivX, MKV/Full Frame, MKV/MPEG-1, MKV/MPEG-2, MKV/MPEG-4, MKV/XviD ▪ MOV, MP4, MPE ▪ MPEG1, MPEG2, MPEG4, MPG, MTS ▪ QT, RM ▪ TS, TS/TP/M2T ▪ VDR, VOB, WMV, Xvid
Image	JPEG, PNG, TIF, BMP

Note: Some devices may not support playback of all these files. Please refer to your device's user manual to see which formats are supported.

Formats Compatible with WD My Cloud App

iOS	
Photo	jpg, png, gif, tiff, bmp
Video	mov, mp4, m4v
Music	mp3, m4a, aiff, wav
Android	
Photo	jpg, png, gif, tiff, bmp
Video	Depends on the third party app used to play video on the mobile device
Music	mp3 (support for m4a, wma, wav and aiff added in release 3.1 - requires Android 4.0 or later)

Note: You can go to the Help/FAQ section on each platform to find the supported types.

Appendix C. Compliance and Warranty Information

This appendix includes the following topics:

- [Regulatory Compliance](#)
- [Battery Safety](#)
- [GNU General Public License \(“GPL”\)](#)

Regulatory Compliance

Federal Communications Commission (FCC) Class B Information

Operation of this device is subject to the following two conditions:

1. This device may not cause harmful interference.
2. This device must accept any interference received, including interference that may cause undesired operation.

This equipment has been tested and found to comply with the limits for a Class B digital device pursuant to Part 15 of the FCC Rules. These limits are designed to provide reasonable protection against harmful interference in a residential installation. This equipment generates, uses, and can radiate radio frequency energy and, if not installed and used in accordance with the manufacturer's instruction manual, may cause interference with radio communications. However, there is no guarantee that interference will not occur in a particular installation. If this equipment does cause harmful interference to radio or television reception, which can be determined by turning the equipment off and on, you are encouraged to try to correct the interference by one or more of the following measures:

- Reorient or relocate the receiving antenna.
- Increase the separation between the equipment and the receiver.
- Connect the equipment into an outlet on a circuit different from that to which the receiver is connected.
- Consult the retailer or an experienced radio/television technician for help.

Any changes or modifications not expressly approved by WD could void the user's authority to operate the equipment.

Note: The country code selection is for non-US models only and is not available for all US models. Per FCC regulations, all Wi-Fi products marketed in the US must have fixed US operation channels only.

Regulatory Information/Disclaimers

Installation and use of this Wireless LAN device must be in strict accordance with the instructions included in the user documentation provided with the product. Any changes or modifications (including the antennas) made to this device that are not expressly approved by the manufacturer may void the user's authority to operate the equipment. The manufacturer is not responsible for any radio or television interference caused by unauthorized modification of this device, or the substitution of the connecting cables and equipment other than manufacturer specified. It is the responsibility of the user to correct any interference caused by such unauthorized modification, substitution or attachment. Manufacturer and its authorized resellers or distributors will assume no liability for any

damage or violation of government regulations arising from failing to comply with these guidelines.

CAUTION: To comply with FCC RF exposure compliance requirements, the antenna used for this transmitter must be installed to provide a separation distance of at least 20cm from all persons and must not be co-located or operating in conjunction with any other antenna or transmitter.

The product complies with the FCC portable RF exposure limit set forth for an uncontrolled environment and is safe for intended operation as described in this manual. Further RF exposure reduction can be achieved if the product can be kept as far as possible from the user's body or set the device to lower output power if such function is available.

Industry Canada (IC)

This device complies with RSS-210 of the Industry Canada Rules. Operation is subject to the following two conditions:

1. this device may not cause interference and
2. this device must accept any interference, including interference that may cause undesired operation of the device

The product complies with the Canada portable RF exposure limit set forth for an uncontrolled environment and is safe for intended operation as described in this manual. Further RF exposure reduction can be achieved by keeping the product as far as possible from the user's body or by setting the device to lower output power if such function is available.

This device has been designed to operate with an antenna having a maximum gain of 2dBi. Antenna having a higher gain is strictly prohibited per regulations of Industry Canada. The required antenna impedance is 50 ohms.

To reduce potential radio interference to other users, the antenna type and its gain should be so chosen that the EIRP is not more than required for successful communication.

IMPORTANT NOTE:

Radiation Exposure Statement:

This equipment complies with IC radiation exposure limits set forth for an uncontrolled environment. This equipment should be installed and operated with minimum distance of 20cm between the radiator & your body.

The product complies with Canada's portable RF exposure limit set forth for an uncontrolled environment and is safe for intended operation as described in this manual. Further RF exposure reduction can be achieved by keeping the product as far as possible from the user or by setting the device to lower output power if such a function is available.

Déclaration d'exposition aux radiations:

Ce dispositif est conforme à la norme CNR-210 d'Industrie Canada applicable aux appareils radio exempts de licence.

Son fonctionnement est sujet aux deux conditions suivantes:

- (1) le dispositif ne doit pas produire de brouillage préjudiciable, et
- (2) ce dispositif doit accepter tout brouillage reçu, y compris un brouillage susceptible de provoquer un fonctionnement indésirable.

Le produit est conforme aux limites d'exposition pour les appareils portables RF pour les Etats-Unis et le Canada établies pour un environnement non contrôlé. Cet équipement doit être installé et utilisé avec un minimum de 20 cm de distance entre la source de rayonnement et votre corps.

Le produit est sûr pour un fonctionnement tel que décrit dans ce manuel. La réduction aux expositions RF peut être augmentée si l'appareil peut être conservé aussi loin que possible du corps de l'utilisateur ou que le dispositif est réglé sur la puissance de sortie la plus faible si une telle fonction est disponible.

CAN ICES-3(B)/NMB-3B Statement

Cet appareil numérique de la classe B est conforme à la norme NMB-3(B) du Canada.

This device complies with Canadian ICES-3(B).

Safety Compliance

Approved for US and Canada. CAN/CSA-C22.2 No. 60950-1, UL 60950-1: Safety of Information Technology Equipment.

Approuvé pour les Etats-Unis et le Canada. CAN/CSA-C22.2 No. 60950-1 : Sûreté d'équipement de technologie de l'information.

This product is intended to be supplied by a listed limited power source, double insulated, or direct plug-in power unit marked "Class 2."

This device is only for use with the compatible UL Listed AC adapter.

Cet appareil n'est destiné qu'à des adaptateurs compatibles marqués "UL Listed."

CE Compliance for Europe

Operation of this device is subjected to the following National regulations and may be prohibited to use if certain restriction should be applied.

Marking by the CE symbol indicates compliance of this system to the applicable Council Directives of the European Union, including the EMC Directives (2004/108/EC), (1999/5/EC), the Low Voltage Directive (2006/95/EC), and EuP Directive (2005/32/EC) and RoHS directive 2011/65/EU. A "Declaration of Conformity" in accordance with the applicable directives has been made and is on file at Western Digital Europe.

Сведения для Таможенного Союза (только для России)

Дата изготовления указана на маркировке оборудования.

(Manufacturing date marked on the equipment.)

Подтверждение соответствия Минкомсвязи России:

Декларация соответствия № Д-РД-xxxx от DD.MM.YYYY года, действительна до DD.MM.YYYY года, зарегистрирована в Федеральном агентстве связи DD.MM.YYYY года

VCCI Statement

この装置は、クラスB情報技術装置です。この装置は、家庭環境で使用することを目的としていますが、この装置がラジオやテレビジョン受信機に近接して使用されると、受信障害を引き起こすことがあります。

取扱説明書に従って正しい取り扱いをして下さい。 VCCI-B

Environmental Compliance (China)

符合电子信息产品污染控制管理办法的有毒有害物质或元素标识表

部件名称	有毒有害物质或元素					
	铅(Pb)	汞(Hg)	镉(Cd)	六价铬(Cr(VI))	多溴联苯(PBB)	多溴二苯醚(PBDE)
ME Plastic 机构塑胶件	○	○	○	○	○	○
ME Metal parts 机构金属件	○	○	○	○	○	○
Rubber 橡胶	○	○	○	○	○	○
PCBA 线路板	X	○	○	○	○	○
Cable 线材	○	○	○	○	○	○

O: 代表此种部件所用的均质材料中所含的该种有毒有害物质均低于 SJ/T 11363-2006 规定的限量。

X: 代表此种部件所用的均质材料中所含的该种有毒有害物质均高于 SJ/T 11363-2006 规定的限量,但是符合 EU ROHS 2011/65/EC指令的豁免条款。

(在此表中, 企业可能需要根据实际情况对标记" X" 的项目进行进一步的技术性解释。)

Battery Safety

This product contains a rechargeable, non-user replaceable lithium-ion battery. The life of the battery depends on the model, usage conditions, and configurations of the product.

Following are some precautions to take for safety and use:

- Dispose of the product properly.
- Do not disassemble the product; there are no user-serviceable parts inside.
- Do not expose the product to water, heat, or fire, and avoid storage in direct sunlight.
- Use only the charger that comes with the product.
- Do not drop or otherwise shock or jar the product.
- If a cell should leak, avoid contact with skin or eyes. If the liquid has made contact, wash thoroughly with water and seek immediate medical advice.
- Do not leave the battery in charging mode for extended period.
- The battery operates best at from 20°C+5 °C.
- Retain the original product literature for future reference.

Warranty Information

Obtaining Service

WD values your business and always attempts to provide you the very best of service. If this Product requires maintenance, either contact the dealer from whom you originally purchased the Product or visit our product support website at <http://support.wd.com> for information on how to obtain service or a Return Material Authorization (RMA). If it is determined that the Product may be defective, you will be given an RMA number and instructions for Product return. An unauthorized return (i.e., one for which an RMA number has not been issued) will be returned to you at your expense. Authorized returns must be shipped in an approved shipping container, prepaid and insured, to the address provided on your return paperwork. Your original box and packaging materials should be kept for storing or shipping your WD product. To conclusively establish the period of warranty, check the warranty expiration (serial number required) via <http://support.wd.com>. WD shall have no liability for lost data regardless of the cause, recovery of lost data, or data contained in any Product placed in its possession.

Limited Warranty

WD warrants that the Product, in the course of its normal use, will for the term defined below, be free from defects in material and workmanship and will conform to WD's specification therefor. The term of your limited warranty depends on the country in which your Product was purchased. The term of your limited warranty is for 2 years in the North, South and Central America region, 2 years in the Europe, the Middle East and Africa region, and 2 years in the Asia Pacific region, unless otherwise required by law. The term of your limited warranty period shall commence on the purchase date appearing on your purchase receipt. WD shall have no liability for any Product returned if WD determines that the Product was stolen from WD or that the asserted defect a) is not present, b) cannot reasonably be rectified because of damage occurring before WD receives the Product, or c) is attributable to misuse, improper installation, alteration (including removing or obliterating labels and opening or removing external enclosures, unless the product is on the list of limited user-serviceable products and the specific alteration is within the scope of the applicable instructions, as found at <http://support.wd.com>), accident or mishandling while in the possession of someone other than WD. Subject to the limitations specified above, your sole and exclusive warranty shall be, during the period of warranty specified above and at WD's option, the repair or replacement of the Product.

The foregoing limited warranty is WD's sole warranty and is applicable only to products sold as new. The remedies provided herein are in lieu of a) any and all other remedies and warranties, whether expressed, implied or statutory, including but not limited to, any implied warranty of merchantability or fitness for a particular purpose, and b) any and all obligations and liabilities of WD for damages including, but not limited to accidental, consequential, or special damages, or any financial loss, lost profits or expenses, or lost data arising out of or in connection with the purchase, use, or performance of the Product, even if WD has been advised of the possibility of such damages. In the United States, some states do not allow exclusion or limitations of incidental or consequential damages, so the limitations above may not apply to you. This warranty gives you specific legal rights, and you may also have other rights which vary from state to state.

GNU General Public License (“GPL”)

Firmware incorporated into this product may include third party copyrighted software licensed under the GPL or Lesser General Public License (“LGPL”) (collectively, “GPL Software”) and not Western Digital’s End User License Agreement. In accordance with the GPL, if applicable: 1) the source code for the GPL Software may be downloaded at no charge from <http://support.wd.com/download/gpl> or obtained on CD for a nominal charge from <http://support.wd.com/download/gpl> or by calling Customer Support within three years of the date of purchase; 2) you may re-use, re-distribute, and modify the GPL Software; 3) with respect solely to the GPL Software, no warranty is provided, to the extent permitted by applicable law; and 4) a copy of the GPL is included herewith, may be obtained at <http://www.gnu.org>, and may also be found at <http://support.wd.com/download/gpl>.

Modification of or tampering with the Software, including but not limited to any Open Source Software, is solely at your own risk. Western Digital is not responsible for any such modification or tampering. Western Digital will not support any product in which you have or have attempted to modify the Software supplied by Western Digital.

Information furnished by WD is believed to be accurate and reliable; however, no responsibility is assumed by WD for its use nor for any infringement of patents or other rights of third parties which may result from its use. No license is granted by implication or otherwise under any patent or patent rights of WD. WD reserves the right to change specifications at any time without notice.

Western Digital, WD, the WD logo, and My Passport are registered trademarks of Western Digital Technologies, Inc. in the U.S. and other countries; WD Drive Utilities and Data Lifeguard are trademarks of Western Digital Technologies, Inc. in the U.S. and other countries. Apple, Mac, OS X, and Time Machine are trademarks of Apple, Inc., registered in the U.S. and other countries. Thunderbolt and the Thunderbolt logo are trademarks of Intel Corporation in the U.S. and/or other countries. Other marks may be mentioned herein that belong to other companies. Picture shown may vary from actual product.

© 2014 Western Digital Technologies, Inc. All rights reserved.

Western Digital
3355 Michelson Drive, Suite 100
Irvine, California 92612 U.S.A.

4779-705118-A00 JUL 2014