

MICROWAVE HOOD COMBINATION

Use & Care Guide

For questions about features, operation/performance, parts, accessories or service, call: 1-800-253-1301.

or visit our website at...
www.estateappliances.com

Table of Contents.....	2
------------------------	---

Model TMH16XS
Model TMH16

TABLE OF CONTENTS

MICROWAVE HOOD COMBINATION SAFETY	3
Electrical Requirements	4
PARTS AND FEATURES.....	5
Turntable	5
MICROWAVE OVEN CONTROL.....	5
Display	5
Start	6
Off Cancel.....	6
Add 1 Minute.....	6
Clock	6
Tones.....	6
Timer.....	6
Control Lock.....	6
Vent Fan	7
Cooktop Light.....	7
Demo Mode.....	7
MICROWAVE OVEN USE	7
Food Characteristics	7
Cooking Guidelines	8
Cookware and Dinnerware	8
Aluminum Foil and Metal	8
Microwave Cooking Power.....	9
Manual Cooking	9
Cooking in Stages (or steps).....	9
Doneness	10
Popcorn.....	10
Baked Potato	10
Preset Cooking.....	10
Reheating	11
Defrosting	11
MICROWAVE OVEN CARE.....	12
General Cleaning.....	12
Replacing Filters.....	12
Replacing Cooktop Light	13
Replacing Microwave Oven Light.....	13
TROUBLESHOOTING	14
ASSISTANCE OR SERVICE.....	15
Replacement Parts.....	15
WARRANTY	16

MICROWAVE HOOD COMBINATION SAFETY

Your safety and the safety of others are very important.

We have provided many important safety messages in this manual and on your appliance. Always read and obey all safety messages.



This is the safety alert symbol.

This symbol alerts you to potential hazards that can kill or hurt you and others.

All safety messages will follow the safety alert symbol and either the word “DANGER” or “WARNING.”

These words mean:

⚠ DANGER

You can be killed or seriously injured if you don't immediately follow instructions.

⚠ WARNING

You can be killed or seriously injured if you don't follow instructions.

All safety messages will tell you what the potential hazard is, tell you how to reduce the chance of injury, and tell you what can happen if the instructions are not followed.

IMPORTANT SAFETY INSTRUCTIONS

When using electrical appliances basic safety precautions should be followed, including the following:

WARNING: To reduce the risk of burns, electric shock, fire, injury to persons, or exposure to excessive microwave energy:

- Read all instructions before using the microwave oven.
- Read and follow the specific “PRECAUTIONS TO AVOID POSSIBLE EXPOSURE TO EXCESSIVE MICROWAVE ENERGY” found in this section.
- The microwave oven must be grounded. Connect only to properly grounded outlet. See “GROUNDING INSTRUCTIONS” found in this section and in the provided Installation Instructions.
- Install or locate the microwave oven only in accordance with the provided Installation Instructions.
- Some products such as whole eggs in the shell and sealed containers – for example, closed glass jars – are able to explode and should not be heated in the microwave oven.
- Use the microwave oven only for its intended use as described in this manual. Do not use corrosive chemicals or vapors in the microwave oven. This type of oven is specifically designed to heat, cook, or dry food. It is not designed for industrial or laboratory use.
- As with any appliance, close supervision is necessary when used by children.
- Do not operate the microwave oven if it has a damaged cord or plug, if it is not working properly, or if it has been damaged or dropped.
- The microwave oven should be serviced only by qualified service personnel. Call an authorized service company for examination, repair, or adjustment.
- See door surface cleaning instructions in the “Microwave Oven Care” section.
- To reduce the risk of fire in the oven cavity:
 - Do not overcook food. Carefully attend the microwave oven when paper, plastic, or other combustible materials are placed inside the oven to facilitate cooking.
 - Remove wire twist-ties from paper or plastic bags before placing bags in oven.
 - If materials inside the oven ignite, keep oven door closed, turn oven off, and disconnect the power cord, or shut off power at the fuse or circuit breaker panel.
 - Do not use the cavity for storage purposes. Do not leave paper products, cooking utensils, or food in the cavity when not in use.
- Liquids, such as water, coffee, or tea are able to be overheated beyond the boiling point without appearing to be boiling. Visible bubbling or boiling when the container is removed from the microwave oven is not always present. **THIS COULD RESULT IN VERY HOT LIQUIDS SUDDENLY BOILING OVER WHEN THE CONTAINER IS DISTURBED OR A SPOON OR OTHER UTENSIL IS INSERTED INTO THE LIQUID.**
 - To reduce the risk of injury to persons:
 - Do not overheat the liquid.
 - Stir the liquid both before and halfway through heating it.
 - Do not use straight-sided containers with narrow necks.
 - After heating, allow the container to stand in the microwave oven for a short time before removing the container.
 - Use extreme care when inserting a spoon or other utensil into the container.
- Oversized foods or oversized metal utensils should not be inserted in the microwave oven as they may create a fire or risk of electric shock.
- Do not clean with metal scouring pads. Pieces can burn off the pad and touch electrical parts involving a risk of electric shock.

SAVE THESE INSTRUCTIONS

IMPORTANT SAFETY INSTRUCTIONS

- Suitable for use above both gas and electric cooking equipment.
- Intended to be used above ranges with maximum width of 36" (91.44 cm).
- Clean Ventilating Hoods Frequently - Grease should not be allowed to accumulate on hood or filter.
- Do not use paper products when appliance is operated in the "PAN BROWN" mode (on models with this feature).
- Do not store any materials, other than manufacturer's recommended accessories, in this oven when not in use.
- Do not store anything directly on top of the microwave oven when the microwave oven is in operation.
- When flambeing foods under the hood, turn the fan on.
- Use care when cleaning the vent-hood filter. Corrosive cleaning agents, such as lye-based oven cleaners, may damage the filter.
- Do not cover or block any openings on the microwave oven.
- Do not store this microwave oven outdoors. Do not use the microwave oven near water - for example, near a kitchen sink, in a wet basement, or near a swimming pool, or similar locations.
- Do not immerse cord or plug in water.
- Keep cord away from heated surfaces.
- Do not let cord hang over edge of table or counter.
- Do not mount over a sink.
- Do not cover racks or any other part of the oven with metal foil. This will cause overheating of the oven.

SAVE THESE INSTRUCTIONS

PRECAUTIONS TO AVOID POSSIBLE EXPOSURE TO EXCESSIVE MICROWAVE ENERGY

- (a) Do not attempt to operate this oven with the door open since open-door operation can result in harmful exposure to microwave energy. It is important not to defeat or tamper with the safety interlocks.
- (b) Do not place any object between the oven front face and the door or allow soil or cleaner residue to accumulate on sealing surfaces.
- (c) Do not operate the oven if it is damaged. It is particularly important that the oven door close properly and that there is no damage to the:
 - (1) Door (bent),
 - (2) Hinges and latches (broken or loosened),
 - (3) Door seals and sealing surfaces.
- (d) The oven should not be adjusted or repaired by anyone except properly qualified service personnel.

Electrical Requirements

⚠ WARNING



Electrical Shock Hazard

- Plug into a grounded 3 prong outlet.**
- Do not remove ground prong.**
- Do not use an adapter.**
- Do not use an extension cord.**
- Failure to follow these instructions can result in death, fire, or electrical shock.**

Observe all governing codes and ordinances.

Required:

- A 120 Volt, 60 Hz, AC only, 15- or 20-amp electrical supply with a fuse or circuit breaker.

Recommended:

- A time-delay fuse or time-delay circuit breaker.
- A separate circuit serving only this appliance.

GROUNDING INSTRUCTIONS

- **For all cord connected appliances:**
The microwave oven must be grounded. In the event of an electrical short circuit, grounding reduces the risk of electric shock by providing an escape wire for the electric current. The microwave oven is equipped with a cord having a grounding wire with a grounding plug. The plug must be plugged into an outlet that is properly installed and grounded.

WARNING: Improper use of the grounding plug can result in a risk of electric shock. Consult a qualified electrician or serviceman if the grounding instructions are not completely understood, or if doubt exists as to whether the microwave oven is properly grounded.

Do not use an extension cord. If the power supply cord is too short, have a qualified electrician or serviceman install an outlet near the microwave oven.

SAVE THESE INSTRUCTIONS

This device complies with Part 18 of the FCC Rules.

PARTS AND FEATURES

This manual may cover several different models. The model you have purchased may have some or all of the features shown here. The appearance of your particular model may differ slightly from the illustrations in this manual.

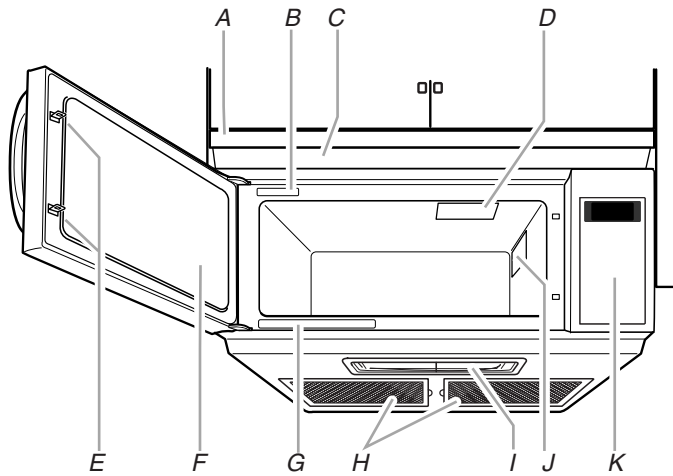

- A. Vent grille
 - B. Model and serial number plate
 - C. Charcoal filter (behind vent grille)
 - D. Microwave oven light
 - E. Door lock system
 - F. Metal shielded window
 - G. Cooking guide label
 - H. Grease filters (shipped in microwave oven cavity)
 - I. Cooktop light
 - J. Microwave inlet cover
 - K. Control panel
- Parts and Features not shown**
Turntable

Turntable

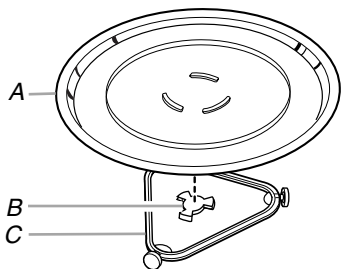

- A. Turntable
- B. Hub
- C. Support

The turntable can rotate in either direction to help cook food more evenly. Do not operate the microwave oven without having the turntable in place. See "Assistance or Service" to reorder any of the parts.

To Install:

1. Remove tape from the hub.
2. Place the support on the microwave oven cavity bottom.
3. Place the turntable on the support.

Fit the raised, curved lines in the center of the turntable bottom between the three spokes of the hub. The rollers on the support should fit inside the turntable bottom ridge.

MICROWAVE OVEN CONTROL

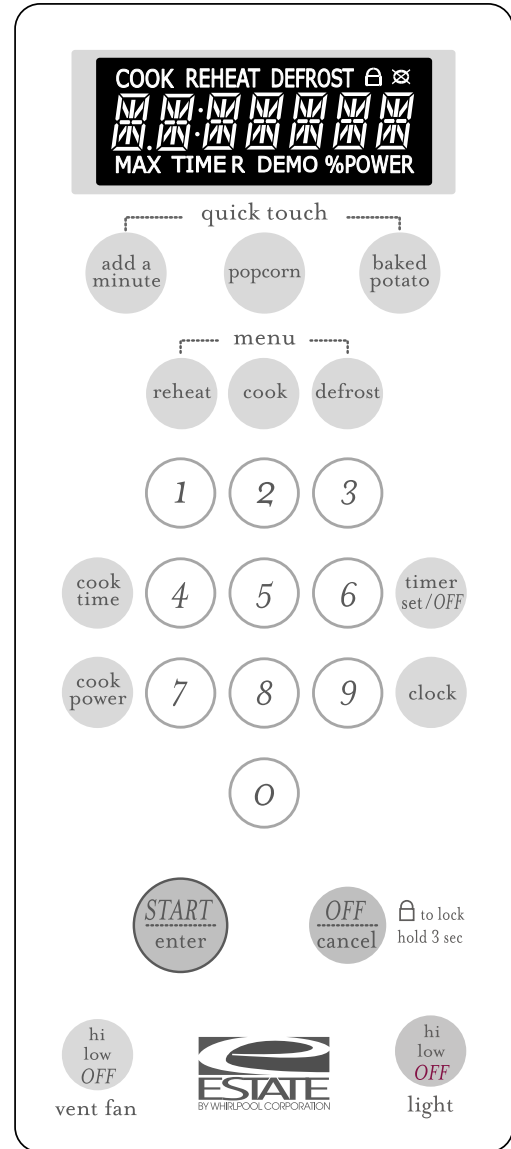

Display

When power is first supplied to the microwave oven, a ":" will blink in the display. Touch OFF CANCEL to stop the blinking. If the ":" blinks in the display at any other time, a power failure has occurred. Touch OFF CANCEL and reset the clock if needed.

If an invalid value has been entered, the invalid entry tones will sound, and the input prompt will reappear in the display. Retry your entry.

When the microwave oven is in use, the display shows cooking power, quantities, weights and/or prompts. When the microwave oven is not in use (standby mode), the display shows the time of day or Timer countdown.

The speed of the scrolling text may be adjusted, if necessary.

To Adjust Scroll Speed:

1. Touch and hold CLOCK for 3 seconds until 2 tones sound.
2. Touch number pad "1" for SLOW, "2" for NORMAL or "3" for FAST.
3. Touch START to complete the adjustment.

Start

The START pad begins any function. If it is not touched within 5 seconds after touching a pad, "PRESS START" will scroll in the display as a reminder. If START pad is not touched within 2 minutes after touching a pad, the display will return to the time of day mode and the programmed function will be canceled.

If cooking is interrupted by opening the door, touching START will resume the preset cycle.

Off Cancel

The OFF CANCEL pad stops most functions except for the Control Lock and Demo Mode.

The microwave oven will also turn off when the door is opened. Close the door and touch START to resume the cycle.

Add 1 Minute

The ADD 1 MINUTE control automatically starts the microwave oven at 100% power for 1 minute, and adds 1 minute of cook time, up to 10 minutes, with each additional touch of the control.

Touching ADD 1 MINUTE during a manual cook cycle will add 1 minute of cook time at the current cook power.

Clock

This is a standard 12-hour clock (12:00-11:59) and does not show a.m. or p.m.

To Set:

The microwave oven and timer must be off.

1. Touch CLOCK.
2. Touch the number pads to set the time of day.
3. Touch CLOCK or START.

To Remove:

1. Touch CLOCK.
2. Touch 0.
3. Touch CLOCK.

The time will disappear, and ":" will appear on the display.

Tones

Tones are audible signals, indicating the following:

One tone

- Valid entry (short tone)
- End of timer countdown

Two tones

- End of stage in multistage cooking
- Control Lock active
- Hidden feature has been entered or exited
- Reminder, repeat each minute after the end-of-cycle tones

Three tones

- Invalid entry

Four tones

- End of cycle

To Turn Off/On Valid Entry Tones: With the microwave oven in standby mode, touch and hold the number pad "1" for 3 seconds until 2 tones sound. Touch and hold number pad "1" to turn tones back on.

To Turn Off All Tones (except end-of-timer and hidden feature tones): With the microwave oven in standby mode, touch and hold the number pad "2" for 3 seconds until 2 tones sound. Touch and hold number pad "2" to turn tones back on.

Timer

The Timer can be set in minutes and seconds, up to 90 minutes, and counts down the set time.

NOTE: The Timer does not start or stop the microwave oven.

While the Timer is in use, the microwave oven can also operate. To see the countdown for 10 seconds while the microwave oven is in use, touch TIMER SET/OFF.

To Set:

1. Touch TIMER SET/OFF.

The TIMER icon will appear in the display.

"ENTER TIME IN MIN AND SEC" will scroll in the display. If no action is taken after 2 minutes, the display will return to the time of day mode.

2. Touch the number pads to set the length of time.
3. Touch TIMER SET/OFF or START.

When the set time ends, "END TIMER" will appear in the display, and the end-of-timer tone will sound, followed by reminder tones.

Remember, touching OFF CANCEL while a cook function is active in the display will cancel the cook function, not the Timer.

4. Touch TIMER SET/OFF or OFF CANCEL to cancel the Timer when only the Timer is operating.

Touch TIMER SET/OFF when a cook function is also operating to make the Timer countdown active in the display, and then touch OFF CANCEL to cancel the Timer. The cook function will continue to operate.

Control Lock

The Control Lock shuts down the control panel pads to avoid unintended use of the microwave oven.

When the control is locked, only the Vent Fan and Light pads will function. If any other control pad is touched, "LOCKED" will appear in the display and the invalid entry tones will sound.

To Lock/Unlock Control: The microwave oven must be in standby mode. Touch and hold OFF CANCEL for 3 seconds until 2 tones sound and a padlock icon appears in the display. Repeat to unlock and remove the padlock icon from display.

Vent Fan

The vent (exhaust) fan has 2 speeds: high and low.

To protect the microwave oven, if the temperature from the range or cooktop below the microwave oven gets too hot, the vent fan will automatically turn on at high speed. It may stay on for up to 1 hour to cool the microwave oven. When this occurs, the vent fan cannot be turned off. If the vent fan pad is touched during automatic fan operation, "AUTO FAN IS ON, FAN SPEED WILL REMAIN ON UNTIL HEAT IS NO LONGER SENSED" will scroll in the display as a reminder.

The vent fan is also the cooling fan, and will start at low speed when any cooking function begins. It will remain on until the cooking function ends.

To Turn Vent Fan On/Off: Touch VENT FAN pad once for high, twice for low or 3 times for off.

Cooktop Light

The cooktop light has 3 settings: high, low and off.

To Turn Light On/Off: Touch LIGHT pad once for high, twice for low or 3 times for off.

Demo Mode

The Demo Mode is ideal for learning how to use the microwave oven. When set, functions can be entered without actually turning on the microwave generator (magnetron). The microwave oven light will come on, the fan will run, and the turntable will rotate (if set on).

The DEMO icon will appear in the display while the microwave oven is off, and will flash during any function. After 5 minutes of inactivity, a reminder message will scroll in the display when any control pad is touched.

To Turn On/Off: The microwave oven must be in standby mode. Touch and hold the number pad "3" for 3 seconds until 2 tones sound and the DEMO icon appears in the display. Repeat to turn off and remove the DEMO icon from the display.

MICROWAVE OVEN USE

A magnetron in the oven produces microwaves which reflect off the metal floor, walls and ceiling and pass through the turntable and appropriate cookware to the food. Microwaves are attracted to and absorbed by fat, sugar and water molecules in the food, causing them to move, producing friction and heat which cooks the food.

- Do not lean on or allow children to swing on the microwave oven door.
- Do not operate microwave oven when it is empty.
- The turntable must be in place and correct side up when microwave oven is in use. Do not use if turntable is chipped or broken. See "Assistance or Service" section to reorder.
- Baby bottles and baby food jars should not be heated in microwave oven.
- Clothes, flowers, fruit, herbs, wood, gourds, paper, including brown paper bags and newspaper, should not be dried in microwave oven.
- Do not use the microwave oven for canning, sterilizing or deep frying.
- Paraffin wax will not melt in the microwave oven because it does not absorb microwaves.
- Use oven mitts or pot holders when removing containers from microwave oven.
- Do not overcook potatoes. At the end of the recommended cook time, potatoes should be slightly firm. Let potatoes stand for 5 minutes. They will finish cooking while standing.
- Do not cook or reheat whole eggs inside the shell. Steam buildup in whole eggs may cause them to burst. Cover poached eggs and allow a standing time.

Food Characteristics

When microwave cooking, the amount, size and shape, starting temperature, composition and density of the food affect cooking results.

Amount of Food

The more food heated at once, the longer the cook time needed. Check for doneness and add small increments of time if necessary.

Size and Shape

Smaller pieces of food will cook more quickly than larger pieces, and uniformly shaped foods cook more evenly than irregularly shaped food.

Starting Temperature

Room temperature foods will heat faster than refrigerated foods, and refrigerated foods will heat faster than frozen foods.

Composition and Density

Foods high in fat and sugar will reach a higher temperature, and will heat faster than other foods. Heavy, dense foods, such as meat and potatoes, require a longer cook time than the same size of a light, porous food, such as cake.

Cooking Guidelines

Covering

Covering food helps retain moisture, shorten cook time and reduce spattering. Use the lid supplied with cookware. If a lid is not available, wax paper, paper towels or plastic wrap approved for microwave ovens may be used. Plastic wrap should be turned back at one corner to provide an opening to vent steam.

Condensation on the door and cavity surfaces is normal during heavy cooking.

Stirring and Turning

Stirring and turning redistribute heat evenly to avoid overcooking the outer edges of food. Stir from outside to center. If possible, turn food over from bottom to top.

Arranging

If heating irregularly shaped or different sized foods, arrange the thinner parts and smaller sized items toward the center. If cooking several items of the same size and shape, place them in a ring pattern, leaving the center of the ring empty.

Piercing

Before heating, use a fork or small knife to pierce or prick foods that have a skin or membrane, such as potatoes, egg yolks, chicken livers, hot dogs, and sausage. Prick in several places to allow steam to vent.

Shielding

Use small, flat pieces of aluminum foil to shield the thin pieces of irregularly shaped foods, bones and foods such as chicken wings, leg tips and fish tail. See "Aluminum Foil and Metal" first.

Standing Time

Food will continue to cook by the natural conduction of heat even after the microwave cooking cycle ends. The length of standing time depends on the volume and density of the food.

Cookware and Dinnerware

Cookware and dinnerware must fit on the turntable. Always use oven mitts or pot holders when handling because any dish may become hot from heat transferred from the food. Do not use cookware and dinnerware with gold or silver trim. Use the following chart as a guide, then test before using.

MATERIAL	RECOMMENDATIONS
Aluminum Foil, Metal	See "Aluminum Foil and Metal" section.
Browning Dish	Bottom must be at least 3/16" (5 mm) above the turntable. Follow manufacturer's recommendations.
Ceramic Glass, Glass	Acceptable for use.
China, Earthenware	Follow manufacturer's recommendations.
Melamine	Follow manufacturer's recommendations.
Paper: Towels, Dinnerware, Napkins	Use nonrecycled and those approved by the manufacturer for microwave oven use.
Plastic: Wraps, Bags, Covers, Dinnerware, Containers	Use those approved by the manufacturer for microwave oven use.
Pottery and Clay	Follow manufacturer's recommendations.
Silicone Bakeware	Follow manufacturer's recommendations.
Straw, Wicker, Wooden Containers	Do not use in microwave oven.
Styrofoam [†]	Do not use in microwave oven.
Wax Paper	Acceptable for use.

To Test Cookware or Dinnerware for Microwave Use:

1. Place cookware or dinnerware in microwave oven with 1 cup (250 mL) of water beside it.
2. Cook at 100% cooking power for 1 minute.

Do not use cookware or dinnerware if it becomes hot and the water stays cool.

Aluminum Foil and Metal

Always use oven mitts or pot holders when removing dishes from the microwave oven.

Aluminum foil and some metal can be used in the microwave oven. If not used properly, arcing (a blue flash of light) can occur and cause damage to the microwave oven.

OK for Use

Racks and bakeware supplied with the microwave oven (on some models), aluminum foil for shielding, and approved meat thermometers may be used with the following guidelines:

- Do not allow aluminum foil or metal to touch the inside cavity walls, ceiling or floor.

[†]STYROFOAM is a Registered Trademark of The Dow Chemical Company.

- Always use the turntable.
- Do not allow contact with another metal object during microwave cooking.

Manual Cooking

Do Not Use

Metal cookware and bakeware, gold, silver, pewter, non-approved meat thermometers, skewers, twist ties, foil liners such as sandwich wrappers, staples and objects with gold or silver trim or a metallic glaze should not be used in the microwave oven.

Microwave Cooking Power

Many recipes for microwave cooking specify which cooking power to use by percent or name. For example, 70%=Medium-High.

Use the following chart as a general guide for the suggested cooking power of specific foods.

PERCENT/NAME	USE
100%, High (default setting)	Quick heating convenience foods and foods with high water content, such as soups, beverages and most vegetables.
90%	Cooking small, tender pieces of meat, ground meat, poultry pieces and fish fillets. Heating cream soups.
80%	Heating rice, pasta or casseroles. Cooking and heating foods that need a cook power lower than high. For example, whole fish and meat loaf.
70%, Medium-High	Reheating a single serving of food.
60%	Cooking sensitive foods such as cheese and egg dishes, pudding and custards. Cooking non-stirring casseroles, such as lasagna.
50%, Medium	Cooking ham, whole poultry and pot roasts. Simmering stews.
40%	Melting chocolate. Heating bread, rolls and pastries.
30%, Medium-Low, Defrost	Defrosting bread, fish, meats, poultry and precooked foods.
20%	Softening butter, cheese, and ice cream.
10%, Low	Taking chill out of fruit.

To Use:

1. Place food on the turntable and close the door.
2. Touch COOK TIME, then enter a length of time to cook.
If cooking with 100% power, skip Step 3.
3. Touch COOK POWER, then enter the desired power level using the appropriate number pad
or
Touch COOK POWER repeatedly to select the desired power level. See "Microwave Cooking Power" chart.
4. Touch START.
The display will count down the cook time.
When the cycle ends, "END" will appear in the display, and the end-of-cycle tones will sound, followed by reminder tones.
5. Touch OFF CANCEL or open the door to clear the display and/or stop reminder tones.

The cook time and power may be changed after touching START without interrupting cooking.

To Change Cook Time: Touch COOK TIME. The countdown will freeze for a few seconds. Enter the new cook time and touch START or wait a few seconds for the countdown to resume.

To Change Cook Power: Touch COOK POWER repeatedly to scroll through the cook power levels. Touch START.

Cooking in Stages (or steps)

The microwave oven can be set for manual cooking at different cooking powers for various lengths of time, up to 2 stages.

To Cook in Stages:

1. Place food on the turntable and close the door.
2. Touch COOK TIME, then enter length of time to cook for the first stage.
If cooking with 100% power, skip Step 3.
3. Touch COOK POWER, then enter the desired power level for the first stage. See "Microwave Cooking Power" chart.
4. Repeat steps 2 and 3 for the second stage.
5. Touch START.
The display will count down each of the cook times. The display will switch briefly to "STEP 1" or "STEP 2" every 30 seconds during their respective stages.
When the cycle ends, "END" will appear in the display, and the end-of-cycle tones will sound, followed by reminder tones.
6. Touch OFF CANCEL or open the door to clear the display and/or stop reminder tones.

The cook time and cooking power of the operating stage can be changed after touching START without interrupting cooking.

To Change Cook Time: Touch COOK TIME. The countdown will freeze for a few seconds. Enter the new cook time and touch START or wait a few seconds for the countdown to resume.

To Change Cook Power: Touch COOK POWER repeatedly to scroll through the cook power levels. Touch START.

Doneness

Doneness may be adjusted to more done, less done, or back to normal doneness (default) for all automatic cooking functions except Popcorn. During programming, before touching START, touch COOK TIME once for MORE, twice for LESS or 3 times for NORMAL.

Popcorn

Popping time has been preset based on commercially packaged microwave popcorn. The preset programs are for bag sizes 3.5 oz (99 g), 3.0 oz (85 g) and 1.75 oz (50 g). For bag sizes not listed in this section, follow directions on the package.

NOTE: The Popcorn times are programmed to run 15 seconds longer than the actual pop time. During this 15-second period, the magnetron is off, and the microwave oven is cooling. This allows the microwave oven to pop another bag of popcorn immediately following the cycle.

- Do not use regular paper bags or glassware.
- Pop only one package of popcorn at a time.
- Follow manufacturer's instructions when using a microwave popcorn popper.
- Do not try to pop unpopped kernels.
- Use fresh bags of popcorn for optimal results.
- Cooking results may vary by brand and fat content.
- If popcorn volume is less than expected, try placing a microwave-safe dish upside down on the turntable, placing a fresh popcorn bag on the dish, and then starting the cycle.

To Use POPCORN:

1. Place popcorn bag on the turntable, and close the door.
 2. Touch POPCORN.
Bag size selections will scroll across the display.
 3. Enter the bag size, in ounces, using the number pads (invalid numbers will not be accepted)
or
 4. Touch POPCORN repeatedly to scroll through the bag size selections.
 5. Touch START.
The display will count down the popping time.

When the popcorn cycle ends, "END" will appear in the display, and the end-of-cycle tones will sound, followed by reminder tones.
 6. Touch OFF CANCEL or open the door to clear the display and/or stop reminder tones.
-

Baked Potato

One to four 10 oz (283 g) potatoes may be baked automatically in the microwave oven by using the Baked Potato function.

- Pierce each potato several times with a fork before baking.
- Place a single potato on the turntable, off to the side (not centered). Place 2, 3 or 4 potatoes on the turntable around the edges, at least 1" (2.5 cm) apart.
- Let potato(es) stand for 5 minutes after baking.

To Bake Potatoes:

1. Place potato(es) on the turntable and close the door.
 2. Touch BAKED POTATO.
 3. Enter the number of pieces
or
Touch BAKED POTATO repeatedly to select a number.

Doneness may be adjusted at this time by touching COOK TIME.
 4. Touch START.
The display will count down the cook time.

When the cycle ends, "END" will appear in the display, and the end-of-cycle tones will sound, followed by reminder tones.
 5. Touch OFF CANCEL or open the door to clear the display and/or stop reminder tones.
-

Preset Cooking

Times and cooking power have been preset for certain microwavable foods. Use the following chart as a guide.

FOOD	PAD	QUANTITY/INSTRUCTIONS
Frozen Entrée	1	10, 20, 40 or 60 oz (283 or 567 g, or 1.1 or 1.7 kg)/ Remove from package. Loosen cover on 3 sides. If entrée is not in microwave-safe container, place on plate, cover with plastic wrap and vent. For 10- or 20-oz entrée, let stand 2-3 minutes after cooking. For 40- or 60-oz entrée, remove film halfway through cycle. Let stand 5 minutes after cooking.
Fresh Vegetables	2	1-4 cups (250 mL-1 L)/ Place in microwave-safe container. Add 2-4 tbs (30-60 mL) water. Cover with plastic wrap and vent. Stir and let stand 2-3 minutes after cooking.
Frozen Vegetables	3	1-4 cups (250 mL-1 L)/ Remove from package. Place in microwave-safe container. Cover with plastic wrap and vent. Stir and let stand 2-3 minutes after cooking.

To Use Preset Cooking:

1. Place food on the turntable, and close the door.
2. Touch COOK.
3. Select food by entering the number from the chart
or
Touch COOK repeatedly to scroll through food selections.
4. Enter quantity.
Doneness may be adjusted at this time by touching COOK TIME.
5. Touch START.
The display will count down the cook time.

When the cycle ends, "END" will appear in the display, and the end-of-cycle tones will sound, followed by reminder tones.
6. Touch OFF CANCEL or open the door to clear the display and/or stop reminder tones.

Reheating

Times and cooking power have been preset for reheating specific food types. Use the following chart as a guide.

FOOD	PAD	QUANTITY/INSTRUCTIONS
Pizza	1	1-3 slices, 3 oz (85 g) each (refrigerated)/ Place pizza slice(s) on paper towel or paper plate.
Casserole	2	1-4 cups (250 mL-1 L)/ Place in microwave-safe container, and cover with plastic wrap. Stir and let stand 2-3 minutes after reheating.
Dinner Plate	3	1 serving (1 plate), 8-10 oz (227-283 g)/ Place food on plate, cover with plastic wrap and vent. Let stand 2-3 minutes after reheating.
Soup/Sauce	4	1-4 cups (250 mL-1 L)/ Place in microwave-safe container. Cover with plastic wrap and vent. Stir and let stand 2-3 minutes after reheating.
Baked Goods (example: medium muffin or bagel)	5	1-6 pieces, 2 oz (57 g) each*/ Place on paper towel.

*For smaller rolls, 2 rolls may be counted as 1 piece.

To Use Reheat:

- Place food on the turntable, and close the door.
- Touch REHEAT.
- Select food by entering the number from the chart
or
Touch REHEAT repeatedly to scroll through food selections.
- Enter quantity.
Doneness may be adjusted at this time by touching COOK TIME.
- Touch START.
The display will count down the reheat time.
When the cycle ends, "END" will appear in the display, and the end-of-cycle tones will sound, followed by reminder tones.
- Touch OFF CANCEL or open the door to clear the display and/or stop reminder tones.

To Reheat Manually: Follow directions in "Manual Cooking" section, and use 70% cooking power. See "Microwave Cooking Power" chart.

Defrosting

The Auto Defrost feature can be used or the microwave oven can be manually set to defrost.

- Food should be 0°F (-18°C) or colder at defrosting for optimal results.
- Unwrap foods and remove lids (for example, from fruit juice containers) before defrosting.
- Shallow packages will defrost more quickly than deep blocks.
- Separate food pieces as soon as possible during or at the end of cycle for more even defrosting.
- Use small pieces of aluminum foil to shield parts of food such as chicken wings, leg tips and fish tails. See "Aluminum Foil and Metal" first.

The Auto Defrost system has 3 categories: Meat, Poultry and Fish. It should not be used for food left outside the freezer more than 20 minutes and frozen ready-made food. Use the following chart as a guide.

MEAT

<i>Beef:</i> ground, steaks, roast, stew	The narrow or fatty areas of irregular shaped cuts should be shielded with foil before defrosting.
<i>Lamb:</i> stew and chops	
<i>Pork:</i> chops, ribs, roasts, sausage	Do not defrost less than 1/4 lb (113 g) or two 4 oz (113 g) patties. Place all meats in microwave-safe baking dish.

POULTRY

<i>Chicken:</i> whole and cut up	Place in microwave-safe baking dish, chicken breast side up.
<i>Cornish hens</i>	
<i>Turkey:</i> breast	

FISH

<i>Fillets, Steaks, Whole, Shellfish</i>	Place in microwave-safe baking dish.
------------------------------------------	--------------------------------------

To Use Auto Defrost:

- Unwrap food, place on the turntable, and close the door.
- Touch DEFROST.
- Select food by entering 1 for Meat, 2 for Poultry or 3 for Fish
or
Touch DEFROST repeatedly to scroll through food selections.
- Enter the weight in pounds.
Meats and Poultry can be set from 0.2 to 6.6 lb (90 g to 3 kg).
Fish can be set from 0.2 to 4.4 lb (90 g to 2 kg).
Doneness may be adjusted at this time by touching COOK TIME.
- Touch START.
The display will count down the defrost time.
When the cycle ends, "END" will appear in the display, and the end-of-cycle tones will sound, followed by reminder tones.
- Touch OFF CANCEL or open the door to clear the display and/or stop reminder tones.

To Defrost Manually: Follow directions in "Manual Cooking" section, and use 30% cooking power. See "Microwave Cooking Power" chart.

MICROWAVE OVEN CARE

General Cleaning

IMPORTANT: Before cleaning, make sure all controls are off and the microwave oven is cool. Always follow label instructions on cleaning products.

Soap, water and a soft cloth or sponge are suggested unless otherwise noted.

GREASE FILTERS

Do not use ammonia or corrosive cleaning agents such as lye-based oven cleaners.

- Hot water and mild detergent:

Soak filters, then scrub and swish to remove embedded dirt and grease. Rinse well and shake to dry.

- Dishwasher:

Wash separately, not with dirty dishes, because food can be trapped in the filters.

NOTE: Some discoloration of the filters may occur after cleaning them in the dishwasher. This is normal, and will not affect the performance of the grease filters.

MICROWAVE OVEN CAVITY

To avoid damage to the microwave oven cavity, do not use soap-filled scouring pads, abrasive cleaners, steel-wool pads, gritty washcloths or some recycled paper towels.

To avoid damage to stainless steel models, rub in direction of grain.

The area where the microwave oven door and frame touch when closed should be kept clean.

Average soil

- Mild, nonabrasive soaps and detergents:

Rinse with clean water and dry with soft, lint-free cloth.

Heavy soil

- Mild, nonabrasive soaps and detergents:

Heat 1 cup (250 mL) of water for 2 to 5 minutes in microwave oven. Steam will soften soil. Rinse with clean water and dry with soft, lint-free cloth.

Odors

- Lemon juice or vinegar:

Heat 1 cup (250 mL) of water with 1 tbs (15 mL) of either lemon juice or vinegar for 2 to 5 minutes in microwave oven.

Microwave Inlet Cover

To avoid arcing and microwave oven damage, the microwave inlet cover (see “Parts and Features”) should be kept clean.

- Wipe with wet cloth.

MICROWAVE OVEN DOOR AND EXTERIOR

The area where the microwave oven door and frame touch when closed should be kept clean.

- Mild, nonabrasive soaps and detergents:

Rinse with clean water and dry with soft, lint-free cloth.

- Glass cleaner and paper towels or nonabrasive plastic scrubbing pad:

Apply glass cleaner to towel, not directly to surface.

Stainless Steel (on some models)

To avoid damage to microwave oven door and exterior, do not use soap-filled scouring pads, abrasive cleaners, steel-wool pads, gritty washcloths or some paper towels. Rub in direction of grain.

- Stainless Steel Cleaner & Polish (not included):

See “Assistance or Service” section to order.

- Liquid detergent or all-purpose cleaner:

Rinse with clean water and dry with soft, lint-free cloth.

- Vinegar for hard water spots

CONTROL PANEL

- Sponge or soft cloth and water:

Dampen sponge with water and wipe panel. Dry with soft cloth.

- Do not use chemical or abrasive cleansers.

TURNTABLE

Replace turntable immediately after cleaning. Do not operate the microwave oven without the turntable in place.

- Mild cleanser and scouring pad

- Dishwasher

Replacing Filters

The grease filters should be removed and cleaned at least once a month. Do not operate the microwave oven or exhaust fan without the grease filters in place. The charcoal filters cannot be washed and should be replaced every 6 to 12 months. See “General Cleaning” for cleaning instructions. See “Assistance or Service” to reorder filters.

To Remove and Replace Grease Filters:

1. Remove each grease filter by sliding filter to the end. Pull tab down until the filter drops out.

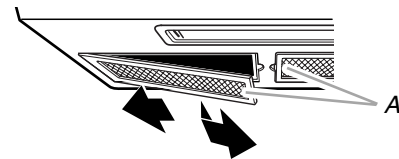

A. Tabs

2. Replace grease filter by inserting one end of the filter into the outer end of the frame. Swing the other end up and slide into position.

To Remove and Replace Charcoal Filter:

1. Remove the 2 vent grille mounting screws located directly behind the top louver.

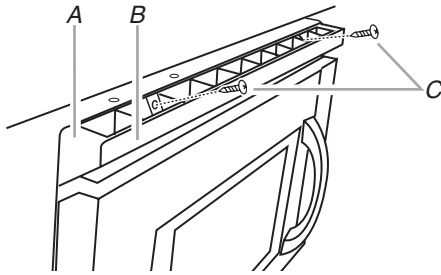

A. Vent grille
B. Top louver
C. Mounting screws

2. Tip the vent grille forward and down, then lift to remove.

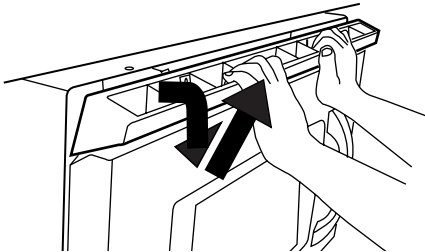

3. Slide filter back slightly, lift front end, and pull out filter.

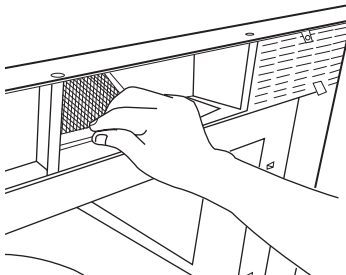

4. Install new charcoal filter.
5. Replace vent grille and mounting screws.

Replacing Cooktop Light

The cooktop light is a candelabra base bulb. See "Assistance or Service" section to reorder.

To Replace:

1. Unplug microwave oven or disconnect power.
2. Remove the bulb cover mounting screw.

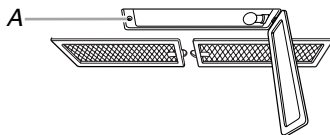

A. Mounting screw

3. Replace light. Close bulb cover. Replace mounting screw.
4. Plug in microwave oven or reconnect power.

Replacing Microwave Oven Light

The microwave oven light is a candelabra base bulb. It will automatically come on when the door is opened and when the microwave oven is operating. See "Assistance or Service" section to reorder.

To Replace:

1. Unplug microwave oven or disconnect power.
2. Remove the 2 vent grille mounting screws located directly behind the top louver.

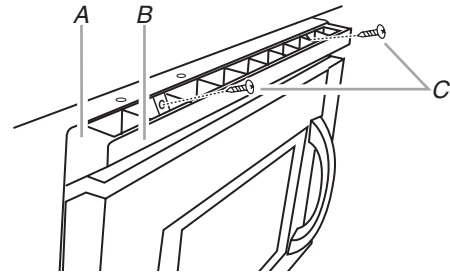

A. Vent grille
B. Top louver
C. Mounting screws

3. Tip the vent grille forward and down, then lift out to remove.

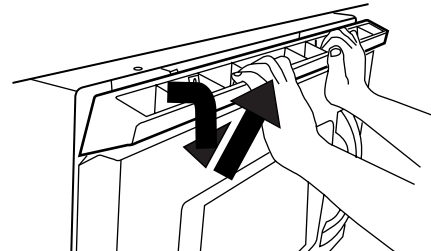

4. Lift up the bulb cover.

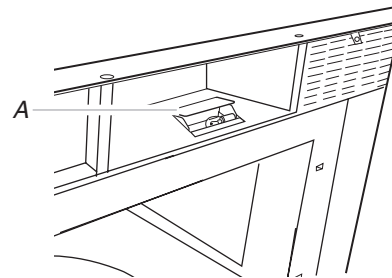

A. Bulb cover

5. Replace light. Close bulb cover.
6. Reattach vent grille. Replace the mounting screws.
7. Plug in microwave oven or reconnect power.

TROUBLESHOOTING

Try the solutions suggested here first in order to avoid the cost of an unnecessary service call.

Nothing will operate

- **Has a household fuse blown, or has the circuit breaker tripped?**
Replace the fuse or reset the circuit breaker. If the problem continues, call an electrician.
- **Is the appliance wired properly?**
See Installation Instructions provided with your microwave oven.

Microwave oven will not operate

- **Is the door completely closed?**
Firmly close door.
- **Is a spacer (on some models) attached to the inside of the door?**
Remove spacer, then firmly close door.
- **Is the electronic microwave oven control set correctly?**
See “Microwave Oven Control” section.
- **On some models, is the Control Lock set?**
See “Control Lock” section.
- **On some models, is the Demo Mode activated?**
See “Demo Mode” section.
- **Is the magnetron working properly?**
Try to heat 1 cup (250 mL) of cold water for 2 minutes at 100% cooking power. If water does not heat, call for service. See “Assistance or Service” section.

Microwave oven makes humming noise

- This is normal and occurs when the power supply switches the magnetron on and off.

Microwave oven door looks wavy

- This is normal and will not affect performance.

Turntable will not operate

- **Has the tape been removed from turntable hub?**
See “Turntable” section.
- **Is the turntable properly in place?**
Make sure turntable is correct side up and is sitting securely on the turntable support.
- **Is the turntable support operating properly?**
Remove turntable. Remove and clean turntable support and rollers. Replace turntable support. Replace turntable. Place 1 cup (250 mL) of water on the turntable, then restart microwave oven. If it still is not working, call for service. See “Assistance or Service” section. Do not operate the microwave oven without turntable and turntable support working properly.

Turntable alternates rotation directions

- This is normal and depends on motor rotation at the beginning of the cycle.

Display shows messages

- **Is the display showing “:”?**
There has been a power failure or the clock time has been turned off. See “Display” section to clear display. See “Clock” section to reset the clock or to turn it on.
- **Is the display showing a letter followed by a number?**
See “Display” section to clear. If it reappears, call for service. See “Assistance or Service” section.

Display shows time countdown, but is not operating

- **Is the Timer in use?**
See “Timer” section.
- **On some models, is the Demo Mode in use?**
See “Demo Mode” section.

Tones are not sounding

- **Are tones turned off?**
See “Tones” section.

Steam is coming from the vent grille

- Some steam is normal.

Fan running slower than usual

- **Has the microwave oven been stored in a cold area?**
The fan will run slower until the microwave oven warms up to normal room temperature.

Fan running during microwave cooking

- This is normal. The fan comes on at low speed to cool the microwave oven. See “Vent Fan” section.

Fan comes on during cooktop usage

- This is normal. The fan automatically comes on to cool the microwave oven if the temperature from the cooktop below gets too hot. See “Vent Fan” section.

Cooking times seem too long

- **Is the cooking power set properly?**
See “Microwave Cooking Power” section.
- **Are large amounts of food being heated?**
Larger amounts of food need longer cooking times.
- **Is the incoming voltage less than that specified in “Microwave Hood Combination Safety?”**
Have a qualified electrician check the electrical system in the home.

Radio, TV or cordless phone interference

- **Is the microwave oven plugged into the same outlet?**
Try a different outlet.
- **Is the radio or TV receiver near the microwave oven?**
Move the receiver away from the microwave oven, or adjust the radio or TV antenna.
- **Are the microwave oven door and sealing surfaces clean?**
Make sure these areas are clean.
- **Is the cordless phone frequency 2.4 GHz?**
Some 2.4 GHz-based cordless phones and home wireless networks may experience static or noise while the microwave oven is on. Use a corded phone, a different frequency cordless phone or avoid using these items during microwave oven operation.

ASSISTANCE OR SERVICE

Before calling for assistance or service, please check “Troubleshooting.” It may save you the cost of a service call. If you still need help, follow the instructions below.

When calling, please know the purchase date and the complete model and serial number of your appliance. This information will help us to better respond to your request.

If you need replacement parts

If you need to order replacement parts, we recommend that you use only FSP® replacement parts. FSP® replacement parts will fit right and work right because they are made with the same precision used to build every new ESTATE® appliance.

To locate FSP® replacement parts in your area, call our Customer eXperience Center telephone number or your nearest designated ESTATE® service center.

In the U.S.A.

Call the Whirlpool Customer eXperience Center toll free: **1-800-253-1301**.

Our consultants provide assistance with:

- Features and specifications on our full line of appliances.
- Installation information.
- Use and maintenance procedures.
- Accessory and repair parts sales.
- Specialized customer assistance (Spanish speaking, hearing impaired, limited vision, etc.).
- Referrals to local dealers, repair parts distributors, and service companies. Whirlpool designated service technicians are trained to fulfill the product warranty and provide after-warranty service, anywhere in the United States.

To locate the Whirlpool designated service company in your area, you can also look in your telephone directory Yellow Pages.

For further assistance

If you need further assistance, you can write to Whirlpool Corporation with any questions or concerns at:

Estate Brand Home Appliances
Customer eXperience Center
553 Benson Road
Benton Harbor, MI 49022-2692

Please include a daytime phone number in your correspondence.

Replacement Parts

Turntable Part Number 4393799	Charcoal Filter Part Number 8206230
Turntable Support and Rollers Part Number 8206227	Cooktop Light Bulb Part Number 8206232
Turntable Hub Part Number 8206228	Microwave Oven Light Bulb Part Number 4393681
Grease Filters Part Number 8206229	

Cleaning Supplies

Heavy Duty Degreaser Part Number 31552	Stainless Steel Cleaner & Polish Part Number 31462
All-Purpose Appliance Cleaner Part Number 31662	

WHIRLPOOL CORPORATION MAJOR APPLIANCE WARRANTY

ONE YEAR LIMITED WARRANTY

For one year from the date of purchase, when this major appliance is operated and maintained according to instructions attached to or furnished with the product, Whirlpool Corporation or Whirlpool Canada LP (hereafter "Whirlpool") will pay for Factory Specified Parts and repair labor to correct defects in materials or workmanship. Service must be provided by a Whirlpool designated service company. This limited warranty applies only when the major appliance is used in the country in which it was purchased.

ITEMS WHIRLPOOL WILL NOT PAY FOR

1. Service calls to correct the installation of your major appliance, to instruct you how to use your major appliance, to replace or repair house fuses or to correct house wiring or plumbing.
2. Service calls to repair or replace appliance light bulbs, air filters or water filters. Those consumable parts are excluded from warranty coverage.
3. Repairs when your major appliance is used for other than normal, single-family household use.
4. Damage resulting from accident, alteration, misuse, abuse, fire, flood, acts of God, improper installation, installation not in accordance with electrical or plumbing codes, or use of products not approved by Whirlpool.
5. Any food loss due to refrigerator or freezer product failures.
6. Replacement parts or repair labor costs for units operated outside the United States or Canada.
7. Pickup and delivery. This major appliance is designed to be repaired in the home.
8. Repairs to parts or systems resulting from unauthorized modifications made to the appliance.
9. Expenses for travel and transportation for product service in remote locations.
10. The removal and reinstallation of your appliance if it is installed in an inaccessible location or is not installed in accordance with published installation instructions.
11. Replacement parts or repair labor costs when the major appliance is used in a country other than the country in which it was purchased.

DISCLAIMER OF IMPLIED WARRANTIES; LIMITATION OF REMEDIES

CUSTOMER'S SOLE AND EXCLUSIVE REMEDY UNDER THIS LIMITED WARRANTY SHALL BE PRODUCT REPAIR AS PROVIDED HEREIN. IMPLIED WARRANTIES, INCLUDING WARRANTIES OF MERCHANTABILITY OR FITNESS FOR A PARTICULAR PURPOSE, ARE LIMITED TO ONE YEAR OR THE SHORTEST PERIOD ALLOWED BY LAW. WHIRLPOOL SHALL NOT BE LIABLE FOR INCIDENTAL OR CONSEQUENTIAL DAMAGES. SOME STATES AND PROVINCES DO NOT ALLOW THE EXCLUSION OR LIMITATION OF INCIDENTAL OR CONSEQUENTIAL DAMAGES, OR LIMITATIONS ON THE DURATION OF IMPLIED WARRANTIES OF MERCHANTABILITY OR FITNESS, SO THESE EXCLUSIONS OR LIMITATIONS MAY NOT APPLY TO YOU. THIS WARRANTY GIVES YOU SPECIFIC LEGAL RIGHTS AND YOU MAY ALSO HAVE OTHER RIGHTS, WHICH VARY FROM STATE TO STATE OR PROVINCE TO PROVINCE.

Outside the 50 United States and Canada, this warranty does not apply. Contact your authorized Whirlpool dealer to determine if another warranty applies.

If you need service, first see the "Troubleshooting" section of the Use & Care Guide. After checking "Troubleshooting," additional help can be found by checking the "Assistance or Service" section or by calling Whirlpool. In the U.S.A., call **1-800-253-1301**. In Canada, call **1-800-807-6777**.

12/05

Keep this book and your sales slip together for future reference. You must provide proof of purchase or installation date for in-warranty service.

Write down the following information about your major appliance to better help you obtain assistance or service if you ever need it. You will need to know your complete model number and serial number. You can find this information on the model and serial number label located on the product.

Dealer name _____
Address _____
Phone number _____
Model number _____
Serial number _____
Purchase date _____

W10110884

© 2006 Whirlpool Corporation.
All rights reserved.

© Registered Trademark/TM Trademark of Whirlpool, U.S.A.

4619-652-68392
9/06
Printed in China