



# 1F80-240

(for HEATING ONLY systems)  
Programmable Electronic Digital Thermostat  
**INSTALLATION AND  
OPERATION INSTRUCTIONS**

**Operator: Save these instructions for future use!**

**FAILURE TO READ AND FOLLOW ALL INSTRUCTIONS CAREFULLY  
BEFORE INSTALLING OR OPERATING THIS CONTROL COULD CAUSE  
PERSONAL INJURY AND/OR PROPERTY DAMAGE.**

## DESCRIPTION

Your new White-Rodgers 5-Day/1-Day/1-Day Digital Thermostat uses the technology of a solid-state microcomputer to provide precise time/temperature control. This thermostat offers you the flexibility to design a heating program that fits your needs.

### Features:

- Separate 5-day (weekday), 1-day (Sat) and 1-day (Sun) programming with four separate time/temperature periods per day
- Preprogrammed temperature control
- LCD continuously displays set point, and alternately displays time and room temperature

- Heat program storage
- Backlit display
- Temperature override until next program period
- Manual program override (HOLD temperature)
- Temporary HOLD
- °F/°C convertibility
- Temperature range 45° to 90°F
- RH, W, and G terminals
- Battery powered
- 2 "AA" Energizer® alkaline batteries included

## PRECAUTIONS

This thermostat is intended for use with a low voltage system; do not use this thermostat with a line voltage system. If in doubt about whether your wiring is millivolt, line, or low voltage, have it inspected by a qualified heating and air conditioning contractor or electrician.

Do not exceed the specification ratings.

All wiring must conform to local and national electrical codes and ordinances.

This control is a precision instrument, and should be handled carefully. Rough handling or distorting components could cause the control to malfunction.

### **CAUTION**

**To prevent electrical shock and/or equipment damage, disconnect electric power to system at main fuse or circuit breaker box until installation is complete.**

### **WARNING**

**Do not use on circuits exceeding specified voltage. Higher voltage will damage control and could cause shock or fire hazard.**

**Do not short out terminals on gas valve or primary control to test. Short or incorrect wiring will damage thermostat and could cause personal injury and/or property damage.**

**Thermostat installation and all components of the system shall conform to Class II circuits per the NEC code.**

## SPECIFICATIONS

### ELECTRICAL DATA

#### Electrical Rating:

- 8 to 30 VAC 50/60 Hz. or D.C.
- 0.05 to 1.0 Amps (Load per terminal)
- 1.5 Amps Maximum Total Load** (All terminals combined)

### THERMAL DATA

#### Setpoint Temperature Range:

45°F to 90°F (7°C to 32°C)

#### Operating Ambient Temperature Range:

32°F to 105°F

#### Operating Humidity Range:

0 to 90% RH (non-condensing)

#### Shipping Temperature Range:

-4°F to 150°F

### APPLICATIONS

For use with:

- Standard heat only systems
- Electric heat systems
- Gas or oil fired systems
- Gas systems with intermittent ignition devices (I.I.D.) and/or vent dampers
- Hydronic (hot water or steam) systems
- Single-stage heat pump systems (no auxiliary heat)
- Millivolt systems

#### DO NOT USE WITH:

- Multi-stage systems
- Systems exceeding 30 VAC and 1.5 amps
- 3-wire zoned hydronic heating systems
- Heat pump systems

**WHITE-RODGERS**  
EMERSON ELECTRIC CO.  
9797 REAVIS ROAD  
ST. LOUIS, MISSOURI 63123-5398  
www.white-rodgers.com

Printed in U.S.A.

**PART NO. 37-6325B**

0148

# INSTALLATION

## REMOVE OLD THERMOSTAT

1. Shut off electricity at the main fuse box until installation is complete. Ensure that electrical power is disconnected.
2. Remove the front cover of the old thermostat. **With wires still attached**, remove wall plate from the wall. If the old thermostat has a wall mounting plate, remove the thermostat and the wall mounting plate as an assembly.
3. **Identify each wire attached to the old thermostat using the labels enclosed with the new thermostat.**
4. Disconnect the wires from old thermostat one at a time. **DO NOT LET WIRES FALL BACK INTO THE WALL.**
5. Install new thermostat using the following procedures.

### ATTENTION!

This product does not contain mercury. However, this product may replace a unit which contains mercury.

Do not open mercury cells. If a cell becomes damaged, do not touch any spilled mercury. Wearing nonabsorbent gloves, take up the spilled mercury with sand or other absorbent material and place into a container which can be sealed. If a cell becomes damaged, the unit should be discarded.

Mercury must not be discarded in household trash. When the unit this product is replacing is to be discarded, place in a suitable container and return to White-Rodgers at 9797 Reavis Road, St. Louis, MO, 63123-5398 for proper disposal.

## ELECTRIC HEAT OR SINGLE-STAGE HEAT PUMP SYSTEMS

This thermostat is configured from the factory to operate a fossil fuel (gas, oil, etc.) and forced air system. It is configured correctly for any system that DOES NOT require the thermostat to energize the fan on a call for heat. If your system is an electric heat system that REQUIRES the thermostat to turn on the fan on a call for heat, locate the **GAS/ELECTRIC switch** on the back of the thermostat (see fig. 1) and switch it to the **ELECTRIC** position. This will allow the thermostat to energize the fan immediately on a call for heat. If you are unsure if the heating system requires the thermostat to control the fan, contact a qualified heating and air conditioning service person.

## ATTACH THERMOSTAT BASE TO WALL

1. Remove the packing material from the thermostat. Gently pull the cover straight off the base. Forcing or prying on the thermostat will cause damage to the unit. If necessary, move the electric heat switch (see **ELECTRIC HEAT SYSTEMS**, above).
2. Connect wires beneath terminal screws on base using appropriate wiring schematic (see figs. 2 through 5).
3. Place base over hole in wall and mark mounting hole locations on wall using base as a template.
4. Move base out of the way. Drill mounting holes.
5. Fasten base loosely to wall, as shown in fig. 1, using two mounting screws. Place a level against bottom of base, adjust until level, and then tighten screws. (Leveling is for appearance only and will not affect thermostat operation.) If you are using existing mounting holes, or if holes drilled are too large and do not allow you to tighten base snugly, use plastic screw anchors to secure subbase.

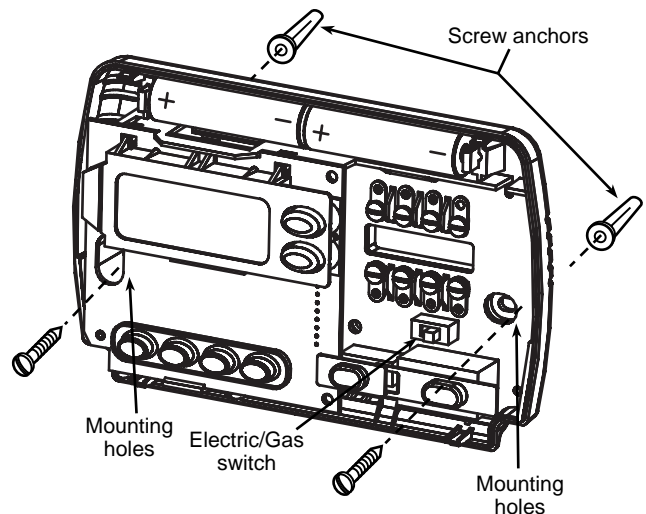

Figure 1. Thermostat Base

6. Push excess wire into wall and plug hole with a fire-resistant material (such as fiberglass insulation) to prevent drafts from affecting thermostat operation.

## BATTERY LOCATION

2 "AA" alkaline batteries are included in the thermostat at the factory with a battery tag to prevent power drainage. **You must remove the battery tag to engage the batteries.**

If **BATT** is displayed, the batteries are low and should be replaced with fresh "AA" Energizer® alkaline batteries. To replace batteries, install the batteries along the top of the base (see Fig. 1). The batteries must be installed with the positive (+) end to the left.

## HYDRONIC (HOT WATER OR STEAM) HEATING SYSTEMS

This thermostat is set to operate properly with a forced-air heating system. If you have a hydronic heating system (a system that heats with hot water or steam), you must set the thermostat to operate properly with your system. Change the second option in the configuration menu to SL (see CONFIGURATION MENU, page 4).

## CHECK THERMOSTAT OPERATION

If at any time during testing your system does not operate properly, contact a qualified service person.

Turn on power to the system.

### Fan Operation

If your system **does not** have a **G** terminal connection, skip to **Heating System**.

1. Move fan to **ON** position. The blower should begin to operate.
2. Move fan switch to **AUTO** position. The blower should stop immediately.

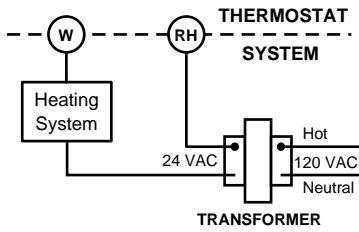

**Figure 2. Typical wiring diagram for heating only, 2-wire, single transformer systems**

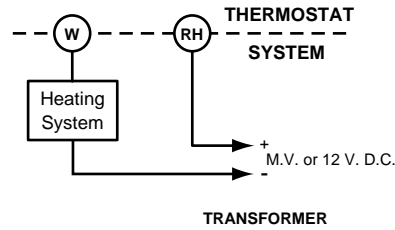

**Figure 3. Typical wiring diagram for heating only, 2-wire, single transformer systems**

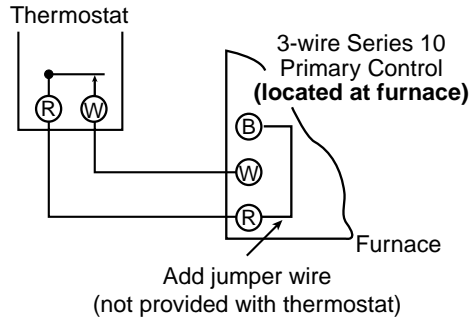

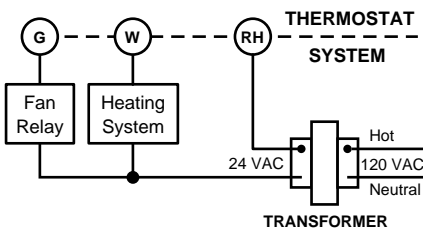

**Figure 4. Typical wiring diagram for 3-wire SERIES 10 heating systems**



**Figure 5. Typical wiring diagram for heat only, 3-wire, single transformer systems**

### Heating System

1. Move SYSTEM switch to **HEAT** position. If the heating system has a standing pilot, be sure to light it.
2. Press  to adjust thermostat setting above room temperature. The heating system should begin to operate.
3. Press  to adjust temperature setting below room temperature. The heating system should stop operating.

# OPERATION

Before you begin programming your thermostat, you should be familiar with its features and with the display and the location and operation of the thermostat buttons. Your thermostat consists of two parts: the **thermostat cover** and the **base**. To remove the cover, pull it straight out from the base. To replace the cover, line up the cover with the base and press until the cover snaps onto the base.

## The Thermostat Buttons and Switches

- ① Raises temperature setting.
- ② Lowers temperature setting.
- ③ TIME button.
- ④ PRGM (program) button.
- ⑤ RUN (run program) button.
- ⑥ HOLD temperature button.
- ⑦ FAN switch (ON, AUTO).
- ⑧ SYSTEM switch (OFF, HEAT).

## The Display

- ⑨ Indicates day of the week.
- ⑩ **Flame icon** (Δ) is displayed when the SYSTEM switch is in the HEAT position.
- ⑪ Displays **BATT** when the 2 "AA" batteries are low and should be replaced. Only **BATT** and **LO** in the minutes field are displayed when batteries are low.
- ⑫ Alternately displays current time and temperature. Displays **LO** in the minutes field when batteries are low.
- ⑬ The word **HOLD** is displayed when the thermostat is in the HOLD mode. **HOLD** is displayed flashing when the thermostat is in a temporary HOLD Mode.
- ⑭ Displays currently programmed set temperature (this is blank when SYSTEM switch is in the OFF position).
- ⑮ Displays **FLTR** when the system has run for the programmed filter time period as a reminder to change or clean your air filter.

## CONFIGURATION MENU

The configuration menu allows you to set certain thermostat operating characteristics to your system or personal requirements.

Press RUN to make sure the thermostat is in the run program mode, then press PRGM and RUN at the same time to enter the configuration menu. The display will show the first item in the configuration menu.

The configuration menu table summarizes the configuration options. An explanation of each option follows.

Press HOLD to change to the next menu item or press TIME to go backwards to the previous item in the menu. To exit the menu and return to the program operation, press RUN. If no keys are pressed within fifteen minutes, the thermostat will revert to normal operation.

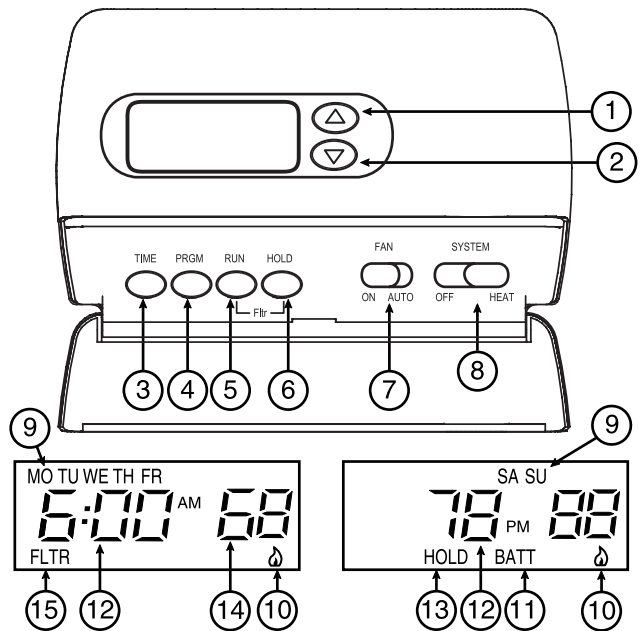





Figure 6. Thermostat display, buttons, and switches

- 1) **Select Temporary Hold Time** - The thermostat can hold any temperature you set it to for the amount of time you select on this option. Your choices are 0:00 to 8:00 hours in 15 minute increments. 0:00 disables the function  
 Example:
  1. You have selected 3:00 hours for the Temporary Hold time period.
  2. With the thermostat set to Heat, press HOLD for **approximately five seconds** until HOLD time (3:00 indicating 3 hours) appears as a setting reminder.
  3. After releasing the button, **HOLD** in the display will blink.
  4. Use ▲ or ▼ to set the temperature to your preference. The thermostat will maintain this temperature setting for 3 hours with **HOLD** blinking to remind you it is in Temporary Hold. After 3 hours the thermostat will go back to the program temperature and **HOLD** will no longer blink or display.
- 2) **Select FA or SL (Fast or Slow) Heating Cycle Rate** - The FA setting is frequently used for gas, oil or electric heat. The SL setting produces a longer heating cycle which is normally for hot water or steam (hydronic) systems. Both settings produce very accurate temperature control and can be set to your personal preference. FA cycles the system just under 1°F and the SL setting cycles at approximately 1.5°F.
- 3) **Select Display Light ON or OFF** - The display backlight improves display contrast in low lighting conditions. Selecting **d-I ON** will keep the light on for a short period of time after any key is pressed. Selecting **d-I OFF** will keep the light off.

## Configuration Menu

| Step | Press Button(s)               | Displayed (Factory Default)   | Press  or  to select: | COMMENTS  |
|------|-------------------------------|---|---|---|
| 1    | <b>PRGM</b><br>and <b>RUN</b> | HOLD<br>(0:00)  | 0 to 8 hrs (in<br>15 minute increments)   | Select temporary Hold time                              |
| 2    | <b>HOLD*</b>                  | <br>(FA) | SL  | Select FA or SL (Fast or Slow) heating cycle rate       |
| 3    | <b>HOLD*</b>                  | d-L<br>(ON)   | OFF   | Select display backlight OFF or ON                      |
| 4    | <b>HOLD*</b>                  | E<br>(ON)   | OFF   | Select Energy Management Recovery OFF or ON             |
| 5    | <b>HOLD*</b>                  | Filter<br>(000)   | 0 to 1950 hours<br>(in 50 hour increments)  | Select filter replacement run time                      |
| 6    | <b>HOLD*</b>                  | LOC<br>(OFF)  | ON  | Compressor lockout feature not applicable to this model |
| 7    | <b>HOLD*</b>                  | 0 HI<br>(0)   | 4 LO to<br>4 HI   | Select temperature display adjustment higher or lower   |
| 8    | <b>HOLD*</b>                  | (F)   | C   | Select temperature display to F or C                    |
| 9    | <b>RUN</b>                    |   |   | Returns to normal operation                             |

\* Press **HOLD** to advance to next item or **TIME** to move backwards to previous item

#### 4) Select Energy Management Recovery OFF or ON -





Energy Management Recovery (EMR) causes the thermostat to start heating early to make the building temperature reach the program setpoint at the time you specify. Heating will start 5 minutes early for every 1° of temperature required to reach setpoint.

**Example:** You select EMR and have your heating programmed to 65° at night and 70° at 7 AM. If the building temperature is 65° the difference between 65° and 70° is 5°. Allowing 5 minutes per degree the thermostat setpoint will change to 70° at 6:35 AM.

- 5) **Select filter replacement run time** - The thermostat will display **FLTR** after a set time of operation. This is a reminder to change or clean your air filter. This time can be set from 0 to 1950 hours in 50 hour increments. **A selection of 000 will cancel this feature.** When **FLTR** is displayed, you can clear it by pressing **HOLD** and **RUN** at the same time. This resets the timer and starts counting the hours until the next filter change. Changing the time in the menu also resets the timer.
- 6) **Compressor Lockout** - Feature not applicable to this model.
- 7) **Select Temperature Display Adjustment 4 LO to 4 HI** - Allows you to adjust the room temperature display 4° higher or lower. Your thermostat was accurately calibrated at the factory but you have the option to change the display temperature to match your previous thermostat.
- 8) **Select F° or C° Readout** - Changes the display readout to Centigrade or Fahrenheit as required.

## OPERATING FEATURES

Now that you are familiar with the thermostat buttons and display, read the following information to learn about the many features of the thermostat.

- **TEMPERATURE OVERRIDE** — Press  or  until the display shows the temperature you want. The thermostat will override current programming and keep the room temperature at the selected temperature until the next program period begins. Then the thermostat will automatically revert to the program.
- **HOLD TEMPERATURE (BYPASSING THE PROGRAM)** The thermostat can hold any temperature within its range for an indefinite period without reverting to the programmed temperature. Momentarily press **HOLD** button. **HOLD** will be displayed. Then choose the desired temperature by pressing  or . The thermostat will hold the room temperature at the selected setting until you press **RUN** button to start program operation again.
- **CONFIGURATION MENU** — Allows you to customize certain thermostat options.

## PROGRAMMING YOUR THERMOSTAT

This section will help you plan your thermostat's program to meet your needs. For maximum comfort and efficiency, keep the following guidelines in mind when planning your program.

- When heating your building, program the temperatures to be cooler when the building is vacant or during periods of low activity.

## Planning Your Program

Look at the factory preprogrammed times and temperatures shown in the sample schedule. If this program will suit your needs, simply press the RUN button to begin running the factory preset program.

If you want to change the preprogrammed times and temperatures, follow these steps.

Determine the time periods and temperatures for your weekday and weekend programs. You must program four periods for both the weekday and weekend program. However, you may use the same heating temperatures for consecutive time periods. You can choose start times and heating temperatures independently for both weekday and weekend programs (for example, you may select 5:00 AM and 70° as the weekday **1st period heating** start time and temperature).

Use the following table to plan your program time periods and the temperatures you want during each period. Fill in the complete table to have a record of your programs.



## Entering Your Program

Follow these steps to enter the heating program you have selected.





### Set Current Time and Day

1. Press TIME button once. The display will show the hour only.

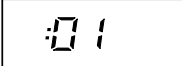
EXAMPLE: 

2. Press and hold either  or  until you reach the correct hour and AM/PM designation (**AM** begins at midnight; **PM** begins at noon).
3. Press TIME once. The display window will show the minutes only.

EXAMPLE: 

4. Press and hold either  or  until you reach the correct minutes.
5. Press TIME once. The display will show the day of the week.
6. Press  or  until you reach the current day of the week.
7. Press RUN once. The display will show the correct time and room temperature alternately.

**SAMPLE**  
Heating Schedule Plan (Factory Program)

| Period | WEEKDAY (5 DAY) |             | SATURDAY (1 DAY) |             | SUNDAY (1 DAY) |             |
|--------|-----------------|-------------|------------------|-------------|----------------|-------------|
|        | Start Time      | Temperature | Start Time       | Temperature | Start Time     | Temperature |
| 1ST    | 6:00 AM         | 70 F        | 6:00 AM          | 70 F        | 6:00 AM        | 70 F        |
| 2ND    | 8:00 AM         | 62 F        | 8:00 AM          | 62 F        | 8:00 AM        | 62 F        |
| 3RD    | 5:00 PM         | 70 F        | 5:00 PM          | 70 F        | 5:00 PM        | 70 F        |
| 4TH    | 10:00 PM        | 62 F        | 10:00 PM         | 62 F        | 10:00 PM       | 62 F        |

Heating Schedule Plan



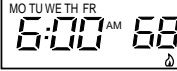

| Period | WEEKDAY (5 DAY) |             | SATURDAY (1 DAY) |             | SUNDAY (1 DAY) |             |
|--------|-----------------|-------------|------------------|-------------|----------------|-------------|
|        | Start Time      | Temperature | Start Time       | Temperature | Start Time     | Temperature |
| 1ST    |                 |             |                  |             |                |             |
| 2ND    |                 |             |                  |             |                |             |
| 3RD    |                 |             |                  |             |                |             |
| 4TH    |                 |             |                  |             |                |             |

## Enter Heating Program

1. Move the SYSTEM switch to **HEAT**.
2. Press PRGM once. "**MOTUWETHFR**" (indicating weekday program) will appear in the display. Also displayed are the currently programmed start time for the **1st heating** period and the currently programmed temperature (flashing).

EXAMPLE: 

This display window shows that for the 1st weekday period, the start time is 6:00 AM, and 68° is the programmed temperature (this example reflects factory preprogramming).

3. Press  or  to change the displayed temperature to your selected temperature for the 1st heating program period.
4. Press TIME once (the programmed time will flash). Press  or  until your selected time appears. The time will change in 15 minute increments. When your selected time is displayed, press TIME again to return to the change temperature mode.
5. Press PRGM once. The currently programmed start time and setpoint temperature for the **2nd heating** program period will appear.
6. Repeat steps 3 and 4 to select the start time and heating temperature for the 2nd heating program period.
7. Repeat steps 3 through 5 for the 3rd and 4th heating program periods. Weekday heating programs are now complete.
8. Press PRGM once. "**SA**" (indicating Saturday program) will appear in the display, along with the start time for the 1st heating period and the currently programmed temperature.
9. Repeat steps 3 through 7 to complete Saturday heating programming.
8. Press PRGM once. "**SU**" (indicating Sunday program) will appear in the display. Repeat steps 3 through 7 to complete Saturday heating programming.
10. When you have completed entering your heating program, press RUN.

## CHECK YOUR PROGRAMMING

Follow these steps to check your thermostat programming one final time before beginning thermostat operation.



1. Move SYSTEM switch to **HEAT** position.
2. Press PRGM to view the 1st weekday heating period time and temperature. Each time you press PRGM, the next heating period time and temperature will be displayed in sequence for weekday, then weekend program periods (you may change any time or temperature during this procedure).
3. Press RUN to begin program operation.

**YOUR THERMOSTAT IS NOW COMPLETELY PROGRAMMED AND READY TO PROVIDE MAXIMUM COMFORT AND EFFICIENCY!**

## TROUBLESHOOTING

| Symptom   | Possible Cause  | Corrective Action   |
|---|---|---|
| No Heat/No Fan<br>(common problems)                                       | <ol style="list-style-type: none"> <li>1. Blown fuse or tripped circuit breaker.</li> <li>2. Furnace power switch to OFF.</li> <li>3. Furnace blower compartment door or panel loose or not properly installed.</li> </ol>  | Replace fuse or reset breaker.<br>Turn switch to ON.<br>Replace door panel in proper position to engage safety interlock or door switch.  |
| No Heat   | <ol style="list-style-type: none"> <li>1. Pilot light not lit.</li> <li>2. System Switch not set to Heat.</li> <li>3. Loose connection to thermostat or system.</li> <li>4. Furnace Lock-Out Condition. Heat may also be intermittent.</li> <li>5. Heating System requires service or thermostat requires replacement.</li> </ol> | Re-light pilot.<br>Set System Switch to Heat and raise setpoint above room temperature.<br>Verify thermostat and system wires are securely attached.<br>Many furnaces have safety devices that shut the system down when a lock-out condition occurs. If the heat works intermittently contact the furnace manufacturer or local service person for assistance.<br>Diagnostic: Set System Switch to Heat and raise the setpoint above room temperature. Within a few seconds the thermostat should make a soft click sound. This sound usually indicates the thermostat is operating properly. If the thermostat does not click, try the reset operation listed above. If the thermostat does not click after being reset contact your heating and cooling service person or place of purchase for a replacement. If the thermostat clicks, contact the furnace manufacturer or a service person to verify the heating system is operating correctly. |
| Heat or Fan Runs Constantly   | <ol style="list-style-type: none"> <li>1. Possible short in wiring.</li> <li>2. Possible short in thermostat.</li> <li>3. Possible short in Heat/Cool/Fan system.</li> <li>4. Fan Switch set to Fan On.</li> </ol>  | Check each wire connection to verify they are not shorted or touching together. No bare wire should stick out from under terminal screws. Try resetting the thermostat as described below.<br>If the condition persists the manufacturer of your system or service person can instruct you on how to test the Heat/Cool system for correct operation. If the system operates correctly, replace the thermostat.   |
| Furnace Cycles Too Fast or Too Slow<br>(narrow or wide temperature swing) | <ol style="list-style-type: none"> <li>1. The location of the thermostat and/or the size of the Heating System may be influencing the cycle rate.</li> </ol>  | Item 2 in the Configuration Menu is the adjustment that controls the cycle rate. If an acceptable cycle rate is not achieved using the FA (Fast) or SL (Slow) adjustment contact a local service person for additional suggestions.   |
| Thermostat Setting and Thermometer Disagree                               | <ol style="list-style-type: none"> <li>1. Thermostat thermometer setting requires adjustment.</li> </ol>  | The thermometer can be adjusted +/- 4 degrees as listed in item 7 of the Configuration Menu. No other adjustment is possible.   |
| Thermostat Does Not Follow Program  | <ol style="list-style-type: none"> <li>1. AM or PM set incorrectly in program.</li> <li>2. AM or PM set incorrectly on the clock.</li> <li>3. Voltage spike or static discharge.</li> </ol>   | Check current clock and program settings including the AM or PM designations for each time period. If a voltage spike or static discharge occurs use the Reset Operation listed below.  |
| Blank Display and/or Keypad Not Responding                                | <ol style="list-style-type: none"> <li>1. Loss of power and dead batteries.</li> <li>2. Voltage Spike or Static Discharge.</li> </ol>   | Replace batteries and check heat/cool system for proper operation. If a voltage spike or static discharge occurs use the Reset Operation listed below.  |

### Reset Operation

If a voltage spike or static discharge blanks out the display or causes erratic thermostat operation you can reset the thermostat by pressing ,  and TIME at the same time. This also resets the factory defaults to the configuration menu and program. If the thermostat has power, has been reset and still does not function correctly contact your heating/cooling service person or place of purchase.

### Batteries

For optimum performance, we recommend replacing batteries once a year with fresh "AA" Energizer® alkaline batteries.

For additional product information, visit [www.white-rodgers.com](http://www.white-rodgers.com)