



UP400 Programmable Thermostat

Installation Instructions & User Guide



For Installation Help	
	1-877-654-9394
	White-Rodgers.com



White-Rodgers
8100 West Florissant Avenue
St. Louis, MO 63136

Congratulations on the purchase of your White-Rodgers™ thermostat!
Save these instructions for future use!

Questions? Contact White-Rodgers™
customer service at 1-877-654-9394

⚠ CAUTION

- Failure to read and follow all instructions carefully before installing or operating this control could cause personal injury and/or property damage.
- The thermostat may stop controlling temperature and your house may freeze or overheat when batteries are too low. Batteries must be changed when  appears on the display.



ATTENTION: MERCURY NOTICE

This product does not contain mercury. However, this product may replace a product that contains mercury. Mercury and products containing mercury must not be discarded in household trash. Do not touch any spilled mercury. Wearing non-absorbent gloves, clean up any spilled mercury and place in a sealed container. For proper disposal of a product containing mercury or a sealed container of spilled mercury, place it in a suitable shipping container. Refer to www.White-Rodgers.com for location to send product containing mercury.

These symbols are used throughout this User Guide.

Watch for them to identify:

⚠ CAUTION Cautions

TIP Tips

PROG Programmable Features

TABLE OF CONTENTS

Part 1: Before Getting Started	Page 2
1.1 Check package contents	
1.2 Answer questions about source of heating in your home	
1.3 Assemble tools	
1.4 Turn off power to your heating and cooling system	
Part 2: Remove Old Thermostat and Install New Thermostat	Page 4
2.1 Expose wires connected to old thermostat	
2.2 Label and disconnect the wires	
2.3 Install new thermostat's wallplate	
2.4 Match and connect wires	
2.5 Install batteries	
2.6 Snap thermostat to the wallplate	
Part 3: Quick Setup	Page 13
3.1 Get to know your thermostat	
3.2 Set fan and system mode	
3.3 Select options	
3.4 Turn on power to your heating and cooling system	
3.5 Set time and date	
3.6 Review pre-programmed schedule	
Part 4: Additional Thermostat Features	Page 18
4.1 Customize the pre-program schedule	
4.2 Set favorite temperatures (home / sleep / away)	
4.3 Set temporary hold at	
4.4 Bypass the schedule (permanent hold)	
4.5 Set vacation hold	
4.6 Change batteries	
4.7 Activate permanent auxiliary heat (for Heat Pumps only)	
4.8 Set keypad lockout	
4.9 Set change filter reminder	
4.10 Set change humidifier pad reminder	
4.11 Enable auto changeover	
4.12 Adjust actual temperature display	
4.13 Change faceplate color	
Part 5: Troubleshooting Guide	Page 30
Appendix: Heat Pump Identification	Page 32

Part 1 Before Getting Started

Before getting started, please review the following pre-installation checklist.

1.1 Check package contents

Open the package and verify that the following items are included:

- Wallplate (A) thermostat (B) white cover (C)
- 4 color inserts (D)
- Clear plastic cover (E)
- 2 mounting screws and wall anchors (F)
- Wire Labels
- Installation Instructions and User Guide

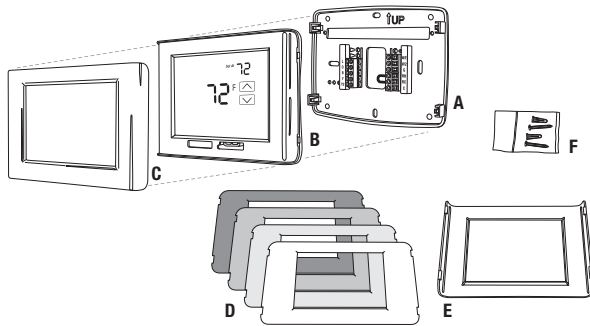

TIP If any of the items shown above are missing from your package, call White-Rodgers™ customer service at 1-877-654-9394 before returning the thermostat to your place of purchase.

1.2 Answer questions about source of heating in your home

- ✓ Do you have either an oil or gas burning furnace?
- ✓ Do you have a Heat Pump (and is it 1-stage or 2-stage)?*
- ✓ Do you have Hydronic Heating (steam or hot water radiators or radiant floor heating)?

TIP *To determine if you have a Heat Pump and/or whether it is a 1-stage or 2-stage model, see the Appendix on the last page of the Manual.

1.3 Assemble tools

You will need the following tools:

- ✓ Flat-head screwdriver
- ✓ 2 AA alkaline batteries

You may also need:

- ✓ Hammer
- ✓ Drill with 3/16" (4 mm) bit
- ✓ Small pliers to bend wires

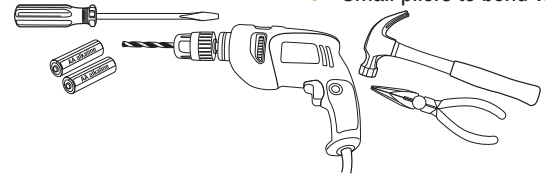

1.4 Turn off power to your heating and cooling system

Typically, this is achieved by flipping a switch on the outside of the furnace/air handler to the "OFF" position.

CAUTION Do not turn the system back on until you have completed the installation and set up of the thermostat.

Part 2 Remove Old Thermostat and Install New Thermostat

TIP Do not disconnect wires from the old thermostat until you label all the wires **according to this manual**.

2.1 Expose wires connected to old thermostat

2.1.1 **After turning off power to your heating & cooling system,** expose wallplate with wires and wire terminals. The required steps vary depending on your old thermostat type.

Your old thermostat may consist of:

- **3 parts:** a cover, base and wallplate
or
- **2 parts:** a cover and wallplate

3-Part unit

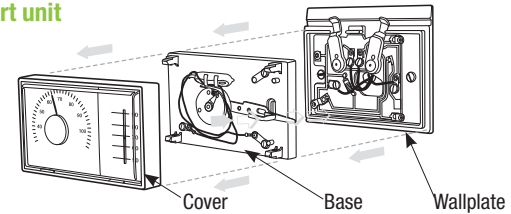

2-Part unit

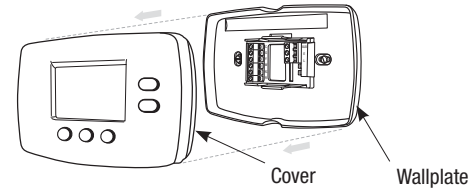

- ✓ **The Cover:** This usually pulls off, but is sometimes secured by a screw which must be loosened.
- ✓ **The Base:** This either pulls off or needs to be removed by loosening screws under the cover.
- ✓ **The Wallplate:** This is removed by loosening the screws that hold the thermostat to the wall.

- 2.1.2 Loosen all screws holding the old thermostat's wallplate to the wall. **Do not disconnect the wires from terminals.** Allow the wallplate to hang loosely on the wires.

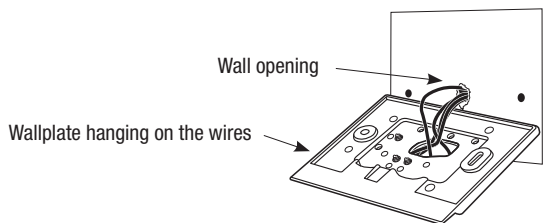

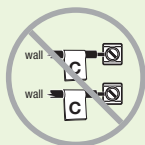

TIP

- ✓ **Ignore wire colors.** There is no standard color code for thermostat wires.
- ✓ **Ignore existing wire labels,** if they are present.
- ✓ **Use the provided labels** to label/re-label the thermostat wires.
- ✓ **The new labels must remain on the wires** at least until the installation process is complete.
- ✓ **No two wires can have the same label.**



2.2 Label and disconnect the wires

2.2.1 Note you may see two types of wiring in the old thermostat:

1. Wires leading from the wall to a terminal on the thermostat 
2. Wires connecting one terminal to another (jumper wire). These don't have to be labeled. 

2.2 Label and disconnect the wires (cont.)

2.2.2 Label each wire that comes **out of the wall and attaches to terminals** on the old thermostat. Use labels provided with your new thermostat.

1. Note the letter printed near each wired terminal
2. For each out-of-the-wall wire:
 - find its terminal letter(s) in the **left column** of the table on page 9,
 - label the wire according to the **right column** of the table.
3. Make the following notes in the **right column** of the table on page 9:

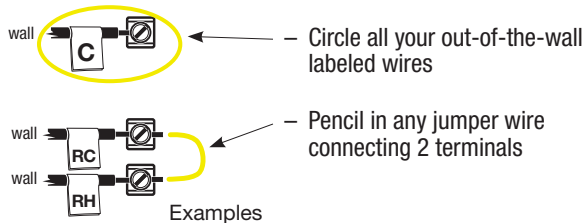

You'll need this information further in the installation process!

TIP Note: No thermostat installation uses all of the wires shown on page 9. In most cases, between 4 and 5 terminals are wired.

CAUTION Mislabeling the wires could result in damage to your heating and cooling unit.

Contact White-Rodgers™ Customer Service at 1-877-654-9394 if your old thermostat contains any wired terminals not listed in the table.

If the OLD thermostat's terminal is wired into the wall and identified by this letter...

...Then label its wire with this letter:

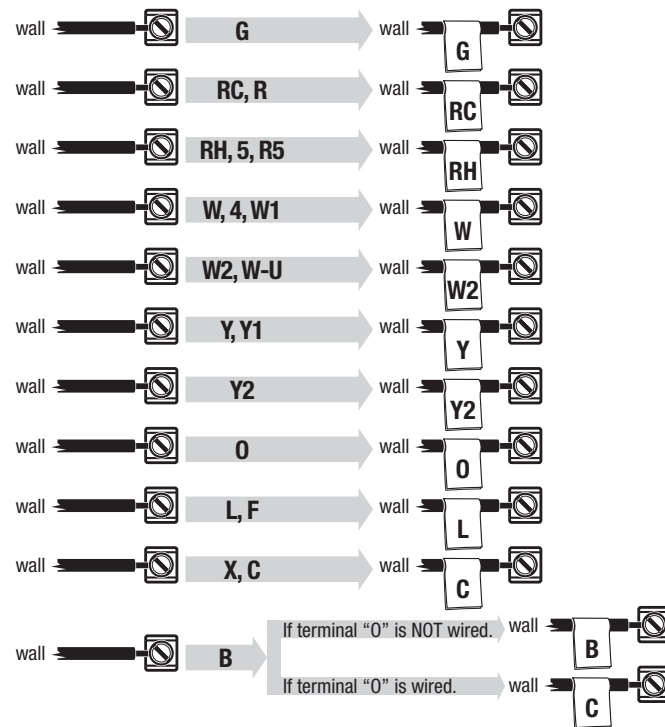

2.2.3 After labeling all the wires, use a screwdriver to disconnect each wire from its terminal. Remove the old thermostat.

TIP Make sure that the wires don't fall into the wall after you detach them from the old thermostat. You may choose to tape them to the wall or tightly wind them around a pencil or screwdriver.

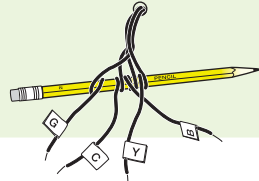

2.3 Install new thermostat's wallplate

2.3.1 Detach the new thermostat's wallplate from the rest of the thermostat and position the wallplate on the wall according to the illustration below, passing the labeled wires through the wire hole in the center of the wallplate.

2.3.2 With the wallplate flush against the wall, mark mounting holes with a pencil.

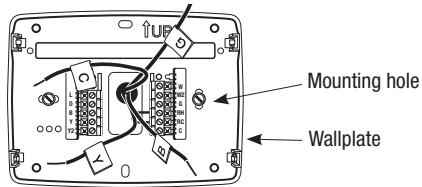

CAUTION Do not allow wires to touch each other or parts on the thermostat. Doing so could result in damage to your heating and cooling unit.

2.3.3 Move the wallplate aside. Drill the mounting holes using a 3/16" drill bit. With a hammer, tap the wall anchors, provided in the package, into the drilled holes.

2.3.4 Position the wallplate on the wall again and screw the mounting screws into the wall anchors. Do not use a power screwdriver, you may damage your thermostat.

2.4 Match and connect wires

2.4.1 Match each wire coming from the wall to its corresponding terminal, as shown in the illustration below. Insert each wire into the hole on the side of its matching terminal. Using a screwdriver, tighten the screw securely. **DO NOT REMOVE THE WIRE LABELS.**

TIP No thermostat installation uses all of the wires shown below. In most cases, between 4 and 5 terminals are wired. The remaining terminals will not be used.

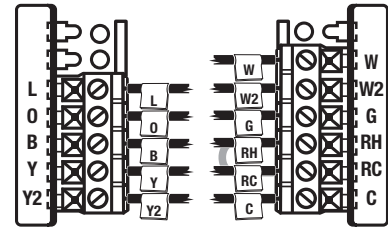

CAUTION A maximum of one wire from the wall can be wired into each terminal.

2.4.2 In the new thermostat, a jumper wire connects the RC and RH terminals.



If, in your OLD thermostat...	Then...
Terminals RC and RH (or 5 , or R5) were connected by a jumper wire,	...leave the jumper wire in place in the new thermostat.
There was a terminal R , which you then labeled RC according to 2.2.2,	...leave the jumper wire in place in the new thermostat.
Terminals RC and RH (or 5 or R5) were NOT connected by a jumper wire,	...remove the jumper wire from the new thermostat.
If you're not sure whether terminals RC and RH were connected in your old thermostat, refer to your notes made in section 2.2.2.	

2.5 Install batteries

Install 2 AA alkaline batteries (not included) into the battery compartment at the top of the thermostat.

2.6 Snap thermostat to the wallplate

CAUTION Do not restore power to the heating and cooling system until instructed.

Part 3 Quick setup

3.1 Get to know your thermostat

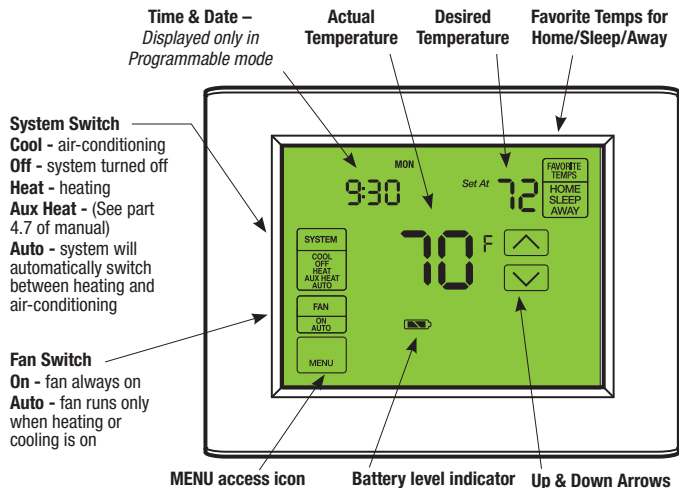

Note: After a period of inactivity, the thermostat display goes to “sleep” where only the temperature and the  icons are visible. To “wake up” the display, press the  icon.

3.2 Set fan and system mode

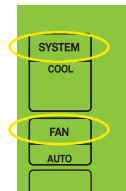

1. Press the **FAN** icon to set it to **AUTO**.
2. Press the **SYSTEM** icon until you see **COOL** (to turn on cooling), or until you see **HEAT** (to turn on heating).



3.3 Select options

Press the **MENU** icon and then press the **MORE OPTIONS** icon.

You will be prompted to answer 10 “Options” questions, shown below. As each option is presented:

- ✓ Use the  to answer each question.
- ✓ Use the **MORE OPTIONS**  to advance to the next question.



Options	Default Setting	Additional Information
1. Do you want the keypad lock turned on or off?	OFF (no key lockup)	Select default OFF for now. <i>To lock the keypad, see Additional Functions section 4.8.</i>
2. Do you want to be reminded when it is time to change the air filter?	ON (13 weeks)	Select default ON for now. <i>To modify a filter-change reminder, see Additional Features section 4.9.</i>
3. Do you want to be reminded when it is time to change the Humidifier Pad?	OFF (no reminder)	Select default OFF for now. <i>To set a pad-change reminder, see Additional Features section 4.10.</i>
4. Do you want the thermostat to work in Programmable Mode?	ON (programmable)	Select default ON for Programmable Mode. Select OFF to operate in Non-Programmable Mode.

TIP If you select **OFF**, your thermostat will work as a **non-programmable unit**. The clock and date will not be displayed. Some functions, identified by **PROG** in this manual, are available only in Programmable Mode.

Options	Default Setting	Additional Information
5. Does either a gas or oil furnace provide heating to your home?	GAS (for either gas or oil furnace)	Select GAS if you have either a gas or oil furnace. If you do not have a gas or oil furnace select ELE .
6. Do you have a Heat Pump?	OFF (no Heat Pump)	If you do not have a Heat Pump select OFF . If you have a Heat Pump, use the  to select (On1) for a 1-stage, or (On2) for a 2-stage Heat Pump

TIP To determine if you have a Heat Pump and/or whether it is a 1-stage or 2-stage model, see the Appendix at the end of manual.

7. Do you want the Cycle Rate to be Fast or Slow?	FA (fast)	Select SL (slow) if you have Hydronic (water or steam) Heating. Otherwise, select default FA .
8. Do you want to activate Auto Changeover function?	OFF (no Auto Changeover)	Select default OFF for now. <i>To set the function, see Additional Functions Section 4.11.</i>
9. Do you want temperature displayed in °C (Celsius) or °F (Fahrenheit)?	°F (Fahrenheit)	
10. How much displayed temperature offset do you want?	0 (no offset)	Select default 0 for now. <i>To adjust the displayed temperature reading, see Additional Functions Section 4.12.</i>

When you have answered all 10 questions, press the **DONE** icon twice.

3.4 Turn on power to your heating and cooling system.

PROG 3.5 Set time and date

1. Press the **MENU** icon and then press the **SET TIME** icon.
2. Using the ◀▶ arrows, adjust the hour then press **SET**.
3. Adjust the minutes, and press **SET**.
4. Repeat the process to set the year, month and date. The day of the week will automatically be set.
5. Press **DONE** when you are finished.



Congratulations!

You have completed the basic setup of your new thermostat. It's ready to use.

To read about additional thermostat features, continue to section 4.

PROG 3.6 Review pre-programmed schedule

The thermostat is set to control temperature according to the following pre-programmed, energy-efficient schedule. If this schedule meets your needs, no further action is required.

	Period	Mon - Fri		Sat - Sun	
		Start Time	Temp	Start Time	Temp
HEAT	Morning	6 am	70°F	6 am	62°F
	Day	8 am	60°F	8 am	70°F
	Evening	5 pm	70°F	5 pm	70°F
	Night	10 pm	62°F	10 pm	62°F
COOL	Morning	6 am	78°F	6 am	82°F
	Day	8 am	85°F	8 am	78°F
	Evening	5 pm	78°F	5 pm	78°F
	Night	10 pm	82°F	10 pm	82°F

To customize this schedule, continue to the next page (section 4.1).

Part 4 Additional thermostat features

PROG 4.1 Customize the pre-programmed schedule

You can change the day, time period or temperature settings of the pre-programmed schedule.

1. Press the **SYSTEM** icon to set to **COOL** (to program the cooling schedule), or to **HEAT** (to program the heating schedule).
2. Press the **MENU** icon, then press **SET SCHEDULE**.
The screen will look like this:

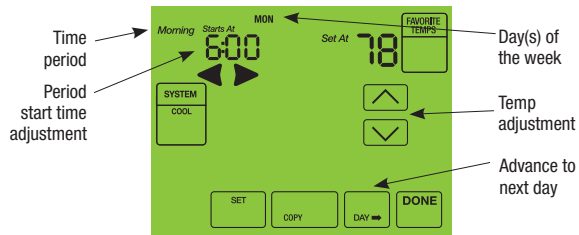

3. The schedule for Monday (**MON**) is displayed.
 - To modify the start time of the first time period (**Morning**) on that day, use the **◀▶** to change the morning time in 15-minute increments.
 - To set the temperature for that time period, use the .
 - When the time and temperature are set, press **SET**.
4. The next time period (Day) is now flashing. Program **Day** and then **Evening** and **Night** Time Periods for Monday as you programmed **Morning** in point 3.

5. To program subsequent days, use the **Easy Copy function** OR move to step 6.

Easy Copy function

- You can copy one day's schedule to other days of the week.
 - If the **Copied Day is Monday**, you can copy to the remaining working days, all remaining six days, the weekend, or any single day.
 - If the **Copied Day is not Monday**, you can copy to any other single day.
- After programming a day you want to copy, press the **COPY** icon.
 - The copied day will be displayed solid at the top of the screen.
 - Next to it, the following day(s) will be flashing. To paste the programmed schedule to the flashing day(s), press **PASTE**.
 - To paste the copied schedule to a different day, press the **◀▶** to advance through the days of the week.
 - When your targeted day is flashing, press **PASTE** to paste the schedule.

6. Press the **DAY→** icon to advance to the next day. Tuesday (**TUE**) will be displayed at the top of the screen. Program the remaining days individually as outlined on the previous page or use the Easy Copy function.
7. When you finish customizing the schedule, press the **DONE** icon twice.

4.2 Set favorite temperatures (home / sleep / away)

You can set your three most frequent temperatures (Home, Sleep, Away). You can then select the settings anytime with one touch of an icon.

4.2.1 To set Home / Sleep / Away temperatures:

1. Press the **MENU** icon, then press **SET FAVORITES**.
2. Toggle between **HOME**, **SLEEP**, and **AWAY** by pressing the **FAVORITE TEMPS** icon. Select the one you want to customize.
3. Set the desired temperature for that Favorite using the . Press **SET** to lock-in the desired temperature.
4. Repeat the process for the remaining two Favorites.
5. Press the **DONE** icon when finished.
6. You'll need to set your favorites separately for cooling and heating. For example, you might set "Away" to 88°F in the summer and 55°F in the winter.





4.2.2 Using your Favorite Temps:

1. Press **FAVORITE TEMPS** icon in the upper right corner of the screen to toggle between **HOME**, **SLEEP**, and **AWAY**.
2. By default, the Favorite temperature will automatically end at the end of the current scheduled time period.
3. You can change the end time of the Favorite by using the  until the desired end time is displayed in the clock.
4. Cancel the Favorite by pressing the **RUN SCHEDULE** icon.

TIP In non-programmable mode, your favorite temperature will remain until you change it by pressing  or selecting another Favorite Temperature.

PROG 4.3 Set temporary hold at

You can override a programmed temperature for a brief period of time.

1. Use the  to raise or lower the setting. **Temporary Hold At** will be displayed to the left of the desired temperature.
2. By default, the override will automatically cancel at the end of the current scheduled time period (Morning, Day, etc.).
3. To adjust the end time of the override, use the  until the desired end time is displayed in the upper left corner of the screen.
4. Cancel the override by pressing the **RUN SCHEDULE** icon.

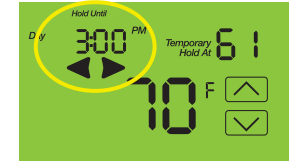
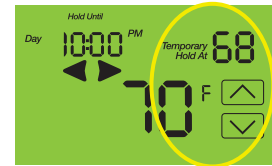

PROG 4.4 Bypass the schedule (permanent hold)

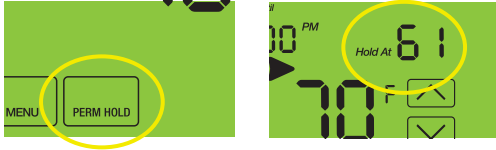

You can override the currently-programmed temperature indefinitely.

1. Use the  to raise or lower the setting.
2. When the desired temperature is displayed in the upper right corner of the screen, press the **PERM HOLD** icon at the bottom of the screen. **Hold At** will flash to the left of the desired temperature.
3. The override **will last until you cancel it**. Cancel the override by pressing the **RUN SCHEDULE** icon.



PROG 4.5 Set vacation hold

You can override a preset temperature for up to 60 days.

1. Use the  to set the desired temperature for Vacation Hold.
2. Press the **Day** icon to switch to vacation hold mode.
3. Using the  select the number of days for the vacation hold.
4. The vacation hold will automatically cancel at 8:00 am on the final day (in this example on the 5th day)
5. Cancel the Vacation Hold by pressing **RUN SCHEDULE** icon.

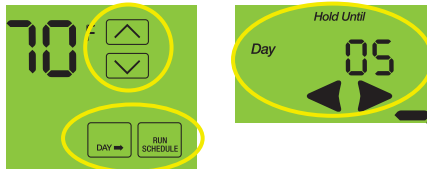

PROG 4.6 Change batteries

The thermostat displays battery life in three stages:

- Battery full 
- Battery half-full 
- Battery one-third full  **Change**  – you need to replace batteries with 2 new alkaline AA batteries

⚠ CAUTION When the batteries become only one-third full, your thermostat will automatically reduce or increase the desired temperature setting by 10 degrees to provide you with additional warning. You can adjust the temperature back, but you need to replace the batteries.

4.7 Activate permanent auxiliary heat (for Heat Pumps only)

Use this function to bypass the Heat Pump and use **ONLY** auxiliary heating. This may be a comfortable solution for the coldest days, but **it typically leads to higher energy costs.**

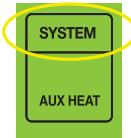

To activate the Permanent Auxiliary Heat (also known as “Emergency Heat”):

1. Press the **SYSTEM** icon until **AUX HEAT** is displayed.
2. Cancel the Permanent Aux Heat by selecting a different mode from the **SYSTEM** menu.



4.8 Set keypad lockout

4.8.1 To activate:

1. Press the **MENU** icon, then press **MORE OPTIONS**.
2. Using the  select **ON**, then press **SET**.
3. Enter a 3-digit PIN number into the thermostat. Select the first digit by using the  arrows, then use the  to advance the second and third digits of the PIN.
4. **Make note of your PIN number**, then press **DONE**.
5. The keypad is now in a locked mode and cannot be changed without first entering the PIN.

4.8.2 To unlock the thermostat:

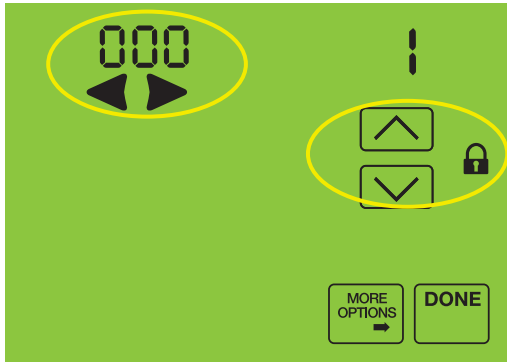

1. Press the **MENU** icon, then press **MORE OPTIONS**.
2. Enter the PIN number, then press **DONE**.



4.9 Set change filter reminder

The thermostat can display a reminder when it is time to change the air filter on your heating and cooling unit.

4.9.1 To adjust Change Filter reminder settings:

1. Press the **MENU** icon, then press **MORE OPTIONS** twice to access the **CHANGE FILTER** option.
2. Press **SET**, and use the  to select the number of weeks until the next Change Filter reminder.
3. When finished, press **SET** and then press **DONE**.
4. **CHANGE FILTER** and  will blink when it is time to change your filter.

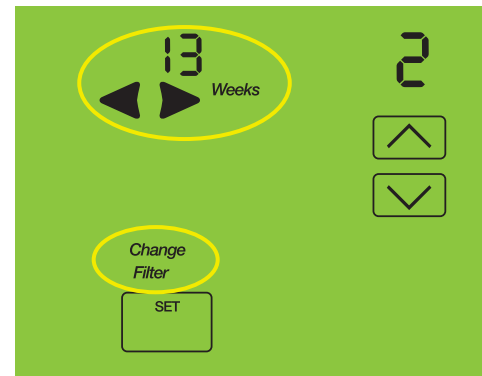

4.9.2 To reset the change filter reminder, simultaneously press the two blinking .



4.10 Set change humidifier pad reminder

If you have a humidifier in your system, the thermostat can display a reminder when it is time to change the humidifier pad.

4.10.1 To enable Humidifier Pad Reminder:

1. Press the **MENU** icon, then continue to press **MORE OPTIONS** until you access the **CHANGE HUMIDIFIER PAD** option.
2. Using the  select **ON**, then press **SET**.
3. Using the  select the number of weeks until the next Humidifier Pad reminder, then press the **SET**, then press **DONE**.
4. **CHANGE HUMIDIFIER PAD** and  will blink when it is time to change your humidifier pad.

4.10.2 To reset the change filter reminder, simultaneously press the two blinking .

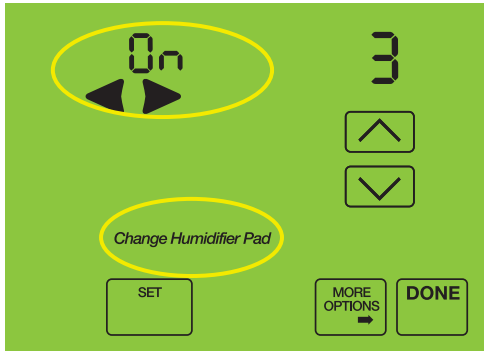

4.11 Enable auto changeover

Use this if both heating and cooling may be required in the same day. The thermostat will automatically change the system setting from heating to cooling. **For example:** In the morning heating is required. During the day, the temperature gets warmer and you want the air conditioner to run.

1. Press the **MENU** icon, then press **MORE OPTIONS**.
2. Continue to press **MORE OPTIONS** until option #8 is displayed.
3. Using the  change the setting to **ON**. Press **DONE**.
4. The **SYSTEM** settings will now include **HEAT**, **COOL**, **AUTO**, **AUXILIARY HEAT** and **OFF**.
5. You can select **AUTO** (Auto Changeover) mode by toggling through the **SYSTEM** settings list.

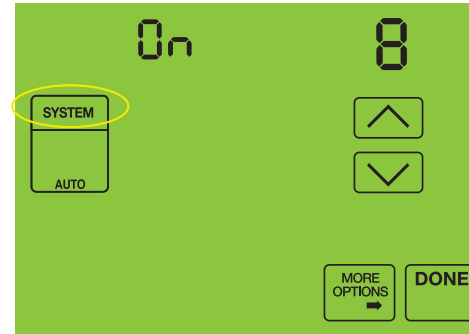

TIP When using Auto Changeover, scheduled **COOL** temperature should be set at least 2 degrees above scheduled **HEAT** temperature.

4.12 Adjust actual temperature display

Your thermostat was accurately calibrated at the factory. However, if you would like the displayed temperature to read higher or lower than the actual temperature, you can adjust the displayed temperature by +/- 4 degrees.

To adjust the actual temperature display:

1. Press the **MENU** icon, then press **MORE OPTIONS**.
2. Continue to press the **MORE OPTIONS** icon until you reach option #10.
3. Use the  to adjust the displayed temperature; from **4:LO** to **4:HI**.
4. Press **DONE**.

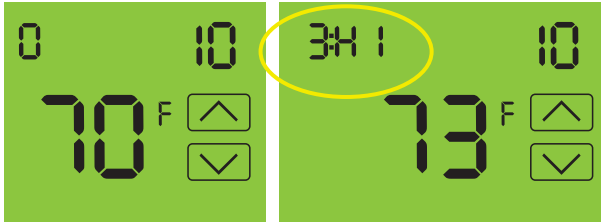

4.13 Change faceplate color

You can customize the look of the thermostat by changing the faceplate color.

1. Remove the white faceplate. Insert a small screwdriver into each of the 4 slots located on both sides of the thermostat, and pop up the white cover **in all 4 spots**.
2. Select a color from the inserts provided in the package.
3. Put the clear cover on a flat surface **face down**.
4. Fit the selected insert onto the 4 tabs located on the inside of the clear cover. Be sure the insert is properly aligned. Do not bend the insert excessively.
5. Flatten/spread the insert gently with your fingers into the clear cover. **The insert should rest securely attached to the tabs, even if you turn the cover upside-down.**
6. Snap the faceplate (with the insert in it) onto the thermostat. Make sure the cover tabs align with the installation slots in the thermostat.

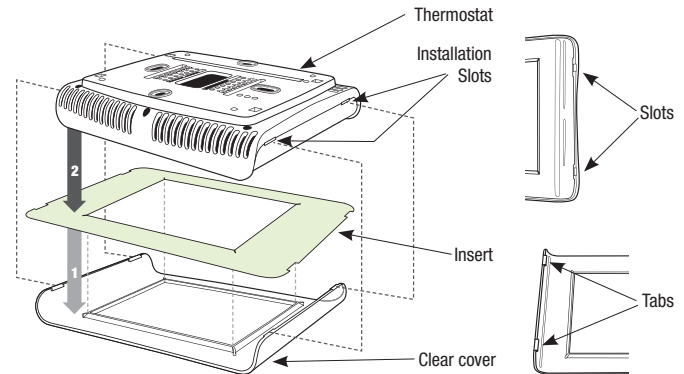

Part 5 Troubleshooting Guide

Problem	Possible Cause	Action
Temperature set point icon blinking	2-minute lockout enabled to protect compressor	No action needed: should stop blinking after 2 minutes
No Heat, No Cool, or No Fan	Blown fuse / tripped circuit breaker	Replace fuse or reset breaker
	Furnace power switch to OFF	Turn switch to ON
	Furnace blower compartment door or panel loose or not properly installed	Replace door panel in proper position to engage safety interlock or door switch
	Loose connection to thermostat or system	Tighten connections
	Low Batteries	Replace batteries
Thermostat & Indoor Thermometer Setting Disagree		The thermometer can be adjusted +/- 4 degrees. See Temperature Display Adjustment in the Configuration Menu section
No Display or no Backlight	Low Batteries	Replace batteries

5 Troubleshooting Guide (continued)

Problem	Possible Cause	Action
Thermostat doesn't follow the scheduled program	AM or PM set incorrectly in the program	Check the current settings including AM and PM designations for each time period
	AM or PM set incorrectly on the thermostat's clock	
HEAT or COOL icon flashing in Auto Changeover mode	Part of normal operation; indicates Heating or Cooling operation	No action required

Reset Operation

If a voltage spike or static discharge blanks out the display or causes erratic thermostat operation, you can reset the thermostat by pressing all three (**SYSTEM**, and press both  icons) simultaneously for 2 seconds. This reset will restore your thermostat's initial factory setting.

⚠ CAUTION Remember to turn off your heating / cooling system **BEFORE** resetting your thermostat. You will then have to go through a full initial setup described in Part 3 and Part 4 of the manual before you can turn your Heating & Cooling system back on. Failure to follow this instruction may lead to your Heating & Cooling system damage or malfunction.

Appendix: Heat Pump Identification

1. How do I know if I have a Heat Pump?

- Check the documentation for your heating and cooling system or contact your HVAC contractor.
- Confirm that you have a Heat Pump by checking the labels of the wires coming out from the wall (labels you attached according to the **right-hand column of the 2.2.2 table**).

According to the right-hand column of the 2.2.2 table, if you have:	You have:
An “ O ” wire, or a “ B ” wire	A Heat Pump

2. How do I know if I should select **On1** or **On2** for my Heat Pump?

- The labeled thermostat wires coming out of the wall indicate whether you have a **1-stage** or **2-stage** Heat Pump.

According to the right-hand column of the 2.2.2 table, if you have:	You have:
One “ Y ” wire coming from the wall	1-stage Heat Pump, select On1
One “ Y ” wire and one “ Y2 ” wire coming from the wall	2-stage Heat Pump, select On2