



OPERATING INSTRUCTIONS

M700DM4 Rugged Tablet Computer

Contents

| | |
|--|-----------|
| Chapter 1: Read Me First | 1 |
| Safety Information | 1 |
| Handling and Maintenance | 2 |
| Chapter 2: Getting Started | 3 |
| Unpacking | 3 |
| Description Of Parts | 4 |
| First-time Operation | 6 |
| Turning On / Off | 8 |
| Chapter 3: Using Android 4.2 Operating System | 9 |
| Wake Up The Tablet | 9 |
| Using the Touch Screen | 9 |
| Using the Home Screen | 10 |
| Status and Notification Icons | 12 |
| Using the On-Screen Keyboard | 13 |
| Display Setting | 16 |
| Audio Profile Setting | 16 |
| Language & Keyboard Setting | 17 |
| USB Debugging Setting | 19 |
| About Phone | 19 |
| Chapter 4: Connecting to Network and Devices | 20 |
| Connecting to Wi-Fi Networks | 20 |
| Connecting to Bluetooth Devices | 21 |
| Connecting to Computer via USB | 21 |
| Chapter 5: Using the Camera | 23 |
| Open Camera | 23 |
| Take a Picture | 23 |
| Viewing Pictures | 23 |
| Shoot a Video | 24 |
| Opening the Gallery | 24 |
| Chapter 7: Accessories | 25 |

Read Me First

Getting Started

Useful Information

Accessories

Chapter 1: Read Me First

Safety Information

Follow and adhere to all warnings and instructions in this manual. For your safety, please read all safety and operating instructions before using the product. Keep this manual for future reference.

Read Me First



Precaution on Battery Pack

Do Not Expose the Battery Pack to Excessive Heat, or Extreme Heat (Near Fire, in Direct Sunlight for example) Generation of heat, ignition or rupture may result

Do Not Disassemble, Modify, or Insert Sharp Objects Into the Battery Pack. Electrolyte leakage, generation of heat, ignition or rupture may result.

Do Not Short the Positive (+) and Negative (-) Terminals of the Battery. Generation of heat, ignition or rupture may result. When carrying or storing the device, do not place the battery pack together with articles that may contact electricity.

Do Not Apply Shocks to the Battery by Dropping It or Applying Strong Pressure to It. Electrolyte leakage, generation of heat, ignition or rupture of battery may occur.

Do Not Charge the Battery Other Than Methods Those Specified In This Manual. If the battery is not charged using one of the specified methods, electrolyte leakage, generation of heat, ignition or rupture may result.

When the Battery Pack Has Deteriorated, Replace It with a New Battery. Continued use of a damaged battery pack may result in heat generation, ignition or battery rupture.

Do Not Use the Battery Pack With Any Other Products. The battery pack is rechargeable and is only designed for this specific product. If it is used with a product other than the specified product, electrolyte leakage, generation of heat, ignition or rupture may result.

Do Not Use This Product With Battery Other Than the One Specified.



General Product Safety

This product should not be used near water such as bathtubs, sinks, swimming pools, wet basement, etc.

Do not block any ventilation openings. Do not place the product against a wall or in an enclosed space as doing so might impede the flow of cooling air.

Do not place the product near any heat sources such as radiators, warm air intakes, stoves or other heat-generating devices (including amplifiers or other heat producing equipment).

Do not disregard the safety that a polarized or grounded connection can provide. A polarized connection consists of two plugs, one of which is larger than the other. A grounded connection has two blades and a third one that is grounded. If the main plug provided cannot be inserted into your outlet, consult an electrician to replace your obsolete outlet.

Protect the power cord from being crushed or pinched, particularly in the area of the plugs, any receptacles used, and the point of exit from the apparatus. Do not break off the ground pin of the power cord.

Use only accessories specified by the manufacturer.

Use only with its transport carriage, stand, tripod, console or table specified by the manufacturer or sold with the product. When using a carriage, move the carriage assembly with the product carefully to avoid damage from falling over.

Unplug this apparatus during lightning storms or when it is not being used for long periods.

Refer all servicing to qualified service personnel. A technical intervention is required when the apparatus has been damaged in any way, for example if the power cord or plug is damaged, liquid has been spilled or objects have fallen inside the unit, if the product has been exposed to rain or moisture, if it does not operate normally or if it has been dropped.

To maximize the life of the backlight in the display, allow backlight to automatically turn off as a result of power management. Avoid using a screen saver or other software that prevents the power management from working.



Cleaning Guideline

Use a soft cloth moistened with water or a non-alkaline detergent to wipe the exterior of the product.

Gently wipe the display with a soft, lint-free cloth. Do not use alcohol or detergent on the product.

Read Me First

Handling and Maintenance

Follow and adhere to all warnings and instructions in this manual. For you're the longevity of the product usage, please read all operating instructions before using the product. Keep this manual for future reference.



General Guideline

Keep the product at least 13 cm (5 inches) away from electrical appliances that can generate a strong magnetic field such as TV, refrigerator, motor, or a large audio speaker.

Do not place heavy objects on top of the tablet computer as this may damage the display.

The screen surface can be easily scratched. Use with care. Do not use paper towels to clean the display but use the included cleaning cloth. Avoid touching it with a pen or pencil.



Touchscreen Guideline

Use your finger or the stylus on the display. Using sharp or metallic object may cause scratches and damage the display, thereby causing errors.

Use a soft cloth to remove dirt on the display. The touchscreen surface has a special protective coating that prevents dirt from sticking to it. Not using a soft cloth may cause damage to the special protective coating on the touchscreen surface. To clean off hard to remove dirt, blow some steam on the particular area and gently wipe away using a soft cloth.

Do not use excessive force on the display. Avoid placing objects on top of the display as this may cause the glass to break.

When there is a noticeable discrepancy in the operation of the touchscreen function (your touch does not correlate to the proper location on the screen), recalibrate the touchscreen display.

Chapter 2: Getting Started

Congratulations on purchasing this Android rugged Tablet Computer. The rugged design allows you to use it in harsh outdoor environments.

This chapter tells you step by step how to get the Tablet Computer up and running. You will find instructions for the following procedures:

- Unpacking
- Description of Parts
- First Time Operations
- Turning On/Off

Unpacking

Check and identify the supplied accessories:

Getting Started

- Tablet Computer

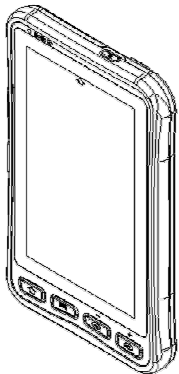

- Standard Battery

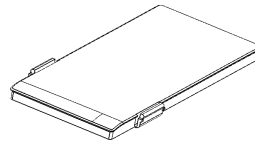

- Universal Adapter



- Quick Start Guide



- Driver CD



Description Of Parts

Front :

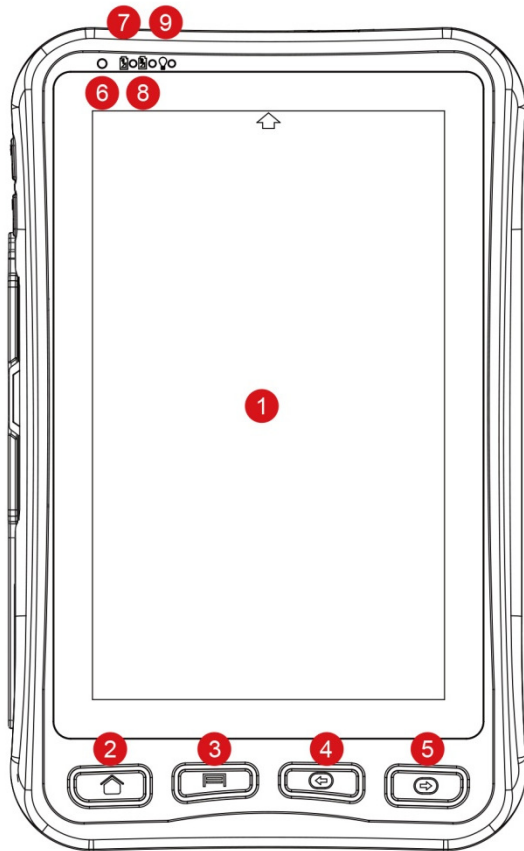

Left :



Getting Started

| No | Item | Description | No | Item | Description |
|-------|-----------------|---|----|--------------------|---|
| 1 | 7" Touch Screen | Displays and act as one of the inputs for the Tablet Computer | 9 | Power Mode Status | Blue light : indicates the Power On No light : indicates no Power |
| 2 | Home Button | Return to home screen | 10 | Standard I/O Cover | Use to give IP protection to the device |
| 3 | Menu Button | Open a list of actions that user can do on the current screen | 11 | Volume Up | Increase the volume of music or radio |
| 4 | Return Button | Return to the previous screen | 12 | Volume Down | Decrease the volume of music or radio |
| 5 | Trigger Button | If the device was equipped with scanners, this button can be function as a trigger button | 13 | Audio Jack | To connect a set of headphones, external speakers, or an audio device |
| 6 | Light sensor | To control screen brightness | 14 | Power Jack | DC-IN power input jack |
| 7 / 8 | Battery Status | Green light : Indicates the device is charging Red light : Indicates low battery | 15 | USB ports | To connect USB flash drive 2.0 / mouse / printer / keyboard, etc |

| No | Item | Description |
|----|---------------------|---|
| 16 | MicroSD Card Reader | Memory card reader port for MicroSD Card |
| 17 | SIM card slot | Service window to insert Micro SIM card. |
| 18 | Docking connector | Port to docking solutions such as vehicle docking to provide power and external antenna |

Front LED Indicators Detail :



Rear :

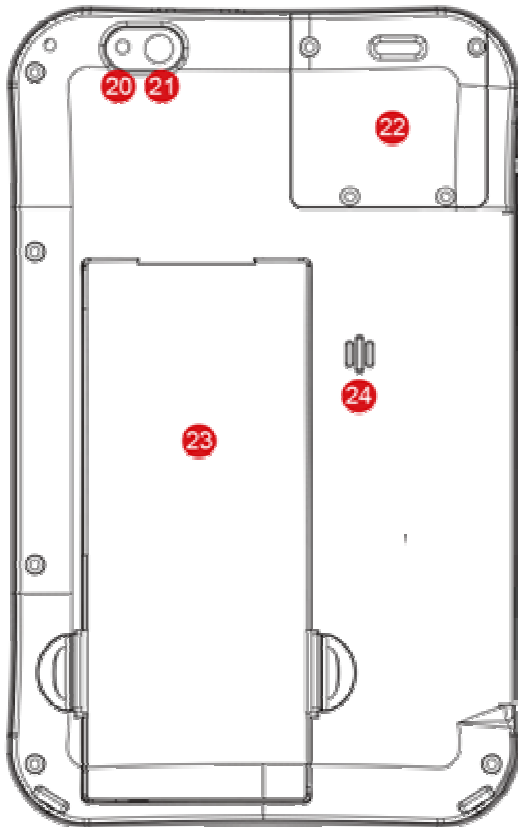

Top :

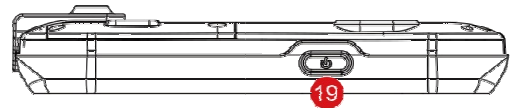

| No | Item | Description |
|----|--------------|--|
| 19 | Power Button | <p>Press and hold the button for 3 seconds to turn on M700DM4</p> <p>Press to turn on/off the screen</p> <p>Press and hold the button for 3 seconds to select:</p> <ul style="list-style-type: none"> • Power Off -- to turn off the M700DM4 press button for 8 Sec to force system power off • Airplane mode – to disable all wireless connection • Restart – to restart the device |

| No | Item | Description |
|----|---------------------|---|
| 20 | LED auxiliary light | To provide lighting while using camera |
| 21 | Rear Camera | 5MP Autofocus Camera. Captures photos and videos. |
| 22 | Optional Barcode | Barcode Scanner for reading of 1D/2D barcode. |
| 23 | Battery | Replaceable batter 3.7V 5300mAh battery |
| 24 | Speaker | Provide audio output for music and video |

Getting Started

First-time Operation

Inserting Battery Pack

To insert the included standard battery pack into the Tablet Computer:

1. Disconnect any cords connected to the tablet computer.
2. Turn the tablet computer over, back facing up.
3. Insert the battery on the connector-pins side first, and then lower the battery into the battery compartment. Continue to hold the Battery Locker before battery is fully inserted.
4. Make sure the battery is completely lowered into the compartment before letting go the Battery Locker. Battery will be flat against the housing once fully inserted.

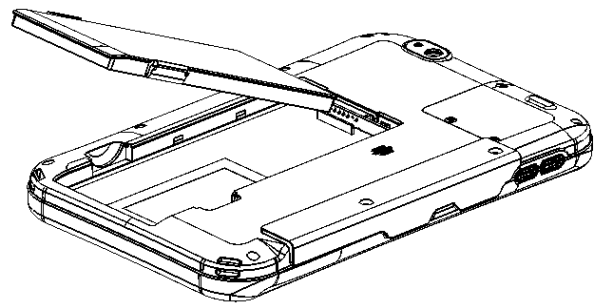
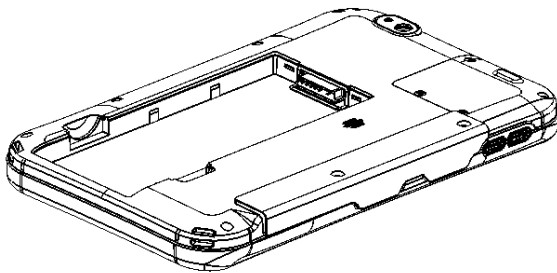

Removing the Battery Pack

1. Shut down the tablet computer. Disconnect any cords connected to the computer.
2. Turn the tablet computer over, back facing up.
3. Locate the Battery Lock and push it to the "Unlocked" position.
4. Pull back and hold.
5. Lift the battery out using the opening on side of battery compartment.

Connecting to Power Supply

The Tablet Computer operates either on external AC power or internal battery power. It is recommended to use AC power when you start up the Tablet Computer for the first time.



Caution

Use only the AC adapter included with your Tablet Computer. Using other AC adapters may damage the Tablet Computer and the Battery.

Perform the following to connect the Tablet computer to AC Power:

1. On the side of the Tablet computer, lift the I/O protective cover by pulling on the latch.
2. Plug the AC adapter into the Power Jack of the tablet computer.
3. Finally, Plug the AC adapter power cord into the electrical outlet.



When the AC Adapter is connected, the battery pack starts charging. The battery LED indicator on the tablet computer would show different states. Please refer to description of LED indicator on Description of Parts.

Turning On / Off

Turning On

1. Place the device on a flat and stable surface or hold it
2. Make sure the device is either connected to AC power or to the battery pack with power
3. Press and hold the power button for 3 seconds, located on the top part of the unit

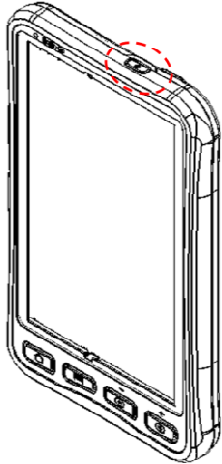

Note:

- Do not press the power switch repeatedly.
- Do not perform the following operations until the hard drive indicator turns off
 - Connecting or disconnecting the AC adapter
 - Pressing the power switch
 - Touching the tablet buttons, screen, or external keyboard/mouse

Turning Off

Perform the following procedure to shutdown the Tablet Computer:

1. Make sure you have closed any programs that are open on the Desktop.
2. To turn off the device, press and hold the power button until the phone options menu appears, tap the **Power off**.
3. User can also use the Phone options menu to put the device into silent or airplane mode, see features table.
4. Wait for Tablet Computer to power off.

Note:

- The computer will forcefully be turned off if the power switch is pressed and held for six seconds or longer.

Chapter 3: Using Android 4.2 Operating System

This section details how to use Android 4.2 operating system on the tablet for the first time.

Wake Up The Tablet

If you do not use the tablet for a while, the screen dims and then darkens to conserve the battery. To wake up the tablet:

1. Press the **Power** button on the top of the Tablet PC
2. Drag the lock icon to the right

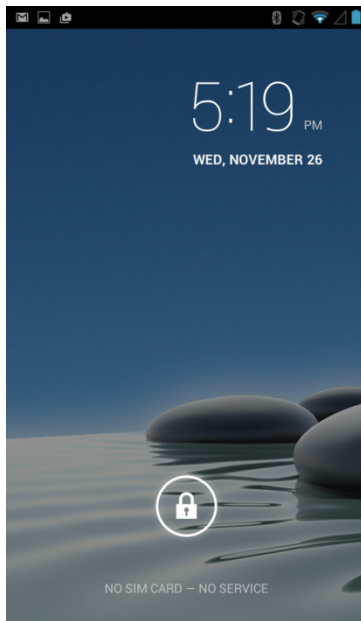

3. There are several options to choose the screen lock method such as Slide, Voice Lock, Pattern, PIN or Password
4. To select the screen lock method, tap  select **Settings** and then select **Security**

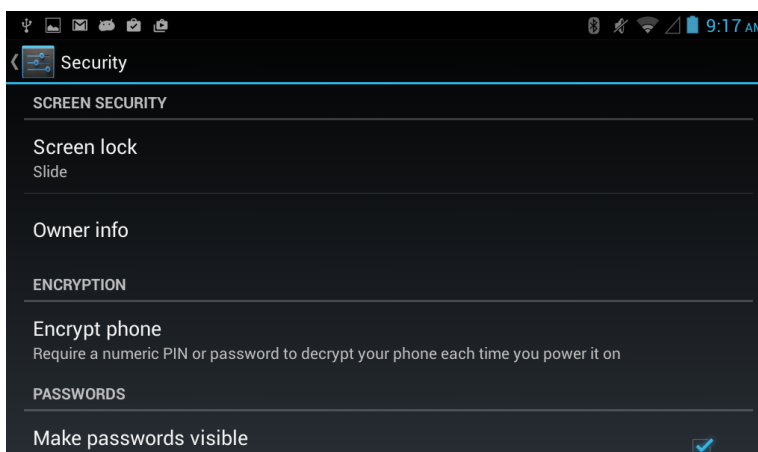

Using the Touch Screen

To gain full access of the Android interface is by using your finger to manipulate icons, on screen keyboard, menu items, and other items on the touch screen.

- *Tap* – Simply touch the icon, symbol, or onscreen button using your finger
- *Tap and hold* – Touching an item using your finger and not lifting it until an action occurs
- *Drag* – Touch and hold an item for some amount of time and then, without lifting your finger, move your finger along the screen until you reach target position
- *Swipe or slide* – Quickly move your finger across the surface of the screen, without pausing it when you first touch it. (e.g. scroll a page or a list up or down)
- *Double tap* – Tap quickly twice on a webpage, map, or other screen to zoom. Double tapping after pinching the zoom in some application to fit the width of the screen
- *Pinch* – Place two fingers on the screen at once and pinching them together (to zoom out) and spreading them apart (to zoom in).
- *Rotate the screen* – Orientation of the screens rotates with the phone as user turn it from upright to its side and back again.

Using the Home Screen

Home screen is the starting point to access all the features on your PDA Device. It displays application icons, widgets, shortcuts, and other features. User can personalize the home screen. See “Personalizing home screen”

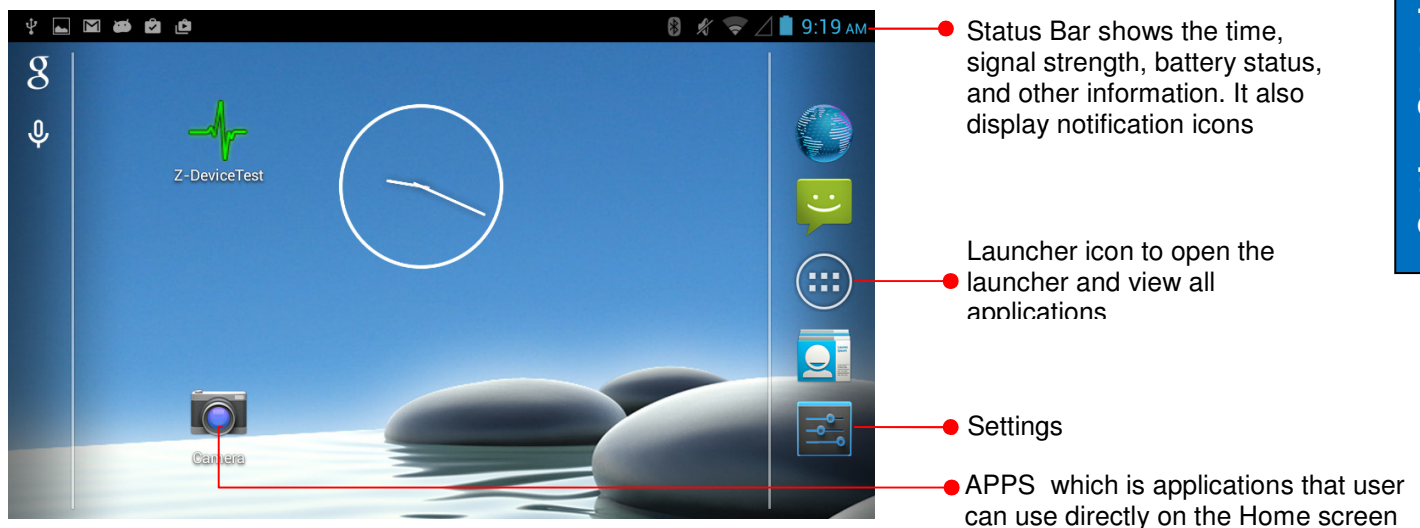

Personalizing Home Screen

User can add application icons, shortcuts, widgets, and other items to any part of any Home screen where there is free space. User can also switch the wallpaper.

To change wallpaper on the Home screen:

1. Tap  and select **Setting**, select **Display** and then tap **Wallpaper**
2. On the menu that opens tap the type of item you want to add.

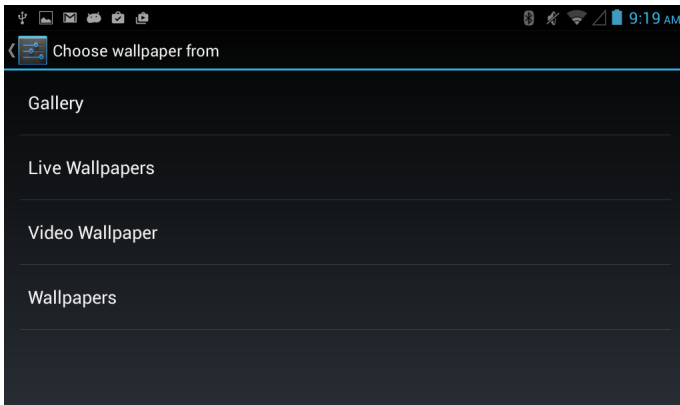

To move an item on the Home screen:

1. Tap and hold the item you want to move, until it can be moved.
2. Drag it to a new location on the screen
3. Place the item where you want to put it and lift your finger

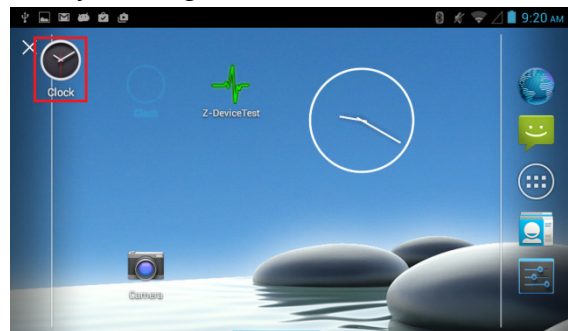
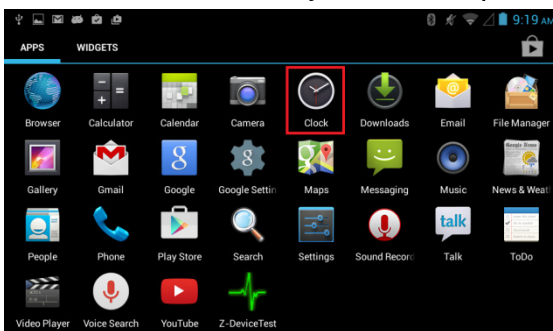

To move an item on the Home screen:

1. Tap and hold the item you want to remove. The launcher icon will change into a Remove icon
2. Drag the item you want to remove to the Remove icon on the top of the screen
3. When the icon turns red, release your finger



View other parts of the home screen

1. Slide your finger left or right across the Home screen
Extensions to the Home screen provide extra space for APPS, shortcuts, and other items.
2. Tap the launcher icon  (on the upper right part) to view the entire APPS and Widgets of the device

APPS

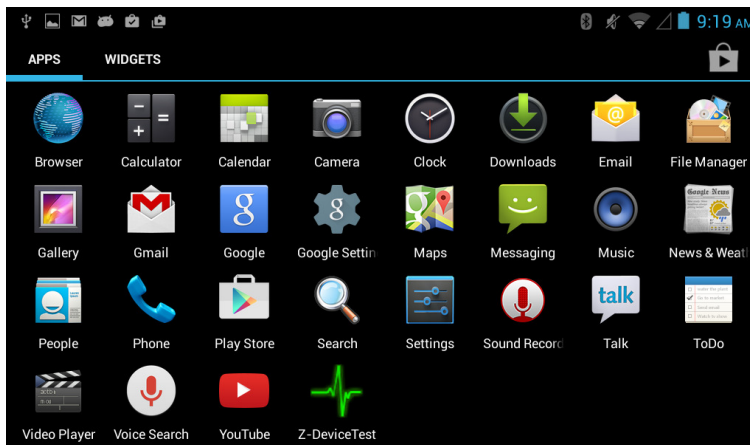

WIDGETS

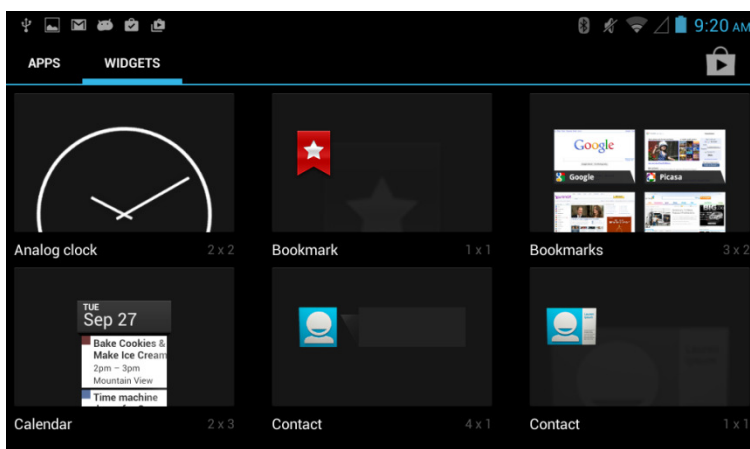

Getting Started











Status and Notification Icons

The status bar appears at the top right of every screen, along with the current time and on the bottom left are navigation icons.









Status Icons

The following icons indicate the status of your Tablet PC, for example if users are connected to a Wi-Fi network that is not connected to the internet, the network icons are appears in white color. User can view the details by touching the clock at the bottom right of the screen. Status icons that appear in the status bar are as follows:

| | | | |
|---|---------------------------------|---|------------------------------|
|  | Connected to a Wi-Fi network |  | Battery is very low |
|  | Roaming |  | Battery is low |
|  | Airplane mode |  | Battery is partially drained |
|  | Bluetooth is on |  | Battery is full |
|  | Connected to a Bluetooth device |  | Battery is charging |

Notification Icons

The following icons indicate that you have received notification

| | | | |
|---|-------------------|---|----------------------------------|
|  | New email message |  | A screenshot is captured |
|  | Alarm is set |  | Downloading data |
|  | Upcoming event |  | Phone is connected via USB cable |

Using the On-Screen Keyboard

User will be able to enter text using the On-Screen Keyboard. Some applications will launch the keyboard automatically. In others, user needs to touch a text field where user wants to enter text to launch the keyboard.

Enter text by Typing



1. Open a text field, in this example we used Chrome to create a text, The On-Screen Keyboard opens.

Tap once to capitalize the alphabet

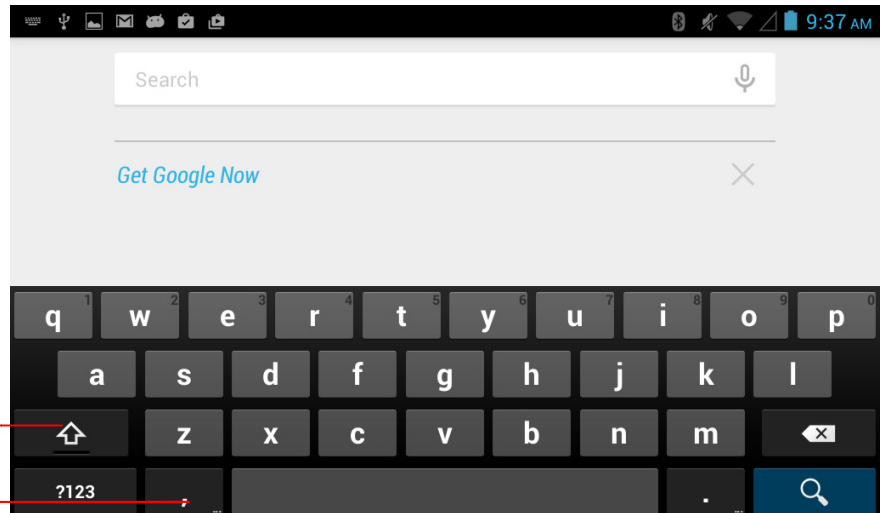
Tap and hold for input options



If user taps in a text field which already contains text, the insertion point is set where user tap and the cursor appears. User can drag the cursor to pick exactly where you want to add more text. User can also select a word to copy, cut and paste it. See “Editing Text”

2. Tap the delete key  to erase characters to the left of the cursor
3. Tap  to enter numbers. Tap  to return to letters
4. To enter symbols and other characters, tap and hold one of the top-row keys and slide your finger up to the list of the options. Lift your finger when you find your selection.

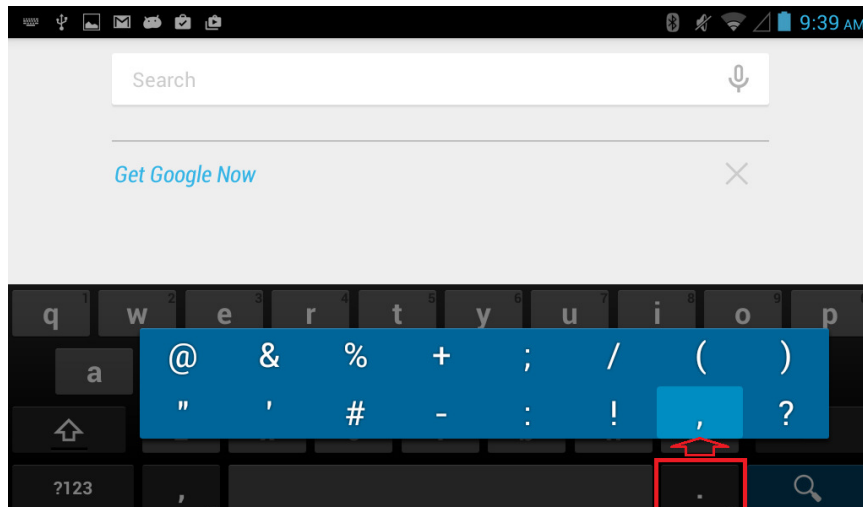



Editing text

To select text

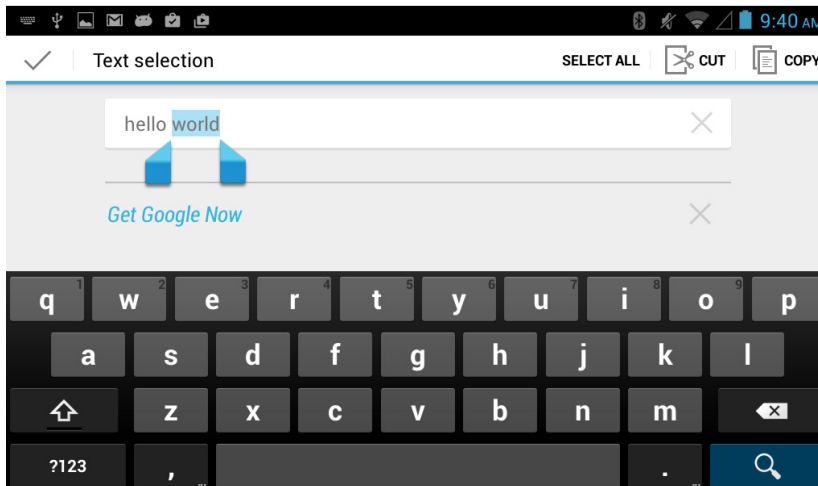
1. Double tap the text you want to select
2. Tap **Select All** to select all the sentences in the menu that appears, the selected text is highlighted in blue, with a tab at each end of the selected word
3. Drag selection tab to expand or reduce the range of the selected text



To Cut or Copy Text

1. Select the text to cut or copy, see “to select text”
2. Tap  or  in the Edit text menu
3. If you select , the selected text is removed from the text field; it is stored in temporary area so that you can paste it into different text field.

To Paste Text

1. After Cut or Copy the text, see “To Cut or Copy Text”
2. Place the cursor in the text field where you want to paste the text, user can paste text that you copied from one application into a text field in any application
3. Tap and hold into the location that you want to paste, Tap **Paste** in the menu that opens to replace the existing text with copied text

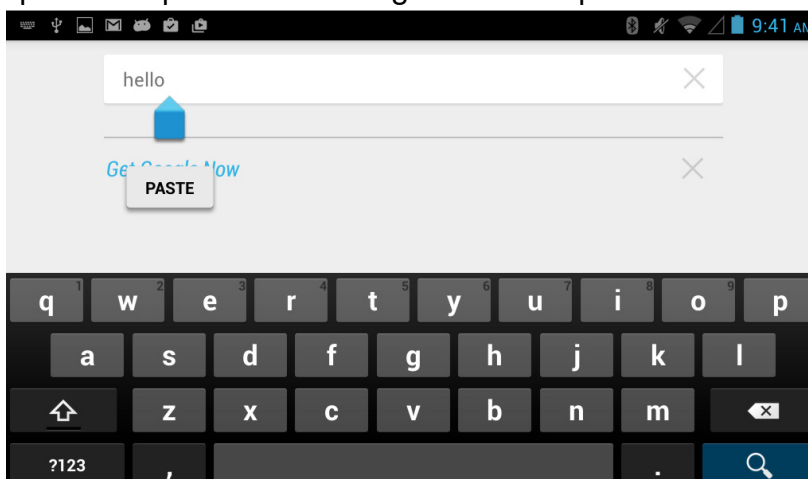

Display Setting

Use the display settings to configure brightness.

1. Tap  and select **Settings** and then tap **Display**
2. Tap **Brightness**:
 - Tap Automatic Brightness – for adjusting the brightness automatically.
 - Tap Economical Backlight to save power
 - Slide the bar to adjust the brightness manually



For the longest battery life between charges, use the lowest brightness level

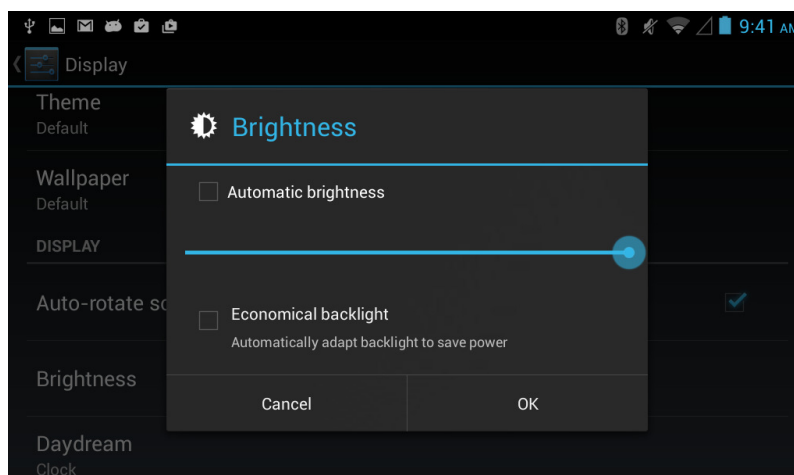

Use the display settings to configure Font size.

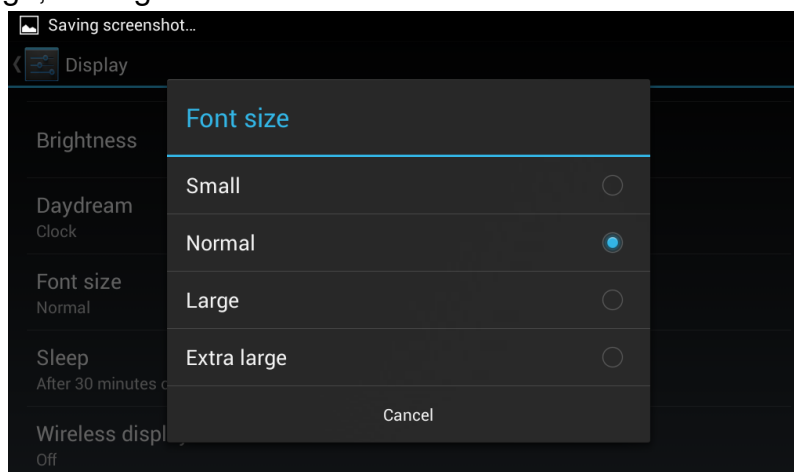

1. Tap **Font Size** to adjust the size, there are several options such as: Small, Normal , Large, or Huge



Audio Profile Setting

Use the sound settings to configure how and at what volume the phone rings, vibrates or alerts user in other ways when user receive a call, receive a notification or an alarm sounds.

Sound Settings

1. Tap  and select **Settings** and then tap **Audio profiles**
2. Tap **General** and then tap the **Settings** (located on the right side of the screen ) user can select to disable or adjust the Music, video games & other media as well as notifications and Alarms

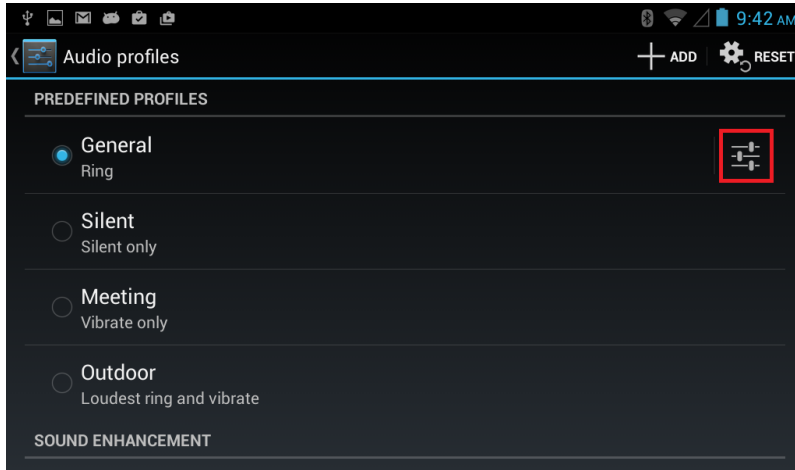

Adjust Volume

1. Press the volume keys to change the ring volume (On Home screen) or earpiece volume (during a call)

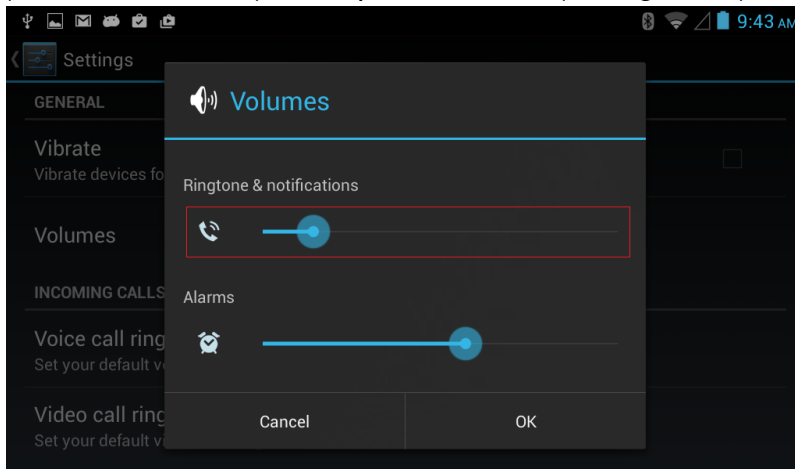

Language & Keyboard Setting

Use the Language & keyboard settings to select the language for the text on your phone and for configuring On-Screen Keyboard, including words that you have added to its dictionary

1. Tap  and select **Settings** and then tap **Language & input**
2. Tap **Language & Input**
language – to open the language screen, where user can select the language to use for the text on the device.

Spell checker – to improve the text-input experience on Android by helping the user quickly identify and correct spelling errors

Personal dictionary – to add custom words to a personal dictionary for faster typing

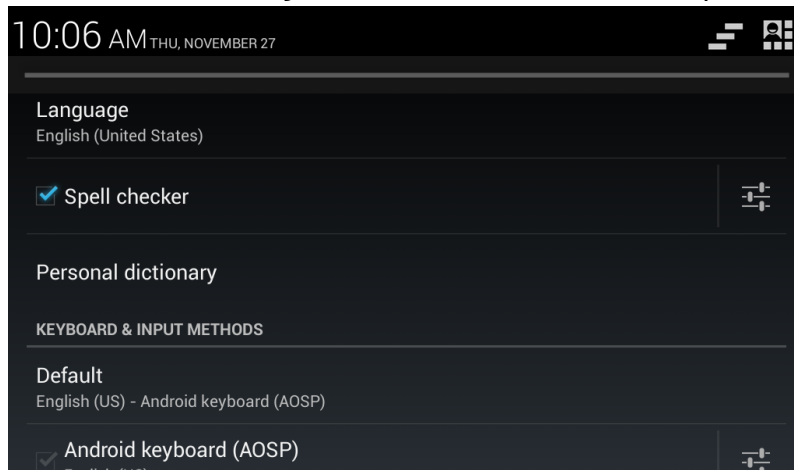

Change the Keyboard Language

The current keyboard language is displayed on the Settings icon and user can switch languages.

1. Tap the keyboard icon located on the top right, there are four input options **Hardware-physical keyboard, English (US)- Android Keyboard, and Google voice typing**

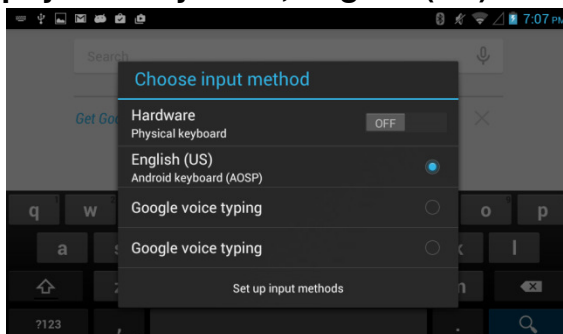

2. If you want to use **Android Keyboard**, make sure to disable the **Hardware-physical keyboard**
3. Tap **English (US)- Android Keyboard** and in the **Set up input methods**, user can select the languages by tapping (insert icon) and then select the **Input languages >> ACTIVE INPUT METHODS**

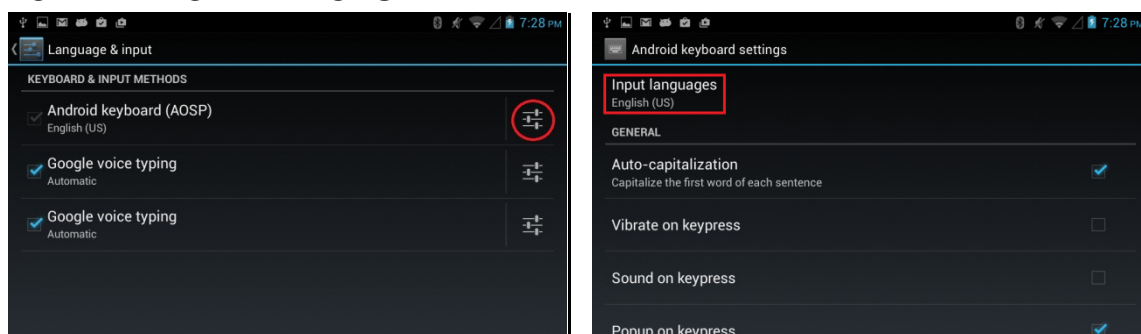

4. Tap **android keyboard settings** to adjust the settings such as Auto capitalization, auto correction or other options

USB Debugging Setting

To permit debugging tools on a computer to communicate with User's Tablet via USB Connection.

1. Tap  and select **Settings** and then Tap { } **Developer options** and then tap **USB debugging**
2. If the USB is connected, there will be a symbol in the notification icons on the bottom right

About Phone

System Update — provides information regarding the local or online update of your devices



Status — opens the status screen with a list of information about battery, network, signal strength and other details

Legal Information — lists details about the model number, Android Version, Baseband version etc. this information is useful if user need to work with support team

Chapter 4: Connecting to Network and Devices

Connecting to Wi-Fi Networks

Turn On the Wi-Fi and Connect to a Wi-Fi network

1. Tap  and then tap **Settings**
2. Tap **Wireless & networks** and then select **Wi-Fi** to turn it on
3. Tap **Wi-Fi**
The device scans for available Wi-Fi networks and displays the list of it. Secured networks are indicated with a lock icon 
If the phone finds a network that you have connected previously, it connects to it automatically.
4. Tap a network to connect to it;
 - If the network is open, you are prompted to confirm that you want to connect it by tapping **Connect**
 - If the network is secured, users are prompted to enter a password or other credentials
5. To check the details about the speed, security, address and related settings, tap its name in the Wi-Fi settings screen

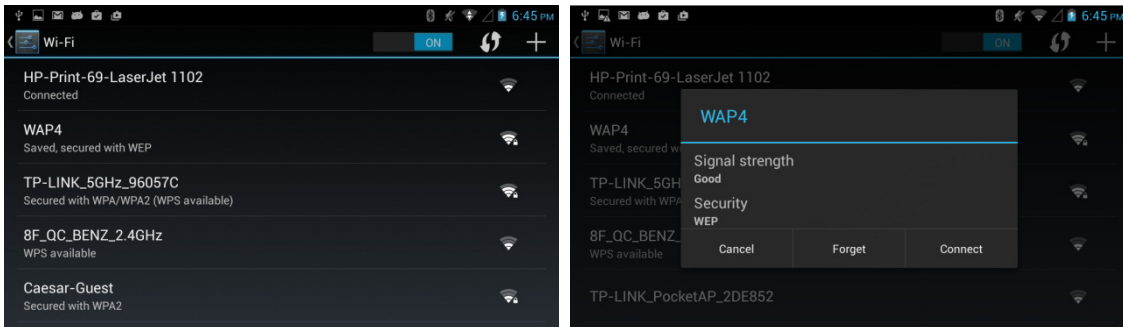

Add a Wi-Fi Network

1. Turn on Wi-Fi, in the Wi-Fi settings screen, tap  icon (at the top right of the list of discovered networks)
2. Input the SSID (name) of the network, if the network is secured, tap the security menu and then tap the type of security deployed on the network.
3. Enter any required security credentials
4. Tap **Save**

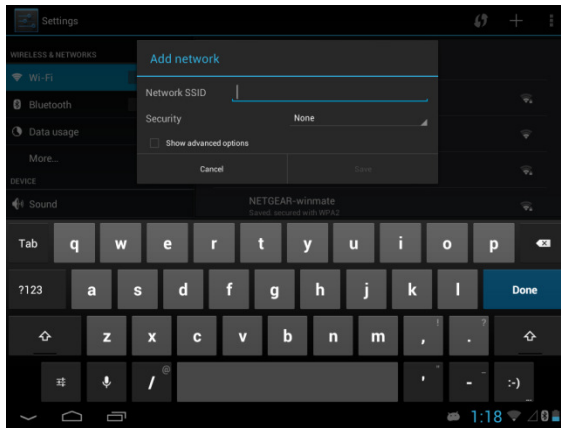

Connecting to Bluetooth Devices

Turn Bluetooth On or Off

1. Tap  and then tap **Settings**
2. Tap **Wireless & networks** and then select **Bluetooth** to turn it on

Connect to a Bluetooth device

1. Tap  and then tap **Settings**
2. Tap **Wireless & networks**, and then tap **Bluetooth**
3. It will automatically scans and displays the IDs of all available Bluetooth devices in range. Tap **SEARCH FOR DEVICES** to search other Bluetooth devices
4. Tap the ID of the other device in the list in Settings to pair them



Disconnect from a Bluetooth Device

1. Tap the device in the Bluetooth settings screen
2. Tap **OK** to confirm that you want to disconnect

Connecting to Computer via USB

User can connect their Tablet PC to a computer with USB cable to transfer files between Tablet PC and computer



When connecting your Tablet PC to a computer and mounting its USB storage or SD card, user must follow the computer's instructions for connecting and disconnecting USB device, to avoid damaging or corrupting files.

To connect your Tablet PC to a computer via USB:

1. Use the USB cable that came with your Tablet PC to connect the device to a USB port on your computer
2. After received a notification that the USB is connected, tap the notification icon and then tap **USB connected** 
3. Select **Turn on USB Storage** to let user transfer media files on windows, or using Android File Transfer

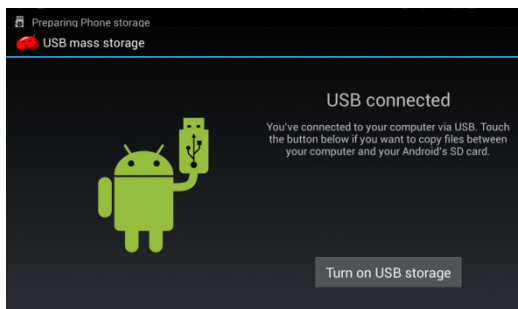

4. When the device is connected as USB storage, the screen indicates that USB storage is in use and user will receive a notification



Carefully follow your computer's instructions to un-mount the USB storage or SD card. Disconnect USB device not properly can cause a loss of important data or information.



When user finished, simply disconnect the tablet by unplugging the USB cable.

Chapter 5: Using the Camera

Winmate M700DM4 equipped with 5 MP on the rear side, which user can use to capture photos or video

Open Camera

1. Tap the **launcher** and then tap **Camera** 

Camera opens in Portrait mode, ready to take a picture or shoot a video



Note

Make sure the protective lens cover is clean before taking pictures. A lens cover with smudges from fingers can cause blurry picture

Take a Picture

1. Adjust the exposure, flash, and other necessary settings. Or leave it automatic.
2. Frame your subject / object on screen
Pinch to zoom in or out.
3. Tap the On Screen Shutter icon 

The camera brings the image into focus, when the image is in focus, the focus indicators in each corner will turn green and ready to capture
4. Touch  to change camera settings

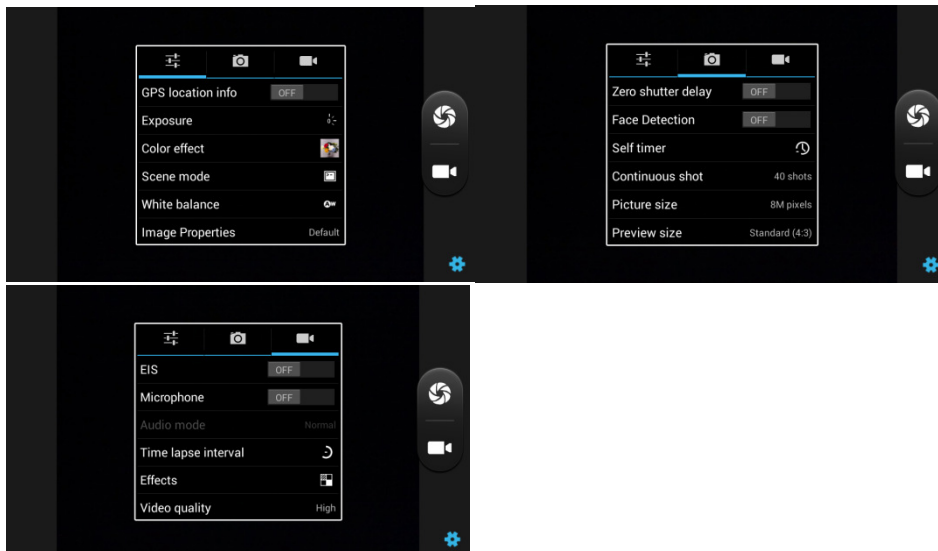

Viewing Pictures

1. After taking a photo, a thumbnail of the picture is shown on the corner of the capture screen. Tap the thumbnail to view it
2. Tap the onscreen button



to share photo





to delete photo



to view other photo or video in the galleries Swipe right or left to view more

Shoot a Video

1. Tap  to switch from camera to video mode
2. Point the lens to record the scene where you want to start
3. Tap the On Screen  icon to start recording
The time remaining to shoot counts down at the left; when less than a minute is left, the countdown turns red
4. Tap the  icon again to stop shooting



Opening the Gallery

1. Tap the **launcher** and then tap **Gallery** 
2. Tap a folder to view the pictures or video inside in full screen mode
3. Flick the pictures left or right to view the previous or next picture

Chapter 7: Accessories

The tablet computer offers the following optional accessories that can be purchased:

| | |
|--|--|
| <p>Vehicle Dock</p> <ul style="list-style-type: none"> • VESA Mounting support • USB 2.0 x 2 • LAN (10/100) • COM (RS232) • 9-36V DC IN with 3-pin terminal block • Easy insert and release with key-lock | <p>Desk Dock</p> <ul style="list-style-type: none"> • USB 2.0 x 4 (Rear x 2, Side x 2) • LAN (10/100) • COM (RS232) • 12V DC IN |
| <p>Carry Bag</p> <ul style="list-style-type: none"> • Allow users to carry the device easily | <p>Hand Strap</p> <ul style="list-style-type: none"> • Ergonomic hand-strap can help you handle the Rugged Tablet PC much more easily and comfortably. |
| <p>Capacitive Touch Stylus</p> <ul style="list-style-type: none"> • For Capacitive Touch | <p>Micro SD Card</p> <ul style="list-style-type: none"> • 4GB Micro SD Card |

FCC Statement

1. This device complies with Part 15 of the FCC Rules. Operation is subject to the following two conditions:

(1) This device may not cause harmful interference.

(2) This device must accept any interference received, including interference that may cause undesired operation.

2. Changes or modifications not expressly approved by the party responsible for compliance could void the user's authority to operate the equipment.

NOTE: The manufacturer is not responsible for any radio or TV interference caused by unauthorized modifications to this equipment. Such modifications could void the user's authority to operate the equipment.

NOTE: This equipment has been tested and found to comply with the limits for a **Class B** digital device, pursuant to part 15 of the FCC Rules. These limits are designed to provide reasonable protection against harmful interference in a residential installation.

This equipment generates uses and can radiate radio frequency energy and, if not installed and used in accordance with the instructions, may cause harmful interference to radio communications. However, there is no guarantee that interference will not occur in a particular installation. If this equipment does cause harmful interference to radio or television reception, which can be determined by turning the equipment off and on, the user is encouraged to try to correct the interference by one or more of the following measures:

- Reorient or relocate the receiving antenna.

- Increase the separation between the equipment and receiver.

-Connect the equipment into an outlet on a circuit different from that to which the receiver is connected.

-Consult the dealer or an experienced radio/TV technician for help

The SAR limit of USA (FCC) is 1.6 W/kg averaged over one gram of tissue. Device types Portable Tablet Computer (FCC ID: PX9M700) has also been tested against this SAR limit. The highest SAR value reported under this standard during product certification when properly worn on the body is 0.351W/kg. This device was tested for typical body-worn operations with the back of the handset kept 0cm from the body. To maintain compliance with FCC RF exposure requirements, use accessories that maintain a 0cm separation distance between the user's body and the back of the handset. The use of belt clips, holsters and similar accessories should not contain metallic components in its assembly. The use of accessories that do not satisfy these requirements may not comply with FCC RF exposure requirements, and should be avoided.

IC Statement

This device complies with RSS-210 of Industry Canada.

Operation is subject to the following two conditions:

(1) this device may not cause harmful interference, and

(2) this device must accept any interference received, including interference that may cause undesired operation.

Le présent appareil est conforme aux CNR d'Industrie Canada applicables aux appareils radio exempts de licence. L'exploitation est autorisée aux deux conditions suivantes :

- (1) l'appareil ne doit pas produire de brouillage, et
- (2) l'utilisateur de l'appareil doit accepter tout brouillage radioélectrique subi, même si le brouillage est susceptible d'en compromettre le fonctionnement.