



# OPERATING INSTRUCTIONS

Rugged Tablet Computer  
M101 Series

## Contents

<b>Chapter 1: Read Me First</b>	<b>1</b>
Safety Information	1
Handling and Maintenance	2
<b>Chapter 2: Getting Started</b>	<b>3</b>
Unpacking	3
Description Of Parts	4
First-time Operation	7
Turning On / Off	9
<b>Chapter 3: Useful Information</b>	<b>10</b>
HotTab Operation	10
Hot Swapping Batteries	18
Accessories	18
<b>Chapter 4: Troubleshooting</b>	<b>19</b>
Troubleshooting (Basic)	19

Read Me First

Getting Started

Useful Information

Troubleshooting

Appendix

Please read these instructions carefully before using this product, and save this manual for future use.

# Chapter 1: Read Me First

## Safety Information

Follow and adhere to all warnings and instructions in this manual. For your safety, please read all safety and operating instructions before using the product. Keep this manual for future reference.

Read Me First



### **Precaution on Battery Pack**

Do Not Expose the Battery Pack to Excessive Heat, or Extreme Heat (Near Fire, in Direct Sunlight for example) Generation of heat, ignition or rupture may result

Do Not Disassemble, Modify, or Insert Sharp Objects Into the Battery Pack. Electrolyte leakage, generation of heat, ignition or rupture may result.

Do Not Short the Positive (+) and Negative (-) Terminals of the Battery. Generation of heat, ignition or rupture may result. When carrying or storing the device, do not place the battery pack together with articles that may contact electricity.

Do Not Apply Shocks to the Battery by Dropping It or Applying Strong Pressure to It. Electrolyte leakage, generation of heat, ignition or rupture of battery may occur.

Do Not Charge the Battery Other Than Methods Those Specified In This Manual. If the battery is not charged using one of the specified methods, electrolyte leakage, generation of heat, ignition or rupture may result.

When the Battery Pack Has Deteriorated, Replace It with a New Battery. Continued use of a damaged battery pack may result in heat generation, ignition or battery rupture.

Do Not Use the Battery Pack With Any Other Products. The battery pack is rechargeable and is only designed for this specific product. If it is used with a product other than the specified product, electrolyte leakage, generation of heat, ignition or rupture may result.

Do Not Use This Product With Battery Other Than the One Specified.



### **General Product Safety**

This product should not be used near water such as bathtubs, sinks, swimming pools, wet basement, etc.

Do not block any ventilation openings. Do not place the product against a wall or in an enclosed space as doing so might impede the flow of cooling air.

Do not place the product near any heat sources such as radiators, warm air intakes, stoves or other heat-generating devices (including amplifiers or other heat producing equipment).

Do not disregard the safety that a polarized or grounded connection can provide. A polarized connection consists of two plugs, one of which is larger than the other. A grounded connection has two blades and a third one that is grounded. If the main plug provided cannot be inserted into your outlet, consult an electrician to replace your obsolete outlet.

Protect the power cord from being crushed or pinched, particularly in the area of the plugs, any receptacles used, and the point of exit from the apparatus. Do not break off the ground pin of the power cord.

Use only accessories specified by the manufacturer.

Use only with its transport carriage, stand, tripod, console or table specified by the manufacturer or sold with the product. When using a carriage, move the carriage assembly with the product carefully to avoid damage from falling over.

Unplug this apparatus during lightning storms or when it is not being used for long periods.

Refer all servicing to qualified service personnel. A technical intervention is required when the apparatus has been damaged in any way, for example if the power cord or plug is damaged, liquid has been spilled or objects have fallen inside the unit, if the product has been exposed to rain or moisture, if it does not operate normally or if it has been dropped.

To maximize the life of the backlight in the display, allow backlight to automatically turn off as a result of power management. Avoid using a screen saver or other software that prevents the power management from working.

## Handling and Maintenance

Follow and adhere to all warnings and instructions in this manual. For you're the longevity of the product usage, please read all operating instructions before using the product. Keep this manual for future reference.



### **General Guideline**

Keep the product at least 13 cm (5 inches) away from electrical appliances that can generate a strong magnetic field such as TV, refrigerator, motor, or a large audio speaker.

Do not place heavy objects on top of the tablet computer as this may damage the display.

The screen surface can be easily scratched. Use with care. Do not use paper towels to clean the display but use the included cleaning cloth. Avoid touching it with a pen or pencil.



### **Cleaning Guideline**

Use a soft cloth moistened with water or a non-alkaline detergent to wipe the exterior of the product.

Gently wipe the display with a soft, lint-free cloth. Do not use alcohol or detergent on the product.



### **Touchscreen Guideline**

Use your finger or the stylus on the display. Using sharp or metallic object may cause scratches and damage the display, thereby causing errors.

Use a soft cloth to remove dirt on the display. The touchscreen surface has a special protective coating that prevents dirt from sticking to it. Not using a soft cloth may cause damage to the special protective coating on the touchscreen surface. To clean off hard to remove dirt, blow some steam on the particular area and gently wipe away using a soft cloth.

Do not use excessive force on the display. Avoid placing objects on top of the display as this may cause the glass to break.

When there is a noticeable discrepancy in the operation of the touchscreen function (your touch does not correlate to the proper location on the screen), recalibrate the touchscreen display.

## Chapter 2: Getting Started

Congratulations on purchasing this rugged Tablet Computer. The rugged design allows you to use it in harsh outdoor environments.

This chapter tells you step by step how to get the Tablet Computer up and running. You will find instructions for the following procedures:

- Unpacking
- Description of Parts
- First Time Operations
- Turning On/Off

### Unpacking

Check and identify the supplied accessories:

- Tablet Computer



- Standard Battery



- Power Adapter



- Power Cord and Plugs



- Capacitive Touch Stylus



# Description Of Parts

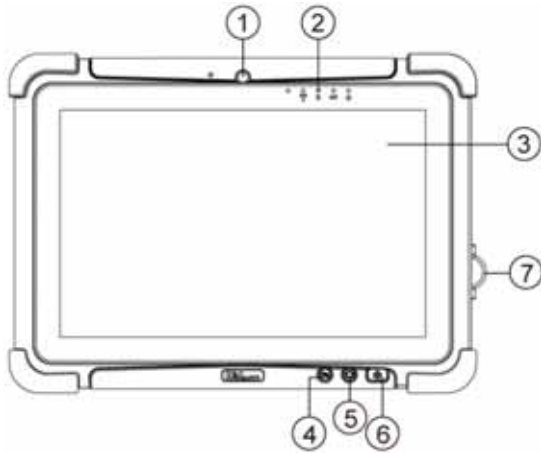

Front:

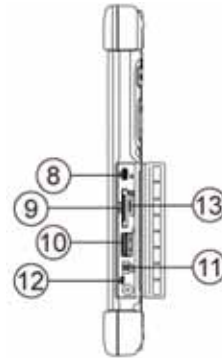

Right:



Getting Started

No	Item	Description
1	Front Camera	2 Megapixel Webcam
2	LED Indicators:	Show the current status of the Tablet Computer
	RF 	<b>Green</b> - WiFi/BT/3G/GPS ON <b>No light</b> - None of WiFi/BT/3G/GPS is ON
	HDD	<b>Green</b> - Harddrive Activity <b>No light</b> - Harddrive Idling
	Battery 	<b>Orange</b> - Charging in progress <b>Green</b> - Fully charged <b>Blinking Red</b> - Battery removed while tablet ON <b>Solid Red</b> - Low Battery (<10%)
	Power 	<b>Blue</b> – Tablet is ON <b>No light</b> – Tablet is OFF
3	Touch Screen	Displays and act as one of the inputs for the Tablet Computer
4	Fn1 Button	Programmable function key configured by HotTab Utility. Default: Web Browser
5	Menu Button	HotTab Quick Access
6	Power Button	Turns on/off tablet

No	Item	Description
7	I/O Cover	Protects I/O ports
8	Micro HDMI	HDMI output to external display
9	LAN/RS232	Adapter port for LAN/RS232 connector
10	USB 3.0	High speed USB port connects to USB devices, such as USB flash drive, mouse, keyboard, printer, etc.
11	Mic In/Line Out	Headset or headphone can be connected
12	Power Jack	DC-IN power input jack
13	MicroSD Card Reader	Memory card reader port for MicroSD Card

Side I/O Details:

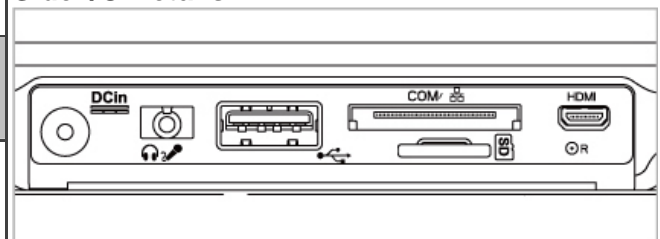

Front LED Indicators Detail:

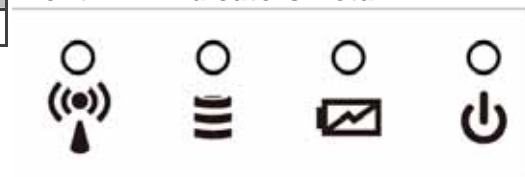

Front Buttons Details:

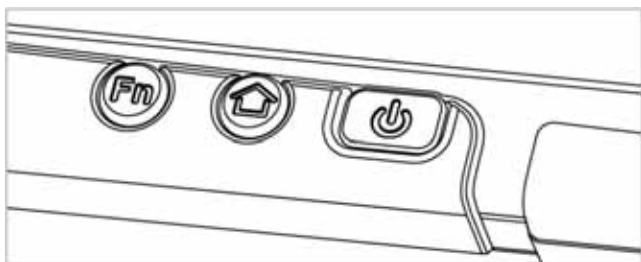

## Rear:

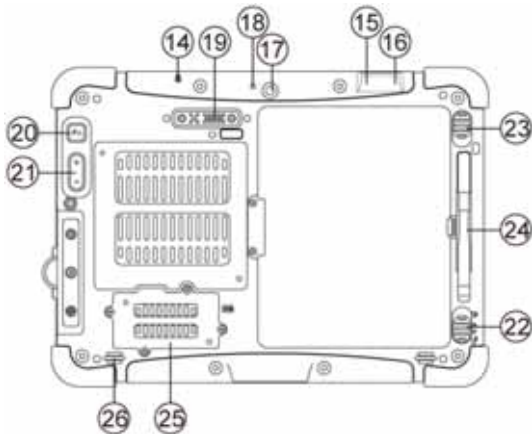

No	Item	Description
14	Kensington Lock Port	Provides lock access for Kensington Lock.
15	Optional Barcode	Barcode Scanner for reading of 1D/2D barcode.
16	Optional RFID	RFID reader for reading of RFID tags.
17	Rear Camera	5MP Autofocus Camera. Captures photos and videos.
18	Camera Flash	LED camera flash to provide flash lighting when use with camera.
19	Expansion Port	Provides optional connectivity to custom modules for special application (USB2.0 x 1 , RS232 x 1).
20	Fn2 Button	Programmable function key configured by HotTab Utility. Default: Camera
21	Volume Buttons	Volume Control. (+) Raises volume, (-) Lowers volume.
22	Battery Release Slider	Spring-loaded slider that latches the battery in.
23	Battery Lock Latch	Latch to lock the battery in place once battery is inserted. Not spring-loaded.
24	Touch Pen Slot	Pen holder slot to store touch pen
25	3G Module/SIM card slot	Service window to insert Micro SIM card. Also provide access to 3G Module.
26	Speakers	Emits sounds.

## Bottom:

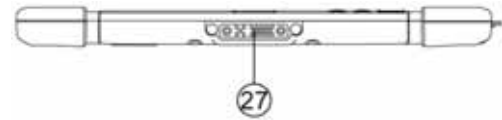

No	Item	Description
27	Docking Connector	Port to docking solutions such as vehicle docking to provide power and external antenna

### Docking Connector Detail:

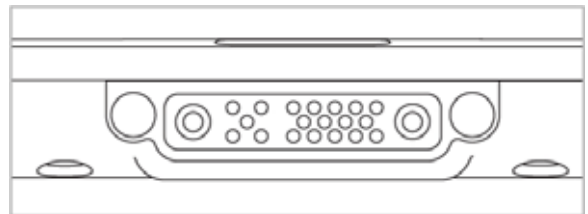

### Expansion Port Detail:

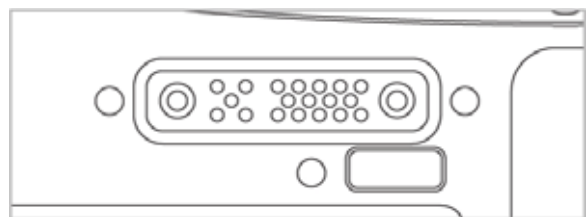

### Battery Lock Latch Detail:

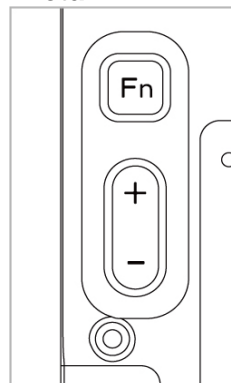

### Rear Buttons Detail:

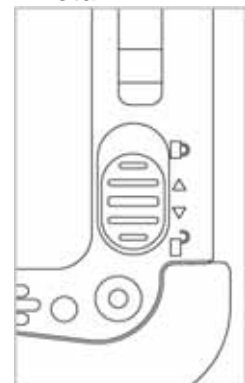

## First-time Operation

### **Insert SIM card (For Optional 3G/LTE equipped device)**

The Tablet Computer supports data connection using 3G/LTE SIM cards and fits Micro-SIM card. (Note: 3G/LTE feature is optional). Perform the following to install the SIM card to your Tablet Computer:

1. Remove the service window in the rear by unscrewing four screws.
2. Remove the screw that is securing the 3G/LTE module.
3. Carefully lift the 3G wireless module up, and be cautious not to damage the connected cable.
4. Make sure the SIM card IC contact patch is faced down, notch is in the direction of insertion (towards right).
5. Insert the 3G SIM card into the slot located near the right side of the service window.
6. Reposition the removed 3G/LTE module screw to secure the 3G/LTE module.
7. Reposition the removed service window screw to secure the service window.

Getting Started

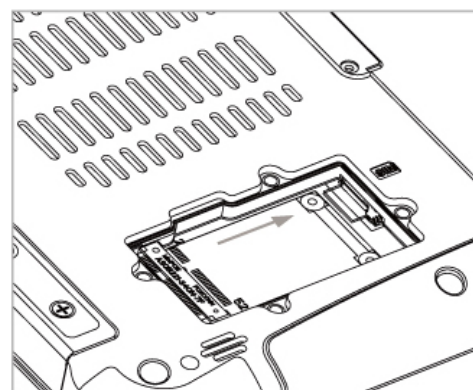
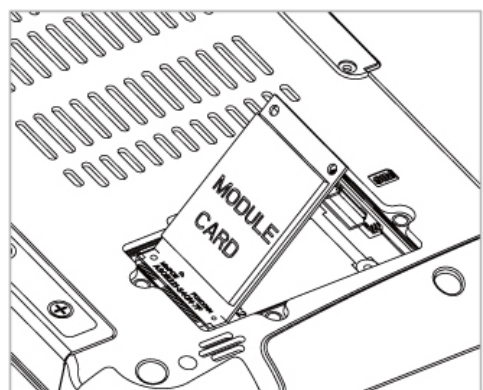
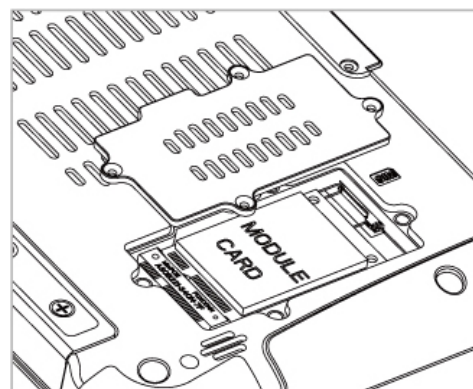
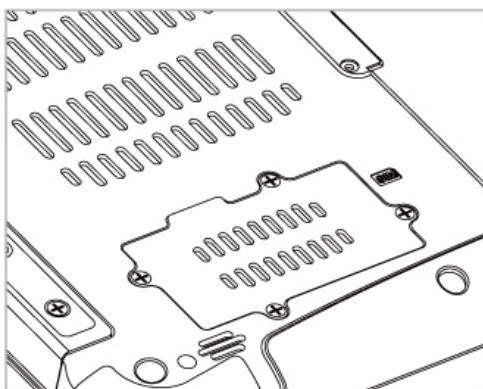

### **Inserting Battery Pack**

To insert the included standard battery pack into the Tablet Computer:

1. Disconnect any cords connected to the tablet computer.
2. Turn the tablet computer over, back facing up.
3. Locate the Battery Lock Latch and push it to the “Unlocked” position.
4. Locate the Battery Release Slider that is spring-loaded. Pull back and hold.



5. Insert the battery on the connector-pins side first, and then lower the battery into the battery compartment. Continue to hold the Battery Release Slider before battery is fully inserted.
6. Make sure the battery is completely lowered into the compartment before letting go the Battery Release Slider. Battery will be flat against the housing once fully inserted

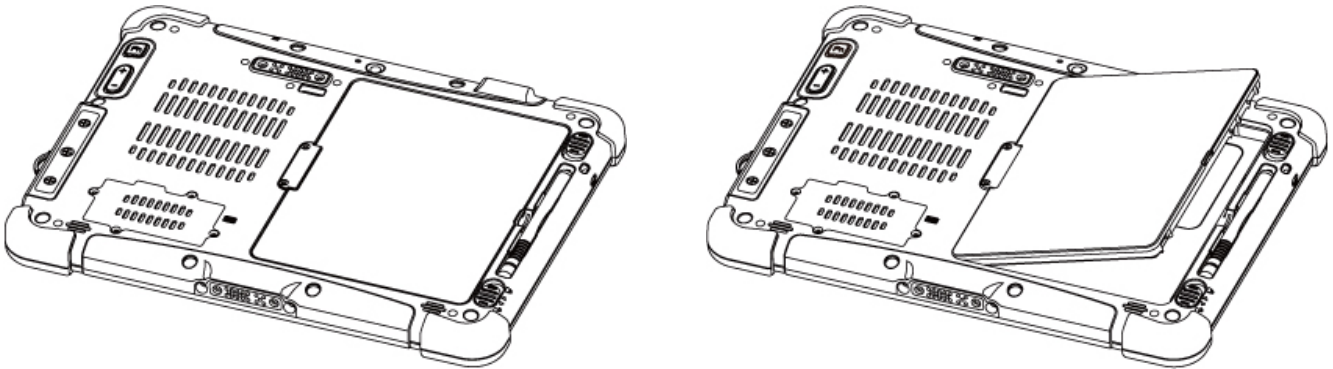

### Removing the Battery Pack

1. Shut down the tablet computer (or put it to sleep). Disconnect any cords connected to the computer.
2. Turn the tablet computer over, back facing up.
3. Locate the Battery Lock Latch and push it to the “Unlocked” position.
4. Locate the Battery Release Slider that is spring-loaded. Pull back and hold.
5. Lift the battery out using the opening on side of battery compartment.

### Connecting to Power Supply

The Tablet Computer operates either on external AC power or internal battery power. It is recommended to use AC power when you start up the Tablet Computer for the first time.



#### Caution

**Use only the AC adapter included with your Tablet Computer. Using other AC adapters may damage the Tablet Computer and the Battery.**

Perform the following to connect the Tablet computer to AC Power:

1. On the side of the Tablet computer, lift the I/O protective cover by pulling on the latch
2. Plug the DC cord of the AC adapter into the Power Jack of the tablet computer.
3. Plug the AC power cord into the AC adapter.
4. Finally, Plug the AC power cord into the electrical outlet.

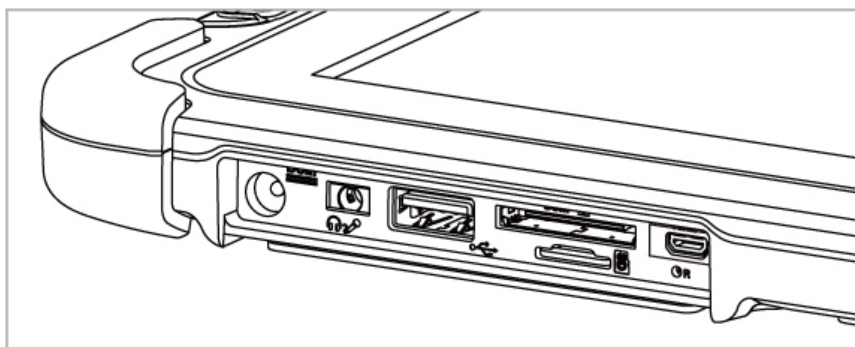

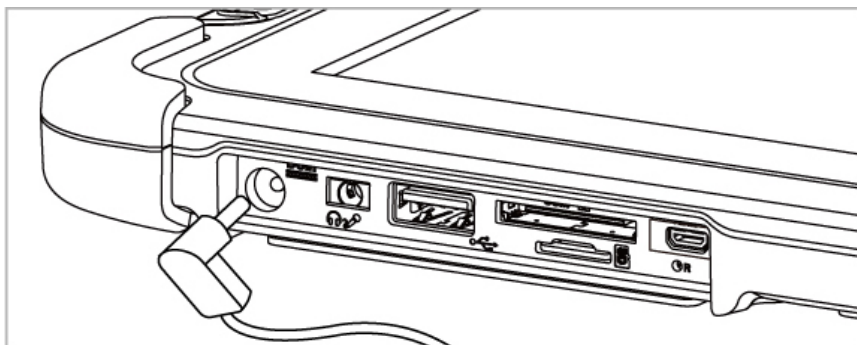

When the AC Adapter is connected, the battery pack starts charging. The battery LED indicator on the tablet computer would show different states. Please refer to description of LED indicator on Description of Parts.

## Turning On / Off

### Turning On

Press and hold the power switch for 3 seconds until the blue LED power indicator light lid up.

#### Note:

- Do not press the power switch repeatedly.
- Do not perform the following operations until the hard drive indicator turns off
  - Connecting or disconnecting the AC adapter
  - Pressing the power switch
  - Touching the tablet buttons, screen, or external keyboard/mouse

### Turning Off

Perform the following procedure to shutdown the Tablet Computer:

1. Make sure you have closed any programs that are open on the Desktop. Start Screen apps don't need to be closed.
2. Open the Charms Bar by swiping your finger from the far right of the screen towards the middle of the screen.
3. Tab on the **Settings** charm.
4. Tab on **Power**.
5. Tab on **Shut Down**.
6. Wait for Tablet Computer to power off.

#### Note:

- The computer will forcibly be turned off if the power switch is pressed and held for six seconds or longer.

# Chapter 3: Useful Information

## HotTab Operation

HotTab provides quick access to the tablet's functions and features, such as turning on/off Wifi, Bluetooth, GPS, programming function key, and changing power management.

As Windows starts up, HotTab starts and runs in the background. To display the HotTab control utility, press the  (Menu) Button located on the front panel, OR launching the HotTab Utility application.

 (Menu) Button on the Front Panel:

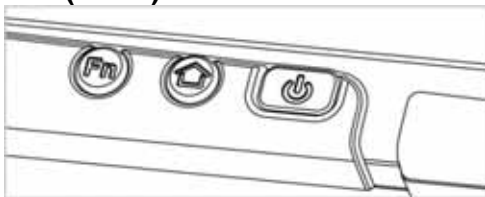

HotTab Utility Icon:



HotTab is designed to be a quick access utility, therefore the main user interface will be on the right side of the screen without blocking the content on screen. There are 4 main menu options: Short cut, Camera, Device and Settings. Operations and functions on each menu options is explained in detail in the coming section.



HotTab Utility User Interface:



## Short Cut

This HotTab menu option allows users to configure short cut to quickly access programs with a few tabs. The Short Cut menu offers 8 empty slots to store user's desired quick access. Shortcuts can be mapped to any of the executable files (.exe) installed on the tablet.

### Short Cut Menu:

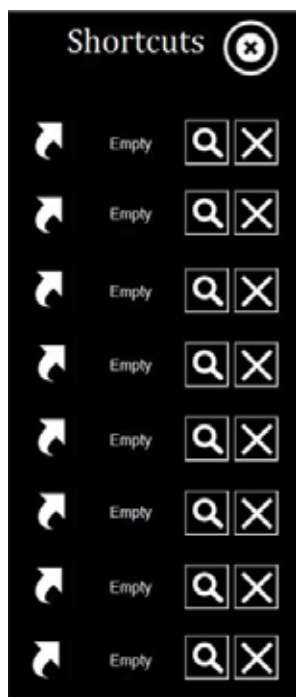

### To store a new Short Cut:

1. Tab on button of any empty slot.
2. An on screen file browser will appear.
3. Browse to find the desired application to have short cut.
4. Click "Open" to save the short cut.

### To remove an saved Short Cut:

1. Tab on the button of any saved slot to remove
2. Short Cut will be removed, and once again show "NULL" to indicate slot is empty.

Tab on the button will hide the HotTab Utility Menu.





## Camera

This HotTab menu option allows users take a picture or record a video. Before use, make sure the Camera is turned on under Devices menu option. The Camera user interface will take up the entire screen as shown below:









### Description of Camera User Interface Buttons:

No	Item		Description
1	Camera Switch		Switch between front camera or rear camera
2	Settings		Brings up Camera settings page Available Settings: <ul style="list-style-type: none"> <li>• <b>Picture Save:</b> modify/inspect saved location for pictures</li> <li>• <b>Video Save Folder:</b> modify/inspect saved location for video recordings.</li> <li>• <b>Picture Quality:</b> Picture compression quality</li> </ul>
3	Flash Control		Disables LED Flash when taking picture
			LED flash fires regardless of condition when taking pictures
			LED Flash fires automatically in low light condition when taking pictures.
4	Resolution		Pictures will be saved at resolution of <b>640 x 480</b>
			Pictures will be saved at resolution of <b>1024 x 768</b>
			Pictures will be saved at resolution of <b>1600 x 1200</b>
			Pictures will be saved at resolution of <b>2592 x 1944</b>

5	<b>Exit</b>	 Exits the Camera and hide HotTab Utility
6	<b>Picture/Video Mode Switch</b>	 Switches between picture taking or video recording
7	<b>Shutter/Record</b> (automatically switch base on mode)	 Camera Shutter Button. Tap to take picture.
		 Video Record Button. Tap to Start, and press again to stop recording.
8	<b>Open Saved Location</b>	 Opens the location where pictures and videos are saved in a window.

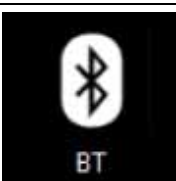
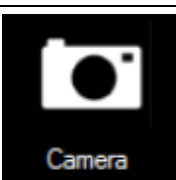
## Device

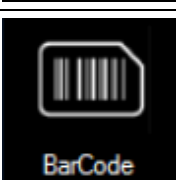
This HotTab menu option enables/disables tablet computer's hardware functions:

Item	Status Color	Description
	Orange	Wi-Fi is enabled
	White	Wi-Fi is disabled
	Orange	WWAN (3G/4G) is enabled
	White	WWAN (3G/4G) is disabled
	Orange	GPS is enabled
	White	GPS is disabled
	Orange	Bluetooth is enabled
	White	Bluetooth is disabled
	Orange	Camera is enabled
	White	Camera is disabled
	Orange	Enables Front LED indicators
	White	Disables Front LED indicators
	Orange	Barcode Reader is enabled. Reading will need to triggered manually thru Fn button.
	White	Barcode Reader is disabled.
	Orange	RFID Reader is enabled. Reading will occur without trigger
	White	RFID Reader is disabled.
	Orange	Expansion Port 5V Power is enabled.
	White	Expansion Port 5V Power is disabled.

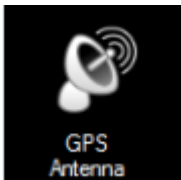
	Orange	Built-in GPS antenna is used for GPS.
	White	External GPS antenna is used for GPS if it is available otherwise, device will switch to Built-in GPS antenna automatically.

## Setting

This HotTab menu option provides users information such as PC Information, Battery status, and also device settings such as power management setting, and function key mappings.

### PC Information:

```

PC Information
  BIOS Ver.: V108      EC Ver.:101
  HotTab Ver.: M101_A40.1.05
  OS Ver.:
  Units SN: To be filled by O.E.M.
  
```

This section provides user device information in regards to BIOS Version, EC Versions, HotTab Versions, OS Versions, as well as Unit Serial Number, shown in the picture sample.

### Battery Information:

```

Battery Information
  Main      BackUp
    
  100 %      Medium
  BAT1ChargeTime: 0 h
  
```

This section provides user battery Information.

#### Main Battery:

The main battery Icon displays the battery level in percentages (0 to 100%).

#### Backup Battery:

The backup battery used for battery hot swapping displays its state in text with the following meanings.

Status	Description
High	Backup battery is fully charged, and can be used for hot swapping
Medium	Backup battery level is intermediate, but can be used for hot swapping
Low	Backup battery level is low, and hot swapping is not recommended.

#### Battery Charge Time:

The Battery Information also displays estimated time needed to fully charge the main battery when AC adapter is plugged in.



## Power Management (Performance):

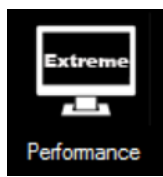





The power management (performance) feature allows user to switch to different power modes of power consumption.

Power supply to different components is controlled on an as-needed basis. This allows maximum power conservation and performance at the same time.

Your Tablet Computer comes with the **HotTab** power management scheme which has pre-defined power options for you to select.

To switch to a different power management scheme, tab on the Power Management Icon, and four different schemes will be displayed on the HotTab Utility Pane



Item		Description
Saving		Screen brightness is at its lowest. Uses the least battery power.
Office		Low screen brightness. Suitable when using typical applications, such as word processing and managing documents. Uses less battery power.
High		High screen brightness. Suitable for application that need better visibility of screen.
Extreme		Maximum screen brightness. The battery power drains easily.

## Function Key Mapping



The function key mapping menu option allows user to change the physical function buttons, Fn1 and Fn2. Users can change what application will be launched with short press or long press of keys.

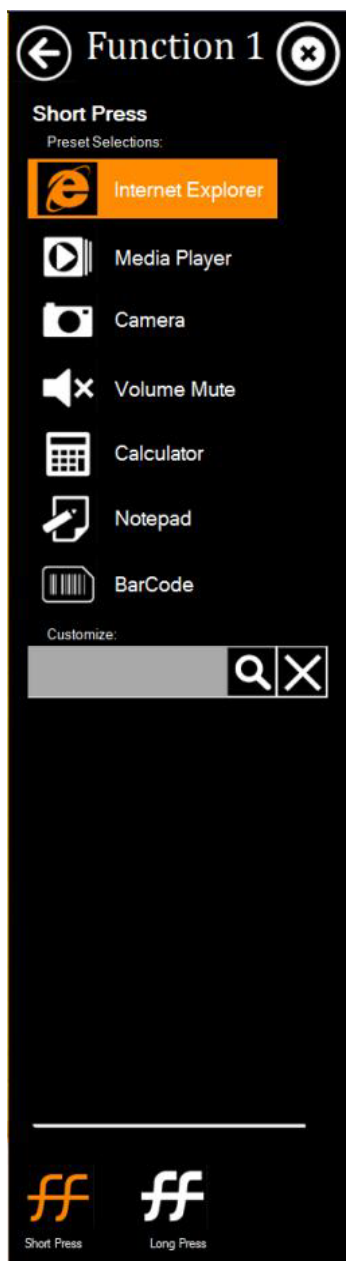

**To configure function key mapping, perform the following:**

1. Tap on function key icon for the corresponding key that you want to change.
2. At top of utility, it will say “Short Press” or “Long Press” to indicate what type of press is being configured
3. You can switch what type of press you want to configure by tapping on the “Short Press” or “Long Press” icon at the bottom of the utility window.
4. Pick from list of preset applications by tapping on the application icons OR customize which application to execute using the picker.

**Using the Custom picker:**

1. Tap the icon to reveal browser window
2. Navigate to the desired executable to map to function key
3. Tap on “Done” to save selection.

**To map the function key to another application:**

4. Tap on the icon to remove connection to the original application, and pick again tapping on icon.

## Hot Swapping Batteries

The tablet computer supports hot-swapping of batteries, meaning the tablet doesn't need to be powered off in order to replace the main battery. To support such mechanism, there is a backup battery inside the tablet that is charged up with the main battery. This backup battery cannot be removed, and needs to have adequate power for hot swapping of main battery to be done without issue. When the backup battery is fully charged, it can sustain up to 5 minutes of runtime to allow for battery hot-swapping.

Perform the following to hot swap the batteries:

1. While the tablet is powered on, go to HotTab utility to check on the power level of the Backup battery.
2. If the Backup battery level is at "Low", please charge the tablet with AC Power until the Backup battery level is at "Medium" or "High", and do not remove the main battery.
3. If the Backup battery level is at "Medium" or "High", continue to remove the main battery.
4. Insert a new charged up removable battery into the battery compartment.
5. Go to HotTab utility to check if Main battery level can be correctly read. If not, check if the new removable battery is inserted properly.
6. If Main battery level can be read, continue to use the tablet computer.

## Accessories

M101 offers the following optional accessories that can be purchased:

<b>Gigabit Ethernet Adapter</b> <ul style="list-style-type: none"> <li>• For LAN from 30-pin extension port</li> <li>• Length; 10 cm</li> <li>• Connector: RJ45, female</li> <li>• Gigabit LAN, 10/100/1000 Mbps</li> </ul>	<b>RS232 Ethernet Adapter</b> <ul style="list-style-type: none"> <li>• For RS232 from 30-pin extension port</li> <li>• Length:10 cm</li> <li>• Connector: DB9 Serial RS232 Cable, female</li> </ul>
<b>High Capacity Battery</b> <ul style="list-style-type: none"> <li>• Capacity: 7.4V 10600mAh (2S2P)</li> <li>• Li-Polymer Battery</li> </ul>	<b>Hand Strap</b> <ul style="list-style-type: none"> <li>• Ergonomic hand-strap can help you handle the Rugged Tablet PC much more easily and comfortably.</li> </ul>
<b>Charging Cart</b> <ul style="list-style-type: none"> <li>• Charge max up to 32 pcs of tablet PC at the same time</li> <li>• Lockable doors and casters design for security and safety</li> </ul>	<b>Vehicle Charger</b> <ul style="list-style-type: none"> <li>• Rapidly charges your M101 tablet PC in your car while you drive</li> <li>• Length: 3m</li> </ul>
<b>Mobile Power Station</b> <ul style="list-style-type: none"> <li>• Model Name: M44BW-100</li> <li>• 8.4/12/16/19V DC out</li> <li>• Capacity: 8800mAh</li> </ul>	<b>Bluetooth Keyboard</b> <ul style="list-style-type: none"> <li>• Black style Bluetooth 3.0 Keyboard</li> </ul>

## Chapter 4: Troubleshooting

### Troubleshooting (Basic)

Problem	Solution
The removable battery is not charging	<ul style="list-style-type: none"> <li>• Make sure the AC adapter is properly connected, and that the removable battery is properly inserted.</li> </ul>
Nothing appears on the screen.	<ul style="list-style-type: none"> <li>• The tablet computer may be in sleep mode. Press the power button to wake up the display.</li> <li>• The brightness level may be too low. Increase brightness.</li> </ul>
The screen suddenly turns blank and the power indicator goes off	<ul style="list-style-type: none"> <li>• Make sure that LED indicator is not turned off in HotTab.</li> <li>• Make sure the AC adapter is properly connected</li> <li>• If running on battery power, the battery may be depleted, charge the battery.</li> </ul>
Wireless LAN signal quality is poor	<ul style="list-style-type: none"> <li>• The tablet computer may be out of range. Move the tablet computer closer to the access point or another wireless LAN device associated with it.</li> <li>• Check if your surroundings have interferences, such as microwave ovens, cordless phones. Move the tablet computer away from objects causing interference.</li> </ul>
I cannot connect to another wireless LAN device	<ul style="list-style-type: none"> <li>• Make sure that wireless LAN feature is turned on.</li> <li>• Make sure that the SSID setting is the same for every wireless LAN device in the network.</li> <li>• Restart the tablet computer</li> <li>• Make sure the IP address or subnet mask setting is correct.</li> </ul>
I cannot connect to another device with Bluetooth.	<ul style="list-style-type: none"> <li>• Make sure that both devices have Bluetooth turned on (For the Tablet Computer, check HotTab to see if Bluetooth is turned on).</li> <li>• Make sure that the distance between the two devices is within 10 meters and there are no walls or large obstructions between the devices.</li> </ul>

	<ul style="list-style-type: none"> <li>• Make sure the both devices are turned on and configured to be discoverable</li> <li>• Make sure that both devices are compatible.</li> </ul>
<b>The GPS application cannot find my location.</b>	<ul style="list-style-type: none"> <li>• Make sure that GPS is turned on in HotTab.</li> <li>• Make sure that GPS receiver and the location sensor are enabled in Control Panel.</li> <li>• The tablet computer may be out of coverage area. Move your tablet computer outdoors or closer to a window.</li> <li>• Check if your surroundings have interferences, such as microwave ovens, cordless phones. Move the tablet computer away from objects causing interference.</li> </ul>
<b>No sound is produced.</b>	<ul style="list-style-type: none"> <li>• Adjust volume of the tablet computer by pressing on the volume rocker.</li> <li>• If using an external audio device, make sure that the cable is properly connected.</li> </ul>
<b>I cannot project the tablet computer display to another monitor</b>	<ul style="list-style-type: none"> <li>• Make sure the VGA driver is installed.</li> <li>• Make sure the output setting selected is correct.</li> </ul>

This device complies with Part 15 of the FCC Rules. Operation is subject to the following two conditions: (1) this device may not cause harmful interference and (2) this device must accept any interference received, including interference that may cause undesired operation.

This equipment has been tested and found to comply with the limits for a Class B digital device, pursuant to part 15 of the FCC rules. These limits are designed to provide reasonable protection against harmful interference in a residential installation. This equipment generates, uses and can radiate radio frequency energy and, if not installed and used in accordance with the instructions, may cause harmful interference to radio communications. However, there is no guarantee that interference will not occur in a particular installation. If this equipment does cause harmful interference to radio or television reception, which can be determined by turning the equipment off and on, the user is encouraged to try to correct the interference by one or more of the following measures:

- Reorient or relocate the receiving antenna. -

- Increase the separation between the equipment and receiver. -

- Connect the equipment into an outlet on a circuit different from that to which the receiver is connected. -Consult the dealer or an experienced radio/TV technician for help.

You are cautioned that changes or modifications not expressly approved by the party responsible for compliance could void your authority to operate the equipment.

FCC RF Radiation Exposure Statement: 1. This Transmitter must not be co-located or operating in conjunction with any other antenna or transmitter. 2.

This equipment complies with FCC RF radiation exposure limits set forth for an uncontrolled environment.

#### Information to OEM integrator

The OEM integrator has to be aware not to provide information to the end user regarding how to install or remove this RF module in the user manual of the end product. The user manual which is provided by OEM integrators for end users must include the following information in a prominent location.

1. To comply with IC RF exposure compliance requirements, the antenna used for this transmitter must be installed and must not be co-located or operating in conjunction with any other antenna or transmitter, except in accordance with IC multi-transmitter product transmitter product procedures.
2. Only those antennas with same type and lesser gain filed under this IC ID number can be used with this device.
3. The regulatory label on the final system must include the statement: "Contains IC ID: xxxx".
4. The final system integrator must ensure there is no instruction provided in the user manual or customer documentation indicating how to install or remove the transmitter module except such d

evice has implemented two-ways authentication between module and the host system.

5. If the end product integrating this module is going to be operated in 5.15 ~5.25GHz frequency range, the warning statement in the user manual of the end product should include the restriction of operating this device in indoor could void the user's authority to operate the equipment.

**C Statement** This device complies with Industry Canada licence-exempt RSS standard(s). Operation is subject to the following two conditions: (1) this device may not cause interference, and (2) this device must accept any interference, including interference that may cause undesired operation of the device. Le présent appareil est conforme aux CNR d'Industrie Canada applicables aux appareils radio exempts de licence. L'exploitation est autorisée aux deux conditions suivantes : (1) l'appareil ne doit pas produire de brouillage, et (2) l'utilisateur de l'appareil doit accepter tout brouillage radioélectrique subi, même si le brouillage est susceptible d'en compromettre le fonctionnement. Industry Canada - Class B This digital apparatus does not exceed the Class B limits for radio noise emissions from digital apparatus as set out in the interference-causing equipment standard entitled "Digital Apparatus," ICES-003 of Industry Canada. Cet appareil numérique respecte les limites de bruits radioélectriques applicables aux appareils numériques de Classe B prescrites dans la norme sur le matériel brouilleur: "Appareils Numériques," NMB-003 édictée par l'Industrie. Operation is subject to the following two conditions: (1) this device may not cause interference, and (2) this device must accept any interference, including interference that may cause undesired operation of the device. L'opération est soumise aux deux conditions suivantes: (1) cet appareil ne peut causer d'interférences, et (2) cet appareil doit accepter toute interférence, y compris celles susceptibles de provoquer fonctionnement du dispositif. To reduce potential radio interference to other users, the antenna type and its gain should be so chosen that the equivalent isotropically radiated power (e.i.r.p.) is not more than that permitted for successful communication. Afin de réduire les interférences radio potentielles pour les autres utilisateurs, le type d'antenne et son gain doivent être choisie que la puissance isotrope rayonnée équivalente (PIRE) est pas plus que celle promise pour une communication réussie. RF exposure warning: The equipment complies with RF exposure limits set forth for an uncontrolled environment. The antenna(s) used for this transmitter must not be co-located or operating in conjunction with any other antenna or transmitter. Avertissement d'exposition RF: L'équipement est conforme aux limites d'exposition aux RF établies pour un incontrôlés environnement. L'antenne (s) utilisée pour ce transmetteur ne doit pas être co-localisés ou fonctionner en conjonction avec toute autre antenne ou transmetteur. Avertissement d'exposition RF: 1. Cet émetteur ne doit pas n'être coimplante ou operation en meme temps qu'aucune autre antenne ou émetteur. 2. Cet équipement est conforme aux limites d'exposition de rayonnement de la FCC rf determinees pour un environnement non controle. CAN ICES-3 (B)/NMB-3(B)

### **Winmate Communication INC.**

9F, No.111-6, Shing-De Rd., San-Chung District, New Taipei City 241, Taiwan, R.O.C

Web Site: <http://www.winmate.com.tw>