

UMC-I210C Module Installation Guide

Rev. 0.1

2015/06/12

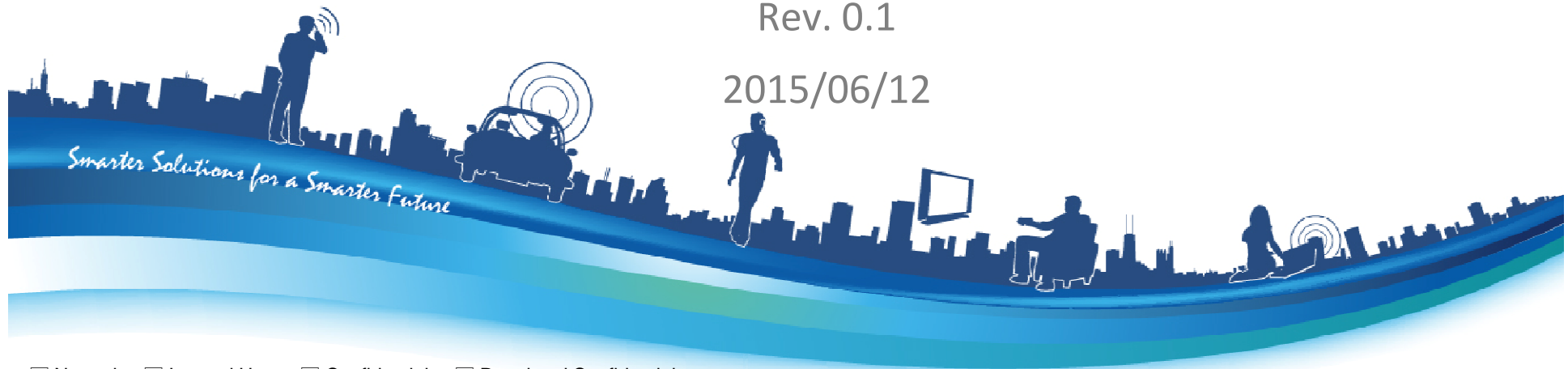

Parts' Overview

Transparent Mask

From Meter



When the UMC-I210C is installed in GE I-210+c meter (i.e. host device), the FCC label is placed on the outside of the GE I-210+c meter transparent mask which must cover the info, something like "contains the FCC ID: NKR- CB1GI210C"

Cover

From Meter



UMC-I210C

From WNC



Base

From Meter

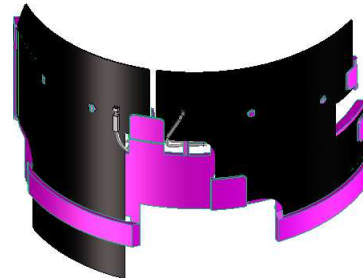

Antenna unit

From WNC

>>>> LTE Antenna unit and UMC-I210C are from WNC.
>>>> Transparent mask, cover and base are from GE I-210+c meter.

Overview of Installation Steps

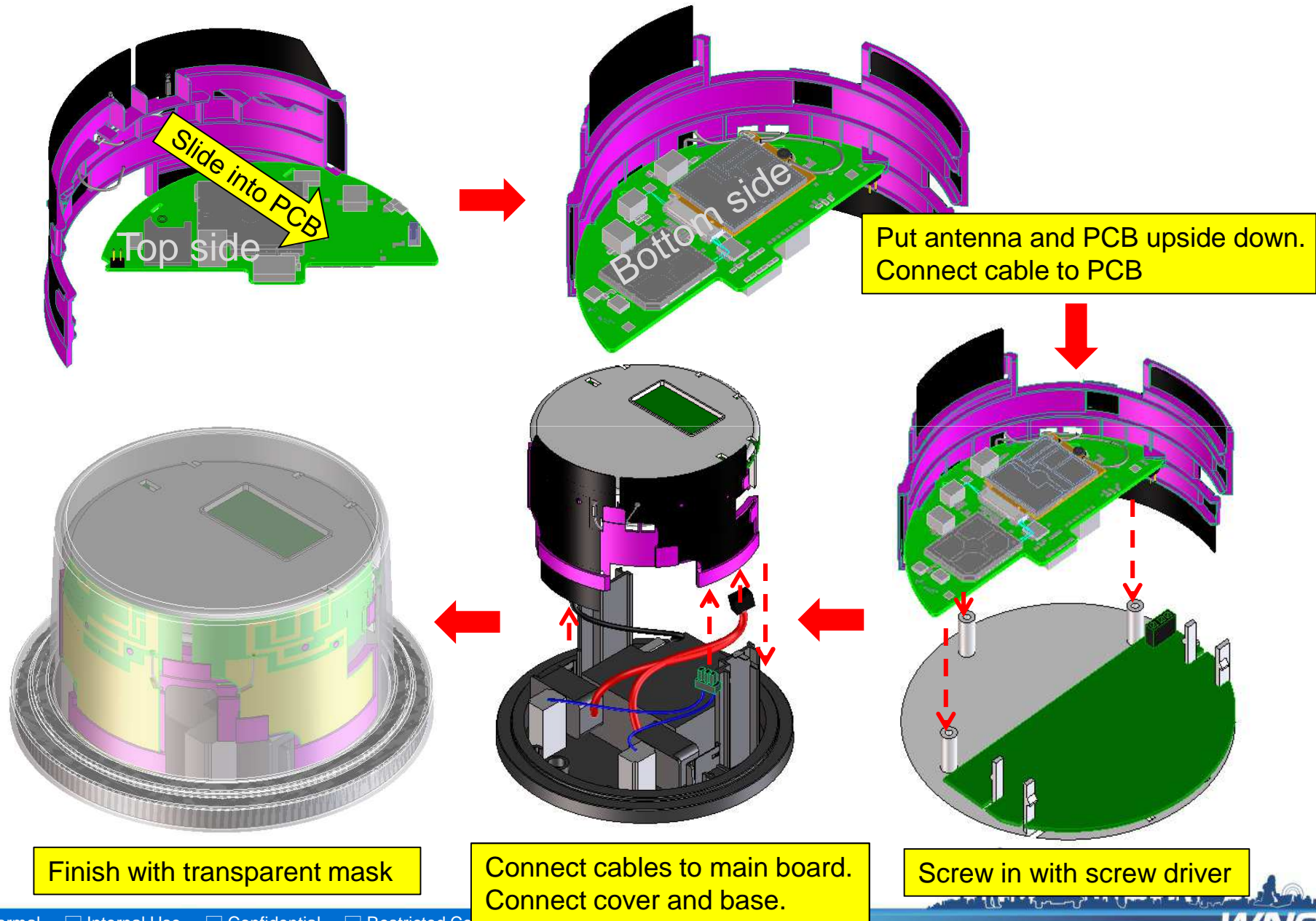

Installation LTE Antenna Unit into UMC-I210C

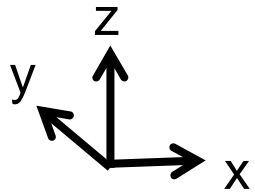
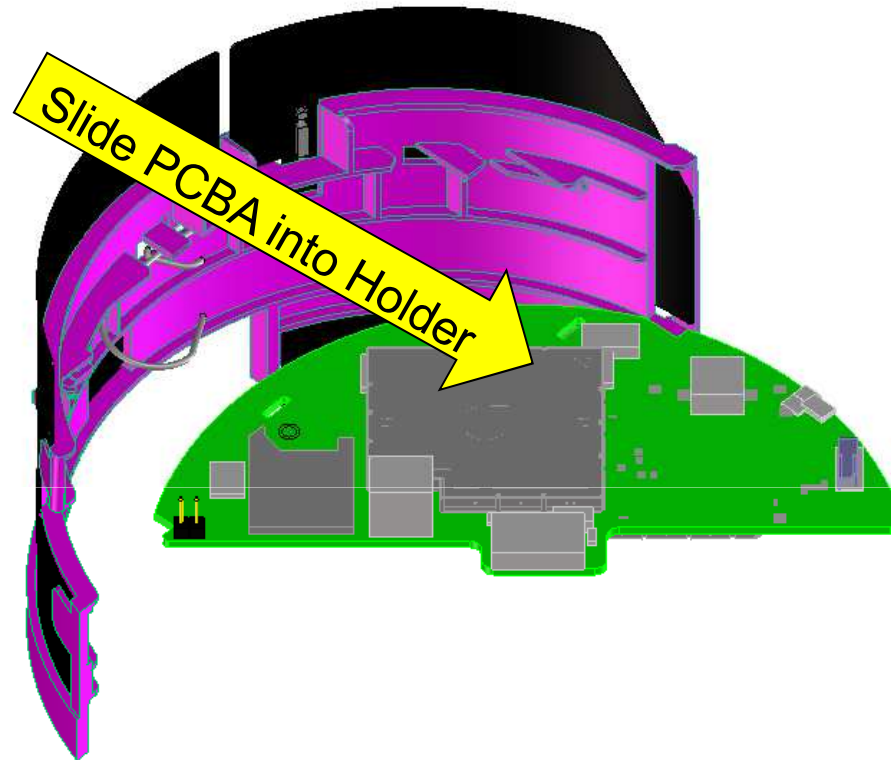

Hooks are designed in holder that would help assembly of antenna and PCB.

Connecting LTE Antenna Cables into IMG03

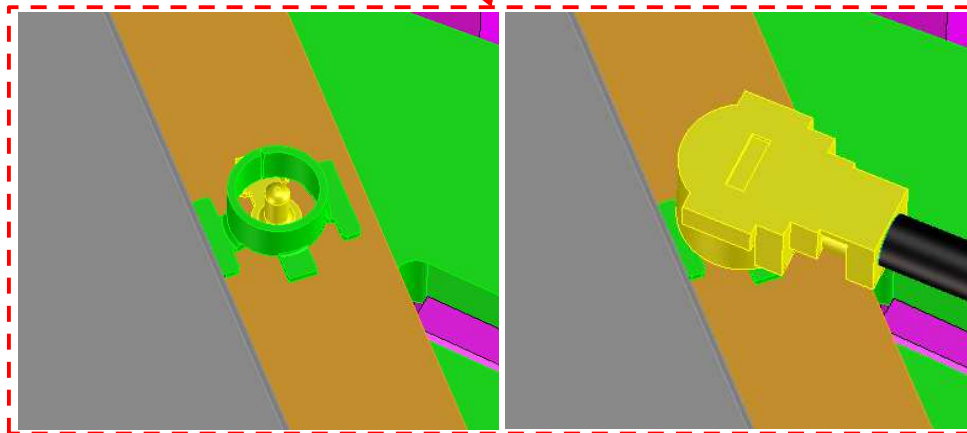
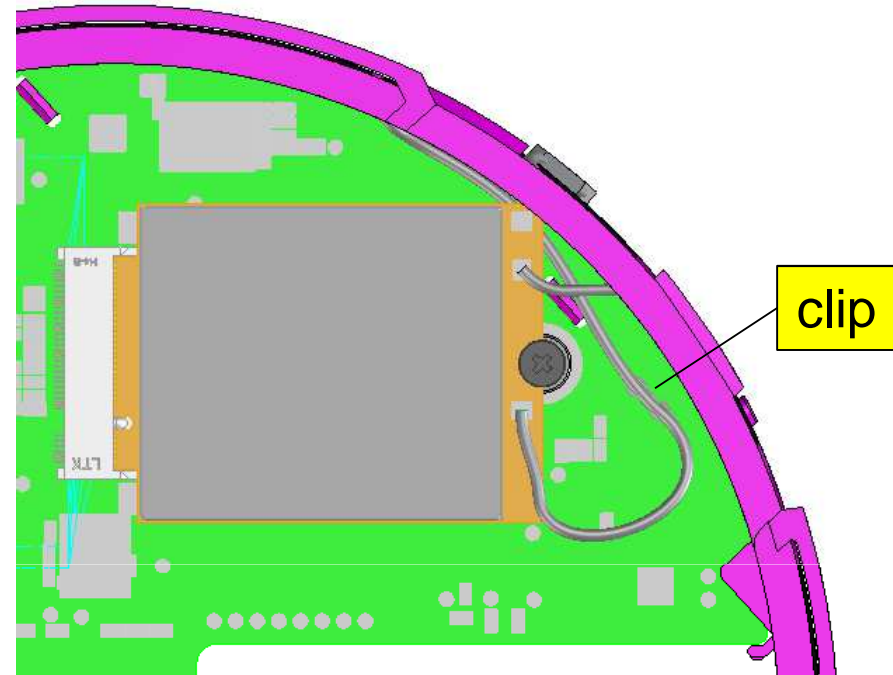
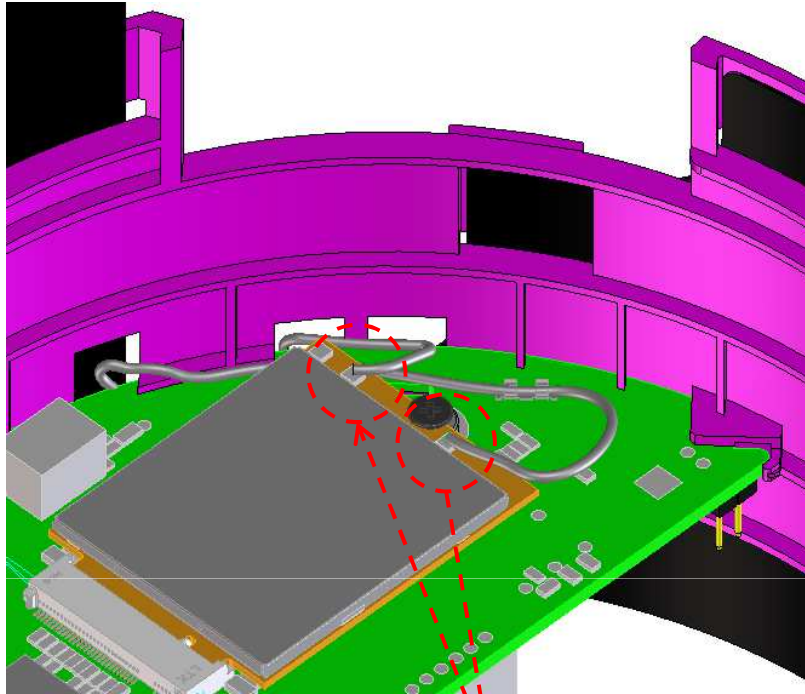

Connect antenna cable to PCB.
Cables are fixed with IPEX on the module.

Installation UMC-I210C with Antenna Unit into Meter

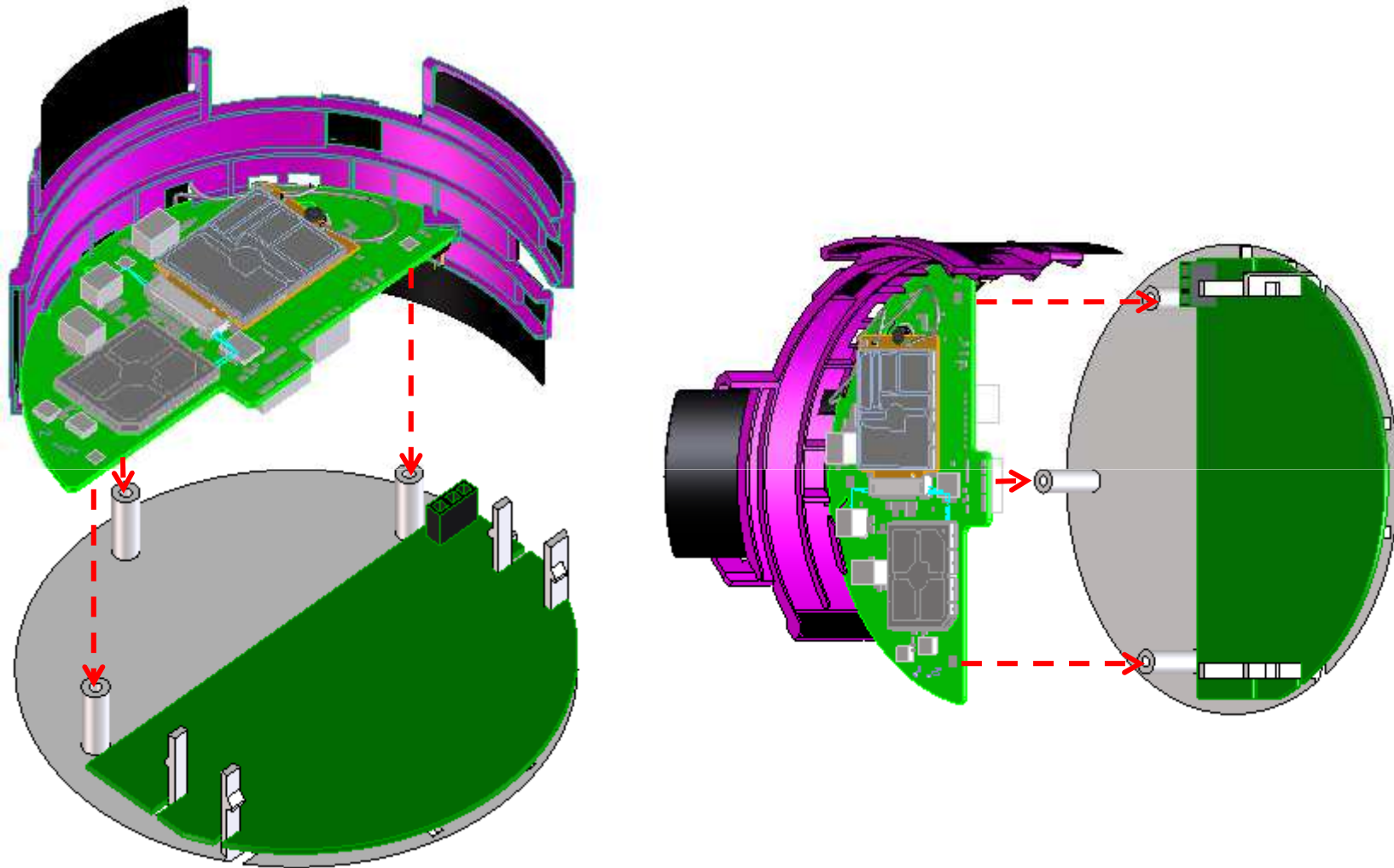

WNC

Smarter Solutions for a Smarter Future

Wistron Neweb Corporation Proprietary & Confidential

