

BrainPort® V100 Device



User Manual



BrainPort® Technologies
Wicab, Inc.

Wicab, Inc.
8313 Greenway Blvd.
Middleton, Wisconsin 53562 USA

Table of Contents

CHAPTER 1	5
General Information	5
Purpose of Device (Indications for Use)	5
Description of BrainPort® V100	6
When NOT TO USE the Device (Contraindications)	7
Risks of Use	7
General Warnings	7
Precautions	12
Clinical Experience	13
Product and Package Labeling	14
CHAPTER 2 Using the BrainPort® V100	17
User Interface Description	19
<i>Contrast</i>	19
<i>Status</i>	19
<i>Image Mode</i>	20
<i>Lock</i>	20
<i>Test</i>	20
<i>Volume</i>	20
<i>Power</i>	20
<i>Intensity and Invert</i>	20
<i>Zoom</i>	21
<i>Camera Tilt</i>	21
<i>Battery Compartment</i>	21
Quick Start: Turning on the BrainPort V100	24
Starting vRemote	25
Device Announcements	26
Batteries	28
Battery Charger	29
Battery Precautions	30
Care and Maintenance	31
CHAPTER 3 Troubleshooting	32
Problems with Battery Power	33
Controller Troubleshooting	35
Headset Troubleshooting	37
vRemote Troubleshooting	37
CHAPTER 4 Product Specifications and Technical References	38
General Specifications	38

User Profile 40
Electromagnetic Compatibility 41
Warranty 48
Appendix A Cleansers..... 49
Appendix B Clinical Safety Information..... 50

Using this Manual

This manual is intended for use after you have been trained on the operation of the BrainPort® V100. This manual serves as a reference to supplement your training and to address any questions you may have when you use the device at home.

The manual contains general information on safety, operation, and troubleshooting. Please read it thoroughly and become familiar with its contents.

This manual is written in an accessible format.

- Chapter 1 describes the BrainPort V100 and the risks and benefits of using it.
- Chapter 2 explains how to use the BrainPort V100.
- Chapter 3 includes troubleshooting procedures to use in the event of problems with the BrainPort V100.
- Chapter 4 lists product specifications and technical references.

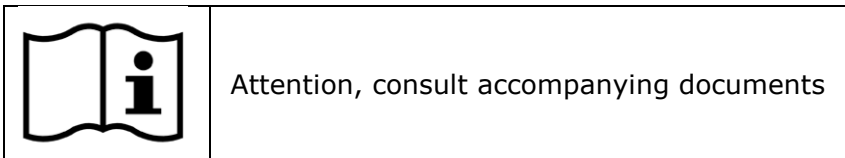

This label is a reminder for you to consult this manual or other material you received with the device for important safety information.

Rx only

Caution: Federal law restricts this device to sale by or on the order of a physician.

CHAPTER 1

General Information

The BrainPort V100 is a non-surgical electronic assistive prescription device for profoundly blind individuals to aid in orientation, mobility and object recognition. The BrainPort V100 is indicated as an adjunct to other assistive devices, such as the white cane and guide dog. It translates digital information from a video camera to gentle electrical stimulation patterns on the surface of the tongue. Users describe the experience as streaming images drawn on their tongue with small bubbles. With training, users are able to interpret the shape, size, location and motion of objects in their environment.



Warning

The BrainPort V100 does not replace the cane or guide dog. The BrainPort V100 is intended to augment, rather than replace, other assistive technologies such as the white cane or guide dog.

**Training is required before using the
BrainPort V100.**

Purpose of Device (Indications for Use)

The BrainPort V100 is intended for use as an electronic assistive prescription device for profoundly blind individuals to aid in orientation, mobility and object recognition. The BrainPort V100 is indicated as an adjunct to other assistive devices, such as the white cane and guide dog.

Description of BrainPort® V100

Headset

A digital video camera is mounted on a pair of sunglasses at the nose bridge. The camera is capable of working indoors and outdoors in typical lighting conditions. The camera's field of view is user-controlled and varies from narrow to wide angle views. There are two cables permanently attached to the left ear piece: The IOD assembly and the headset cable.

Intra Oral Device (IOD)

The IOD (tongue electrode array) contains electrodes that act as "pixels" for the tongue. The flat side with the electrodes should be in contact with the front top surface of the tongue. Close your lips around the thin stem, maximizing tongue contact with the electrodes. The stimulus pattern on the electrode array corresponds to the scene captured by the camera. There is one cable exiting the thin stem of the IOD that is permanently attached to the ear piece of the headset.

Controller

The Controller contains the battery as well as the user control features for the BrainPort V100. The Controller is generally handheld. A belt clip is provided for hands free operation.

Battery Charger

A battery charger with factory instructions is included.

Training and Training PC

Training is required before you use the BrainPort V100. The trainer may use an accessory personal computer during training. When the personal computer is in use:

- Do not touch the personal computer or your trainer, and
- Do not come into contact with any device plugged into a wall circuit.

Your BrainPort V100 does not include or require a personal computer.

When NOT TO USE the Device (Contraindications)

You should not use the BrainPort V100 if you have any of the following conditions:

- Numbness or lack of feeling of your tongue
- History of injuries that impair sensation or use of your tongue
- Any neurological condition that causes impaired sensitivity to your tongue or loss of consciousness

Risks of Use

Potential risks arising from the use of the BrainPort V100 include:

- Electrical and electromagnetic safety hazards associated with battery-operated devices
- Allergic reaction to the materials in the device
- Irritation of your tongue from the electrodes or excessive stimulation

You can manage these risks by setting the stimulus level according to your preferred comfort level, adhering to the instructions in this manual, and applying the training you received for the proper and safe use of the device.



General Warnings

- *Long-term use.* Limited data are available on the long-term effects of electrical stimulation of the tongue. Long-term effects (beyond one year) have not been evaluated in clinical trials.
- *Device Usage.* Limited data is available on use of the device exceeding an average of between 250 and 400

minutes per month, and a maximum of 1550 minutes per month. Wicab recommends that you tailor your use of the device to be within these time limits since long-term effects (beyond one year) exceeding this usage have not been evaluated in clinical trials.

- *Trainers.* Potential trainers of users of the BrainPort V100 should have relevant experience, such as experience working with the blind or visually impaired. Trainers may have professional credentials, such as certification as a Certified Low Vision Specialists (CLVS), Certified Orientation and Mobility Specialist (COMS) or Teachers of the Visually Impaired (TVI). All potential trainers will be trained by Wicab according to Wicab procedures and only those who have successfully completed the training will be considered qualified to train users of the BrainPort V100.
- *Supervision.* The BrainPort V100 should only be used after you have completed training. Do not give the device to untrained individuals for use.
- *Use only Wicab supplied components and procedures.* Using controls, adjustments, components, or procedures other than those specified in this manual may damage the BrainPort V100, increase risk, or decrease benefit.
- *Oral Health.* Limited data is available on stimulation sensitivity for individuals with oral conditions such as oral ulcers, herpes simplex, oral thrush, and geographic tongue. If use of the device causes discomfort, discontinue use.
- *Oral Health.* Individuals with high, narrow palatal vaults should discontinue use of the device if use causes discomfort
- *Oral Health.* Individuals with maxillary or mandibular tori that interfere with the IOD placement such that full contact with the tongue is prevented should seek

additional training to gain the most benefit of the device.

- *Dental Appliances (orthodontic appliances, removable partial or full dentures, lingual amalgam alloy restoration, metal crowns, etc.)* Electrical stimulation of the tongue when metal appliances/surfaces are present may change results and/or cause unintended stimulation. If the stimulation causes discomfort, remove the IOD from your mouth and discontinue use of the device. If you notice a change in your dental device or appliance (warmth or looseness), discontinue the use of the device and contact your dentist.
- *Dental Implants.* The BrainPort device has not been thoroughly evaluated in the presence of dental implants. The safety of dental implants in BrainPort users is unknown. The use of this device potentially may cause heating of dental implants; chronic use of this device potentially may result in loosening and failure of dental implants.
- *Condition of device.* Before EACH use, tactilely inspect the device for damage, for example, anything rough or loose on the IOD, disconnected cables, worn cables, cracked or broken glasses, cracked or broken handset, etc. If you find these or similar issues, contact Customer Support and DO NOT use the device. Using a damaged device could expose sharp edges and/or the damage could prevent normal operation, thereby increasing the risk of use.
- *Proper environment for use.* The BrainPort V100 is intended for use as a supplemental assistive device.
 - Do not use it in environments that could put you in danger.
 - Do not operate the device in hot or cold conditions (below 0°C/32°F or above 40°C/104°F). Maintain conditions between 5% and 95% relative humidity.

The device is intended for operation under normal atmospheric pressures (700 hPa to 1060 hPa)

- If the controller becomes uncomfortably warm, or when the ambient temperature exceeds 35°C/95°F, use the belt clip to carry the device.
- The controller, camera, and other headset components are not waterproof. Do not use the device in environments that will allow liquids (such as rain and snow) to enter these components.
- **Electrical shock. To avoid electrical shock, do not immerse the BrainPort V100 or the battery charger in liquids.**
- Do not use where flammable gases are present.
- Do not come into contact with any device which is plugged into a wall circuit or any person using such a device.
- Follow the guidance outlined in *CHAPTER 4 – Product Specifications and Technical References* regarding the intended electromagnetic use environment.
- Contact Wicab if you have questions or concerns about a particular use environment.
- **Discomfort.** Using the BrainPort V100 should not cause discomfort. If you experience any pain, numbness or discomfort including burning or stinging, please stop using the device. If the symptoms are temporary, you may resume using the device by reducing the stimulation level to a comfortable level. If the condition recurs, stop using the device and seek professional help.
- **Risk of Strangulation.** Take care in arranging cables to avoid the risk of strangulation. Small children may become entangled in the cables. Do not allow children to use the device. Store the device out of reach of small children.

- *Choking.* The BrainPort V100 contains small parts. Check the device for loose or missing parts before each use. Do not use the device if parts are missing. Do not allow children to use the device. Store the device out of reach of small children.
- *Discomfort.* Use of the BrainPort V100 may be contraindicated for young individuals or people with narrow dental arches of the upper palate – it may be difficult to comfortably place the IOD on the tongue for these individuals.
- *Care and Maintenance.* Use only the procedures in this manual to care for your device.
- *Intended Purpose.* Do not use the BrainPort V100 for any purpose other than that stated in the Indications for Use.
- *Personal Computer.* When using a personal computer with vRemote:
 - Do not allow the user to touch the personal computer;
 - Do not touch the personal computer and the user at the same time;
 - Do not allow the user to come into direct or indirect contact with any device plugged into a wall circuit;
 - Do not use a power strip or extension cord to power the personal computer;
 - The personal computer used to run vRemote is an accessory that is used only by trainers or users' sighted companions, and is not a medical device when operated standalone. It becomes part of a medical device system when used for training and the precautions listed inside the *BrainPort V100 Device User Manual* must be followed to insure client safety.

Precautions

- *Signal Stimulation.* Adjust the stimulation to a comfortable level that allows you to clearly feel and respond to the signal. Increasing beyond this point does not improve effectiveness. If the stimulation causes discomfort, reduce the stimulation setting to a comfortable level. If discomfort continues, remove the IOD from your mouth and discontinue use of the device.
- *Sensitivity to stimulation.* Although the BrainPort V100 is designed to minimize the risk of injury due to stimulation strength, if you react negatively to the stimulation from the BrainPort V100, remove the IOD from your mouth and discontinue use of the device.
- *Oral health.* If you currently have or develop open lesions, sores or abrasions in your mouth, discontinue use of the BrainPort V100 until the situation has resolved.
- *Mouth injuries/Dental Trauma.* The IOD is intended to be held in the mouth during use. Take care so that the cables do not become entangled, pulling the IOD out of your mouth potentially injuring your mouth, teeth or lips.
- *Choking.* The IOD is intended to be held in the mouth during use. To minimize the risk of choking on the IOD, make certain it is securely connected to the flexible cable and that the IOD is positioned properly in the mouth. Do not use the device if the IOD is damaged.
- *Neck Trauma.* Take care so that you do not become entangled in the cables that run from the headset to the controller. A sudden yank could cause neck trauma.
- *Batteries.* Do not use the device with the battery compartment door open. Inspect the battery prior to use. Do not use the battery if it appears damaged,

corroded, is leaking, or is swollen.

- *Connections.* Do not attempt to connect the headset to equipment other than the BrainPort V100 controller. Doing so may damage the BrainPort V100, increase risk, or decrease benefit.
- *Connections.* Do not attempt to connect anything other than the headset that came with your unit to the BrainPort V100 controller. Doing so may damage the BrainPort V100, increase risk, or decrease benefit.

Clinical Experience

The BrainPort V100 device was evaluated in a single arm, open label clinical study of 75 enrolled blind/profoundly blind subjects from 7 sites in the U.S. and Canada. Subjects underwent 2-3 days (10 hours) of training followed by in-home use over the span of 12 months for the study.

The primary safety endpoint was no occurrence of a clinically significant device-related adverse event. A clinically significant device-related adverse event was defined as any event that resulted in tongue burns attributed to use of the BrainPort V100 device, an allergic reaction requiring medical care, or negatively altered changes in taste or numbness that was sustained and/or resulted in withdrawal from the study. The primary efficacy endpoint was success in a test of object recognition of at least 50%. The secondary endpoints measured success rates of at least 50% in tests of word identification and at least 35% in sign identification in a mobility task. Effectiveness endpoints were measured at 12 month follow up, and safety events were captured throughout the study.

Study results demonstrated that the safety objective was achieved, with no clinically significant device-related adverse events throughout the study. There were no serious device-related adverse events. Two (2.67%) of

the study's subjects reported mild/moderate events possibly/probably related to the device that led to decrease in device use or discontinuation of device use. One subject reported worsening sinus drainage that was considered a possible metal allergy and possibly related to the device. Device use was discontinued for this subject. One subject reported tongue soreness that was considered probably related to the device. Device use decreased for this subject. Both subjects recovered. For a complete list of device-related adverse events that occurred in the clinical study of the device, see Appendix B.

In terms of effectiveness, the primary efficacy objective was achieved with more than 50% of subjects achieving success on the object recognition task. Results of the secondary efficacy endpoints similarly confirmed device performance, where approximately 44% of subjects were able to successfully complete the word identification and mobility tasks (where subjects with missing data were counted as failures for a conservative analysis). Based on all available data at the end of the study, i.e., the "per protocol" subjects who completed 12 month follow up, 57.9% of the study subjects successfully completed the word identification and mobility tasks.

Overall, evaluation of the safety and efficacy of the BrainPort V100 device demonstrated a low-risk safety profile with no serious device-related adverse events, and strong effectiveness results confirming device performance in the intended user population.

Product and Package Labeling

The labels on the back of the BrainPort V100 controller and on its packaging provide important information. You will need the model name, model number, reference number, and serial number if you call Wicab for assistance. See the inside back cover of this manual for contact information.

Product Label

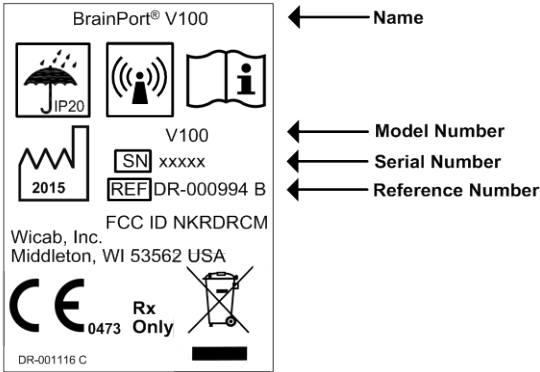

Explanation of Symbols



Important safety information is contained in the documents that accompany the device.



Year of manufacture



The BrainPort V100 includes RF transmitters



Keep the BrainPort V100 dry.



Dispose of in accordance with WEEE



Serial Number



Reference Number

Package Label

BrainPort® V100

V100 DR-001062

Wicab, Inc.

8313 Greenway Blvd

Middleton, WI 53562 USA

DR-001115 Rev B

Rx only

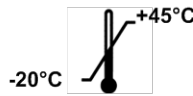
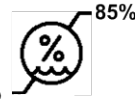

Explanation of Symbols

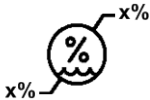

Humidity range for transportation and storage



Fragile

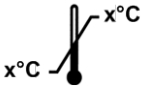

Temperature range for transportation and storage



Keep dry



Important safety information is contained in the documents that accompany the device.



Year of manufacture



Dispose of in accordance with WEEE

CHAPTER 2

Using the BrainPort® V100

This chapter explains how to set up and use the BrainPort V100.

(Refer to Figure 1: BrainPort V100 and/or the verbal descriptions below)



Using procedures other than those specified in this manual may damage the BrainPort V100, increase risk of injury, and decrease benefits of use.



Before EACH use, tactilely inspect the device for damage, for example, anything rough or loose on the IOD, disconnected cables, etc. If you find any of these problems, contact Customer Support and DO NOT use the device.

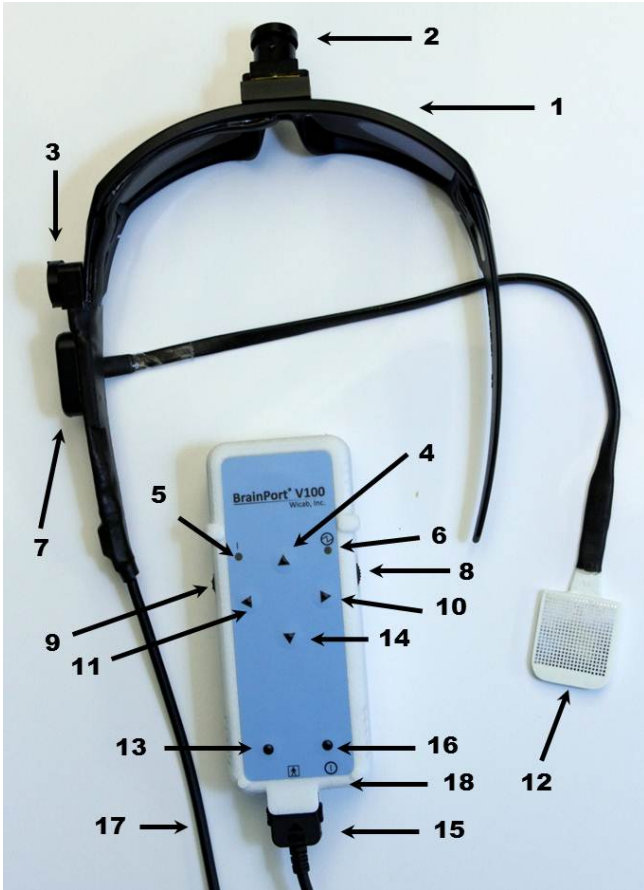

Figure 1: BrainPort V100

BrainPort® V100 Device Components

- | | |
|---------------------------|---|
| 1 Headset | 2 Camera – Image Sensor |
| 3 Camera Tilt Knob | 4 Contrast Button |
| 5 Power Indicator LED | 6 Stimulation Indicator LED |
| 7 IOD Receptacle | 8 Zoom Dial / Zoom Home |
| 9 Intensity Dial / Invert | 10 Status Button |
| 11 Image Gain LOCK | 12 IOD (Intra-Oral Device) with
Tongue Array |
| 13 Test Button | 14 Image Mode Button |
| 15 Headset Connector | 16 Option Button |
| 17 Headset Cable | 18 Power ON/OFF Button |

User Interface Description

The BrainPort V100 may be held in either hand with the bottom end of the controller (point of headset connection) facing downwards and the front panel of the controller with six raised buttons facing toward the user.

Four of the raised buttons on the front panel of the device are oriented in a diamond pattern, located at 12 o'clock, 3 o'clock, 6 o'clock, and 9 o'clock. There are two additional buttons on the front panel near the bottom of the controller.

On each side of the device there are wheels that both rotate and act as a button when pressed in. Wicab recommends holding the device so that your thumb rotates one wheel and your forefinger rotates the other wheel.

Finally, on the bottom of the controller, next to the connector is a button controlling power on and off.

Pressing the buttons or wheels will emit a beep and a voice will announce the information assigned to each button. Some actions also trigger a vibration felt in the hand. Button descriptions and uses are provided below.

Contrast (12 o'clock button- 4): This button toggles between standard contrast (default) and high contrast mode. PRESS once to activate high contrast and PRESS again to return to normal contrast.

Status (3 o'clock button- 10): PRESS and release of this button provides a quick status of the battery percentage and zoom level in degrees field of view. PRESS-HOLD the button for one second to hear additional status information such as battery level, zoom level, intensity level, lock status, and invert status, tilt, low light status.

Image Mode (6 o'clock button- 14): This button is a three state toggle. PRESSING it once makes a bright image more detailed on the tongue, PRESSING it twice makes a darker image more detailed on the tongue, and PRESSING it three times returns to default image mode.

Lock (9 o'clock button- 11): This button toggles between allowing the camera to automatically adjust to the lighting conditions (default) and locking that feature. The device will announce whether lock is on or off.

Test (Bottom left button- 13): PRESSING this button displays a test pattern on the tongue array to enable confirmation that the tongue display is active. To stop the test pattern press the Test button a second time.

Volume (Bottom right button- 16): This button toggles between three volume levels: high volume, low volume (default), and mute/vibrate only. *Note: You cannot mute the status button.*

Power (18): Located on the narrow end of the controller, next to the headset connector housing is a small button controlling power on and off. To turn the device on or off, PRESS the button for two seconds.

Intensity and Invert (Left Wheel- 9): On the left side of the controller is a rotating wheel that also acts as a button when PRESSED. This wheel controls stimulation intensity, while the button controls the invert function.

Turning the wheel up (towards the top of the controller) increases the intensity of the stimulation on your tongue. Turning the wheel down (towards the bottom of the controller) decreases the intensity on your tongue. The device will vibrate at the limits of stimulation (highest = 100, lowest = 0). At power up, stimulation intensity always resets to zero and must be increased to your comfortable working level.

A PRESS of the stimulation wheel activates the Invert feature that inverts the stimulation intensity values – strongest becomes weakest and vice-versa. The Invert Feature is used to toggle between whether bright objects or dark objects in the field of view stimulate the tongue array.

Zoom and Home (Right Wheel- 8): On the right side of the controller is a rotating wheel that also acts as a button when PRESSED. The wheel and button control the zoom level of the camera.

Turning the wheel up (towards the top of the controller) zooms the camera in (reducing the camera's effective field of view). Turning the wheel down (towards the bottom of the controller) zooms the camera out (increasing the camera's field of view). The device will vibrate at the limits of zoom (widest = 69 degrees, narrowest = 3 degrees).

PRESSING the wheel straight in activates the home zoom position. The default home position is a medium field of view (24 degrees). To set the home zoom position, use the right zoom wheel to achieve the desired field of view and then PRESS and hold the right wheel for two seconds.

Camera Tilt (3): On the left side of the headset temple is a small round wheel with a tactile line in the middle. Prior to start up, make sure the tactile line is positioned horizontally. Upon start up, rotating the knob through its positions (all the way down and all the way up) calibrates the digital camera tilt. You will hear a tone once tilt has been initialized. The tilt knob is non-functional until it has been calibrated. The raised tactile line indicates the direction of tilt.

Battery Compartment: On the back of the unit is a sunken well. Insert a finger into the well to grasp the lip

of the battery cover door and pull straight back, away from the controller, to open the battery compartment.

A fully charged battery should always be used at the start of each session.

Companion Software (vRemote)

Letters in parentheses refer to *Figure 2. vRemote* below.

The vRemote software program runs on a personal computer and can be used by a sighted companion to view the images collected by the BrainPort V100 camera and presented to the IOD. The Camera View **(A)** represents a generally higher resolution view of the scene detected by the camera. The yellow box in the Camera View **(A)** represents the region of interest (zoom/field of view) that the user has chosen. The IOD View **(B)** is a visual representation of the information being sent to the IOD (derived from the region of interest).

vRemote is not to be used by the companion to provide any instructions to the user, but is simply for watching. The companion software can be used as an assistive tool for practice following standard device training with a Wicab certified trainer.

Note: The personal computer used to run the vRemote software must have an operating system of Windows XP or higher (.NET 4.0 or higher), and must be able to establish an 'ad-hoc' Wi-Fi connection (minimum 802.11 a/b) with the BrainPort V100 device.

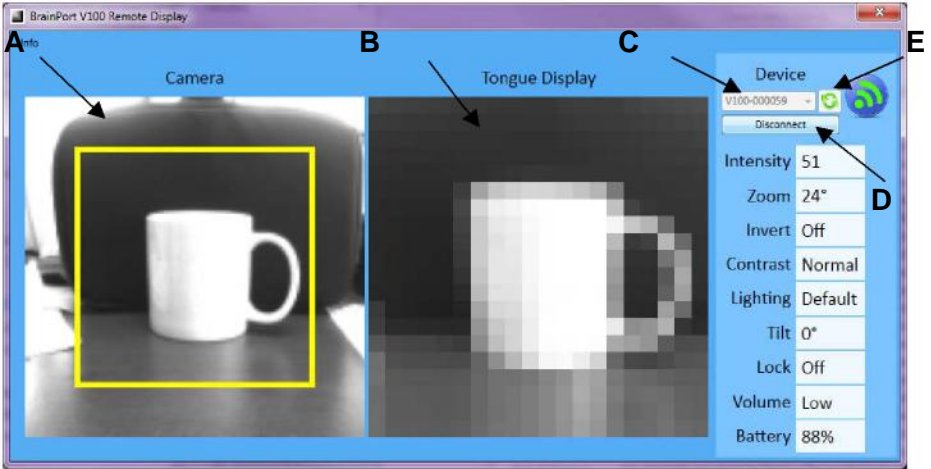

Figure 2. vRemote

- A. Camera View
- B. IOD View
- C. Device Name (Serial No.)
- D. Connect/Disconnect Button
- E. Refresh Button

Quick Start: Turning on the BrainPort V100

Numbers in parentheses refer to Figure 1: BrainPort V100

1. Fully charge the batteries included with your device prior to using your BrainPort V100 for the first time.
2. Wicab recommends that you thoroughly clean the IOD before using it for the first time. Use the alcohol towelette (included with your device) to clean the IOD. Allow to air dry. Thoroughly rinse the IOD with tap water. Your IOD is ready for use after the rinse. See "Care and Maintenance" for detailed instructions on how to clean the IOD.
3. The headset cable connector **(15)** is attached to a receptacle at the base of the Controller near the Power On/Off button **(18)**. This will be considered the bottom of the Controller.
4. Insert a fully charged battery into the back of the Controller.
5. Verify that the Tilt Knob **(3)** is at its home position by rotating it up (clockwise) until it reaches its stop position (do not force past the stop point).
6. There are two ways to use the BrainPort V100: in standalone mode, or in Wi-Fi mode to connect to the companion vRemote software.

Standalone Mode

To turn on the BrainPort V100 in standalone mode, PRESS the Power On/Off button **(18)** at the bottom of the Controller. After power-up, the device issues a series of one second ticks followed by (~35 sec) the phrase "active mode" which indicates the BrainPort V100 has completed its self-test and is ready for use.

WiFi Mode

To turn on the BrainPort V100 in Wi-Fi mode, hold both wheels **(8 and 9)** in towards the middle of the controller then PRESS the Power On/Off button **(18)**

at the bottom of the Controller. The Controller will double beep, perform the same power up self-testing as above, and then announce "Wi-Fi enabled" "active mode". You may release the wheels after the initial double beep.

Starting in WiFi mode is necessary if you wish to connect to vRemote

7. Place the headset onto your head and make any adjustments for comfort.
8. Initialize camera tilt by rotating the tilt knob **(3)** down (counter-clockwise) and back to its start position, until an initialization double beep is heard. This ensures that the device tilt range is maximized.
9. Hold the Controller in your right hand with the buttons of the front panel facing toward you for purposes of these instructions.
10. Place the IOD in your mouth. Use the stimulation intensity dial on the left side **(9)** of the Controller to control stimulation intensity.
11. The camera field of view (zoom) will default to a medium field of view (24 degrees). This can be changed by using the Zoom dial **(8)**.
12. To shut down the system, PRESS-HOLD the Power On/Off button **(18)** until all beeps are finished (approximately 4 seconds).

Starting vRemote

If your sighted companion will be using the personal computer with vRemote software, follow the instructions below:

1. Start the V100 in WiFi mode.

2. Power-on the personal computer and wait for the operating system to boot.
3. Open the vRemote program and click the Refresh button.
4. Each unit is configured with an Ad Hoc network corresponding to its serial number. From the drop-down menu in vRemote, choose the wireless network that matches the numeric portion of the device serial number of the user's device. For instance if the device serial number is SN000079, select wireless network BPV-000079. Press the Connect button to connect to the Wi-Fi network. The device will announce "Wi-Fi connect" and the camera image will appear inside vRemote.
5. A Camera View **(A)** and IOD View image **(B)** should appear in vRemote on the personal computer. Note:
 - a. Reminder: Review *Personal Computer* under General Warnings.
6. To turn off the system, turn off both the BrainPort V100 device and the personal computer; order is not important.
 - a. Exit the vRemote application and power down the personal computer.

Device Announcements

During use, the device will produce a variety of announcements following button presses. These announcements let the user know which button was pressed and what changes have been made to the camera or IOD. Sometimes the device may detect change in environmental conditions.

Low Light

In low light conditions, the device will announce “low light” one time per session. A long PRESS of the Status button will reveal whether the conditions remain low light. This announcement is used to remind users to optimize their lighting conditions (i.e. turn on a light) in order for the camera to capture a useful image.

LOW BATTERY

When the battery level decreases to a low level, the device will repeatedly announce “low battery”. This announcement acts as a reminder that a replacement battery should be inserted in order to continue using the device.

STANDBY MODE

The device will announce “standby mode” when the headset is not properly connected to the controller. When the device is in standby mode, no button will function until the device returns to active mode.

ACTIVE MODE

The device will announce “active mode” upon completion of start-up testing or when the headset connection has been restored. The device is ready for use while in active mode.

WI-FI MODE

The device will announce “Wi-Fi enabled” upon activation of the Wi-Fi module and completion of start-up testing. The device is ready to connect to the vRemote software while in Wi-Fi mode.

When the device connects with the vRemote software, the device will announce “Wi-Fi connect”. When the device is disconnected from vRemote, it will announce “Wi-Fi disconnect”.

Batteries

The system includes a rechargeable Lithium-Polymer battery, charger and charging instructions. When fully charged, a battery provides approximately three hours of standard usage. A given battery has an expected life of more than 500 charge cycles. A fully charged battery should always be used at the beginning of each session.

To replace the battery, open the door on the back on the Controller by inserting a finger into the recessed area and swinging the door toward the end of the box where the cable connects. To remove the battery, grip the top of the battery and pull outward. To replace the battery, align the exposed metal connectors to the metal connectors in the Controller and snap the battery into place and close the door.



To test the battery power while using the BrainPort V100, use a PRESS of the Status button. The speaker will report the approximate percentage of charge remaining for the installed battery. In a low battery condition, the device may shutdown automatically to avoid improper operation.

Avoid direct contact with the gold contacts located in the battery compartment and on the battery.

- If you will not be using the BrainPort V100 for a period of more than 5 days, remove the battery.
- Storage and Transportation Conditions:
 - Temperature: -20°C to +45°C
 - Humidity: 5% to 85%



The nearby figure shows the location of the Battery Manufacturer Part Number.

BrainPort V100 Battery Specifications	
Wicab Part Number	DR-000839
Manufacturer Part Number	56446 702 099
Battery Type	Rechargeable Li-Polymer
Electrical Specification	<ul style="list-style-type: none"> - 3.7V - 2260mAh - 8.4Wh
Storage and Transportation Conditions	<ul style="list-style-type: none"> - Temperature: -20°C to +45°C - Humidity: 5% to 85%
Charge Cycles	> 500

Battery Charger

A copy of the battery charger manual is provided with your BrainPort V 100. Follow the manufacturer's instructions when charging your battery.

Avoid direct contact with the gold contacts located in the pocket of the charger. Do not power the charger using a power strip or extension cord.

Battery Precautions

- Avoid short circuits
- Do not heat the batteries above 60°C
- Do not dispose of batteries in fire
- Do not solder directly to the battery
- Do not charge with more than 1C and above 4.2V
- Do not charge below 0°C or above 45°C
- Do not discharge with more than 1C and below 2.7V
- Do not discharge below -20°C or above 60°C
- Do not disassemble the batteries
- Do not insert the batteries in reverse polarity
- **WARNING: FIRE, EXPLOSION, AND SEVERE BURNS HAZARD**



Personal injury can occur if the battery is handled carelessly or improperly. For your safety, follow these instructions for proper battery handling:

- The battery can ignite or explode if not handled properly. If you notice any deformities, cracks, or other abnormalities in the battery, immediately discontinue use of the battery and contact the manufacturer.
- Use only authentic, manufacturer-recommended battery chargers and charge the battery only by the method described in this user manual.
- Do not place the battery near heating devices or expose to excessively warm environments, such as the inside of an enclosed car in the summertime.
- Do not place the battery in a microwave oven.
- Avoid storing or using the battery in hot, humid places, such as spas or shower enclosures

Care and Maintenance

- If you will not be using the BrainPort V100 for a period of more than 5 days, remove the battery.
- Thoroughly rinse the IOD with tap water as needed to remove contaminants. You may use it immediately following such a rinse.
- Wicab recommends that you clean the IOD once a week. Use the cleaning solutions listed in Appendix A on a cotton ball or cotton swab to gently wipe the surfaces of the IOD. DO NOT SCRUB! Thoroughly rinse the IOD with tap water to remove any residual cleaning solution and allow it to air-dry.
- As needed, use a cloth slightly damp with water to wipe the exterior of the controller, headset, and battery charger. DO NOT rinse or immerse the controller, headset, or the battery charger. After cleaning, allow the controller, headset, and battery charger to dry completely before use.
- DO NOT store or transport the device in extreme hot or cold conditions (except for batteries – see above section).

Storage and Transportation Conditions:

- Temperature: -25°C to +70°C
- Humidity: 5% to 95%
- DO NOT bend, fold, or crush the IOD cable as this may permanently damage the IOD.
- Always protect the IOD. To avoid damaging the IOD, follow these instructions:
 - Do not drag the IOD electrode surface across an object;
 - Do not strike the IOD against a hard object;
 - Do not allow the IOD to come in contact with other electrical equipment such as cell phones, cell phone chargers, portable music players, etc.

CHAPTER 3

Troubleshooting

This chapter describes steps you can take if the BrainPort V100 does not seem to be working properly. You may need the assistance of a sighted individual to help with troubleshooting. If the troubleshooting procedures do not help, if you need further assistance, or if you think the device may need service, use the information on the inside back cover of this manual to contact Wicab.

The BrainPort V100 has no user-serviceable parts and does not require routine adjustment or calibration. You will void your warranty if you attempt to service the BrainPort V100.



DO NOT attempt to repair the BrainPort V100 yourself.

To insure that you receive accurate real time information representative of the scene captured by the camera, the device self-monitors and transitions from active mode to standby mode (stimulation disabled) whenever an irregularity occurs. This is the normal and intended behavior of the device as it insures that you do not act upon potentially compromised or significantly time delayed visual information. You must take action to return to active mode. The device prevents a return to active mode if the irregularity persists. If the device emits 3 warning beeps and stops functioning, simply turn the power off, then restart the device as usual.

Problems with Battery Power

The BrainPort V100 battery status reports the estimated percentage of power remaining, assuming a fully charged battery was installed at the beginning of the session. In cases where a partially charged battery is used, the battery report may be misleading and put the device into low battery states more quickly than expected.

When the battery in the BrainPort V100 nears the end of its useful life it may take longer to recharge and the duration of use following a recharge may be shorter. If you notice these changes, or suspect that you have other battery related problems, execute the steps below before contacting Wicab.



The BrainPort V100 uses a rechargeable battery that contains electronic components that address safety requirements and that increase its useful life. These electronic components are not present in over-the-counter batteries. Using any other battery may damage the device and increase risk of use.



The battery charger supplied with the BrainPort V100 is specifically designed for use with the battery of the BrainPort V100. Using any other battery charger may damage the device and increase risk of use.



Do not use the device with the battery compartment door open.

Perform the following steps to identify the source of a battery power problem.

1. Follow the instructions in the battery charger manual to insure the charger is working properly. If the behavior of your battery charger does not match the operation described in the manual, the problem is most likely to be with the battery charger. Use the information on the inside back cover of this manual to

contact Wicab to report the charger problem.

2. If the charger functions correctly, fully charge a battery. Once charged, place the battery into the BrainPort V100 controller and attempt to power up the controller. If the controller does not illuminate the green power-on light or begin the startup ticks, repeat the prior test with your second battery. If the controller still does not illuminate the green power-on light or emit the startup ticks, the problem is most likely to be with the controller. Use the information on the inside back cover of this manual to contact Wicab to report the controller problem.

If, however, the green power-on light illuminates or startup ticks begin with one, but not the other, of your batteries, the problem is most likely with the battery that fails to power up the controller. Use the information on the inside back cover of this manual to contact Wicab to report the battery problem.

3. With the fully charged battery inserted, turn your system on and note the time. If after two hours of continuous operation, if the device is functioning, your battery is functioning as expected. Repeat the two hour test on your second battery. Should either battery fail to operate the device for two hours or more, the battery is likely nearing the end of its natural life. Use the information on the inside back cover of this manual to contact Wicab.
4. If you reach this point, your batteries are mostly likely functioning properly. If you continue to have problems with your device, proceed to the controller troubleshooting section below.

Controller Troubleshooting

Perform the following steps if you suspect a malfunction with the controller. If you identify a problem with the controller and contact Wicab, the support staff may ask for the serial number of the controller. This is found on the system label on the rear of the unit (see Product Label in Chapter 1).

1. Place a fully charged battery into the controller and attempt to power up the controller. If the controller does not illuminate the green power-on light or begin the startup ticks, perform the battery power troubleshooting procedure described above before continuing with troubleshooting of the controller.
2. If the controller illuminates the green power-on light and begins the startup ticks, but does not produce the ready for operation announcement of *"active mode"*, the problem is most likely to be with the controller. Use the information on the inside back cover of this manual to contact Wicab to report the controller problem.
3. If the controller successfully completes the self-test, depress each of the buttons and dials in turn. The controller should beep with each depression. If the controller does not beep for every depression of a button or dial, the problem is most likely to be with the controller. Use the information on the inside back cover of this manual to contact Wicab to report the controller problem.
4. If the controller successfully recognizes button and dial depressions, rotate the stimulation dial and verify the stimulation light illuminates yellow and that you feel stimulation on your tongue from the IOD. If the yellow stimulation light fails to illuminate or you do not feel any stimulation, the problem is most likely to be with the controller. Use the information on the inside back cover of this manual to contact Wicab to report the controller problem.

5. If the yellow stimulation light illuminates or you can feel stimulation, remove the IOD from your mouth. Rotate both the stimulation and zoom dials through their fully up and fully down positions. Verify the controller vibrates when the maximum and minimum stimulation and zoom levels are reached. If the controller does not vibrate when a limit is reached, the yellow stimulation light stays illuminated, or you feel stimulation when the stimulation dial is rotated to minimum, the problem is most likely to be with the controller. Use the information on the inside back cover of this manual to contact Wicab to report the controller problem.
6. If you reach this point, your controller is mostly likely functioning properly. If you continue to have problems with your device, proceed to the headset troubleshooting section.

Headset Troubleshooting

1. Perform the following step if you suspect a malfunction with the headset. If you identify a problem with the headset and contact Wicab, the support staff may ask for the serial number of the headset. This is found on the label located on the inside of the glasses on the left hand side. Perform the controller troubleshooting section; including a test of your batteries as noted in step one. If both your batteries and controller are functioning properly, then the problem is most likely with the headset. Use the information on the inside back cover of this manual to contact Wicab to report the headset problem.

vRemote Troubleshooting

1. Delayed camera image. Due to Wi-Fi limitations an occasional delay in the camera image may occur. To minimize delay the distance between the personal computer and Controller should be less than 6 meters (20 feet).
2. Intermittent connection problems. Replace the battery with a fully charged battery in the Controller. Follow instructions in "Starting vRemote".
3. Device serial number not listed in "Wireless Connection" dialog on the personal computer. Replace the battery with a fully charged battery in the Controller. Follow instructions in "Starting vRemote".

If you continue to experience difficulties with the device or the vRemote software, contact Wicab for assistance.

CHAPTER 4

Product Specifications and Technical References

This chapter provides technical reference material that may be useful to you, your doctor, your trainer, or local, state, and national regulatory agencies.

General Specifications

	Type BF Equipment
Physical	Length 13.3 cm width 5.6 cm height 3.5 cm (excluding belt clip) weight <175 g (including battery) Cable length to headset 106 cm
Power	Internally powered by a lithium polymer rechargeable battery (3.7V, 2260mAh, 8.4Wh)
Output Waveforms	Monophasic Capacitive coupling
Pulse Frequency	200 Hz
Pulse Width	25 μ s
Surface Area	0.46 mm ² (per electrode)
Voltage	0 to 1.414 V rms (per electrode) 0 to 14.14 V rms (device)
Current	0 to 0.518 mA rms (per electrode) 0 to 20.7 mA rms (device)
Energy/pulse	10.35 μ J (see note below)
Materials	The BrainPort V100 is not made with natural rubber latex
Disposal	Many localities have recycling requirements for batteries, electronic equipment, and packaging. Recycle or dispose of the device and its packaging in accordance with local ordinances.
Environmental Conditions	Operating Conditions: <ul style="list-style-type: none"> - Temperature Range: 0°C to +40°C - Humidity Range: 5% to 95%

	<ul style="list-style-type: none"> - Atmospheric pressure range of 700 hPa to 1060 hPa <p>Storage and Transportation Conditions (except batteries):</p> <ul style="list-style-type: none"> - Temperature Range: -25°C to +70°C - Humidity Range: 5% to 95% <p>Storage and Transportation Conditions (batteries):</p> <ul style="list-style-type: none"> - Temperature Range: -20°C to +45°C - Humidity Range: 5% to 85%
IP Classification	<p>The BrainPort V100 is classified as IP20. The device is protected against solid foreign objects over 12 mm.</p> <p>Regarding 60601-1-11 8.3.1: Other than the IOD assembly, the V100 device is not designed to prevent ingress of water or other liquids per test of IEC 60529:1989 for IPX2. However, in all cases the device maintains BASIC SAFETY and ESSENTIAL PERFORMANCE (which may include cessation of operation) after undergoing the test.</p> <p>The IOD assembly is IPX4 rated (protection against splashing water)</p>
Intended Conditions for Use	<ul style="list-style-type: none"> - Non-Sterile - Used in the home environment - Used to augment white cane or guide dog. Does not replace white cane or guide dog. - Typical duration of use: multiple sessions per day, usually less than an hour per session
Part Numbers	<p>Controller: DR-000994 (V100) Headset: DR-000649 Battery: DR-000839 (56446 702 099)</p>
Declaration of Conformity	<p>The CE mark on this product indicates it complies with the provisions noted in the 93/42/EEC Medical Device Directive.</p>

Note: Stimulation is voltage controlled and limited to 20.0 Volts. Stimulation current depends on variations in user physiology and with the pressure of the tongue against the electrode array. Values given for current and energy per pulse are at maximum voltage into a 2770 Ω load, for a single electrode. Up to four electrodes may be active at any given time; therefore the current may exceed 10mA rms.

User Profile

User	For use by individuals who are profoundly blind.
Education	Completed traditional blindness rehabilitation: white cane, and/or guide dog, and rehabilitation in activities of daily living
Knowledge	Minimum: ability to understand verbal training instructions Reading and comprehension at 10 th grade level
Experience	All users must participate in a minimum of 10 hours of supervised training per Wicab's training protocol prior to unsupervised use of the device
Permissible Impairments	Diagnosis of no light perception or light perception Blindness may be acquired or congenital Absence of oral sensory impairments

Electromagnetic Compatibility

Medical electrical equipment needs special precautions regarding electromagnetic compatibility. The BrainPort V100 should be used according to the electromagnetic compatibility information provided below.



NOTE: The BrainPort V100 (DR-0001062) uses WiFi and an antenna. The following information is included for reference.

Your BrainPort V100 contains a Wi-Fi transmitter and receiver with the following characteristics:

FCC ID	NKRDRCM
Description	WLAN 802.11B/G CF MODULE
Model No.	DRCM-81
Frequency Range 802.11b/g:	2400~2483.5 MHz
Support channels for 802.11b/g	11 Channels
Antenna Type	Dipole
Antenna peak Gain	2 dBi (11b/g)

Other equipment may interfere with this device, even if that other equipment complies with CISPR emission requirements.

This equipment has been designed to comply with the limits for a Class B digital device, pursuant to Part 15 of the FCC Rules. These limits are designed to provide reasonable protection against harmful interference in a residential installation. This equipment generates, uses, and can radiate radio frequency energy and, if not installed and used in accordance with the instruction, may cause harmful interference to radio communications. There is no guarantee that interference will not occur in a particular installation. If this equipment does cause harmful interference to radio or television reception, which can be determined by turning the equipment off and on, the user is encouraged to try the correct the interference by one of the following measures:

- Reorient or relocate the receiving antenna.
- Increase the separation between the equipment and receiver
- Consult the dealer or an experienced radio/TV technician for help.

The BrainPort V100 has been tested and found to conform to IEC 60601-1-2 and is intended for use in the electromagnetic environment specified in the following tables. If you must use the BrainPort V100 in close proximity to other electronic equipment, observe the device to verify normal operations before starting use.

Note: The following tables use the European convention of representing decimal values with a comma instead of a period as is done in the United States. For example, the value "2,5 GHz" in Table 204 is typically written "2.5 GHz" in the United States.

This device complies with part 15 of the FCC Rules.

Operation is subject to the following two conditions:

- (1) This device may not cause harmful interference, and
- (2) this device must accept any interference received, including interference that may cause undesired operation.

Changes or modifications not expressly approved by the party responsible for compliance could void the user's authority to operate the equipment.

Table 1: Electromagnetic Emissions

The user of the BrainPort V100 should ensure that it is used in the intended environment, as specified below.

Guidance and manufacturer’s declaration – electromagnetic emissions		
The BrainPort V100 is intended for use in the electromagnetic environment specified below. The customer or the user of the BrainPort V100 should assure that it is used in such an environment.		
Emissions test	Compliance	Electromagnetic environment – guidance
RF emissions CISPR 11	Group 1	The BrainPort V100 must emit electro-magnetic energy in order to perform its intended function. Nearby electronic equipment may be affected. The product is considered Group 1 - the emitted energy is below 9kHz.
RF emissions CISPR 11	Class B	The BrainPort V100 is suitable for use in all establishments, including domestic establishments and those directly connected to the public low-voltage power supply network, which supplies power for buildings used for domestic purposes.
Harmonic emissions IEC 61000-3-2	Not applicable (internally powered)	
Voltage fluctuations/ flicker emissions IEC 61000-3-3	Not applicable (internally powered)	

Table 2: Electromagnetic Immunity

The user of the BrainPort V100 should ensure that it is used in the intended environment, as specified below.

Guidance and manufacturer's declaration – electromagnetic immunity			
The BrainPort V100 is intended for use in the electromagnetic environment specified below. The customer or the user of the BrainPort V100 should assure that it is used in such an environment.			
Immunity test	IEC 60601 test level	Compliance level	Electromagnetic environment – guidance
Electrostatic discharge (ESD) IEC 61000-4-2	±8 kV contact ±15 kV air	±8 kV contact ± 15 kV air	Floors should be wood, concrete, or ceramic tile. If floor covering is synthetic material, the relative humidity should be at least 30%.
Electrical fast transient/burst IEC 61000-4-4	±2 kV for power supply lines ±1 kV for input/output Lines	Not applicable (internally powered) (No input/output lines)	
Surge IEC 61000-4-5	±1 kV line(s) to line(s) ±2 kV line(s) to earth	Not applicable (internally powered)	
Voltage dips, short interruptions, and voltage variations on power supply input lines IEC 61000-4-11	<5% Ut (>95% dip in Ut) for 0,5 cycle 40% Ut (60% dip in Ut) for 5 cycles 70% Ut (30% dip in Ut) for 25 cycles <5% Ut (>95% dip in Ut) for 5 sec	Not applicable (internally powered)	
Power frequency (50/60 Hz) magnetic field IEC 61000-4-8	30 A/m	30 A/m	Power frequency magnetic fields should be at levels characteristic of a typical commercial building or hospital or home.
Note: Ut is the a.c. main voltage prior to application of the test level.			

Table 3: Electromagnetic Immunity

Users of the BrainPort V100 should ensure that it is used in the intended environment, as specified below.

Guidance and manufacturer’s declaration – electromagnetic immunity			
The BrainPort V100 is intended for use in the electromagnetic environment specified below. The customer or the user of the BrainPort V100 should assure that it is used in such an environment.			
Immunity test	IEC 60601 test level	Compliance level	Electromagnetic environment – guidance
Conducted RF IEC 61000-4-6	6 Vrms; 150 kHz to 80 MHz	6 V	Portable and mobile RF communications equipment should be used no closer to the BrainPort V100, including cables, than the recommended separation distance calculated from the equation that applies to the transmitter’s frequency. Recommended separation distance $d = 1,2\sqrt{P}$
Radiated RF IEC 61000-4-3	10 V/m; 80 MHz to 2,7 GHz	10 V/m	$d = 1,2\sqrt{P}$ 80 MHz to 800 MHz $d = 2,3\sqrt{P}$ 800 MHz to 2,5 GHz Where P is the maximum output power rating of the transmitter in watts (W) according to the transmitter manufacturer, and d is the recommended separation distance in metres (m). Field strengths from fixed RF transmitters, as

determined by an electromagnetic site survey,^a should be less than the compliance level in each frequency range.^b

Interference may occur in the vicinity of equipment marked with the following symbol:



Note 1: At 80 MHz and 800 MHz, the higher frequency range applies.

Note 2: These guidelines may not apply in all situations. Electromagnetic propagation is affected by absorption and reflection from structures, objects, and people.

- ^a Field strengths from fixed transmitters, such as base stations for radio (cellular/cordless) telephones and land mobile radios, amateur radio, AM and FM radio broadcast, and TV broadcast, cannot be predicted theoretically with accuracy. To assess the electromagnetic environment due to fixed RF transmitters, consider doing an electromagnetic site survey. If the measured field strength in the location in which the BrainPort V100 is used exceeds the applicable RF compliance level above, observe the BrainPort V100 to verify normal operation. If you detect abnormal performance, additional measures may be necessary, such as reorienting or relocating the BrainPort V100.
- ^b Over the frequency range of 150 kHz to 80 MHz, field strengths should be less than 10 V/m.

Table 4: Recommended Separation Distances

Users of the BrainPort V100 should ensure that it is used in the intended environment, as specified below.

Recommended separation distances between portable and mobile RF communications equipment and the BrainPort V100.			
The BrainPort V100 is intended for use in an electromagnetic environment in which radiated RF disturbances are controlled. The customer or user of the BrainPort V100 can help prevent electromagnetic interference by maintaining a minimum distance between portable and mobile RF communications equipment (transmitters) and the BrainPort V100 as recommended below, according to the maximum output power of the communications equipment.			
Rated maximum output power of transmitter W	Separation distance according to frequency of transmitter M		
	150 kHz to 80 MHz $d = 1,2\sqrt{P}$	80 MHz to 800 MHz $d = 1,2\sqrt{P}$	800 MHz to 2,5 GHz $d = 2,3\sqrt{P}$
0,01	0,12	0,12	0,23
0,1	0,38	0,38	0,73
1	1,2	1,2	2,3
10	3,8	3,8	7,3
100	12	12	23
For transmitters rated at a maximum output power not listed above, the recommended separation distance d in metres (m) can be estimated using the equation applicable to the frequency of the transmitter, where P is the maximum output power of the transmitter in watts (W) according to the transmitter manufacturer.			
Note 1: At 80 MHz and 800 MHz, the separation distance for the higher frequency range applies.			
Note 2: These guidelines may not apply in all situations. Electromagnetic propagation is affected by absorption and reflection from structures, objects, and people.			

Warranty

Limited Product Warranty. Wicab, Inc. (the "Company") warrants to the purchaser ("Purchaser") (limited to the original Purchaser and to no other person) that the Product and the component parts thereof manufactured and distributed by the Company will meet the specifications stated on the Product specification sheets and shall be free from defects in workmanship and materials for a period of two years (Service Life) measured from the date the Product is shipped to the Purchaser ("Warranty Period"). If any component of the Product does not conform to these specifications, the Company will, at its sole discretion, as its sole and exclusive liability and as to the Buyer's sole and exclusive remedy, repair or replace the Product with a new or factory reconditioned Product at no charge or refund the cost of the Product; provided that notice of nonconformance (setting forth in reasonable detail the nature of the nonconformance) is given the Company within the Warranty Period and within 30 calendar days of the discovery of the defect or nonconformance.

This warranty limits the Company's liability to the repair or replacement of Product or refund of the cost of Product. No other warranties of any kind, express or implied, including without limitation, an implied warranty of merchantability or fitness for a particular purpose or noninfringement, are provided by company. Company shall in no event be liable for personal injury or property damage or any other loss, damage, cost of repair, or direct, indirect, incidental, special, consequential, or punitive damages of any kind, whether based upon warranty, contract, strict liability, negligence, or any other cause of action, arising out of the sale, use, results of the use or inability to use product or its components. The foregoing shall apply, without limitation to losses of profits, business interruption, damages to purchaser's reputation or any other such damages.

Limitation of Liability. With respect to any Company liability not legally subject to the foregoing terms, the Company's liability shall not exceed the amount paid by Purchaser to the Company for the Product.

Appendix A Cleansers

Wicab recommends that you clean the IOD once per week using the cleansers listed in the table below. If the cleanser is in solution, wet a cotton ball or cotton swab and gently wipe the surfaces of the IOD. **DO NOT SCRUB!** Thoroughly rinse the IOD with tap water to remove any residual cleanser and allow it to air-dry.

The cleansers listed below have been tested and shown to be compatible with the materials used in IOD. Follow the manufacturer's directions regarding safe use and disposal for the cleanser.

Please visit our website for the most recent list of approved cleansers. Cleansers are added to the list as they are tested and shown to be compatible with the IOD.

Cleanser	Source
70% isopropyl alcohol (rubbing alcohol)	Over the Counter (local pharmacy) May be in solution or as 'wipes'



The IOD may be damaged by bleach or oxidizing agents. Do not use any product that contains chlorine, sodium hypochlorite, calcium hypochlorite, hydrogen peroxide, sodium percarbonate, sodium perborate, or similar chemical. Household bleach and over-the-counter whitening agents will damage the IOD.

Appendix B Clinical Safety Information

As described in Chapter 1, the BrainPort V100 was evaluated in a clinical study of 75 enrolled subjects. All adverse events reported, regardless of whether or not the events were related to the device, were captured in the study. The device-related adverse events are presented in Table A below. Throughout the 12 month study, a total of 28 device-related adverse events were reported in 18 subjects, but no clinically significant device-related adverse event occurred.

Table A: Device-Related Adverse Events Reported with Use of the BrainPort V100 Device (n=75 Subjects)

Type of Event	Number of Events	Events
Allergic reaction NOT requiring medical care	3	Sinus Drainage Worsening
		Metallic Taste
		Suspected Metal Allergy
Positively altered change in taste or numbness that is NOT sustained	2	Tingling sensation in mouth
		Hypergeusia (increased taste sensation)
Negatively altered change in taste or numbness that is NOT sustained	13	Tongue sensitivity
		Taste of metal in mouth
		Dysgeusia while using device (metallic taste)
		Tingling on tongue
		Metallic taste while using the device
		Occasional hyposensitivity to taste after prolonged use
		Intermittent numbness in upper right dentition- canine and incisor
		Intermittent tingling sensation on tongue
		Increased sensitivity in teeth
		Increased tongue sensitivity
		Tongue stinging
		Mild sensitivity to teeth
Soreness of tongue		
Other event related to health or condition not included in above categories	10	Increased tongue awareness
		Headache
		Increased salivation
		Small erythematous area on hard palate of mouth
		Small 2-3mm irritation in ridge- midline of mouth
		Headaches
		Clicking on right side of jaw
		Clicking of jaw (more on right than left)
		Headaches after prolonged use of device, intermittent
Clicking of jaw bilaterally		

Note: Some study participants reported more than 1 event; each event is counted individually in the table above.

The IOD component of the BrainPort V100 device has also been evaluated in patients with balance disorders in another device (Wicab Balance). The device-related safety data reported for this device are presented below. The Balance device is indicated for use in patients with

balance disorders, and thus the reported adverse events may not be the same as those reported in the profoundly blind patients that were treated with the BrainPort V100 vision device. However, for a comprehensive evaluation of the device safety profile, all relevant available device-related safety data are presented in Table B (events reported during the clinical study of the Balance Device) below.

Table B: Device-Related Adverse Events Reported with the BrainPort Balance Device – Controlled Clinical Trial (n=148 Users)

Type of Event	Events	Number of Events
Oral Conditions	Tingling tongue	4
	Dysgeusia	3
	Tongue irritation	2
	Cheilitis	2
	Mouth ulcer	3
	Burning tongue	1
	Oral pain	1
Ear & Labyrinth Disorders	Vertigo	4
Accident, Injury, And Procedural Complications	Fall	3
	Ankle sprain	1
Nervous System Disorders	Migraine	1
	Headache	1
Gastrointestinal Disorders	Nausea	1
Psychiatric Disorders	Concentration deficit	1

User Assistance

If you need assistance setting up, using or maintaining the BrainPort V100, or to report unexpected operation or events, please contact Wicab, Inc. by mail, telephone, or e-mail:

North America

Wicab, Inc.

Attn: Customer Support

8313 Greenway Blvd.

Suite 100

Middleton, WI 53562 USA

Telephone: 1.608.829.4500

Fax: 1.608.829.4501

E-Mail: customersupportus@wicab.com

Internet: www.wicab.com



BrainPort is a trademark or registered trademark of Wicab, Inc. in the United States and other countries.



**Correct Disposal of This Product
(WEEE - Waste Electrical & Electronic Equipment)**

This marking on the product, accessories or literature indicates that the product and its electronic accessories should not be disposed of with other household waste at the end of their working life. To prevent possible harm to the environment or human health from uncontrolled waste disposal, please separate these items from other types of waste and recycle them responsibly to promote the sustainable reuse of material resources.

Household users should contact either the distributor where they purchased this product or their local government office for details of where and how they can take these items for environmentally safe recycling.

Copyright 2014, Wicab, Inc.

DR-001114 Rev D, January 2015