

Subject: UMC-A18Q7 User Manual

REV: 0.1

PAGE 1 OF 21

UMC-A18Q7 User Manual

The document contains proprietary information which is the property of **Wistron NeWeb Corporation** and is strictly confidential and shall not be disclosed to others in whole or in part, reproduced, copied, or used as basic for design, manufacturing or sale of apparatus without the written permission of **Wistron NeWeb Corporation**.

Subject: UMC-A18Q7 User Manual

REV: 0.1

PAGE 2 OF 21

Revision History

Issue Date	Version	Description
2016/09/06	0.1	Initial Issued

WNC Proprietary & Confidential

Contents

1. Introduction.....	4
2. Test Setup.....	5
2.1 Developing board	5
2.2 HW connection and power on sequence	7
2.3 Connectors and switches	9
2.4 The configuration by adjusting jumpers	10
3. Interfaces.....	11
3.1 UART port	11
3.2 Android ADB interface	13
3.3 Qualcomm HS-USB Diagnostics 9025 (COM port).....	14
3.4 Qualcomm HS-USB WWAN Adapter 9025	14
3.5 Qualcomm HS-USB Android Modem 9025.....	15
4. Federal Communication Commission Interference Statement.....	16
Appendix I.....	18

1. Introduction

This User Manual of A18Q7 module is to describe how to use the following sections for lab test by specific qualified engineers or technicians. Furthermore, this module is NOT intended for commercial use but designed as part of Smart Meter product and M2M devices which mainly provide 4G LTE WAN access capability.

FCC Interference Statement

This module complies with Part 15 of the FCC Rules. Operation is subject to the following two conditions: (1) This module may not cause harmful interference and (2) this module must accept any interference received, including interference that may cause undesired operation.

Radiation Exposure Statement

This module complies with FCC radiation exposure limits set forth for an uncontrolled environment. This module should be installed and operated with minimum distance of 20cm between radiator and human body.

Any changes or modifications not expressly approved by the party responsible for compliance could void the user's authority to operate the device.

2. Test Setup

2.1 Developing board

The location of A18Q7:

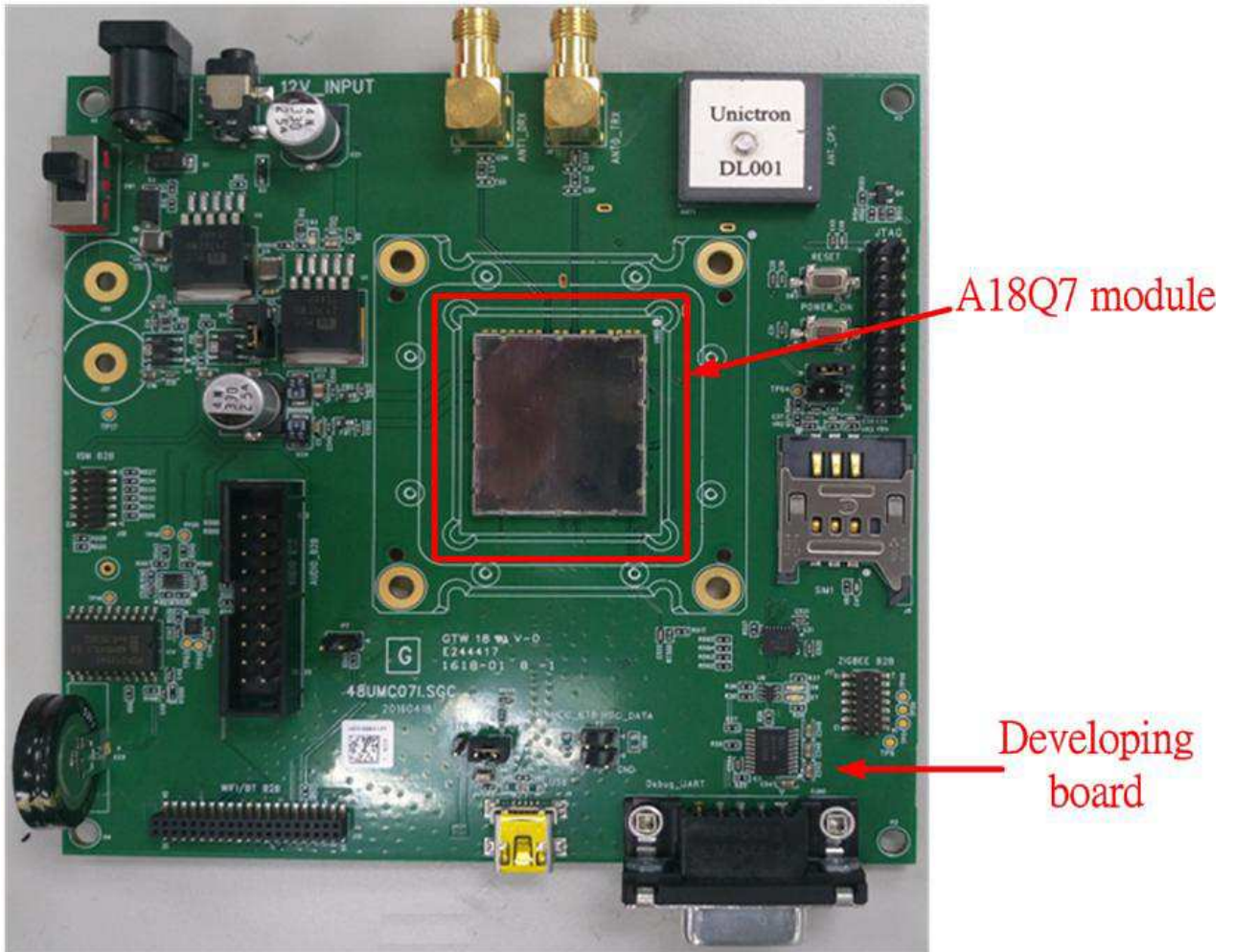

Top view:

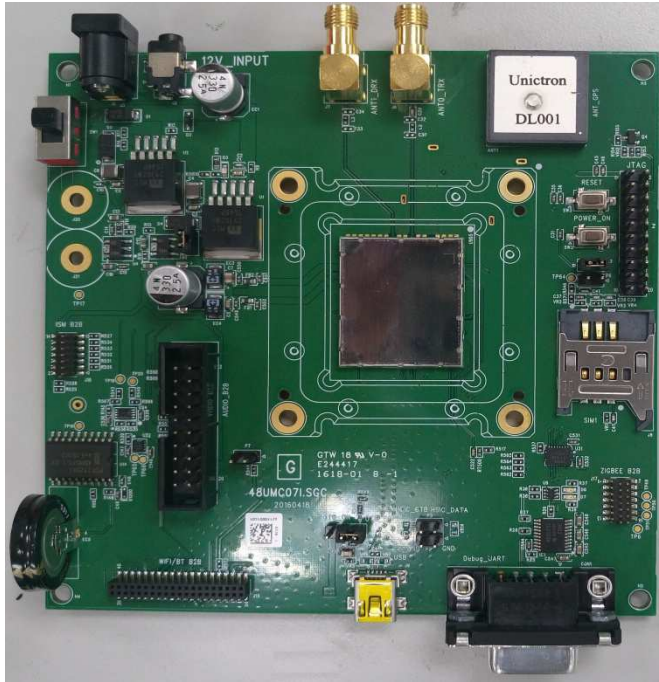

Bottom view:

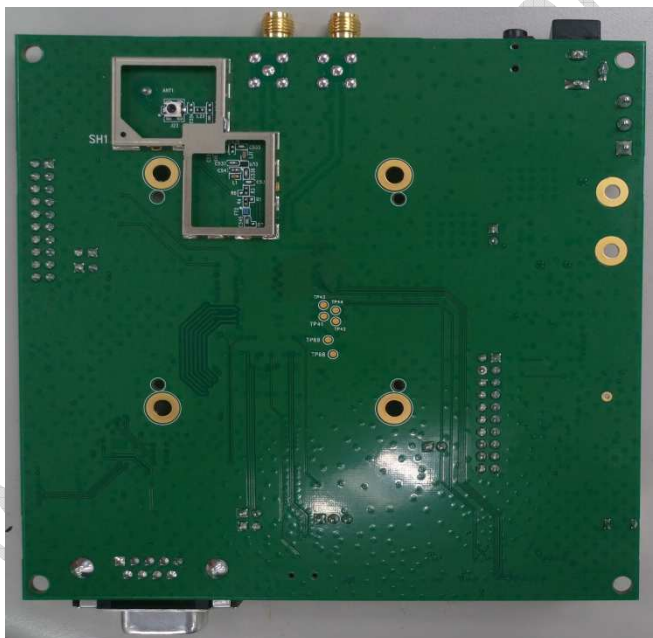

2.2 HW connection and power on sequence

Connection:

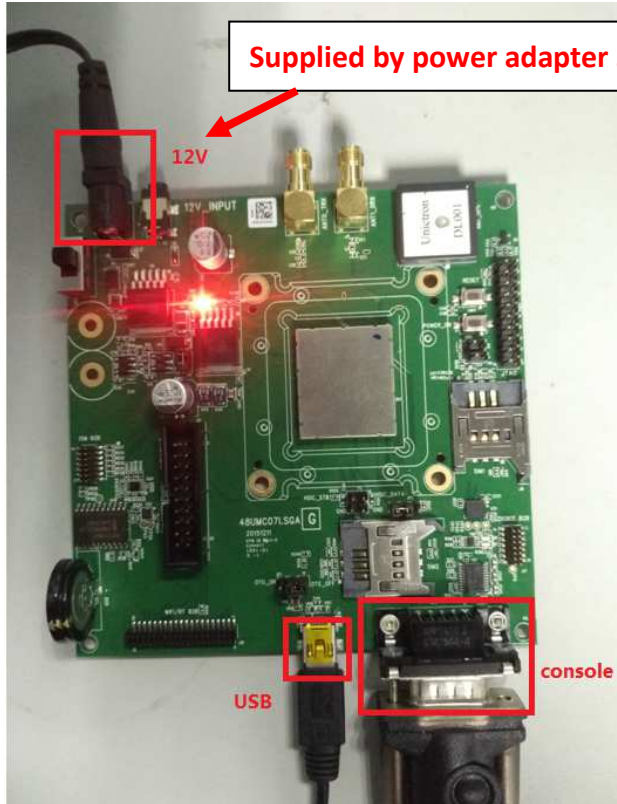

Procedures for powering on module:

Step1: Connecting DC12V/5V adapter to the DC jack and sliding the switch to the “ON state”



Step 2: Check if power LED lights on, which indicates external power supplies to the interface board

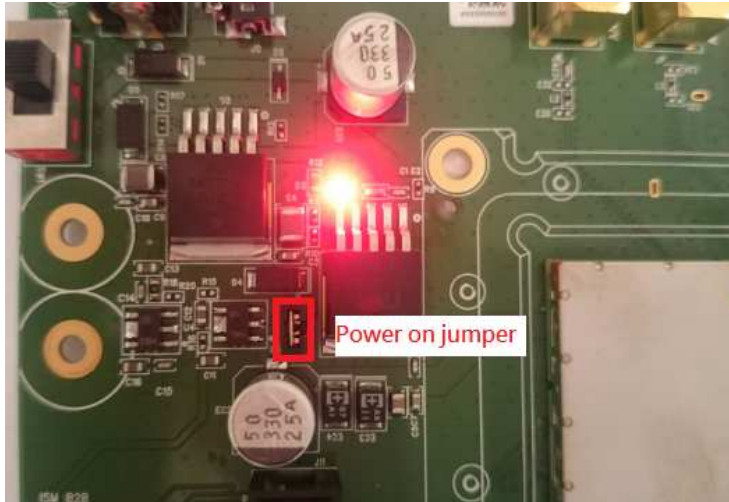

Step3: Press the button of power switch to enable module



2.3 Connectors and switches

The following pictures show the locations for all of connectors and switches.

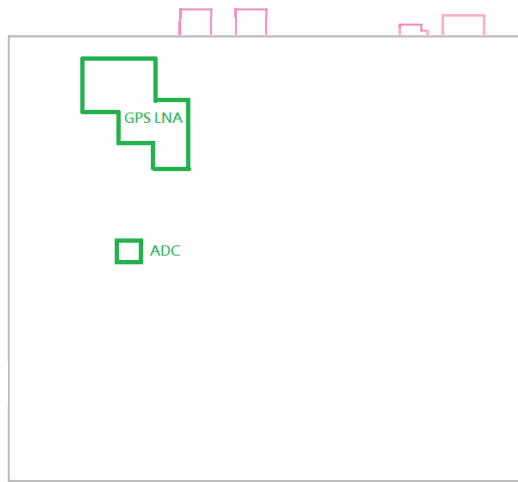
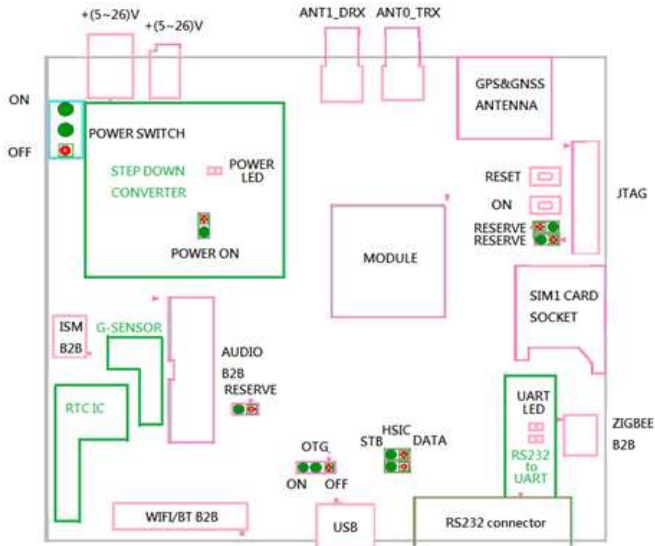

2.4 The configuration by adjusting jumpers

Below figure shows the location of each jumper on developing board. And the configurations for all of jumpers are addressed in below table. The testers can change it by their own according to different test conditions.

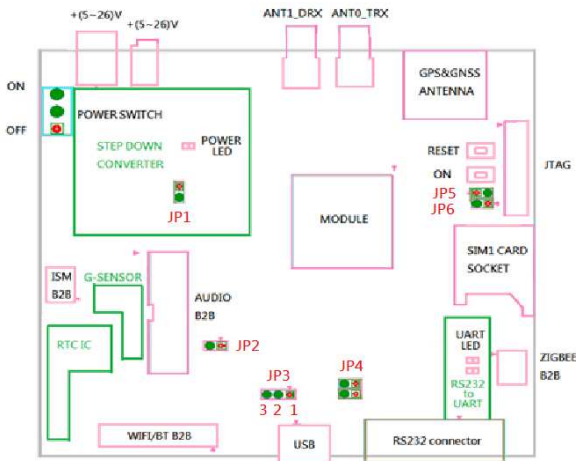

Jumper	Description	Comment
JP1	Module Power	Provide LTE module power when JP1 had connection.
JP2	Force_USB_BOOT	Force module into USB boot mode when JP2 had connection.
JP3	USB detection	Pin12: Enable USB detection, Pin23: Disable USB detection
JP4	HSIC	No used
JP5	Power on	LTE module automatic power on when JP5 had connection.
JP6	RESERVE	No used

3. Interfaces

This module offers following interfaces to communicate with module. Except UART console, before those USB emulated ports could be used, it requires to setup the Qualcomm's usb driver into your windows PC at first.

After driver installation is finished, device manager will show below USB emulated COM ports.

3.1 UART port

The UART port is Linux console port, where users could communicate with Linux via shell command. For current laptops, there is no external COM port connector. Recommend to use an usb-to-uart cable to connect with the UART port. Then it is required to install the corresponding driver in advance. After connecting with the cable, it should be able to see the COM port in device manager. For example, COM18 is found for usb-to-uart com port in Windows Device Manager in below figure.



Any terminal emulated tool can be used to communicate with Linux via this port. Putty is an open source terminal emulator to be an example in following figure.

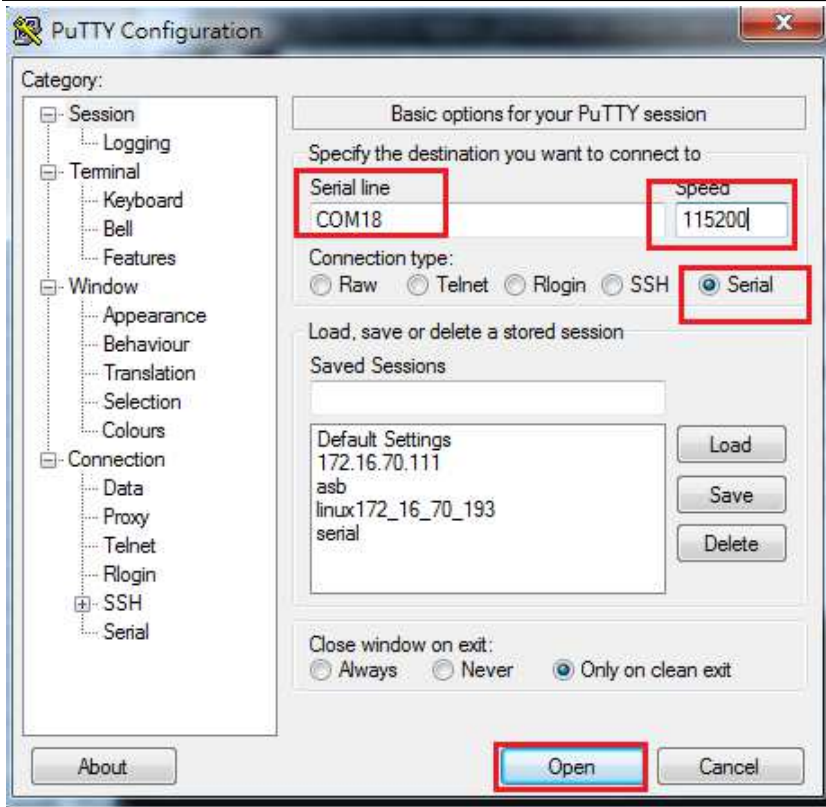

After simply configuring speed 115200, terminal will show login prompt. Default login account and password is shown in below figure.

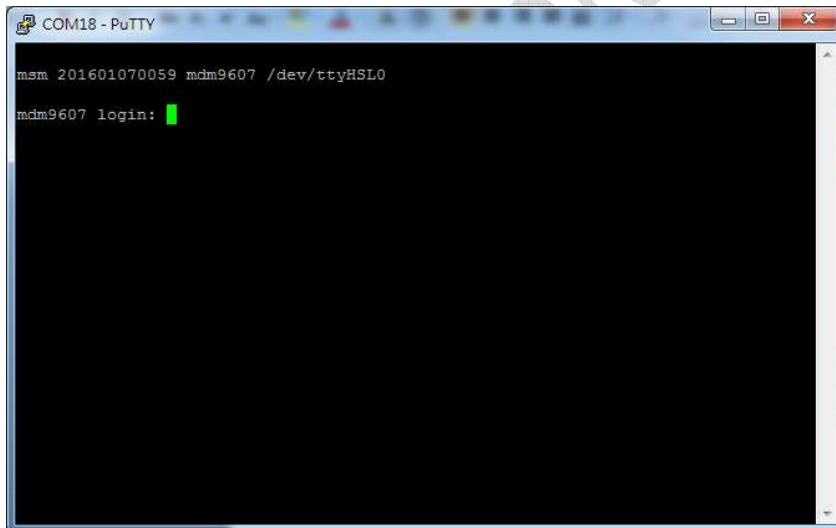

Input Login/Password as root/oelinux123.

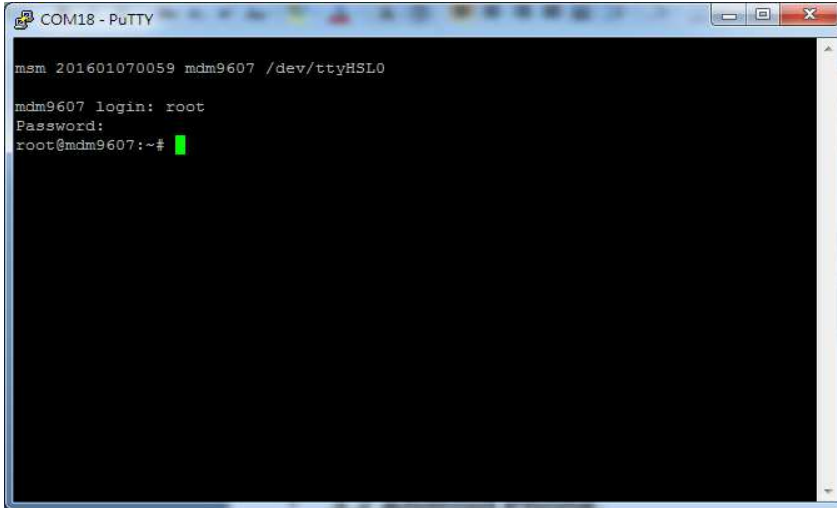

3.2 Android ADB interface

If USB driver is installed successfully, the interface is available as below figure. The functionalities of this interface like UART port.



It's required to install Android USB driver on PC/Windows to use adb tool. Adb tool provides an easy way for PC side to push Linux applications to run over the module. Command "adb devices" is often the first command to detect if any module connected with the adb link. And command "adb shell" could start a Linux shell to operate on module's Linux system. Please refer to following figure.

```
D:\project\adb_cmd>adb devices
List of devices attached
123eaa device

D:\project\adb_cmd>adb shell
/# ls -al
ls -al
total 16
drwxr-xr-x 23 root root 1984 Jan 6 00:35 +[1;34m.+[0m
drwxr-xr-x 23 root root 1984 Jan 6 00:35 +[1;34m.+[0m
-rw----- 1 root root 437 Jan 6 04:28 +[0;0m.ash_history+[0m
-rw----- 1 root root 1024 Jan 1 1970 +[0;0m.rnd+[0m
drwxrwx--- 3 www-data www-data 224 Jan 6 2016 +[1;34mWEBSERVER+[0m
drwxr-xr-x 2 root root 15736 Jan 7 2016 +[1;34mbin+[0m
drwxr-xr-x 2 root root 160 Jan 6 2016 +[1;34mboot+[0m
```

3.3 Qualcomm HS-USB Diagnostics 9025 (COM port)

This port is created for modem debugging purpose and used by Qualcomm PC tools to communicate with the module. Qualcomm’s tool is protected by Qualcomm License.



3.4 Qualcomm HS-USB WWAN Adapter 9025

This port is created as a virtual network interface which could be used by PC to connect with Internet.



3.5 Qualcomm HS-USB Android Modem 9025

This port is also called as modem port. Users could use PC terminal tool to connect with the port and send AT commands to control modem directly.

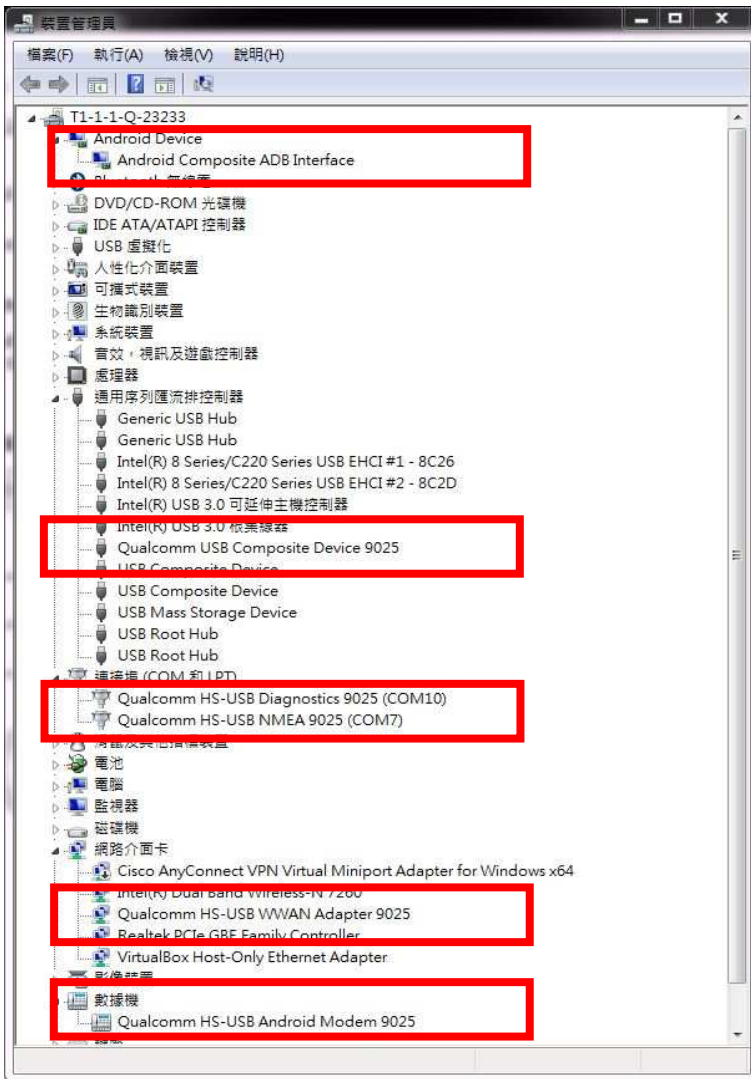

4. Federal Communication Commission Interference

Statement

This device complies with Part 15 of the FCC Rules. Operation is subject to the following two conditions: (1) This device may not cause harmful interference, and (2) this device must accept any interference received, including interference that may cause undesired operation.

This equipment has been tested and found to comply with the limits for a Class B digital device, pursuant to Part 15 of the FCC Rules. These limits are designed to provide reasonable protection against harmful interference in a residential installation. This equipment generates, uses and can radiate radio frequency energy and, if not installed and used in accordance with the instructions, may cause harmful interference to radio communications. However, there is no guarantee that interference will not occur in a particular installation. If this equipment does cause harmful interference to radio or television reception, which can be determined by turning the equipment off and on, the user is encouraged to try to correct the interference by one of the following measures:

- Reorient or relocate the receiving antenna.
- Increase the separation between the equipment and receiver.
- Connect the equipment into an outlet on a circuit different from that to which the receiver is connected.
- Consult the dealer or an experienced radio technician for help.

FCC Caution:

- Any changes or modifications not expressly approved by the party responsible for compliance could void the user's authority to operate this equipment.
- This transmitter must not be co-located or operating in conjunction with any other antenna or transmitter.

Subject: UMC-A18Q7 User Manual

REV: 0.1

PAGE 17 OF 21

Radiation Exposure Statement:

This equipment complies with FCC radiation exposure limits set forth for an uncontrolled environment. This equipment should be installed and operated with minimum distance 20cm between the radiator & your body.

This device is intended only for OEM integrators under the following conditions:

- 1) The antenna must be installed such that 20 cm is maintained between the antenna and users, and the maximum antenna gain allowed for use with this device is +2.0 dBi.
- 2) The transmitter module may not be co-located with any other transmitter or antenna.

As long as 2 conditions above are met, further transmitter test will not be required. However, the OEM integrator is still responsible for testing their end-product for any additional compliance requirements required with this module installed.

IMPORTANT NOTE:

In the event that these conditions cannot be met (for example certain laptop configurations or co-location with another transmitter), then the FCC authorization is no longer considered valid and the FCC ID cannot be used on the final product. In these circumstances, the OEM integrator will be responsible for re-evaluating the end product (including the transmitter) and obtaining a separate FCC authorization.

End Product Labeling:

This transmitter module is authorized only for use in device where the antenna may be installed such that 20 cm may be maintained between the antenna and users. The final end product must be labeled in a visible area with the following: "Contains FCC ID: NKR-LMA18Q7. The grantee's FCC ID can be used only when all FCC compliance requirements are met.

Manual Information To the End User:

The OEM integrator has to be aware not to provide information to the end user regarding how to install or remove this RF module in the user's manual of the end product which integrates this module. The end user manual shall include all required regulatory information/warning as show in this manual.

Appendix I

Environmental Setup

1. Windows 7 x64

The environment setup was tested on Windows 7 x64 successfully.

2. Install Android SDK for adb, fastboot and USB driver

To install the Android SDK platform and USB driver components on a Windows machine:

- Go to <http://developer.android.com/sdk/win-usb.html>.
- Follow the instructions for installing the SDK and USB driver.
- Right-click My Computer, select Properties > Advanced > Environment Variables, and set the path to include the "C:\Program Files (x86)\Android\android-sdk\platform-tools" if you installed Android SDK by using default path.
- Now the "Windows Devices Managers" looks like the below because there is no QTI device VPD/PID in default installed USB driver.

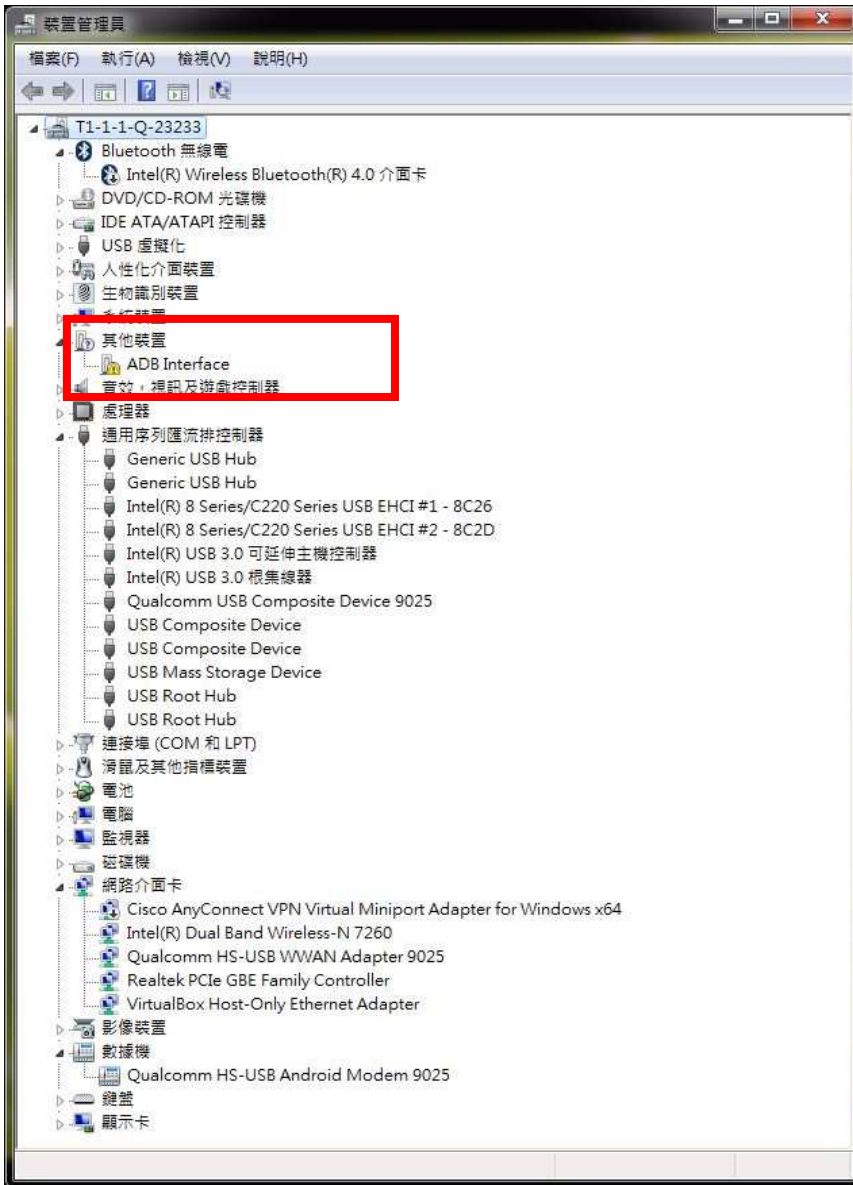

- Modify C:\Program Files (x86)\Android\android-sdk\extras\google\usb_driver\android_winusb.inf
 - _winusb.inf
 - [Google.NTx86]
 - ;Qualcomm FFA
 - %SingleAdbInterface% = USB_Install, USB\VID_05C6&PID_9025
 - %CompositeAdbInterface% = USB_Install, USB\VID_05C6&PID_9025&MI_01
 - %SingleBootLoaderInterface% = USB_Install, USB\VID_18D1&PID_D00D

[Google.NTamd64]

;Qualcomm FFA

%SingleAdbInterface% = USB_Install, USB\VID_05C6&PID_9025

%CompositeAdbInterface% = USB_Install, USB\VID_05C6&PID_9025&MI_01

%SingleBootLoaderInterface% = USB_Install, USB\VID_18D1&PID_D00D

In addition, make sure that there are matching entries under the [Strings] section:

[Strings]

SingleAdbInterface = "Android ADB Interface"

CompositeAdbInterface = "Android Composite ADB Interface"

SingleBootLoaderInterface = "Android Bootloader Interface"

- Create a %USERPROFILE%\android directory if it does not exist
Create/edit the adb_usb.ini file as below contexts
ANDROID 3RD PARTY USB VENDOR ID LIST -- DO NOT EDIT.
USE 'android update adb' TO GENERATE.
1 USB VENDOR ID PER LINE.
0x05C6
- Then open "Windows Device Manager" and click right-button on "ADB Interface" and then toggle "Upgrade driver". Then "Refresh driver" will pop up and installation procedure is shown on following pictures.



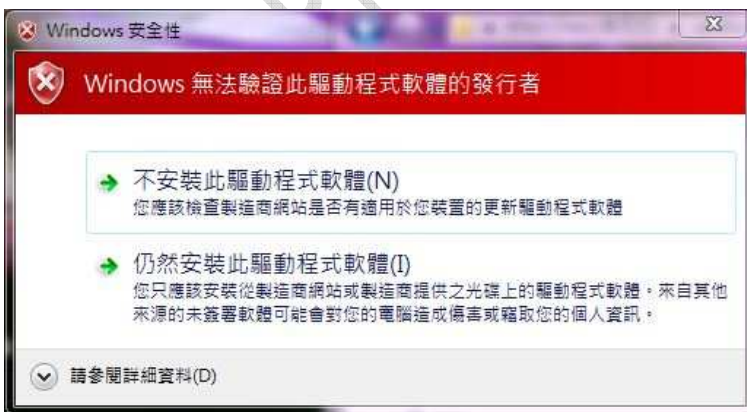
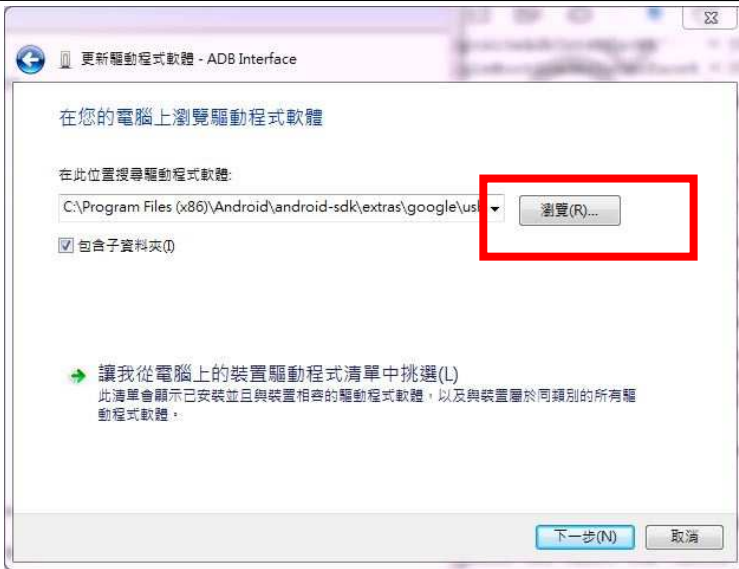

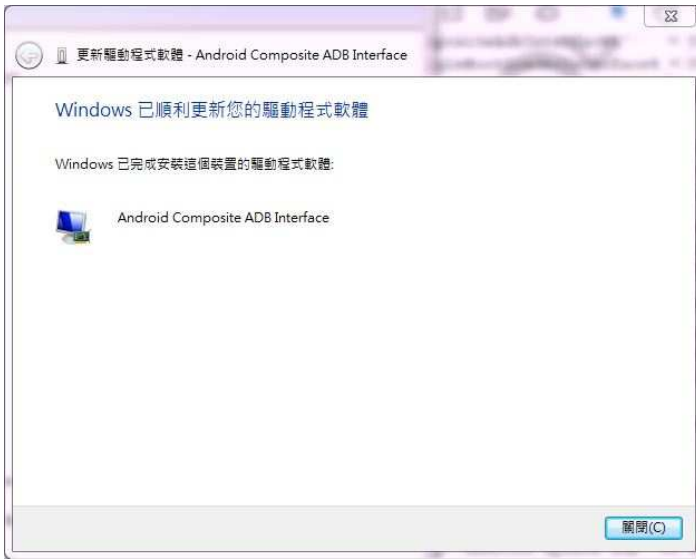

3. USB driver

QUD.WIN.1.1 Installer-10037.3 will be needed to be installed for the following ports:

- Qualcomm HS-USB Android DIAG
- Qualcomm HS-USB Android Modem
- Qualcomm HS-USB Android GPS (NMEA)
- Qualcomm Wireless HS-USB Ethernet Adapter on a Windows 7 OS