



# STREAMER lite

SIR-SL1 Satellite Radio Receiver User Guide





**CONGRATULATIONS!** Your new Streamer Lite™ SIR-SL1 portable Plug-n-Play Receiver kit lets you enjoy SIRIUS® Satellite Radio's digital entertainment on the road or at home. (Home use requires the Home Docking Kit sold separately.) Use this manual to familiarize yourself with all of Streamer Lite's features and capabilities. For the latest information about this and other Sirius products, visit [www.sirius.com](http://www.sirius.com)

### Table of Contents

Box Contents .....	3	Menu Display Options .....	19
Safety Precautions .....	3	Sirius ID .....	20
Receiver Controls and Features .....	6	Favorite Team .....	20
Remote Control .....	7	Jump Settings .....	21
Activating your SIRIUS Subscription .....	8	Display Settings .....	22
Basic Operation .....	9	Confirm Tone Options .....	23
Changing Channels .....	9	FM Transmitter .....	23
Display Button .....	9	Channel Add or Skip .....	24
Search Modes (Category, Channel, Artist, Song) ..	10	Lock Options .....	24
Direct Tuning .....	11	Audio Level .....	25
Setting Channel Presets .....	12	Antenna Aiming .....	26
Recalling Channel Presets .....	12	Memory Options .....	26
Jump Preset Button .....	12	Time-Based Features .....	27
Searching for a Channel Preset (P.TUNE Mode) ...	13	Factory Default .....	29
Preset Tune List Mode .....	14	Troubleshooting .....	31
Memory (MEMO) and SongSeek (S-Seek) Functions	15	Specifications .....	32
Game Alert .....	19	Optional Accessories .....	34
		Warranty .....	36

# STREAMER lite

## Box Contents

Unpack your Streamer Lite carefully and make sure that everything listed here is present:

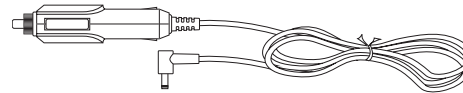
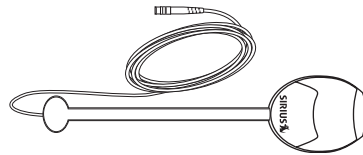
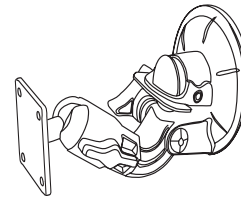
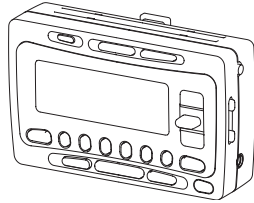

If anything is missing or damaged, or if your Streamer Lite Receiver fails to operate, notify your dealer immediately. It is recommended that you retain the original carton and packing materials in case you need to ship your Receiver in the future.

This device complies with Part 15 of the FCC Rules. Operation is subject to the following two conditions: (1) This device may not cause harmful interference, and (2) this device must accept any interference received, including interference that may cause undesired operation.

FCC Caution: Any changes or modifications not expressly approved by the party responsible for compliance could void the user's authority to operate this equipment.

This transmitter must not be co-located or operating in conjunction with any other antenna or transmitter.

---

## Safety Precautions

### **Warning**

Take the following precautions to prevent traffic accidents and avoid personal injury:

- Installation must be performed according to this user guide. Sirius Satellite Radio is not responsible for issues arising from installations not performed according to the procedures in this manual.
- Do not install the unit where it may obstruct your view through the windshield or of your vehicle's indicator displays.
- Do not install the unit where it may hinder the function of safety devices such as an airbag. Doing so may prevent the airbag from functioning properly in the event of an accident.
- The installation and use suggestions contained in this manual are subject to any restrictions or limitations that may be imposed by applicable law—the purchaser should check applicable law for any restrictions or limitations before installing and/or operating this unit.
- Failure to follow these safety instructions and warnings may result in a serious accident.

### **Warning**

Take the following precautions to prevent fire and avoid personal injury:

- To avoid short circuits, never put or leave any metallic objects (coins, tools, etc.) inside the unit.
- If the unit emits smoke or unusual odors, turn the power off immediately and consult your retailer.
- Do not drop the unit or subject it to strong shocks.
- If the LCD display becomes damaged or broken, do not touch the liquid crystal fluid. The fluid can be dangerous to your health. If the liquid crystal fluid contacts your body or clothing, immediately wash it off with soap and water.

### **Caution**

Take the following precautions to keep the unit in proper working order:

- Be sure the unit is connected to a 12V DC power supply with a negative ground connection.
- Do not open the unit.
- Do not install the unit where it will be exposed to high levels of humidity, moisture, or dust.

- When replacing a fuse, use only a new one with the proper rating. Using a fuse with the wrong rating may cause the unit to malfunction.
- To prevent a short circuit when replacing a fuse, first disconnect the wiring harness.

#### Note

If the unit doesn't seem to be working properly:

- Turn the unit's power off, wait 5 – 10 seconds, then turn the power on again.
- If the unit still malfunctions, turn the unit's power off, remove it from the cradle, wait 5 – 10 seconds, replace it in the cradle and turn the power back on. If the problem persists, consult your Sirius Sportster retailer.

#### FCC Warning

This equipment may generate or use radio frequency energy. Changes or modifications to this equipment may cause harmful interference unless the modifications are expressly approved in this User Guide. The user could lose the authority to operate this equipment if an unauthorized change or modification is made.

#### Note

This equipment has been tested and found to comply with Part 15 of the FCC Rules. These rules are designed to provide reasonable protection against harmful interference. This equipment may cause harmful interference to radio communications if it is not installed and used in accordance with these instructions. However, there is no guarantee that interference will not occur in a particular installation. If this equipment does cause harmful interference to radio or television reception, which can be determined by turning the equipment off and on, the user is encouraged to try to correct the interference by one of more of the following measures:

- Reorient or relocate the receiving antenna.
- Increase the separation between the equipment and Streamer Lite Receiver.
- Connect the equipment into an outlet on a circuit different from that to which the Streamer Lite Receiver is connected
- Consult the dealer or an experienced radio/TV technician for help.

### Cleaning the Unit

If the unit becomes dirty, turn its power off and wipe it clean with a soft dry cloth. Do not use hard cloths or paint thinner, alcohol, or other volatile solvents to clean the unit. These may cause damage or remove indicator characters.

#### **Warning**

Do not operate the unit in a way that might divert your attention from driving safely. As a driver, you alone are responsible for safely operating your vehicle in accordance with traffic safety laws at all times.

### Receiver Controls and Features

1. **POWER Button**  : Turns Receiver On and Off.
2. **Channel Switch & Select Button**: Navigates through channels & display screens and makes selections of items highlighted on the display. Pressing up increases or moves up in the menus. Pressing down decreases or moves down in the menus. Pressing in duplicates the function of the Select button.
3. **CATEGORY Buttons**: Navigates through Category List Screen which displays Sirius Channel Categories.
4. **Display Button**: Changes text size of artist names and song titles.
5. **Menu Button**: Used to access menu options to make setup and feature changes.
6. **Select Button**: Selects an option on the screen.
7. **Preset Number Buttons (0-6)**: Sets and selects preset channels.
8. **Memory (MEMO) Button (S-Seek Function)**: Saves and recalls artist names and song titles. You can store up to 20 artist/song title combinations.

# STREAMER lite

- 9. Band Button (P.Tune):** Pressing and releasing switches between preset banks A, B, and C, which hold 10 presets each. Pressing and holding enables “Preset Tune Mode”, which allows for viewing and listening of stored presets with turn of Rotary Knob.
- 10.Remote Control Receiver:** Receives signals from the included wireless remote control.
- 11.DC 12V:** Input jack for cigarette lighter adapter or 12V DC power supply.
- 12.FM Out:** FM Output for use with wired FM switch box accessory (sold separately).
- 13.ANT:** Input jack for Sirius antenna.
- 14.VOL:** Volume control for line out jack.
- 15.AUDIO:** Audio line out or headphone jack.

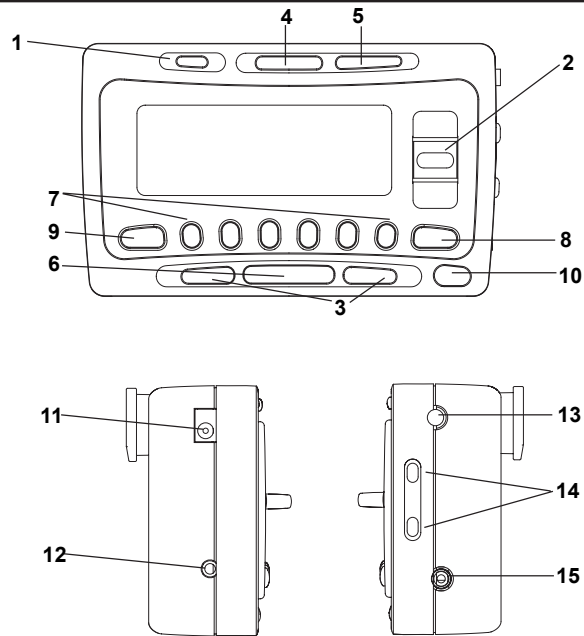



### Remote Control

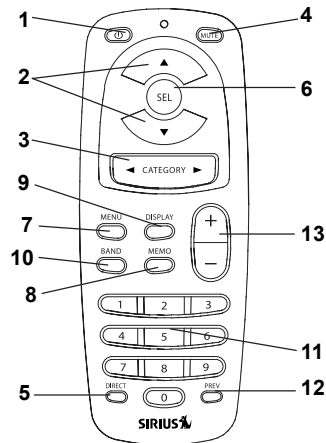

1. **POWER Button** (⏻) : Turns Receiver ON and OFF.
2. **Channel Buttons**: Navigate through channels and display screens.
3. **Category Buttons**: Navigate through categories and display screens.
4. **Mute Button**: Mutes audio.
5. **DIRECT Button**: Accesses channels directly by number.
6. **SELECT (SEL) Button**: Selects items highlighted on the display; hold-down to jump to the previously-received Channel.
7. **MENU Button**: Enters and exits the Setup Mode.
8. **MEMORY (MEMO) Button**: Saves & recalls song & artist information; sets Parental Lock code number.
9. **DISPLAY Button**: Changes text size of artist names and song titles.
10. **BAND Button**: Switches between preset bands A, B, and C.
11. **Number Buttons (0-9)**: Select channels directly and by preset.
12. **Previous Button**: Tunes to the last tuned channel.
13. **VOL+ / VOL- Buttons**: Adjust the volume up & down.

### Installing Batteries in the Remote

1. Remove the battery cover.
2. Install CR2025 battery. (+ side is up)
3. Replace the battery cover.

## Activating your SIRIUS Subscription

Before you can listen to the Receiver, you must subscribe to SIRIUS Satellite Radio's service.

1. Make sure that the Streamer Lite Receiver is properly connected and that its antenna is oriented to receive the SIRIUS satellite signal.
2. Press the power button to turn the Receiver ON. After displaying the SIRIUS logo, the Receiver will update all the SIRIUS channels. The display will read "UPDATING CHANNELS" on the top line and "X% Completed" (0%-20%-40%-60%-80%-100%) on the bottom line until the update completes.

**NOTE: Don't push any buttons or perform any operations until updating has been completed.**

Once updated and the SIRIUS channels are received, the display will change to "Call 1-888-539-SIRIUS to Subscribe" and will place you in SIRIUS Satellite Radio's Preview Channel. Channel 184 is the SIRIUS preview channel. You will not be able to tune to any other channels until you activate your SIRIUS subscription.

4. Press the MENU button to enter the "Menu Options" mode. The "Sirius ID" menu option will now be highlighted.
5. Push the Select button to select "Sirius ID". This will display your unit's unique 12-digit SIRIUS ID Number. This SID number should also be available on the Streamer Lite Receiver packaging. Write the number down and have your credit card handy. A space has been provided at the end of this manual to write your SID.



6. Contact SIRIUS on the Internet: <https://activate.siriusradio.com/> Follow the prompts to activate your subscription. You can also call SIRIUS toll-free at 1-888-539-SIRIUS (1-888-539-7474).

### Basic Operation

After you have successfully activated your SIRIUS subscription, the Normal Operation (Default ) screen will appear (*Below*): Use the Channel Switch to select channels.

- The selected channel will automatically start playing. The name and artist of the currently playing song will scroll across the display.

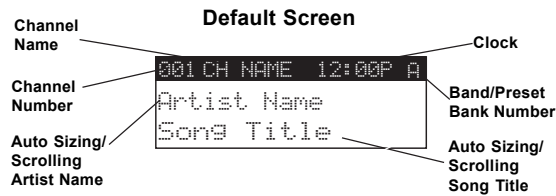

### Display Button

Pressing the DISPLAY button from the Default display toggles the top line of the display between the channel name & time and the category & date.



Pressing and holding the DISPLAY button for 3 seconds will enter Channel List mode, described in the next section.

### Changing Channels

Pressing the Channel Switch up will increase or move up to the next channel. Pressing the Channel Switch down will decrease or move to the previous channel.

## Search Modes (Category, Channel, Artist, Song Title)

The Streamer Lite Receiver has several ways to search for and select music: by channel, by category, by artist and by song title.

### Searching Channels

If you want to find a different channel to listen to, press and hold the DISPLAY button to enter Channel List mode:

1. Use the CATEGORY buttons to scroll through music and entertainment categories.
2. Use the Channel Switch to scroll through the available channels in each category.
3. When the channel you want is highlighted, press SELECT to tune to it. The channel will change and the display will revert to the Default screen for the new channel.
  - Pressing the DISPLAY button while in the Channel List Mode will change between Channel Name, Artist Name and Song Title to preview what is playing on other channels before selecting.

To exit this mode without changing to a new channel, press and hold the DISPLAY button for 1 second.



Press one of the CATEGORY buttons to activate the category list.



Press DISPLAY to show the Artist Name



Press DISPLAY again to show the Song Title

**Note:** If you are viewing a sports category channel list (NFL Zone, NHL Zone), pressing the DISPLAY button will toggle between the team names and the current score of any live play-by-play game.

### Direct Tuning (Remote Control Only)

Channels can be directly accessed by pressing the DIRECT button on the remote control and then using the 0-9 keys to enter the desired channel number. Once the desired number has been entered, the channel will change and the display will revert to the Default screen for the new channel. The receiver will change immediately if three numbers are entered (ex. "0", "0", "7"), but if just one or two digits are entered, the unit will wait for 3 seconds before changing the channel.



### Setting Channel Presets

You can store up to 30 of your favorite channels as presets, for quick access. Presets are stored in 5 banks, each containing 6 channel presets.

1. Press the BAND button to activate the preset bank you want. The selected bank is shown in the top right corner of the Default screen.
2. Select the channel you want to preset (see *Basic Operation* and *Changing Channels* section).
3. Hold the numbered preset button you want to store the channel in for at least 2 seconds.
  - You will hear a beep and "Preset Stored" will flash to indicate that the channel has been memorized.
  - If the preset button already has a channel stored in it, it will be replaced by the new channel.

### Recalling Channel Presets

The 6 presets in the active bank (A - E) can be selected by pressing the "0" - "6" buttons.

1. Press the BAND button to activate the preset bank you want. The selected bank is shown in the top right corner of the Default screen.
2. Press the desired preset button to recall the preset. The channel will change and the display will revert to the Default screen for the new channel.

## Searching for a Channel Preset (P.TUNE Mode)

It is possible to quickly search through all of your presets using the Channel Switch.

1. Press and hold the BAND button to enter the Preset Tune Mode (P.TUNE).
2. The top corners of the display will invert to indicate Preset Tune Mode.
3. Use the Channel Switch to move up or down through your presets. Only channels stored in your presets will be displayed, regardless of which bank they are stored in.
  - Presets will be grouped and displayed by preset bank and number (ex. A-1, A-2...B-1, B-2) and rotate back to the beginning.

```
001 CH NAME 12:00P A
Artist Name
Song Title
```

Default Display

```
001 CH NAME 12:00P A
Artist Name
Song Title
```

P.TUNE Display

To exit Preset Tune Mode and return to Channel Tuning Mode, press and hold the BAND button.

## Preset Tune List Mode

In Preset Tuning Mode you can view your list of presets showing Channel Name, Artist Name, or Song Title just like in the Channel List Mode:

1. Press and hold the BAND button to enter the Preset Tune Mode (P.TUNE).
2. Press the DISP button for 2-seconds which will bring up the Preset Tune List Mode displaying up to 3 preset channel names.
  - Pressing the DISP button while in this mode will change between Channel Name, Artist Name and Song Title list modes.
  - The name field will scroll only if the length of the artist or song title cannot be viewed in its entirety.
3. Use the Channel Switch to select the desired preset.
4. Push SELECT to select the channel. The channel will change and the display will revert to the P.TUNE Display.

```
001 CH NAME 12:00P A
Preset Tuning Mode
```

```
A-1 CH Name
A-2 CH Name
A-3 CH Name
```

**P.TUNE  
Channel Name  
List Display**

```
A-1 Artist Name
A-2 Artist Name
A-3 Artist Name
```

**P.TUNE Artist  
Name List  
Display**

```
A-1 Song Title
A-2 Song Title
A-3 Song Title
```

**P.TUNE Song  
Title List  
Display**

### Memory (MEMO) and Song Seek (S-Seek) Functions:

This feature allows the user to capture and store information about the programming (Artist/Song, sports team or traffic city) on the currently tuned channel, up to a total of 10 listings. The unit also has the capability to continuously search all incoming Sirius channels and alert the user when a saved program is being played.

#### Storing Song Titles

1. While the Receiver is in the Default display mode, momentarily pressing and releasing the MEMO button stores the current program data information within the Receiver's memory. A memory "**Stored**" pop-up screen, followed by "**X Used/Y Empty**" will each appear for 1 second (below).

```
001 CH NAME 12:00P A
  Stored
```

```
001 CH NAME 12:00P A
 X Used/Y Empty
```

If the current tuned channel is an NFL play-by-play sports broadcast, pressing the MEMO button will allow you to select one of the teams playing to be stored in memory. In the future, as long as your receiver is turned on, you will be alerted when your team is playing in a game being broadcast.

If the current tuned channel is a non-NFL sports play-by-play broadcast, pressing the MEMO button will store the name of both teams and you will only be alerted when these same teams are playing each other.

2. If the MEMO button is pressed and all of the memory spaces are full, **Memory Full** will flash on the display for 1 second, followed by a pop-up screen presenting the **Replace-Cancel** options.

This prompt allows you to make the following Replace/Cancel choices:

- By selecting **Replace**, the memory list will appear, and you can use the Channel Switch to select the data that you would like to overwrite with the new Artist/Song Title. After highlighting the selected title in the list, press SELECT to delete the stored Artist/Song Title and replace it with the updated information. The display will show the "Stored" screen.
- By selecting **Cancel**, the prompt screen will disappear and revert to the original screen. Nothing will be stored.

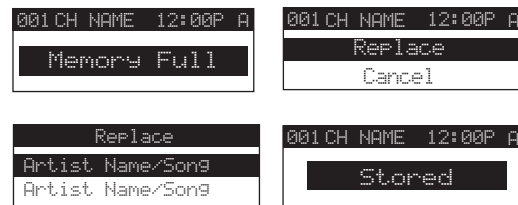



### Viewing Program Information stored in Memory

1. Press and hold the MEMO button for 3 seconds to enter S-Seek Mode. The program information stored in memory will be displayed one-at-a-time in page format.
2. Use the Channel Switch to scroll through the listings. This function allows you to review previously stored program information.
2. Use the Channel Switch to highlight the "Delete" option.
3. Press SELECT and a Delete confirmation screen will appear.
4. To permanently delete the program from your list, select "Yes" using the Channel Switch and press SELECT to confirm.



Memory S X/V  
Artist Name  
Song Title



Delete  
Yes  
No

### Deleting a Song Title Stored into Memory

1. Press SELECT while in S-Seek Mode. A pop-up screen displaying two selectable options - "Delete" and "S-Seek" - is displayed.



Memory Recall  
Delete  
S-Seek

## Activating the Song (S-Seek) Alert

1. Press and hold the MEMO button for 3 seconds to enter the S-Seek Mode.
2. Press and release SELECT. A pop-up screen displaying two selectable options - “Delete” and “S-Seek” will appear (below left).
3. Use the Channel Switch to highlight the “S-Seek” option.
4. Press and release SELECT and an S-Seek confirmation screen will appear. Select the “Yes” option using the Channel Switch and press SELECT to confirm (below right).



Whenever the Streamer Lite Receiver is turned on, it automatically searches the incoming channels to determine if a match exists with the program information stored in receiver’s memory. If one or more matches are found, a pop-up screen momentarily appears for 2-seconds and displays “S-Seek Alert”. An audible beep tone will be

heard indicating that a match has been found. The display then reverts to the S-Seek Alert screen which displays the current matches. You can now select the Artist/Song Title or game that you wish to listen to. No stored match alert is provided for the currently selected channel. To ensure that no duplicate entries are stored in memory, the Receiver will check the stored input data to ensure the information about to be stored is not already in memory.

- If one or more matches are found, a list appears. You can scroll through the list and select a program using the Channel Switch. Your selection will be tuned and the display will revert to the last active display mode.
- If a selection is not chosen within 10 seconds, the screen will revert to the last active display and tuning modes.

**NOTE:** Play of the current selection will continue until a new selection is made.

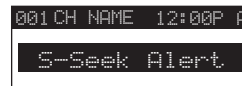



### Menu Display Options

To enter the Menu Options page, press and release the MENU Button. The “**Menu Options**” list will appear on the display (*below*).

Using the Channel Switch, highlight the option you wish to adjust and press SELECT. The following options are available:

- |                      |                 |
|----------------------|-----------------|
| Sirius ID            | Lock Options    |
| Audio Level          | Antenna Aiming  |
| Display Settings     | Memory Options  |
| Confirm Tone Options | Time Features   |
| FM Transmitter       | Factory Default |
| Channel Add/Skip     |                 |



### Sirius ID

Displays your 12 digit Sirius ID (SID) number. The SID is unique to every Streamer Lite Receiver and is required to activate your service. It is recommended that you write this number in the space provided on the last page of this user guide. No adjustments are allowed in this mode. To exit this option, press the SELECT or Menu Button.



**Note:** If a button is not pressed within 10 seconds, the Receiver will exit the “**Menu Options**” function and revert back to the Default screen display.

## Display Settings

It is possible to adjust the Brightness and Contrast of the Receiver's display. While in the "Menu Options" list perform the following steps:

1. Use the Channel Switch to highlight the "Display Settings" option. Press SELECT to select.
2. Select one of the following using the Channel Switch:
  - a. **Contrast Control:** Adjusts the relationship between the background and the text on the LCD display. Use the Channel Switch to adjust the contrast up or down. The bar graph at the bottom of the screen will move to indicate the change.



- b. **Brightness Control:** Adjusts the overall intensity of the display to help with viewing in different lighting conditions. Use the Channel Switch to adjust brightness up or down. The bar graph at the bottom of the screen will move to indicate the change.

To exit the Display settings, simply push the MENU button.

## Confirm Tone Options

The Streamer Lite Receiver will sound an Audio "Tone" alert when the unit powers ON and OFF as well as when the S-Seek Alert is activated. The default is ON. To change the tone options, perform the following:

1. From the Menu, use the Channel Switch to highlight the "Confirm Tone Options". Press SELECT.
2. Use the Channel Switch to Select "ON" or "OFF". Press SELECT to set the Tone Option.

To exit , push the MENU button.

### FM Transmitter Options

If you would like to use the built-in FM Transmitter, you must turn ON the function and select an FM frequency:

1. Use the Channel Switch to highlight “**FM Transmitter**”. Press SELECT.
2. Use the Channel Switch to select “**FM On/Off**”. Press SELECT.
3. Use the Channel Switch to select “On”. Press SELECT.
4. Use the Channel Switch to highlight the “**Frequency**”. Press SELECT.
5. Use the Channel Switch and Category Buttons to adjust the FM frequency. The Channel Switch adjusts in 0.1 MHz increments and the Category Buttons adjust in 1 MHz

```

Frequency
94.1 MHz
  
```

### Lock Options

The Streamer Lite Receiver has the ability to lockout the use of any channels you do not want others to access without your permission. Like the Skip feature, the locked channel will not appear when the user changes channels with the Channel Switch. When the user tries to access a locked channel using the Direct Tuning function, the “Enter Code” screen will be displayed and the channel will not be accessed until the proper code is entered.

While in the “**Menu Options**” List mode, follow the steps below to Lock a channel:

1. Use the Channel Switch to highlight the “**Lock Options**”. Press SELECT.
2. Select “**Lock/Unlock**” from the Lock Options Menu (*below left*) and press SELECT.
3. Use the Channel Switch to select the channel you want to lock. Press SELECT (*below right*).

```

Lock Options
Lock/Unlock
Edit Code
  
```

```

001 CH Name
002 CH Name L
003 CH Name
  
```

## Changing the Lock/Unlock Code

The first time the Lock/Unlock function is accessed, the user must enter the default lock code. The default lock code is "0000". This code can be maintained or changed. To change the lock code, perform the following procedure while in the "Menu Options" List mode:

1. Use the Channel Switch to highlight "Lock Options". Press SELECT.
2. Select "Edit Code" from the Lock Options Menu and press SELECT.
3. Enter your current code or the default code "0000".
4. The "New Code" prompt will appear. Enter your new four digit code using the 0-6 number buttons. You will then be prompted to confirm the new code by entering it again.
5. The lock code is now changed.

Note: You can use this same method to edit the code after it has changed from the default.



## Audio Level

The audio of the Streamer Lite Receiver can be adjusted to fine-tune the signal level for optimal performance. The following setting affects both the line output and FM output levels.

To change the audio level, perform the following procedure while in the "Menu Options" List mode:

1. Use the Channel Switch to highlight the "Audio Level". Press SELECT.
2. Use the Channel Switch to adjust to the desired audio output level. A 10 segment horizontal bar graph is displayed with a "-" sign to the left and a "+" sign to the right. To store your setting and exit this function, press SELECT.



Note: The volume controls on the remote control and on the right of the unit can be used to adjust the overall output level of the line/headphone out.

### Antenna Aiming

When using the optional Streamer Lite Receiver indoor, such as with the Home Docking Kit, it is important to locate the antenna in an acceptable location (See the individual installation guides for more information).

1. Use the Channel Switch to highlight “**Antenna Aiming**”. Press SELECT.
2. Two 10 segment horizontal bar graphs will be displayed ( SAT and TER) with a “-” sign to the left and a “+” sign to the right. SAT indicates satellite signal and TER indicates terrestrial signal – if available.
3. Adjust the antenna for greatest signal reception, per the Home Docking Kit manual.

To exit this function, press SELECT or MENU.



### Memory Options

In this mode, the user can turn the Memory Search Function (S-Seek) ON or OFF. In addition, all 30 Preset Memory Locations can be cleared. To change the Memory Options, use the following procedure while in the “**Menu Options**” List mode:

1. Use the Channel Switch to highlight “**Memory Options**”. Press SELECT.
2. Select one of the following Memory Options:
  - a. **Automatic Memory Search:** This feature enables or disables the ability of the Receiver to search for Song Titles stored in the S-Seek memory list. Press SELECT. Use the Channel Switch to select **On** or **Off** by highlighting the desired selection. Then press SELECT.
  - b. **Clear All:** This will delete all song titles stored in the S-Seek memory list. Press SELECT. A prompt appears confirming - **Clear All**. Select “**Yes**” or “**No**” and press SELECT.

To exit this function, press SELECT or MENU.

## Time-Based Features

This Menu Option allows for adjustment of the following items:

Clock	Auto Shutdown
Alarm Clock	Sleep Mode
Program Alert	

To change the Time-Based Features, use the following procedure while in the “**Menu Options**” List mode:

1. Use the Channel Switch to highlight the “**Time-Based Features**”. Press SELECT.
2. Use the Channel Switch to select one of the following Time-Based Features to adjust:
  - a. **Clock:** When entering this menu option, you can configure format of the clock shown on the default display and the time zone in which you reside. The clock data is provided via the Sirius Satellite data stream, and will update based on the received signal.
    - **Format:** The Clock Format option allows for either 12 Hour (Default) or 24 Hour display.

- **Time Zone:** Since the clock adjusts automatically, it is important to specify your proper time zone. Use the Channel Switch to select the proper time zone. The following is a list of time zones available:
  - (GMT-9:00) Alaska
  - (GMT-8:00) Pacific
  - (GMT-7:00) Mountain
  - (GMT-6:00) Central
  - (GMT-5:00) Eastern
  - (GMT-4:00) Atlantic (GMT-3:30) Newfoundland (Abbreviated as Newfndln)
- **Daylight Savings Time (DST) Observance:** Activate this function if your area is subject to DST; use the Channel Switch to toggle between **DST Observed** (default) or **DST Not Observed**.
- b. **Alarm Clock:** When this menu option is highlighted and selected, you will be able to set the unit to turn on at a specific time. The last selected channel prior to shutdown will be tuned when the Alarm feature is activated. Alarm appears on the first line of the display followed by the alarm options:



