



User Guide

Starmate 5

Dock & Play SIRIUS Radio



Here's your new **SIRIUS® Starmate ST5** **Dock & Play Radio**

Your new SIRIUS Starmate ST5 Dock & Play Radio comes with everything you need to enjoy SIRIUS® in your car. And with available SIRIUS Universal Docking accessories you can use your Starmate ST5 just about anywhere.

Your new Starmate ST5 gives you powerful features:

- >> SIRIUS Replay™ – Pause, rewind and replay up to 44 minutes of live radio.
- >> Memo function – Store up to 30 favorite songs and artists plus a favorite sports team or NASCAR® car and get an alert whenever they're playing on any channel.
- >> Easy-to-read wide-angle 5-line display.
- >> Built-in wireless FM transmitter so you can listen to SIRIUS through your car's FM stereo. An FM Presets button makes transmitter frequency changes quick and easy.
- >> Full-function wireless remote control

Use this manual to familiarize yourself with all of your SIRIUS Starmate ST5's features and capabilities. For the latest information about your ST5 and other SIRIUS products and accessories, visit <http://www.sirius.com>.

Table of Contents

Table of Contents	4
Warning and Safety Information	6
FCC Information	6
Canadian Compliance	7
General Precautions	7
Warnings	9
Copyrights & Trademarks	10
Package Contents	11
Installation	14
Installing the Vehicle Dock	14
Installing the Magnetic Antenna	21
Connecting the Cigarette Lighter Adapter	37
Docking the Starmate ST5	38
Cable Separation and Routing	39
Connecting the Starmate ST5 to Your Vehicle's Audio System	41
Subscribing to the SIRIUS Service	65
Controls	66
SIRIUS Starmate ST5 Front Panel	66
Remote Control Buttons	68
Vehicle Dock Reference Guide	71

Operation	72
Display Screen Information	72
Changing Channels and Categories	73
My Channels Category	74
Display Button (Disp)	75
Selecting Channels Directly	76
Channel Presets (Band Button)	77
Memory (MEMO) and Song Seek (S-Seek) Functions	79
Jump Button	87
SIRIUS Replay	89
Using SIRIUS Replay	91
FM Presets Button	93
Menu Options	96
Sirius ID	96
FM Transmitter	97
Settings	98
Parental Control	104
Time Based Features	106
Signal Indicator	112
Factory Default	113
Troubleshooting	115
Specifications	116
Sirius ID	117

Warning & Safety Information

FCC Information

This device complies with part 15 of the FCC Rules. Operation is subject to the following two conditions:

1. This device may not cause harmful interference, and
2. This device must accept any interference received, including interference that may cause undesired operation.

Note: This equipment has been tested and found to comply with the limits for a CLASS B digital device, pursuant to Part 15 of the FCC Rules. These limits are designed to provide reasonable protection against harmful interference when the equipment is operated in a commercial environment. This equipment generates, uses, and can radiate radio frequency energy and, if not installed and used in accordance with the instructions, may cause harmful interference to radio communications. However, there is no guarantee that interference will not occur in a particular installation. If this equipment does cause harmful interference to radio or television reception, which can be determined by turning the equipment off and on, the user is encouraged to try to correct the interference by one or more of the following measures:

1. Reorient or relocate the receiving antenna.
2. Increase the separation between the equipment and the receiver.
3. Connect the equipment into an outlet on a circuit different from that to which the receiver is connected.
4. Consult the dealer or an experienced radio/TV technician for help.



Warning

Changes or modifications not expressly approved by the manufacturer could void the user's authority to operate the equipment.

Canadian Compliance

This Class B digital apparatus complies with Canadian ICES-003.

Cet appareil numérique de la classe B est conforme à la norme NMB-003 du Canada.

General Precautions

Liquid Crystal Precautions

If the LCD screen on the radio is damaged, do not touch the liquid crystal fluid. If any of the following situations happen, take the action indicated:

1. If the liquid crystal fluid comes in contact with your skin, wipe the skin area with a cloth and then wash the skin thoroughly with soap and running water.
2. If the liquid crystal fluid gets into your eye, flush the eye with clean water for at least 15 minutes. Seek medical care.
3. If the liquid crystal fluid is ingested, flush your mouth thoroughly with water. Drink large quantities of water and induce vomiting. Seek medical care.



Safety Precautions

Be sure to observe the following warnings. Failure to follow these safety instructions and warnings may result in a serious accident.

- Do not operate your SIRIUS ST5 in a way that might divert your attention from driving safely. As a driver, you alone are responsible for safely operating your vehicle in accordance with traffic safety laws at all times.

- Do not install the radio where it may obstruct your view through the windshield, or of your vehicle's indicator displays.
- Do not install the radio where it may hinder the function of safety devices such as an airbag. Doing so may prevent the airbag from functioning properly in the event of an accident.
- Be sure the radio and accessories are installed as described in these installation instructions and the instructions which accompany each accessory kit. SIRIUS Satellite Radio is not responsible for issues arising from installations which were not installed according to the instructions.
- Before attaching the suction cup mount to your windshield, you should check your state and local laws for regulations regarding mounting this device on your windshield.
- To avoid short circuits, do not open the radio or accessories, and never put or leave any metallic objects (coins, tools, etc.) inside the radio.
- If the radio or accessories emit smoke or unusual odors, turn the power off immediately, and disconnect the radio from any power source.
- Do not drop the radio or subject it to strong shocks.
- If your ST5 doesn't seem to be working properly, turn it off, wait 10 seconds and then turn it on again.
- The installation and use suggestions contained in this manual are subject to any restrictions or limitations that may be imposed by applicable law. The purchaser should check applicable law for any restrictions or limitations before installing and/or operating this unit.
- Do not install the FM Extender Antenna where it will hinder or block your view. In some states it may be illegal to mount it on the windshield of your vehicle. Check applicable law for any restrictions or limitations before installing the FM Extender Antenna on your windshield.

- Do not install the FM Extender Antenna where it may hinder the function of safety devices such as an airbag. Doing so may prevent the airbag from functioning properly in the event of an accident.



Warnings

Notice To Drivers In California and Minnesota

State law prohibits drivers in California and Minnesota from using suction mounts on their windshields while operating motor vehicles. Other dashboard or friction mounting options should be used. SIRIUS does not take any responsibility for any fines, penalties, or damages that may be incurred as a result of disregarding this notice. (See California Vehicle Code Section 26708(a); Minnesota Statutes 2005, Section 169.71)

Operating Temperature

The radio is designed to operate between -20° to $+85^{\circ}$ C (-4° to $+185^{\circ}$ F). Avoid leaving the radio in a vehicle or elsewhere where the temperature may fall outside this range. Extreme temperatures or extreme temperature fluctuations can degrade the performance of the LCD display screen, and possibly damage it.

Cleaning and Maintenance

If the radio or accessories become dirty, turn the power off and wipe it clean with a soft cloth. Do not use hard cloths, strong cleaning fluids, paint thinner, alcohol, or other volatile solvents to clean. These may cause damage to the radio.

Cigarette Lighter Adapter

The Vehicle Dock cannot be powered directly from a vehicle's 12VDC power system. It must be powered from the vehicle's cigarette lighter or similar power port using the included Cigarette Lighter Adapter or an equivalent DC power adapter (see your local electronics dealer). Connecting the Vehicle Dock directly to the vehicle's 12VDC power system may result in damage to the Vehicle Dock or SIRIUS radio, or both.

Copyrights & Trademarks

© 2008 SIRIUS Satellite Radio Inc. All Rights Reserved.

® “SIRIUS”, the SIRIUS dog logo, channel names and logos are trademarks of SIRIUS Satellite Radio Inc. All other trademarks, service marks, sports team names, album art, and logos are the property of their respective owners. All Rights Reserved.

™ “Starmate” is a trademark of SIRIUS Satellite Radio.

Portions of the software on this radio are licensed under the eCos License. Distribution of eCos requires that the eCos source code be made available to SIRIUS Satellite Radio customers. The eCos License and eCos source code are available to the public at <http://www.sirius.com/ecoslicense>.

SIRIUS Satellite Radio reserves all rights to all radio software not covered under the eCos license. This includes all portions of radio software that were not distributed to SIRIUS as part of the eCos operating system.

Hardware, subscription and activation fee required. For full Terms & Conditions, visit <http://sirius.com>. Prices and programming are subject to change. Not available in HI and AK. Equipment and subscription sold separately. Installation required with some equipment.

Package Contents

The following items are included with your SIRIUS Starmate ST5 radio:

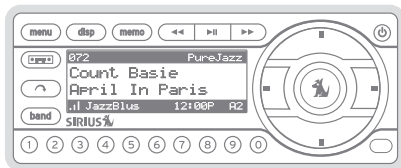

Starmate ST5 Radio



Remote Control

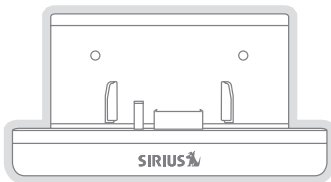

Vehicle Dock

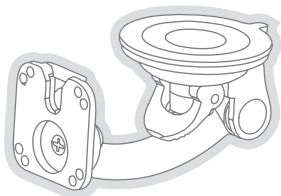

Suction Cup Mount

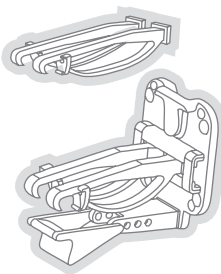

Vent Mount &
Extended Vent Hooks

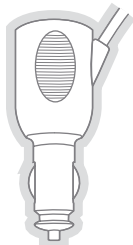

Cigarette Lighter
Adapter



Magnetic Antenna



Antenna
Cover/Tail



Mounting Screws



Alcohol Swab

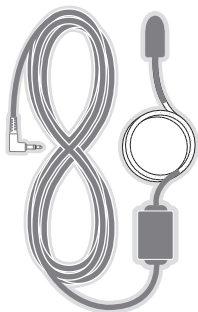

FM Extender Antenna



Suction Cups (2)



Self Adhesive
Cable Guides (3)

Unpack your SIRIUS Starmate ST5 radio carefully and make sure that everything shown is present. If anything is missing or damaged, or if your SIRIUS Starmate ST5 fails to operate, notify your dealer immediately. We recommend that you retain the original carton and packing materials in case you need to ship your radio in the future.

Installation

SIRIUS suggests that you have your Starmate ST5 professionally installed in your vehicle. Professional installation provides an experienced technician to install this product in your vehicle, advice for selecting a suitable mounting location for the Vehicle Dock, installation of the antenna, and proper routing of all the necessary wires and cables. If the locations of your Starmate ST5 and your vehicle's FM antenna make the performance the ST5's built-in FM transmitter within your vehicle poor, a professional installer will have the necessary accessories to install an optional FM Direct Adapter or an audio cable to connect the audio output of the Vehicle Dock directly to your vehicle's audio system. Ask your SIRIUS retailer if they provide professional installation services, or can recommend a professional installation service.

Installing the Vehicle Dock

When installing the Vehicle Dock in your vehicle, choose a location in your vehicle where it will not block your vision, interfere with the vehicle controls, or obstruct the air bag. The location should be easily accessible and provide good visibility of the display, and should not be located where it will be in direct sunlight which will affect the visibility of the display screen.

The mounting accessories necessary to install the Vehicle Dock in a vehicle are provided. *Figure 1* shows two examples of the SIRIUS radio mounted in a vehicle: **A** is the suction cup mount method, and **B** is the vent mount method using the vent mount clip.

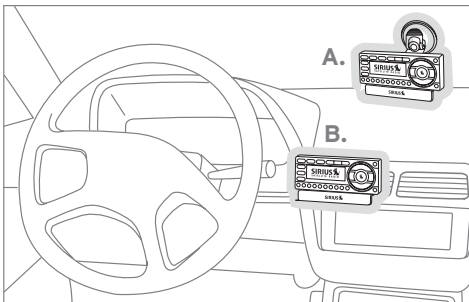
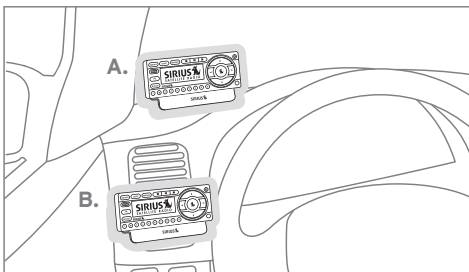

Figure 1

Depending upon the mounting location you select in your vehicle, the mount should be attached to the vehicle dock and installed as described in the following sections.

Suction Cup Mount Method (A)

The suction cup mount may be attached to any smooth surface. Before attaching the suction cup mount to your windshield, you should check your state and local laws for regulations regarding mounting this device on your windshield.

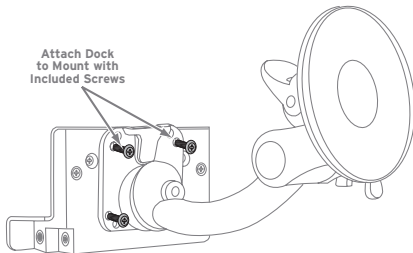

Figure 2

To mount the vehicle dock using the suction cup mount, assemble the mount as follows:

1. Attach the vehicle dock to the suction cup mount using the provided screws (see *Figure 2*).
2. Clean the area where you are attaching the suction cup with the supplied alcohol wipe.

3. Be sure the cam lever is up (as shown in *Figure 3*) and position the suction cup mount on the windshield or other location you which have chosen. Press the cam lever all the way down towards the base of the mount until it locks to adhere the suction cup. (To unlock the suction cup, lift the lever up.)

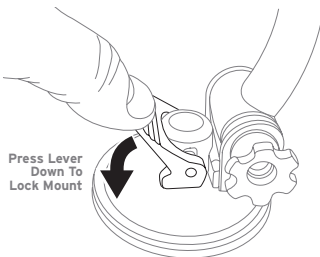

Figure 3

Vent Mount Method (B)

To mount the vehicle dock using the vent mount method, install the vent mount as follows:

1. If the vent louvers in your vehicle are recessed, you may need to use the longer vent hooks with the vent mount. Refer to *Figure 4* and install the longer vent hooks into the vent mount. Be sure to observe the orientation of the vent hooks as shown.
2. Attach the vent mount to the vehicle dock using the provided screws (see *Figure 5*).

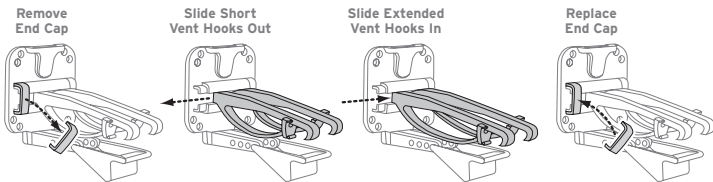

Figure 4

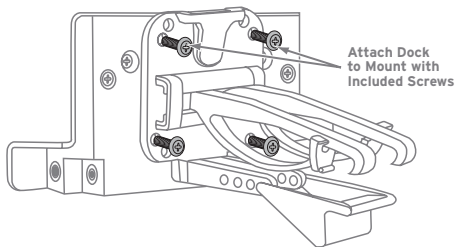

Figure 5

3. Refer to *Figure 6* and attach the vent mount to a heating/air conditioning vent in your vehicle. Position the two tension springs **A** against a vent louver **B**. Then push the vent mount into the vent, far enough so that the hooks **C** drop down and hook the rear of the vent louver (see *Figure 7*). Once you are sure that the hooks have grasped a vent louver, the tension springs **A** will keep the vent mount hooked to the louver.

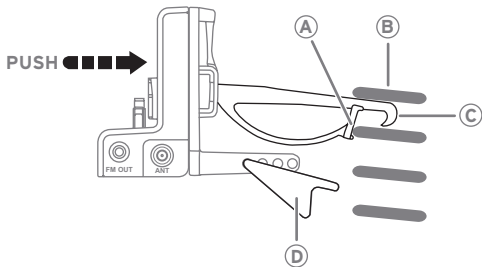

Figure 6

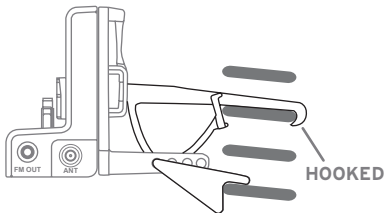

Figure 7

4. You can change the angle of the vehicle dock by changing the position of foot **D** on the vent mount to a different adjustment hole (see *Figure 8*).

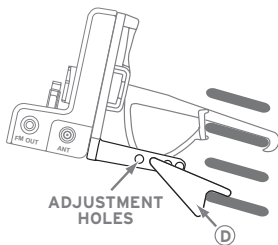

Figure 8

Installing the Magnetic Antenna

Caution

Because adhesive is used in the installation of the Rubber Antenna Cover/Tail, we recommend that you install the antenna at or above room temperature (68° F). The adhesive on the Rubber Cover/Tail may not adhere properly to the vehicle roof at temperatures lower than this. Warmer temperatures will also make it easier to route of the antenna cable through the rubber molding around the windows and in other areas in the vehicle. Maximum adhesion usually occurs within 72 hours at room temperature, so you should avoid car washes as well as other contact with the antenna and Rubber Cover/Tail during this 72-hour period.



Warning

Be sure not to cut, damage, or puncture the external jacket of the antenna cable during the installation procedure. Damage to the antenna cable can degrade the SIRIUS signal or make it unavailable, and can also cause water to intrude via the cable into the antenna causing the antenna to fail.

Do not lengthen or shorten the antenna cable by cutting it. Doing so will cause the antenna to not function properly.

Installation

Installing the magnetic antenna consists of two steps:

- Mounting the magnetic antenna and Rubber Antenna Cover/Tail on the vehicle
- Routing the antenna cable through the vehicle to the Vehicle Dock

Antenna Mounting

The SIRIUS Magnetic Mount Vehicle Antenna has a strong magnetic mount designed to hold it in place during normal driving conditions (highway/city). This also makes the antenna easy to remove for transferring it to other vehicles.

Figure 9 shows the optimal mounting location for the antenna on several types of vehicles. These mounting positions should be observed when installing the antenna:

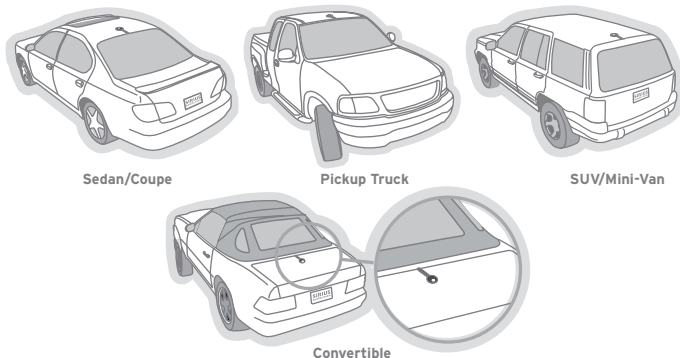

Convertible

Figure 9

- **Sedan/Coupe/SUV/Mini-Van:** Install the antenna at the rear center of the roof, near the rear window.
- **Pickup Truck:** Install the antenna at the front center of the roof, near the windshield.
- **Convertible:** Install the antenna at the front center of the trunk lid, near the rear window.

The SIRIUS antenna needs to have an unobstructed area of **3 inches by 3 inches around it**. It is important to mount the antenna where no obstructions will block the antenna from receiving the SIRIUS signal. Objects which can obstruct the antenna could be a roof rack, a sunroof, a roof-mounted cargo container, another antenna, etc. If your vehicle has a potential obstruction, be sure that the SIRIUS antenna is mounted at least 3 inches away from it (but no closer than 3 inches from the edge of the roof or trunk lid).

Note: Read the **DO** and **DO NOT** installation tips beginning on page 32 for additional antenna installation information.

Follow this procedure to mount the antenna:

1. Select an appropriate mounting position for your type of vehicle that has an unobstructed area of 3 inches by 3 inches around the antenna.
2. Attach the Rubber Cover/Tail to the antenna, as shown in *Figure 10*, and press the antenna cable into the rubber cover/tail. The Rubber Cover/Tail will help to position the antenna the correct distance from the edge of the roof or trunk lid.

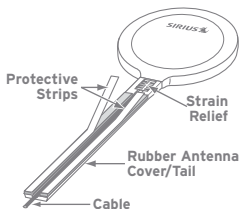

**Magnetic Antenna
(Upside-Down)**

Figure 10

3. Clean the surface area of the vehicle where you will be installing the antenna with the alcohol prep pad.

4. Peel the protective material from the adhesive strips (see *Figure 10*, on page 23) and press the rubber Cover/Tail firmly into place on the vehicle.
5. Double check that the location of the antenna and rubber cover/tail are correct, and continue to press firmly down on the Rubber Cover/Tail for another 30 seconds. At room temperature (68° F), maximum adhesion usually occurs within 72 hours. During this period, avoid car washes and other contact with the antenna and the Rubber Antenna Cover/Tail.

Cable Routing

After you have mounted the antenna you can route the antenna cable to the SIRIUS Vehicle Dock. Separate antenna cable routing procedures are provided for each type of vehicle: Sedan/Coupe, Pickup Truck, SUV/Mini-Van and Convertible.

Note that additional breakout illustrations for each step of the antenna cable routing procedures can be found on the SIRIUS website at <http://www.sirius.com>. Click on the **Install/Activate** link and then follow the link for the **Car Installation Tips**.

Sedan/Coupe Antenna Cable Routing Procedure

Figure 11 shows how the antenna cable should be routed from the antenna to your Starmate ST5 in a sedan/coupe.

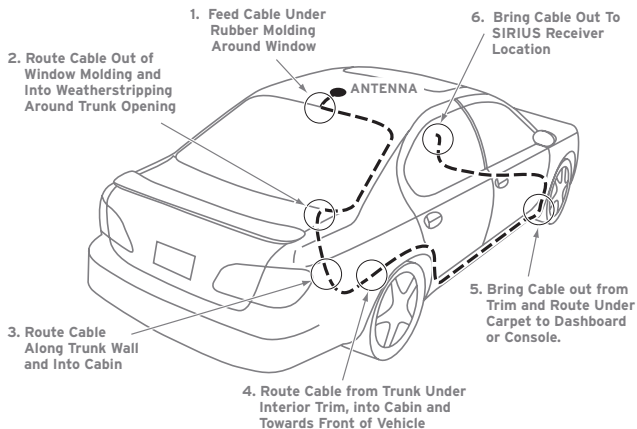

Figure 11

Follow these detailed cable installation instructions:

1. Feed the cable from the antenna underneath the rubber molding around the rear window. Use a plastic putty knife or similar object to lift the rubber molding around the rear window and tuck the antenna cable underneath the molding. Route the antenna cable around and down the window to the lowest point. If your rear window does not have rubber molding, SIRIUS recommends consulting with a professional installer.

2. Route the antenna cable out of the window molding and into the rubber weather stripping around the trunk opening. Lift the weather stripping from the opening and tuck the cable inside it, then replace the weather stripping. To avoid sharp bends in the cable, run the cable inside of the weather stripping for a few inches, then remove the cable from the weather stripping inside of the trunk. Keep the cable away from hinges, gears, etc., that could damage it.
3. Route the cable out from the rubber weather stripping and along the trunk wall. Continue routing the cable into the cabin through a conduit or along an existing wiring harness.
4. Route the cable through the main cabin area under the interior trim, towards the front of the vehicle. Use the plastic putty knife to lift the plastic trim just enough to tuck the cable underneath. Avoid side airbag locations on back pillars and above the doors. (Airbag locations are marked with "SRS" logos.) Be careful not to crimp or cut the cable.
5. Bring the cable out from the trim near the firewall and route it under the carpet toward the dashboard or console. Coil any excess cable in a hidden location, such as under the carpet, keeping it away from any vehicle pedals or controls. Secure the excess cable with wire ties.
6. Bring the end of the cable out at the SIRIUS Vehicle Dock location. Leave yourself enough cable so you can easily connect it to the antenna connector on the Vehicle Dock.

Pickup Truck Antenna Cable Routing Procedure

Figure 12 shows how the antenna cable should be routed from the antenna to your Starmate ST5 in a pickup truck.

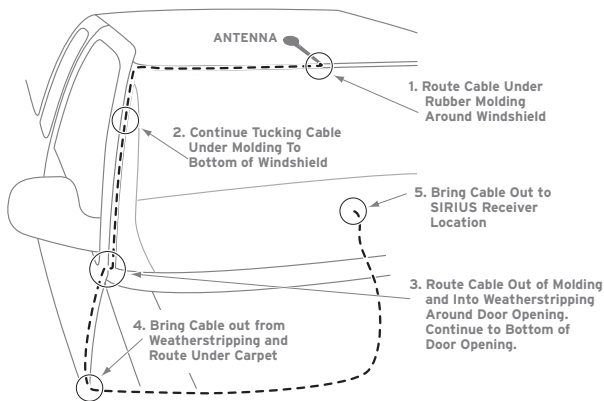

Figure 12

Follow these detailed cable installation instructions:

1. Use a plastic putty knife or similar tool to lift the rubber molding around the windshield and tuck the antenna cable underneath it.
2. Continue tucking the cable underneath the windshield molding around the windshield to the lowest corner.

3. At the lowest corner of the windshield, route the cable out of the windshield molding and into the rubber weather stripping around the door opening. Lift the weather stripping from the opening and tuck the cable inside it, then replace the weather stripping. Run the cable inside of the weather stripping to the bottom of the door opening.
4. Pull the cable out of the weather stripping at the bottom of the door opening and route it under the carpet toward the dashboard. Coil any excess cable in a hidden location, such as under the carpet, keeping it away from any vehicle pedals or controls. Secure the excess cable with wire ties.
5. Bring the end of the cable out at the SIRIUS Vehicle Dock location. Leave yourself enough cable so you can easily connect it to the antenna connector on the Vehicle Dock.

SUV/Mini-Van Antenna Cable Routing Procedure

Figure 13 (opposite) shows how the antenna cable should be routed from the antenna to your Starmate ST5 in an SUV or a Mini-Van.

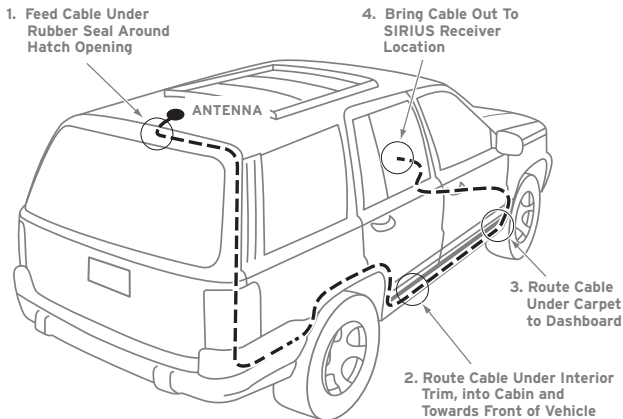

Figure 13

Follow these detailed cable installation instructions:

1. Feed the antenna cable underneath the rubber weather stripping of the rear tailgate window/door and route the cable along the rear hatch. Lift the weather stripping from the opening and tuck the cable inside it, then replace the weather stripping. Pull the cable out from weather stripping and route it into the cabin under the interior trim. Avoid hinges or gears that could crimp or cut the cable.
2. Route the cable through the SUV's main cabin area under the interior trim, towards the front of the vehicle. Use a plastic putty knife to lift the plastic trim just enough to tuck the cable underneath. Avoid side airbag locations on back pillars and above the doors. (Airbag locations are marked with "SRS" logos.) Be careful not to crimp or cut the cable.

- Bring the cable out from the trim near the firewall and route it under the carpet toward the dashboard or console. Coil any excess cable in a hidden location, such as under the carpet, keeping it away from any vehicle pedals or controls. Secure the excess cable with wire ties.
- Bring the end of the cable out at the SIRIUS Vehicle Dock location. Leave yourself enough cable so you can easily connect it to the antenna connector on the Vehicle Dock.

Convertible Antenna Cable Routing Procedure

Figure 14 shows how the antenna cable should be routed from the antenna to your Starmate ST5 in a convertible.

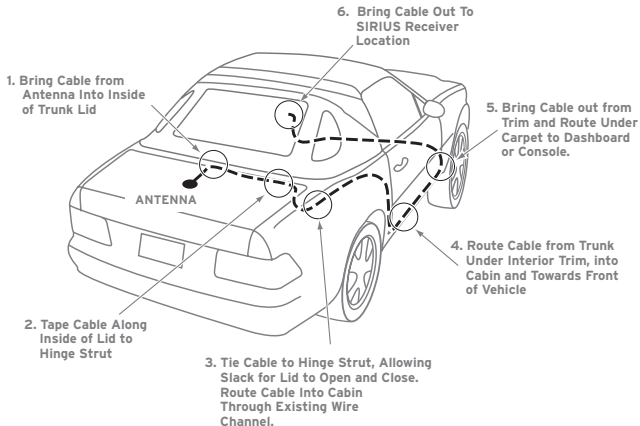

Figure 14

Follow these detailed cable installation instructions:

1. Bring the cable from the antenna into the trunk at the front edge of the trunk lid. Keep any bends in the cable loose. Tape or tie the cable along the inside of the trunk lid to the trunk lid hinge strut.
2. Allow enough slack in the cable so the trunk lid can easily open and close and keep the cable away from hinges, gears, etc., that could crimp or cut it. Route the cable along the trunk wall and into the cabin through a conduit or along an existing wiring harness.
3. Route the cable through the main cabin area under the interior trim, towards the front of the vehicle. Use a plastic putty knife to lift the plastic trim just enough to tuck the cable under underneath. Avoid side airbag locations on back pillars and above the doors. (Airbag locations are marked with "SRS" logos.) Be careful not to crimp or cut the cable.
4. Bring the cable out from the trim near the firewall and route it under the carpet toward the dashboard or console. Coil any excess cable in a hidden location, such as under the carpet, keeping it away from any vehicle pedals or controls. Secure the excess cable with wire ties.
5. Bring the end of the cable out at the SIRIUS Vehicle Dock location. Leave yourself enough cable so you can easily connect it to the antenna connector on the Vehicle Dock.

Tip**Antenna Installation Tips**

The following **DO** and **DO NOT** antenna mounting tips illustrate how to install the antenna for optimal performance, and also illustrate where the antenna should not be installed.

DO

Mount the antenna on the roof, at least 3 inches from the edge.

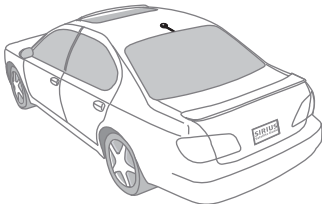
**DO**

Mount the antenna on the roof where it has a clear view of the sky in all directions.

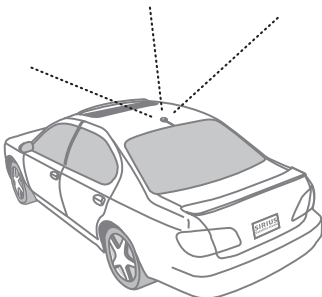

DO

Mount the antenna on the roof where it has at least 3 inches of clear space around it.

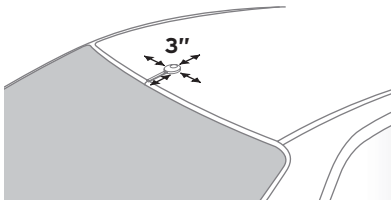

DO

Use the supplied Rubber Tail Cover to protect the antenna cable.

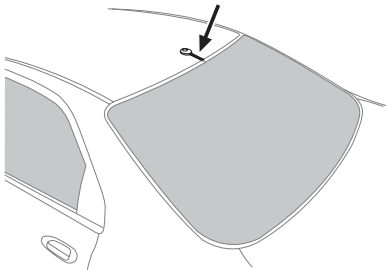

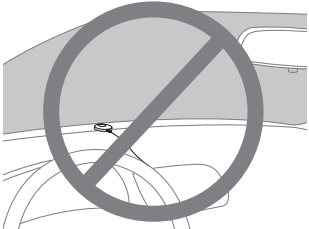
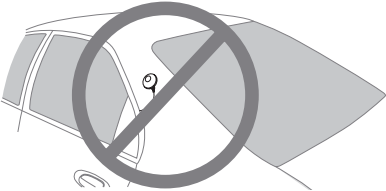
DO NOT	Don't mount the antenna inside the vehicle, for example, on the dashboard.	 A line drawing of the interior of a vehicle, showing the dashboard and steering wheel. A small antenna is mounted on the dashboard. A large, dark gray circle with a diagonal slash through it is overlaid on the image, indicating that this installation is prohibited.
DO NOT	Don't mount the antenna on any of the vehicle's front, back or side pillars.	 A line drawing of the exterior of a vehicle, showing the front, back, and side pillars. A small antenna is mounted on the side pillar. A large, dark gray circle with a diagonal slash through it is overlaid on the image, indicating that this installation is prohibited.

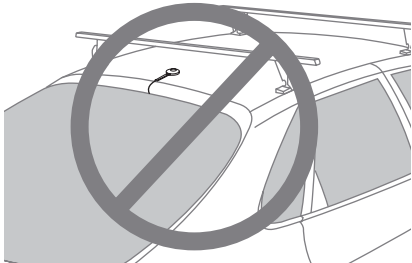
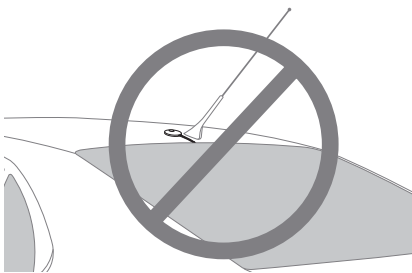
<p>DO NOT</p>	<p>Don't mount the antenna close to a roof rack. Adjust the rack so it's further away from the antenna or move the antenna closer to the center of the roof.</p>	
<p>DO NOT</p>	<p>Don't mount the antenna close to another antenna. Mount it at least 3 inches away.</p>	

**DO
NOT**

Don't mount the antenna closer than 3 inches from the edge of the roof. Use the supplied rubber tail/cover as a guide for judging proper length and correct positioning.

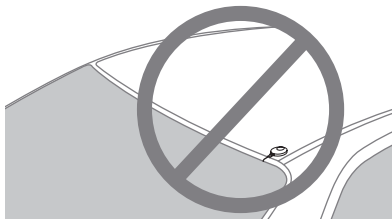

After you've routed the cable to the SIRIUS Vehicle Dock, connect the antenna cable to the ANT connection on the left side of the Vehicle Dock. (See *Figure 15*.)

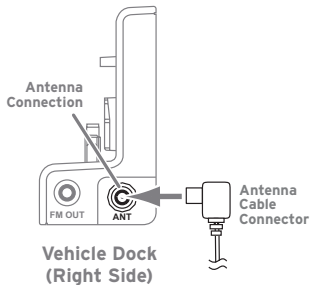

Figure 15

Connecting the Cigarette Lighter Adapter

Connect the provided cigarette lighter adapter to the PWR connector on the right side of the Vehicle Dock (see *Figure 16*).

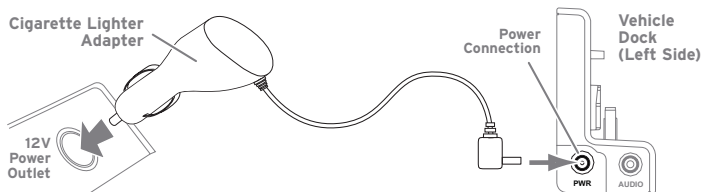

Figure 16



IMPORTANT: Do NOT power the VEHICLE DOCK DIRECTLY FROM YOUR VEHICLE'S 12VDC POWER SYSTEM WITHOUT USING THE CIGARETTE LIGHTER ADAPTER. DOING SO COULD DAMAGE THE VEHICLE DOCK, YOUR STARMATE ST5 OR BOTH.

Docking the Starmate ST5

To place your SIRIUS ST5 into the Vehicle Dock, align the radio against the rear of the Dock so that the rails on the Dock fit into the mounting slots in the back of the radio (see *Figure 17*). Slide the radio all the way down onto the Dock so that it fits firmly.

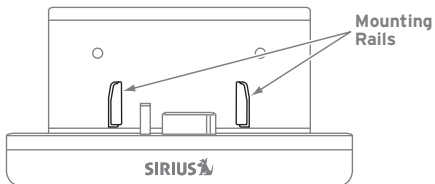

Figure 17

Cable Separation and Routing



FCC Information

The satellite antenna cable, FM extender antenna (FEA) cable and cigarette lighter adapter (CLA) power cable must be appropriately separated and routed for your radio to be compliant with federal regulations.

Step 1

The connections on your vehicle dock are clearly marked. Install your vehicle dock and connect the antenna cable into the connection labeled “ANT”, the CLA power cable into the power connection marked “PWR” and the FEA cable into the connection marked “FM OUT”. (See *Figure 18*.)

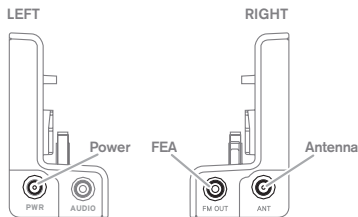

Figure 18

Step 2

It is important that you keep the three cables as separate from each other as possible and that you keep the two antenna cables away from the vehicle dock and from the CLA power cable. The cables must not be bundled together as they exit the dock (see *Figure 19*, on page 40).

As a guide, you can follow the diagram in *Figure 19*, adapting the example to suit your own vehicle's configuration. For example, if your cigarette lighter socket is to the left of the vehicle dock, route the two antenna cables towards the passenger side of the vehicle. If your cigarette lighter socket is on the right-hand side of the vehicle dock, route the two antenna cables towards the driver's door. The CLA cable and antenna cables MUST be routed in opposite directions. Safely conceal all antenna cables within door, carpet or cash panels to prevent snags and interference.

Step 3

Coil any excess cable between the cigarette lighter socket and vehicle dock, keeping it away from vehicle pedals or controls to prevent any slack which might interfere with the safe operation of your vehicle. Secure the excess cable with wire ties. If possible, tuck the coiled part in a hidden location, such as in between the carpet and plastic panel of the front console (see *Figure 20*).

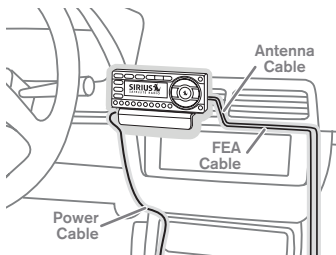

Figure 19

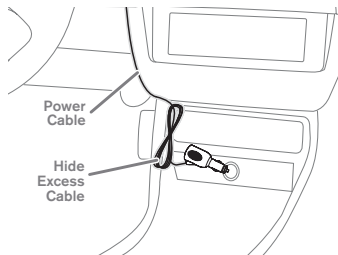

Figure 20

Step 4

Follow the instructions in this manual to install, route and hide the antenna cable and the FEA cable. Be sure to coil and secure any excess cable in a hidden location, such as under the carpet on the passenger side, keeping it away from vehicle pedals and controls. The bundled cables should be as far away from the CLA power cable as possible (see *Figure 21*).

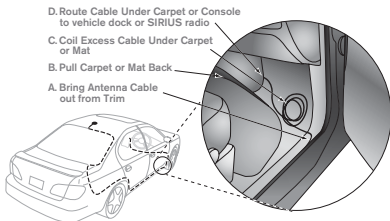

Figure 21

Connecting the Starmate ST5 to Your Vehicle's Audio System

There are two ways to connect your SIRIUS Starmate ST5 to your vehicle's audio system: Direct Connection or Wireless Connection. Which one will perform best in your vehicle depends on your vehicle's audio system. For the latest information go to <http://www.sirius.com/vehicleinstallation>.

Direct Wired Audio Connection

If your vehicle's audio system has an "AUX IN" or "LINE IN" jack it is the best-quality audio connection you can use for your SIRIUS radio. (And if the AUX IN or LINE IN connector is located somewhere on the front of your vehicle radio or elsewhere in the cabin, this is also the easiest way to connect your SIRIUS receiver.)

1. Purchase an audio cable that matches the connection type of your vehicle's audio system and your SIRIUS Vehicle Dock at your local electronics retailer.
 - The Vehicle Dock requires a male $\frac{1}{8}$ " stereo connector.
2. Plug the cable's male $\frac{1}{8}$ " stereo connector into the AUDIO jack on the left side of the Vehicle Dock. Plug the other end into the AUX IN/LINE IN connector on your vehicle's audio system (see *Figure 22*).

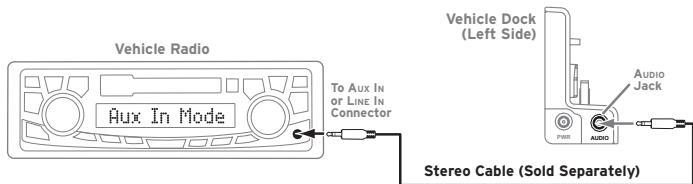

Figure 22

Direct FM Audio Connection

If your vehicle's audio system does not have an Aux In/Line In connection, a SIRIUS FM Direct Adapter (sold separately) will provide the next-best quality connection between your Starmate ST5 and your vehicle radio. You will listen to your ST5 through your car radio's FM tuner, but the SIRIUS FM Direct Adapter connects your vehicle's FM radio directly to the Vehicle Dock's FM Out jack, eliminating the outside static and interference you sometimes experience when using a wireless FM connection (see *Figure 23*).

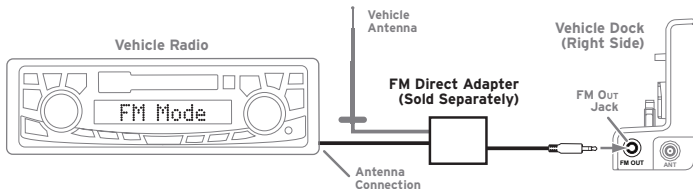

Figure 23

NOTE: PROFESSIONAL INSTALLATION MAY BE REQUIRED. SEE YOUR LOCAL SIRIUS RETAILER. THE SIRIUS FM DIRECT ADAPTER IS AVAILABLE AT YOUR LOCAL SIRIUS RETAILER OR AT [HTTP://SHOP.SIRIUS.COM](http://shop.sirius.com). FOLLOW TO THE INSTRUCTIONS INCLUDED WITH THE FM DIRECT ADAPTER.

Cassette Adapter

If your vehicle's audio system has a cassette player you can purchase a cassette adapter from your local electronics retailer or from SIRIUS at <http://shop.sirius.com>. Plug the adapter's connector into the Audio jack on the left side of the Vehicle Dock, and insert the adapter into your vehicle's cassette player (see *Figure 24*).

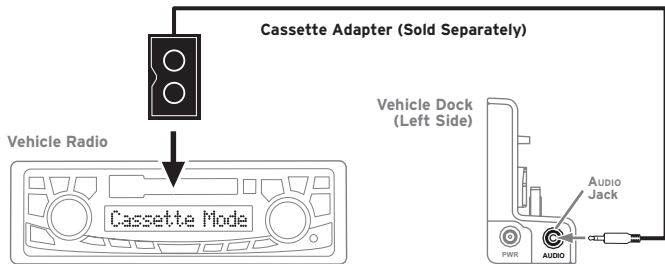

Figure 24

NOTE: REFER TO THE CASSETTE ADAPTER'S INSTRUCTIONS FOR CORRECT USE.

Wireless Connection

If you cannot connect your SIRIUS radio directly to your vehicle's audio system, your Starmate ST5 contains an FM transmitter that will 'broadcast' its audio to your vehicle's FM radio.

To use this you need to tune the ST5's FM transmitter to an FM frequency that's not being used in your area (If you use an FM channel that is being used by a local broadcaster, it will interfere with your ST5's performance.) See *Figure 25*.

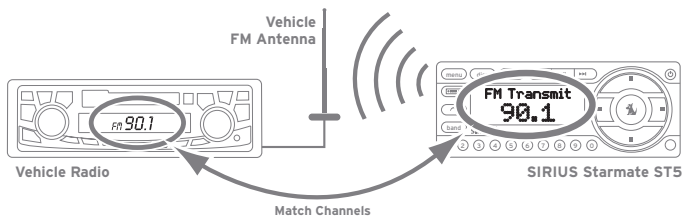

Figure 25

1. Tune through your vehicle radio's FM channels to find an FM channel (between 88.1MHz and 107.9MHz) that is not broadcasting in your area.
2. Once you have located an FM channel that is not broadcasting in your area, save it as a preset on your vehicle radio. This will become your SIRIUS preset.
3. Dock your Starmate ST5 and turn its power ON. Wait for the *Channel Update* to finish before pressing any buttons.

- Press and hold the FM PRESETS button (see *Figure 26*). The FM PRESETS screen will appear, with FM1 highlighted. FM1 is factory-set to 88.1MHz. This may not be the best frequency for your area (see *Figure 27*).

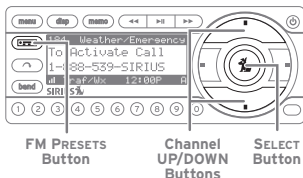

Figure 26

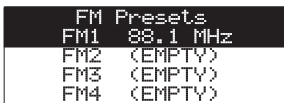

Figure 27

- Press the Select button. The FM1 frequency screen will appear (see *Figure 28*, left).

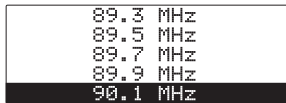
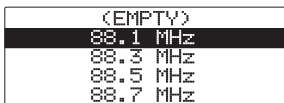

Figure 28

- Use the Channel UP/DOWN buttons to highlight the FM frequency that matches the channel that you preset on your vehicle radio in *Step 2*, then press the Select button to select it (see *Figure 28*, right).

To listen to your SIRIUS radio, turn your SIRIUS radio ON, then turn your vehicle's FM radio ON and press the SIRIUS preset you set in *Step 2*, on page 44.

**Tip**

If you regularly travel between cities with different active FM channels, you may need to find channels that are not broadcasting in each city. Your Starmate ST5 can store up to 5 preset FM transmit channels (see *Figure 27*, on page 45), so you can easily switch to the best FM channel for each city.

- To switch the FM transmit preset, press the FM PRESETS button on the ST5 front panel, or the remote. (See pages 66 - 69)

If you're not sure which FM channels are not broadcasting in your home or travel cities, you can also go to **<http://www.sirius.com/fmchannel>** and search for a suggested FM channel based on your zip code.

Wireless Audio Connection Using the FM Extender Antenna

Your SIRIUS radio includes an FM Extender Antenna (FEA) that can maximize the audio quality of your SIRIUS radio when using a Wireless Connection. The FM Extender Antenna brings the FM signal transmitted from your SIRIUS radio into close proximity with your vehicle's FM antenna to provide a strong FM signal for good reception (see *Figure 29*).

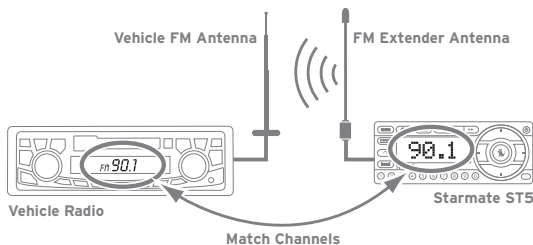

Figure 29

Because of the different kinds and locations of radio antennas found in different vehicles, SIRIUS suggests that the FM Extender Antenna be professionally installed in your vehicle. Professional installation provides an experienced technician to install the Extender Antenna, knowledge of your vehicle for locating its radio antenna, and routing the cable and connecting it to your SIRIUS radio. Ask your SIRIUS retailer if they provide professional installation services, or can recommend a professional installation service.

IMPORTANT NOTE

The FM Extender Antenna is placed **inside** your vehicle in close proximity to the vehicle's FM antenna. In order for it to provide a strong FM signal for good reception, it **MUST** be mounted in the correct location and orientation, as described in the following sections. The correct mounting location and orientation is determined by the type and location of your vehicle's FM antenna.



Warning and Safety Information

Safety Precautions

Be sure to observe the following warnings. Failure to follow these safety instructions and warnings may result in a serious accident and/or personal injury.

- Installation must be performed according to this installation guide. SIRIUS is not responsible for issues arising from installations not performed according to the procedures in this guide.
- Do not install the FM Extender Antenna where it will hinder or block your view. In some states it may be illegal to mount it on the windshield of your vehicle. Check applicable law for any restrictions or limitations before installing the extender cable on your windshield.
- Do not install the FM Extender Antenna where it may hinder the function of safety devices such as an airbag. Doing so may prevent the airbag from functioning properly in the event of an accident.
- The installation and use suggestions contained in this manual are subject to any restrictions or limitations that may be imposed by applicable law. The purchaser should check applicable law for any restrictions or limitations before installing the extender cable.



WARNING

Notice to drivers In California and Minnesota

State law prohibits drivers in California and Minnesota from using suction mounts on their windshields while operating motor vehicles. Other dashboard or friction mounting options should be used. SIRIUS does not take any responsibility for any fines, penalties, or damages that may be incurred as a result of disregarding this notice. (See California Vehicle Code Section 26708(a); Minnesota Statutes 2005, Section 169.71)

A Note About The Installation Procedure

Before you permanently mount the FM Extender Antenna (FEA), you will first mount it using the included suction cup mounts to test the installation. Once you find an acceptable location, you will remove the suction cups and permanently adhere the FEA using its adhesive mounts.

Installation

Step 1: Determine the type and location of your vehicle's FM antenna

The key to properly installing the FEA in your vehicle is being able to determine the type and location of your vehicle's FM antenna. The type and location of the FM antenna in your vehicle should be one of the following (see *Figure 30*, opposite):

- A.** Whip/aerial mounted on the front fender or hood: A fixed or retractable aerial antenna located on the front fender or hood of the vehicle.
- B.** Whip/aerial mounted in the A-pillar of car frame: A fixed or retractable aerial antenna located in the A-pillar of the vehicle's frame.
- C.** In-glass, in the rear windshield: Several lengths of wire in the rear windshield glass, usually near the top of the window. There is a difference between the FM antenna and the rear window defroster wires found in many vehicles. The FM antenna wires have uneven spacing, breaks in the wires, and some of the wires do not run from edge-to-edge in the glass, while the rear window defroster wires have uniform spacing and all wires run from edge-to-edge in the glass.
- D.** Whip/aerial mounted on rear part of roof: A whip or aerial antenna mounted on the rear part of the roof (often just above the rear windshield glass). The whip or aerial should be 7 inches or longer.
- E.** Whip/aerial mounted on the rear fender or trunk: A fixed or retractable whip or aerial antenna located on the rear fender or trunk of the vehicle.
- F.** Whip/aerial mounted on front part of roof: A whip or aerial antenna mounted on the front part of the roof (often just above the front windshield glass). The whip or aerial should be 7 inches or longer.
- G.** In-glass, in the front windshield: One or more strands of wire in the front windshield, usually near the top of the windshield.
- H.** In-glass, in a rear side window: Several strands of wires in a rear side window, often found in SUVs, mini-vans and station wagons.

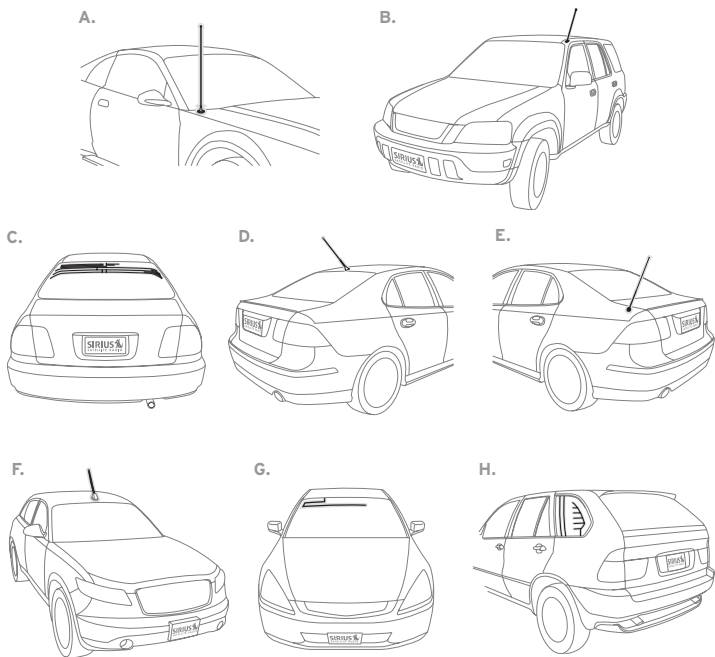

Figure 30

Step 2: Prepare the FEA for temporary installation

Attach the suction cups to the antenna portion of the FEA in the positions shown in *Figure 31*. The antenna portion of the FEA is the relatively thinner section of the cable in between the bead and the arrow that transmits the FM signal to your vehicle's FM antenna.

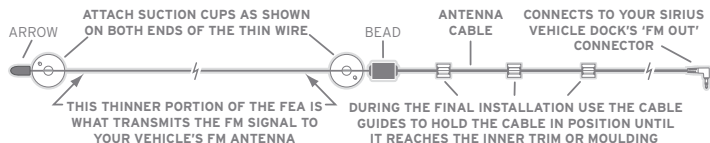

Figure 31

Step 3: Use the suction cups to temporarily install the FEA according to your vehicle's antenna type

On the next several pages you will find the FEA mounting location for your type of FM antenna (**A**, **B**, **C**, etc.). Before attaching the FEA, clean the area where the suction cups will be mounted with the supplied alcohol swab. The FEA wire between the two suction cups should be pulled taut and as straight as possible, and should not obstruct the driver's view.

For vehicles with A and B type FM antennas:

- Whip/aerial mounted on the front fender or hood
- Whip/aerial mounted in the A-pillar of car frame

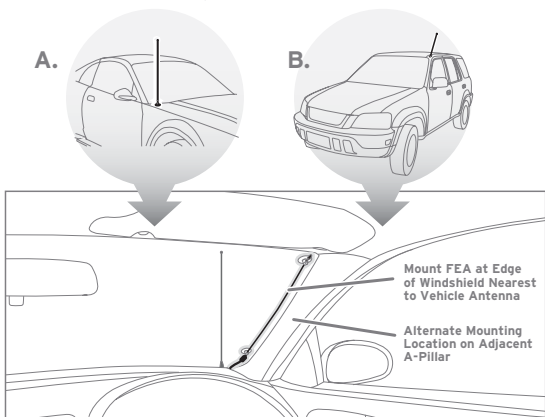

Figure 32

Mount the FEA vertically on the front windshield at the edge of the glass, on the same side as the vehicle's antenna (i.e. nearest to the antenna). See *Figure 32*. Clean the suction cup mounting areas with the alcohol swab. The FEA wire between the two suction cups should be pulled taut, and as straight as possible, and should not obstruct the driver's view.



Caution: In some states it may not be legal to put the FEA on the windshield glass. In this case, the FEA should be mounted on the A-Pillar adjacent to the vehicle's FM antenna.

For vehicles with C and D type FM antennas:

- In-glass, in the rear windshield
- Whip/aerial mounted on rear part of roof

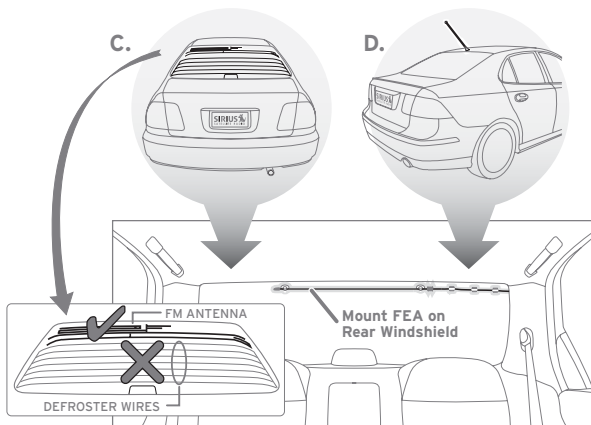

Figure 33

Mount the FEA horizontally along the top edge of the rear windshield (see Figure 33). For vehicles with a rooftop antenna, center the FEA below the antenna whip. For vehicles with an in-glass antenna, the FEA should be directly over one of the FM antenna's wires.

Note: Do not install the FEA over the defroster wires (see inset on Figure 33). Clean the suction cup mounting areas with the alcohol swab. The FEA wire between the two suction cups should be pulled taut, and as straight as possible, and should not obstruct the driver's view.

For vehicles with an E type FM antenna:

- Whip/aerial mounted on the rear fender or trunk

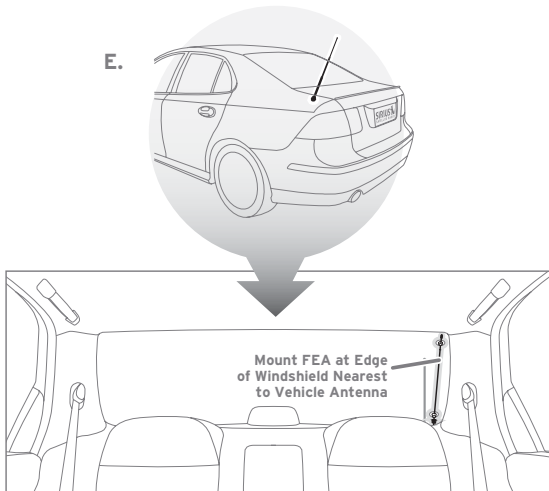

Figure 34

Mount the FEA vertically on the rear windshield at the edge of the glass, on the same side as the vehicle's antenna (i.e. nearest to the antenna). See *Figure 34*. Clean the suction cup mounting areas with the alcohol swab. The FEA wire between the two suction cups should be pulled taut, and as straight as possible, and should not obstruct the driver's view.

For vehicles with F or G type FM antennas:

- Whip/aerial mounted on the front part of roof
- In-glass, in the front windshield

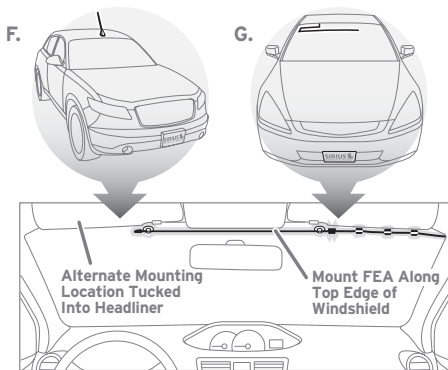

Figure 35

Mount the FEA horizontally along the top edge of the front windshield or install it into the headliner of the vehicle just above the front windshield (see *Figure 35*). For vehicles with a rooftop antenna, center the FEA below the antenna whip. For vehicles with an in-glass antenna, the FEA should be directly over the antenna wire itself. Clean the suction cup mounting areas with the alcohol swab. The FEA wire between the two suction cups should be pulled taut, and as straight as possible, and should not obstruct the driver's view.



Caution: In some states it may not be legal to put the FEA on the windshield, glass, so the FEA should be installed into the headliner. Remove the suction cups and tuck the wire into the headliner, stretched taut and straight.

For vehicles with an H type FM antenna:

- In-glass, in a rear side window

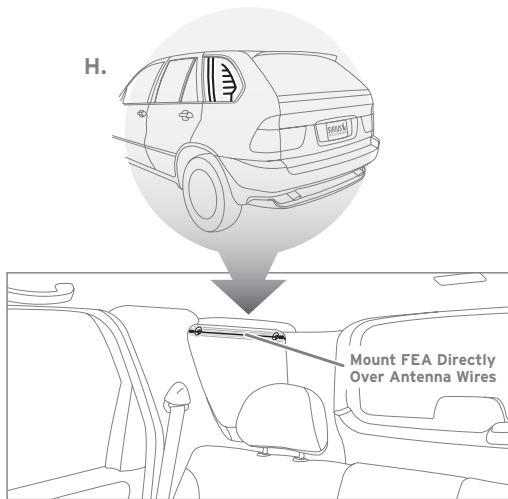

Figure 36

Mount the FEA directly over the in-glass antenna wires. If the antenna wires are vertical, mount the FEA vertically on the glass; if the in-glass antenna wires are horizontal, mount the FEA horizontally on the glass. (See *Figure 36*.) Clean the suction cup mounting areas with the alcohol swab. The FEA wire between the two suction cups should be pulled taut, and as straight as possible, and should not obstruct the driver's view.

Step 4: Temporarily plug the FEA into the Vehicle Dock's FM Out connector

See Figure 37.

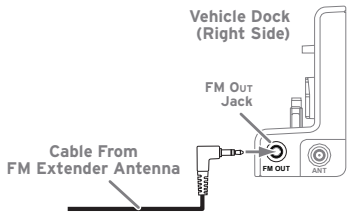

Figure 37

Step 5: Tune your vehicle's FM radio to a channel that's not being used in your area

Use your vehicle radio's *Tune* function (not the *Scan* function) to find an FM channel (between 88.1MHz and 107.9MHz) that is not broadcasting in your area. If you're not sure which FM channels are not broadcasting in your home or travel cities, you can also go to <http://sirius.com/fmchannel> and search for a suggested FM channel based on your zip code.

- Once you have located an FM channel that is not broadcasting in your area, save it as a preset on your vehicle radio. This will become your SIRIUS preset.

Step 6: Set Your Starmate ST5's FM transmitter to the same FM channel

- a. Dock your Starmate ST5 and turn its power **ON**. Wait for the *Channel Update* to finish before pressing any buttons.
- b. Press and hold the FM Presets button (see Figure 38, opposite). The FM PRESETS screen will appear, with FM1 highlighted. FM1 is factory-set to 88.1MHz. This may not be the best frequency for your area (see Figure 39, opposite).

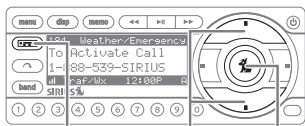

FM PRESETS Button Channel UP/DOWN Buttons SELECT Button

Figure 38

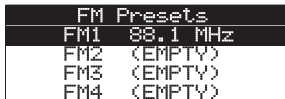

Figure 39

- c. Press the Select button. The FM1 frequency screen will appear (see *Figure 40*).
- d. Use the Channel UP/DOWN buttons to highlight the FM frequency that matches the channel that you preset on your vehicle radio in *Step 5*, on page 58, then press the Select button to select it (see *Figure 41*).

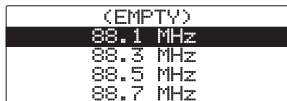

Figure 40

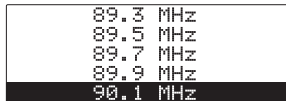

Figure 41

- e. Turn your vehicle's FM radio **ON** and press the SIRIUS preset you set in *Step 5*, on page 56. You should now hear the audio from your Starmate ST5 over your vehicle's FM radio (see *Figure 42*).

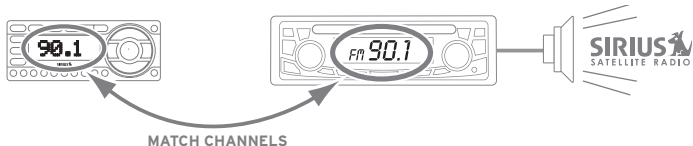

Figure 42

Step 7: Optimize the placement of the FEA

1. Mute the volume of your Starmate ST5. The easiest way to do this is to use the MUTE button on the remote control (see pages 66 - 69). You can also press the MENU button on the ST5 unit, select SETTINGS, then select AUDIO LEVEL and turn the volume down to zero. (See page 103.) Note, your SIRIUS radio is still **ON**.
2. Turn up the volume of your vehicle's FM radio. If you hear static or interference adjust the position of the FEA until the static or interference is eliminated or minimized (see *Figure 43*).

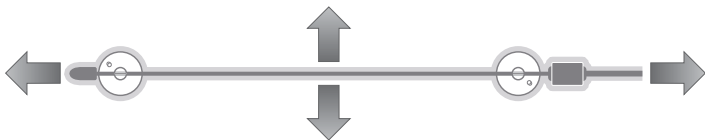

Figure 43

3. If the level of static or interference is still high, please select another FM channel by repeating *Steps 5 & 6*, on pages 58 - 59

Step 8: Permanently install the FEA

NOTE: IF YOU ARE MOUNTING THE FEA IN THE VEHICLE'S HEADLINER, SKIP THIS STEP.

When you are satisfied with the FEA's mounting location, remove the suction cup mounts and peel the backing off the bead and arrow adhesive mounts. Clean the area where the FEA will be attached with the alcohol swab. Permanently adhere the FEA in the same position on the glass (or A-pillar), making certain the wire is taut and is as straight as possible (see *Figure 44*). If necessary, use the cable guides to hold the cable.

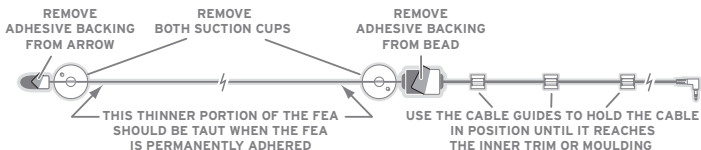

Figure 44

Step 9: Route and hide the cable through the vehicle to the Vehicle Dock

Hide the FEA cable by properly routing it to your SIRIUS Vehicle Dock (see *Figure 45*). Use the cable guides to hold the cable in place until it reaches the inner trim or moulding at the edge of the window. Take advantage of any existing cable channel or wiring conduit and route the cable around the passenger compartment to the Vehicle Dock. Take care not pull the cable across sharp edges that could damage it, and keep it away from areas where it might entangle feet. Coil and secure any excess antenna cable in a location where it can be hidden and secured (such as under the carpet or floor mat).

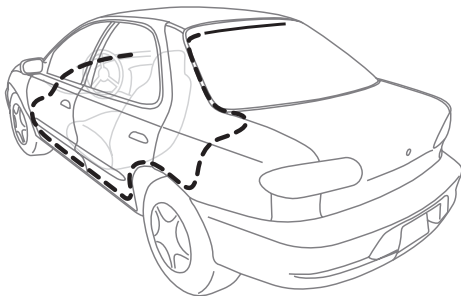

Figure 45

Plug the FEA cable into the Vehicle Dock's FM OUT connector (see *Figure 37*, on page 58).

Tip**Tips for Identifying the FM Antenna**

Correctly identifying your vehicle's FM antenna is a key to successfully installing the FEA. The preceding installation section already showed you the different kinds of FM antennas found on vehicles. However, there are several types of antennas found on vehicles that you may at first believe to be the FM antenna but which in reality are not. Instead they may actually be GPS, OnStar®, cell phone, factory-installed satellite radio antennas, or another type of antenna.

Please be aware of the following when identifying your vehicle's FM antenna:

- Puck-type antennas and shark-fin type antennas are **never** the FM antenna. *Figure 46* shows several types of these antennas which should not be mistaken for an FM antenna. If you have located one of these types of antennas on your vehicle you can be certain that it's not the FM antenna. Continue your search to find the actual FM antenna.

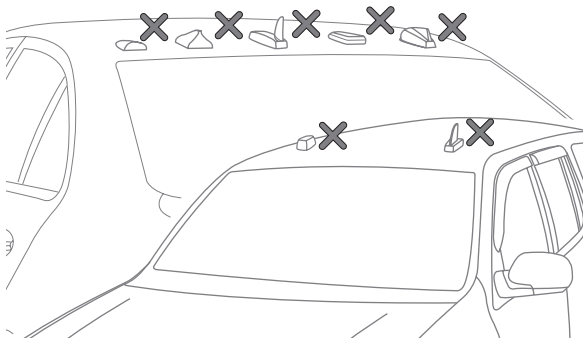

Figure 46

- Greater confusion may arise with whip type antennas. *Figure 47* shows some whip type antennas which can be found on the front or rear of a vehicle's roof, or on the rear windshield. Some of these antennas could be the FM antenna and some are not the FM antenna.

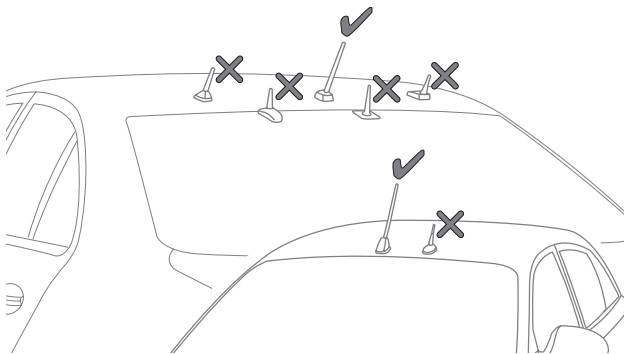

Figure 47

- Antennas with a short 2-4 inch stubby whip or protrusion are **not** FM antennas, while antennas with a whip length of 7 inches or longer are likely to be the FM antenna. If your vehicle has a short stubby antenna, you should continue searching your vehicle's FM antenna.

If after searching your vehicle you're still uncertain as to where its FM antenna is located then SIRIUS recommends professional installation of the FM Extender Antenna. Ask your SIRIUS retailer if they provide professional installation services, or can recommend a professional installer.

If you don't correctly identify your vehicle's FM antenna, the installation of the FEA will result in poor performance and unsatisfactory results.

Subscribing to the SIRIUS Service

Before you can listen to the SIRIUS service, you need to subscribe to the SIRIUS Satellite Radio service. To subscribe, do the following:

1. Be sure that your SIRIUS Starmate ST5 is correctly installed, is properly docked in the Vehicle Dock, and that the antenna is oriented to receive the SIRIUS signal.
2. Turn on the ST5. After the startup sequence, it will update the SIRIUS channel line-up (see *Figure 48*). Wait until the channel updates have completed before pressing any buttons.
3. Once the channels have been updated, the ST5 will automatically tune to channel 184 and the display will change to *To Activate Call 1-888-539-SIRIUS* (see *Figure 49*). You will not be able to listen to any other channels until you activate your SIRIUS subscription.
4. To display your Starmate ST5's SIRIUS ID (SID) number, tune to channel 0 by pressing the SELECT button, then the 0 (zero) button, and then the SELECT button again (see *Figure 50*). The SID number is also available on your ST5's packaging. Write the SID number down.
5. Have your credit card handy and contact SIRIUS on the Internet at home.sirius.com/. You can also call SIRIUS toll-free at: 1-888-539-SIRIUS.
6. When you have successfully subscribed to the SIRIUS service an alert will be displayed (see *Figure 51*). To continue, press any button on the front panel.

You are now ready to begin enjoying SIRIUS Satellite Radio's digital entertainment, and can tune to other channels!

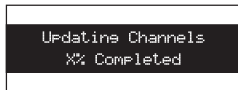

Figure 48



Figure 49

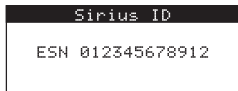

Figure 50



Figure 51

Controls

Starmate ST5 Front Panel

Figure 52 and the section following identify and describe your SIRIUS Starmate ST5's buttons and controls.

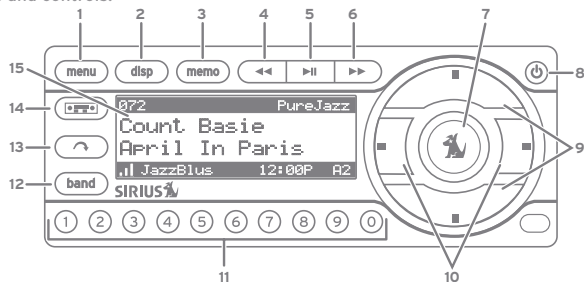

Figure 52

- 1. Menu Button:** Accesses Menu options to make setup and feature changes.
- 2. Display (DISP) Button:** Toggles the Default display screen between the normal display mode and large text display mode (see page 76). Pressing and holding switches the display to the My CHANNELS screen (see page 75).
- 3. Memory (MEMO) Button (S-Seek Function):** Saves and recalls artist names, song titles, and sports teams. You can store up to 30 artist/song title combinations, including your favorite sports teams/cars and traffic channels. Pressing and holding the MEMO button will enter the recall mode, displaying the stored information.

- 4. Rewind Button:** Rewinds through a broadcast saved in SIRIUS Replay.
- 5. Play/Pause Button:** Pauses and replays live or time-shifted content from the currently tuned channel. Pressing and holding this button displays the list of content saved in SIRIUS Replay.
- 6. Fast-Forward Button:** Fast-forwards through a broadcast saved in SIRIUS Replay.
- 7. Select Button:** Selects items highlighted on the display screen. When the Default screen is displayed, a press-and-release of the SELECT button will display a prompt to enter a channel number. Pressing and holding will return to the last channel played.
- 8. Power Button:** Turns the ST5 **ON** and **OFF**.
- 9. Channel Up/Down Buttons:** Navigate through channels and display screens, and highlight items on the display.
- 10. Category < / > Buttons:** Navigate through the Category List screens, which display SIRIUS channel categories. Pressing and holding the buttons provides a shortcut for adjusting the display's brightness without having to enter the Menu Options (see page 96).
- 11. Preset Number Buttons (0 - 9):** Set and select preset channels. Also used to directly tune channels by entering the channel number.
- 12. BAND Button:** Pressing and releasing this button switches between preset banks A, B, and C, which hold 10 presets each for a total of 30. Pressing and holding this button switches to the MY PRESETS category, which lets you see what artists and songs are playing on each of your stored presets.
- 13. Jump Button:** Quickly switches between the current channel and a favorite (or frequently-accessed) channel.
- 14. FM Presets Button:** Selects between different preset frequencies used by the built-in wireless FM transmitter.
- 15. LCD Display Screen:** Provides information about the ST5's operation, the program that is playing and other programming that is available.

Starmate ST5 Remote Control Buttons

Figure 53 and the section following identify the buttons of your ST5's remote control.

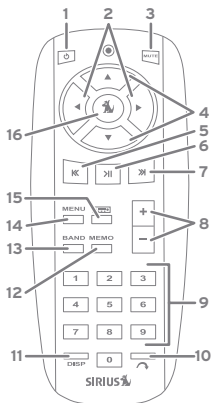

Figure 53

- 1. Power Button:** Turns the ST5 **ON** and **OFF**.
- 2. Category </> Buttons:** Navigate through the Category List screens, which display SIRIUS channel categories. Pressing and holding the buttons provides a shortcut for adjusting the display's brightness without having to enter the Menu Options (see page 96).
- 3. MUTE Button:** Mutes the audio. When the ST5 is muted an icon appears in the lower-left corner of the display, replacing the Band/Preset Bank Number indicator.

- 4. Channel Up/Down Buttons:** Navigate through channels and display screens, and highlight items on the display.
- 5. Rewind Button:** Rewinds through a broadcast saved in SIRIUS Replay.
- 6. Play/Pause Button:** Pauses and replays live or time-shifted content from the currently tuned channel. Pressing and holding this button displays the list of content saved in SIRIUS Replay.
- 7. Fast-Forward Button:** Fast-forwards through a broadcast saved in SIRIUS Replay.
- 8. Volume +/- Buttons:** Adjusts the audio volume up & down.
- 9. Number Buttons (0 - 9):** Set and select preset channels. Also used to directly tune channels by entering the channel number.
- 10. Jump Button:** Quickly switches between the current channel and a favorite (or frequently-accessed) channel.
- 11. DISP (Display) Button:** Toggles the Default display screen between the normal display mode and large text display mode (see page 76). Pressing and holding switches the display to the MY CHANNELS screen (see page 75).
- 12. Memory (MEMO) Button (S-Seek Function):** Saves and recalls artist names, song titles, and sports teams. You can store up to 30 artist/song title combinations, including your favorite sports teams/cars and traffic channels. Pressing and holding the MEMO button will enter the recall mode, displaying the stored information.
- 13. BAND Button:** Pressing and releasing switches between the five preset banks (A, B, C), which hold ten presets each. Pressing and holding this button switches to the MY PRESETS category, which lets you see what artists and songs are playing on each of your stored presets.
- 14. MENU Button:** Accesses Menu options to make setup and feature changes.
- 15. FM Presets Button:** Selects between preset FM frequencies used for the ST5's built-in wireless transmitter.
- 16. Select Button:** Selects items highlighted on the display screen. When the Default Screen is displayed, a press-and-release of the Select button will display a prompt to enter a channel number. Pressing and holding will return to the last channel played.

Remote Control Battery Installation

To install the remote control battery, turn the remote control over and locate the battery cover near the bottom edge. Open the battery compartment and place the battery in the compartment with the + side of the battery facing up. Replace the battery cover on the remote control. See *Figure 54*.

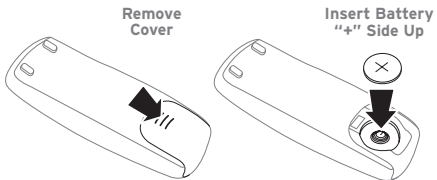

Figure 54

Vehicle Dock Reference Guide

Figure 55 and the section following identify and describe the controls and connectors of the vehicle dock.

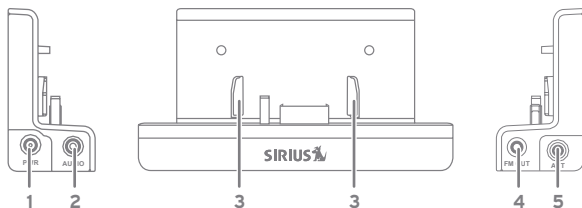

Figure 55

- 1. Power (PWR) Connector:** Power connection for the supplied cigarette lighter adapter (see page 37).
- 2. Audio Out (AUDIO) Connector:** Audio output for directly connecting to your vehicle's audio system (see pages 41 & 43).
- 3. Docking Rails:** Fit-into slots in the back of the ST5 to secure it while it is docked (see page 40).
- 4. FM Out Connector:** FM output for use with the optional FM Direct Adapter (see page 42).
- 5. Antenna (ANT) Connector:** Connection for the supplied magnetic antenna (see page 36).

Operation

Display Screen Information

Your SIRIUS Starmate ST5's 5-line LCD display screen provides information about the operation of the radio, such as the currently-tuned channel, song or show being played, artist name, time and other information. This screen is referred to as the *Default* screen in this manual. *Figure 56* identifies the information displayed on the Default screen when listening to a typical broadcast.



Figure 56

Whenever you power your ST5 **ON**, the previously-selected channel will automatically begin playing, and the currently-playing artist name and song title will be displayed.

Changing Channels and Categories

Pressing the Channel UP or DOWN button will immediately tune to the next or previous subscribed channel.

Pressing the Category < or > button once will display a list of the subscribed channels in the current category, highlighting the currently-tuned channel (see *Figure 57*). This is the *Category List* mode.

Pop	
005	Sirius Gold
006	'60s Vibrations
007	Totally '70s
008	Bis '80s

Figure 57

Pressing the Category < or > button again will display a listing of the previous or next channel category.

If you repeatedly press the DISP button while in the Category List mode, the display will sequence between listings of currently-playing artist names, song titles, and back to channel names within the current category (see *Figure 58*).

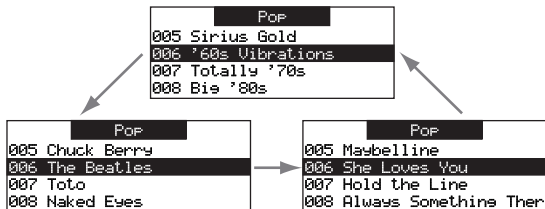

Figure 58

Use the Channel UP/DOWN buttons to highlight a channel within a category and press the Select button to tune to the highlighted channel. When you tune to a new channel, the display will revert to the Default screen for the new channel.

To exit the Category List mode without changing to a different channel, press-and-hold the DISP button for at least 1 second until the Default screen is displayed.

My Channels Category

The first category displayed in the Category List mode is a My Channels category (see *Figure 59*) that will show all of the channels contained in your SIRIUS subscription plan. The category heading bar will show the total number of channels your Starmate ST5 is subscribed to.



Figure 59

Use the Channel UP/DOWN buttons to highlight a channel and press the Select button to listen to the highlighted channel.

- Channels that have been locked using the Parental Control feature (see page 104) will be displayed with a padlock icon next to the channel name.
- If you try to tune to an unsubscribed channel the ST5 will display a “Channel Unsubscribed” message.
- The ST5 will not display channel information for any unsubscribed or locked channels.
- The Memory and Song Seek functions (see page 77) will only occur on subscribed channels.
- All of the Category List screens and Channel List screens (see page 73) will only display subscribed channels that have not been locked using Parental Control.

For information about your SIRIUS subscription, go to **home.sirius.com**.

Display (DISP) Button

Pressing and holding the DISP button for 1+ seconds will also activate the MY CHANNELS screen (see page 74). The MY CHANNELS screen makes it easy to quickly search for and locate music on any of your subscribed channels by channel, by artist, and by song title.

When the MY CHANNELS screen is active, the ST5 displays a listing of all your subscribed channel numbers and names. Repeated momentary pressing and releasing of the DISP button will sequence the display between listings of artist names, song titles, and back to channel names (see *Figure 60*). For sports channels, pressing the DISP button will toggle between the team/driver names and the current score of any live play-by-play game or the standings in a race being run.

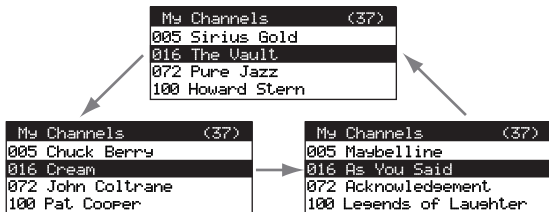

Figure 60

Use the Channel UP/DOWN buttons to scroll through the available subscribed channels. Press the Select button to tune to the highlighted channel. The new channel will begin playing and the display will revert to the Default screen for the new channel.

To exit the MY CHANNELS screen without changing to a different channel, press and hold the DISP button for 1+ seconds, until the Default screen is displayed.

Changing the Display

Momentarily pressing the DISP button while the Default screen is displayed changes the artist name and song title to a scrolling, single-line, large-format display for easier viewing from a distance (see *Figure 61*).



Figure 61

Selecting Channels Directly (Direct Tuning)

You can directly tune to any channel by entering the channel number using the 0 - 9 Number buttons. To enter a channel number, momentarily press and release the Select button. At the display prompt (*Figure 62*) enter the three-digit channel number.



Figure 62

Channel Presets (BAND Button)

You can store up to 30 of your favorite channels as presets for quick access with the press of a button.

Storing Channel Presets

Presets are stored in three banks (A, B and C), each containing ten channel presets:

1. Momentarily press and release the BAND button until the desired preset bank, A, B, or C, is displayed in the lower right corner of the default display screen.
2. Tune to the channel you wish to store as a preset (see *Changing Channels and Categories*, on page 73).
3. Press and hold the Number button in which you wish to store your favorite channel for 1+ seconds until you hear a beep. The screen will confirm that the channel has been stored (*Figure 63*), and the band and preset number will then be displayed in the lower-right corner of the display screen.



Figure 63

NOTE: IF THE NUMBER BUTTON ALREADY HAS A PRESET CHANNEL STORED IN IT, THE PRESET WILL BE REPLACED BY THE NEWLY-STORED CHANNEL.

Recalling Channel Presets

The 10 presets in the active bank (A, B, or C) can be selected by pressing the 0 - 9 buttons.

1. Press the **BAND** button to activate the preset bank you want. The selected bank is shown in the lower-right corner of the default display screen. The ST5 will tune to the last-tuned preset in the selected bank.
2. Press the desired preset button 0 - 9 to tune to a different preset in the bank. The channel will change and the display will revert to the Default screen for the new channel, with the preset bank and number shown in the lower-right corner.

Pressing and holding the **BAND** button displays the **MY PRESETS** screen (see below).

My Presets Screen

You can use the Channel UP/DOWN buttons to quickly see what's playing on all of your presets:

1. Press and hold the **BAND** button to activate the **MY PRESETS** screen (see *Figure 64*).



Figure 64

2. Use the Channel UP/DOWN buttons to scroll through the presets. When the preset you want to listen-to is highlighted, press the **Select** button to listen to it. Pressing the Channel UP/DOWN buttons will cycle through all of the stored presets by preset bank and number (for example, A1, A2...B1, B2...C1, C2...). Pressing the Channel UP/DOWN buttons after the last stored preset is displayed will return back to the first stored preset.

While the MY PRESETS screen is active, pressing the DISP button will cycle the channel information on the screen between channel names, artist names, composer names (if available) and song title (see *Figure 65*).

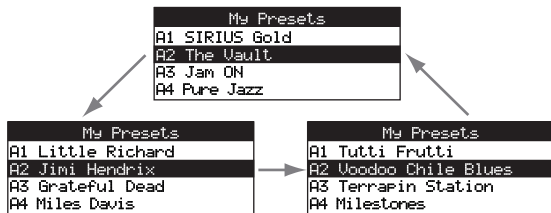

Figure 65

To exit the MY PRESETS screen and return to Default display screen, press and hold the BAND button for 1+ seconds.

Memory (MEMO) and Song Seek (S-Seek) Functions

This feature allows you to capture and store information in the ST5's memory about the currently tuned programming – artist, song, or sports team/NASCAR car. The ST5 then continuously searches all subscribed SIRIUS channels and alerts you when a program currently being played matches one stored in memory (see *Figure 66*). A total of 30 artists and songs, plus one sports team/car may be stored in memory.



Figure 66

If you have saved a sports team or car in memory, when you initially power your ST5 on you will be alerted if your sports team/car are playing/racing in a game/race being broadcast. Also, you will be alerted should your team/car begin playing/racing while you're listening to your Starmate ST5.

Storing Artist Names, Song Titles, and Sports Teams to Memory

If you are listening to a song, entertainment channel, or a sports team, and wish to save the artist, song, or sports team selection to memory for future S-Seek alerts, do the following:

- 1. For Artist Names or Song Titles:** If the currently-tuned channel is a music or entertainment channel, momentarily press and release the MEMO button. The ST5 will display a menu to choose to store either the artist name or the song title (see *Figure 67*).



Figure 67

If either the artist name or song title is not available to save, the choice will be displayed as unavailable (see *Figure 68*).



Figure 68

Using the Channel UP/DOWN buttons, choose STORE ARTIST or STORE SONG (when available) and press the Select button to save the selection to memory. If both the artist and song are available to save, you will be prompted again to save whichever one you haven't yet saved (see *Figure 69*).



Figure 69

- 2. For Sports Teams:** If the currently-tuned channel is a sports broadcast, momentarily press and release the MEMO button. The ST5 will display a menu to choose which sports team or NASCAR car should be saved to memory (see *Figure 70*).



Figure 70

If any of the teams/cars is not available to save, that team/car will be displayed as unavailable (see *Figure 71*).



Figure 71

Using the Channel UP/DOWN buttons, choose the desired sports team (when available) and press the Select button to save the current selection to memory.

3. To ensure that no duplicate entries are stored in memory, the ST5 will check the stored memory list to ensure that the alert about to be stored is not already stored in memory. If a duplicate entry is found, an UNABLE TO STORE screen will be displayed for 1 second. The screen will then revert to the last active display mode.
4. If the new alert was successfully stored in memory, an ARTIST/SONG STORED pop-up screen followed by an X USED/Y EMPTY screen will be displayed for 1 and 2 seconds respectively. X is the total number of listings stored in memory, and Y is the total number of memory listings still available for storage (see *Figure 72*).



Figure 72

5. If all of the memory spaces are full when you press the MEMO button, a MEMORY FULL screen will be displayed for 1 second (see *Figure 73*).



Figure 73

The ST5 will then display a REPLACE - CANCEL screen, which will allow you to choose whether to replace an existing alert stored in memory, or to cancel storing the alert to memory (see *Figure 74*, opposite).



Figure 74

Use the Channel UP/DOWN buttons to choose whether to replace an existing alert or cancel saving the alert to memory. If you cancel saving the alert, the radio will revert to the last active display mode. If you have chosen to replace an existing alert, a listing of all the alerts stored in memory will be displayed (see *Figure 75*).



Figure 75

Use the Channel UP/DOWN buttons to highlight the alert that you would like to overwrite and press the Select button to store the new alert. If the new alert was successfully saved in memory, an ARTIST/SONG STORED pop-up screen followed by an X USED/Y EMPTY screen will be displayed for 1 and 2 seconds respectively (see *Figure 76*).

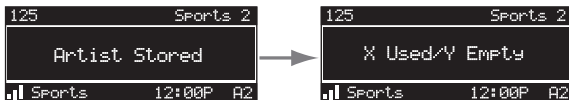

Figure 76

X is the total number of listings stored in memory, and Y is the total number of memory listings still available for storage. The screen will then revert to the last active display mode.

Viewing Stored Alerts Stored in Memory

To view all the alerts you have saved to memory, press and hold the MEMO button for 1+ seconds to enter the S-Seek mode. The alerts stored in memory will be displayed one-at-a-time in page format (see *Figure 77*). Use the Channel UP/DOWN buttons to scroll through the listings. This function allows you to review previously stored program information.

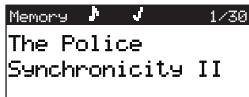

Figure 77

To Activate, Cancel or Delete an Alert:

1. Press and hold the MEMO button for 1+ seconds to enter the S-Seek mode, then use the Channel UP/DOWN buttons to find the alert which you wish to activate, cancel or delete.
2. Press the Select button. The MEMORY RECALL screen will appear (see *Figure 78*).



Figure 78

3. Use the Channel UP/DOWN buttons to highlight the option you want for that particular alert, and press the Select button. If you select DELETE, a DELETE CONFIRMATION screen will appear. To permanently delete the alert from the memory list, highlight and select Yes.

- An ARTIST DELETED pop-up screen followed by an X Used/Y EMPTY screen will be displayed for 1 and 2 seconds respectively (see *Figure 79*) X is the total number of listings saved in memory, and Y is the total number of memory listings still available for storage. The screen will then revert to the last active display mode.



Figure 79

When the S-Seek option is enabled, whenever the ST5 is turned on, it automatically searches the incoming channels to determine if a match exists with the program information stored in the S-Seek memory. If one or more matches are found, a pop-up screen momentarily appears for 2 seconds and displays S-SEEK ALERT (see *Figure 80*). You will also hear an audible beep tone, indicating that a match was found.



Figure 80

The ST5 then displays the SIRIUS SEEK LIST screen, which displays a list of the current matches (see *Figure 81*). No alert is provided for the currently-tuned channel.

Sirius Seek List	
072	John Coltrane/Equinox
016	Cream
123	Trojans @ UCLA

Figure 81

Use the Channel UP/DOWN buttons to highlight the artist, song, or sports event that you wish to listen to, and then press the Select button to tune to it. If you don't make a selection within 10 seconds, the ST5 will revert to the last active display mode. Note that the currently-tuned channel will continue to play until you make a new selection from the S-SEEK list.

Jump Button

Your Starmate ST5 has a special preset button called the *Jump* button that lets you quickly tune to a channel that you want to access frequently, such as a traffic channel or a sports channel. Pressing the Jump button 'jumps' to the specific channel you have programmed into the Jump button; pressing the Jump button again 'jumps' back to your original channel. (Refer to *Jump Settings*, on page 100 for instructions for configuring the Jump button.)

Traffic channel: If you have set the Jump button to the TRAFFIC option, pressing it will immediately begin a search for the traffic report of the specific city you have designated. The Jump icon will be displayed in the lower right corner of the display screen to indicate that a Jump search is active (see *Figure 82*).



Figure 82

The search process may take up to 4 minutes until the ST5 finds the city's traffic report. Once the traffic report is found the ST5 will automatically tune to the traffic report channel (see *Figure 83*).



Figure 83

Pressing the Jump button again while the ST5 is actively searching for a traffic report will cancel the search.

Pressing the Jump button after the ST5 has tuned to the traffic report channel will return you to the previous channel.

Other channel: If you've set the Jump button to the JUMPSET option, pressing the Jump button will immediately tune to the channel you preset into the JUMPSET. The Jump icon will be displayed in the lower right corner of the display screen to indicate that the Jump preset channel is currently tuned (see *Figure 84*).



Figure 84

Pressing the Jump button again will return to the previous channel.

NOTE: THE CHANNEL PRESET FOR THE JUMP BUTTON REMAINS THE SAME REGARDLESS OF WHICH PRESET MEMORY BANK IS CURRENTLY SELECTED.

SIRIUS Replay

Your Starmate ST5 automatically stores the audio of the channel you're listening to for later playback. Approximately 30 to 60 minutes of audio (depending upon the channel to which you are tuned) is stored. As soon as you tune to a channel, the ST5 automatically begins storing the audio, enabling you to rewind at any time to replay the audio again.

Pause/Play Button ►||: Places the ST5 in the SIRIUS Replay pause mode, which mutes the audio. The ST5 will then display a PAUSED message for two seconds to confirm that it has entered the SIRIUS Replay mode (see *Figure 85*).



Figure 85

To listen to the audio that was stored, press the Pause/Play button again and the ST5 will begin to play back the audio stored in the SIRIUS Replay memory from the point where you pressed the Pause/Play button. During SIRIUS Replay playback, the ST5 continues to store the channel's live audio.

- Pressing-and-holding the Pause/Play button changes the display to a listing of the artist's names in the stored audio (see *Figure 86*, left), listed from the most recent to the oldest, beginning with an entry called "<<LIVE>>". (Pressing the Disp button will toggle the display between the artist name list and the song/program title list. See *Figure 86*, right.)



Figure 86

Select an item from the list and the playback will commence from that point in the stored audio. If you select “<<Live>>” the ST5 will exit the SIRIUS Replay mode and resume playing the live broadcast.

NOTE: IF YOU TUNE THE ST5 TO ANOTHER CHANNEL WHILE IN THE SIRIUS REPLAY MODE, THE SIRIUS REPLAY MODE IS EXITED, ALL THE AUDIO STORED IN THE SIRIUS REPLAY MEMORY IS ERASED, AND THE NEWLY-TUNED CHANNEL BEGINS TO PLAY. ALSO NOTE THAT TUNING TO ANOTHER CHANNEL MAY OCCUR AUTOMATICALLY IF ANOTHER FEATURE OF THE ST5 HAS BEEN PROGRAMMED TO DO SO.

Fast-Forward Button ►►: The Fast-Forward button moves you forward through the stored audio.

- Pressing-and-releasing the Fast-Forward button forwards to the start of the next song or program in the stored audio and playback automatically begins from there. Repeatedly pressing and releasing the Fast-Forward button continues to move forward in the stored audio to the starts of each song or program until the end of the stored audio is reached. When you reach the end of the stored audio you will hear a beep (if the Confirmation Tone option is enabled, see page 101), the ST5 will exit the SIRIUS Replay mode and resume playing the live broadcast.
- Pressing-and-holding the Fast-Forward button for one second advances the playback forward in 10 second intervals, which increases to 15 and then 30 second intervals the longer the Fast-Forward button remains pressed. Playback begins immediately when you release the button. When you reach the end of the stored audio you will hear a beep, the SIRIUS Replay mode will be exited, and the ST5 will resume playing the live broadcast.

Rewind Button ◀◀: The Rewind button moves you backwards through the stored audio.

- Pressing-and-releasing the Rewind button rewinds to the start of the current song or program in the stored audio, and playback automatically begins. Repeatedly pressing and releasing the Rewind button continues to move backwards in the stored audio to the start of each previous song or program until the beginning of the stored audio is reached. If you reach the beginning of the stored audio you will hear a beep (if the Confirmation Tone option is enabled, see page 101) and playback will automatically begin.

- Pressing-and-holding the Rewind button for one second rewinds playback in 10 second intervals, which increase to 15 and then 30 second intervals the longer the Rewind button remains pressed. Playback begins immediately when you release the button. If you reach the beginning of the stored audio while rewinding, you will hear a beep and playback will automatically begin.

NOTE: DEPENDING UPON WHERE IN A PARTICULAR BROADCAST THE CHANNEL WAS SELECTED, THE START OF A SONG OR PROGRAM MAY NOT BE AVAILABLE IN SIRIUS REPLAY MEMORY. IF THIS OCCURS, THE PLAYBACK WILL START FROM WHERE THE AUDIO BEGAN TO BE STORED.

Using SIRIUS Replay

When the SIRIUS Replay mode is active, status information is shown at the bottom of the display screen (see *Figure 87*).

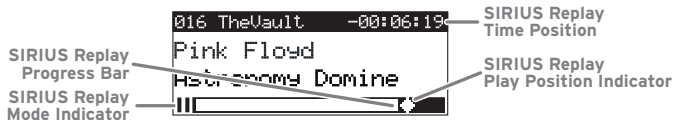

Figure 87

The Progress Bar shows how much of the SIRIUS Replay memory has been used and how much remains. A diamond-shaped Play Position indicator is superimposed over the Progress Bar, providing a visual indicator of the current playback position in the SIRIUS Replay memory. Icons displayed at the bottom left of the screen indicate the current SIRIUS Replay mode:

|| Pause mode: The ST5 is paused and muted.

▶ Play mode: You are listening to stored audio in the SIRIUS Replay playback mode.

▶▶ Fast-Forward mode: You are fast-forwarding through the stored SIRIUS Replay audio.

◀◀ Rewind mode: You are rewinding through the stored SIRIUS Replay audio.

The Progress Bar is a visual indicator of the status of the SIRIUS Replay memory (see *Figure 88*). As the memory fills, Progress Bar begins to fill from the right side providing a visual indication of how much of the SIRIUS Replay memory is filled. The end of the bar indicates the end of the stored audio, where the live broadcast begins. When all available memory has been used, the bar will be completely filled.

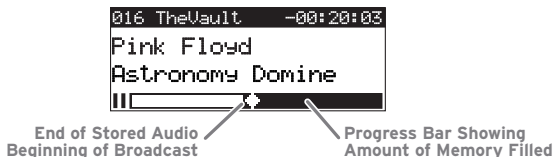

Figure 88

The Play Position indicator shows your current listening position in the stored audio. When you press the Pause/Play button to begin playback of the stored audio, this indicator will begin to move to the left showing the progression of the playback through the SIRIUS Replay memory – provided that the memory is not full (see *Figure 89*).

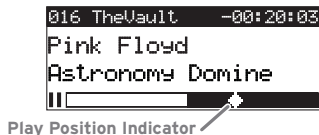

Figure 89

If you press the Pause/Play button to stop the playback, the play position indicator will stop moving and continue to provide a visual indication of your current position in the SIRIUS Replay memory.

The portion of the Progress Bar to the right of the Play Position indicator shows how much you can rewind in the SIRIUS Replay memory, while the filled portion to the left of the Play Position Indicator shows how much you can fast-forward in the memory.

While you are in the playback mode, the ST5 continues to store the audio from the channel. Obviously, you will be unable to “catch up” to the live broadcast during playback, as new audio is being stored at the same rate at which you are playing-back the stored audio. You can use the FAST-FORWARD button to skip ahead or exit the SIRIUS Replay mode, and begin listening to the live broadcast again.

When the SIRIUS Replay memory is 10 seconds from becoming full you will hear two beeps (if the Confirmation Tone option is enabled, see page 103). When the memory is full, the ST5 will automatically begin to play the SIRIUS Replay memory contents from the beginning, and will continue to store the channel audio, overwriting the oldest portion of the audio previously stored. When the memory is full, you will be unable to rewind through the stored audio.

If you have partially played-back the stored audio, and have paused the radio again, the Play Position indicator will begin to move right when the SIRIUS Replay memory becomes full, as it begins overwriting the oldest portion of the audio previously stored. When the Play Position indicator reaches the rightmost position, indicating that the memory is full, the ST5 will automatically begin to play the SIRIUS Replay memory contents from the beginning.

The SIRIUS Replay Time Position shows the exact amount of time the Play Position indicator is behind the live broadcast, expressed as Hours:Minutes:Seconds, and displayed as a negative number (see *Figure 90*). For example, if -00:20:03 is displayed, the Play Position indicator is 20 minutes and 3 seconds behind the live broadcast.



Figure 90

FM Presets Button

If you are using a wireless connection between your Starmate ST5 and your vehicle's audio system (see page 44), the FM Presets button makes it easy for you to select between the five different FM transmitter preset frequencies. It also makes it easy for you to select new FM transmitter preset frequencies without having to go through the Menu Options (see page 96).

If the FM transmitter is set to OFF when you press the FM Presets button, the FM TRANSMITTER ON screen will be displayed (see *Figure 91*). Select YES to turn the transmitter ON.

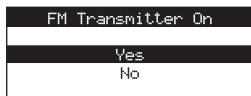

Figure 91

After you select YES, the FM PRESETS list will be displayed (see *Figure 92*, left). If you haven't set any of the FM preset frequencies, FM1 is factory-set to 88.1MHz; FM2 - FM5 will be EMPTY.



Figure 92

Use the Channel UP/DOWN buttons to highlight the preset you wish to change, and press the Select button to choose the preset. The FM frequency screen will appear (see *Figure 92*, right).

Use the Channel UP/DOWN buttons to highlight the frequency you wish to select for the preset and press the Select button. The FM frequency will then be stored in the preset. To select that preset and exit, press the MENU button.

Tip

If you frequently travel to different areas, you can set the five FM presets to frequencies that are not being used by broadcasters in those areas.

NOTE: YOU CAN DISPLAY THE FM PRESET LIST AT ANY TIME BY PRESSING AND HOLDING THE FM PRESETS BUTTON.

If the FM transmitter is already set to ON when you press the FM Presets button, the FREQUENCY screen will be displayed for 3 seconds showing the currently-selected FM frequency and preset (see *Figure 93*).



Figure 93

Pressing the FM Presets button again while the FREQUENCY screen is displayed will change to the next FM preset frequency.

Menu Options

Menu Options allows you to set and/or change the various features and settings of your SIRIUS Starmate ST5. Press and release the MENU button to display the MENU OPTIONS (see *Figure 94*).

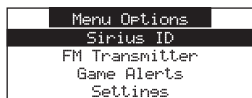

Figure 94

Use the Channel UP/DOWN buttons to highlight selections in the menu lists and press the Select button to select them. To exit a menu, press the MENU button. If you don't make a selection within 10 seconds the ST5 will exit the MENU OPTIONS screen and revert to the last active display mode. You can exit any Menu Options screen by pressing the MENU button.

Sirius ID

This displays your ST5's 12-digit SIRIUS ID (SID) number (see *Figure 95*).

The SID is unique to each SIRIUS radio, and is required to activate your SIRIUS service. We recommend that you write this number in the space provided near the end of this user guide. No adjustments are allowed in this mode.

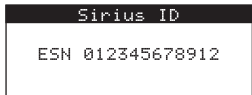

Figure 95

FM Transmitter

The FM TRANSMITTER menu option allows you to enable or disable the ST5's built-in FM transmitter, and select up to 5 different preset FM transmitter frequencies (see *Figure 96*).



Figure 96

FM PRESETS

You can set up to 5 preset FM transmitter frequencies:

1. On the FM TRANSMITTER screen (*Figure 96*), highlight and select FM PRESETS. The FM PRESETS screen will appear (see *Figure 97*, left). Note: You may also enter this list by pressing and holding the FM Transmitter button.



Figure 97

2. Highlight the FM preset you wish to set (or change) and press the Select button. A list of FM frequencies will be displayed, beginning with the currently selected FM frequency for the preset (see *Figure 97*, right)
3. Use your vehicle's FM radio to locate FM frequencies that aren't being used by local broadcasters, and where there is no interference from adjacent FM stations. These are the frequencies you should added to the FM PRESETS list.
4. Highlight the frequency you wish to select for the preset and press the Select button. The FM frequency will then be stored in the preset. (If you do not want a frequency for the preset, choose EMPTY from the menu.)

5. Select FM frequencies for other presets using the same steps. To exit the FM PRESETS menu, press the MENU button.

FM ON/OFF

To turn the ST5's FM transmitter ON or OFF, highlight and select FM ON/OFF on the FM TRANSMITTER screen (see *Figure 96*, on page 97). The FM ON/OFF screen will appear (see *Figure 98*).

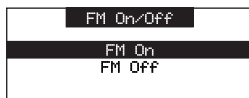

Figure 98

To turn the FM transmitter ON, highlight and select FM ON; to turn the FM transmitter OFF, highlight and select FM OFF.

Settings

The SETTINGS menu lets you access the DISPLAY OPTIONS, JUMP SETTINGS, MEMORY OPTIONS, AUDIO LEVEL, CONFIRMATION TONE and PARENTAL CONTROL menu options (see *Figure 99*).



Figure 99

Display Options

You can adjust the brightness and contrast of the ST5's LCD display screen to improve its visibility in different lighting conditions (see *Figure 100*).

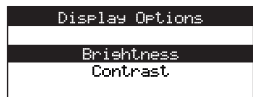

Figure 100

BRIGHTNESS adjusts the overall intensity of the LCD display to help with viewing in different lighting conditions. **CONTRAST** adjusts the relationship between the background and the text on the LCD display.

Use the Channel UP/DOWN buttons to adjust the brightness and contrast. The bar graphs will indicate the change (see *Figure 101*).



Figure 101

NOTE: YOU CAN CHANGE THE SCREEN BRIGHTNESS WITHOUT ENTERING THE MENU SYSTEM BY PRESSING AND HOLDING THE CATEGORY < AND > BUTTONS (SEE PAGES 66 - 68).

Jump Settings

JUMP SETTINGS controls the actions of the Jump button (see *Figure 102*). You can also access the JUMP SETTINGS screen by pressing and holding the Jump button.



Figure 102

Two Jump setting options are available, TRAFFIC and JUMP SET. The Jump icon indicates the currently-selected option.

The TRAFFIC option sets the Jump button to provide a traffic report for a selected city, while the JUMPSET option assigns any channel to the Jump button.

TRAFFIC

1. Highlight and select the TRAFFIC option. The TRAFFIC MARKET screen will appear (see *Figure 103*). Highlight and select the desired city.

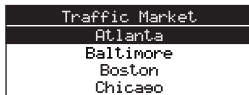

Figure 103

2. If the ST5 has not yet updated the city list it will display a message indicating that the city list is updating (see *Figure 104*). Wait 10 minutes and then try again.



Figure 104

JUMPSET

1. On the JUMP SETTINGS screen (see *Figure 102*, on page 100), highlight and select JUMPSET. The JUMPSET screen will appear (see *Figure 105*).



Figure 105

2. Tune to the channel you want assigned to the Jump button (you can use the Channel UP/DOWN buttons, your presets or enter the channel number directly). When the channel is tuned, press and hold the Jump button for 2 seconds until the screen in *Figure 106* is displayed.

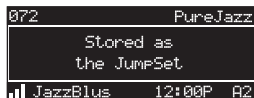

Figure 106

The selected channel is now assigned to the Jump button.

NOTE: WHILE LISTENING TO ANY CHANNEL OTHER THAN A TRAFFIC CHANNEL, YOU CAN ASSIGN THAT CHANNEL TO THE JUMP BUTTON BY SIMPLY PRESSING AND HOLDING THE JUMP BUTTON FOR 2 SECONDS.

Memory Options

Memory Options lets you turn the automatic S-Seek feature **ON** or **OFF**, and also provides a way to clear (erase) all the stored S-Seek alerts from memory (see *Figure 105*).



Figure 105

Auto Memory Search

This lets you turn the S-Seek function **ON** or **OFF**.

On the Memory Options screen (see *Figure 101*), highlight and select **AUTO MEMORY SEARCH**. The **AUTO MEMORY SEARCH** screen will appear (see *Figure 106*). Highlight and select either **ON** or **OFF**.



Figure 106

Clear All Memory

This clears all S-Seek memory entries.

On the Memory Options screen (see *Figure 101*), highlight and select **CLEAR ALL MEMORY**. The **CLEAR ALL MEMORY?** screen will appear (see *Figure 107*). Highlight and select either **Yes** or **No**.

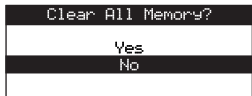

Figure 107

Audio Level

Use the Channel UP/DOWN buttons to adjust the ST5's audio output level (see *Figure 108*). The bar graph will indicate the change.



Figure 108

Confirmation Tone

The ST5 will sound an audio alert tone when you power it **ON** or **OFF**, as well as when a S-Seek alert or other alert is activated. The default setting is **ON**. To change the Confirmation Tone setting, use the Channel UP/DOWN buttons to highlight On or Off, and press the Select button (see *Figure 109*).

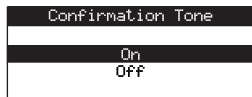

Figure 109

Parental Control

Your SIRIUS Starmate ST5 has the ability to lock channels you do not want others (such as children) to access without your permission. Locked channels will not appear on the Channel List screen, the Category List screen or when browsing channels with the Channel UP/DOWN buttons. When the anyone tries to access a locked channel using the Direct Tuning function (see page 76), an ENTER CODE screen will be displayed and the channel won't be accessed until the correct code is entered.

NOTE: LOCKED CHANNELS WILL APPEAR ON THE MY CHANNELS SCREEN. SEE PAGE 74.

Locking and Unlocking Channels

1. Select the PARENTAL CONTROL menu option. The PARENTAL CONTROL screen will appear (see *Figure 110*, left).

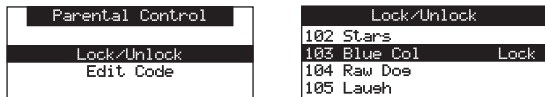

Figure 110

2. Select LOCK/UNLOCK. You will need to enter the lock code to proceed. Refer to *Changing the Lock/Unlock Code*, on page 105 for information on how to set the lock code.
3. Once you enter the lock code the LOCK/UNLOCK screen will appear (see *Figure 110*, right). Highlight the channel you wish to lock or unlock from the channel list. Pressing the Select button will either add the word Lock next to the channel name to indicate that the channel will be locked, or unlock a locked channel by removing the word Lock.

Changing the Lock/Unlock Code

The first time you access the LOCK/UNLOCK menu, you must enter the default lock code. The default lock code is **0 0 0 0**. You can keep this code or change it. To change the lock code:

1. Select the PARENTAL CONTROL menu option. The PARENTAL CONTROL screen will appear (see *Figure 110*, left, on page 104)
2. Select the EDIT CODE menu option. The ENTER CODE screen will appear (see *Figure 111*).



Figure 111

3. Enter the default lock code (**0 0 0 0**) or the current lock code if you have changed it from the default code. (If you enter the wrong code, a message will be displayed indicating that the wrong code has been entered.)
4. The NEW CODE prompt will be displayed. Enter your new four digit code using the 0 - 9 number buttons. You will then be prompted to enter the new code again to confirm.
5. When the new lock code is confirmed, the lock code is changed.

You can use this same procedure to change the lock code again after you have changed it from the default code.

NOTE: IF YOU HAVE FORGOTTEN YOUR PARENTAL CONTROL CODE, CALL SIRIUS CUSTOMER SERVICE FOR HELP.

Time Based Features

The TIME BASED FEATURES screen (*Figure 112*) lets you adjust the following features:

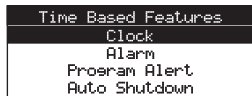

Figure 112

Clock - Sets the clock format, time zone, and daylight savings time function.

Alarm - Sets an alarm for a specific time.

Program Alert - Sets the radio to tune to a specific channel at a specified time.

Auto Shutdown - Sets the radio to turn off at a specified time.

Sleep Mode - Sets the radio to turn off after a designated period of time.

Use the Channel UP/DOWN buttons to highlight the option you wish to adjust, and press the Select button.

Clock

The CLOCK screen (see *Figure 113*) allows you to setup the clock that appears on the Default screen, based on the format desired and the time zone in which you reside. The actual time is provided via the SIRIUS satellite signal, and will automatically update your Starmate ST5.

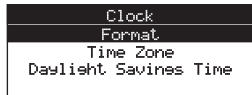

Figure 113

FORMAT: Displays the time in either 12-hour (default) or 24-hour format (see *Figure 114*).

Format
12 Hour
24 Hour

Figure 114

TIME ZONE: Since the clock adjusts the time automatically, it is important to specify your time zone. Select your time zone from the list of the available time zones (see *Figure 115*).

Time Zone
(GMT -6:00) Central
(GMT -5:00) Eastern
(GMT -4:30) Atlantic
(GMT -3:30) Newfoundland

Figure 115

DAYLIGHT SAVINGS TIME: Select **On** if your area observes Daylight Savings Time; select **Off** if your area does not (see *Figure 116*).

Daylight Savings Time
DST Observed
DST Not Observed

Figure 116

Alarm

The ALARM screen (see *Figure 117*) lets you to set your Starmate ST5 to turn **ON** at a specific time. The last selected channel prior to shutdown will play when the ST5 powers **ON**.



Figure 117

SET ALARM: This turns the alarm **ON** and **OFF**.

ALARM TIME: This lets you set the alarm time (see *Figure 118*). Use the Category < and > buttons to set the hours and use the Channel UP/DOWN buttons to set the minutes when you want the ST5 to power on. (The default time is 12:00.)

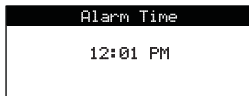

Figure 118

Program Alert

The PROGRAM ALERT screen (see *Figure 119*) lets you program the radio to automatically tune to a specific channel at a specific time. The radio must be powered on in order for this feature to function.

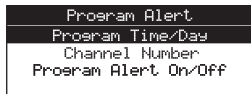

Figure 119

PROGRAM TIME/DAY: Program the day and time you want the ST5 to tune to the specific channel.

1. Highlight and select PROGRAM TIME/DAY. The PROGRAM TIME/DAY screen will appear (see *Figure 120*).

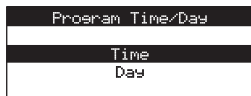

Figure 120

2. Highlight and select TIME. The PROGRAM TIME screen will appear (see *Figure 121*). To select the time you wish to tune to the specified channel, use the Category < and > buttons to change the hours, and the Channel UP/DOWN buttons to set the minutes. When you have selected the desired time, press the Select button to set the time and exit.

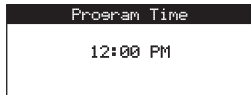

Figure 121

3. On the PROGRAM TIME/DAY screen, highlight and select DAY. The PROGRAM DAY screen will appear (see *Figure 122*).

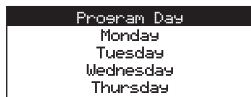

Figure 122

4. Using the channel up and down buttons, select the day of the week you wish to tune to the selected channel, i.e., Monday, Tuesday, etc., and press the Select button. To exit the PROGRAM TIME/DAY menu, press the MENU button.

Channel Number: Set the channel to which the radio will tune when Program Alert is **ON**:

1. On the PROGRAM ALERT screen, highlight and select CHANNEL NUMBER. A channel list screen will appear (see *Figure 123*).

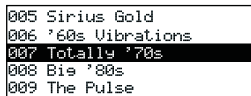

Figure 123

2. Use the Channel UP/DOWN buttons to highlight the channel you want the ST5 to play when Program Alert turns it **ON**, then press the Select button to set the channel.

Program Alert On/Off: Turn Program Alert **ON** or **OFF**:

1. On the PROGRAM ALERT screen (see *Figure 119*, on page 109), highlight and select PROGRAM ALERT ON/OFF. The PROGRAM ALERT ON/OFF screen will appear.
2. Highlight and select ON or OFF.

To exit the PROGRAM ALERT ON/OFF menu, press the MENU button.

Auto Shutdown

Auto Shutdown lets you program the ST5 to automatically shut **OFF** after a one-hour period of inactivity (no button presses or other user intervention). After selecting Auto SHUTDOWN on the TIME BASED FEATURES screen (see *Figure 112*, on page 106) the AUTO SHUTDOWN screen will appear (see *Figure 124*).

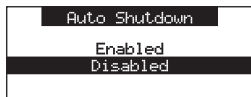

Figure 124

Select **ENABLE** to activate the auto shutdown; select **DISABLE** to cancel an auto shutdown. After 59 minutes of inactivity, a beep tone will sound and a **CANCEL AUTO SHUTDOWN** display prompt appears on the screen to allow you to delay the automatic shutdown. Pressing the **Select** button will reset the Auto Shutdown for another 1-hour period.

Sleep Mode

The **SLEEP MODE** screen (see *Figure 125*) lets you program the ST5 to automatically shut **OFF** after a selected period of time.

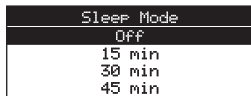

Figure 125

Highlight and select the amount of time you want the ST5 to remain **ON** before it shuts **OFF**.

Signal Indicator

When using your Starmate ST5 indoors with the optional SIRIUS Home Docking Station or Boombox, it is important to aim the antenna for maximum signal reception. The SIGNAL INDICATOR screen (see Figure 126) visually shows the strength of the satellite and terrestrial signals being received by the ST5. (Refer to the Home Docking Station installation guide for more information about properly orienting the antenna.)

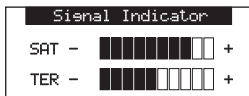

Figure 126

The SAT bar graph indicates the strength of the satellite signal strength; the TER bar graph indicates the strength of the terrestrial signal strength (if available).

Factory Default

The Factory Default option will restore almost every feature of the ST5 to its original factory settings. The following is a list of all features affected by the Factory Default option:

- All Presets are cleared
- All S-Seek Memory entries are cleared
- Display brightness set to 50%
- Display Contrast set to 50%
- FM Transmitter set to ON
- FM Frequency set to 88.1 MHz
- Clock set to 12-Hour Format
- Time Zone set to Eastern Standard Time
- Daylight Savings Time set to Observed
- Auto Shutdown set to Off
- Sleep Mode set to Off
- Auto Select set to Off
- Program Alert cleared

Note that the Parental Control feature is not affected by the Factory Default option. If a code has been set for the Parental Control feature, the code will not be reset by the Factory Default feature, preventing someone from circumventing the Parental Control feature. Channels which have been locked will remain locked.

To activate the Factory Default feature, and restore the above features to their factory defaults, do the following:

1. Highlight and select **FACTORY DEFAULT** from the **MENU OPTIONS** screen. The **RESTORE SETTINGS?** screen will appear (see *Figure 127*).

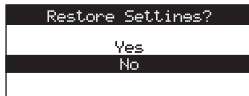

Figure 127

- Highlight and select YES to restore the above settings to the their factory default settings, or select No to leave them as-is and return to the MENU OPTIONS screen.
- If you select Yes, a confirmation screen appears (see *Figure 128*). Use the Channel UP/DOWN buttons to select YES to restore all settings to the settings from the factory, or select No to leave them as-is and return to the Menu Options menu.

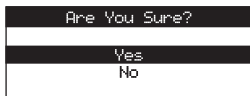

Figure 128

- If you select Yes, the ST5 will revert to the original factory settings (see *Figure 129*).

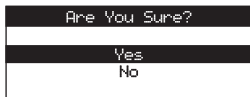

Figure 129

- When the Factory Default is complete, the ST5 will automatically tune to Channel 184 (the SIRIUS preview channel) and display CALL 1-888-539-SIRIUS TO SUBSCRIBE. Your ST5 is still subscribed to the SIRIUS service, and you can tune to any channel that hasn't been locked using the Parental Control feature.

Troubleshooting

Symptom	Solution
Radio does not power ON	Blown fuse, or the power cable is not properly connected. Check for a bad fuse and check power cable connection
Radio displays: ANTENNA NOT DETECTED	The satellite antenna is not connected to the vehicle dock. Check the satellite antenna connection to the vehicle dock.
Radio displays: ACQUIRING SIGNAL	No satellite signal is being received. Check for obstacles over or around the satellite antenna. Change the vehicle location to eliminate nearby obstacles (bridges, overpasses, tress, buildings, etc.).
Audio static or loss of clarity	The vehicle radio's FM frequency contains static. Locate a quiet FM frequency on your vehicle radio and set the Starmate ST5's FM transmitter frequency to match. If using your vehicle's AUX audio connector, check the cable connections.
No sound	The audio cables are not connected, or the FM radio is set to the wrong frequency. Check the audio cables at the SIRIUS Vehicle Dock and the radio. Tune the FM radio to the same FM frequency the Starmate ST5's FM Transmitter is tuned.

Specifications

Satellite Frequencies2322.293/2330.207 MHz
Terrestrial Frequencies	2326.250MHz
Power Requirements	5.2 Volts, Negative Ground, DC
Audio Output	2.8V (normal) 3.0V (max.) (Peak-to-Peak)
Total Harmonic Distortion (THD)	<0.2%
Signal-to-noise (S/N)Greater than 73dB
Operation Temperature	-20° to +85° C (-4° to +185° F)
Radio Dimensions (Length x Height x Depth)	124.2mm x 48.5mm x 16mm (4.9" x 1.9" x .06")
Radio Weight	71g (2.5 oz.)
Remote Control Dimensions (Width x Length x Height)	41mm x 104mm x 15mm (1.61" x 4.09" x .59")
Remote Control Battery Requirements	CR2025
Cigarette Lighter Adapter Fuse Requirement	2A Slow Blow
Cigarette Lighter Adapter Cable Length	1.8m (6ft.)
Cigarette Lighter Adapter Operating Temperature	-20° to +85° C (-4° to +185° F)
Antenna Type	Low Profile Magnetic
Antenna Cable Length	21' (single micro-cable)
Antenna Connector Type	SMB (right-angle)
Audio Out Interface	1/8" / 3.5mm Stereo Jack

SIRIUS ID

Write down your SIRIUS Starmate ST5's SIRIUS ID (SID) number in the space provided below.

SID: _____

Federal Communication Commission Interference Statement

This equipment has been tested and found to comply with the limits for a Class B digital device, pursuant to Part 15 of the FCC Rules. These limits are designed to provide reasonable protection against harmful interference in a residential installation. This equipment generates, uses and can radiate radio frequency energy and, if not installed and used in accordance with the instructions, may cause harmful interference to radio communications. However, there is no guarantee that interference will not occur in a particular installation. If this equipment does cause harmful interference to radio or television reception, which can be determined by turning the equipment off and on, the user is encouraged to try to correct the interference by one of the following measures:

- Reorient or relocate the receiving antenna.
- Increase the separation between the equipment and receiver.
- Connect the equipment into an outlet on a circuit different from that to which the receiver is connected.
- Consult the dealer or an experienced radio/TV technician for help.

FCC Caution: Any changes or modifications not expressly approved by the party responsible for compliance could void the user's authority to operate this equipment.

This device complies with Part 15 of the FCC Rules. Operation is subject to the following two conditions: (1) This device may not cause harmful interference, and (2) this device must accept any interference received, including interference that may cause undesired operation.

Country Code Statement

For product available in the USA/Canada market, only channel 1-11 can be operated. Selection of other channels is not possible.

This device and its antenna(s) must not be co-located or operation in conjunction with any other antenna or transmitter.

FCC NOTICE: To comply with FCC part 15 rules in the United States, the system must be professionally installed to ensure compliance with the Part 15 certification. It is the responsibility of the operator and professional installer to ensure that only certified systems are deployed in the United States. The use of the system in any other combination (such as co-located antennas transmitting the same information) is expressly forbidden.

IC Statement

This Class B or A digital apparatus complies with Canadian ICES-003.

Operation is subject to the following two conditions: (1) this device may not cause interference, and (2) this device must accept any interference, including interference that may cause undesired operation of the device.

Cet appareil numérique de la classe B or A conforme à la norme NMB-003 du Canada.

Operation is subject to the following two conditions: (1) this device may not cause interference and (2) this device must accept any interference, including interference that may cause undesired operation of the device.

Country Code Statement

For product available in the USA/Canada market, only channel 1~11 can be operated. Selection of other channels is not possible.

This device and its antenna(s) must not be co-located or operation in conjunction with any other antenna or transmitter.

To reduce potential radio interference to other users, the antenna type and its gain should be so chosen that the equivalent isotropically radiated power (e.i.r.p) is not more than that permitted for successful communication.

RSS-GEN issue 2

(7.1.4) Transmitter Antenna

This device has been designed to operate with the antennas listed below, and having a maximum gain of [x] dB.

Antennas not included in this list or having a gain greater than [x] dB are strictly prohibited for use with this device. The required antenna impedance is 50 ohms.

RSS-GEN issue 2 (7.1.3) External Amplifiers

In accordance with Industry Canada Regulations, this radio frequency power amplifier may only be used with a transmitter with which the amplifier has been certified by Industry Canada. This Industry Canada Identification Number for the transmitter with which this amplifier is permitted to operate is...(XXX-XXX MHz)

RSS-210 Issue 7 Annex 9 A9.5(4)

The device could automatically discontinue transmission in case of absence of information to transmit, or operational failure. Note that this is not intended to prohibit transmission of control or signaling information or the use of repetitive codes where required by the technology.



SIRIUS Customer Service: 1-800-869-5590
customer care@sirius-radio.com

SIRIUS Satellite Radio Inc.
1221 Avenue of the Americas
New York, NY 10020
1-800-869-5590
<http://www.sirius.com>

sirius.com

Sirius Satellite Radio Inc.
1221 Avenue of the Americas
New York, NY 10020

800.869.5590

Starmate 5 User Guide (022108a)
49.UPAS5.002