

STILETTO 2

Live Portable Satellite Radio



User Guide

Congratulations on the purchase of your new Stiletto 2!

The Stiletto 2™ is SIRIUS's **next generation** live personal satellite radio. It includes everything you need to listen live to SIRIUS® radio almost anywhere you want to go. Powerful features allow you to record up to 100 hours of your favorite songs and shows, and even download your personal MP3 & WMA files for continuous entertainment.

With your Stiletto 2 you can:

- Listen live to more than 125 SIRIUS satellite channels of 100% commercial free music, sports, and talk programming.
- Listen live to SIRIUS Internet Radio over an available Wi-Fi network.
- Store up to 100 hours of your favorite songs, SIRIUS shows, and personal MP3 & WMA music files. **Add a microSD™ card and store even more of your personal MP3 & WMA music files.**
- Schedule recordings up to 6 hours long so you never miss your favorite shows.
- Add any music you hear to your “**wish list**” and then go online to purchase and download from almost any Windows Media® based music service.

The Stiletto 2 includes My Sirius Studio™ and Yahoo! Music Jukebox™ software to help you create and manage your personal playlists, and supports the download of both purchased and subscription based music content.



Table of Contents

TABLE OF CONTENTS.	2
WARNING AND SAFETY INFORMATION.	4
FCC Information	4
FCC Interference Statement	4
FCC Radiation Exposure Statement	5
Canadian Compliance	5
General Precautions	5
PACKAGE CONTENTS.	8
BATTERY LIFE, INSTALLATION, AND CHARGING	10
INSTALLING A REMOVABLE MEDIA CARD.	13
CONTROLS	14
Stiletto 2 Reference Guide	14
Using the Media Dial	18
GETTING STARTED	19
Turning the Stiletto 2 On/Off, Sleep, and Lock Modes	19
Navigating Menus and Lists	21
Receiving the SIRIUS Satellite Signal	23
Subscribing to the SIRIUS Service	25
Device Tour	25
Connecting the Stiletto 2 to a PC Computer	26
OPERATION	27
Satellite Radio	28
Internet Radio	40
Library	45
Radio Replays	54
Recording	57
Settings	61
MY SIRIUS STUDIO SOFTWARE INSTALLATION	67

TROUBLESHOOTING	68
OPTIONAL ACCESSORIES	69
SPECIFICATIONS	71
WARRANTY	72
END USER LICENSE AGREEMENT	73
COPYRIGHTS & TRADEMARKS	81
Copyrighted Broadcast Material	81
Copyrights & Trademarks	81
SIRIUS ID	82
INDEX	83

Warning and Safety Information

FCC Information

This device complies with part 15 of the FCC Rules. Operation is subject to the following two conditions:

1. This device may not cause harmful interference, and
2. This device must accept any interference received, including interference that may cause undesired operation.

FCC Interference Statement

This equipment has been tested and found to comply with the limits for a Class B digital device, pursuant to Part 15 of the FCC Rules. These limits are designed to provide reasonable protection against harmful interference in a residential installation. This equipment generates, uses and can radiate radio frequency energy and, if not installed and used in accordance with the instructions, may cause harmful interference to radio communications. However, there is no guarantee that interference will not occur in a particular installation. If this equipment does cause harmful interference to radio or television reception, which can be determined by turning the equipment off and on, the user is encouraged to try to correct the interference by one of the following measures:

- Reorient or relocate the receiving antenna.
- Increase the separation between the equipment and receiver.
- Connect the equipment into an outlet on a circuit different from that to which the receiver is connected.
- Consult the dealer or an experienced radio/TV technician for help.

Any changes or modifications not expressly approved by the party responsible for compliance could void the user's authority to operate this equipment. This device and its antenna(s) must not be co-located or operating in conjunction with any other antenna or transmitter. For product available in the USA market, only channel 1~11 can be operated. Selection of other channels is not possible.

FCC Radiation Exposure Statement

This EUT is compliance with SAR for general population/uncontrolled exposure limits in ANSI /IEEE C 95.1-1999 and had been tested in accordance with the measurement methods and procedures specified in OET Bulletin 65 Supplement C.

Canadian Compliance

This Class B digital apparatus complies with Canadian ICES-003.

Cet appareil numérique de la classe B est conforme à la norme NMB-003 du Canada.

General Precautions

SIRIUS disclaims all liability for hearing loss, bodily injury, or property damage as a result of the use or misuse of this product.

Volume and Hearing Safety Precautions

- When listening to your Stiletto, be aware of your surroundings. The use of earbuds or headphones while riding a bike or operating a vehicle or motorcycle may be prohibited by law, and is not recommended.
- If you experience ringing in the ears while listening, stop using the Stiletto and consult a medical professional.
- When using your Stiletto, start the volume low and gradually turn it up to a medium level which you can hear. If the ambient sounds around you are noisy or loud, do not turn the volume up to high level. Find a quieter location instead.

- Permanent hearing loss can occur if you set the volume too high. Your ears adapt to the loud volume and can be permanently damaged.
- The use of earbuds or headphones for an extended period of time can cause serious damage to your ears. Wearing them for prolonged periods of time or while sleeping is not recommended.

Liquid Crystal Precautions

If the LCD screen on the Stiletto is damaged, do not to touch the liquid crystal fluid. If any of the following situations happen, take the action indicated:

1. If the liquid crystal fluid comes in contact with your skin, wipe the skin area with a cloth and then wash the skin thoroughly with soap and running water.
2. If the liquid crystal fluid gets into your eye, flush the eye with clean water for at least 15 minutes. Seek medical care.
3. If the liquid crystal fluid is ingested, flush your mouth thoroughly with water. Drink large quantities of water and induce vomiting. Seek medical care.

General Safety Precautions

Be sure to observe the following warnings. Failure to follow these safety instructions and warnings may result in a serious accident.

- Do not expose the Stiletto to moisture or use it near or in water. Do not handle it with wet hands, or let water or any other liquid spill on or in it.
- Do not operate the Stiletto in a way that might divert your attention from driving safely. As a driver, you alone are responsible for safely operating your vehicle in accordance with traffic safety laws at all times.
- [Be sure the unit is installed as described in the installation instructions in this guide. When installing the unit using a Vehicle Kit, Home Kit or Executive Sound System, follow the installation instructions included with those accessories.](#)
- To avoid short circuits, do not open the unit, and never put or leave any metallic objects (coins, tools, etc.,) inside the unit.
- If the unit emits smoke or unusual odors, turn the power off immediately, and disconnect the unit from any power source.
- Do not drop the unit or subject it to strong shocks.
- If the unit doesn't seem to be working properly, turn the unit off, remove the battery from the unit, wait 10 seconds, replace the battery and then turn it on again.

My Sirius Studio Software

The My Sirius Studio software CD-ROM included with the Stiletto 2 will allow you to connect your Stiletto 2 to your PC computer running the Windows® XP operating system with Service Pack 2, or the Vista operating system. It is important that this software be used to transfer and manage information on your Stiletto 2 to ensure that the operating system software essential to the operation of the Stiletto 2 is not removed or damaged.

The software also provides for upgrading features and functionality as they become available from SIRIUS. Be sure to periodically connect the Stiletto 2 to your PC computer to load the latest updates. Refer to the user guide included on the software CD-ROM for further information on installing and using the software.

The My Sirius Studio software should be installed *before* connecting the Stiletto 2 to your PC computer.

Operating Temperature

The Stiletto 2 is designed to operate between -5° to +40° C (23° to 104° F). Avoid leaving the unit in a vehicle or elsewhere where the temperature may fall outside this range. Extreme temperatures or extreme temperature fluctuations can degrade the performance of the LCD display screen, and possibly damage it.

Cleaning and Maintenance

If the Stiletto 2 becomes dirty, turn the power off and wipe it clean with a soft clean cloth. Do not use hard cloths, paint thinner, alcohol, or other volatile solvents to clean. These may cause damage to the unit.

Package Contents

The following items are included with your purchase of the Stiletto 2:



Stiletto 2



Battery

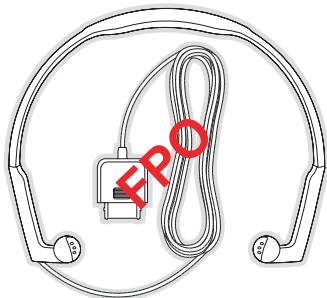

Antenna Headphones

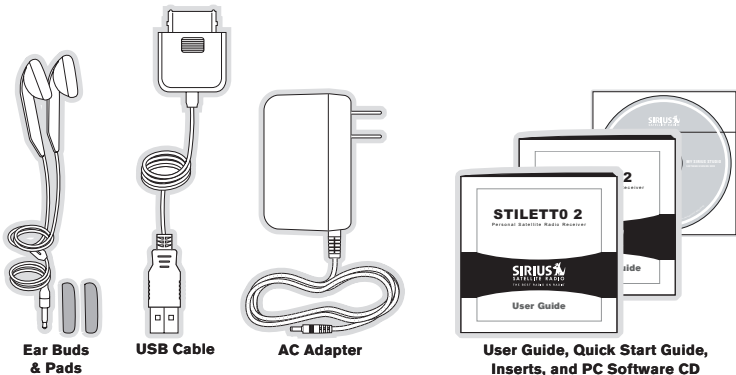

ENHANCING THE VERSATILITY OF YOUR STILETTO

Stiletto Vehicle Kit (Model SLV1)

In order to use your Stiletto in a vehicle, you will need the Stiletto Vehicle Kit. The kit includes a compact docking cradle that rapidly charges your Stiletto's battery, connects to an external-mounted antenna for more reliable reception, and plays audio through your vehicle's stereo system. Ten dedicated preset buttons (30 presets total) and an included remote control make it easy to tune and operate your Stiletto without taking your eyes from the road.

Stiletto Home Kit (Model SLH1)

The Stiletto Home Kit provides everything you need to use the Stiletto in your home or office. The sleek docking cradle provides a convenient way to charge your Stiletto's battery along with an extra slot for charging a spare battery. The included indoor/outdoor antenna provides improved reception, while audio cables enable you to connect the Stiletto to amplified speakers or a home entertainment system. A remote control is included, along with USB cable and PC computer software for optionally connecting the home dock to your PC computer.

Battery Life, Installation, and Charging

The **Stiletto battery** when fully charged will provide a range of listening times depending on the listening mode. The following table provides the approximate listening times:

Listening Mode	Approximate Listening Time
Satellite Radio	4 hours
Internet Radio	8 hours
Library	20 hours
Radio Replays	20 hours

As batteries age, the amount of listening time diminishes. Replacement (or spare) batteries are available from your SIRIUS product distributor.

The amount of listening time the battery provides is dependent upon several settings: decreasing the length of time the backlight of the display screen remains on will prolong battery life as well as adjusting the brightness of the display screen to a dimmer setting. Both of these adjustments are made through the *Settings* menu. Refer to **Brightness** and **Backlight Timer** on page 61 for details about these settings.

Stiletto 2 Battery Installation/Removal

To access the Stiletto battery, refer to Figure 1 and slide the battery cover toward the bottom of the Stiletto and remove it. The battery can then be removed.

When installing the battery, place the battery into the battery compartment in the orientation shown. The battery cover can then be reinstalled

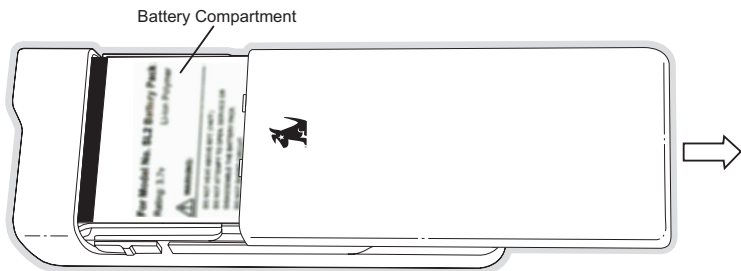

Figure 1

Battery Charging

The battery in the Stiletto 2 is shipped partially charged but should be fully charged before using. For the fastest charging time, the Stiletto 2 should be turned off while the battery is being charged. When off, a fully discharged battery will charge in 4 hours.

To charge the Stiletto, power the unit off and connect the AC Adapter as shown in Figure 2.



Figure 2

Battery Disposal

When disposing of batteries, do so in accordance with the local waste disposal regulations. Batteries should not be disposed of in household waste, but should be recycled instead.

Installing A Removable Media Card

You can add additional memory to the Stiletto 2 by installing a microSD card. This adds additional storage space for purchased and downloaded content. The microSD card can be any size, up to a maximum size of 8GB.

The card slot for the microSD card is located underneath the battery which will need to be removed in order to install the card. (Refer to the **Stiletto 2 Battery Installation/Removal** instructions on page 11.) Once the battery has been removed, the microSD card holder will be visible. As shown in Figure 3, flip up the card holder (1) and slide the microSD card into the card holder in the orientation shown (2). Close the card holder (3) and reinstall the battery and cover to complete the installation.

You can verify that the Stiletto has recognized that the microSD card is present by pressing the  Home button and selecting **Settings** → **Device** → **microSD Card**.

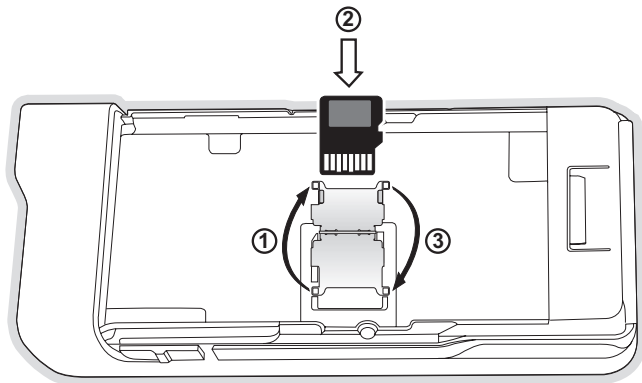

Figure 3

Controls

Stiletto 2 Reference Guide

Figure 1 identifies the buttons, controls, and connectors of the Stiletto 2.

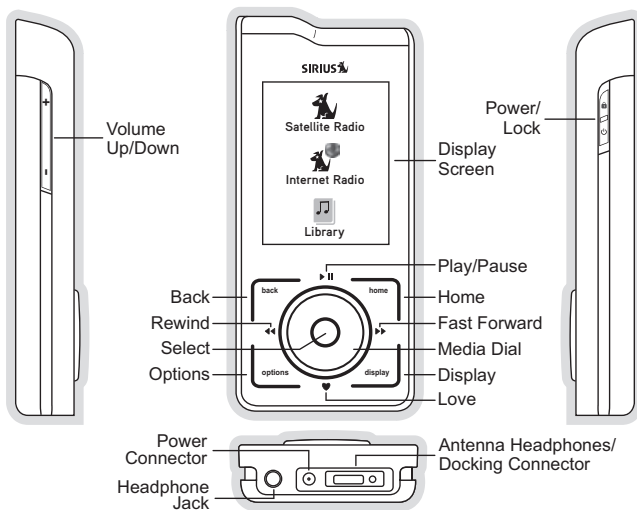









Figure 1





The following table describes the functions of the buttons and controls on the Stiletto 2.

Stiletto 2 Button and Control Descriptions				
Button	Action	Satellite Radio Mode	Internet Radio Mode	Replay/Library Mode
 Power/Lock	Slide Up	Locks all buttons on the Stiletto 2		
	Center	Unlocks all buttons on the Stiletto 2		
	Slide Down	Slide down and release: Turns Stiletto 2 On (if Off), or places radio in sleep mode (if On) Slide down and hold for 5 seconds: Turns the Stiletto 2 Off		
 Volume	Press	+ Increases the audio volume – Decreases the audio volume		
 Play/Pause	Press	Pauses a broadcast or resumes playing a paused broadcast	If playing, mutes audio If muted, resumes playing	Pauses or resumes playing the current song or show
 Rewind	Press	If listening, skips to the previous song or show If in a channel or preset list, moves through categories or preset banks	If listening and muted, resumes playing If in a channel or category list, moves through channel categories	Skips to the beginning of the song or show
	Hold	If listening, rewinds through a broadcast		Rewinds through song or show

Stiletto 2 Button and Control Descriptions *Continued*

Button	Action	Satellite Radio Mode	Internet Radio Mode	Replay/Library Mode
 Fast-Forward	Press	If listening, skips in the replay buffer to the next song or show If in a channel or preset list, moves through categories or preset banks	If listening and muted, resumes playing If in a channel or category list, moves through channel categories	Skips to the next song or show
	Hold	Fast-Forwards through the replay buffer		Fast-Forwards through song or show
 Love	Press	Saves the song or show if possible, or adds to the wish list when song/show cannot be saved While recording, prompts to stop recording	Adds the artist/song to the wish list	
	Hold	Displays recording setup screen While recording, prompts to stop recording		
 Media Dial	Scroll	If listening, displays channel or category list If in a list, menu, or prompt, scrolls to next or previous item		

Stiletto 2 Button and Control Descriptions *Continued*

Button	Action	Satellite Radio Mode	Internet Radio Mode	Replay/Library Mode
 Select	Press	Selects highlighted item in a list, menu, or prompt		
 back	Press	Returns back to the screen displayed just prior to the currently displayed screen		
 home	Press	First press returns to the Home screen Additional press returns to the Now Playing screen		
 options	Press	Displays available options for the currently displayed screen If no options are available, nothing is displayed		
 display	Press	Cycles between the normal/near and car/far display mode , artist name, and song title when in the channel browsing mode		

Using the Media Dial

The **Media Dial** of the Stiletto 2 is controlled by placing your finger on the **Media Dial** and rotating the dial clockwise or counter-clockwise to scroll, highlighting a channel, genre, preset, menu item, or list item. (Figure 4) It may also be pressed at the north, south, east and west locations for selecting **Play/Pause**, **Love**, **Fast-Forward**, and **Rewind** as labeled. Pressing the center button provides the **Select** function for selecting a highlighted item.

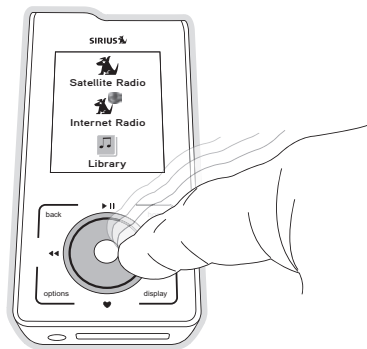

Figure 4

Getting Started

Turning the Stiletto 2 On/Off, Sleep, and Lock Modes

To turn the Stiletto 2 on, slide the ϕ Power/Lock switch down momentarily and then release it. When on, to put the Stiletto into sleep mode, slide the ϕ Power/Lock switch down momentarily and release it. The Stiletto will display *Going to sleep*. (Figure 1) Sleep mode allows the Stiletto to start up quickly when powered on. The Stiletto will power itself completely off after 18 hours of sleep.

To turn the Stiletto 2 completely off, hold the ϕ Power/Lock switch down for 5 seconds. The Stiletto will display *Shutting down*. (Figure 2) When completely off, the battery will remain charged for several weeks. When completely off, the Stiletto will take 1–2 minutes to power up.

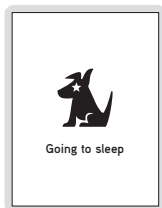



Figure 1



Figure 2

The Stiletto 2 may be locked to prevent the accidental pressing of a button by sliding the  Power/Lock switch up to the locked position (Figure 3) The  Power/Lock switch must be placed back into the unlocked (center) position for the other buttons to function.

If you press a button on the Stiletto while it is locked, the lock icon will be displayed to remind you that the Stiletto is locked. (Figure 4)

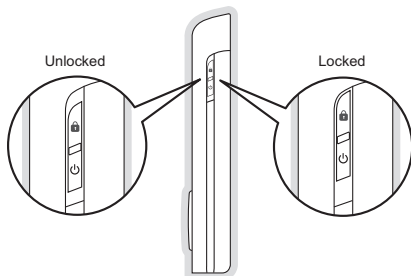

Figure 3



Figure 4

Navigating Menus and Lists

The menu and list structures in the Stiletto 2 are navigated by using the **Media Dial** to scroll through a menu or list to highlight your choice, and then pressing the **Select** button to select the choice. To return to the Home screen at any time, press the **Home** button. (Figure 5)

Tip: Pressing the **Home** button twice from any menu will return you to the Now Playing screen.

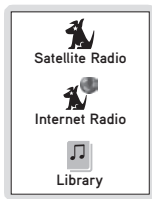

Figure 5

Let's say you have saved the song *Blue Moon* and now you want to listen to it. Use the ● Media Dial to highlight a choice and press the ● Select button to select the choice until you have navigated to the song. Refer to Figure 6 for an example.

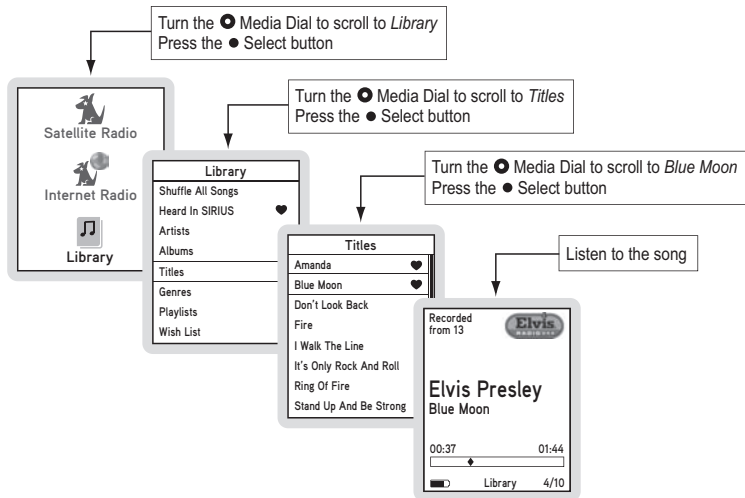

Figure 6

In this user guide, menu or list structures like the previous example are shown as:

Home → *Library* → *Titles* → *Blue Moon* → Listen.

The ▢ Back button will move you back to the previous display screen and the ▢ Home button will return you to the Home screen. Pressing the ▢ Home button again will return you to the Now Playing screen.

Receiving the SIRIUS Satellite Signal

The SIRIUS satellite signal is broadcast from satellites covering almost all of North America. To receive the satellite signal your Stiletto must have a clear view of the sky. Obstructions such as buildings, trees, bridges, and high voltage power lines can interfere with the satellite signal.

The human body will also block satellite signal reception if it is placed between the Stiletto and the sky. It is possible to lose even a strong signal as you move and change position.

The use of the antenna headphones included with your Stiletto will help to significantly eliminate these issues. By placing the antenna above any interference from the body, signal reception can be improved. Figure 7 illustrates the satellite signal being received by the Stiletto 2 using the antenna headphones, with no obstacles blocking the antenna headphones from having a clear view of the sky.

You can view the signal strength in your location by first selecting Satellite Radio, and then from the Home screen navigating to *Settings* → *Device* → *Antenna Aiming*. (Figure 8) At least one of the signals should be greater than 50% to reliably activate and use the Stiletto 2.

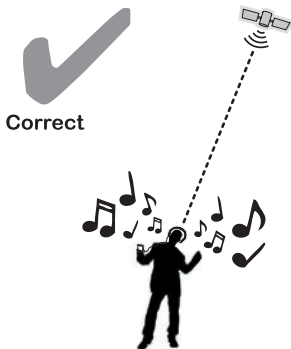

Figure 7

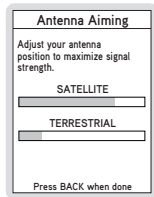

Figure 8

Figures 9 and 10 illustrate several unacceptable situations where obstacles are blocking the Stiletto 2 from having a clear view of the sky, preventing reception of the signal from the SIRIUS satellites.

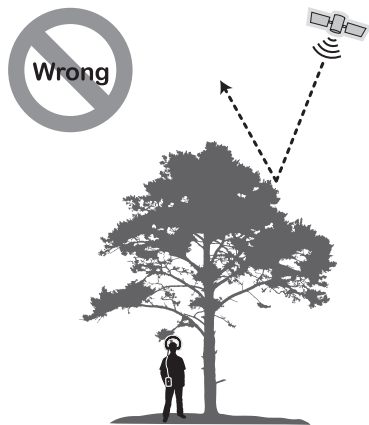

Figure 9

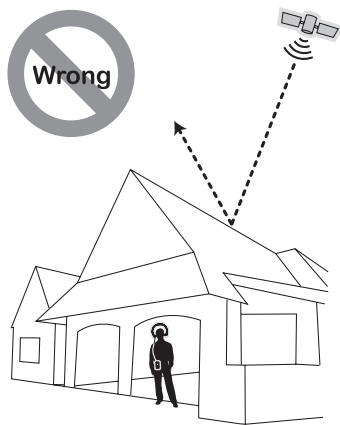

Figure 10

Subscribing to the SIRIUS Service

Before you can listen to the SIRIUS service, you need to activate your subscription. The Stiletto must be receiving the SIRIUS signal throughout the activation procedure.

The Stiletto 2 has a built-in activation wizard which will guide you through the activation process. To subscribe your Stiletto, simply follow the on-screen instructions. (Figure 11)

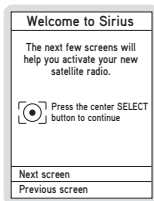

Figure 11

Device Tour

After you have subscribed your Stiletto 2 as described in the previous section, you will be offered a tour which will demonstrate some of the features of the radio. (Figure 12)

If you want to take the tour later press the  Home button. You can repeat the tour at any time by navigating from the Home screen to *Settings* → *Device Settings* → *Device Tour* and selecting *Yes, show tour*.



Figure 12

Connecting the Stiletto 2 to a PC Computer

Before connecting the Stiletto 2 to your PC computer, install the My Sirius Studio software that came with your Stiletto. Refer to the **My Sirius Studio Software Installation** section on page 67 for more information.

To connect the Stiletto 2 to a PC computer, connect one end of the USB cable to the Stiletto 2 and the other end to an available USB port on the PC computer, as shown in Figure 13.

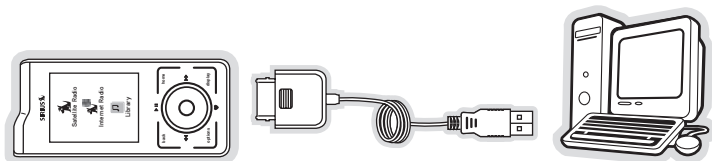

Figure 13

Your PC computer software will recognize the Stiletto and ask you which application you want to use to manage the content on your device. You may choose My Sirius Studio or any other compatible software including Windows Media® Player and Yahoo! Music Jukebox.

When you connect to the PC computer, the Stiletto will display a message asking you to turn off Satellite Radio and connect. (Figure 14) You may cancel and continue listening to satellite radio, or stop satellite radio and connect to the PC computer.

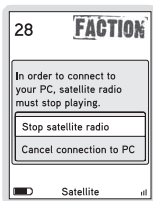

Figure 14

Operation

The Stiletto 2 delivers great audio entertainment in four distinct listening environments:

- **Satellite Radio.** Listen live to satellite broadcasts of all SIRIUS 100% commercial free music channels, talk, and sports programming. (Page 28)
- **Internet Radio.** Listen to SIRIUS commercial free music and select talk channels streamed over the Internet via a Wi-Fi network connection. (Page 40)
- **Library.** Listen to saved songs and shows, and content you have downloaded from your PC computer to the Stiletto 2. (Page 45)
- **Radio Replays.** Listen to content which has been automatically saved from your favorite music channels. (Page 54)

Each of these environments are described in detail in the sections following along with:

- **Recording.** Set up scheduled recordings to record SIRIUS broadcasts. (Page 57)
- **Settings.** Make changes to the global settings of the Stiletto 2 to personalize your experience. (Page 61)



Satellite Radio

Satellite Radio allows you to receive live SIRIUS broadcasts when you are receiving a signal from the SIRIUS satellite or terrestrial transmitters. You can browse and select the SIRIUS channels, and see information about the songs, artists, sports, news, weather, and traffic being broadcast.

To access Satellite Radio on your Stiletto 2, from the Home screen use the **Media Dial** to highlight Satellite Radio and press the **Select** button.

NOW PLAYING SCREEN INFORMATION

The Now Playing screen for Satellite Radio provides information such as the currently tuned channel, song or show being played, mode, recording, and other information. Figure 1 identifies the information which may be displayed when in the Satellite Radio mode.

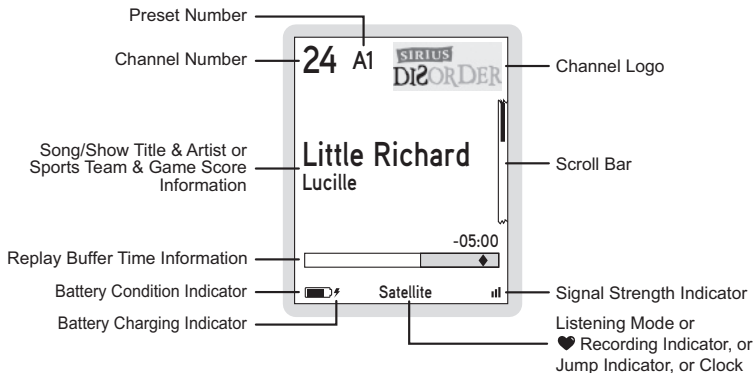

Figure 1

BROWSING AND NAVIGATING CHANNELS

When Satellite Radio is selected (Figure 2), channels may be browsed in several ways:

- In a list of all channels in numerical order. (Figure 3)
- In a list of channels which have been saved as presets. (Figure 4)
- In groupings of channels by genre (also referred to as categories) such as *Pop*, *Rock*, *Country*, etc. (Figure 5)

Use the ● Media Dial to highlight your choice, and press the ● Select button.

As you browse the lists, the channel names will be spoken if this feature is enabled. Channels may be selected for listening from any of the lists by using the **Media Dial** to scroll and highlight a selection and then pressing the **Select** button.

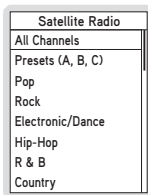

Figure 2



Figure 3

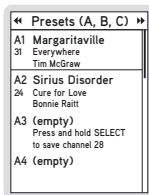

Figure 4



Figure 5

The **Display** button toggles the display screen between the normal/near and car/far channel list mode. (Figures 6 & 7) The car/far mode displays the text in a larger size for easier viewing from a distance.



Figure 6



Figure 7

CHANNEL PRESETS

Channels which you tune frequently and want to be able to access quickly may be added to a list of presets. Presets are grouped into three banks, A, B, and C which store 10 presets each for a total of 30 presets. Presets are displayed as A1, A2, B1, B2, etc. (Figure 4)

Tuning to a Saved Preset

Saved presets may be selected by browsing the Presets category:

1. Select *Presets (A, B, C)* from the *Satellite Radio* screen. (Figure 2)
2. Use ◀◀ Rewind and ▶▶ Fast Forward to navigate between the A, B, and C banks of presets. (Figure 4)
3. Use the ● Media Dial to highlight a preset and press the ● Select button.

Saving Channels as Presets

To save a channel as a preset:

1. Tune to the desired channel.
2. Press the  Options button.
3. Highlight *Save Channel as Preset* and press the ● Select button. (Figure 8)
4. The *Presets (A, B, C)* screen will be displayed. Use ◀◀ Rewind and ▶▶ Fast Forward to navigate between the A, B, and C banks of presets, and use the ● Media Dial to highlight the preset where you want the channel saved. Press and hold the ● Select button to save the channel as a preset.

If you have chosen a preset which has already been assigned to a channel, the preset will be replaced with the new channel.

Removing a Channel Preset

To remove a channel as a preset:

1. Select *Presets (A, B, C)* from the *Satellite Radio* screen. (Figure 2)
2. Use ◀◀ Rewind and ▶▶ Fast Forward to navigate between the A, B, and C, banks of presets. (Figure 4)
3. Use the ● Media Dial to highlight the preset you want to remove and press the ◻ Options button.
4. Highlight *Remove this Preset* and press the ● Select button to remove the preset. (Figure 9)



Figure 8

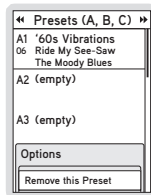

Figure 9

PAUSING, REWINDING, AND REPLAYING LIVE RADIO

While listening to satellite radio, up to the most recent 60 minutes of the broadcast may be put into a temporary replay buffer. At any time you may rewind to replay something you just heard or you may press **||** Play/Pause to pause the live broadcast. You may resume listening to the broadcast at any time, beginning from the point where the broadcast was paused, or you can fast-forward or rewind through the replay buffer, pause the replay buffer again, or return to the live broadcast.

The replay buffer is retained until the memory becomes full. When memory becomes full, the oldest part of the replay buffer is deleted to make room for the new material so that the live broadcast can continue to be added to the replay buffer. The replay buffer is discarded when the Stiletto 2 is either turned off or tuned to another channel or to a playlist.

Pausing a Live Broadcast

To pause a live broadcast:

1. Press **||** Play/Pause to pause a live broadcast.
2. The audio will mute and a time bar will be shown near the bottom of the display screen indicating how much of the replay buffer is filled with the broadcast. (Figure 10)



Figure 10

Playing a Paused Broadcast

Press **||** Play/Pause to begin playing a paused broadcast from the point at which it was paused. To jump ahead to the live broadcast, press **▶▶** Fast-Forward until you reach the live broadcast.

Fast-Forwarding and Rewinding Through Broadcasts

Press ►► Fast-Forward or ◀◀ Rewind to navigate through the replay buffer. Pressing and releasing moves forwards or backwards to the start of the next or previous segment.

Pressing and holding ►► Fast-Forward or ◀◀ Rewind moves progressively faster forward or backwards in the buffer.

As you fast-forward or rewind, the ♦ diamond indicator in the time bar will move to show your current playback position relative to the live broadcast. (Figures 11 & 12)



Figure 11

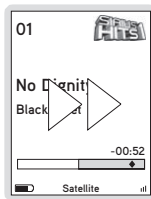

Figure 12

SAVING CONTENT FROM A LIVE BROADCAST

Songs and shows can be saved by using ♥ Love when listening to a live satellite broadcast. When saving a song or show, it is recorded exactly as it was broadcast. If a channel is tuned in the middle of playing a song/show that you want to save, the song/show is saved from the point at which you tuned to the channel.

Note: Saving songs and shows using ♥ Love is only possible while in Satellite Radio mode. The feature is not enabled when listening to Internet Radio.

The Stiletto 2 limits the amount of songs saved using ♥ Love to a total of 10 hours. If you exceed that limit, the oldest songs “recorded from SIRIUS” will be automatically deleted to make space for new loved songs. Displayed messages will appear to remind you that you may lose older music and that you can keep tracks permanently by downloading authorized MP3 or WMA files from your personal collection or any Windows Media based online music service.

To delete content, refer to the section **Deleting Content From the Library** on page 51.

Saving a Song or Show

To save a song or show as it is playing:

1. Press ♥ Love to begin saving the song/show.
2. While the song/show is being saved, the love icon will be displayed briefly, and then the ♥ heart icon is displayed at the bottom center until the content has finished saving. (Figure 13)
3. The song/show is saved in the Library. Refer to the **Library** section on page 45 for information on playing back the song/show.
4. The Stiletto 2 will attempt to retrieve as much of the elapsed song or show as is available in the replay buffer.

If you attempt to tune away before the song/show is complete, or fast-forward or rewind, you will be prompted to confirm that you wish to stop recording. You may continue recording, or save or discard the partial recording. (Figure 14)

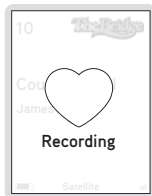

Figure 13



Figure 14

Recording a Block of Time

To record a concert or a whole talk or entertainment show, a block of time can be selected for recording using ♥ Love. Time recordings are limited to a maximum duration of 6 hours.

To record a block of time:

1. Press and hold ♥ Love to begin the recording. You will be prompted to select to record to the next hour (for example, *Record until 7:00 PM*), or to select *Recording options...* where you can customize the recording. (Figure 15) If you select to record to the next hour, recording will begin immediately.

- If you have chosen *Recording options...*, you will be presented with a screen where you can change the parameters for the recording. (Figure 16)
- Use the **●** Media Dial to highlight the parameter you want to change and press the **●** Select button.
- Use the **●** Media Dial to scroll and change the parameter. When your selection is complete, press the **●** Select button.
- When all the parameters have been set, use the **●** Media Dial to highlight *Done* and press the **●** Select button. The recording will then begin if you have set the parameters to begin immediately. The **♡** heart icon will be displayed at the bottom center of the screen to indicate that a recording is in progress. (If you have selected for the recording to begin at a later time, the recording will begin at the scheduled time. Refer to the **Recording** section on page 57 for more information.)
- The recording is saved in the Library. Refer to the **Library** section on page 45 for information on playing back the recording.

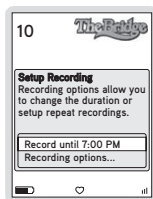

Figure 15

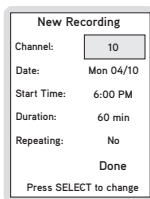

Figure 16

OTHER FEATURES

Game Alert and Sports Ticker

You can program the Stiletto 2 to remember your favorite sports teams and automatically alert you when any of your favorite sports teams are playing in a game (Figure 19), or display a sports ticker while a game is in progress. (Figure 20) There is no limit on the number of teams you can select for game alerts or sports ticker.

Adding and Removing Favorite Teams for Game Alerts and Sports Ticker

To add or remove favorite teams for game alerts and sports ticker:

1. From the Home screen select *Settings* → *Sports* → *Favorite Teams* and select the sports league or college for the team you want to add or remove. (Figure 17) →
→ To add teams for game alerts and/or sports ticker, select an individual team. (Figure 18)
Press the ● Select button once to mark the team for sports ticker, or twice to select the team for sports ticker and game alert. If you only want game alert for the selected team press the ● Select button a third time. Selected teams will have the ticker and/or alert boxes next to the team name highlighted.

Tip: To add all teams in the list, press the  Options button and choose *Select All*.

- To remove teams from game alerts and sports ticker, select the team you want to remove. Repeatedly press the ● Select button until the team is deselected. The highlighting will be removed indicating the team is no longer selected for sports ticker or game alert.
2. You may continue selecting or removing teams from other sports leagues by using the  Back button to navigate back in the menu structure to select another league or college.

Favorite Teams	
NASCAR	[Set]
NFL Football	[3]
NBA Basketball	[0]
NHL Hockey	[0]
College Football	[0]
College Basketball	[0]

Figure 17

NFL Football	
49ers	
Bears	
Bengals	
Bills	
Broncos	
Browns	
Buccaneers	
Cardinals	

Figure 18

19 BUZZSAW	
Dio	
Rainbow In The Dark	
Game Alert Eagles vs Giants (bdcast) NFL Pregame On channel 123	
Satellite <small>off</small>	

Figure 19

19 BUZZSAW	
Dio	
Rainbow In The Dark	
Sports Ticker	
Jets	41
Patriots (bdcast)	17
40	
Satellite <small>off</small>	

Figure 20

Whenever you're listening to Satellite Radio, either live or from the replay buffer, you'll receive an alert if any of your favorite teams are playing. (Figure 19) If you wish to tune to the channel playing the game, press the Options button and select the *Listen to...* option.

If you have selected a sports ticker for your favorite teams, a sports ticker will be displayed whenever any of your teams are playing. (Figure 20)

Tip: Pressing the Back button temporarily dismisses the sports ticker for 10 seconds.

Game Zone

The Game Zone category lists all the sports games which are currently playing for your favorite teams, and can be browsed for the games scores. (Figure 21) You can scroll through the list and select a game to tune to the channel where the game is being broadcast.

« Game Zone »	
Jets	21
Patriots (bdcast)	17
40	
Colts	28
Titans (bdcast)	24
30	
Bills	17
Jets	21
20	
Ravens (bdcast)	9
Browns	3
10	

Figure 21

Parental Controls

The parental controls feature sets a password for access to specific channels. This will prevent access to these locked channels until the password is entered. (Figure 22)

No details about the current content of a locked channel will be displayed. When you attempt to access a locked channel, you will be prompted to enter your password before you can proceed. (Figure 23) The parental control feature is accessed through the *Settings* menu, as described in **Parental Controls** on page 65.

Hiding channels and genres, as described in the next section, can be an alternative to locking channels.



Figure 22

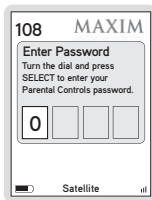

Figure 23

Hide Channels and Genres

The hide feature allows you to designate channels and genres to not be displayed when browsing channel and genre lists. The hide feature differs from the parental control lock feature in that a locked channel will be displayed while browsing a list (but is password protected), while a hidden channel will never appear in a list.

Hidden channels are not locked, but can only be tuned by directly entering the channel number using the numeric keypad on the remote control when the Stiletto 2 is in a docking station. The hide feature is accessed through the *Settings* menu, as described in **Hidden Channels** on page 62.



Internet Radio

Internet Radio allows you to listen to all of the SIRIUS music channels and select talk channels live using a wireless internet connection (Wi-Fi). Your SIRIUS subscription includes standard Sirius Internet Radio streaming at 64Kbps. The Stiletto 2 also supports SIRIUS's Premium Internet Radio service streaming at 128Kbps and offering superior audio quality. Premium Internet Radio service may require an additional subscription charge.

Note: Because Internet Radio is streamed and not broadcast, certain features available when listening to Satellite Radio are not supported. It is not possible to record any material from Internet Radio or pause and rewind live content.

To access Internet Radio on your Stiletto 2, from the Home screen use the ● Media Dial to highlight Internet Radio and press the ● Select button.