

# STILETTO

Vehicle Kit



## Installation & User Guide

## **Congratulations on the Purchase of your new SIRIUS Stiletto Vehicle Kit!**

The Stiletto Vehicle Kit will maximize your safety and provide convenience by positioning the Stiletto for easy viewing and operation. Whether you choose the FM wireless or direct connect option when installing the kit, the rich digital sound of SIRIUS radio will play through your vehicle's stereo system. The vehicle dock features preset and direct tune buttons for quickly tuning to your favorite channels. It is designed for professional or self-installation, and includes a vent and dash mount for flexible mounting options. Use this manual as a guide for the installation.

The SIRIUS Stiletto Vehicle Kit will work with the Stiletto model satellite radios.

For the latest information about this and other SIRIUS products and accessories, visit <http://www.siriuscanada.ca>.



# Table of Contents

<b>TABLE OF CONTENTS.</b>	<b>3</b>
<b>WARNING AND SAFETY INFORMATION.</b>	<b>4</b>
IC Caution Statement	4
Safety Precautions.	4
Warnings	5
<b>PACKAGE CONTENTS.</b>	<b>7</b>
<b>CONTROLS</b>	<b>9</b>
Vehicle Dock	9
Remote Control Reference Guide.	11
Remote Control Battery Installation	15
<b>INSTALLATION</b>	<b>16</b>
Installing the Vehicle Kit.	16
Installing the Antenna	21
Connecting the Cigarette Lighter Adapter	24
Docking and Un-docking the Stiletto	25
Maximizing Audio Quality From Your Stiletto Radio	26
Wireless Connection	26
Direct Connections	39
Subscribing to the SIRIUS Service	42
<b>OPERATION</b>	<b>43</b>
Presets	43
Direct Channel Tuning	44
<b>TROUBLESHOOTING</b>	<b>45</b>
<b>OPTIONAL ACCESSORIES.</b>	<b>46</b>
<b>WARRANTY</b>	<b>47</b>
<b>SPECIFICATIONS.</b>	<b>48</b>
<b>COPYRIGHTS &amp; TRADEMARKS</b>	<b>49</b>
<b>SIRIUS ID</b>	<b>50</b>

## **Federal Communication Commission Interference Statement**

This equipment has been tested and found to comply with the limits for a Class B digital device, pursuant to Part 15 of the FCC Rules. These limits are designed to provide reasonable protection against harmful interference in a residential installation. This equipment generates, uses and can radiate radio frequency energy and, if not installed and used in accordance with the instructions, may cause harmful interference to radio communications. However, there is no guarantee that interference will not occur in a particular installation. If this equipment does cause harmful interference to radio or television reception, which can be determined by turning the equipment off and on, the user is encouraged to try to correct the interference by one of the following measures:

- Reorient or relocate the receiving antenna.
- Increase the separation between the equipment and receiver.
- Connect the equipment into an outlet on a circuit different from that to which the receiver is connected.
- Consult the dealer or an experienced radio/TV technician for help.

FCC Caution: Any changes or modifications not expressly approved by the party responsible for compliance could void the user's authority to operate this equipment.

This device complies with Part 15 of the FCC Rules. Operation is subject to the following two conditions: (1) This device may not cause harmful interference, and (2) this device must accept any interference received, including interference that may cause undesired operation.

The antenna(s) used for this transmitter must not be co-located or operating in conjunction with any other antenna or transmitter.

# Warning and Safety Information

## IC Caution Statement

"Operation is subject to the following two conditions: (1) this device may not cause interference, and (2) this device must accept any interference, including interference that may cause undesired operation of the device."

"To reduce potential radio interference to other users, the antenna type and its gain should be so chosen that the equivalent isotropically radiated power (EIRP) is not more than that required for successful communication".

"This device has been designed to operate with an antenna having a maximum gain of [2] dBi. Antenna having a higher gain is strictly prohibited per regulations of Industry Canada. The required antenna impedance is 50 ohms."

"To reduce potential radio interference to other users, the antenna type and its gain should be so chosen that the equivalent isotropically radiated power (e.i.r.p.) is not more than that permitted for successful communication."

This device and its antenna(s) must not be co-located or operating in conjunction with any other antenna or transmitter.

## Safety Precautions

Be sure to observe the following warnings. Failure to follow these safety instructions and warnings may result in a serious accident and/or personal injury.

- Installation must be performed according to this installation guide. SIRIUS is not responsible for issues arising from installations not performed according to the procedures in this guide.
- Do not operate the SIRIUS radio in a way that might divert your attention from driving safely. As a driver, you alone are responsible for safely operating your vehicle in accor-

dance with traffic safety laws at all times.

- Do not install the unit where it may obstruct your view through the windshield, or of your vehicle's indicator displays.
- Do not install the unit where it may hinder the function of safety devices such as an airbag. Doing so may prevent the airbag from functioning properly in the event of an accident.
- To avoid short circuits, do not open the unit, and never put or leave any metallic objects (coins, tools, etc.) inside the unit.
- If the unit emits smoke or unusual odors, turn the power off immediately, and disconnect the unit from any power source.
- Do not drop the unit or subject it to strong shocks.
- The installation and use suggestions contained in this installation manual are subject to any restrictions or limitations that may be imposed by applicable law. The purchaser should check applicable law for any restrictions or limitations before installing and/or operating this unit.
- Do not install the FM Extender Cable where it will hinder or block your view. In some states it may be illegal to mount it on the windshield of your vehicle. Check applicable law for any restrictions or limitations before installing the extender cable on your windshield.
- Do not install the FM Extender Cable where it may hinder the function of safety devices such as an airbag. Doing so may prevent the airbag from functioning properly in the event of an accident.

## Warnings

### **Operating Temperature**

The SIRIUS Cigarette Lighter Adapter is designed to operate between -20° to +85° C (-4° to +185° F). Avoid leaving it in a vehicle or elsewhere where the temperature may fall outside this range.

### **Cleaning and Maintenance**

If the vehicle dock becomes dirty, turn the power off and wipe it clean with a soft cloth. Do not use hard cloths, strong cleaning fluids, paint thinner, alcohol, or other volatile solvents to

clean. These may cause damage to the unit.

**Cigarette Lighter Adapter**

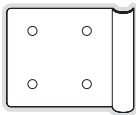
The vehicle dock cannot be powered directly from a vehicle's 12 VDC power system. It must be powered using the included Cigarette Lighter Adapter only. Connecting the vehicle dock directly to the vehicle's 12 VDC power system may result in damage to the vehicle dock or SIRIUS radio, or both.

# Package Contents

The following items are included with your purchase of the SIRIUS Stiletto Vehicle Kit. Unpack the kit carefully and make sure that everything shown is present. If anything is missing or damaged, or if the kit fails to operate properly, notify your dealer immediately. It is recommended that you retain the original carton and packing materials in case you need to ship your kit in the future.



**Vehicle Dock**



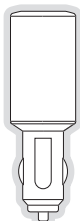
**Vehicle Dock  
Finger Grip**



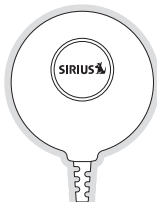
**Vehicle Mounts**



**Remote Control**



**Cigarette Lighter  
Adapter**



**Magnetic  
Antenna**



**Antenna  
Cover/Tail**

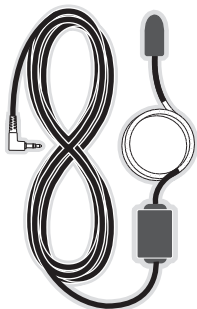


**Mounting  
Screws**

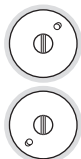


**Alcohol Swab**





**FM Extender Cable**



**Suction Cups (2)**

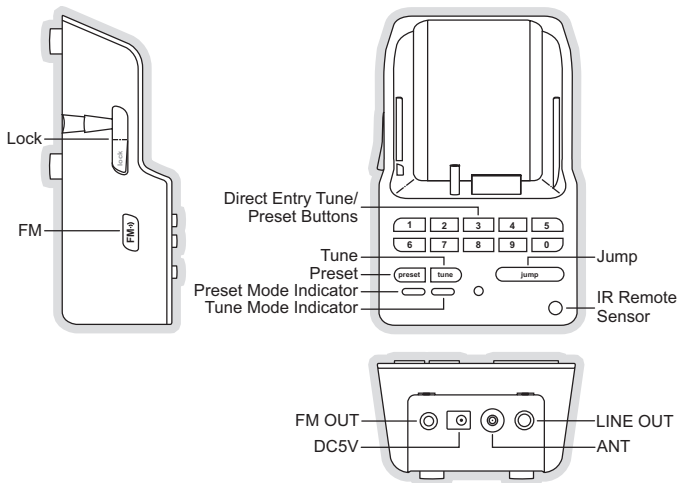


**Self Adhesive  
Cable Guides (3)**

# Controls

## Vehicle Dock

Figure 1 and the table following identify and describe the buttons, connectors, and features of the vehicle dock.



**Figure 1**

<b>Vehicle Dock Button and Connector Descriptions</b>		
<b>Button/ Connector</b>	<b>Action</b>	<b>Description</b>
<b>0 - 9</b>	Press	<i>In Tune Mode:</i> Directly selects the channel indicated by the numbers which were pressed <i>In Preset Mode:</i> Selects presets 0 - 9
<b>tune</b>	Press	Changes to the direct tuning mode where channel numbers may be entered
<b>preset</b>	Press	Changes to the preset mode and displays the list of preset channels The second and subsequent press cycles through the preset banks, A, B, and C
<b>jump</b>	Press	Jumps to a preselected traffic/weather channel A second press returns to the previous channel or song/show
<b>FM</b>	Press	Displays the FM Frequency screen where the FM transmitter frequency can be selected, or an FM preset selected using the 0 - 9 buttons
<b>Lock</b>	Toggle	Secures the Stiletto in the vehicle dock
<b>FM OUT</b>	This connection is used for the FM Extender Cable (or optional FM Direct Adapter which directly connects to the vehicle's FM radio antenna input)	
<b>DC 5V</b>	Connection for the Cigarette Lighter Adapter	
<b>LINE OUT</b>	Audio output for direct connection to the vehicle's audio system. An audio cable (not supplied) is required to utilize this connection	
<b>ANT</b>	Connection for the Magnetic Antenna	

## Remote Control Reference Guide

Figure 2 and the table following identify and describe the buttons of the remote control. The remote control works when the Stiletto is in the vehicle dock.

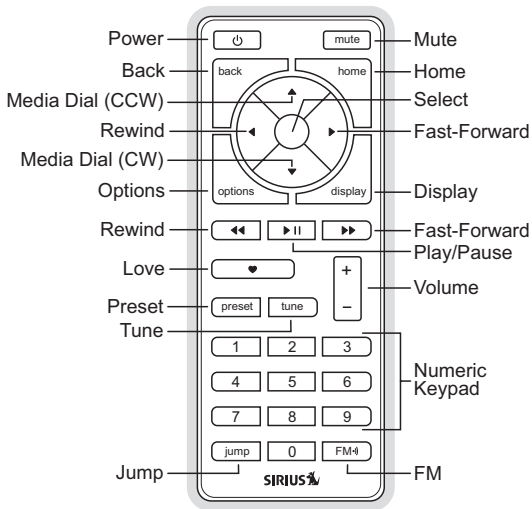














Figure 2


<b>Remote Control Button Descriptions</b>				
<b>Button</b>	<b>Action</b>	<b>Satellite Radio Environment</b>	<b>Internet Radio Environment</b>	<b>Replay/Library Environment</b>
 <b>Power</b>	Press	Turns the Stiletto On/Off		
<b>Mute</b>	Press	Mutes (or un-mutes) the audio		
 <b>Up/Down</b>	Press	Pressing Up is equivalent to turning the Media Dial counter-clockwise Pressing Down is equivalent to turning the Media Dial clockwise If listening, displays channel or category list If in a list, menu, or prompt, scrolls to next or previous item		
 <b>Left/Right</b>	Press	Pressing Right is equivalent to Fast-Forward Pressing Left is equivalent to Rewind		
 <b>Select</b>	Press	Selects highlighted item in a list, menu, or prompt		
 <b>back</b>	Press	Returns back to the screen displayed just prior to the currently displayed screen		
 <b>home</b>	Press	First press returns to the Home screen Additional press returns to the Now Playing screen		
 <b>options</b>	Press	Displays available options for the currently displayed screen If no options are available, nothing is displayed		

**Remote Control Button Descriptions** *Continued*

<b>Button</b>	<b>Action</b>	<b>Satellite Radio Environment</b>	<b>Internet Radio Environment</b>	<b>Replay/Library Environment</b>
 <b>display</b>	Press	Cycles between 3-channel display mode, 6-channel display mode, artist name, and song title when in the channel browsing mode		
 <b>Play/Pause</b>	Press	Pauses a broadcast or resumes playing a paused broadcast	If playing, mutes audio If muted, resumes playing	Pauses or resumes playing the current song or show
 <b>Rewind</b>	Press	If listening, rewinds a broadcast to the previous song or show If in a channel or preset list, moves through categories or preset banks	If listening and muted, resumes playing If in a channel or category list, moves through channel categories	Skips to the beginning of the song or show
	Hold	If listening, rewinds through a broadcast		Rewinds through song or show
 <b>Fast-Forward</b>	Press	If listening, fast-forwards in the replay buffer to the next song or show If in a channel or preset list, moves through categories or preset banks	If listening and muted, resumes playing If in a channel or category list, moves through channel categories	Skips to the next song or show
	Hold	Fast-Forwards through the replay buffer		Fast-Forwards through song or show

**Remote Control Button Descriptions** *Continued*

<b>Button</b>	<b>Action</b>	<b>Satellite Radio Environment</b>	<b>Internet Radio Environment</b>	<b>Replay/Library Environment</b>
 <b>Love</b>	Press	Saves the song or show if possible, or adds to favorites when song/show cannot be saved  While recording, prompts to stop recording	Adds the artist/song to the favorites list	
	Hold	Displays recording setup screen  While recording, prompts to stop recording		
<b>+/-</b> <b>Volume</b>	Press	+ increases the audio volume - decreases the audio volume		
<b>preset</b>	Press	Changes to the preset mode and displays the list of preset channels  A second and subsequent press cycles through the preset banks, A, B, and C		
<b>tune</b>	Press	Changes to the direct tuning mode where channel numbers may be entered		
<b>0 - 9</b>	Press	<i>In Tune Mode:</i> Directly selects the channel indicated by the numbers which are pressed <i>In Preset Mode:</i> Selects presets 0–9		

Remote Control Button Descriptions <i>Continued</i>				
Button	Action	Satellite Radio Environment	Internet Radio Environment	Replay/Library Environment
jump	Press	Jumps to a preselected traffic/weather channel A second press returns to the previous channel or song/show		
 FM	Press	Displays the FM Frequency screen where the FM transmitter frequency can be selected, or an FM preset selected using the 0-9 buttons		

### REMOTE CONTROL BATTERY INSTALLATION

To install the remote control battery, locate the battery drawer on the bottom edge. Open the battery drawer by holding the latch tab to the right and sliding the drawer out as shown in Figure 3. Place the battery in drawer with the + side of the battery facing up and slide the drawer back into the remote control.

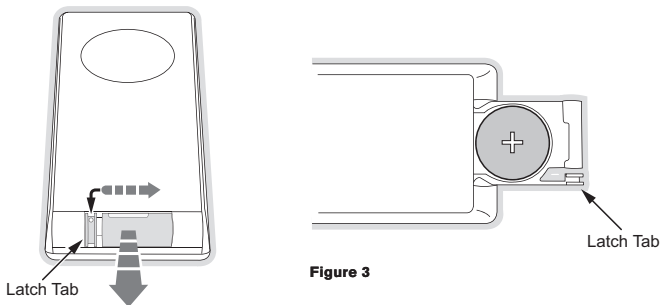



Figure 3



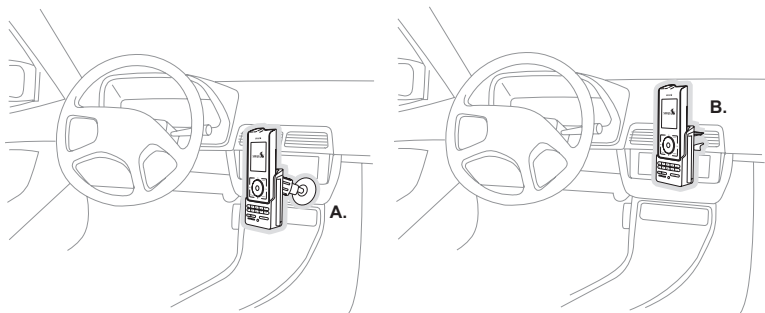
# Installation

SIRIUS suggests professional installation of this product in your vehicle. Professional installation provides an experienced technician to install this product in your vehicle, advice for selecting a suitable mounting location, installation of the antenna, and routing all the necessary wires and cables. An installer will have the necessary audio connection accessories to provide optimal audio output of the SIRIUS radio directly to your vehicle's audio system. Ask your SIRIUS retailer if they provide professional installation services, or can recommend a professional installation service.


## Installing the Vehicle Kit

When installing the vehicle dock, choose a location in your vehicle where the radio will not block your vision, interfere with the vehicle controls, or obstruct the air bag. The location should be easily accessible and provide good visibility of the display, and should not be located where it will be in direct sunlight which will affect the visibility of the display screen. The left side of the vehicle dock which has the Lock and  FM buttons should also not be obstructed.

The mounting accessories necessary to install the vehicle dock in a vehicle are provided. Figure 4 shows two examples of the Stiletto mounted in a vehicle: **A** is the console mount method using the adhesive mount, and **B** is the vent mount method.



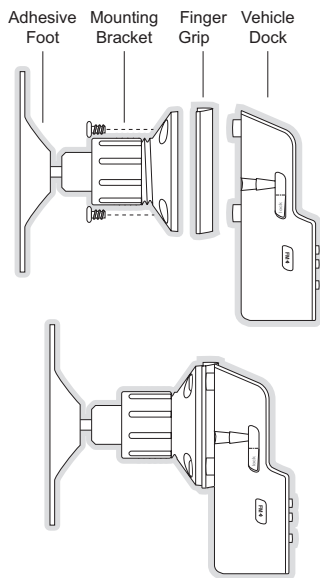
**Figure 4**

Depending upon the mounting method you select, the mount should be assembled as described in one of the following two sections. In choosing a mounting location, be sure that position chosen will not block access to the Lock and  FM buttons on the side of the vehicle dock.

### **Console Mount Method (A)**

To assemble and mount the vehicle dock for the console mount method **A** as shown in Figure 4:

1. Attach the adhesive foot to the vehicle dock using the provided screws, placing the finger grip between the adhesive foot and the vehicle dock. (Figure 5)
2. Before adhering the mount to the console, be sure to select your mounting position carefully because once the mount has been adhered to a surface, it will not be possible to remove it and adhere it again.
3. Clean the selected mounting surface area in the vehicle with the alcohol swab.
4. Unscrew the adhesive foot from the mounting bracket. Peel the protective material off the adhesive on the foot and press the foot firmly against the vehicle surface.
5. The adhesive mount should then be allowed to adhere for a minimum of 2-4 hours before use. Best adhesion occurs after 24 hours. When the adhesive foot has achieved sufficient adhesion, reattach the vehicle dock to the foot.

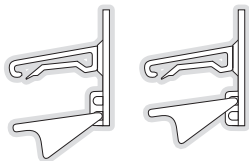


**Figure 5**

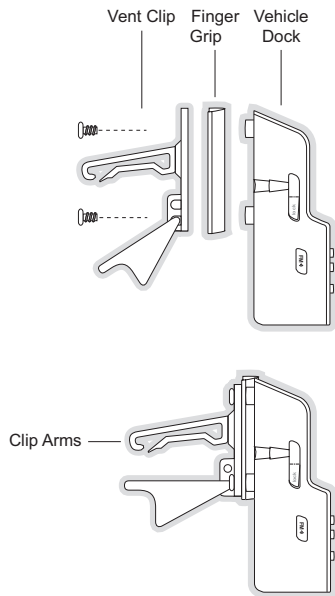
### Vent Mount Method (B)

To assemble and mount the vehicle dock for the vent mount method **B** as shown in Figure 4:

1. Assemble the vent mount clip as shown in Figure 6. Note that the lower arm may be attached in two different positions. You should assemble the vent clip in the configuration that works best in your particular vehicle. Figure 6 illustrates both possible configurations of the vent clip.
2. Attach the vent clip to the vehicle dock using the provided screws, placing the finger grip between the vent clip and the vehicle dock. (Figure 7)
3. Slide the vent clip portion of the mount into a vent in your vehicle, insuring that one of the vent louvers slides between the upper and lower portions of the two clip arms, and hooks the rear of the louver.



**Figure 6**



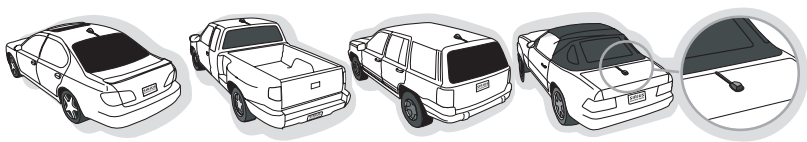
**Figure 7**

## Installing the Antenna

The optimum mounting location for the magnetic antenna is on the roof of the vehicle, with a minimum unobstructed area of 12 inches by 12 inches, and exactly 6½ inches from the rear roof edge of the vehicle (the length of the rubber antenna cable cover/tail). It is important to avoid any obstructions that will block the SIRIUS signal, obstructions such as a roof rack, a sunroof, roof mounted cargo containers, or other antennas. For convertible vehicles, the antenna should be installed on the trunk lid.

For best performance, it is recommended that the antenna be installed with the rubber antenna cable cover/tail. This rubber antenna cable cover/tail provides two benefits: first, it positions the antenna the recommended distance from the rear window, rear door/hatch, or trunk edge to give the antenna the best view of the sky. Secondly, it conceals and protects the exposed antenna cable. The rubber antenna cable cover/tail has adhesive strips that hold it securely in place.

The following illustrations show the recommended mounting locations of the antenna for several types of vehicles. (Figure 8) Follow these recommendations for best performance from the antenna.



**Figure 8**

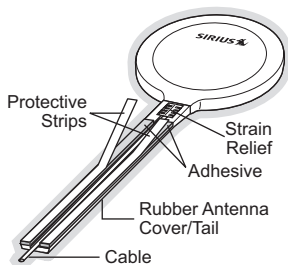
**Sedan/Coupe.** Mount the antenna along the rear center-line of the vehicle roof, located at the rear of the roof near the rear window.

**Pickup Truck.** Mount the antenna along the rear center-line of the cab roof, located at the rear of the roof near the rear window.

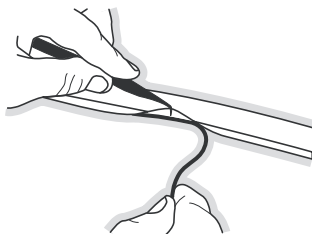
**SUV/Mini-Van.** Mount the antenna along the rear center-line of the vehicle roof, located at the rear of the roof near the rear door/hatch.

**Convertible.** Mount the antenna along the center-line of the trunk lid, with the rubber antenna cable cover/tail directed toward the rear window.

When you have selected a suitable mounting location, clean the area where the antenna and rubber antenna cable cover/tail will be mounted with the supplied alcohol swab.



**Figure 9**



**Figure 10**

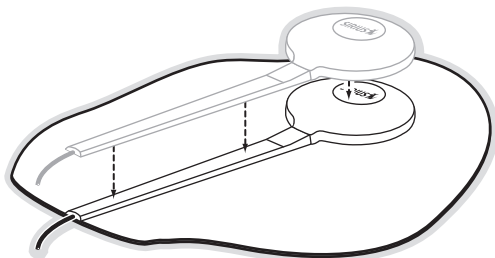
Connect the rubber antenna cable cover/tail to the antenna cable, making sure that the strain-relief on the antenna sits into the rubber antenna cable cover/tail groove. (Figure 9) Route the antenna cable through the wire channel in the rubber antenna cable cover/tail. Do not remove the protective strips yet.

Temporarily position the antenna and rubber antenna cable cover/tail in the selected mounting area and route the cable from the antenna to the vehicle's interior by tucking it underneath the rubber molding around rear window, as shown in Figure 10.

Route the cable from the lowest point of the rear window into the trunk. Take advantage of any existing cable channels or wiring conduits. For SUVs, mini-vans and 5-door vehicles, bring the cable into the vehicle under the rubber molding for the tailgate, and continue under the interior trim.

From the trunk, or rear of the vehicle, route the cable around the passenger compartment and to the front of the vehicle, to the radio. Take care not pull the cable across sharp edges that could damage it, and keep it away from areas where it might entangle feet. Coil any excess

antenna cable in a location where it can be hidden. Connect the antenna cable to the **ANT** connection at the rear of the vehicle dock. (Refer to Figure 12 on page 24 for the location of this connector.)



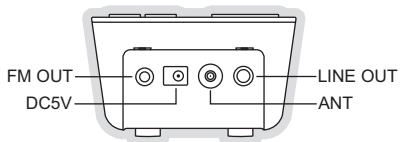
**Figure 11**

Once the antenna cable is routed through the vehicle, and you are satisfied with the cable routing, peel the protective material from the adhesive strips and press the rubber antenna cable cover/tail firmly into place on the vehicle. Double check that the location of the antenna and rubber antenna cable cover/tail are correct, and continue to press firmly down on rubber antenna cable cover/tail for another 30 seconds. (Figure 11) At room temperature (68 degrees), maximum adhesion usually occurs within 72 hours. During this period, avoid car washes and other contact with the antenna and rubber antenna cable cover/tail.



## Connecting the Cigarette Lighter Adapter

Connect the provided cigarette lighter adapter to the **DC5V** connection at the rear of the vehicle dock. (Figure 12)



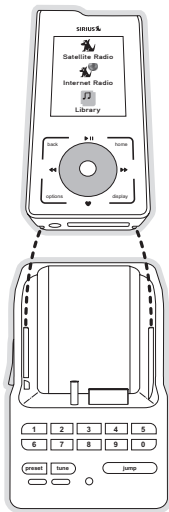
**Figure 12**

Do not use any other power adapter for the vehicle dock, or connect it directly to the vehicle's power. Doing so will damage the vehicle dock and the Stiletto. Using anything other than the supplied cigarette lighter adapter to power the vehicle dock will void the warranty.

## Docking and Un-docking the Stiletto

When docking the Stiletto, be sure the Lock button of the vehicle dock is in the unlocked position. (Refer to Figure 1 on page 9 for the location of the Lock button.) Grasp the vehicle dock with your free hand and place the Stiletto into the vehicle dock, as shown in Figure 13, and slide it down until it is fully seated. Place the Lock button into the locked position to secure the Stiletto in the vehicle dock.

To remove the Stiletto from the vehicle dock place the Lock button in the unlocked position. Grasp the vehicle dock with your free hand and pull the Stiletto up until it disengages from the vehicle dock.



**Figure 13**

## Maximizing Audio Quality From Your Stiletto Radio

There are two primary ways to connect your SIRIUS radio to your vehicle radio: **Wireless Connection** or **Direct Connection**. The following sections will help you obtain the best performance. For the latest information go to <http://www.siriuscanada.ca>.

### WIRELESS CONNECTION

Your SIRIUS radio contains an FM transmitter. The FM transmitter sends the audio from your SIRIUS radio to your vehicle radio. (Figure 14)

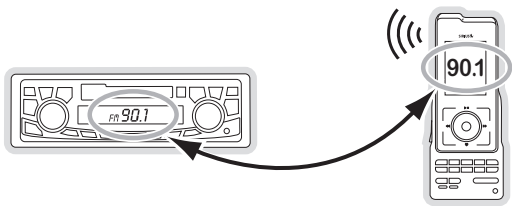


Figure 14

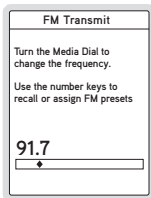
Included with your SIRIUS radio is an FM Extender Cable to maximize the audio quality of your SIRIUS radio when using a wireless audio connection. Should the wireless audio quality without the FM Extender Cable be not acceptable, you can try using the FM Extender Cable (or opt for a direct connection).

### Wireless Audio Connection Without the FM Extender Cable

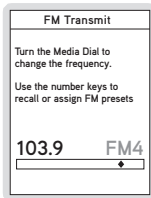
To tune your vehicle's FM radio and your SIRIUS radio to the same FM channel (Figure 14):

1. Turn off your Stiletto and tune through the FM channels on your vehicle's FM radio to locate an FM channel that is not broadcasting in your area. If you use an FM channel that is being used by a local broadcaster, it will interfere with the performance of your SIRIUS radio. Once you have located an FM channel that is not broadcasting in your area, save it as a preset on your vehicle radio. This will become your SIRIUS preset.
2. Power the Stiletto on. When it is completely powered up, press the **FM** button on

- the left side of the vehicle dock or press the **FM** button on the remote control.
- Use the **Media Dial** or the **Left Arrow** buttons on the remote control to select the same FM channel. (Figure 15) Press and hold a preset number (0–9) on the vehicle dock in which you want to store the selected FM channel as a preset. (Figure 16) Press the **Select** button to exit and transmit on the selected FM channel. The Stiletto will transmit on the selected FM channel.



**Figure 15**



**Figure 16**

**Note:** The FM transmitter in your SIRIUS radio is automatically set to FM channel 88.1. This may not be the best channel in your area.

**Tip:** If you regularly travel between cities with different active FM channels, you may need to find channels that are not broadcasting in each city. The Stiletto can store multiple FM transmit channels as presets, so you can easily switch to the best FM channel for each city. You will also want to set the FM channels that are not broadcasting in each city as presets on your vehicle radio.

You should now hear the audio from your SIRIUS radio over your vehicle's FM radio. If the audio quality is not satisfactory, you should install the FM Extender Cable as described in the following section (or use a direct connection as described on page 39).

### **Wireless Audio Connection Using the FM Extender Cable**

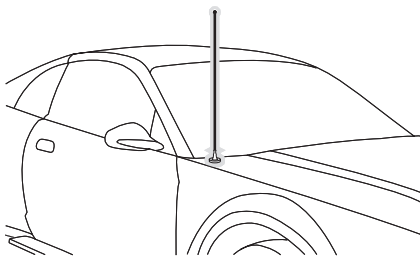
Included with your SIRIUS radio is an FM Extender Cable to maximize the audio quality of your SIRIUS radio when using a wireless audio connection. Proper placement of the FM Extender Cable inside your vehicle in close proximity to the vehicle's own FM antenna will provide

a strong FM signal for good reception. The FM Extender Cable has suction cup mounts or permanent adhesive mounts for installing it on your vehicle's window.

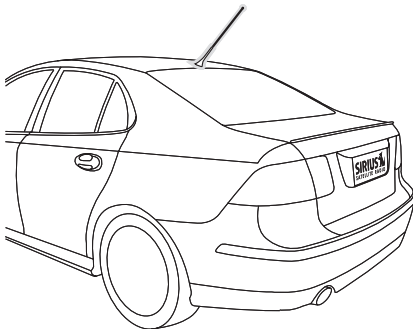
Because of the different types of FM antennas found in vehicles, and the varied locations of the antenna in each vehicle, SIRIUS suggests professional installation of FM Extender Cable in your vehicle. Ask your SIRIUS retailer if they provide professional installation services, or can recommend a professional installation service.

The FM antennas found in vehicles are of four distinct types:

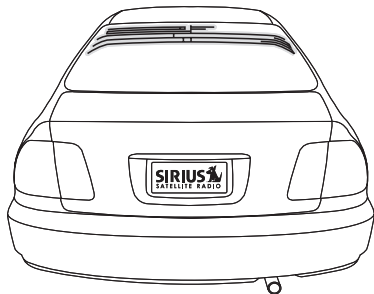
- **Aerial Type Fender Mounted FM Antenna:** A fixed or retractable aerial antenna located on the front or rear fender of the vehicle.



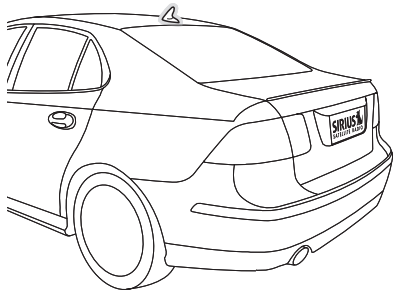
- **Aerial Type Roof Mounted FM Antenna:** A fixed aerial antenna mounted on the roof (often at the front or rear of the roof, just above the window glass).



- **On Glass Type FM Antenna:** Wires on the window glass of the vehicle, usually near the top of the window. It may be located on the windshield glass, the rear window glass, or a rear side window in some SUV and mini-van type vehicles (and other vehicles). It will look similar to the rear window defroster wires found in many vehicles.



- **"Shark Fin" Type FM Antenna:** A device resembling a shark fin (or other shape) located on the vehicle roof above the rear window.

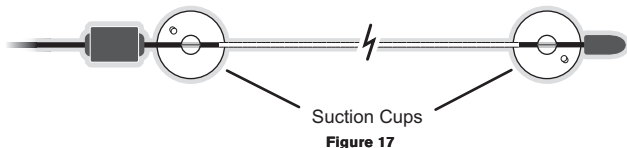


Before attempting installation, you should verify the type and location of the FM antenna in your particular vehicle. If you have trouble locating it, consult the manual which accompanied your vehicle, consult a dealer for your type of vehicle, or consult a professional installer.

The FM Extender Cable should be placed inside the vehicle, as close as possible to the vehicle's FM antenna. A test mounting should be done first using the included suction cup mounts to test the installation. Once an acceptable location has been found, you will remove the suction cups and permanently adhere the FM Extender Cable using the adhesive mounts.

To install the FM Extender Cable in your vehicle, follow these instructions:

1. Attach the suction cups to the FM Extender Cable in the positions shown in Figure 17.



2. In this step, follow the specific instructions in sub-step **a**, **b**, **c**, or **d** depending on the type of FM antenna in your vehicle:

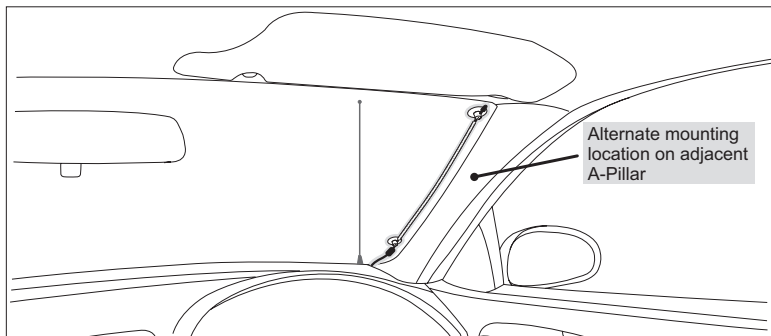
**a. Installation Instructions for Vehicles with Aerial Type Fender Mounted FM Antenna.**

For vehicles where the FM radio antenna is located on the front fender, the FM Extender Cable should be mounted vertically on the front windshield at the edge of the glass nearest to the antenna. (Figure 18)

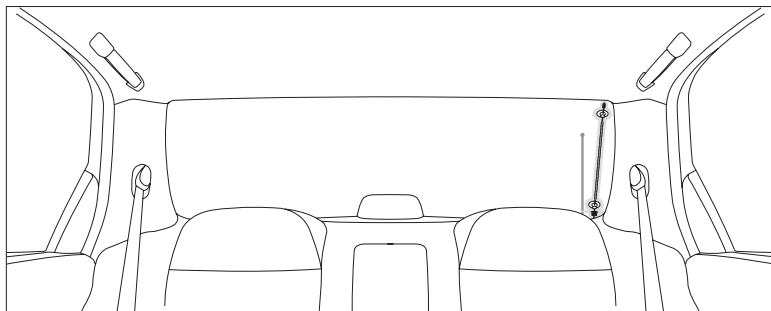
For vehicles where the FM radio antenna is located on the rear fender, the FM Extender Cable should be mounted vertically on the rear window at the edge of the glass nearest to the antenna. (Figure 19)

Attach the FM Extender Cable to the section of glass closest to the FM antenna in a vertical orientation. (Figure 18 or Figure 19) The wire between the two suction cups should be pulled taut and as straight as possible, and should not obstruct the driver's view.

**Important Caution:** In some states it may not be legal to put the FM Extender Cable on the windshield glass. In this case, the FM Extender Cable should be mounted on the A-Pillar adjacent to the FM antenna.



**Figure 18**



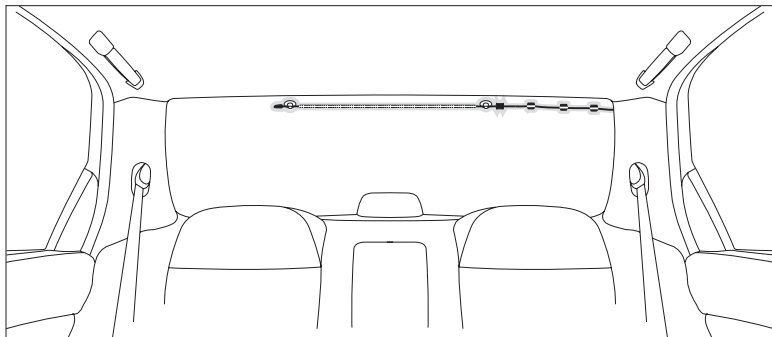
**Figure 19**



**b. Installation Instructions for Vehicles with Aerial Type Roof Mounted FM Antenna.**

For vehicles where the FM radio antenna is located on the front or rear of the roof of the vehicle, the FM Extender Cable should be mounted horizontally on the front or rear glass below the FM antenna, or installed into the headliner of the vehicle under the FM antenna.

- If you are installing the FM Extender Cable on the window glass, attach the suction cups to the glass under the FM antenna in a horizontal orientation. The wire between the two suction cups should be pulled taut and as straight as possible, and should not obstruct the driver's view. (Figure 20)
- If you are installing the FM Extender Cable into the headliner, remove the suction cups and tuck the wire into the headliner, stretched taut and straight, and centered under the FM antenna.

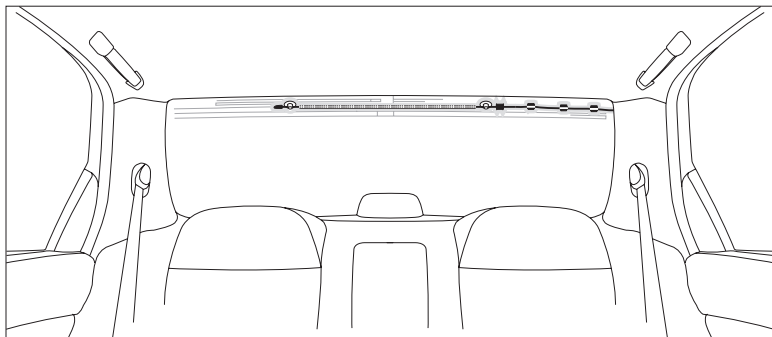


**Figure 20**

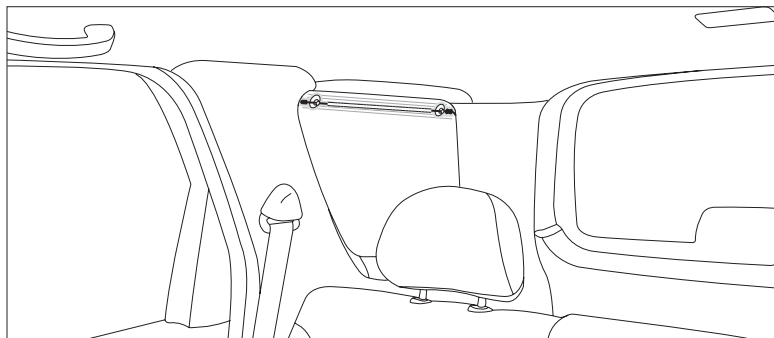
**c. Installation Instructions for Vehicles with On Glass Type FM Antenna.**

For vehicles where the FM radio antenna is located on the window glass, the FM Extender Cable can be mounted horizontally on the glass, directly over the FM radio antenna, or installed into the headliner of the vehicle directly above the FM antenna.

- If you are installing the FM Extender Cable on the window glass, attach the suction cups to the glass centered over the FM radio antenna in a horizontal orientation. The wire between the two suction cups should be pulled taut and as straight as possible, and should not obstruct the driver's view. (Figure 21 & 22)
- If you are installing the FM Extender Cable into the headliner, remove the suction cups and tuck the wire into the headliner, stretched taut and straight, and centered above the FM antenna.



**Figure 21**

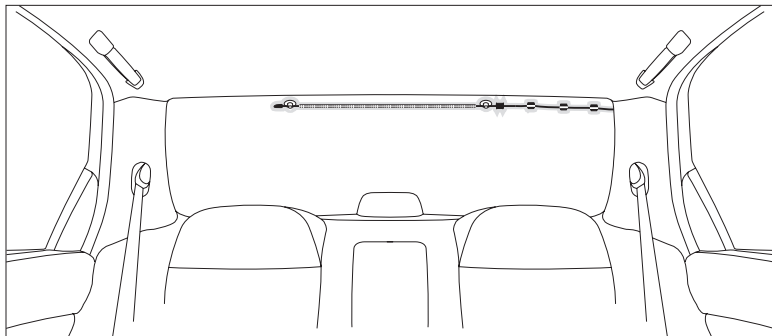


**Figure 22**

**d. Installation Instructions for Vehicles with Shark Fin Type FM Antenna.**

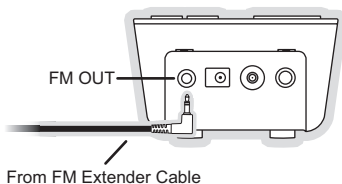
For vehicles where the FM radio antenna is located on the rear of the roof of the vehicle, the FM Extender Cable should be mounted horizontally on the glass below the FM antenna, or installed into the headliner of the vehicle under the FM antenna.

- If you are installing the FM Extender Cable on the window glass, attach the suction cups to the glass below the FM antenna in a horizontal orientation. (Figure 23) The wire between the two suction cups should be pulled taut and as straight as possible, and should not obstruct the driver's view.
- If you are installing the FM Extender Cable into the headliner, remove the suction cups and tuck the wire into the headliner, stretched taut and straight, and centered under the FM antenna.



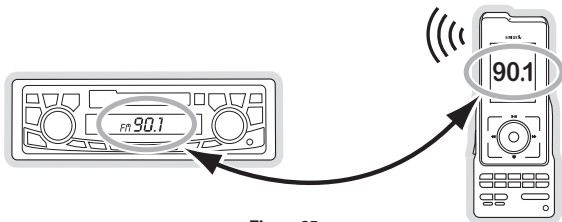
**Figure 23**

3. Plug the FM Extender Cable into the **FM OUT** connector of your Stiletto vehicle dock. (Figure 24)








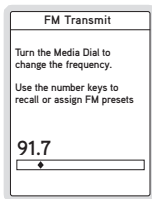
**Figure 24**

4. Tune your vehicle's FM radio and your Stiletto to the same FM channel (Figure 25):
  - a. Turn off your Stiletto and tune through the FM channels on your vehicle's FM radio to locate an FM channel that is not broadcasting in your area. If you use an FM channel that is being used by a local broadcaster, it will interfere with the performance of your SIRIUS radio. Once you have located an FM channel that is not broadcasting in your area, save it as a preset on your vehicle radio. This will become your SIRIUS preset.

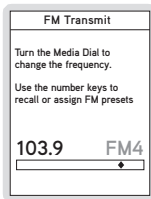


**Figure 25**

- b. Power the Stiletto on. When it is completely powered up, press the  FM button on the left side of the vehicle dock or press the  FM button on the remote control.
- c. Use the  Media Dial or the  buttons on the remote control to select the same FM channel. (Figure 26) Press and hold a preset number (0–9) on the vehicle dock in which you want to store the selected FM channel as a preset. (Figure 27) Press the  Select button to exit and transmit on the selected FM channel. The Stiletto will transmit on the selected FM channel.



**Figure 26**



**Figure 27**

**Note:** The FM transmitter in your SIRIUS radio is automatically set to FM channel 88.1. This may not be the best channel in your area.

**Tip:** If you regularly travel between cities with different active FM channels, you may need to find channels that are not broadcasting in each city. The Stiletto can store multiple FM transmit channels as presets, so you can easily switch to the best FM channel for each city. You will also want to set the FM channels that are not broadcasting in each city as presets on your vehicle radio.

5. You should now hear the audio from your SIRIUS radio over your vehicle's FM radio. If the audio quality is not satisfactory, try moving the FM Extender Cable slightly to see if a better signal can be obtained.
6. *If you are mounting the FM Extender Cable in the headliner of the vehicle, skip this step.* When you are satisfied with the mounting location, remove the suction cup mounts and peel the backing off the adhesive mounts. Permanently adhere it in the same position on the glass (or A-Pillar), keeping it taut and as straight as possible. (Figure 28)



**Figure 28**

7. Route the antenna cable to your SIRIUS radio. Use the included self adhesive cable guides (if necessary) to hold the antenna wire in place until it reaches the weather stripping or moulding at the edge of the window. Take advantage of any existing cable channels or wiring conduits and route the cable around the passenger compartment to the vehicle dock. Take care not pull the cable across sharp edges that could damage it, and keep it away from areas where it might entangle feet. Coil and secure any excess antenna cable in a location where it can be hidden and secured.
8. Plug the FM Extender Cable into the **FM OUT** connector of your Stiletto vehicle dock (Refer to Figure 24 on page 36.)

This completes the installation of the FM Extender Cable.

***To assign additional FM channels as FM presets in your Stiletto:***

1. Press the **FM-4** FM button on the left side of the vehicle dock or press the **FM** button on the remote control.
2. Use the **Media Dial** or the **Left Arrow** buttons on the remote control to select an FM channel.
3. Press and hold the preset number (0-9) in which you want to store the selected FM channel. Repeat steps 2 and 3 to assign additional FM presets.
4. Press the **Select** button to exit and transmit on the selected FM channel, or press the **FM-4** FM button to simply exit.

If you're not sure which FM channels are not broadcasting in your home or travel cities, you can also go to <http://www.siriuscanada.ca>.

## DIRECT CONNECTIONS

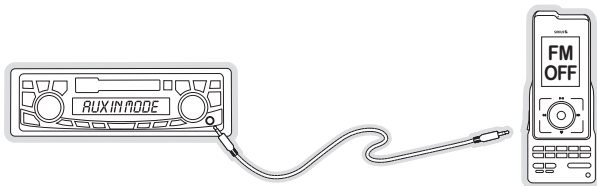
A direct connection provides better audio performance than a wireless connection and removes the possibility of interference from local FM broadcasters. There are several ways to directly connect your Stiletto which are explained in the following sections.

**Tip:** Depending on the model of radio in your vehicle and your level of comfort with in-car installations, a direct connection may require professional installation assistance. Ask your retailer or contact SIRIUS customer support for recommended installers in your area.

### Direct Wired Audio Connection

If your vehicle radio offers an “AUX IN” or “LINE IN” connection, it is the best audio connection available. If the “AUX IN” or “LINE IN” connector is located on the front of your vehicle radio, this is also the easiest connection. (Figure 29)

1. Purchase an audio cable that matches the connection type of your vehicle radio and your SIRIUS radio at your local electronics retailer. Your SIRIUS radio requires a 1/8" stereo male connector. Your local electronics retailer can help you determine the proper connection for your vehicle radio.
2. Plug one end of the cable into the **LINE OUT** jack on the vehicle dock. (Refer to Figure 12 on page 24.) Plug the other end into your “AUX IN” or “LINE IN” jack on your vehicle radio.

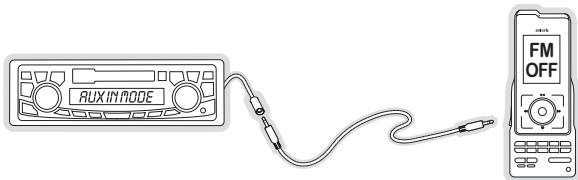


**Figure 29**

**Note:** Refer to your vehicle radio manufacturer’s guidelines for correct installation.

**Note:** If the “AUX IN” or “LINE IN” connection is on the back of your vehicle radio, you may want to consider professional installation. (Figure 30)





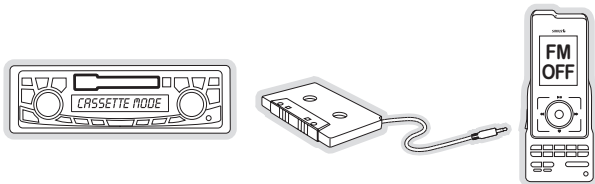
**Figure 30**

### **Cassette Adapter**

If your vehicle radio has a cassette player:

1. Purchase a Cassette Adapter at your local electronics retailer.
2. Connect the adapter between the **LINE OUT** on the vehicle dock (refer to Figure 12 on page 24), and the vehicle radio's cassette slot. (Figure 31)

**Note:** Refer to the cassette adapter manufacturer's guidelines for correct use.



**Figure 31**

### SIRIUS FM Direct Adapter

If your vehicle radio does not have an “AUX IN” or “LINE IN” jack, the SIRIUS FM Direct Adaptor provides a wired connection between your Stiletto and your vehicle radio, eliminating the outside static and interference you sometimes experience when using a wireless FM connection. (Figure 32) Professional installation may be required. See your local SIRIUS retailer. (The SIRIUS FM Direct Adapter is available at your local SIRIUS retailer or at <http://www.siriuscanada.ca>.)

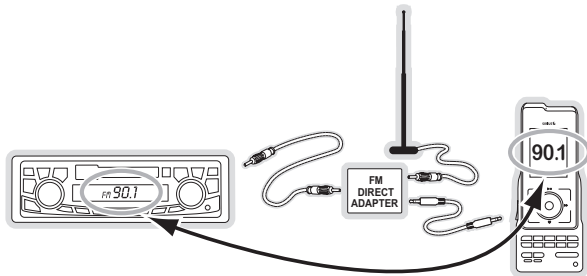





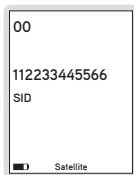
Figure 32

## Subscribing to the SIRIUS Service

Before you can listen to the SIRIUS service, you need to activate your subscription. To subscribe, do the following:

1. Before activating your Stiletto, be sure you have installed the vehicle kit as described in the previous sections. Place the Stiletto in the vehicle dock and power it on by sliding the  Power/Lock switch down.
2. When the Stiletto has fully powered on, from the Home screen select *Satellite Radio* → *All Channels* and tune to channel 184. The SIRIUS channel line-up will begin updating. Wait until the channel updates have completed before pressing any buttons.
3. Once the channels have been updated, the display will change to *Call 1-888-539-SIRIUS to Subscribe*. You should be able to hear audio from channel 184, the SIRIUS Weather and Emergency channel.
4. Use the  Media Dial to tune to channel 0 to display the Stiletto's unique 12-digit SIRIUS ID Number (SID). (Figure 33) The SID number is also available on the Stiletto's packaging, and may also be accessed by selecting *Settings* → *Device* → *Sirius ID*. Write the SID number down in the space provided near the end of this installation guide.
5. Have your credit card handy and contact SIRIUS on the Internet at:  
<https://www.siriuscanada.ca/activate/>  
and follow the prompts to activate your subscription. You can also call SIRIUS toll-free at: 1-888-539-SIRIUS (1-888-539-7474).
6. When you have successfully subscribed to the SIRIUS service, and the Stiletto has been updated with your subscription information, an alert will be displayed. To continue, press the  Select button.

You are now ready to begin enjoying Sirius Satellite Radio's digital entertainment, and can tune to other channels!





**Figure 33**



# Operation

## Presets

Channel presets may be selected using the vehicle dock to tune to a channel by pushing the 0–9 buttons when the vehicle dock is in the preset mode. The Stiletto must be in the Satellite Radio mode to select presets. To select to a preset:

1. Press the  Preset button on the vehicle dock. The preset mode indicator light will indicate that the preset mode is active.
2. Select the desired preset band (A, B, or C) by repeatedly pressing the  Preset button until the desired preset band is displayed. (Figure 34)
3. Press one of the 0–9 buttons to select the desired preset

**OR**

Use the  Media Dial to highlight a preset and press the  Select button. (Figure 35)




**Figure 34**



**Figure 35**

## Direct Channel Tuning

Channels may be tuned directly by entering the channel number using the 0–9 buttons on the vehicle dock when the vehicle dock is in the tune mode. The Stiletto must be in the Satellite Radio mode to select channels. To directly tune a channel:

1. Press the  Tune button on the vehicle dock. (Figure 36) The tune mode indicator light will indicate that the tune mode is active.
2. Enter the channel number of the desired channel. If a 3-digit channel number is entered, the channel will be tuned immediately. If only one or two digits are entered, the channel will be tuned after a slight pause. (Figure 37)



**Figure 36**



**Figure 37**

# Troubleshooting

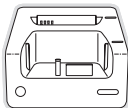
Symptom	Solution
SIRIUS radio does not power on	Blown fuse, or the vehicle dock does not have power or is not properly connected. Check the cigarette lighter adapter connection. Refer to the vehicle's owners manual for the location of the vehicle's fuse panel and check for a blown fuse.
SIRIUS radio displays: <i>Antenna Not Detected</i>	The satellite antenna is not connected to the vehicle dock. Check the satellite antenna connection to the vehicle dock.
SIRIUS radio displays: <i>Acquiring Signal</i>	The Stiletto is searching for a satellite signal. Check for obstacles over or around the satellite antenna. Change the vehicle location to eliminate nearby obstacles (bridges, overpasses, tress, buildings, etc).
Audio static or loss of clarity	The FM channel contains static. Locate a unused FM channel on your vehicle radio and set the FM transmitter frequency of the SIRIUS radio to match. If using a direct connection, check the cable connections. Refer to the section, <b>Maximizing Audio Quality From Your Stiletto Radio.</b>
No sound	The vehicle dock is not connected or is incorrectly connected to the vehicle's sound system. Refer to the section <b>Maximizing Audio Quality From Your Stiletto Radio</b> and follow the instructions carefully.

# Optional Accessories

The following optional accessories are available for purchase from your SIRIUS retailer to maximize your SIRIUS Stiletto experience:

## Home Kit (Model SLH1C)

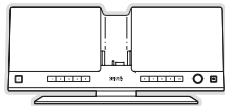
The Stiletto Home Kit is a compact home dock that provides everything you need to use the Stiletto in your home or office. The sleek home dock provides a convenient way to charge your Stiletto's battery along with an extra slot for charging a spare battery. The included indoor/outdoor antenna provides improved reception, while audio cables enable you to connect the Stiletto to amplified speakers or a home entertainment system.



The kit includes a compact tabletop/desktop home dock with FM output for wireless connectivity, a remote control, audio cables, an adjustable indoor/outdoor windowsill antenna with 20' of cable, and an AC Adapter. Detailed installation instructions are included with the kit.

## Executive Sound System (Model SLEX1C)

The Stiletto Executive Sound System is a portable docking station and audio system for use with the Stiletto radio. With the built-in amplifier and speakers, the system delivers rich, powerful sound indoors or outdoors, and features an auxiliary input for other audio devices. Included with the system is an adjustable indoor/outdoor windowsill antenna with 20' of cable and an AC adapter.



## FM Direct Adapter (Product No. 14100)

The FM Direct Adapter directly connects the FM signal from your SIRIUS radio to your vehicle's AM/FM radio, reducing any interference which might be present from FM radio station broadcasts. When the SIRIUS radio is turned off, the vehicle's FM antenna is automatically connected back to the vehicle's AM/FM radio. The adapter connects directly in-line with the vehicle's existing AM/FM antenna input. SIRIUS recommends professional installation of this product.

# Warranty

## 12 Month Limited Warranty

SIRIUS Canada Inc. (the "Company") warrants to the original retail purchaser of this product that should this product or any part thereof, under normal use and conditions, be proven defective in material or workmanship within 12 months from the date of original purchase, such defect(s) will be replaced with new or reconditioned product (at the Company's option) without charge for parts and labor. To obtain replacement within the terms of this Warranty, the product is to be delivered with proof of warranty coverage (e.g. dated bill of sale), specification of defect(s), transportation prepaid, to the location shown below under WARRANTY RETURN.

This Warranty does not extend to the elimination of externally generated static or noise, to correction of antenna problems, to costs incurred for installation, removal or reinstallation of the product, or to damage to tapes, compact discs, speakers, accessories, or vehicle electrical systems.

This Warranty does not apply to any product or part thereof which, in the opinion of the Company, has suffered or been damaged through alteration, improper installation, mishandling, misuse, neglect, accident, or by removal or defacement of the factory serial number/bar code label(s). THE EXTENT OF THE COMPANY'S LIABILITY UNDER THIS WARRANTY IS LIMITED TO THE REPAIR OR REPLACEMENT PROVIDED ABOVE AND, IN NO EVENT, SHALL THE COMPANY'S LIABILITY EXCEED THE PURCHASE PRICE PAID BY PURCHASER FOR THE PRODUCT.

This Warranty is in lieu of all other express warranties or liabilities. ANY IMPLIED WARRANTIES, INCLUDING ANY IMPLIED WARRANTY OF MERCHANTABILITY, SHALL BE LIMITED TO THE DURATION OF THIS WRITTEN WARRANTY. ANY ACTION FOR BREACH OF ANY WARRANTY HEREUNDER INCLUDING ANY IMPLIED WARRANTY OF MERCHANTABILITY MUST BE BROUGHT WITHIN A PERIOD OF 48 MONTHS FROM DATE OF ORIGINAL PURCHASE. IN NO CASE SHALL THE COMPANY BE LIABLE FOR ANY CONSEQUENTIAL OR INCIDENTAL DAMAGES FOR BREACH OF THIS OR ANY OTHER WARRANTY, EXPRESS OR IMPLIED, WHATSOEVER. No person or representative is authorized to assume for the Company any liability other than expressed herein in connection with the sale of this product. Some states do not allow limitations on how long an implied warranty lasts or the exclusion or limitation of incidental or consequential damage so the above limitations or exclusions may not apply to you. This Warranty gives you specific legal rights and you may also have other rights which vary from state to state.

**WARRANTY RETURN:** To obtain a replacement within the terms of this Warranty, please return product to an authorized Sirius Canada retailer or call Erikson Consumer Customer Service at (800) 567-3275 for an authorized Sirius retailer near you; proof of purchase and description of defect are required. Products to be returned to an approved warranty station must be shipped freight prepaid.



# Specifications

Cigarette Lighter Adapter Fuse Requirement	2A Slow Blow
Cigarette Lighter Adapter Cable Length	1.8m (6ft.)
Cigarette Lighter Adapter Operating Temperature	-20° to +85° C (-4° to +185° F)
Vehicle Dock Power Requirements	10-16 Volts, Negative Ground, DC
Antenna Type	Low Profile Magnetic
Antenna Cable Length	21' (single micro-cable)
Connector Type	SMB (right-angle)
Audio Interface	1/8" / 3.5mm Stereo Jack

# Copyrights & Trademarks

© 2006 Sirius Satellite Radio Inc. All Rights Reserved.

® "SIRIUS", the SIRIUS dog logo, channel names and logos are trademarks of Sirius Satellite Radio Inc. All Rights Reserved.

™ "Stiletto" is a trademark of Sirius Satellite Radio Inc.

Hardware, subscription, and activation fee required. For full Terms & Conditions, visit <http://siriuscanada.ca>. Prices and programming are subject to change. Not available in HI and AK. Equipment and subscription sold separately. Installation required with some equipment.

# SIRIUS ID

Write down the SIRIUS ID (SID) of your Stiletto in the space provided below.

SID: \_\_\_\_\_





**SIRIUS**   
**SATELLITE RADIO**

RADIO YOUR WAY™

**SIRIUS Customer Service: 1-888-539-7474**  
customer@siriuscanada.ca

**SIRIUS Canada Inc.**  
135 Liberty Street, 4th Floor  
Toronto, Ontario M6K 1A7  
1-888-539-7474  
<http://www.siriuscanada.ca>

**SIRIUS Canada Inc.**  
135 Liberty Street, 4th Floor  
Toronto, Ontario M6K 1A7  
1-888-539-7474  
[www.siriuscanada.ca](http://www.siriuscanada.ca)

