

TravelMate C300 series

User's guide

Copyright © 2003. Acer Incorporated.
All Rights Reserved.

TravelMate C300 series User's guide
Original Issue: October 2003

Changes may be made periodically to the information in this publication without obligation to notify any person of such revision or changes. Such changes will be incorporated in new editions of this manual or supplementary documents and publications. This company makes no representations or warranties, either expressed or implied, with respect to the contents hereof and specifically disclaims the implied warranties of merchantability or fitness for a particular purpose.

Record the model number, serial number, purchase date, and place of purchase information in the space provided below. The serial number and model number are recorded on the label affixed to your computer. All correspondence concerning your unit should include the serial number, model number, and purchase information.

No part of this publication may be reproduced, stored in a retrieval system, or transmitted, in any form or by any means, electronic, mechanical, photocopy, recording, or otherwise, without the prior written permission of Acer Incorporated.

TravelMate C300 series Notebook computer

Model Number : _____

Serial Number: _____

Purchase Date: _____

Place of Purchase: _____

Acer and the Acer logo are registered trademarks of Acer Incorporated. Other company's product names or trademarks are used herein for identification purposes only and belong to their respective companies.

First things first

We would like to thank you for making the TravelMate series of notebook computers your choice for your mobile computing needs. We hope you will be happy with your TravelMate as much as we enjoyed making it for you.

Your guides

To help you use your TravelMate, we have designed a set of guides:



First off, the **Just for Starters...** poster helps you get started with setting up your computer.



This **User's guide** introduces you to the many ways your computer can help you be more productive. This guide provides clear and concise information about the computer, so read it thoroughly.

If you ever need to print out a copy, this User's guide is also available in PDF (Portable Document Format). Follow these steps:

- 1** Click on **Start, All Programs, AcerSystem**.
- 2** Click on **AcerSystem User's guide**.

Note: Viewing the file requires Adobe Acrobat Reader installed. If Adobe Acrobat Reader is not installed on your computer, clicking on TravelMate User's guide will run the Acrobat Reader setup program first. Follow the instructions on the screen to complete the installation. For instructions on how to use Adobe Acrobat Reader, access the **Help** menu.

For more information about our products, services, and support information, please visit our Web site (www.acer.com).

Basic care and tips for using your computer

Turning your computer on and off

To turn on the computer, simply slide and release the power switch on the left side of your TravelMate. See "Left view" on page 4 for the location of the power switch.

To turn the power off, do any of the following:

- Use the Windows shutdown command
Click on **Start, Turn Off Computer**; then click on **Turn Off**.
- Use the power switch



.....
Note: You can also use the power switch to perform power management functions. See "Power management" on page 29..

Taking care of your computer

Your computer will serve you well if you take care of it.

- Do not expose the computer to direct sunlight. Do not place it near sources of heat, such as a radiator.
- Do not expose the computer to temperatures below 0°C (32°F) or above 50°C (122°F).
- Do not subject the computer to magnetic fields.
- Do not expose the computer to rain or moisture.
- Do not spill water or any liquid on the computer.
- Do not subject the computer to heavy shock and vibration.
- Do not expose the computer to dust and dirt.
- Never place objects on top of the computer to avoid damaging the computer.
- Do not slam the computer display when you close it.
- Never place the computer on uneven surfaces.

Taking care of your AC adapter

Here are some ways to take care of your AC adapter:

- Do not connect the adapter to any other device.
- Do not step on the power cord or place heavy objects on top of it. Carefully route the power cord and any cables away from personal traffic.
- When unplugging the power cord, do not pull on the cord itself but pull on the plug.
- The total ampere ratings of the equipment plugged in should not exceed the ampere rating of the cord if you are using an extension cord. Also, the total current rating of all equipment plugged into a single wall outlet should not exceed the fuse rating.

Taking care of your battery pack

Here are some ways to take care of your battery pack:

- Use only batteries of the same kind as replacements. Turn the power off before removing or replacing batteries.
- Do not tamper with batteries. Keep them away from children.
- Dispose of used batteries according to local regulations. Recycle if at all possible.

Cleaning and servicing

When cleaning the computer, follow these steps:

- 1** Power off the computer and remove the battery pack.
- 2** Disconnect the AC adapter.
- 3** Use a soft cloth moistened with water. Do not use liquid or aerosol cleaners.
- 4** If the computer does not operate normally, please refer to "Troubleshooting my computer" on page 51.

Contents

First things first	iii
Your guides	iii
Basic care and tips for using your computer	iv
1 Getting to know your TravelMate	1
A TravelMate tour	3
Front view	3
Left view	4
Right view	5
Rear view	6
Bottom view	8
Using your computer in tablet mode	9
Writing in the tablet mode	9
Features	12
Indicators	14
Understanding the icons	16
Using the keyboard	17
Special keys	17
Touchpad	24
Touchpad basics	24
Storage	26
Hard disk	26
Optical drive	26
Audio	28
Power management	29
Acer light sensor	30
Moving around with your TravelMate	31
Disconnecting from the desktop	31
Moving around	31
Taking the computer home	32
Traveling with the computer	34
Traveling internationally with the computer	35
Securing your computer	36
Using a computer security lock	36
2 Customizing my computer	39
Expanding through options	41
Connectivity options	41
Upgrade options	44
Using system utilities	47
Notebook Manager	47
Launch Manager	48
BIOS Utility	49

3 Troubleshooting my computer	51
Frequently-asked questions	53
Requesting service	57
International Travelers Warranty (ITW)	57
Before you call	57
Appendix A Acer soft button	59
Appendix B Specifications	65
Appendix C Notices	71
Index	81

1 Getting to know your TravelMate

Your TravelMate computer combines high-performance, versatility, power management features and multimedia capabilities with a unique style and ergonomic design. Work with unmatched productivity and reliability with your new power computing partner.

A TravelMate tour

After setting up your computer as illustrated in the **Just for Starters...** poster, let us show you around your new TravelMate computer.

Front view



#	Item	Description
1	EMR stylus	Electromagnetic resonate (EMR) stylus is used to input data in tablet mode. Use only an EMR-compatible stylus to input data on the screen.

#	Item	Description
2	Display screen	Also called LCD (liquid-crystal display), displays computer output.
3	Tablet Keys	Add enhanced functionality when operating in Tablet mode.
4	Launch Keys	Buttons for launching frequently used programs. See "Launch Keys" on page 23 for more details.
5	Palmrest	Comfortable support area for your hands when you use the computer.
6	Click buttons (left, center and right)	The left and right buttons function like the left and right mouse buttons; the center button serves as a 4-way scroll button.
7	Touchpad	Touch-sensitive pointing device which functions like a computer mouse.
8	Keyboard	Inputs data into your computer.
9	Status indicators	LEDs (light-emitting diodes) that turn on and off to show the status of the computer, its functions and components.

Left view





#	Item	Description
1	Security keylock	Connects to a Kensington-compatible computer security lock.

#	Item	Description
2	Power switch	Turns on the computer power.
3	Ventilation slot	Allows air to circulate through the computer chassis.
4	AcerMedia Bay	For hot-swappable modules including DVD-ROM, DVD/CD-RW combo or DVD dual drive.
5	LED indicator	Lights up when the optical drive is active.
6	Eject button	Ejects the optical drive tray from the drive.
7	Emergency eject slot	Ejects the optical drive tray when the computer is turned off. See page 54 for more details.
8	Pen slot	Keeps the stylus handy when not in use.

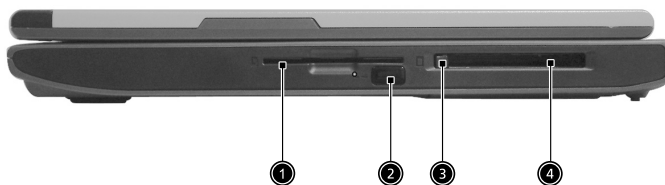
Right view







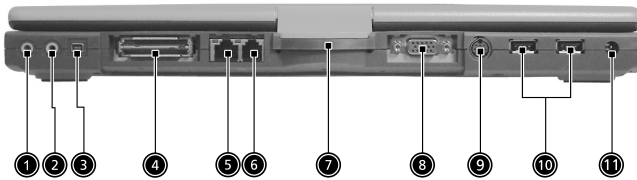

#	Item	Description
1	Smart Card slot	Slot for Smart Card interface with pre-boot authentication system.
2	Infrared port 	Interfaces with infrared devices (e.g., infrared printer, IR-aware computer).

#	Item	Description
3	PC Card eject button	Ejects the PC Card from the slot.
4	PC Card slot 	Accepts one Type II 16-bit PC Card or 32-bit CardBus PC Card.

Rear view



#	Item	Description
1	Line-in/Mic-in jack 	Accepts audio line-in devices (e.g., audio CD player, stereo walkman).
2	Speaker/Line-out Headphone jack 	Connects to audio line-out devices (e.g., speakers, headphones).
3	IEEE 1394 port	Connects to IEEE 1394 devices.
4	Expansion port	Connects to an I/O port replicator or Acer EasyPort port expansion device.
5	Network jack 	Connects to a 10/100/1000 t-based Gigabit Ethernet network.
6	Modem jack 	Connects to a phone line.

#	Item	Description
7	Convertible hinge	Hinges the LCD screen in place when switching from PC mode to tablet mode and vice versa.
8	External display port 	Connects to a display device (e.g., external monitor, LCD projector) .
9	S-video	Connect to a television or display device with S-video input.
10	USB 2.0 ports (2) 	Connect to Universal Serial Bus (USB) 2.0 devices (e.g., USB mouse, USB camera).
11	Power jack 	Connects to an AC adapter.

Bottom view

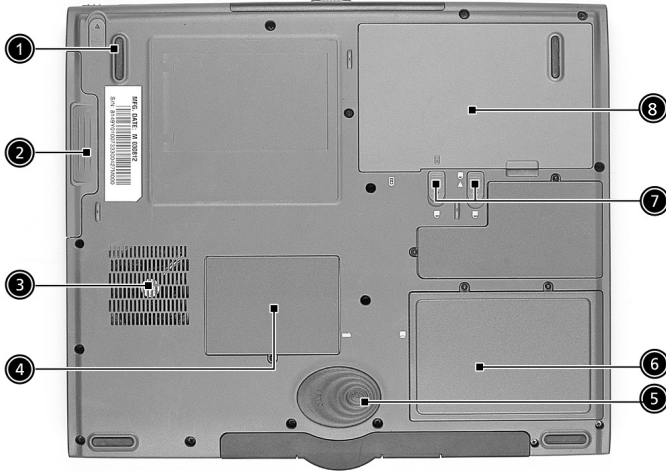

#	Item	Description
1	AcerMedia bay release latch	Unlatches the AcerMedia drive for removal or swapping.
2	AcerMedia bay	Houses an AcerMedia drive module.
3	Cooling fan	Helps keep the computer cool. Note: Don't cover or obstruct the fan opening.
4	Memory compartment	Houses the computer's main memory.
5	Hard disk protector	Protects the hard disk from accidental dumps and vibration.
6	Hard disk bay	Houses the computers Hard disk drive.
7	Battery Lock & release latch	Unlock and unlatches the battery to remove the battery pack.
8	Battery bay	Houses the computer's battery pack.

Using your computer in tablet mode

Your computer is designed for convenience, ergonomic use, and portability. Running the Windows XP Tablet PC edition operating system, your TravelMate utilizes an EMR stylus for pen-based input. Software developed specifically for the computer allows for both handwriting recognition converted to application text, or handwriting captured as rich digital ink for manipulation, editing, and formatting.

Writing in the tablet mode

To write in the tablet mode, follow the steps below:

- 1 Turn the latch to the right (a) and open the display screen in the direction as shown in the illustration below (b).

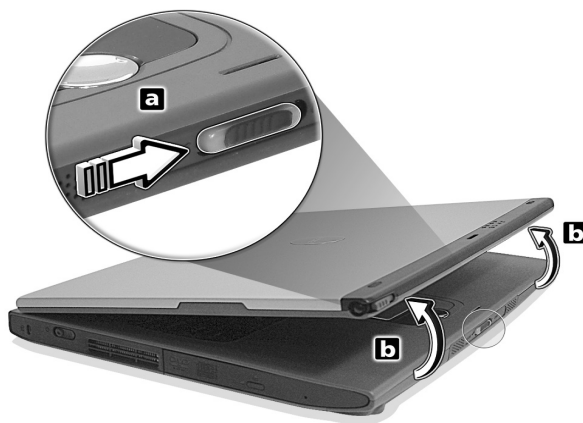

Caution: In the notebook mode, please turn the latch to left to prevent any dangerous action.

- 2 Open the display screen to an angle of about 90 degrees. Rotate the display screen 180 degrees clockwise as shown in the illustration.

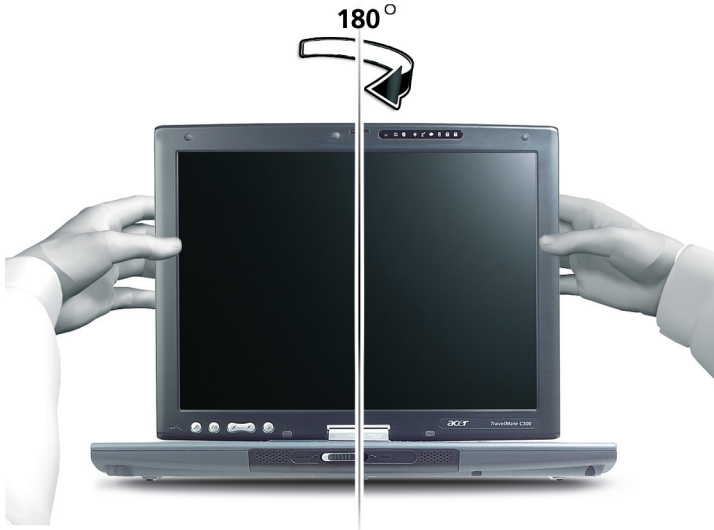

.....
Note: Do not rotate the display screen in any other angle.

- 3 With the screen facing away from the keyboard, close the display cover and slide the lock lever to properly secure the screen.



- 4 Remove the EMR stylus from the pen slot to begin pen-based input.

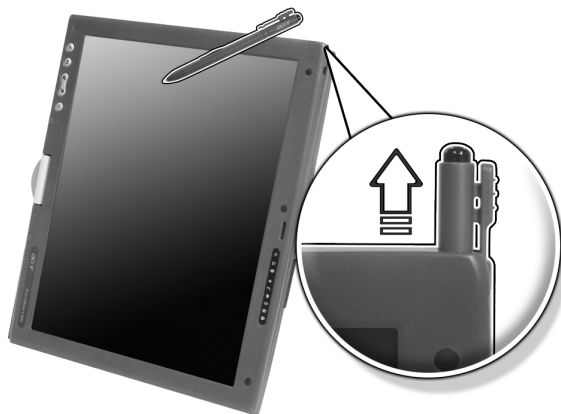

Features

Below is a brief summary of the computer's many features:

Performance

- Intel® Pentium® M processor with 1MB L2 cache
- Intel® 855GM chipset
- CD ROM, DVD, DVD/CD-RW combo, DVD or DVD-dual drive
- High-capacity Enhanced-IDE hard disk
- High-capacity LI-ION battery
- Advanced Configuration Power Interface (ACPI) power management system

Display

- 14.1" Thin-Film Transistor (TFT) liquid crystal display (LCD) supporting pen-based input, with 16M color at 1024x768 XGA (eXtended Graphics Array) resolution
- 3D capabilities
- Simultaneous LCD and CRT display support
- Dual display capability
- Supports other output display devices such as LCD projection panels for large-audience presentations
- Light Sensing background luminance detection - panel automatically adjusts screen brightness
- "Automatic LCD dim" feature that automatically decides the best settings for your display and conserves power

Multimedia

- 16-bit high-fidelity AC'97 stereo audio with 3D sound and wavetable synthesizer
- Built-in stereo speakers
- High-speed CD, DVD, DVD/CD-RW combo or DVD or DVD dual drive

Connectivity

- High-speed fax/data modem port
- 10/100/1000 t-based Gigabit Ethernet port
- USB (Universal Serial Bus) 2.0 ports
- IEEE 1394 port
- 802.11b, 802.11 a+b wireless LAN options
- Bluetooth option

Human-centric design and ergonomics

- Sleek, smooth and stylish design
- Full-sized keyboard
- Ergonomically-centered touchpad pointing device
- Rotating/folding screen for Tablet PC functionality

Expansion





- One Type II CardBus PC Card slot
- Upgradeable memory
- AcerMedia bay
- Acer EasyPort II





Indicators

The computer has eight easy-to-read status icons at the top of the display screen.



The Power and Sleep status icons are visible even when you close the display cover so you can see the status of the computer while the cover is closed.





Icon	Function	Description
	Wireless communication	Lights when the Wireless LAN capabilities are enabled.
	Bluetooth	Lights when Bluetooth is enabled or a Bluetooth enabled device is within range.
	Power	Lights when the computer is on.
	Sleep	Lights when the computer enters Standby mode and blinks when it enters into or resumes from hibernation mode.

Icon	Function	Description
	Media Activity	Lights when the floppy drive, hard disk or optical drive is active.
	Battery Charge	Lights when the battery is being charged.
	Caps Lock	Lights when Caps Lock is activated.
	Num Lock	Lights when Num Lock is activated.

Understanding the icons

When the cover of your computer is closed, four easy-to-read icons are shown, indicating which state or feature is enabled or disabled.



Icon	Description
	Lights when Bluetooth is enabled or a Bluetooth enabled device is within range.
	Lights when the Wireless LAN capabilities are enabled.
	Lights up when the computer is on.
	Lights when the computer enters Standby mode and blinks when it enters into or resumes from hibernation mode.

Using the keyboard

The keyboard has full-sized keys and an embedded keypad, separate cursor keys, two Windows keys and twelve function keys.

Special keys

Lock keys

The keyboard has three lock keys which you can toggle on and off.

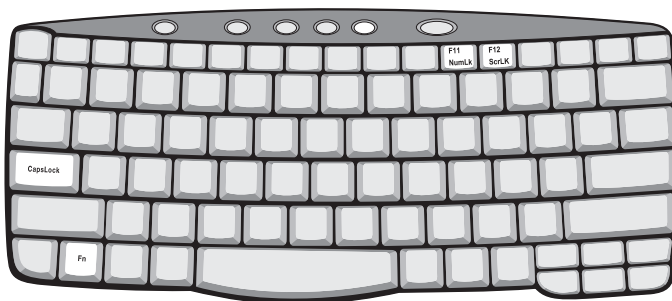

Lock key	Description
Caps Lock	When Caps Lock is on, all alphabetic characters typed are in uppercase.
Num Lock (Fn-F11)	When Num Lock is on, the embedded keypad is in numeric mode. The keys function as a calculator (complete with the arithmetic operators +, -, *, and /). Use this mode when you need to do a lot of numeric data entry. A better solution would be to connect an external keypad.
Scroll Lock (Fn-F12)	When Scroll Lock is on, the screen moves one line up or down when you press the up or down arrow keys respectively. Scroll Lock does not work with some applications.

Embedded numeric keypad

The embedded numeric keypad functions like a desktop numeric keypad. It is indicated by small characters located on the upper right corner of the keycaps. To simplify the keyboard legend, cursor-control key symbols are not printed on the keys.



Desired access	Num lock on	Num lock off
Number keys on embedded keypad	Type numbers in a normal manner.	
Cursor-control keys on embedded keypad	Hold Shift while using cursor-control keys.	Hold Fn while using cursor-control keys.
Main keyboard keys	Hold Fn while typing letters on embedded keypad.	Type the letters in a normal manner.











Note: If an external keyboard or keypad is connected to the computer, the Num Lock feature automatically shifts from the internal keyboard to the external keyboard or keypad.

Windows keys

The keyboard has two keys that perform Windows-specific functions.



Key	Description
Windows logo key 	Start button. Combinations with this key perform shortcut functions. Below are a few examples:  + Tab (Activates next taskbar button)  + E (Explores My Computer)  + F (Finds Document)  + M (Minimizes All) Shift +  + M (Undoes Minimize All)  + R (Displays the Run... dialog box)
Application key 	Opens a context menu (same as a right-click).











Hot keys

The computer employs hot keys or key combinations to access most of the computer's controls like screen brightness, volume output and the BIOS Utility.

To activate hot keys, press and hold the **Fn** key before pressing the other key in the hot key combination.



Hot key	Icon	Function	Description
Fn-F1	?	Hot Key Help	Displays help on hot keys.
Fn-F2		Setup	Accesses the computer's configuration utility.
Fn-F3		Power Management Scheme Toggle	Switches the power management scheme used by the computer (function available if supported by operating system).
Fn-F4	Z ^z	Sleep	Puts the computer in Sleep mode.

Hot key	Icon	Function	Description
Fn-F5		Display Toggle	Switches display output between the display screen, external monitor (if connected) and both the display screen and external monitor.
Fn-F6		Screen Blank	Turns the display screen backlight off to save power. Press any key to return.
Fn-F7		Touchpad Toggle	Turns the internal touchpad on and off.
Fn-F8		Speaker Toggle	Turns the speakers on and off.
Fn-↑		Volume up	Increases the sound volume.
Fn-↓		Volume down	Decreases the sound volume.
Fn-→		Brightness up	Increases the screen brightness.
Fn-←		Brightness down	Decreases the screen brightness.
Fn-PgUp		Home	Functions as the "Home" key.
Fn-PgDn		End	Functions as the "End" key.
Alt Gr-Euro		Euro	Types the Euro symbol.

The Euro symbol

If your keyboard layout is set to United States-International or United Kingdom or if you have a keyboard with a European layout, you can type the Euro symbol on your keyboard.



.....

Note for US keyboard users: The keyboard layout is set when you first set up Windows. For the Euro symbol to work, the keyboard layout has to be set to United States-International.

To verify the keyboard type:

- 1 Click on **Start, Control Panel**.
- 2 Double-click on **Regional and Language Options**.
- 3 Click on the **Language** tab and click on **Details**.
- 4 Verify that the keyboard layout used for "En English (United States)" is set to United States-International.

If not, select and click on **ADD**; then select **United States-International** and click on **OK**.

- 5 Click on **OK**.

To type the Euro symbol:

- 1 Locate the Euro symbol on your keyboard.
- 2 Open a text editor or word processor.
- 3 Hold **Alt Gr** and press the Euro symbol.



.....

Some fonts and software do not support the Euro symbol. Please refer to <http://www.microsoft.com/typography/faq/faq12.htm> for more information.