

# **Notebook Computer**

User's guide

Copyright © 2003  
All Rights Reserved

Notebook Computer User's guide  
Original Issue: August 2003

Changes may be made periodically to the information in this publication without obligation to notify any person of such revision or changes. Such changes will be incorporated in new editions of this manual or supplementary documents and publications. This company makes no representations or warranties, either expressed or implied, with respect to the contents hereof and specifically disclaims the implied warranties of merchantability or fitness for a particular purpose.

Record the model number, serial number, purchase date, and place of purchase information in the space provided below. The serial number and model number are recorded on the label affixed to your computer. All correspondence concerning your unit should include the serial number, model number, and purchase information.

Notebook Computer

Model Number : \_\_\_\_\_

Serial Number: \_\_\_\_\_

Purchase Date: \_\_\_\_\_

Place of Purchase: \_\_\_\_\_

All trademarks and registered trademarks are the properties of their respective companies.

Contents	iii
Preface	vii
Connecting the computer	vii
Care and maintenance	ix
<b>1 Getting familiar with your computer</b>	<b>1</b>
A tour of your computer	3
Top view	3
Front view	5
Left view	6
Right view	7
Rear view	7
Bottom view	9
Features	10
Display	12
Indicators	13
Keyboard	15
Special keys	15
Keyboard ergonomics	20
Touchpad	21
Launch keys	23
Storage	25
Hard disk	25
Optical drive	25
Connectivity options	28
Ethernet and LAN	28
Fax/data modem	28
Optional wireless communication	30
Fast infrared	31
Audio	32
AV control panel	33
Securing your computer	37
Security notch	37
Passwords	37
<b>2 Operating on battery power</b>	<b>39</b>
Battery pack	41
Battery pack characteristics	41
Installing and removing the battery pack	42
Charging the battery	43
Checking the battery level	44
Optimizing battery life	44

# Contents

Battery-low warning	45
Power management	45
Advanced Configuration and Power Interface	46
<b>3 Peripherals and options</b>	<b>47</b>
External monitor	49
Using simultaneous display	49
S-video	50
External keyboard	51
External pointing device	52
Printer	53
Audio devices	54
PC Card	55
PC Card slot	55
USB devices	57
IEEE 1394 devices	58
Miscellaneous options	59
Additional power packs	59
Key component upgrades	60
Memory upgrade	60
Hard disk upgrade	60
<b>4 Moving with your computer</b>	<b>61</b>
Disconnecting from the desktop	63
Moving around	63
Preparing the computer	63
What to bring to short meetings	63
What to bring to long meetings	63
Taking the computer home	63
Preparing the computer	64
What to bring with you	64
Special considerations	64
Setting up a home office	64
Traveling with the computer	65
Preparing the computer	65
What to bring with you	65
Special considerations	65
Traveling internationally with the computer	65
Preparing the computer	65
What to bring with you	66
Special considerations	66

<b>5 Software</b>	<b>67</b>
System software	69
Launch Manager	70
BIOS Utility	71
Security	72
Exit	75
<b>6 Troubleshooting</b>	<b>77</b>
Frequently-asked questions	79
Error messages	82
<b>A Specifications</b>	<b>87</b>
<b>B Notices</b>	<b>93</b>
<b>Index</b>	<b>101</b>



# Preface

This notebook computer incorporates such features as CardBus, internal pointing device, IEEE 1394, and Universal Serial Bus in an portable package.

This manual should answer most of the questions you have about the day-to-day operation of your notebook computer.

You should also take advantage of the online help files that are available with almost all of the programs shipped with your computer.

We hope you enjoy your notebook computer. With proper care, your computer will provide you with years of productive service.

## Connecting the computer

Connecting the computer is as easy as 1-2-3.

1. Insert the battery at an angle (1); press gently on the battery (2) until it click into place. Then slide the lock/unlock latch into the lock position (3).

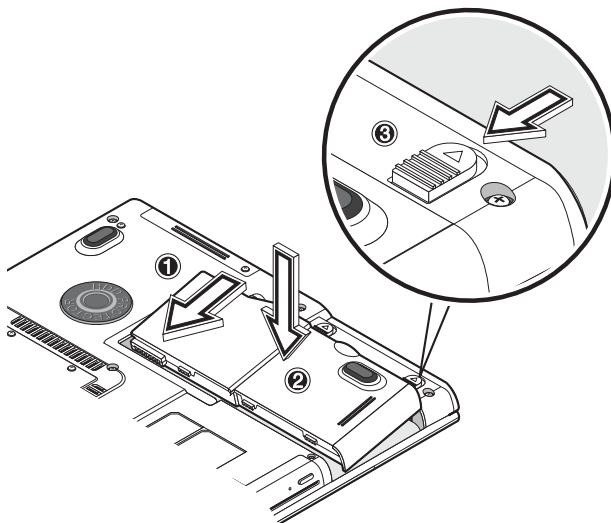

**Note:** When using a battery pack for the first time, fully recharge the battery, then disconnect the adapter to use up the battery before recharging again. Perform this action twice to condition the battery pack.

2. Connect one end of the AC adapter to the DC-in port on the computer's rear panel and the other end to a properly grounded power outlet.

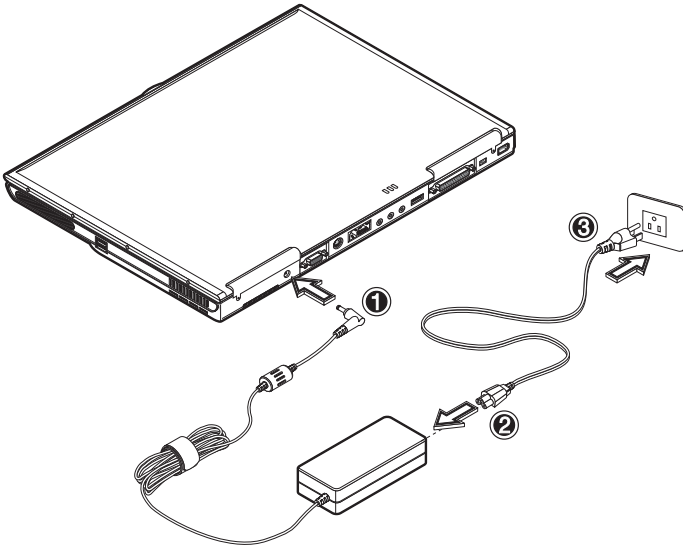

3. Slide the display cover latch to the left (1) to open the display (2). Press the power switch (3) to turn on the power. The POST (power-on self-test) routine executes and Windows begins loading.

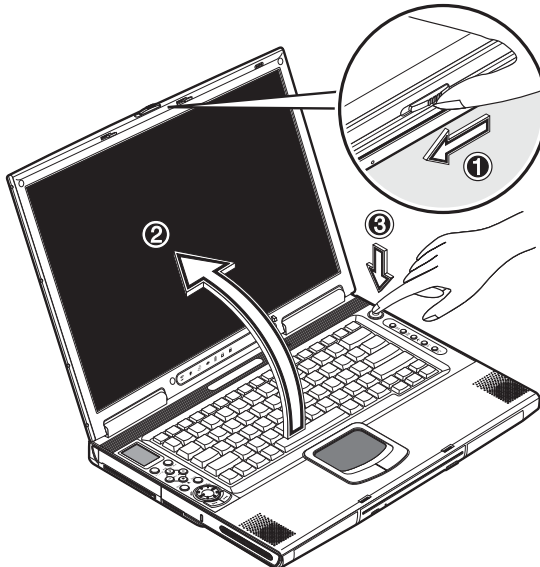





**Note:** To turn off the power, we recommend that you use the Windows Turn Off command to shut down the computer. If you are unable to shut down your computer normally, press and hold the power switch for more than four seconds to turn off the computer. If you turn off the computer and want to turn it on again, wait at least two seconds before powering up.

## Care and maintenance

### Taking care of your computer

Your computer will serve you well if you take care of it.

- Do not expose the computer to direct sunlight. Do not place it near sources of heat, such as a radiator.
- Do not expose the computer to temperatures below 0°C (32°F) or above 50°C (122°F).
- Do not subject the computer to magnetic fields.
- Do not expose the computer to rain or moisture.
- Do not spill water or any liquid on the computer.
- Do not subject the computer to heavy shock and vibration.
- Do not expose the computer to dust and dirt.
- Never place objects on top of the computer to avoid damaging the computer.
- Never place the computer on uneven surfaces.

### Taking care of your AC adapter

Here are some ways to take care of your AC adapter:

- Do not connect the adapter to any other device.
- Do not step on the power cord or place heavy objects on top of it. Carefully route the power cord and any cables away from all potential traffic.
- When unplugging the power cord, do not pull on the cord itself but pull on the plug.
- The total ampere ratings of the equipment plugged in should not exceed the ampere rating of the cord if you are using an extension cord. Also, the total current rating of all equipment plugged into a single wall outlet should not exceed the fuse rating.

## Taking care of your battery pack

Here are some ways to take care of your battery pack:

- Use only batteries of the same kind as replacements. Turn the power off before removing or replacing batteries.
- Do not tamper with batteries. Keep them away from children.
- Dispose of used batteries according to local regulations. Recycle if at all possible.

## Cleaning and servicing

When cleaning the computer, follow these steps:

1. Power off the computer and remove the battery pack.
2. Disconnect the AC adapter.
3. Use a soft cloth moistened with water. Do not use liquid or aerosol cleaners.

Contact your dealer or see your service technician if any of the following occurs:

- The computer has been dropped or the body has been damaged.
- Liquid has been spilled into the product.
- The computer does not operate normally.

# 1 Getting familiar with your computer

This computer combines high-performance, versatility, power management features and multimedia capabilities with a unique style and ergonomic design. Work with unmatched productivity and reliability with your new power computing partner.

This chapter gives an in-depth "tour" of the computer's many features.



# A tour of your computer

Let us show you around your new notebook computer.

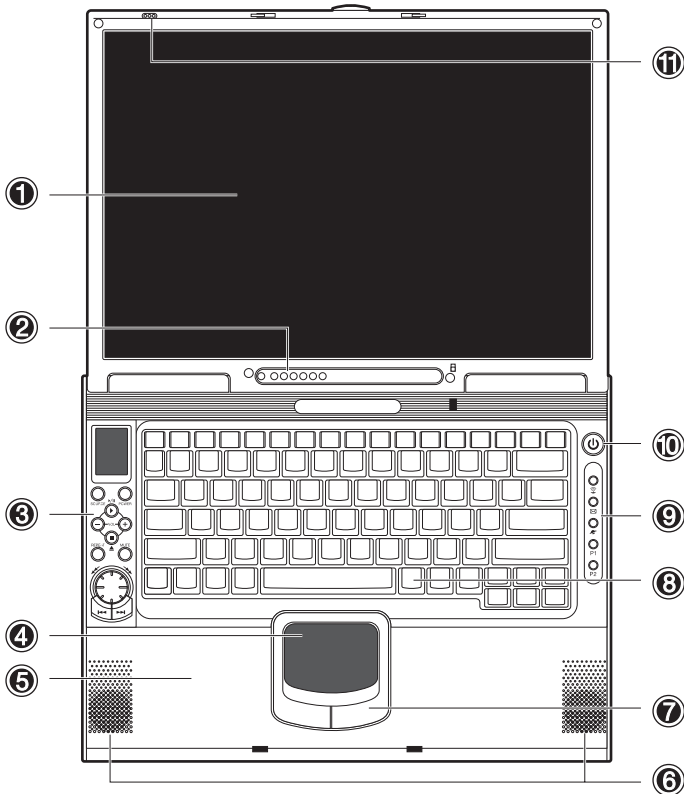
## Top view



#	Item	Description
1	Display screen	Also called LCD (liquid-crystal display), displays computer output.
2	Status indicator	LEDS (light-emitting diodes) that turn on and off to show the status of the computer and its functions and components.

#	Item	Description
3	AV control panel	Control buttons for playing audio/video media.
4	Touchpad	Touch-sensitive pointing device which functions like a computer mouse.
5	Palmrest	Comfortable support area for your hands when you use the computer.
6	Speakers	Outputs sound.
7	Click buttons (left, center and right)	The left and right buttons function like the left and right mouse buttons; the center button serves as a 4-way scroll button.
8	Keyboard	Inputs data into your computer.
9	Launch keys	Buttons for launching frequently used programs. See “Launch keys” on page 23 for more details.
10	Power button 	Turns on the computer power.
11	Microphone 	Inputs sounds and voices into your computer.

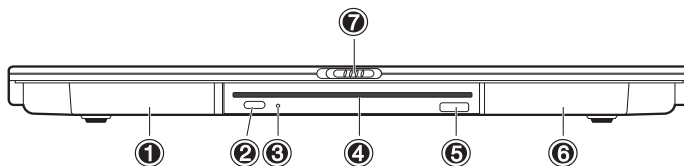

## Front view

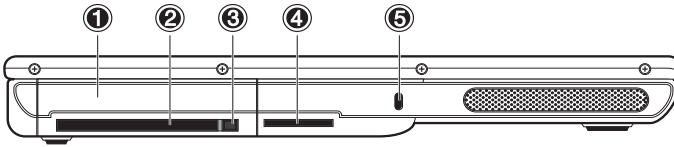

#	Item	Description
1	Battery bay	Houses the computer's battery pack.
2	Eject button	Ejects the CD/DVD disk.
3	LED indicator	Lights up when the DVD/CD-RW combo drive is active.
4	Drive slot	Slot for inserting a CD or DVD.
5	Infrared port	Interfaces with infrared devices (e.g., infrared printer, IR-aware computer).
6	Expansion module	Module for optional second hard disk or optional subwoofer.
7	Display cover latch	Unlatch to open the LCD display.

## Left view



#	Item	Description
1	Hard disk Bay 	Houses the computer's hard disk.
2	PC Card slot 	Accepts one Type II 16-bit PC Card or 32-bit CardBus PC Card with ZV support.
3	PC Card eject button	Ejects the PC Card from its slot.
4	SD slot	Accepts Secured Digital (SD) memory card.
5	Security keylock 	Connects to a Kensington-compatible computer security lock.





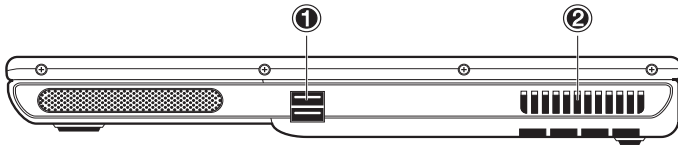

## Right view



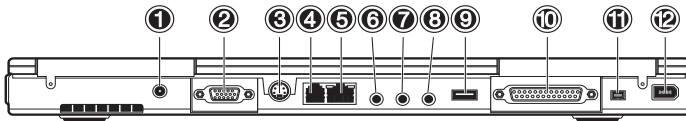







#	Item	Description
1	USB ports 	Connect to a USB devices (e.g., USB mouse).
2	Fan slots	Keep the computer cool. Do not cover these slots to prevent the computer from overheating.

## Rear view



#	Item	Description
1	DC-in jack 	Connects to an AC adapter.
2	External monitor port 	Connects to a display monitor (up to 2048x1536 resolution).
3	S-video port 	Connects to a television or display device with S-video input.

#	Item	Description
4	Modem jack 	Connects a phone line (only for models with an internal fax/data modem).
5	Network jack 	Connects to an Ethernet 10/100-based network.
6	Microphone-in jack 	Connects to a microphone; supports S/PDIF (Sony/Philips Digital Interface) digital input
7	Line-in jack 	Accepts audio line-in devices (e.g., audio CD player, stereo walkman).
8	S/PDIF line-out jack 	Connects to S/PDIF audio line-out devices (e.g., speakers, headphones).
9	USB port 	Connect to a USB devices (e.g., USB digital camera).
10	Parallel port 	Connects to a parallel device (e.g., parallel printer).
11	IEEE 1394 port (4-pin) 	Connects to a IEEE 1394-compatible (4-pin) device (e.g., digital video camera).
12	IEEE 1394 port (6-pin) 	Connects to a IEEE 1394-compatible (6-pin) device (e.g., digital video camera).

## Bottom view

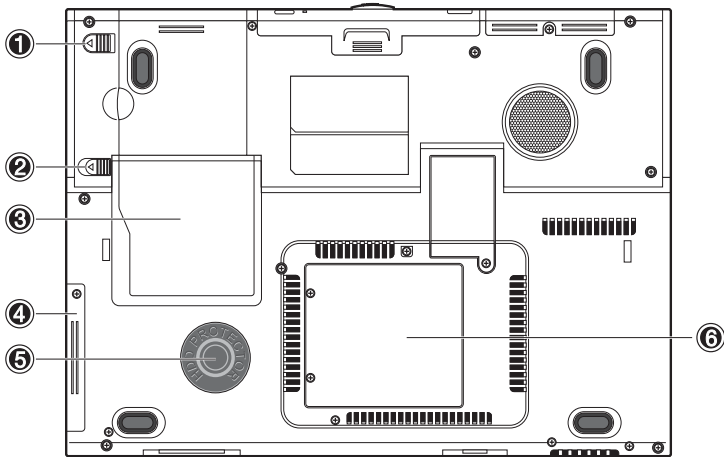

#	Item	Description
1	Battery lock/unlock latch	Locks/unlocks the battery pack.
2	Battery release latch	Unlatches the battery to remove the battery pack.
3	Battery bay	Houses the computer's battery pack.
4	Hard disk bay	Houses the computer's hard disk.
5	Hard disk protector	Protects the hard disk from accidental bumps and vibrations.
6	Memory compartment	Houses the computer's main memory.

# Features

This computer was designed with the user in mind. Here are just a few of its many features:

## Performance

- Mobile Intel® Pentium® 4 Processor - M with Enhanced Intel® SpeedStep™ technology
- 1 MB (1024K) on-die L2 cache
- 15.4" 16:10 SXGA (1280x800) widescreen TFT LCD panel
- ATI® Mobility™ Radeon™ 9600 high-performance graphics chipset with 64MB frame buffer
- Onboard memory upgradable to 2048 MB with 2 DDR-266/333 SoDIMM
- High-capacity, Enhanced-IDE hard disk
- Lithium Ion battery pack
- Power management system
- Dual display capability
- Simultaneous LCD and CRT display
- LCD panel supports resolution up to 2048x1536
- VGA monitor supports resolution up to 2048x1536
- Embedded TV encoder supports resolution up to 1024x768

## Multimedia

- AV control panel
- Playback MP3 through SD, HDD or Audio CD with system off
- AC'97 2.2 compliant stereo audio
- S/PDIF line-out jack
- Enhanced audio system with 2 speakers and an optional subwoofer
- Built-in microphone
- Slot-loading DVD/CD-RW combo drive
- S-video output port

## Connectivity

- High-speed fax/data software modem

- Onboard PCI 10/100 Mbps LAN support
- Fast infrared wireless communication
- USB (Universal Serial Bus) ports (2.0)
- 2 IEEE 1394 ports (one mini port and one regular port)
- Optional 802.11b/g wireless LAN

### Human-centric design and ergonomics

- Sleek, smooth and stylish design
- Full-sized keyboard
- Ergonomically-centered touchpad pointing device
- Launch keys

### Expansion

- Upgradeable memory and hard disk
- Second hard disk module
- Secure Digital (SD) slot

# Display

The graphics display offers excellent viewing, display quality and desktop-performance graphics. The computer supports a widescreen Thin-Film Transistor (TFT) liquid crystal display (LCD) displaying up to 16.7 million colors at 1280x800 Super eXtended Graphics Array (SXGA) resolution.

## Simultaneous display

The computer's crisp display and multimedia capabilities are great for giving presentations. If you prefer, you can also connect an external monitor when giving presentations. This computer supports simultaneous LCD and CRT display. Simultaneous display allows you to control the presentation from your computer and at the same time face your audience. You can also connect other output display devices such as LCD projection panels for large-audience presentations.

## Power management

The power management system incorporates an "automatic LCD dim" feature that automatically dims the LCD when the computer is powered by a battery pack to conserve battery power. See "Power management" on page 45 for more information on power management features.

## Opening and closing the display

To open the display, slide the display cover latch to the left and lift up the cover, then tilt it to a comfortable viewing position. See "Connecting the computer" on page vii. The computer employs a microswitch that turns off the display (e.g., enters standby mode) to conserve power when you close the display cover, and turns it back on when you open the display cover.



.....  
**Note:** If an external monitor is connected, the computer turns off the display (but does not enter standby mode) when you close the display cover.

To close the display cover, fold it down gently until the display cover latch clicks into place.





.....  
**Caution:** To avoid damaging the display, do not slam it when you close it. Also, do not place any object on top of the computer when the display is closed.



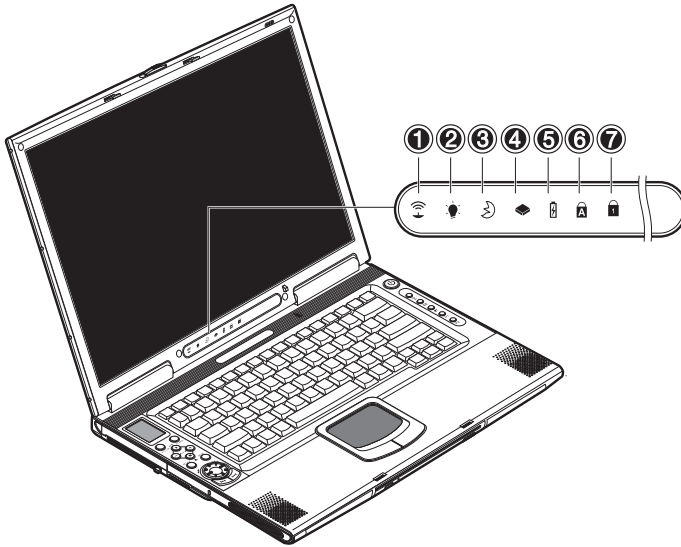

# Indicators

The computer has seven easy-to-read status indicators (LEDs) under the display screen.



The Power and Standby indicators are visible even when you close the display cover so you can see the status of the computer while the cover is closed.

#	Function	Description
1	Wireless communication 	Lights when the Bluetooth/Wireless LAN (optional) capabilities are enabled.
2	Power 	Lights when the computer is on. Blinks when a battery-low condition occurs.
3	Standby 	Blinks when computer enters Hibernation mode.

#	Function	Description
4	Media activity 	Lights when the hard disk, or CD or DVD drive is active.
5	Battery charge 	Lights when the battery is being charged.
6	Caps lock 	Lights when Caps Lock is activated.
7	Num lock (Fn-F11) 	Lights when Numeric Lock is activated.



# Keyboard

The keyboard has full-sized keys with an embedded keypad, separate cursor keys, two Windows keys and twelve function keys.

## Special keys

### Lock keys

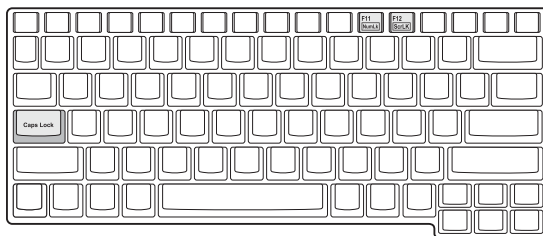

The keyboard has three lock keys which you can toggle on and off.

Lock Key	Description
Caps Lock	When Caps Lock is on, all alphabetic characters typed are in uppercase.
Num Lock (Fn-F11)	When Num Lock is on, the embedded keypad is in numeric mode. The keys function as a calculator (complete with the arithmetic operators +, -, *, and /). Use this mode when you need to do a lot of numeric data entry. A better solution would be to connect an external keypad. See “External keyboard” on page 51.
Scroll Lock (Fn-F12)	When Scroll Lock is on, the screen moves one line up or down when you press ↑ or ↓ respectively. Scroll Lock does not work with some applications.

## Embedded numeric keypad

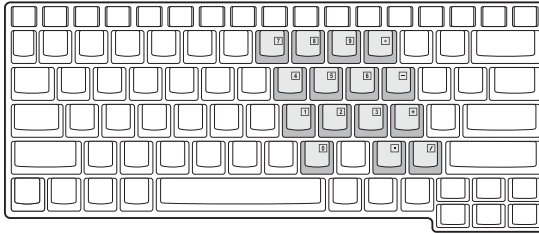

The embedded numeric keypad functions like a desktop numeric keypad. It is indicated by small characters located on the upper right corner of the keycaps. To simplify the keyboard legend, cursor-control key symbols are not printed on the keys.

Desired Access	Num Lock On	Num Lock Off
Number keys on embedded keypad	Type numbers in a normal manner.	
Cursor-control keys on embedded keypad	Hold Shift while using cursor-control keys.	Hold Fn while using cursor-control keys.
Main keyboard keys	Hold Fn while typing letters on embedded keypad.	Type the letters in a normal manner.







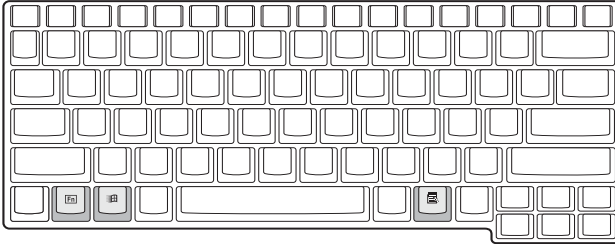

**Note:** If an external keyboard or keypad is connected to the computer, the numlock feature automatically shifts from the internal keyboard to the external keyboard or keypad.

## Windows keys







The keyboard has two keys that perform Windows-specific functions.

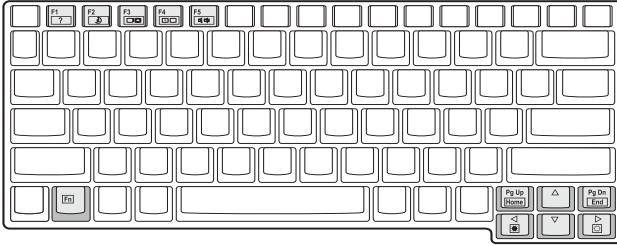

Key	Description
Windows logo key 	Start button. Combinations with this key perform special functions. Below are a few examples:   + Tab (Activates next Taskbar button)   + E (Explores My Computer)   + F (Finds Document)   + M (Minimizes All)  Shift +  + M (Undoes Minimize All)   + R (Displays Run dialog box)
Application key	Opens the application's context menu (same as right-click).

## Hotkeys



The computer employs hotkeys or key combinations to access most of the computer's controls like screen contrast and brightness, volume output and the BIOS setup utility.

HotKey	Function	Description
Fn-F1	Hotkey help ?	Displays a list of the hotkeys and their functions.
Fn-F2	Sleep 	Puts the computer in Sleep mode, which can be defined via the advanced section of the Power Management Properties in the Windows Control Panel.
Fn-F3	Display toggle 	Switches display output between the display screen, external monitor (if connected) and both the display screen and external monitor.
Fn-F4	Screen blank 	Turns the display screen backlight off to save power. Press any key to return.
Fn-F5	Speaker on/off 	Turns the speakers on and off; mutes the sound.
Fn-PgUp	Home	Functions as the "Home" key.
Fn-PgDn	End	Functions as the "End" key.

HotKey	Function	Description
Fn→	Brightness up 	Increases the screen brightness.
Fn←	Brightness down 	Decreases the screen brightness.

### Activating hotkeys

When activating hotkeys, press and hold the **Fn** key before pressing the other key in the hotkey combination.

## Keyboard ergonomics

Located below the keyboard, the wide and curved palm rest is ergonomically designed to provide you with a very comfortable place to rest your hands while you type.



# Touchpad

The built-in touchpad is a pointing device that senses movement on its surface. This means the cursor responds as you move your finger on the surface of the touchpad. The central location on the palm rest provides optimum comfort and support.



## Touchpad basics

The following teaches you how to use the touchpad:

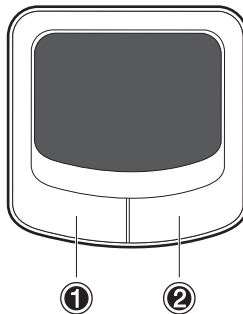

- Move your finger across the touchpad to move the cursor.
- Press the left (1) and right (2) buttons located on the edge of the touchpad to do selection and execution functions. These two buttons are similar to the left and right buttons on a mouse. Tapping on the touchpad produces similar results.

Function	Left Button	Right Button	Tap
Execute	Click twice quickly.		Tap twice (at the same speed as double-clicking the mouse button).
Select	Click once.		Tap once.
Drag	Click and hold, then use finger to drag the cursor on the touchpad.		Tap twice (at the same speed as double-clicking the mouse button) and hold finger to the touchpad on the second tap to drag the cursor.
Access context menu		Click once.	





**Note:** Keep your fingers dry and clean when using the touchpad. Also keep the touchpad dry and clean. The touchpad is sensitive to finger movements. Hence, the lighter the touch, the better the response. Tapping too hard will not increase the touchpad's responsiveness.

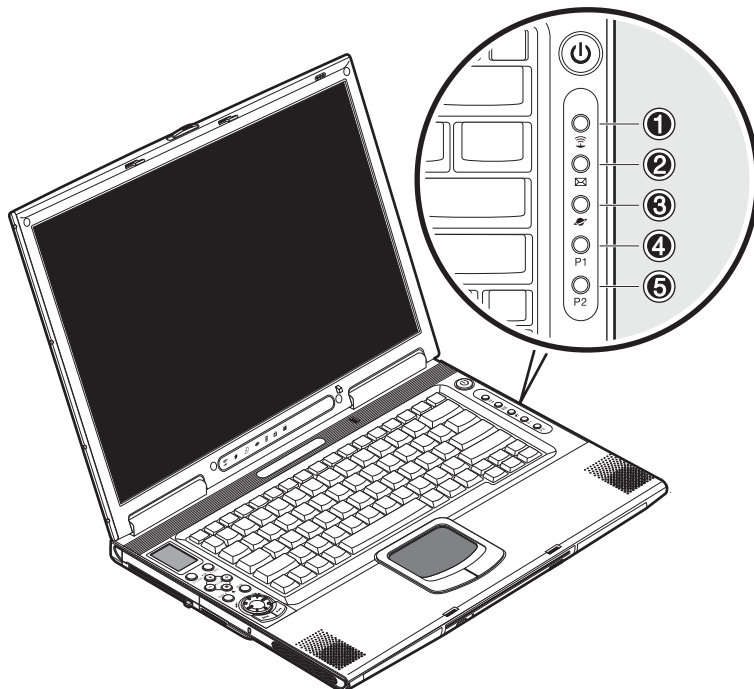

## Launch keys

Located at the top of the keyboard are five launch keys used to launch frequently used applications.



#	Item	Description
1	Wireless communication 	This button is used to enable or disable the Bluetooth/Wireless LAN (optional) function.
2	Email 	The mail button is used to launch the email application.

#	Item	Description
3	Internet browser 	By default, is used to launch your internet browser.
4	P1 P1	This button is user-programmable.
5	P2 P2	This button is user-programmable.

# Storage

This computer supplies you with the following media storage:

- High-capacity Enhanced-IDE hard disk
- Slot-loading DVD/CD-RW combo drive
- Secure Digital (SD) slot
- Optional external USB 3.5-inch floppy drive
- Optional second hard disk module

## Hard disk

The high-capacity hard disk is the answer to your storage needs. This is where your programs and data are stored.

## Optical drive

A high-speed optical drive (DVD/CD-RW combo drive) gives you portable multimedia access and at the same time lets you burn your data onto a CD recordable disc.

## Inserting the disc

This computer features a slot-loading optical drive. To insert a disc into the optical drive, gently push the disc into the slot and the drive will lock the disc in place and pull it inside.



## Ejecting the disc

To eject the disc from the slot, press the eject button and wait for the drive to eject the disc.

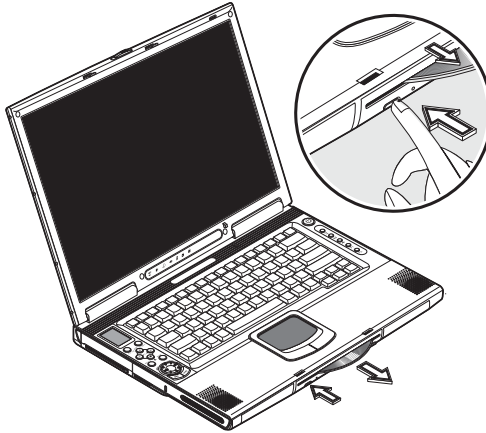

## Playing DVD movies

To play DVD movies in your computer, just insert the DVD disc into the drive and the DVD movie will automatically play after a few seconds.



**Important!** When you launch the DVD player for the first time, the program asks you to input the region code. DVD discs are divided into 6 regions. Once your DVD drive is set to a region code, it will play DVD discs of that region only. You can set the region code a maximum of five times (including the first time), after which the last region code set will remain permanent. Recovering your hard disk does not reset the number of times the region code has been set. Refer to the table below for DVD movie region code information.

Region code	Country or region
1	U.S.A., Canada
2	Europe, Middle East, South Africa, Japan
3	Southeast Asia, Taiwan, Korea (South)
4	Latin America, Australia, New Zealand

Region code	Country or region
5	Former U.S.S.R., parts of Africa, India
6	People's Republic of China



.....

**Note:** To change the region code, insert a DVD movie of a different region into the DVD-ROM drive. Please refer to the online help for more information.

# Connectivity options

The computer has built-in features for connecting to a network and communicating with other computers.

## Ethernet and LAN

The built-in network feature allows you to connect your computer to an Ethernet-based (10/100 Mbps) network.

To use the network feature, connect an Ethernet cable from the network jack on the rear of the computer to a network jack or hub on your network.

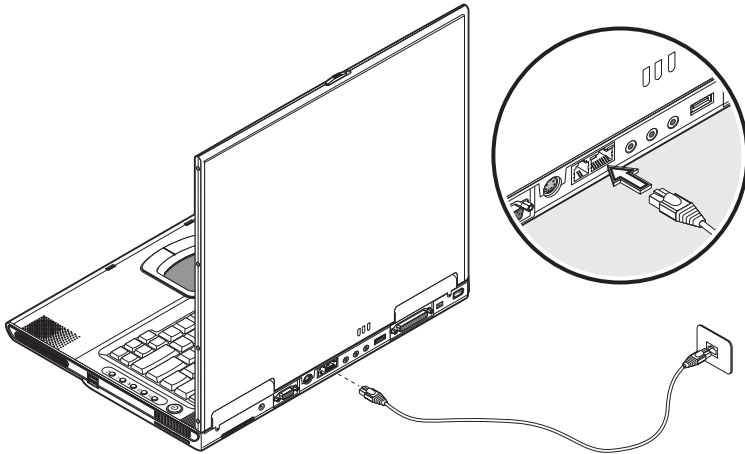

## Fax/data modem

The computer has a built-in fax/data modem (available in select countries).



.....  
**Warning: This modem port is not compatible with digital phone lines.  
Plugging this modem into a digital phone line will damage the modem.**

To use the fax/data modem port, connect a phone cable from the modem port to a telephone jack.

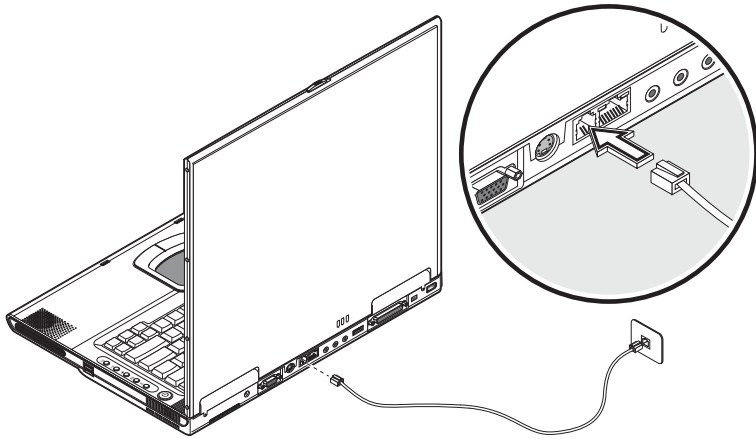

## Optional wireless communication

This computer has optional wireless communication feature built-in. This feature allows you to communicate with other wireless communication devices.

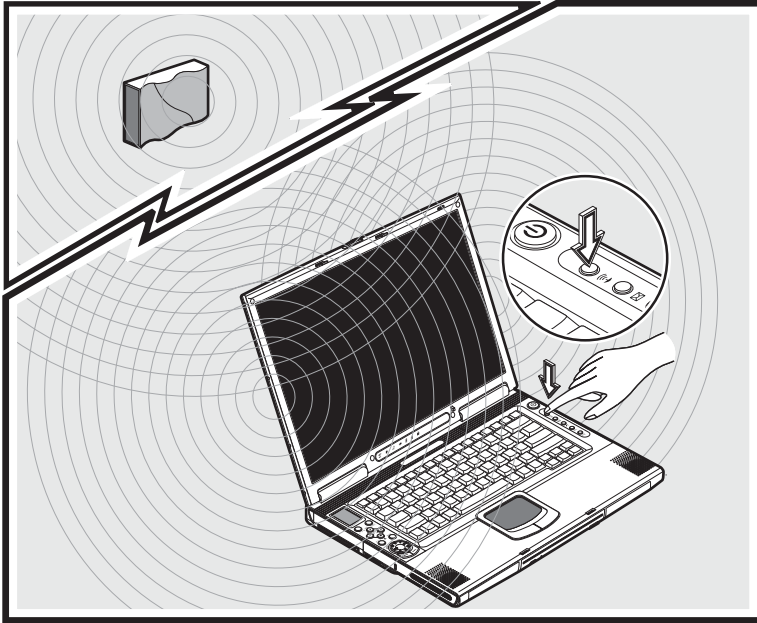

You can manually turn off your wireless communication feature.