

**ThinkPad**

# ThinkPad Helix User Guide

20CG and 20CH

**Note:** Before using this information and the product it supports, be sure to read and understand the following:

- *Safety, Warranty, and Setup Guide*
- *Regulatory Notice*
- “Important safety and handling information” on page iii
- Appendix D “Notices” on page 109

The latest *Safety, Warranty, and Setup Guide* and the *Regulatory Notice* are available on the Lenovo Support Web site at <http://www.lenovo.com/UserManuals>.

**First Edition (November 2014)**

© Copyright Lenovo 2014.

LIMITED AND RESTRICTED RIGHTS NOTICE: If data or software is delivered pursuant a General Services Administration “GSA” contract, use, reproduction, or disclosure is subject to restrictions set forth in Contract No. GS-35F-05925.

---

# Contents

<b>Read this first</b> . . . . .	<b>iii</b>	Comfort and accessibility . . . . .	37
Important safety and handling information . . . . .	iii	Using your tablet more comfortably . . . . .	37
<b>Chapter 1. Product overview</b> . . . . .	<b>1</b>	Accessibility information . . . . .	37
Tablet layout . . . . .	1	Getting updates . . . . .	40
Front view and side view . . . . .	1	Traveling with your tablet. . . . .	40
Rear view . . . . .	3	Travel tips . . . . .	40
Accessories . . . . .	4	Travel accessories . . . . .	40
Features . . . . .	5	Care and maintenance . . . . .	41
Specifications . . . . .	6	<b>Chapter 5. ThinkPad Helix options</b> . . . . .	<b>43</b>
Operating environment . . . . .	7	ThinkPad Helix Ultrabook Keyboard . . . . .	43
Lenovo programs . . . . .	7	Overview of ThinkPad Helix Ultrabook Keyboard . . . . .	43
<b>Chapter 2. Using your tablet</b> . . . . .	<b>9</b>	Using the ThinkPad Helix Ultrabook Keyboard . . . . .	44
Initial setup instructions . . . . .	9	ThinkPad Helix Ultrabook Pro Keyboard. . . . .	48
Using the multi-touch screen . . . . .	10	Overview of ThinkPad Helix Ultrabook Pro Keyboard . . . . .	48
Power management . . . . .	11	Using the ThinkPad Helix Ultrabook Pro Keyboard . . . . .	50
Charging the battery . . . . .	12	ThinkPad Tablet Dock . . . . .	59
Extending the battery life between charges. . . . .	13	Overview of ThinkPad Tablet Dock . . . . .	59
Checking the battery status. . . . .	13	Using the ThinkPad Tablet Dock . . . . .	61
Using the Tablet Digitizer Pen . . . . .	14	<b>Chapter 6. Security</b> . . . . .	<b>63</b>
Using the On-Screen Keyboard or the touch keyboard and handwriting panel. . . . .	14	Using passwords. . . . .	63
Changing the startup behavior to open either the desktop or the Start screen. . . . .	15	Typing passwords . . . . .	63
Downloading games and applications . . . . .	15	Passwords and sleep mode. . . . .	63
Using the fingerprint reader. . . . .	15	Power-on password . . . . .	63
Using the ThinkPad Helix Quickshot Cover . . . . .	18	Supervisor password . . . . .	64
Using the cameras . . . . .	20	Hard disk passwords . . . . .	65
Using the micro-SD-card reader. . . . .	20	Hard disk security . . . . .	67
Using a smart card . . . . .	22	Using the security chip . . . . .	68
Using HDMI devices . . . . .	24	Using firewalls . . . . .	68
Using synchronization solutions . . . . .	25	Protecting data against viruses . . . . .	69
Using the GPS satellite receiver . . . . .	25	<b>Chapter 7. Advanced configuration.</b> . . . . .	<b>71</b>
Turning off the tablet . . . . .	25	Installing device drivers . . . . .	71
<b>Chapter 3. Wireless networks and devices</b> . . . . .	<b>27</b>	ThinkPad Tablet Setup . . . . .	71
Installing and removing the micro SIM card . . . . .	27	Main menu . . . . .	72
Determining which mobile network you are using . . . . .	29	Config menu. . . . .	73
Connecting to a Wi-Fi network . . . . .	29	Security menu . . . . .	77
Connecting to a mobile network. . . . .	30	Startup menu . . . . .	82
Sharing your Internet connection . . . . .	31	Restart menu . . . . .	83
Using Bluetooth devices . . . . .	31	Updating your system UEFI BIOS . . . . .	84
Using the NFC connection . . . . .	32	Using system management. . . . .	84
<b>Chapter 4. You and your tablet</b> . . . . .	<b>37</b>	System management . . . . .	84

<b>Chapter 8. Troubleshooting problems</b> . . . . .	<b>85</b>	German Class B compliance statement . . . . .	100
Diagnosing problems . . . . .	85	Korea Class B compliance statement . . . . .	101
Troubleshooting . . . . .	85	Japanese VCCI Class B statement . . . . .	101
Recovering from a severe software problem . . . . .	87	Japan compliance statement for products which connect to the power mains with rated current less than or equal to 20 A per phase . . . . .	101
Error messages . . . . .	87	Lenovo product service information for Taiwan . . . . .	101
<b>Chapter 9. Recovery information</b> . . . . .	<b>89</b>	Eurasian compliance mark . . . . .	101
Refreshing your tablet . . . . .	89	Brazil regulatory notice . . . . .	101
Resetting your tablet to the factory default settings . . . . .	89	Mexico regulatory notice. . . . .	101
Using the advanced startup options . . . . .	90	<b>Appendix B. WEEE and recycling information</b> . . . . .	<b>103</b>
Recovering your operating system if Windows 8.1 fails to start . . . . .	90	Important WEEE information . . . . .	103
Creating and using recovery media . . . . .	90	Recycling information for China . . . . .	103
<b>Chapter 10. Getting support</b> . . . . .	<b>93</b>	Recycling information for Japan . . . . .	103
Locating important product information . . . . .	93	Recycling information for Brazil . . . . .	104
Lenovo technical support . . . . .	94	Battery recycling information for Taiwan. . . . .	105
Lenovo user forums. . . . .	95	Battery recycling information for the United States and Canada. . . . .	105
Finding ThinkPad options . . . . .	95	Battery recycling information for the European Union . . . . .	105
Purchasing additional services . . . . .	95	China recycling information for Waste Electrical and Electronic Equipment (WEEE) . . . . .	106
<b>Appendix A. Regulatory information</b> . . . . .	<b>97</b>	<b>Appendix C. Restriction of Hazardous Substances Directive (RoHS)</b> . . . . .	<b>107</b>
Wireless related information . . . . .	97	European Union RoHS . . . . .	107
Locating the UltraConnect™ wireless antennas . . . . .	98	China RoHS. . . . .	107
Locating wireless regulatory notices . . . . .	99	Turkish RoHS . . . . .	107
Export classification notice. . . . .	99	Ukraine RoHS . . . . .	108
Electronic emission notices. . . . .	99	India RoHS . . . . .	108
Federal Communications Commission Declaration of Conformity . . . . .	99	<b>Appendix D. Notices</b> . . . . .	<b>109</b>
Industry Canada Class B emission compliance statement . . . . .	99	Trademarks . . . . .	110
European Union - Compliance to the Electromagnetic Compatibility Directive . . . . .	100		

---

## Read this first

Be sure to follow the important tips given here to get the most use and enjoyment out of the tablet. Failure to do so might lead to discomfort or injury, or cause the tablet to fail.

---

### Important safety and handling information

	<p>To avoid personal injury, property damage, or accidental damage to your ThinkPad® Helix (hereafter called the tablet), read all of the information in this section before using it.</p> <p>For detailed operating instructions, refer to the <i>ThinkPad Helix User Guide</i> (this publication). You can access the <i>ThinkPad Helix User Guide</i> by using one of the following methods:</p> <ul style="list-style-type: none"><li>• Go to <a href="http://www.lenovo.com/UserManuals">http://www.lenovo.com/UserManuals</a> and follow the instructions on the screen.</li><li>• Open Windows® Help and Support. Then tap <b>Lenovo User Guide</b>.</li></ul> <p>For additional tips to help you operate the tablet safely, go to: <a href="http://www.lenovo.com/safety">http://www.lenovo.com/safety</a></p>
---	--

#### Handle your tablet with care:

Do not drop, bend, puncture, insert foreign objects, or place heavy objects on your tablet. Sensitive components inside might become damaged.

Your tablet screen is made of glass. The glass might break if the tablet is dropped on a hard surface, is the subject of a high impact, or is crushed by a heavy object. If the glass chips or cracks, do not touch the broken glass or attempt to remove it from the tablet. Stop using the tablet immediately and contact Lenovo® technical support for repair, replacement, or disposal information.

#### Do not disassemble or modify your tablet:

Your tablet is a sealed unit. There are no end-user serviceable parts inside. All internal repairs must be done by a Lenovo-authorized repair facility or a Lenovo-authorized technician. Attempting to open or modify your tablet will void the warranty.

#### General battery notice



**Batteries supplied by Lenovo for use with your product have been tested for compatibility and should only be replaced with approved parts. A battery other than the one specified by Lenovo, or a disassembled or modified battery is not covered by the warranty.**

**Battery abuse or mishandling can cause overheating, liquid leakage, or an explosion. To avoid possible injury, do the following:**

- **Do not open, disassemble, or service any battery.**
- **Do not crush or puncture the battery.**
- **Do not short-circuit the battery, or expose it to water or other liquids.**
- **Keep the battery away from children**
- **Keep the battery away from fire.**

**Stop using the battery if it is damaged, or if you notice any discharge or the buildup of foreign materials on the battery leads.**

**Store the rechargeable batteries or products containing the rechargeable batteries at room temperature, charged to approximately 30 to 50% of capacity. We recommend that the batteries be charged about once per year to prevent overdischarge.**

**Do not put the battery in trash that is disposed of in landfills. When disposing of the battery, comply with local ordinances or regulations.**

#### **Notice for built-in rechargeable battery**



**DANGER**

**Do not attempt to replace the built-in rechargeable battery. Replacement of the battery must be done by a Lenovo-authorized repair facility or technician.**

**Only recharge the battery strictly according to instructions included in the product documentation.**

**The Lenovo-authorized repair facilities or technicians recycle Lenovo batteries according to local laws and regulations.**

#### **Notice for non-rechargeable coin-cell battery**



**DANGER**

**If the coin-cell battery is incorrectly replaced, there is danger of an explosion. The battery contains a small amount of harmful substance.**

**Do not heat to more than 100°C (212°F).**

**The following statement applies to users in the state of California, U.S.A.**

**California Perchlorate Information:**

**Products containing manganese dioxide lithium coin-cell batteries may contain perchlorate.**

**Perchlorate Material - special handling may apply, See [www.dtsc.ca.gov/hazardouswaste/perchlorate](http://www.dtsc.ca.gov/hazardouswaste/perchlorate)**

#### **Prevent your tablet and adapter from getting wet:**

Do not immerse your tablet in water or leave it in a location where it can get saturated with water or other liquids.

#### **Use supported charging methods only:**

You can use any of the following charging methods to recharge the internal battery of your tablet safely:

**Attention:** Use only Lenovo-approved ac power adapters. Unauthorized ac power adapters could severely damage the tablet.

- ac power adapter shipped with your tablet
- ThinkPad Ultrabook Pro Keyboard and the ac power adapter shipped with the keyboard, if available

- ThinkPad Tablet Dock and the ac power adapter shipped with the dock

**Note:** The ThinkPad Tablet Dock is an optional device that Lenovo designed specifically for your tablet. To purchase the option from Lenovo, go to:  
<http://www.lenovo.com/essentials>

Charging devices might become warm during normal use. Ensure that you have adequate ventilation around the charging device. Unplug the charging device if any of the following occurs:

- The charging device has been exposed to rain, liquid, or excessive moisture.
- The charging device shows signs of physical damage.
- You want to clean the charging device.

Lenovo is not responsible for the performance or safety of products not manufactured or approved by Lenovo.

### **Prevent hearing damage:**

Your tablet has a combo audio connector that you can use for headphones (also called a headset) or earphones.



### **CAUTION:**

**Excessive sound pressure from earphones and headphones can cause hearing loss. Adjustment of the equalizer to maximum increases the earphone and headphone output voltage and the sound pressure level. Therefore, to protect your hearing, adjust the equalizer to an appropriate level.**

Excessive use of headphones or earphones for a long period of time at high volume can be dangerous if the output of the headphone or earphone connectors do not comply with specifications of EN 50332-2. The headphone output connector of your tablet complies with EN 50332-2 Sub clause 7. This specification limits the tablet's maximum wide band true RMS output voltage to 150 mV. To help protect against hearing loss, ensure that the headphones or earphones you use also comply with EN 50332-2 (Clause 7 limits) for a wide band characteristic voltage of 75 mV. Using headphones that do not comply with EN 50332-2 can be dangerous due to excessive sound pressure levels.

If your tablet came with headphones or earphones in the package, as a set, the combination of the headphones or earphones and the tablet already complies with the specifications of EN 50332-1. If different headphones or earphones are used, ensure that they comply with EN 50332-1 (Clause 6.5 Limitation Values). Using headphones that do not comply with EN 50332-1 can be dangerous due to excessive sound pressure levels.

### **Take care when using your tablet in a motor vehicle or on a bicycle:**

Always prioritize your safety and the safety of others. Follow the law. Local laws and regulations might govern how you can use mobile electronic devices, such as your tablet, while you drive a motor vehicle or ride a bicycle.

### **Dispose according to local laws and regulations:**

When your tablet reaches the end of its useful life, do not crush, incinerate, immerse in water, or dispose of your tablet in any manner contrary to local laws and regulations. Some internal parts contain substances that can explode, leak, or have an adverse environmental affect if disposed of incorrectly.

See Appendix B “WEEE and recycling information” on page 103 for additional information.

**Keep your tablet and accessories away from small children:**

Your tablet contains small parts that can be a choking hazard to small children. Additionally, the glass screen can break or crack if dropped on or thrown against a hard surface.

**Protect your data and software:**

Do not delete unknown files or change the name of files or directories that were not created by you; otherwise, your tablet software might fail to work.

Be aware that accessing network resources can leave your tablet vulnerable to viruses, hackers, spyware, and other malicious activities that might damage your tablet, software, or data. It is your responsibility to ensure that you have adequate protection in the form of firewalls, antivirus software, and anti-spyware software and keep this software up to date.

Keep electrical appliances such as an electric fan, radio, high-powered speakers, air conditioner, and microwave oven away from your tablet because the strong magnetic fields generated by these appliances can damage the screen and the data on the tablet.

**Be aware of heat generated by your tablet:**

When your tablet is turned on or the battery is charging, some parts might become hot. The temperature that they reach depends on the amount of system activity and the level of charge in the battery. Extended contact with your body, even through clothing, could cause discomfort or even a skin burn. Avoid keeping your hands, your lap, or any other part of your body in contact with a hot section of the tablet for any extended time.

**Plastic bag notice****DANGER**

**Plastic bags can be dangerous. Keep plastic bags away from babies and children to avoid danger of suffocation.**

**Polyvinyl Chloride (PVC) cable and cord notice**

Many personal computer products and accessories contain cords, cables or wires, such as power cords or cords to connect the accessory to a personal computer. If this product has such a cord, cable or wire, then the following warning applies:

**WARNING:** Handling the cord on this product or cords associated with accessories sold with this product will expose you to lead, a chemical known to the State of California to cause cancer, and birth defects or other reproductive harm. ***Wash hands after handling.***



## Chapter 1. Product overview

This chapter provides an overview of the tablet, including the locations of connectors and controls, tablet features, accessories, specifications, operating environment, and preinstalled Lenovo programs.

### Tablet layout

This topic introduces the tablet hardware features to give you the basic information you need to start using the tablet.

### Front view and side view

**Note:** Your tablet might look slightly different from the following illustration.

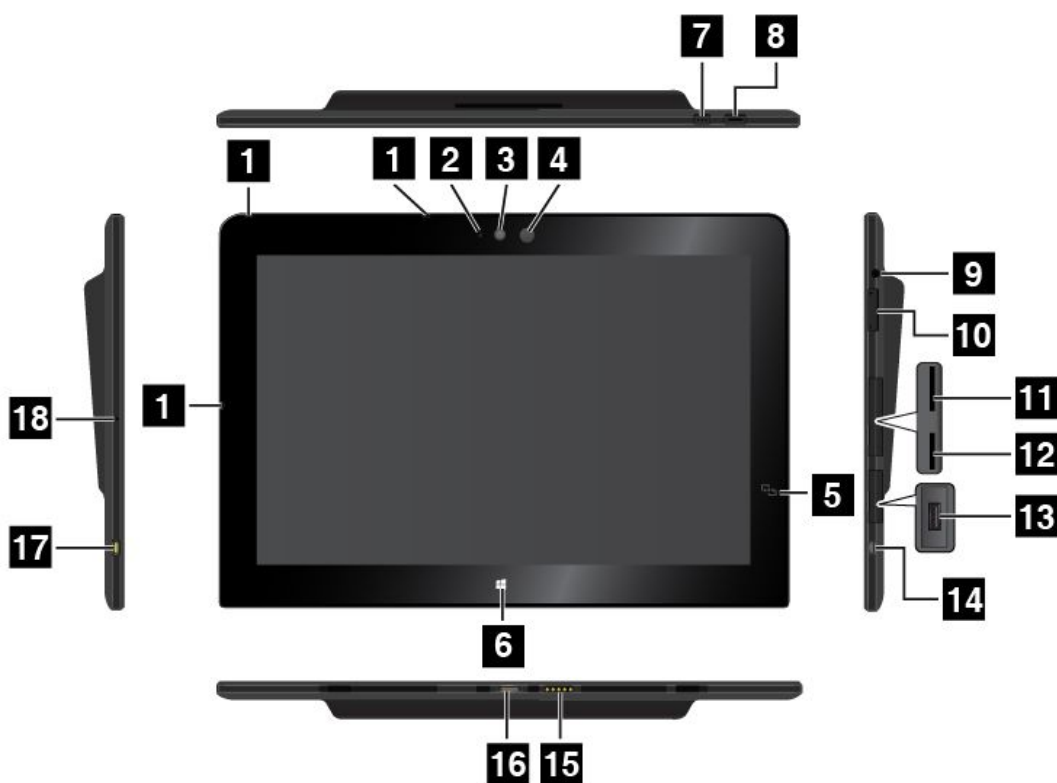

<b>1</b> Microphones	<b>2</b> Camera-status indicator
<b>3</b> Front-facing camera	<b>4</b> Ambient light sensor
<b>5</b> NFC touchpoint (on some models)	<b>6</b> Windows Start screen control
<b>7</b> Screen-rotation-lock button	<b>8</b> Power button
<b>9</b> Audio connector	<b>10</b> Volume-control buttons
<b>11</b> Micro-SIM-card slot (on some models)	<b>12</b> Micro-SD-card slot
<b>13</b> USB 3.0 connector	<b>14</b> Micro HDMI™ connector
<b>15</b> Keyboard connector	<b>16</b> Dock connector
<b>17</b> Power connector	<b>18</b> Emergency-rest hole

## **1 Microphones**

The built-in microphones capture sound and voice when they are used with an application capable of handling audio.

## **2 Camera-in-use indicator**

When you start either the front facing camera or the rear-facing camera, the camera-in-use indicator turns on automatically.

## **3 Front-facing camera**

Your tablet has a 2-megapixel front-facing camera. You can use the camera to take pictures, create videos, or make video calls in collaboration with Web applications. When the camera is started, the camera-in-use indicator turns on. For more information, see “Using the cameras” on page 20.

## **4 Ambient light sensor**

The ambient light sensor detects the brightness of the environment. The screen brightness automatically adjusts depending on the ambient light conditions detected by the ambient light sensor.

## **5 NFC touchpoint (on some models)**

If you find a near field communication (NFC) touchpoint on the right side of the display, it indicates that your tablet supports the NFC feature. For more information about the NFC feature, see “Using the NFC connection” on page 32.

## **6 Windows Start screen control**

Tap the Windows Start screen control to go to the Start screen.

## **7 Screen-rotation-lock button**

Press the button to enable or disable the screen auto-rotation function.

## **8 Power button**

Press the power button to turn on the tablet.

To turn off the tablet, swipe in from the right edge of the screen to display the charms. Then tap **Settings** → **Power** → **Shut down**.

If the tablet stops responding and you cannot turn it off, press and hold the power button for four seconds or more.

You also can program the power button so that by pressing the power button you can shut down the tablet or put it into sleep or hibernation mode. To achieve this, change your power plan settings. To access power plan settings, do the following:

1. From the desktop, tap the battery-status icon in the Windows notification area.
2. Tap **More power options**.
3. In the navigation panel, tap **Choose what the power button does**.
4. Follow the instructions on the screen to change the settings according to your preference.

## **9 Audio connector**

Connect headphones or a headset to listen to stereo sound from the tablet. You also can connect a headset to record audio or make calls.

**Note:** The audio connector does not support a conventional microphone.

## **10 Volume-control buttons**

Press the volume-up or volume-down button to adjust the tablet volume.

## **11 Micro-SIM-card slot (on some models)**

Open the protective cover to access the micro Subscriber Identification Module (SIM) card slot. Insert a micro SIM card to establish a wireless wide area network (WAN) connection. For instructions on how to install a micro SIM card, see “Installing and removing the micro SIM card” on page 27.

## **12 Micro-SD-card slot**

Open the protective cover to access the micro secure digital (SD) card reader. Insert a micro SD card into the micro-SD-card slot for data access or storage. For more information, see “Using the micro-SD-card reader” on page 20.

## **13 USB 3.0 connector**

The USB 3.0 connector is used for connecting USB-compatible devices, such as a USB printer, USB mouse, USB keyboard, USB memory key, or a digital camera.

**Attention:** When you attach a USB cable to this USB connector, ensure that the USB mark is facing upward. Otherwise the connector might be damaged.

## **14 Micro HDMI™ connector**

Your tablet has a micro High-Definition Multimedia Interface (HDMI) connector, which is a digital audio and video interface that can connect a compatible digital audio device or video display such as a high-definition television (HDTV). For more information, see “Using HDMI devices” on page 24.

## **15 Keyboard connector**

Use this connector to connect a ThinkPad Helix Ultrabook Keyboard or a ThinkPad Helix Ultrabook Pro Keyboard. For more information, see “ThinkPad Helix Ultrabook Keyboard” on page 43 and “ThinkPad Helix Ultrabook Pro Keyboard” on page 48.

## **16 Dock connector**

Use this connector to connect a ThinkPad Tablet Dock. The ThinkPad Tablet Dock is available as an option from Lenovo at <http://www.lenovo.com/essentials>. For more information, see “ThinkPad Tablet Dock” on page 59.

## **17 Power connector**

Use this connector with the supplied power cord and the ac power adapter to charge the tablet when the battery power is low.

For more information, see “Charging the battery” on page 12.

## **18 Emergency-reset hole**

If the tablet stops responding and you cannot turn it off by pressing the power button, remove the ac power adapter and insert a straightened paper clip into the emergency-reset hole to reset the tablet.

## **Rear view**

**Note:** Your tablet might look slightly different from the following illustration.

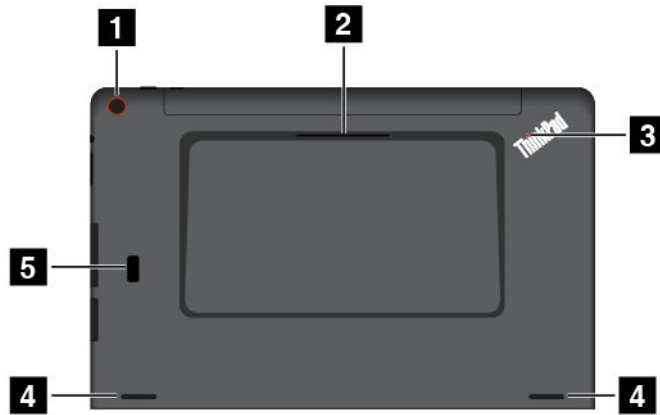

<b>1</b> Rear-facing camera	<b>2</b> Smart card slot (on some models)
<b>3</b> System-status indicator	<b>4</b> Speakers
<b>5</b> Fingerprint reader (on some models)	

### **1 Rear-facing camera**

Your tablet has an 5-megapixel rear-facing camera. You can use the camera to take pictures and create videos. For more information, see “Using the cameras” on page 20.

### **2 Smart card slot (on some models)**

Your tablet might have a smart card slot. For more information, see “Using a smart card ” on page 22.

### **3 System-status indicator**

The illuminated dot in the ThinkPad logo on the backside of the tablet works as a system-status indicator.

- **Blinks three times:** The tablet is connected to a power source.
- **On:** The tablet is on and in use.
- **Off:** The tablet is off, in sleep mode, or in hibernation mode.

### **4 Speakers**

The integrated speakers provide audio output for video and music playback.

### **5 Fingerprint reader (on some models)**

Fingerprint authentication technology provides simple and secure user access by associating your fingerprint with a password. For more information, see “Using the fingerprint reader” on page 15.

---

## Accessories

The following are some examples of accessories available for your tablet. You can purchase these accessories from the Lenovo Web site at <http://www.lenovo.com/essentials> or from a Lenovo reseller.



**1 Power cord and ac power adapter:** Use the power cord together with the ac power adapter to provide ac power to your tablet and charge the battery.

**2 ThinkPad Helix Quickshot Cover (on some models):** The ThinkPad Helix Quickshot Cover attaches to the tablet magnetically. Use the cover to do the following:

- Protect the tablet screen.
- Wake up the tablet or put the tablet into sleep mode conveniently.
- Launch the camera.
- Serve as a stand for the tablet.

For more information, see “Using the ThinkPad Helix Quickshot Cover” on page 18.

**3 Tablet Digitizer Pen (on some models):** Some tablets are equipped with a Tablet Digitizer Pen. Use the Tablet Digitizer Pen to input text or draw graphics in a natural manner and perform other operations without tapping the screen with your finger. For more information, see “Using the Tablet Digitizer Pen” on page 14.

For more information about other options available for your tablet, see Chapter 5 “ThinkPad Helix options” on page 43.

---

## Features

### Processor

- Intel® Core™ processor

### Operating system

- Microsoft® Windows 8.1

### Memory

- 4 GB or 8 GB

### Internal storage

- M.2 solid-state drive

### Display

- Anti-reflective, Gorilla Glass
- Size: 294.5 mm (11.6 inches)
- Screen resolution: 1920 x 1080 pixels
- Automatic brightness control (ambient light sensor)
- In-plane switching technology for fast response time, wide viewing angle, and high-quality color reproduction
- Light-emitting diode (LED) backlight technology
- Multi-touch technology

### Integrated cameras

- Front-facing camera, two megapixels
- Rear-facing camera, five megapixels, auto-focus

## Connectors

- One audio connector
- One power connector
- One keyboard connector
- One dock connector
- One micro HDMI connector
- One USB 3.0 connector
- One Always On USB 3.0 connectors (on the ThinkPad Helix Ultrabook Pro Keyboard)
- One Mini DisplayPort connector (on the ThinkPad Helix Ultrabook Pro Keyboard)
- One USB 2.0 connector (on the ThinkPad Helix Ultrabook Keyboard)

## Card slot or card reader

- One micro-SIM-card slot (on some models)
- One micro-SD-card slot
- One smart card slot (on some models)

## Wireless features

- Bluetooth 4.0
- Wireless LAN
- Wireless WAN (on some models)
- NFC (on some models)
- Global Positioning System (GPS) satellite receiver (on some models)

## Security features

Fingerprint reader (on some models)

---

# Specifications

## Tablet size

- Width: 301.1 mm (11.85 inches)
- Depth: 192.5 mm (7.58 inches)
- Height:
  - For models without a smart card slot: 9.6 mm (0.38 inch)
  - For models with a smart card slot: 19.35 mm (0.76 inch)

## ThinkPad Helix Ultrabook Keyboard size

- Width: 301.1 mm (11.85 inches)
- Depth: 215.7 mm (8.49 inches)
- Height: 7.3 mm (0.29 inches) to 25.4 mm (1.0 inches)

## ThinkPad Helix Ultrabook Pro Keyboard size

- Width: 301.1 mm (11.85 inches)
- Depth: 213.3 mm (8.4 inches)

- Height: 20.2 mm (0.8 inches)

### Battery

- 35 Wh Li-Polymer battery

### Power source (ac power adapter)

- Sine-wave input at 50 Hz to 60 Hz
- Input rating of the ac power adapter: 100 V ac to 240 V ac

## Operating environment

- Maximum altitude without pressurization: 5000 m (16 404 ft)
- Temperature:
  - At altitudes up to 2438 m (8000 ft)
    - Operating: 5.0°C to 35.0°C (41°F to 95°F)
    - Storage: 5.0°C to 43.0°C (41°F to 109°F)
  - At altitudes above 2438 m (8000 ft)
    - Maximum temperature when operating under unpressurized conditions: 31.3°C (88°F)
- Relative humidity:
  - Operating: 8% to 95%
  - Storage: 5% to 95%

If possible, place your tablet in a dry, well-ventilated area without direct exposure to sunshine. Do not use or store your tablet in dusty, dirty areas, or extremely hot or cold areas.

## Lenovo programs

Your tablet comes with Lenovo programs to help you work more easily and securely.

To access Lenovo programs, swipe in from the right edge of the screen to display the charms. Then tap the **Search** charm to search for the desired program.

The following table provides a brief introduction to some Lenovo programs that might be preinstalled on your tablet.

**Note:** Preinstalled Lenovo programs vary by geographic locations and are subject to change.

Lenovo Program	Description
Lenovo Companion	Get information about accessories for your tablet, view blogs and articles about your tablet, and check for recommended programs.
Lenovo QuickControl	Enable you to control your tablet remotely through your smartphone, such as controlling the pointer, changing projection settings, and managing foreground applications and windows.
Lenovo Reach	Enhance your cloud experience. Lenovo Reach keeps you connected at all times and enables you to access all your favorite items from personal tablets, smartphones, or tablets. With Lenovo Reach, you can add your favorite Web services to your cloud desktop; stay logged in to Web sites with the cloud password manager; and access, edit, and share your files from anywhere.
Lenovo Settings	Enhance your computing experience by configuring camera and microphone settings, optimizing your power settings, and creating and managing multiple network profiles.

<b>Lenovo Program</b>	<b>Description</b>
Lenovo SHAREit	Enable you to share files easily and rapidly across devices such as computers and smartphones, even without any Internet connection. You can connect to your friends and send photos, folders, and other files through Lenovo SHAREit. Every sharing is quick and simple.
Lenovo Solution Center	Troubleshoot and resolve tablet problems. It combines diagnostic tests, system information collection, security status, and support information, along with hints and tips for maximum system performance.
Lenovo Support	Register your tablet with Lenovo, view user manuals for your tablet, get the warranty information for your tablet, and explore help and support information.
System Update	Keep the software on your tablet up-to-date by downloading and installing software packages, including Lenovo programs, device drivers, Unified Extensible Firmware Interface (UEFI) basic input/output system (BIOS) updates, and other third-party programs.



---

## Chapter 2. Using your tablet

This chapter provides instructions on how to use some basic applications and tablet features.

---

### Initial setup instructions

To use the tablet the first time after you take it out of the box, ensure that you follow the instructions below:

1. Connect the power cord to the ac power adapter **1**. Then, connect the power connector of the ac power adapter to the power connector on the tablet **2**.
2. Plug the power cord into a standard ac power outlet **3**.



3. Press and release the power button to turn on the tablet.
4. Follow the instructions on the screen to complete the initial setup.

If your tablet comes with a ThinkPad Ultrabook Pro Keyboard, you also can setup your tablet by doing the following:

1. Install the tablet into the ThinkPad Ultrabook Pro Keyboard. See “Installing or removing the tablet” on page 50.

2. Connect the power cord to the ac power adapter **1**. Then, connect the power connector of the ac power adapter to the power connector on the keyboard **2**.
3. Plug the power cord into a standard ac power outlet **3**.

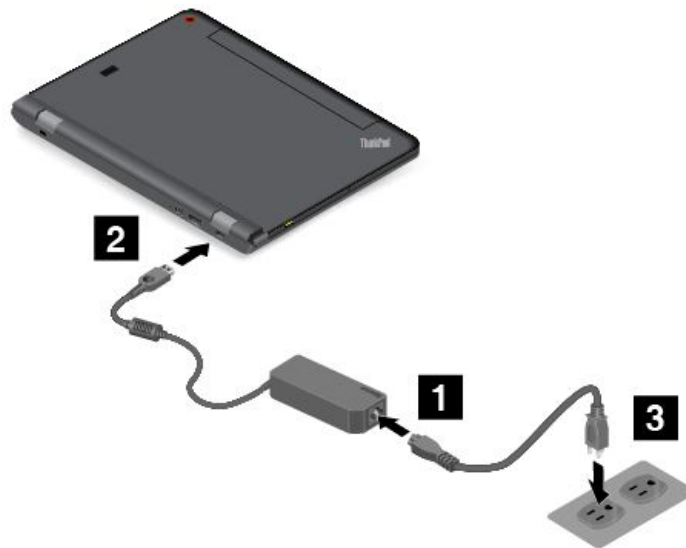

4. Press and release the power button to turn on the tablet.
5. Follow the instructions on the screen to complete the initial setup.

## Using the multi-touch screen

This topic provides instructions on how to use the multi-touch screen.

**Note:** Your tablet screen might look different from the following illustrations.

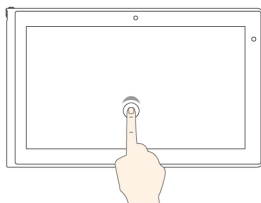

### Tap

Tap on the screen to open an app or perform an action on an open app, such as **Copy**, **Save**, and **Delete**, depending on the app.

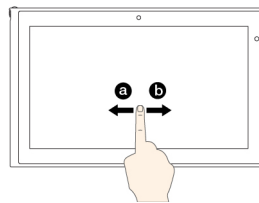

### Slide

Slide leftward or rightward on the screen to scroll through items, such as lists, pages, and photos.

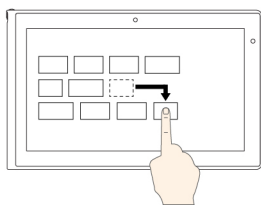

### Drag

Drag an item to the desired location to move an object.

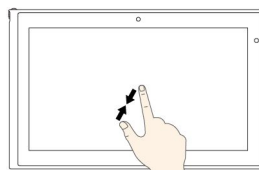

### Zoom out

Put two fingers on the screen and move them closer together to zoom out.

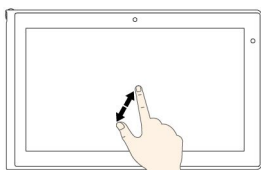

### Zoom in

Put two fingers on the screen and move them farther apart to zoom in.

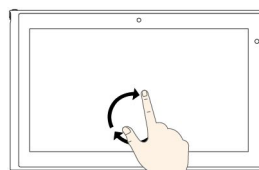

### Rotate

Put two or more fingers on an item, and then rotate your fingers clockwise or counterclockwise (supported only on some apps).

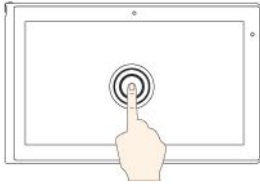

### Tap and hold

Tap and hold on the screen to open a menu with multiple options.

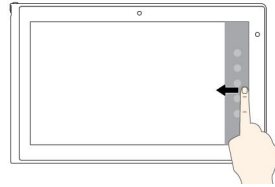

### Swipe from the right edge

Swipe in from the right edge of the screen to display the charms that contain system commands, such as **Start**, **Settings**, **Search**, **Share**, and **Devices**.

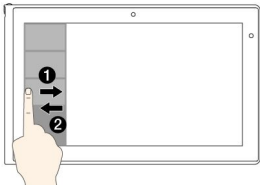

### Swipe in and out on the left edge

Swipe in and out on the left edge of the screen to view the recently used apps or select an active app from the list.

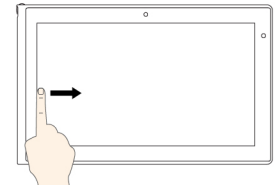

### Swipe from the left edge

Swipe in from the left edge of the screen to cycle through and switch to open apps.

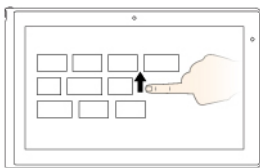

### Swipe up to the top edge

Swipe up to the top edge of the screen to view all apps on the Start screen.

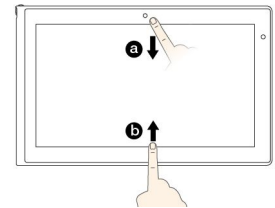

### Swipe from the top or bottom edge

Swipe in from the top or bottom edge of the screen to view the app commands, such as **Copy**, **Save**, and **Delete**, depending on the app.

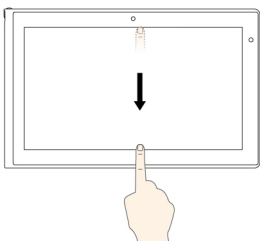

### Swipe in from the top edge to the bottom

Swipe in from the top edge to the bottom of the screen to close the current app.

## Tips on using the multi-touch screen

- The multi-touch screen is a glass panel covered with a plastic film. Do not apply pressure or place any metallic object on the screen that might damage the touch panel or cause it to malfunction.
- Do not use fingernails, gloved fingers, or inanimate objects other than an approved Tablet Digitizer Pen for input on the screen.

## Tips on cleaning the multi-touch screen

- Turn off the tablet before cleaning the multi-touch screen.
- Use a dry, soft, and lint-free cloth or a piece of absorbent cotton to remove fingerprints or dust from the multi-touch screen. Do not apply solvents to the cloth.
- Gently wipe the screen using a top-down motion. Do not apply any pressure on the screen.

---

## Power management

This section provides instructions on how to charge the battery, extend the battery life between charges, and check the battery status.

## Charging the battery

The tablet is shipped with an ac power adapter and a power cord to charge the tablet from any standard ac power outlet.

**Note:** The battery is not fully charged when shipped.

**Attention:** Use only Lenovo-approved ac power adapters. Unauthorized ac power adapters could severely damage the tablet.

To charge the tablet battery, do one of the following:

- Use the ac power adapter shipped with the tablet to charge the tablet battery as shown.



- If your tablet comes with a ThinkPad Helix Ultrabook Pro Keyboard, use the ThinkPad Helix Ultrabook Pro Keyboard and the ac power adapter shipped with the keyboard to charge the tablet battery and keyboard battery as shown.

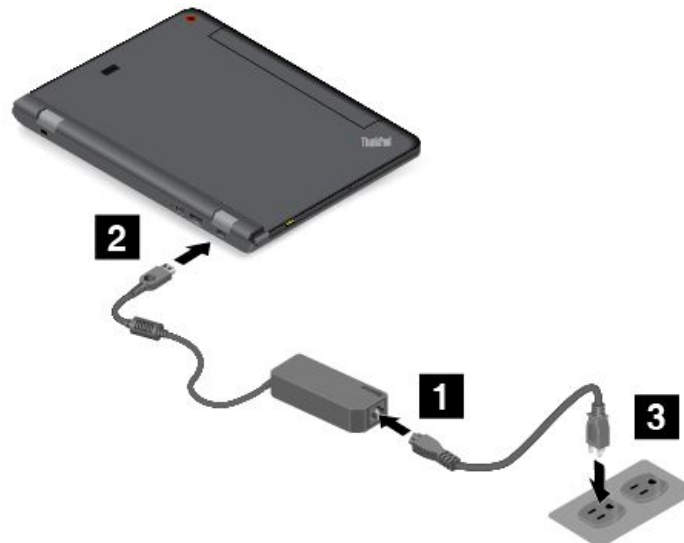

- Use the ThinkPad Tablet Dock and the ac power adapter shipped with the dock to charge the internal battery of your tablet. See “Using the ThinkPad Tablet Dock” on page 61. The ThinkPad Tablet Dock is an optional device. To purchase the option from Lenovo, go to: <http://www.lenovo.com/essentials>

## Extending the battery life between charges

When you are traveling with your tablet and ac power is not available, you can extend the battery life by doing the following:

- Turn off Wi-Fi, mobile network, and Bluetooth when not in use.  
To turn off Wi-Fi, mobile network, and Bluetooth, do the following:
  1. Swipe in from the right edge of the screen to display the charms.
  2. Tap **Settings** → **Change PC settings**.
  3. In the navigation panel, tap **Network** → **Airplane mode**.
  4. In the **Airplane mode** section, slide the control to the right to turn on **Airplane mode** to disable all wireless devices.
- Turn off automatic synchronization if you do not need it.  
To turn off the automatic synchronization function, do the following:
  1. Swipe in from the right edge of the screen to display the charms.
  2. Tap **Settings** → **Change PC settings**.
  3. In the navigation panel, tap **OneDrive** → **Sync settings**.
  4. Switch off **Sync settings with OneDrive**.
- Lower the brightness level of the screen.  
To lower the brightness level of the screen, do the following:
  1. Swipe in from the right edge of the screen to display the charms.
  2. Tap **Settings** → **Brightness**.
  3. Slide the control down to lower the brightness.
- Enter sleep mode when the tablet is temporarily not in use.  
To enter sleep mode, do one of the following:
  - Close the ThinkPad Helix Quickshot Cover.
  - To enter sleep mode from the operating system, do the following:
    1. Swipe in from the right edge of the screen to display the charms.
    2. Tap **Settings** → **Power** → **Sleep**.
- Turn off your tablet if you are not going to use it for a while.  
To turn off your tablet, do the following:
  1. Swipe in from the right edge of the screen to display the charms.
  2. Tap **Settings** → **Power** → **Shut down**.

## Checking the battery status

Get the approximate status of your battery at any time by checking the desktop battery-status icon in the Windows notification area.

To check for the accurate status and adjust your tablet power settings to achieve the best balance between performance and power saving, do the following:

1. From the Start screen, tap **Lenovo Settings** → **Power**.
2. Check your battery status and configure settings.

---

## Using the Tablet Digitizer Pen

Some models are equipped with a Tablet Digitizer Pen as a standard feature. The Tablet Digitizer Pen enables you to input text in a natural manner, take notes, annotate Portable Document Format (PDF) files, and draw graphics together with applications capable of editing and sketching.

### Notes:

- This pen is not waterproof. Take care not to soak it or dip it in water.
- The pen contains pressure sensors. Do not push the tip of the pen for an extended period of time. Do not subject the pen to shock or vibration.

The Tablet Digitizer Pen consists of a tip **1**, a click button **2**, and an eraser tip **3**. Hold the pen and point the tip at the display to move the pointer. The eraser tip **3** functions like an eraser in programs that support this function.

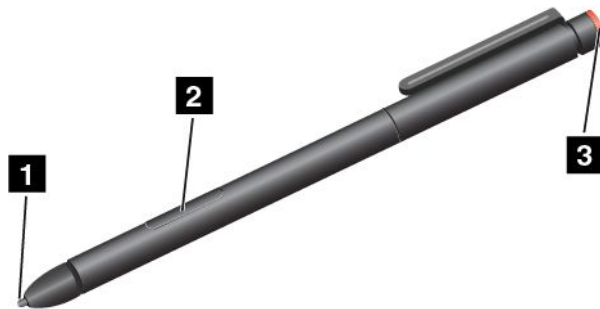

To make a selection (single click), tap the display once with the pen. To double-click, tap the display twice with the pen without pausing between taps. To right-click, do one of the following:

- Tap and hold the tip of the pen on the display for one second and then lift the pen from the display.
- Press and hold the click button **2** and tap the tip on the display.

For more instructions about using the pen with ThinkPad Helix Ultrabook Keyboard or ThinkPad Helix Ultrabook Pro Keyboard, see “Using the ThinkPad Helix Ultrabook Keyboard” on page 44 or “Using the ThinkPad Helix Ultrabook Pro Keyboard” on page 50.

---

## Using the On-Screen Keyboard or the touch keyboard and handwriting panel

Use the On-Screen Keyboard or the touch keyboard and handwriting panel to type text, numbers, symbols, and other characters. You also can use the touch keyboard and handwriting panel to perform handwriting. When you rotate the tablet, the On-Screen Keyboard or the touch keyboard and handwriting panel automatically rotates to the corresponding portrait or landscape view.

To open the On-Screen Keyboard, do the following:

1. Swipe in from the right edge of the screen to display the charms.
2. Tap the **Search** charm to search for **On-Screen Keyboard**.
3. Tap **On-Screen Keyboard**.

To open the touch keyboard and handwriting panel, do one of the following:

- On the desktop, tap the keyboard icon in the Windows notification area.

- On the Start screen, the touch keyboard and handwriting panel is displayed automatically anytime you type.
- On the Desktop or the Start screen, do the following:
  1. Swipe in from the right edge of the screen to display the charms.
  2. Tap the **Settings** charm.
  3. Tap **Keyboard → Touch keyboard and handwriting panel**.

To configure the input language, do the following:

1. From the desktop, swipe in from the right edge of the screen to display the charms.
2. Tap **Settings → Control Panel**.
3. Tap **Clock, Language, and Region → Change input methods**.
4. Follow the instructions on the screen to configure the input language.

---

## Changing the startup behavior to open either the desktop or the Start screen

You can set the tablet to open either the desktop or the Start screen by default. To set the default startup screen, do the following:

1. On the desktop, tap and hold on the taskbar. A menu is displayed.
2. Tap **Properties**. The Taskbar and Navigation properties window is displayed.
3. On the **Navigation** tab, locate the **Start screen** section, and then do one of the following:
  - To set the desktop as your default startup screen, select **When I sign in or close all apps on a screen, go to the desktop instead of Start** so a check is visible.
  - To set the Start screen as your default startup screen, remove the check from the **When I sign in or close all apps on a screen, go to the desktop instead of Start** checkbox.
4. Tap **OK** to save the new setting.

---

## Downloading games and applications

To extend the functionality of your tablet, download and install additional applications from the Windows Store. The Windows Store provides an easy and quick way for you to shop for games and mobile applications.

To download or buy an application or a game from Windows Store, tap **Store** from the Start screen, and then follow the instructions on the screen.

---

## Using the fingerprint reader

Depending on the model, your tablet might have a fingerprint reader. Fingerprint authentication can replace your Windows password. In this way, you can log on to your tablet simply and securely. To enable fingerprint authentication, enroll your fingerprints first.

### Enrolling your fingerprints

To enroll your fingerprints, do the following:

1. Swipe in from the right edge of the screen to display the charms.
2. Tap **Settings → Change PC settings**.
3. In the navigation panel, tap **Accounts → Sign-in options**.

4. In the **Fingerprint** section, tap **Add**. The “Add a fingerprint to this account” window is displayed.
5. Enter the Windows password as required. Then follow the instructions on the screen to enroll your fingerprint.

**Note:** It is recommended that you enroll more than one fingerprint in case of any injuries to your fingers.

### Swiping your finger over the fingerprint reader

To swipe your finger over the fingerprint reader, do the following:

**Note:** Your tablet might look slightly different from the illustrations in this topic.

1. Place the top joint of your finger on the sensor.

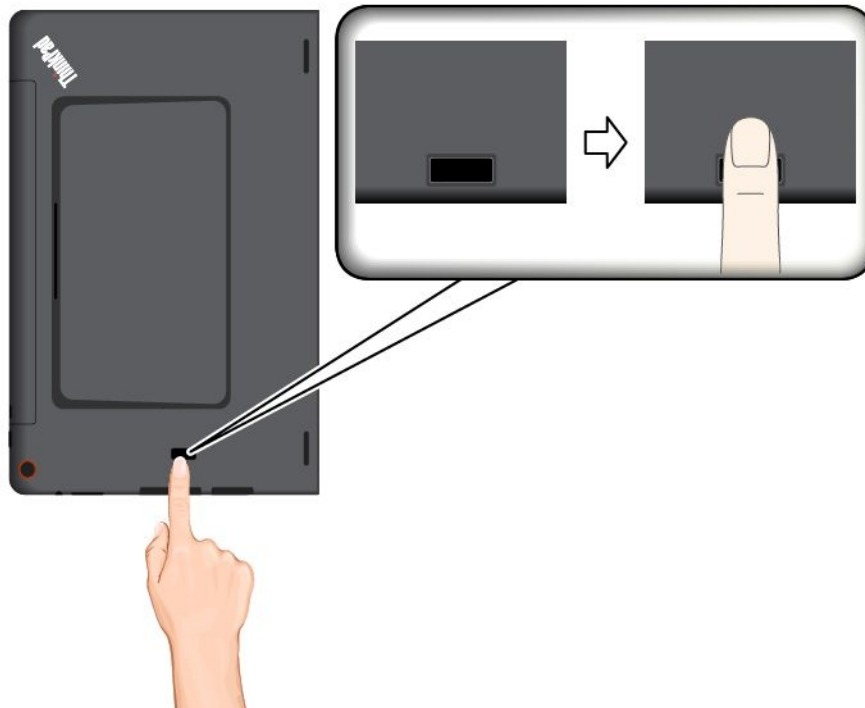



2. Apply light pressure and swipe your finger toward you across the reader in one smooth motion. Do not lift your finger when you are swiping it.

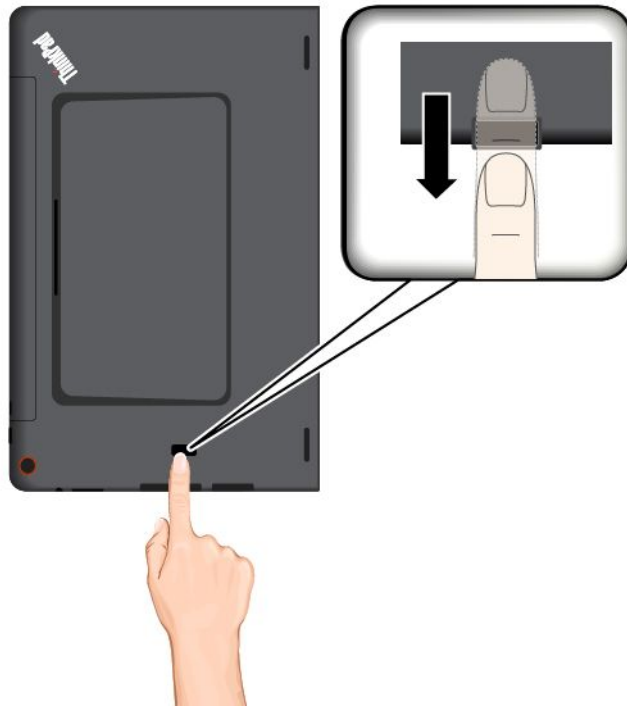

### **Maintaining the fingerprint reader**

The following actions could damage the fingerprint reader or cause it not to work properly:

- Scratching the surface of the reader with a hard, pointed object.
- Scraping the surface of the reader with your fingernail or anything hard.
- Using or touching the reader with a dirty finger.

If you notice any of the following conditions, gently clean the surface of the reader with a dry, soft, lint-free cloth:

- The surface of the reader is dirty or stained.
- The surface of the reader is wet.
- The reader often fails to enroll or authenticate your fingerprint.

If your finger has any of the following conditions, you might not be able to register or authenticate it:

- Your finger is wrinkled.
- Your finger is rough, dry, or injured.
- Your finger is stained with dirt, mud, or oil.
- The surface of your finger is different from when you enrolled your fingerprint.
- Your finger is wet.
- A finger is used that has not been enrolled.

To improve the situation, try the following:

- Clean or wipe your hands to remove any excess dirt or moisture from the fingers.

- Enroll and use a different finger for authentication.
- If your hands are dry, apply lotion to them.

---

## Using the ThinkPad Helix Quickshot Cover

Depending on the model, your tablet might come with a ThinkPad Helix Quickshot Cover (hereafter called the cover). This topic provides instructions on how to use the cover.

To use the cover, attach the cover to the tablet first as shown. The cover will be attached to the tablet magnetically.



### Put the tablet into sleep mode or wake up the tablet

If the cover is open and the tablet is on, the tablet, by default, enters sleep mode automatically after you close the cover.



If the cover is closed and the tablet is in sleep mode, the tablet, by default, resumes normal operation when you open the cover.



You also can change the settings so that by closing the cover you can shut down the tablet, put the tablet into hibernation mode, or do nothing. To achieve this, you must change your lid settings by doing the following:

1. From the desktop, swipe in from the right edge of the screen to display the charms.
2. Tap **Settings** → **Control Panel** → **Hardware and Sound** → **Power Options**.
3. In the navigation panel, tap **Choose what closing the lid does**.
4. Follow the instructions on the screen to choose an option according to your preference.

### Launch the camera

When you use the tablet with the cover open to an angle of 360 degrees, you can flip over the magnetic tab of the cover as shown to launch the camera automatically. This function is enabled by default.



If you want to disable this function, do the following:

1. From the Start screen, tap **Lenovo Settings** → **Camera**.
2. In the **Quickshot** section, slide the control to the left to disable the function.

## Serve as a stand for the tablet

The cover can serve as a stand for the tablet as shown. In this way, you can use the tablet to watch movies, view photos, or make a presentation conveniently.

**Note:** If your tablet is equipped with a smart card slot on the rear side, the cover might not work well as a stand for the tablet.



---

## Using the cameras

Your tablet has two cameras, a front-facing camera and a rear-facing camera. The rear-facing camera has an auto-focus feature that enables you to capture high-quality pictures and videos.

To launch a camera and configure the camera settings, do the following:

1. From the Start screen, tap **Lenovo Settings** → **Camera**.
2. Follow the instructions on the screen to configure settings and use the camera.

To switch between the front-facing camera and the rear-facing camera, do the following:

1. From the Start screen, tap **Lenovo Settings** → **Camera**.
2. In the **View** section, select **Front-facing camera** or **Rear-facing camera** from the **Select a camera** drop-down list box to switch the cameras.

You also can use the camera with other applications that provide features such as photographing, video capturing, and video conferencing. To download other applications, tap Windows **Store** from the Start screen. Then follow the instructions on the screen.

---

## Using the micro-SD-card reader

Your tablet has a micro-SD-card reader that provides a micro-SD-card slot for you to install a micro SD card. The micro-SD-card slot supports the following types of cards:

- Secure Digital eXtended-Capacity (SDXC) card
- Secure Digital (SD) card
- Secure Digital High-Capacity (SDHC) card

### Installing a micro-SD-card

**Attention:** Before handling a micro SD card, touch a metal table or a grounded metal object. This action reduces any static electricity from your body. Static electricity can damage the card.

To install a micro SD card into the micro-SD-card slot, do the following:

1. Open the protective cover on the left side of your tablet. Then locate the micro-SD-card slot **a**.



2. Ensure that the metal contacts of the card are facing down and pointing toward the tablet.
3. Insert the card into the micro-SD-card slot. The card might stop before it is completely installed into the card reader. Ensure that you insert the card firmly until you hear a click.



### Removing a micro SD card

To remove a micro SD card, do the following:

1. Open the protective cover on the left side of your tablet.

2. Push the micro SD card inward a little until you hear a click **1**. Then, release it. The micro SD card ejects.
3. Gently slide the card out of the card slot **2**.



---

## Using a smart card

Some models come with a smart card slot. This topic provides information on how to use the smart card.

Generally, smart cards can provide authentication, data storage, and application processing. Smart cards also might provide strong security authentication for single sign-on (SSO) within large organizations.

Your tablet supports smart cards with the following specifications:

- Width: 85.60 mm (3.37 inches)
- Depth: 53.98 mm (2.13 inches)
- Height: 0.76 mm (0.03 inch)

The following illustrations show both sides of a smart card. In illustration **1**, the metal contacts **a** of the card are facing upward. In illustration **2**, the metal contacts **a** of the card are facing downward.

**Note:** Your smart card might look slightly different from the following illustrations.

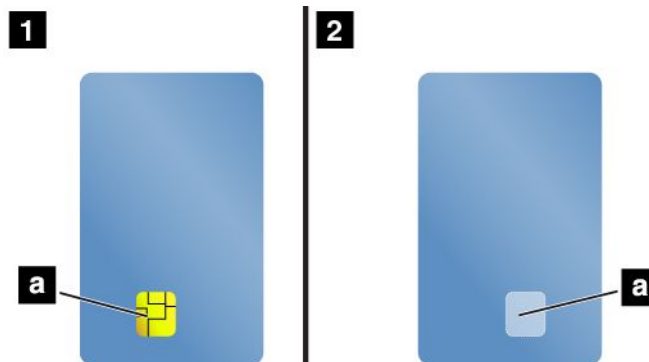

### Installing a smart card

#### Attention:

- Before installing a smart card, touch a metal table or a grounded metal object. This action reduces any static electricity from your body. Static electricity could damage the card.
- While transferring data to or from a smart card, do not put your tablet into sleep or hibernation mode before the data transfer finishes; otherwise, your data could become damaged.

To install a smart card, do the following:

1. Position your tablet as shown and ensure that the metal contacts **a** of the card are facing downward and pointing toward the card slot.
2. Insert the card into the slot as shown.

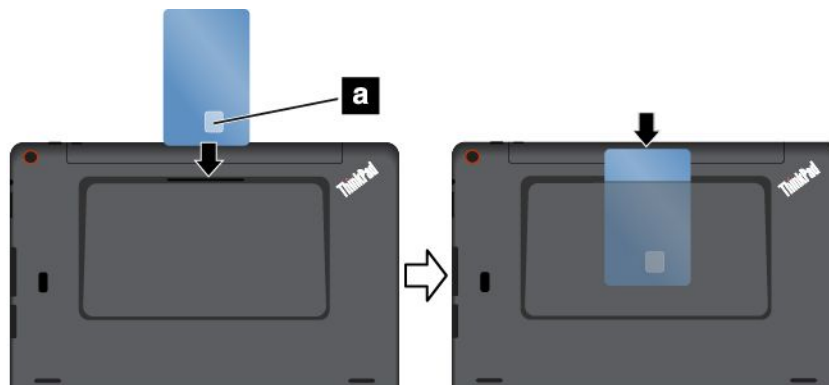

If the plug-and-play feature is not enabled for the installed smart card, do the following to enable the feature:

1. Go to Control Panel.
2. Tap **Hardware and Sound**.
3. Tap **Device Manager**. If you are prompted for an administrator password or confirmation, type the password or provide confirmation.
4. From the **Action** menu, tap **Add legacy hardware**. The Add Hardware Wizard starts.
5. Follow the instructions on the screen.

## Removing a smart card

### Attention:

- Before removing a smart card, stop the card first. Otherwise, data on the card might be damaged or lost.
- Do not remove the smart card while the tablet is in sleep mode or hibernation mode. Otherwise, the system might not respond when you try to resume operation.

To remove a smart card, do the following:

1. Tap the triangular icon on the taskbar to show hidden icons. Then, tap and hold the **Safely Remove Hardware and Eject Media** icon.
2. Tap the item you want to remove to stop the card.
3. Pull the card outward a little, and gently slide the card out of the slot.

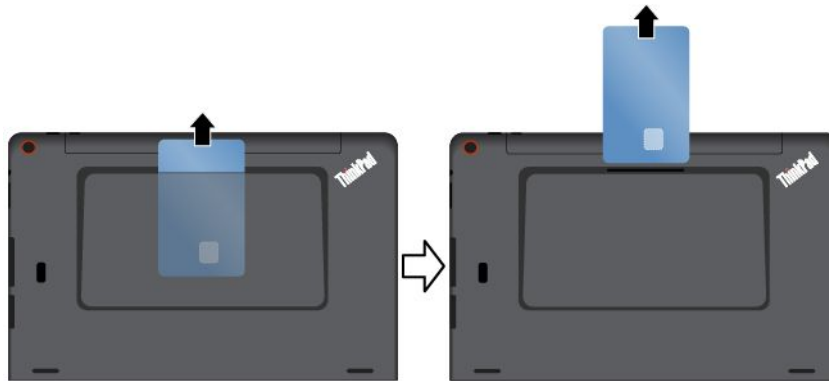

**Note:** If you do not remove the smart card from your tablet after you eject the card from the Windows operating system, the card can no longer be accessed. To access the card, you must remove it first, then insert it again.

---

## Using HDMI devices

Your tablet has a micro HDMI connector that you can use to connect an external display for video output. To locate the micro HDMI connector, see “Tablet layout” on page 1.

### Connecting an external monitor

When you connect an external monitor, a video interface cable with a ferrite core is required.

You might need a micro HDMI to VGA adapter. You can purchase the micro HDMI to VGA adapter as option at <http://www.lenovo.com/essentials>.

To connect an external monitor, do the following:

1. Connect a supported external display to the micro HDMI connector on your tablet.
2. Connect the external monitor to an electric outlet.
3. Turn on the external display.

If your tablet cannot detect the external display, right-click anywhere on the desktop, then click **Screen → Resolution → Detect**.

### Configuring the settings

To configure screen settings for the external display, do the following:



1. Swipe in from the right edge of the screen to display charms.
2. Tap the **Devices** charm.
3. Tap **Project** → **Second screen**.
4. Tap to select a presentation scheme.

---

## Using synchronization solutions

By using synchronization solutions, you can easily synchronize settings between your tablet and other personal computer.

You can synchronizing the settings by using the Windows synchronization solution.

To access Windows synchronization solution, do the following:

1. Swipe in from the right edge of the screen to display the charms.
2. Tap **Settings** → **Change PC settings**.
3. In the navigation panel, tap **OneDrive** → **Sync settings**.
4. Configure settings as desired.

---

## Using the GPS satellite receiver

Your tablet might have a GPS satellite receiver that enables you to pinpoint your location down to the street level. Use location-based applications to find your current location, get directions to your destination, and find other location-based information.

**Note:** By default, the GPS satellite receiver is enabled. For a longer battery life, disable the GPS satellite receiver when not in use.

To disable the GPS satellite receiver, do the following:

1. Swipe in from the right edge of the screen to display the charms.
2. Tap **Settings** → **Change PC settings**.
3. In the navigation panel, tap **Network** → **Airplane mode**.
4. In the **GNSS** section, slide the control to the left to disable the GPS satellite receiver.

---

## Turning off the tablet

To turn of the tablet, do one of the following:

- Go to the Start screen by pressing the Windows key, click the power icon in the top-right corner of the screen, then click **Shut down**.
- Move your pointer to the top-right or bottom-right corner of the screen to display the charms. Then click **Settings** → **Power** → **Shut down**.

**Note:** If your tablet is attached to a supported keyboard, you also can open the **Settings** charm by pressing the settings key .



---

## Chapter 3. Wireless networks and devices

Your tablet can connect to a variety of networks and devices, including mobile networks (3G or 4G), Wi-Fi data networks, and Bluetooth devices.

**Note:** Some tablet models can connect to both mobile networks (3G or 4G) and Wi-Fi networks, while others can connect to Wi-Fi networks only. If your tablet supports Wi-Fi connection only, the information related to mobile networks does not apply to your tablet.

---

### Installing and removing the micro SIM card

If the tablet supports mobile network connection, it might require a micro SIM card to connect to a mobile network. The micro SIM card is shipped with some tablet models only and you can purchase one when necessary.

**Attention:** When installing or removing the micro SIM card, do not touch the micro SIM card metal connectors. Always hold the tablet in your hand before you install or remove the micro SIM card to avoid electrostatic discharges.

To install the micro SIM card, do the following:

1. Turn off the tablet.
2. Open the protective cover on the left side of your tablet. Then locate the micro-SIM-card slot **a**.



3. Hold the micro SIM card with the metal contacts facing down, and then insert it firmly into the micro-SIM-card slot as shown until you hear a click.



4. Close the protective cover and turn on your tablet.



To remove the micro SIM card, do the following:

1. Turn off the tablet.
2. Open the protective cover on the left side of your tablet.

3. Push the micro SIM card inward until you hear a click **1**. The micro SIM card ejects. Gently slide the micro SIM card out of the slot **2**.



4. Close the protective cover.

---

## Determining which mobile network you are using

If you have connected to a network, you can check the network name to see which mobile network you are using.

To check the network name, do one of the following:

- Swipe in from the right edge of the screen to display the charms. Then tap the **Settings** charm. The network name is displayed under the network icon.
- On the desktop, move the pointer to the network icon in the Windows notification area. The network name is displayed.

---

## Connecting to a Wi-Fi network

Wi-Fi is a wireless networking technology that provides network access at distances of up to 100 meters (328 feet) depending on the Wi-Fi router and your surroundings.

A Wi-Fi connection requires access to a functioning Wireless Access Point (WAP), also called a hotspot. Some hotspots are open to the public, but some others implement security features to limit access to specific groups or individuals.

**Note:** The range and quality of the Wi-Fi signal are affected by the number of connected devices, the infrastructure, and the objects through which the signal is transmitted.

### Connecting to a Wi-Fi network

To establish a Wi-Fi network connection, do the following:

1. Swipe in from the right edge of the screen to display the charms.

2. Tap the **Settings** charm.
3. Tap the network icon. A list of available Wi-Fi networks is displayed.
4. Tap the ID of the network you want to connect.
5. Follow the instructions on the screen to connect to the Wi-Fi network.

To view security, address, and other information about the Wi-Fi network you are connected, do the following:

1. Swipe in from the right edge of the screen to display the charms.
2. Tap **Settings** → **Change PC settings**.
3. In the navigation panel, tap **Network** → **Connections**.
4. In the **Wi-Fi** section, tap the network name to view the information.

The tablet supports the proxy feature for Wi-Fi connection. The proxy feature enables you to access more Web-based source and browse Internet more securely. If you want to configure the proxy settings when you are connecting to a Wi-Fi network, do the following:

1. Swipe in from the right edge of the screen to display the charms.
2. Tap **Settings** → **Change PC settings**.
3. In the navigation panel, tap **Network** → **Proxy**.
4. Follow the instructions on the screen to configure the proxy settings.

### **Adding a Wi-Fi network**

If you want to access a Wi-Fi network that does not broadcast its network name (also called a service set identifier or SSID), you must add that Wi-Fi network before you can connect to it.

To add a Wi-Fi network, do the following:

1. Swipe in from the right edge of the screen to display the charms.
2. Tap the **Settings** charm.
3. Tap the network icon. A list of available Wi-Fi networks is displayed.
4. Tap **Hidden network**.
5. Follow the instructions on the screen to add a Wi-Fi network.

### **Adding a network profile**

Each location profile stores all the network and Internet configuration settings needed for connecting to a network infrastructure from a specific location such as a home or an office. By switching between location profiles as you move your tablet from place to place, you can quickly and easily connect to a network with no need to reconfigure your settings manually and restart the tablet each time.

To add a network profile, do the following:

1. From the Start menu, tap **Lenovo Settings**.
2. Tap **Location Awareness**.
3. Follow the instructions on the screen to add a network profile.

---

## **Connecting to a mobile network**

A micro SIM card is required to connect to a mobile network. Refer to “Installing and removing the micro SIM card” on page 27 for instructions on how to install a micro SIM card.

**Note:** Some tablets support access to Wi-Fi networks only. See “Connecting to a Wi-Fi network” on page 29 for instructions on connecting to a Wi-Fi network.

To connect to the mobile network, do the following:

1. Swipe in from the right edge of the screen to display the charms.
2. Tap the **Settings** charm.
3. Tap the network icon. A list of available networks is displayed.
4. In the **Mobile broadband** section, slide the control to the right to turn it on.
5. Tap the network name. A menu is displayed.
6. Tap **Connect**.

When you are connected to the mobile network, set the active mobile network as metered connection to reduce the amount of data you send and receive.

To set the active mobile network as metered connection, do the following:

1. Swipe in from the right edge of the screen to display the charms.
2. Tap **Settings → Change PC settings**.
3. In the navigation panel, tap **Network → Connections**.
4. In the **Mobile broadband** section, tap the network name. A menu is displayed.
5. In the **Set as a metered connection** section, slide the control to the right to turn it on.

After you set your mobile network as a metered connection, you can disable the Download over metered connections feature to prevent extra charges.

To disable the Download over metered connections feature, do the following:

1. Swipe in from the right edge of the screen to display the charms.
2. Tap **Settings → Change PC settings**.
3. In the navigation panel, tap **PC and devices → Devices**.
4. In the **Download over metered connections** section, slide the control to the left to turn it off.

---

## Sharing your Internet connection

You can share your mobile broadband Internet connection with multiple devices.

To share your Internet connection, do the following:

1. Swipe in from the right edge of the screen to display the charms.
2. Tap **Settings → Change PC settings**.
3. In the navigation panel, tap **Network → Connections**.
4. In the **Mobile broadband** section, tap the network name. A menu is displayed.
5. In the **Share this connection** section, slide the control to the right to turn it on.

---

## Using Bluetooth devices

Bluetooth is a short-range wireless communications technology. Use Bluetooth to establish a wireless connection with another Bluetooth-enabled device over a distance of about 10 m (32.8 ft).

### Pairing with a Bluetooth device

To connect and exchange data with another Bluetooth device, pair your tablet with the Bluetooth device by doing the following:

1. Swipe in from the right edge of the screen to display the charms.

2. Tap **Settings** → **Change PC settings**.
3. In the navigation panel, tap **PC and devices** → **Bluetooth**.
4. Slide the control to the right to turn it on. The tablet will search for Bluetooth devices.
5. When the Bluetooth device you want to pair is found, tap the ID of the Bluetooth device.
6. Tap **Pair**.

### Unpairing a Bluetooth device

To unpair a Bluetooth device, do the following:

1. Swipe in from the right edge of the screen to display the charms.
2. Tap **Settings** → **Change PC settings**.
3. In the navigation panel, tap **PC and devices** → **Bluetooth**.
4. Tap the ID of the Bluetooth device you want to unpair.
5. Tap **Remove device**. A notification prompt is displayed.
6. Tap **Yes**.

---

## Using the NFC connection

Near field communication (NFC) is a high-frequency and short-range wireless communications technology. Depending on the model, your tablet might come with the NFC feature. By using the NFC feature, you can establish radio communications between your tablet and another NFC-enabled device over a distance no more than a few centimeters.

If your tablet is equipped with the NFC feature, you can find the NFC icon  on the tablet.

By default, the NFC feature is enabled. If the NFC feature of your tablet is disabled, do the following to enable the NFC feature:

1. Swipe in from the right edge of the screen to display the charms.
2. Tap **Settings** → **Change PC settings** → **Network** → **Radio devices**.
3. Slide the **NFC** control to the right to enable the NFC feature.

If you still cannot enable the NFC feature, check the **NFC** setting in the ThinkPad Tablet Setup program by doing the following:

1. Start the ThinkPad Tablet Setup program. See “ThinkPad Tablet Setup” on page 71.
2. Tap **Security** → **I/O Port Access**.
3. Set the **NFC** option to **On**.

You can use the NFC feature with NFC-supported programs, such as the Lenovo QuickControl program.

In some scenarios, you might want to use an NFC card or an NFC-enabled smartphone with your tablet to transfer data. The following sections provide instructions on how to adjust the position of an NFC card and an NFC-enabled smartphone for NFC communication.

### Positioning an NFC card

#### Attention:

- Before positioning an NFC card, touch a metal table or a grounded metal object. This action reduces any static electricity from your body. Static electricity could damage the card.



- While transferring data to or from an NFC card, do not put your tablet into sleep or hibernation mode before the data transfer finishes; otherwise, your data could become damaged.

**Notes:**

- Before positioning an NFC card, ensure that the tablet is on and the NFC feature of the tablet is enabled.
- Before positioning an NFC card, ensure that the card is in NFC Data Exchange Format (NDEF), otherwise the card will not be successfully detected by the tablet.
- Your tablet screen and NFC card might look different from the illustrations in this topic.

To position an NFC card, do the following:

1. Position your tablet as shown and ensure that the front side of the card is facing upward. Align the left-side edge of the card with the NFC logo on the tablet.



2. Move the card left and right within 5 mm (0.20 inch) as shown. Then, hold the card for about one second until you are prompted that the card has been successfully detected by the tablet. Then, you can transfer data to or from the card through NFC.



For more information about transferring data through NFC, refer to the documentation that came with the card.

**Positioning an NFC-enabled smartphone**

**Attention:** While transferring data to or from an NFC-enabled smartphone, do not put your tablet into sleep or hibernation mode before the data transfer finishes; otherwise, your data could become damaged.

**Notes:**

- Before positioning an NFC-enabled smartphone, ensure that both the tablet and the smartphone are on and the NFC feature is enabled on both the tablet and smartphone.
- The screen of your tablet and NFC-enabled smartphone might look different from the illustrations in this topic.

To position an NFC-enabled smartphone, do one of the following depending on the position of your smartphone:

- When the smartphone is in a portrait position:
  1. Position your tablet as shown and ensure that the screen of the smartphone is facing upward. Align the left-side edge of the smartphone with the NFC logo on the tablet.



2. Move the smartphone left and right within 5 mm (0.20 inch) as shown. Then, hold the smartphone for about one second until you are prompted that the smartphone has been successfully detected by the tablet. Then, you can transfer data to or from the smartphone through NFC.



For more information about transferring data through NFC, refer to the documentation that came with the smartphone.

- When the smartphone is in a landscape position:

1. Position your tablet as shown and ensure that the screen of the smartphone is facing upward. Align the left-side edge of the smartphone with the NFC logo on the tablet.



2. Move the smartphone left and right within 5 mm (0.20 inch) as shown. Then, hold the smartphone for about one second until you are prompted that the smartphone has been successfully detected by the tablet. Then, you can transfer data to or from the smartphone through NFC.



For more information about transferring data through NFC, refer to the documentation that came with the smartphone.



---

## Chapter 4. You and your tablet

This chapter provides the accessibility information about your tablet, and instructions on traveling with the tablet and maintaining the tablet.

---

### Comfort and accessibility

Read this topic to learn how to use your tablet more comfortably and how to use the accessibility features.

#### Using your tablet more comfortably

With the help of all the conveniences and powerful features of your tablet, you can carry your tablet all day long for work or entertainment at many places. Therefore it is important that you remain attentive to good posture, good lighting, and proper seating to achieve greater comfort with your tablet.

**Active sitting and rest breaks:** The longer you sit and work with your tablet the more important it is to observe your working posture. Make minor voluntary postural changes and take frequent, short breaks when you use the tablet for a long time. Your tablet is a light and mobile system; remember that it can easily be repositioned to accommodate many posture modifications you might wish to make.

**Work area setup options:** Familiarize yourself with all of your office furniture so that you know how to adjust your work surface, seat, and other work tools to accommodate your preferences for comfort. If your work area is not in an office setting, be sure to take special note of employing active sitting and utilizing work breaks. Note that there are many ThinkPad product solutions available to help you modify and expand your tablet to best suit your needs. Access the Web site <http://www.lenovo.com/essentials> to view some of these options. Explore your options for docking solutions and external products that can provide the adjustability and features that you want.

#### Accessibility information

Lenovo is committed to providing people with disabilities greater access to information and technology. Some technologies are already provided in your operating system. Others can be purchased through vendors.

Users also can use the Ease of Access Center provided in the Windows operating system to configure their tablet to suit their physical and cognitive needs. The Ease of Access Center is a central location that you can use to configure the accessibility settings and programs available in the Microsoft Windows operating system. To use the Ease of Access Center, open Control Panel and tap **Ease of Access → Ease of Access Center**.

The following information provides ways to help users who have hearing, vision, and mobility limitations get the most out of their computer experience.

##### On-screen notification

On-screen notification helps hearing-impaired people be aware of the status of their tablet. On-screen notification replaces sounds with visual cues or text captions to indicate that activity is happening on the tablet. As a result, system alerts are noticeable even when they are not heard. For example, when you select one object, the object is highlighted.

To use on-screen notification, open Control Panel, tap **Ease of Access → Ease of Access Center**, and then tap **Use text or visual alternative for sounds**.

## Audio notification

Audio notification helps visually impaired people or people with weak sight be aware of the status of their tablet.

To use audio notification, open Control Panel, tap **Ease of Access → Ease of Access Center → Use the computer without a display**, and then select **Turn on Audio Description**.

## Narrator

Narrator is a screen reader that reads texts on the screen aloud and describes events like error messages.

To open Narrator, do the following:

1. Swipe in from the right edge of the screen to display the charms and tap **Search**.
2. In the search field, enter Narrator, and then, in the list of results, tap **Narrator**.

For more information about how to use and configure Narrator, see the Windows Help and Support information system.

## Screen-reader technologies

Screen-reader technologies are primarily focused on software program interfaces, help information systems, and a variety of online documents. For additional information about screen readers, see the following:

- Using PDFs with screen readers:  
<http://www.adobe.com/accessibility.html?promoid=DJGVE>
- Using the JAWS screen reader:  
<http://www.freedomscientific.com/jaws-hq.asp>
- Using the NVDA screen reader:  
<http://www.nvaccess.org/>

## Speech Recognition

Speech Recognition enables you to control your tablet by voice.

Using only your voice, you can start programs, open menus, tap buttons and other objects on the screen, dictate text into documents, and write and send e-mails.

To open Speech Recognition, do the following:

1. Swipe in from the right edge of the screen to display the charms and tap **Search**.
2. In the search field, enter Speech Recognition, and then, in the list of results, tap **Speech Recognition**.

For more information about how to use and configure Speech Recognition, see the Windows Help and Support information system.

## Customizable text size

Depending on your preference, you can change only the text size instead of changing the size of everything on the desktop. To change the text size, open Control Panel and tap **Appearances and Personalization → Display**. Then, go to **Change only the text size** and set a text size that meets your needs.

## Magnifier

Your tablet is equipped with the Microsoft Magnifier to help visually impaired people use the computer more comfortably. Magnifier is a useful utility that enlarges part or all of your screen so that you can see the words and images better. Magnifier is part of the Ease of Access Center.

To open Magnifier, do the following:

1. Swipe in from the right edge of the screen to display the charms and tap **Search**.
2. In the search field, enter Magnifier, and then, in the list of results, tap **Magnifier**.

For more information about how to use and configure Magnifier, see the Windows Help and Support information system.

## **Zoom**

You can use the zoom feature to enlarge or reduce the size of text, pictures, maps, or other objects.

- Zoom in: Move two fingers farther apart on the touch screen to enlarge the size of text, pictures, maps, or other objects.
- Zoom out: Move two fingers closer together on the touch screen to reduce the size of text, pictures, maps, or other objects.

## **Screen resolution**

You can make your documents easier to read by adjusting the screen resolution of your tablet. To adjust the screen resolution, tap and hold anywhere on the desktop, tap **Screen resolution**, and then adjust the settings as you prefer.

**Note:** Setting too low of a resolution might prevent some items from fitting on the screen.

For alternatives on increasing the size of text and other objects, see the following:

- “Customizable text size” on page 38
- “Magnifier” on page 38
- “Zoom” on page 39

## **On-Screen Keyboard**

On-Screen Keyboard displays a visual keyboard with all the standard keys.

To open On-Screen Keyboard, do the following:

1. Swipe in from the right edge of the screen to display the charms and tap **Search**.
2. In the search field, enter On-Screen Keyboard, and then, in the list of results, tap **On-Screen Keyboard**.

For more information about how to use and configure On-Screen Keyboard, see “Using the On-Screen Keyboard or the touch keyboard and handwriting panel” on page 14 or the Windows Help and Support information system.

## **Industry-standard connectors**

Your tablet provides industry-standard connectors that enable you to connect assistive devices, if needed.

For more information on the location and function of each connector, see “Tablet layout” on page 1.

## **Documentation in accessible formats**

Lenovo provides electronic documentation in accessible formats, such as properly tagged PDF files or HyperText Markup Language (HTML) files. Lenovo electronic documentation is developed to ensure that visually impaired users can read the documentation through a screen reader. Each image in the documentation also includes adequate alternative text to explain the image so that visually impaired users can understand the image when they use a screen reader.

---

## Getting updates

Your tablet enables you to update the Windows operating system and Lenovo applications.

### Getting updates from Lenovo

Your tablet is preinstalled with System Update. This program enables you to keep the Lenovo software on your tablet up-to-date by downloading and installing software updates.

To start System Update, do the following:

1. Swipe in from the right edge of the screen to display the charms.
2. Tap the **Search** charm to search for **System Update**.
3. Tap **System Update**.
4. Follow the instructions on the screen.

### Getting updates from Microsoft

To check and keep your Windows, programs, or device drivers up-to-date, see the Windows Help and Support for more information.

---

## Traveling with your tablet

This topic provides information to help you work with and transport your tablet while you traveling.

### Travel tips

Use the following travel tips to travel more confidently and efficiently with your tablet:

- While it is safe to allow your tablet to go through the x ray machines at airport security stations, it is important to keep your eyes on the tablet at all times to prevent theft.
- Put your tablet in a protective case when not in use to prevent damage or scratching.

### Travel tips on airplanes

If you carry your tablet into an airplane, check the following travel tips:

- If you are going to use the wireless service, check with the airline for any restrictions before boarding the airplane.
- If there are restrictions on the use of tablets with the wireless feature on an airplane, enable the Airplane mode. To enable it, do the following:
  1. Swipe in from the right edge of the screen to display the charms.
  2. Tap **Settings** → **Change PC settings**.
  3. In the navigation panel, tap **Network** → **Airplane mode**.
  4. Slide the control to the right to turn on **Airplane mode** to disable all wireless devices.
- Be careful about the seat in front of you on the airplane. Place your tablet in a safe position so that it does not get caught when the person in front of you leans back.

### Travel accessories

The following is a checklist of things to consider packing when you are going to be away from your office or home:



Travel essentials:

- The ac power adapter that comes with your tablet
- The power cord that comes with your tablet
- A quality carrying case that provides adequate cushion and protection

Other items you might want to consider:

- ThinkPad headphones
- Additional storage devices or smart cards
- Tablet Digitizer Pen
- ThinkPad Tablet Dock
- ThinkPad Helix Quickshot Cover
- ThinkPad Helix Ultrabook Keyboard
- ThinkPad Helix Ultrabook Pro Keyboard

If you are traveling to another country or region, you might want to consider the following items:

- A ThinkPad ac power adapter for the country or region to which you are traveling
- A micro SIM card for the local mobile services in that country or region

---

## Care and maintenance

Handle your tablet with care so that you can enjoy this product for a long time.

### Cleaning your tablet

To clean your tablet, unplug all cables and turn off the tablet by pressing and holding the power button for a few seconds. Then wipe the tablet screen with a soft, lint-free, dry cloth to clear stains and smudges.

**Note:** Do not use screen cleaners, household cleaners, aerosol sprays, solvents, alcohol, ammonia, or abrasives to clean your tablet.

### Protecting the screen with a replaceable film

You can purchase a replaceable film to protect the screen from scratching and extend the life of your tablet. To use a replaceable film, clean the screen first and then apply the replaceable film on the screen.

### Storing the tablet for extended periods

If you are not going to use your tablet for an extended period of time, remove the micro SIM card from your tablet, and then pack your tablet with a protective case and store it in a well-ventilated and dry area without direct exposure to sunshine.



---

## Chapter 5. ThinkPad Helix options

The following optional devices are designed specially for your ThinkPad Helix tablet.

- ThinkPad Helix Ultrabook Keyboard
- ThinkPad Helix Ultrabook Pro Keyboard
- ThinkPad Tablet Dock

These options provide convenience and make your tablet easier to use for work, study, and entertainment. For tablets that do not come with these optional devices, you can purchase them from Lenovo at <http://www.lenovo.com/essentials>.

---

### ThinkPad Helix Ultrabook Keyboard

This topic provides an overview of the ThinkPad Helix Ultrabook Keyboard and instructions on how to use it.

#### Overview of ThinkPad Helix Ultrabook Keyboard

The topic introduces the ThinkPad Helix Ultrabook Keyboard hardware features to give you the basic information you need to start using it.



#### **1 2** Tablet Digitizer Pen slot cover and Tablet Digitizer Pen slot

Some models come with a Tablet Digitizer Pen slot cover **1**. To store the Tablet Digitizer Pen in the Tablet Digitizer Pen slot, remove the Tablet Digitizer Pen slot cover from the slot first.

**Note:** Ensure that you keep the Tablet Digitizer Pen slot cover. Reattach it to the Tablet Digitizer Pen slot when you are not storing the pen in the slot.

#### **3** Two-button clickpad

The two-button clickpad is a pointer-positioning device that enables you to point, select, drag, and scroll, like you do when using a mouse. You also can use it to perform some basic touch gestures.

For more information, see “Using the two-button clickpad” on page 46.

#### 4 Special keys

The special keys enable you to control many features of your tablet by pressing a single key. For more information, see “Using the special keys” on page 45.



#### 5 USB 2.0 connector

The USB 2.0 connector is used for connecting USB-compatible devices, such as a USB printer, USB mouse, USB keyboard, USB memory key, or a digital camera.

**Attention:** When you attach a USB cable to this USB connector, ensure that the USB mark is facing upward. Otherwise the connector might be damaged.

## Using the ThinkPad Helix Ultrabook Keyboard

To use the ThinkPad Helix Ultrabook Keyboard, install your tablet into the keyboard first, as shown in the following illustration. Ensure that the tablet is secured in place.



**Note:** Do not detach the tablet from the ThinkPad Helix Ultrabook Keyboard while using the keyboard, otherwise the ThinkPad Helix Ultrabook Keyboard will be disabled.

## Storing and removing the Tablet Digitizer Pen

Some models are equipped with a Tablet Digitizer Pen as a standard feature. You can store the pen in the slot on the right side of the ThinkPad Helix Ultrabook Keyboard. Remove the Tablet Digitizer Pen slot cover first **1**, then push the pen gently into the slot until you hear a click **2**.

**Note:** The Tablet Digitizer Pen slot cover is available on some models.



To remove the pen from the slot, press the pen gently into the slot **1** to release it; then pull the pen out **2**.



**Note:** The pen contains pressure sensors. Do not push the tip of the pen for an extended period of time. Do not subject the pen to shock or vibration.



For more information about using the pen, see “Using the Tablet Digitizer Pen” on page 14.

## Using the special keys



The ThinkPad Helix Ultrabook Keyboard has several special keys. Press a special key to quickly control the associated function.

### Volume and mute control







-  Mute the speakers.

-  Turn down the speaker volume.
-  Turn up the speaker volume.
-  Mute the microphone.

### Screen control

-  Turn down the brightness.
-  Turn up the brightness.

### Application control

-  Open the **Settings** charm.
-  Open the **Search** charm.
-  View all applications that you have opened.
-  View all applications.
-  Navigate to the top when you are viewing information, such as a document or a Web page.
-  Navigate to the bottom when you are viewing information, such as a document or a Web page.

### Fn key control

 + : Press Fn+Esc to enable or disable the Fn Lock function.

- **When the Fn Lock function is disabled:** The Fn Lock indicator is off. To initiate the special function of each key, press the function key directly. To input F1–F12, press the Fn key and the corresponding function key.
- **When the Fn Lock function is enabled:** The Fn Lock indicator turns on. To input F1–F12, press the corresponding function key directly. To initiate the special function of each key, press the Fn key and the corresponding function key.

### Function key combinations

- **Fn+4:** Puts the computer into sleep mode. To return to normal operation, press the Fn key or power button.
- **Fn+End:** Has the same function as the Insert key on a conventional keyboard.
- **Fn+B:** Has the same function as the Break key on a conventional keyboard.
- **Fn+K:** Has the same function as the ScrLK key on the conventional keyboard.
- **Fn+P:** Has the same function as the Pause key on the conventional keyboard.
- **Fn+S:** Has the same function as the SysRq key on the conventional keyboard.

### Using the two-button clickpad

You can enable or disable the two-button clickpad by pressing Fn+8.

The right-click area **a** on the two-button clickpad works as the right-click button on a conventional mouse. The rest area on the two-button clickpad works as the left-click button on a conventional mouse.

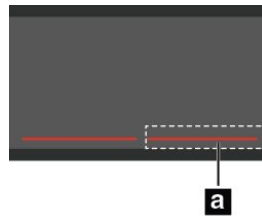

You also can use the two-button clickpad to perform the following touch gestures.

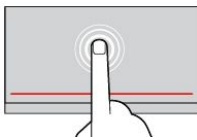

**Tap**

Tap anywhere on the clickpad with one finger to select or open an item.

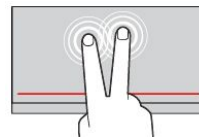

**Two-finger tap**

Tap anywhere on the clickpad with two fingers to display a shortcut menu.

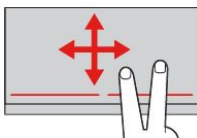

**Two-finger scroll**

Put two fingers on the clickpad and move them in the vertical or horizontal direction. This action enables you to scroll through the document, Web site, or apps.

**Carrying or storing the tablet together with the ThinkPad Helix Ultrabook Keyboard**

Sometimes you do not need to use the keys on the ThinkPad Helix Ultrabook Keyboard, but you would like to carry or store the tablet together with the keyboard. In this situation, you might consider the following methods depending on the model of your tablet.

- For models that are not equipped with a smart card slot, you can install the tablet into the ThinkPad Helix Ultrabook Keyboard with the tablet screen facing upward. To achieve this, do the following:
  1. Position the tablet with the tablet screen facing upward.
  2. Gently slide your tablet as shown. The tablet is attached to the ThinkPad Helix Ultrabook Keyboard. The ThinkPad Helix Ultrabook Keyboard is disabled in this situation.

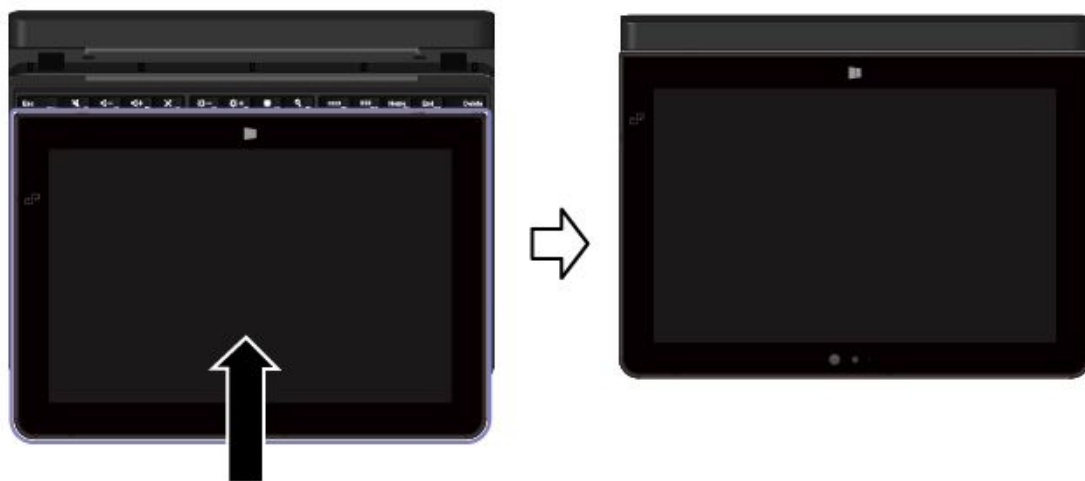

- For all models, you can install the tablet into the ThinkPad Helix Ultrabook Keyboard with the tablet screen facing downward. To achieve this, do the following:

**Note:** Your tablet might look slightly different from the following illustrations.

1. Position the tablet with the tablet screen facing downward.
2. Gently slide your tablet as shown. The tablet is attached to the ThinkPad Helix Ultrabook Keyboard. The ThinkPad Helix Ultrabook Keyboard is disabled in this situation.

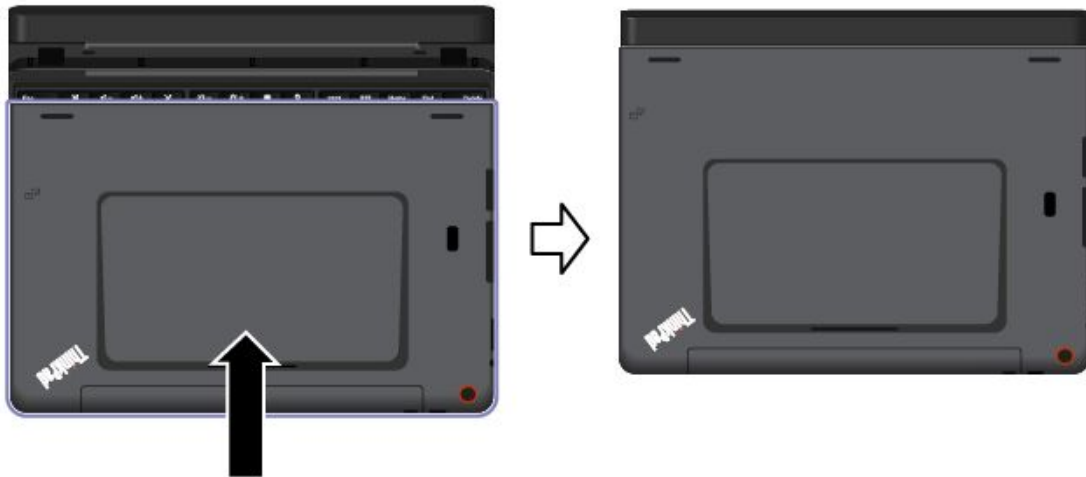

For more information, refer to the documentation that came with the ThinkPad Helix Ultrabook Keyboard.

---

## ThinkPad Helix Ultrabook Pro Keyboard

This topic provides an overview of the ThinkPad Helix Ultrabook Pro Keyboard and instructions on how to use it.

### Overview of ThinkPad Helix Ultrabook Pro Keyboard

The topic introduces the ThinkPad Helix Ultrabook Pro Keyboard hardware features to give you the basic information you need to start using the it.



#### **1** TrackPoint buttons

The TrackPoint buttons contain the following parts:



- Left-click button: Press the left-click zone to select or open an item.
- Scroll bar: Press and hold the dotted scrolling bar while applying pressure to the pointing stick in the vertical or horizontal direction. Then you can scroll through the document, Web site, or apps.
- Right-click button: Press the right-click zone to display a shortcut menu.

## **2 Touch pad**

The touch pad is a pointer-positioning device that enables you to point, select, drag, and scroll, like you do when using a mouse. You also can use it to perform some touch gestures.

For more information, see “Using the touch pad” on page 56.

## **3 Special keys**

The special keys enable you to control many features of your tablet by pressing a single key. For more information, see “Using the special keys” on page 55.

## **4 TrackPoint pointing stick**

To use the TrackPoint pointing stick, apply pressure to the nonslip cap on the pointing stick in any direction parallel to the keyboard. Then you can move the pointer. But the pointing stick itself does not move. The speed at which the pointer moves depends on the pressure you apply to the pointing stick. The cap on the end of the pointing stick is removable. For more information, see “Replacing the cap of the pointing stick” on page 57.

## **5 Dock connector**

Use this connector to connect the tablet to the ThinkPad Helix Ultrabook Pro Keyboard.



## **6 Security-lock slot**

To protect your ThinkPad Helix Ultrabook Pro Keyboard from theft, you can purchase a security cable lock that fits the security-lock slot to lock the keyboard to a stationary object. See “Attaching a mechanical lock” on page 53.

## **7 Mini DisplayPort connector**

Use the mini DisplayPort connector to connect your computer to a compatible projector, external monitor, or high-definition television. The mini DisplayPort connector of your computer supports audio as well as video streaming. This compact connector enables a plug-and-play setup and supports adapters that can plug into DVI, VGA, or HDMI connectors.

## 8 Always On USB 3.0 connector

By default, the Always On USB connector enables you to charge some mobile digital devices and smartphones in the following situations:

- When your tablet is on or in sleep mode
- When your tablet is in hibernation mode or is turned off, but connected to ac power

If you want to charge these devices when the tablet is in hibernation mode or is turned off, and the tablet is not connected to ac power, tap Windows Start screen control to go to the Start screen. Click **Lenovo Settings** → **Power**. Then move the switch to the **On** position in the **Enable Always On USB** area and select the **Enable even when the computer is off** check box, and click **OK** or **Apply**.

## 9 Power connector

Use this connector with the supplied power cord and the ac power adapter to charge the ThinkPad Helix Ultrabook Pro Keyboard and the tablet when the battery power is low.

For more information, see “Charging the battery” on page 12.

## 10 Ejection button

Press the ejection button to release your tablet from the ThinkPad Helix Ultrabook Pro Keyboard.

## 11 Pen holder (on some models)

Some models are equipped with a Tablet Digitizer Pen. You can store the pen in the pen holder. See “Storing and removing the Tablet Digitizer Pen” on page 53.

# Using the ThinkPad Helix Ultrabook Pro Keyboard

This topic provides instructions on how to use the ThinkPad Helix Ultrabook Pro Keyboard.

## Installing or removing the tablet

To use the ThinkPad Helix Ultrabook Pro Keyboard, install your tablet into the keyboard first. To install the tablet for the first time, do the following:

1. Align the hook hole on the bottom of the tablet with the keyboard hook, then, gently slide your tablet as shown. The tablet is attached to the ThinkPad Helix Ultrabook Pro Keyboard.



2. Pivot up the tablet.



To remove the tablet from the keyboard, do the following:

1. Press the eject button on the right side of the keyboard.



2. Remove the tablet from the keyboard.



**Note:** Do not remove the tablet from the ThinkPad Helix Ultrabook Pro Keyboard while using the keyboard, otherwise the ThinkPad Helix Ultrabook Pro Keyboard will be disabled.

The next time you want to reinstall the tablet, align the hook hole on the bottom of the tablet with the keyboard hook, Then, insert the tablet into the keyboard as shown.



**Note:** Do not touch the keyboard connector on the ThinkPad Ultrabook Pro Keyboard.

### Attaching a mechanical lock

You can attach a security cable lock to the ThinkPad Helix Ultrabook Pro Keyboard to prevent the keyboard from theft.

**Note:** You are responsible for evaluating, selecting, and implementing the locking device and security feature. Lenovo makes no comments, judgments, or warranties about the function, quality, or performance of the locking device and security feature.

To attach a security cable lock to the keyboard, do the following:

1. Secure the chain on the lock to a stationary object. Refer to the instructions shipped with the mechanical lock.
2. Insert the security cable lock into the security-lock slot. Then turn around the lock key to the locked position.

### Storing and removing the Tablet Digitizer Pen

Some models are equipped with a Tablet Digitizer Pen as a standard feature. You can store the pen in the pen holder on the right side of the ThinkPad Helix Ultrabook Pro Keyboard.

To store the pen, do the following:

1. Take out the dummy rubber from the pen-holder slot.



2. Insert the pen holder into the pen-holder slot.



3. Insert the pen into the pen holder in the direction as shown by the arrow.



To remove the pen from the slot, do the following:

1. Pull the pen out of the pen holder in the direction as shown by the arrow.



2. Take the pen holder out from the pen-holder slot, if necessary. Then, insert the dummy rubber back into the pen-holder slot.





**Note:** The pen contains pressure sensors. Do not push the tip of the pen for an extended period of time. Do not subject the pen to shock or vibration.



For more information about using the pen, see “Using the Tablet Digitizer Pen” on page 14.

### Using the special keys



The ThinkPad Helix Ultrabook Keyboard has several special keys. Press a special key to quickly control the associated function.

#### Volume and mute control







-  F1 Mute the speakers.
-  F2 Turn down the speaker volume.

-  Turn up the speaker volume.
-  Mute the microphone.

### Screen control

-  Turn down the brightness.
-  Turn up the brightness.

### Application control

-  Open the **Settings** charm.
-  Open the **Search** charm.
-  View all applications that you have opened.
-  View all applications.
-  Navigate to the top when you are viewing information, such as a document or a Web page.
-  Navigate to the bottom when you are viewing information, such as a document or a Web page.

### Fn key control

 + : Press Fn+Esc to enable or disable the Fn Lock function.

- **When the Fn Lock function is disabled:** The Fn Lock indicator is off. To initiate the special function of each key, press the function key directly. To input F1–F12, press the Fn key and the corresponding function key.
- **When the Fn Lock function is enabled:** The Fn Lock indicator turns on. To input F1–F12, press the corresponding function key directly. To initiate the special function of each key, press the Fn key and the corresponding function key.

### Function key combinations

- **Fn+Spacebar:** Controls the keyboard backlight.  
There are three modes for the keyboard backlight: **Off**, **Low**, and **High**. Press Fn+Spacebar to change the modes of the keyboard backlight.
- **Fn+4:** Puts the computer into sleep mode. To return to normal operation, press the Fn key or power button.
- **Fn+End:** Has the same function as the Insert key on a conventional keyboard.
- **Fn+B:** Has the same function as the Break key on a conventional keyboard.
- **Fn+K:** Has the same function as the ScrLK key on the conventional keyboard.
- **Fn+P:** Has the same function as the Pause key on the conventional keyboard.
- **Fn+S:** Has the same function as the SysRq key on the conventional keyboard.

### Using the touch pad

You can use the touch pad to perform a variety of touch gestures. The following table introduces some frequently used touch gestures.



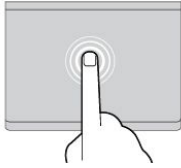

**Tap**  
Tap anywhere on the touch pad with one finger to select or open an item.

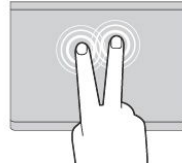

**Two-finger tap**  
Tap anywhere on the touch pad with two fingers to display a shortcut menu.

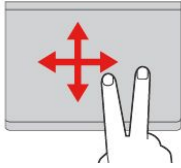

**Two-finger scroll**  
Put two fingers on the touch pad and move them in the vertical or horizontal direction. This action enables you to scroll through the document, Web site, or apps.

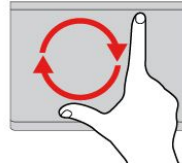

**Two-finger rotate**  
Put two fingers on the touch pad and rotate them clockwise or counterclockwise to rotate an item.

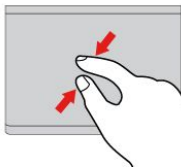

**Two-finger zoom out**  
Put two fingers on the touch pad and move them closer together to zoom out.

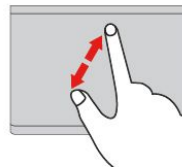

**Two-finger zoom in**  
Put two fingers on the touch pad and move them farther apart to zoom in.

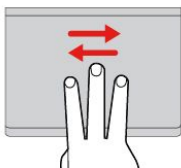

**Three-finger swipe**  
Put three fingers on the touch pad and move them left to show the next item. Move them right to show the previous item.

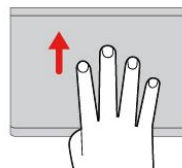

**Four-finger swipe**  
Put four fingers on the touch pad and move them upward to view and choose from opened apps.

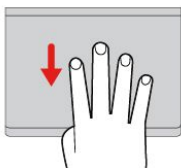

**Four-finger swipe**  
Put four fingers on the touch pad and move them downward to show the desktop.

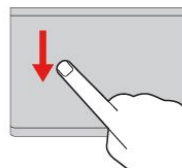

**Swipe from the top edge**  
From the Start screen or the current app, swipe in from the top edge of the touch pad with one finger to display the command menu.

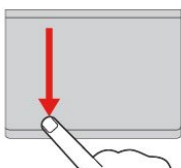

**Swipe from the top to the bottom edge**  
Swipe from the top to the bottom edge of the touch pad with one finger to close the current app. Performing this gesture on the desktop closes the desktop and displays the Start screen.

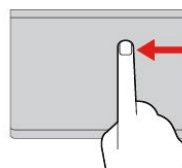

**Swipe from the right edge**  
Swipe in from the right edge of the touch pad with one finger to display the charms.

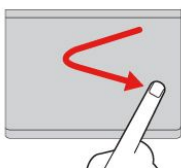

**Swipe in and out**  
Swipe in and out from the right edge of the touch pad with one finger to hide the charms.

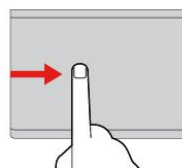

**Swipe from the left edge**  
Swipe in from the left edge of the touch pad with one finger to show the previously used app.

## Replacing the cap of the pointing stick

The cap **1** on the end of the pointing stick is removable. After you use the cap for a period of time, you might consider replacing the cap with a new one.

**Note:** Ensure that you use a cap with grooves **a** as shown in the following illustration.

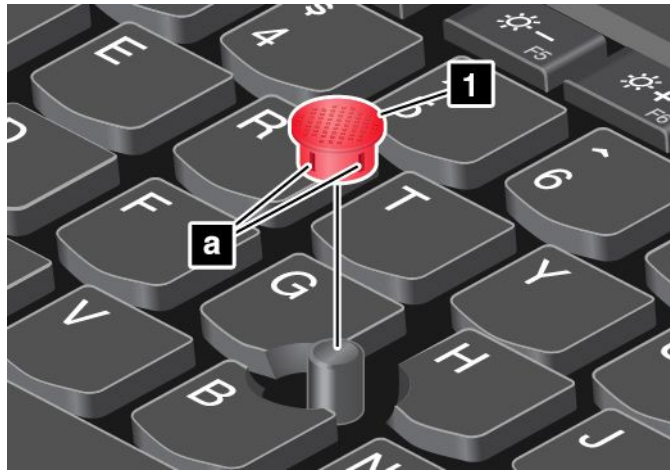

### Carrying or storing the tablet together with the ThinkPad Helix Ultrabook Pro Keyboard

Sometimes you do not need to use the keys on the ThinkPad Helix Ultrabook Pro Keyboard, but you would like to carry or store the tablet together with the keyboard. In this situation, you might consider the following methods depending on the model of your tablet.

- For models that are not equipped with a smart card slot, you can install the tablet into the ThinkPad Helix Ultrabook Pro Keyboard with the tablet screen facing upward. To achieve this, do the following:
  1. Position the tablet with the tablet screen facing upward.
  2. Align the hook hole on the bottom of the tablet with the keyboard hook, then, gently slide your tablet as shown. The tablet is attached to the ThinkPad Helix Ultrabook Pro Keyboard. The keyboard is disabled in this situation.

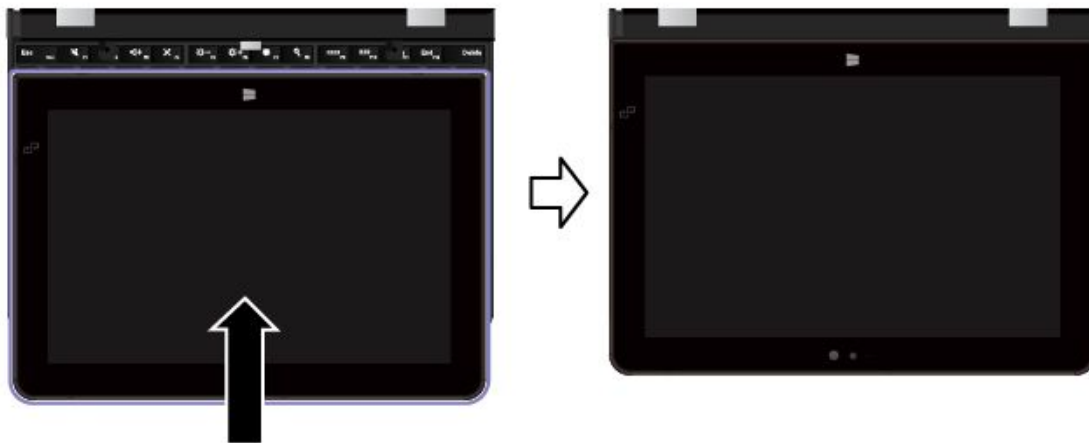

- For all models, you can install the tablet into the ThinkPad Helix Ultrabook Pro Keyboard with the tablet screen facing downward. To achieve this, do the following:

**Note:** Your tablet might look slightly different from the following illustrations.

1. Position the tablet with the tablet screen facing downward.
2. Align the hook hole on the bottom of the tablet with the keyboard hook, then, gently slide your tablet as shown. The tablet is attached to the ThinkPad Helix Ultrabook Pro Keyboard. The keyboard is disabled in this situation.



For more information, refer to the documentation that came with the ThinkPad Helix Ultrabook Pro Keyboard.

---

## ThinkPad Tablet Dock

The ThinkPad Tablet Dock (hereafter called the dock) holds your tablet in an upright position and frees your hands to do other tasks. The dock also provides you with easy access to connectors for USB devices, file transfers, charging, audio input, audio output, and video output.

This topic provides an overview of ThinkPad Tablet Dock and instructions on how to use it.

### Overview of ThinkPad Tablet Dock

The topic introduces the ThinkPad Tablet Dock hardware features to give you the basic information you need to start using the it.

#### Front view and left-side view of the dock



#### **1** Dock connector

Used to establish the connection between the dock and tablet when your tablet is seated in the dock.

## **2 Always-on USB connector (USB 3.0 connector)**

Used to charge some mobile digital devices and smartphones by default, no matter when your tablet is off, in sleep mode, or in hibernation mode. For more information, refer to the documentation that came with the dock.

**Note:** This connector is compatible with the USB 2.0 standard.

## **3 Combo audio connector**

Used to connect headphones or a headset to listen to stereo sound from the tablet. You also can connect a headset to record audio or make calls.

## **Rear view of the dock**

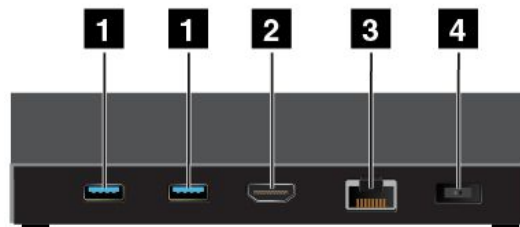

## **1 USB 3.0 connectors**

Used to connect devices that are compatible with USB 3.0 and USB 2.0.

## **2 HDMI connector**

Used to connect a compatible digital audio device or video display.

## **3 Ethernet connector**

Used to connect the dock to an Ethernet LAN.

## **4 Power connector**

Used to connect the ac power adapter shipped with the dock to provide power to the tablet and charge the battery.

## Using the ThinkPad Tablet Dock

Before using the dock, ensure that you connect the tablet to the dock and then connect the dock to an electrical outlet by doing the following:

1. Position your tablet with the dock connector side facing downward.
2. Align the dock connector on the tablet with the one on the dock.
3. Gently slide your tablet into the dock until it is seated in place.



4. Use the ac power adapter and power cord shipped with the dock to connect the dock to an electrical outlet.

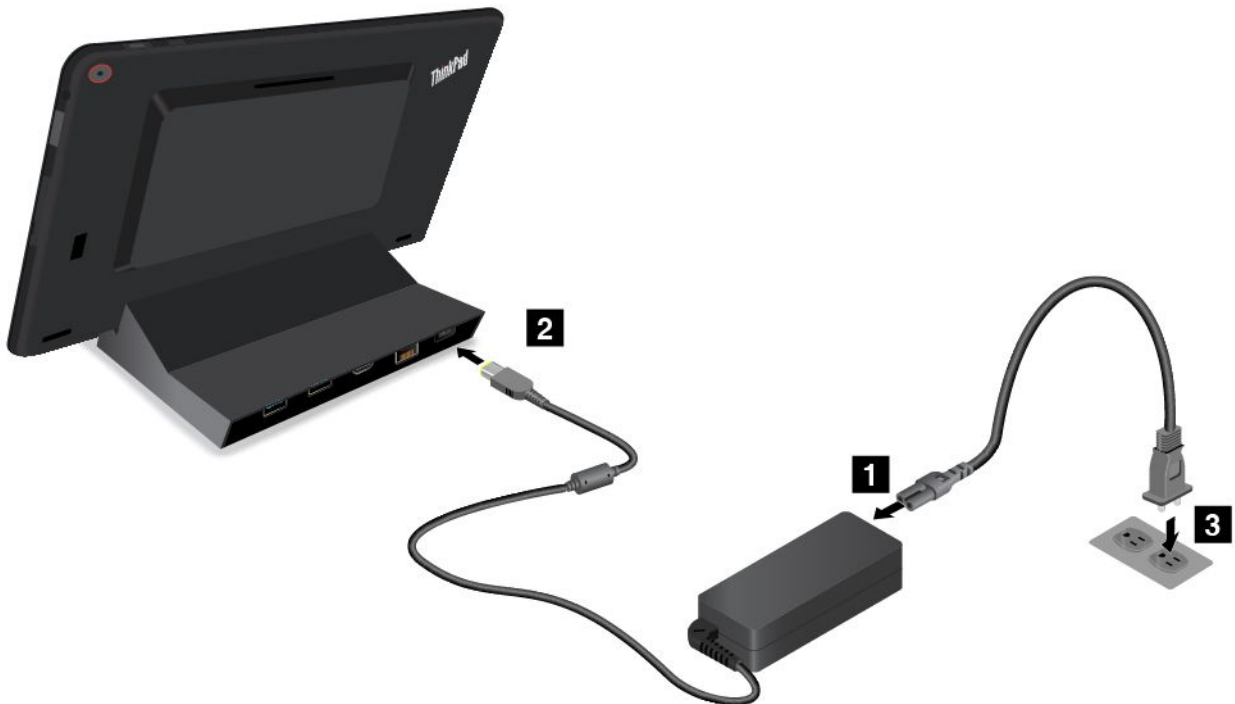

After the tablet is connected to the dock, you can:

- Use your tablet in an upright position without having to hold the tablet.
- Use the dock to hold your tablet upright when using an external USB keyboard.
- Connect the dock to your personal USB storage device with the supplied USB cable to transfer files.
- Connect the dock to a stereo system or speakers using a stereo audio cable to play music.
- Connect the dock to an electrical outlet using the ac power adapter shipped with the dock to charge the tablet battery.

---

## Chapter 6. Security

This chapter provides information about how to protect the information stored on your tablet.

---

### Using passwords

You can help prevent your tablet from unauthorized use by using passwords. Once you set a password, a prompt is displayed on the screen each time you turn on the tablet. Enter your password at the prompt. You cannot use the tablet unless you type the correct password.

If you have set a power-on password, a supervisor password, or a hard disk password, it unlocks automatically when the tablet resumes from sleep mode.

**Note:** If a Windows password has been set, you will be prompted to enter it.

#### Typing passwords



When this icon is displayed, type a power-on password or a supervisor password.



When this icon is displayed, type a user hard disk password. To type a master hard disk password, press F1. When the icon changes to , type the master hard disk password



**Note:** To return to the icon , press F1 again.

### Passwords and sleep mode

If you have set a Windows password and you put your tablet into sleep mode, you will be prompted to enter the password when resuming operation.

If you use your email address as a user account to sign in to Windows, enter your email password when resuming operation.

### Power-on password

You can set a power-on password to help protect your tablet against access by unauthorized users.

If you set a power-on password, the password prompt is displayed on the screen whenever you turn on the tablet. You must enter the correct password to start using the tablet.

#### Setting, changing, or removing a power-on password

To set, change, or remove a power-on password, do the following:

1. Print these instructions.
2. Save all open files, and exit all applications.
3. Restart the tablet by pressing the power button and the volume-up button at the same time. The ThinkPad Tablet Setup program menu opens.
4. Tap **Security** → **Password** → **Power-on Password**.
5. Depending on your need, do one of the following:

- To set a password, do the following:
  - a. Tap **Enter**. A window opens. In the **Enter New Password** field, enter a desired password.
  - b. In the **Confirm New Password** field, reenter the password and tap **OK**.
  - c. In the **Changes have been saved** window, tap **OK**.
- To change a password, do the following:
  - a. Tap **Enter**. A window opens. In the **Enter Current Password** field, enter the current power-on password.
  - b. In the **Enter New Password** field, enter a new power-on password.
  - c. In the **Confirm New Password** field, reenter the new power-on password and tap **OK**.
  - d. In the **Changes have been saved** window, tap **OK**.
- To remove a password, do the following:
  - a. Tap **Enter**. A window opens. In the **Enter Current Password** field, enter the current power-on password.
  - b. Leave the **Enter New Password** and **Confirm New Password** fields blank. Tap **OK**.
  - c. In the **Changes have been saved** window, tap **OK**.

**Attention:** It is recommended that you record your password and store it in a safe place. If you forget your supervisor password, Lenovo cannot reset your password. You must take your tablet to a Lenovo reseller or a Lenovo marketing representative to have the system board replaced. Proof of purchase is required, and a fee will be charged for parts and service.

6. Save configuration changes and exit.

## Supervisor password

If you have set a supervisor password in the ThinkPad Tablet Setup program, you will be prompted to enter a supervisor password when you start the ThinkPad Tablet Setup program.

The supervisor password protects the system information stored in ThinkPad Tablet Setup. Without it, no one can change the configuration of the tablet.

**Note:** The system administrator can set the same supervisor password on many tablets to make administration easier.

### Setting, changing, or removing a supervisor password

Only a system administrator can set, change, or remove a supervisor password.

To set, change, or remove a supervisor password, do the following:

1. Print these instructions.
2. Save all open files, and exit all applications.
3. Restart the tablet by pressing the power button and the volume-up button at the same time. The ThinkPad Tablet Setup program menu opens.
4. Tap **Security** → **Password** → **Supervisor Password**.
5. Depending on your needs, do one of the following:
  - To set a password, do the following:
    - a. Tap **Enter**. A window opens. In the **Enter New Password** field, enter a desired password.
    - b. In the **Confirm New Password** field, reenter the password and tap **OK**.
    - c. In the **Changes have been saved** window, tap **OK**.



- To change a password, do the following:
  - a. Tap **Enter**. A window opens. In the **Enter Current Password** field, enter the current supervisor password.
  - b. In the **Enter New Password** field, enter a new supervisor password.
  - c. In the **Confirm New Password** field, reenter the new supervisor password and tap **OK**.
  - d. In the **Changes have been saved** window, tap **OK**.
- To remove a password, do the following:
  - a. Tap **Enter**. A window opens. In the **Enter Current Password** field, enter the current supervisor password.
  - b. Leave the **Enter New Password** and **Confirm New Password** fields blank. Tap **OK**.
  - c. In the **Changes have been saved** window, tap **OK**.

**Attention:** It is recommended that you record your password and store it in a safe place. If you forget your supervisor password, Lenovo cannot reset your password. You must take your tablet to a Lenovo reseller or a Lenovo marketing representative to have the system board replaced. Proof of purchase is required, and a fee will be charged for parts and service.

6. Save configuration changes and exit.

The next time you open the ThinkPad Tablet Setup program, you will be prompted to enter your password to proceed.

## Hard disk passwords

The following two types of hard disk passwords can help protect the information stored on the hard disk drive:

- **User hard disk password**

If a user hard disk password has been set, but no master hard disk password has been, the user must enter the user hard disk password to access files and applications on the hard disk drive.

- **Master hard disk password**

The master hard disk password also requires a user hard disk password. The master hard disk password is usually set and used by a system administrator. It enables the administrator to access any hard disk drive in a system like a master key. The administrator sets the master password; then assigns a user password for each tablet in the network. The user can then change the user password as desired, but the administrator still can get access by using the master password.

When a master hard disk password is set, only the administrator can remove the user hard disk password.

### Setting a hard disk password

To set a hard disk password, do the following:

1. Print these instructions.
2. Save all open files, and exit all applications.
3. Restart the tablet by pressing the power button and the volume-up button at the same time. The ThinkPad Tablet Setup program menu opens.
4. Tap **Security** → **Password** → **Hard disk Password**.
5. A password window is displayed. You are prompted to select **User** or **User + Master**. Select **User** if you want to set only one hard disk password. Select **User + Master** if you want to set a user hard disk password and a master hard disk password, for example if you are an administrator or a supervisor.
  - If you select **User**, do the following:
    - a. Tap **Enter**. A window opens. In the **Enter New Password** field, enter a desired password.

- b. In the **Confirm New Password** field, reenter the password and tap **OK**.
  - c. In the **Changes have been saved** window, tap **OK**.
  - If you select **User + Master**, do the following:
    - a. First, set a user hard disk password. When a message window prompts you to set the user hard disk password, press Enter to continue. Type your new user hard disk password in the **Enter New Password** field and press Enter. Retype the password in the **Confirm New Password** field and press Enter.
    - b. Then, set a master hard disk password. When a message window prompts you to set the master hard disk password. Press Enter to continue. Type your new master hard disk password in the **Enter New Password** field and press Enter. Retype the password in the **Confirm New Password** field and press Enter.
6. Save configuration changes and exit.

The next time you turn on your tablet, type the user or master hard disk password to start your tablet and access the operating system.

### Changing or removing a hard disk password

To change or remove the hard disk password, do the following:

- If you are in **User + Master** hard disk mode, you can select either **User HDP** or **Master HDP** to change the password, depending on your needs.
  - If you select **User HDP** mode, follow the following steps to change the user hard disk password:
    1. Type the current user hard disk password in the **Enter Current Password** field and press Enter.
    2. Type the new password in the **Enter New Password** field and press Enter; then retype the password in the **Confirm New Password** field and press Enter.
    3. A Setup Notice window is displayed. Press Enter again to continue. The user hard disk password is changed.

**Note:** The hard disk password cannot be removed in **User HDP** mode.

- If you select **Master HDP** mode, follow the following steps to change the master hard disk password:
  1. Type the current master hard disk password in the **Enter Current Password** field and press Enter.
  2. Type the new master hard disk password in the **Enter New Password** field and press Enter; then retype the new password you just entered in the **Confirm New Password** field and press Enter.
  3. A Setup Notice window is displayed. Press Enter to continue. The master hard disk password is changed.

**Note:** If you leave the **Enter New Password** and **Confirm New Password** fields blank and press Enter twice, both the user and master hard disk passwords are removed.

- If you are in **User** hard disk mode, follow the following steps to change the user hard disk password:
  1. Follow steps 1 through 7 in “Setting a hard disk password” on page 65, typing your password to start the ThinkPad Tablet Setup program.
  2. Type the current user hard disk password in the **Enter Current Password** field and press Enter.
  3. Type the new password in the **Enter New Password** field and press Enter; then retype the new password in the **Confirm New Password** field and press Enter.
  4. A Setup Notice window is displayed. Press Enter again to continue. The user hard disk password is changed.

**Note:** If you leave the **Enter New Password** and **Confirm New Password** fields blank and press Enter twice, the user hard disk password is removed.

## Tips on using the hard disk passwords

- You can set the minimum length of a hard disk password through the **Security** menu.
- If you set a hard disk password of over seven characters, the hard disk drive can be used only with a tablet that can recognize a hard disk password of over seven characters. If you then install the hard disk drive in a tablet that cannot recognize a hard disk password that contains more than seven characters, you cannot access the drive.
- Record your password and store it in a safe place. If you forget the user hard disk password, or both user and master hard disk passwords, Lenovo cannot reset your passwords or recover data from the hard disk drive. You must take your tablet to a Lenovo reseller or a marketing representative to have the hard disk drive replaced. Proof of purchase is required, and a fee will be charged for parts and service.

**Notes:** The eDrive storage drives or Trusted Computing Group (TCG) Opal-compliant storage drives provide self-encryption capabilities to secure your data.

- If a TCG Opal-compliant storage drive and a TCG Opal management software program are installed, and the TCG Opal management software program is activated, the hard disk password is not available.
- If an eDrive storage drive is installed in your tablet, and your tablet is preinstalled with the Windows 8.1 operating system, the hard disk password is not available.

## Hard disk security

To protect passwords from unauthorized security attacks, refer to the following tips to maximize security:

- Set a power-on password as well as a hard disk password for your internal solid-state drive. Refer to the procedures in “Power-on password” on page 63 and “Hard disk passwords” on page 65. For security, a longer password is recommended.
- To provide reliable security for the UEFI BIOS, use the security chip and a security application with a Trusted Platform Module management feature. Refer to “Using the security chip” on page 68.
- If an Encryption solid-state drive is installed in your tablet, be sure to protect the contents of your tablet memory from unauthorized access by use of drive encryption software, such as Microsoft Windows BitLocker® Drive Encryption, which is supported in the Professional and Enterprise editions of the Windows 8.1 operating system. Refer to “Using Windows BitLocker Drive Encryption” on page 67.
- Before you dispose of, sell, or hand over your tablet, delete the data stored on it.

## Using Windows BitLocker Drive Encryption

To help protect your tablet against unauthorized access, use the drive encryption software, such as Windows BitLocker Drive Encryption.

Windows BitLocker Drive Encryption is an integral security feature of Windows 8.1 operating system. It is supported in the Professional and Enterprise editions of the Windows 8.1 operating system. It can help you protect the operating system and data stored on your tablet, even if your tablet is lost or stolen. BitLocker works by encrypting all user and system files, including the swap and hibernation files.

BitLocker uses a Trusted Platform Module to provide enhanced protection for your data and to ensure early boot component integrity. A compatible TPM is defined as a V1.2 TPM.

To check the BitLocker status, go to Control Panel, and click **System and Security → BitLocker Drive Encryption**.

For more information about Windows BitLocker Drive Encryption, see the help information system of the Windows operating system, or search for “Microsoft Windows BitLocker Drive Encryption Step-by-Step Guide” on the Microsoft Web site.

## Encryption solid-state drive

Some models contain the Encryption solid-state drive. This feature helps to protect your tablet against security attacks on media, NAND flash, or device controllers by use of a hardware encryption chip. For the efficient use of the encryption feature, set a hard disk password for the internal storage device.

---

## Using the security chip

Strict security requirements are imposed on network client computers that transfer confidential information electronically. You can set the security chip in your tablet to enhance computing security. Some models are equipped with one security chip called the firmware TPM (displayed as “Trusted Platform Module 2.0” in Device Manager). Some models are equipped with two security chips called the discrete TPM (displayed as “Trusted Platform Module 1.2” in Device Manager) and the firmware TPM. For models with two security chips, you can select which one you want to use in the ThinkPad Tablet Setup program by using the instructions in this topic.

**Note:** Ensure that the supervisor password has been set in the ThinkPad Tablet Setup program; otherwise anyone can change the settings for the security chip.

### About the Security Chip menu

The **Security Chip** menu provides the following items for you to configure the embedded security chip. You can find the **Security Chip** menu from the **Security** menu of the ThinkPad Tablet Setup program.

- **Security Chip Selection:** Select the security chip you want to use. This item is displayed only on some tablet models.
- **Security Chip:** Enable or disable the security chip.
- **Clear Security Chip:** Clear the encryption key. This option is not displayed when the security chip is inactive or disabled. To clear the security chip, ensure that you activate or enable the security chip first so that this option can be displayed.

### Setting the security chip

To set the security chip through the **Security Chip** menu, do the following:

1. Print these instructions.
2. Save all open files and exit all applications. Then, turn off your tablet.
3. Press the power button and the volume-up button at the same time when you turn on the tablet. The ThinkPad Tablet Setup program menu opens.
4. Tap **Security**.
5. Tap **Security Chip**.
6. Set the items.
7. Save configuration changes and exit.

---

## Using firewalls

Your tablet is preinstalled with a firewall program as part of antivirus package. This program protects against Internet security threats, unauthorized access, intrusions, and Internet attacks. It also protects your privacy.

For more information about how to use the firewall program, refer to the online help that comes with the program.

---

## Protecting data against viruses

Your tablet is preinstalled with an antivirus program so you can detect and eliminate viruses. The antivirus program is designed to help you detect and eliminate viruses.

Lenovo provides a full version of antivirus software on your tablet with a free 30-day subscription. After 30 days, you must renew the license to continue receiving the antivirus software updates.

For more information about how to use your antivirus software, refer to the help system of your antivirus software.



---

## Chapter 7. Advanced configuration

If you need to update your system UEFI BIOS, install new device drivers, this information will help you handle your tablet with proper care and keep it in top working shape.

- “Installing device drivers” on page 71
- “ThinkPad Tablet Setup” on page 71
- “Using system management” on page 84

---

### Installing device drivers

The device drivers are available at <http://www.lenovo.com/ThinkPadDrivers>. Choose your tablet product name to view all the device drivers for your tablet.

**Attention:** Always go to <http://www.lenovo.com/ThinkPadDrivers> for the latest device drivers. Do not download them from the Windows Update Web site.

---

### ThinkPad Tablet Setup

Your tablet comes with the ThinkPad Tablet Setup program that enables you to view and configure various setup parameters.

To start the ThinkPad Tablet Setup program, do one of the following:

**Note:** If you are required to enter the supervisor password, enter the correct password. You also can skip the password prompt and start the ThinkPad Tablet Setup program. If you do not enter the password, you cannot change the configurations that are protected by the supervisor password. For more information, refer to “Using passwords” on page 63.

- If your tablet is attached to a supported keyboard, restart the tablet. When the ThinkPad logo is displayed, press F1. The ThinkPad Tablet Setup program main menu opens.
- Press the power button and the volume-up button at the same time when you turn on the tablet. The ThinkPad Tablet Setup program main menu opens.
- To start the ThinkPad Tablet Setup program from the operating system, do the following:
  1. Swipe in from the right edge of the screen to display the charms.
  2. Tap **Settings** → **Change PC settings**.
  3. In the navigation panel, tap **Update and recovery** → **Recovery**.
  4. In the **Advanced startup** section, tap **Restart now**.
  5. The tablet restarts and a menu is displayed. Tap **Troubleshoot** → **Advanced options** → **UEFI Firmware Settings** → **Restart**.
  6. The tablet restarts and enters the ThinkPad Tablet Setup program.

**Note:** If you have set a supervisor password, the ThinkPad Tablet Setup program menu will be displayed after you enter the password.

The ThinkPad Tablet Setup program includes the following menus:

- **Main menu:** View the system information and set the date and time for your tablet.
- **Config menu:** View and change the configurations of your tablet.
- **Security menu:** Set the supervisor password and configure other security features of your tablet.

- **Startup menu:** Change the tablet startup settings.
- **Restart menu:** Choose an option for closing the ThinkPad Tablet Setup program and restarting the system.

On each menu, tap the default value to show selectable options and tap a desired option to select it. You can follow the instructions on the screen to configure settings. After you change the settings, tap **Restart**, and then tap your desired option to restart the tablet.

#### Notes:

- Some items are displayed on the menu only if the tablet supports the corresponding features.
- The default configurations are already optimized for you. Incorrect change of the configurations might cause unexpected results.

## Main menu

The **Main** menu is the first interface you see after you enter the ThinkPad Tablet Setup program. It displays the following configuration of your tablet:

- System Information
  - **UEFI BIOS Version**
  - **UEFI BIOS Date (Year-Month-Day)**
  - **Embedded Controller Version**
  - **MPU Firmware Version**
  - **TXE Firmware Version**
  - **Machine Type Model**
  - **System-unit serial number**
  - **UUID**
  - **System board serial number**
  - **Asset Tag**
  - **Processor Type**
  - **Processor Speed**
  - **Total Memory**
  - **Preinstalled operating system license**
  - **UEFI Secure Boot**
- System Date
- System Time

#### Set the system date and system time

If you need to set the current date and time of your tablet, tap **System Date** or **System Time** from the ThinkPad Tablet Setup menu. One of the following submenus is displayed:

- System Date
- System Time

To change the date and time, do the following:

1. Tap to select the item to change the date or time.
2. Tap to select a field.



3. Input the date or time by using the onscreen keyboard.

## Config menu

If you need to change the configuration of your tablet, tap **Config** from the ThinkPad Tablet Setup program main menu.

The following table lists the **Config** menu items.

### Notes:

- Default values are in **boldface**.
- On each submenu, tap the default value to show selectable options and tap a desired option.
- Some items are displayed on the menu only if the tablet supports the corresponding features.

Table 1. Config menu items

Menu item	Submenu item	Selection	Comments
<b>Network</b>	UEFI IPv4 Network Stack	<ul style="list-style-type: none"> <li>• <b>Off</b></li> <li>• On</li> </ul>	Enable or disable Network Stack for PXE Boot.
	UEFI IPv6 Network Stack	<ul style="list-style-type: none"> <li>• <b>Off</b></li> <li>• On</li> </ul>	Enable or disable Network Stack for PXE Boot.
	UEFI PXE Boot Priority	<ul style="list-style-type: none"> <li>• <b>IPv6 First</b></li> <li>• IPv4 First</li> </ul>	Enable or disable Network Stack for PXE Boot.
<b>USB</b>	USB UEFI BIOS Support	<ul style="list-style-type: none"> <li>• Disabled</li> <li>• <b>Enabled</b></li> </ul>	Enable or disable boot support for USB storage devices.
	Always On USB	<ul style="list-style-type: none"> <li>• Disabled</li> <li>• <b>Enabled</b></li> </ul>	<p>If you select <b>Enabled</b>, the external USB devices can be charged through USB connectors even when the tablet is in low-power mode (sleep, hibernate, or power-off).</p> <p><b>Note:</b> If you select Enabled, USB wake up function is not supported on Always On USB connector.</p>
	– Charge in Battery Mode	<ul style="list-style-type: none"> <li>• <b>Disabled</b></li> <li>• Enabled</li> </ul>	If you select <b>Enabled</b> , the external USB devices can be charged through USB connectors even when system is in hibernation or power-off mode and in battery mode.
	USB 3.0 Mode	<ul style="list-style-type: none"> <li>• Disabled</li> <li>• Enabled</li> <li>• <b>Auto</b></li> </ul>	Set the USB 3.0 controller mode for the ports shared between USB 2.0 and USB 3.0 controllers. If you select <b>Auto</b> , it enables you to connect and route appropriate USB 3.0 or USB 2.0 connectors. If you select <b>Enabled</b> , it enables

Table 1. Config menu items (continued)

Menu item	Submenu item	Selection	Comments
			USB 3.0 mode and allows USB 3.0 to be supported in the operating system. If you select <b>Disabled</b> , it disables and hides the USB 3.0 controller, and USB 3.0 connectors will work as USB 2.0 connectors.
<b>Keyboard/Mouse</b>	TrackPoint	<ul style="list-style-type: none"> <li>• Disabled</li> <li>• <b>Enabled</b></li> </ul>	Enable or disable the built-in TrackPoint pointing device.
	Trackpad	<ul style="list-style-type: none"> <li>• Disabled</li> <li>• <b>Enabled</b></li> </ul>	Enable or disable the built-in trackpad.
	Fn and Ctrl Key swap	<ul style="list-style-type: none"> <li>• <b>Disabled</b></li> <li>• Enabled</li> </ul>	If you select <b>Enabled</b> , the Fn key works as the Ctrl key, and the Ctrl key works as the Fn key.
<b>Display</b>	Boot Display Device	<ul style="list-style-type: none"> <li>• <b>ThinkPad LCD</b></li> <li>• Analog (VGA)</li> <li>• Digital on ThinkPad</li> <li>• Display on dock</li> </ul>	<p>Select the display device that is to be activated at boot time. This selection is effective for boot time, password prompt, and ThinkPad Tablet Setup.</p> <p><b>Digital on ThinkPad</b> is the Mini DisplayPort connector on your tablet.</p> <p><b>Display on dock</b> is display connectors on a dock.</p>
<b>Power</b>	Intel (R) SpeedStep technology	<ul style="list-style-type: none"> <li>• Disabled</li> <li>• <b>Enabled</b></li> </ul> <p>Mode for AC</p> <ul style="list-style-type: none"> <li>• <b>Maximum Performance</b></li> <li>• Battery Optimized</li> </ul> <p>Mode for Battery</p> <ul style="list-style-type: none"> <li>• Maximum Performance</li> <li>• <b>Battery Optimized</b></li> </ul>	<p>Select the mode of Intel SpeedStep technology at runtime.</p> <p><b>Maximum Performance:</b> Always highest speed.</p> <p><b>Battery Optimized:</b> Always lowest speed.</p> <p><b>Disabled:</b> No runtime support, highest speed.</p>
	Adaptive Thermal Management	<p>Scheme for AC</p> <ul style="list-style-type: none"> <li>• <b>Maximize Performance</b></li> <li>• Balanced</li> </ul> <p>Scheme for Battery</p> <ul style="list-style-type: none"> <li>• Maximize Performance</li> <li>• <b>Balanced</b></li> </ul>	<p>Select a thermal management scheme to use.</p> <p><b>Maximize Performance:</b> Reduce microprocessor throttling.</p> <p><b>Balanced:</b> Balance sound, temperature, and performance.</p>

Table 1. Config menu items (continued)

Menu item	Submenu item	Selection	Comments
			<b>Note:</b> Each scheme affects fan sound, temperature, and performance.
	CPU Power Management	<ul style="list-style-type: none"> <li>• Disabled</li> <li>• <b>Enabled</b></li> </ul>	Enable or disable the power-saving feature that stops the microprocessor clock automatically when there are no system activities. Normally, it is not necessary to change the setting.
	Power On with AC Attach	<ul style="list-style-type: none"> <li>• <b>Disabled</b></li> <li>• Enabled</li> </ul>	<p>Enable or disable a feature that powers on the system when the ac power adapter is attached.</p> <p>If you select <b>Enabled</b>, the system is powered on when the ac power adapter is attached. When the system is in hibernate state, the system resumes.</p> <p>If you select <b>Disabled</b>, the system is not powered on nor resumed when the ac power adapter is attached.</p>
	Intel Rapid Start Technology	<ul style="list-style-type: none"> <li>• Disabled</li> <li>• <b>Enabled</b></li> </ul> <p>Enter after:</p> <ul style="list-style-type: none"> <li>• Immediately</li> <li>• 1 minute</li> <li>• 2 minutes</li> <li>• 5 minutes</li> <li>• 10 minutes</li> <li>• 15 minutes</li> <li>• 30 minutes</li> <li>• 1 hour</li> <li>• 2 hours</li> <li>• <b>3 hours</b></li> </ul>	<p>To use this feature, a special partition on the solid-state drive is required.</p> <p>When enabled, the tablet enters a lower power state after the specified time in sleep state. And it takes only seconds to resume normal operation.</p>
	Disable Built-in Battery	<ul style="list-style-type: none"> <li>• Yes</li> <li>• <b>No</b></li> </ul>	<p>Temporarily disable the internal built-in battery for servicing the system. After selecting this item, the system will be automatically powered off. The system is then ready to be serviced.</p> <p><b>Note:</b> The battery will be automatically re-enabled when the ac power adapter is reconnected to the system.</p>

Table 1. Config menu items (continued)

Menu item	Submenu item	Selection	Comments
<b>Beep and Alarm</b>	Password Beep	<ul style="list-style-type: none"> <li>• <b>Disabled</b></li> <li>• Enabled</li> </ul>	Enable this option to have a beep sound when the system is waiting for a power-on, hard disk, or supervisor password. Different beeps will sound when the entered password matches or does not match the configured password.
	Keyboard Beep	<ul style="list-style-type: none"> <li>• <b>Enabled</b></li> <li>• Disabled</li> </ul>	Enable or disable keyboard beep when unmanageable key combinations are pressed.
<b>Startup option</b>	Boot Device List F12 Option	<ul style="list-style-type: none"> <li>• <b>On</b></li> <li>• Off</li> </ul>	Enable or disable boot device menu.
	Boot Order Lock	<ul style="list-style-type: none"> <li>• On</li> <li>• <b>Off</b></li> </ul>	Enable or disable boot order lock.
<b>Intel AMT</b>	Intel AMT Control	<ul style="list-style-type: none"> <li>• Disabled</li> <li>• <b>Enabled</b></li> <li>• Permanently Disabled</li> </ul>	<p>If you select <b>Enabled</b>, Intel AMT (Active Management Technology) is configured and additional setup items are provided in MEBx (Management Engine BIOS Extension) Setup.</p> <p>If you select <b>Permanently Disabled</b>, you will never be able to enable it again. Be cautious when you want to use this option.</p> <p><b>Note:</b> You can enter the MEBx Setup menu by pressing the Ctrl+P key combination in the Startup Interrupt Menu window. To display the Startup Interrupt Menu window, press the black button or Enter key during the power-on self-test (POST).</p>
	CIRA Timeout	<p>0-255</p> <p><b>Note:</b> The default value is 60 seconds.</p>	<p>Set the timeout option for CIRA connection to be established. Selectable second values are from 1 to 254.</p> <p>If you select <b>0</b>, use 60 seconds as the default timeout value.</p> <p>If you select <b>255</b>, the waiting time for establishing a connection is unlimited.</p>

Table 1. Config menu items (continued)

Menu item	Submenu item	Selection	Comments
	Console Type	<ul style="list-style-type: none"> <li>• PC ANSI</li> <li>• <b>VT100+</b></li> <li>• PC-ANSI</li> <li>• VT-UTF8</li> </ul>	<p>Select the console type for AMT.</p> <p><b>Note:</b> This console type should match the Intel AMT remote console.</p>
<b>Debug Port</b>	Debug Port	<ul style="list-style-type: none"> <li>• <b>Disabled</b></li> <li>• Enabled</li> </ul>	<p><b>Disabled:</b> Do not allow users to use debug port.</p> <p><b>Enabled:</b> Allow users to use debug port.</p>

## Security menu

If you need to set the security features of your tablet, tap **Security** from the ThinkPad Tablet Setup menu.

The following table lists the **Security** menu items.

### Notes:

- Default values are in **boldface**. The default settings are already optimized for you. If you consider changing the tablet configuration, proceed with extreme caution. Setting the configuration incorrectly might cause unexpected results.
- In each submenu, tap the default value to show selectable options and tap a desired option.
- Some items are displayed on the menu only if the tablet supports the corresponding features.

Table 2. Security menu items

Menu item	Submenu item	Value	Comments
<b>Password</b>	Supervisor Password	<ul style="list-style-type: none"> <li>• <b>Disabled</b></li> <li>• Enabled</li> </ul>	See "Supervisor password" on page 64.
	Lock UEFI BIOS Settings	<ul style="list-style-type: none"> <li>• <b>Disabled</b></li> <li>• Enabled</li> </ul>	Enable or disable the function that protects items in ThinkPad Tablet Setup from being changed by a user who does not have the supervisor password. By default, this is set to <b>Disabled</b> . If you set the supervisor password and enable this function, no one but you can change any items in ThinkPad Tablet Setup.
	Password at Unattended Boot	<ul style="list-style-type: none"> <li>• Disabled</li> <li>• <b>Enabled</b></li> </ul>	If you select and enable <b>Password at unattended boot</b> , a password prompt is displayed when the tablet is turned on, from either a power-off state or hibernation state, by an unattended event such as a Wake on LAN attempt. If you select <b>Disabled</b> ,

Table 2. Security menu items (continued)

Menu item	Submenu item	Value	Comments
			no password prompt is displayed; the tablet goes ahead and loads the operating system. To prevent unauthorized access, set the user authentication on the operating system.
	Password at Restart	<ul style="list-style-type: none"> <li>• <b>Disabled</b></li> <li>• Enabled</li> </ul>	If you select and enable <b>Password at restart</b> , a password prompt is displayed when you restart the tablet. If you select <b>Disabled</b> , no password prompt is displayed; the tablet goes ahead and loads the operating system. To prevent unauthorized access, set the user authentication on the operating system.
	Password at Boot Device List	<ul style="list-style-type: none"> <li>• <b>Disabled</b></li> <li>• Enabled</li> </ul>	If the Security password is set, this option is used to specify whether the Security password must be entered to display the F12 boot device list.  Select <b>Enabled</b> to prompt for the Security password. Select <b>Disabled</b> to proceed without any user action required.
	Password Count Exceeded Error	<ul style="list-style-type: none"> <li>• Disabled</li> <li>• <b>Enabled</b></li> </ul>	Select <b>Enabled</b> to show the POST 0199 error and prompt for the Security password. Select <b>Disabled</b> to hide the POST 0199 error and proceed without any user action needed.
	Set Minimum Length	<ul style="list-style-type: none"> <li>• <b>Disabled</b></li> <li>• x characters (<math>4 \leq x \leq 12</math>)</li> </ul>	Specify a minimum length for power-on passwords and hard disk passwords. If you set the supervisor password and specify a minimum length for passwords, no one but you can change the length.
	Power-On Password	<ul style="list-style-type: none"> <li>• <b>Disabled</b></li> <li>• Enabled</li> </ul>	See "Power-on password" on page 63.
	Hard Disk 1 Password	<ul style="list-style-type: none"> <li>• <b>Disabled</b></li> <li>• Enabled</li> </ul>	See "Hard disk passwords" on page 65.

Table 2. Security menu items (continued)

Menu item	Submenu item	Value	Comments
<b>Secure Boot</b>	Secure Boot	<ul style="list-style-type: none"> <li>• <b>On</b></li> <li>• Off</li> </ul>	Enable or disable UEFI Secure Boot feature.
	Platform Mode	<ul style="list-style-type: none"> <li>• <b>User Mode</b></li> <li>• Setup Mode</li> </ul>	Specify the system operating mode.
	Secure Boot Mode	<ul style="list-style-type: none"> <li>• <b>Standard Mode</b></li> <li>• Custom Mode</li> </ul>	Indicates Secure Boot mode is standard mode or custom mode.
	Reset to Setup Mode	<ul style="list-style-type: none"> <li>• <b>Enter</b></li> </ul>	This option is used to clear the current platform key and put the system into setup mode. You can install your own platform key and customize the Secure Boot signature databases in setup mode. Secure Boot mode will be set to custom mode.
	Restore Factory Keys	<ul style="list-style-type: none"> <li>• <b>Enter</b></li> </ul>	This option is used to restore all keys and certificates in Secure Boot databases to factory defaults. Any customized Secure Boot settings will be erased, and the default platform key will be re-established along with the original signature databases including certificate for Windows 8.1 operating system.
<b>UEFI BIOS Update Option</b>	Flash BIOS Updating by End-Users	<ul style="list-style-type: none"> <li>• Disabled</li> <li>• <b>Enabled</b></li> </ul>	If you select <b>Enabled</b> , all users can update the UEFI BIOS. If you select <b>Disabled</b> , only the person who knows the supervisor password can update the UEFI BIOS.
	Secure RollBack Prevention	<ul style="list-style-type: none"> <li>• <b>On</b></li> <li>• Off</li> </ul>	If you select <b>Off</b> , you can flash to the previous version of UEFI BIOS. If you select <b>On</b> , you can not flash to the previous version of UEFI BIOS.

Table 2. Security menu items (continued)

Menu item	Submenu item	Value	Comments
<b>Memory Protection</b>	Execution Prevention	<ul style="list-style-type: none"> <li>• Disabled</li> <li>• <b>Enabled</b></li> </ul>	Some computer viruses and worms cause memory buffers to overflow. By selecting <b>Enabled</b> you can protect your tablet against attacks by such viruses and worms. If after choosing <b>Enabled</b> you find that a program does not run correctly, select <b>Disabled</b> and reset the setting.
	Virtualization	<ul style="list-style-type: none"> <li>• <b>Disabled</b></li> <li>• Enabled</li> </ul>	If you select <b>Enabled</b> , a Virtual Machine Monitor (VMM) can utilize the additional hardware capabilities provided by Intel Virtualization Technology.
	Intel VT-d Feature	<ul style="list-style-type: none"> <li>• <b>Disabled</b></li> <li>• Enabled</li> </ul>	Intel VT-d stands for Intel Virtualization Technology for Directed I/O. When enabled, a VMM can utilize the platform infrastructure for I/O virtualization.
<b>I/O Port Access</b>	Wireless LAN	<ul style="list-style-type: none"> <li>• <b>On</b></li> <li>• Off</li> </ul>	If you select <b>On</b> , you can use the wireless LAN device.
	Wireless WAN	<ul style="list-style-type: none"> <li>• <b>On</b></li> <li>• Off</li> </ul>	If you select <b>On</b> , you can use the wireless WAN device.
	Bluetooth	<ul style="list-style-type: none"> <li>• <b>On</b></li> <li>• Off</li> </ul>	If you select <b>On</b> , you can use Bluetooth devices.
	GPS	<ul style="list-style-type: none"> <li>• <b>On</b></li> <li>• Off</li> </ul>	If you select <b>On</b> , you can use GPS devices.
	USB Port	<ul style="list-style-type: none"> <li>• <b>On</b></li> <li>• Off</li> </ul>	If you select <b>On</b> , you can use USB connectors.
	Memory Card Slot	<ul style="list-style-type: none"> <li>• <b>On</b></li> <li>• Off</li> </ul>	If you select <b>On</b> , you can use the memory card slots.
	Smart Card Slot	<ul style="list-style-type: none"> <li>• <b>On</b></li> <li>• Off</li> </ul>	If you select <b>On</b> , you can use the smart card slot.
	Integrated Camera	<ul style="list-style-type: none"> <li>• <b>On</b></li> <li>• Off</li> </ul>	If you select <b>On</b> , you can use the integrated camera.
	NFC	<ul style="list-style-type: none"> <li>• <b>On</b></li> <li>• Off</li> </ul>	If you select <b>On</b> , you can use the NFC connection.
	Fingerprint Reader	<ul style="list-style-type: none"> <li>• <b>On</b></li> <li>• Off</li> </ul>	If you select <b>On</b> , you can use the fingerprint reader.



Table 2. Security menu items (continued)

Menu item	Submenu item	Value	Comments
	Microphone	<ul style="list-style-type: none"> <li>• On</li> <li>• Off</li> </ul>	If you select <b>On</b> , you can use the microphones (internal, external, or line-in).
	Ultrabook Keyboard	<ul style="list-style-type: none"> <li>• On</li> <li>• Off</li> </ul>	If you select <b>On</b> , you can use the ThinkPad Helix Ultrabook Keyboard.
	ThinkPad Tablet Dock Audio	<ul style="list-style-type: none"> <li>• On</li> <li>• Off</li> </ul>	If you select <b>On</b> , you can use the audio connector on ThinkPad Tablet Dock.
	ThinkPad Tablet Dock Ethernet LAN	<ul style="list-style-type: none"> <li>• On</li> <li>• Off</li> </ul>	If you select <b>On</b> , you can use the Ethernet LAN device on ThinkPad Tablet Dock.
	USB Port on ThinkPad Tablet Dock	<ul style="list-style-type: none"> <li>• On</li> <li>• Off</li> </ul>	If you select <b>On</b> , you can use USB connectors on ThinkPad Tablet Dock.
<b>Security Chip</b>	Intel TXT Feature	<ul style="list-style-type: none"> <li>• On</li> <li>• Off</li> </ul>	<p>Enable or disable Intel Trusted Execution Technology.</p> <p><b>Notes:</b></p> <ul style="list-style-type: none"> <li>• This item is displayed only if you have selected <b>Active</b> or <b>Enabled</b> for the <b>Security Chip</b> option.</li> <li>• This is set to disabled when Intel PTT is enabled.</li> </ul>
	Security Chip Selection	<ul style="list-style-type: none"> <li>• <b>Firmware TPM</b></li> <li>• Discrete TPM</li> </ul>	Configure the security chip. This option is available only on models that have both the firmware TPM and the discrete TPM.
	Security Chip	<ul style="list-style-type: none"> <li>• On</li> <li>• Off</li> </ul>	Enable or disable security chip feature.
	Clear Security Chip	<ul style="list-style-type: none"> <li>• <b>Enter</b></li> </ul>	<p>Clear the encryption key.</p> <p><b>Note:</b> This item is displayed only if you have selected <b>On</b> for the <b>Security Chip</b> option.</p>
	Physical Presence for Provisioning	<ul style="list-style-type: none"> <li>• Off</li> <li>• On</li> </ul>	This option enables or disables the confirmation message when you change the settings of the security chip.

Table 2. Security menu items (continued)

Menu item	Submenu item	Value	Comments
	Physical Presence for Clear	<ul style="list-style-type: none"> <li>• <b>On</b></li> <li>• Off</li> </ul>	This option enables or disables the confirmation message when you clear the security chip.
<b>Anti-Theft</b>	Intel AT Module Activation	<ul style="list-style-type: none"> <li>• Disabled</li> <li>• <b>Enabled</b></li> <li>• Permanently Disabled</li> </ul>	<p>Enable or disable the UEFI BIOS interface to activate the Intel AT module, which is an optional anti-theft service from Intel.</p> <p><b>Note:</b> If you set the Intel AT module activation to <b>Permanently Disabled</b>, you will be unable to enable this setting again.</p>
	Intel AT Suspend	<ul style="list-style-type: none"> <li>• Enter</li> </ul>	This option is displayed only when the anti-theft function is activated. The Intel anti-theft suspend screen will be displayed at next boot to enter the suspend mode.
	Computrace Module Activation	<p>Current Setting:</p> <ul style="list-style-type: none"> <li>• <b>On</b></li> <li>• Off</li> </ul> <p>Current State:</p> <ul style="list-style-type: none"> <li>• <b>Not activated</b></li> <li>• Activated</li> </ul> <p>Permanently Disabled:</p> <ul style="list-style-type: none"> <li>• Enter</li> </ul>	<p>Enable or disable the UEFI BIOS interface to activate the computrace module. Computrace is an optional monitoring service from Absolute Software.</p> <p><b>Note:</b> If you set the computrace module activation to <b>Permanently Disabled</b>, you will be unable to enable this setting again.</p>

## Startup menu

You might need to change the tablet startup settings. To do so, tap **Startup** from the ThinkPad Tablet Setup menu.

### Attention:

- After you change your startup sequence, you must be extremely careful not to specify a wrong device during a copy, a save, or a format operation. If you specify a wrong device, your data and programs might be erased or overwritten.
- If you are using the BitLocker® drive encryption, you should not change the startup sequence. BitLocker drive encryption detects the change of startup sequence and locks the tablet from booting.

### Changing the startup sequence

To change the startup sequence, do the following:

1. Tap **Boot**. The default boot list is displayed, showing the order in which devices will be started up. Even devices that are not attached to or installed on your tablet are listed.

2. From the **Boot** submenu, tap the menu item to specify the startup sequence that runs when you turn on the power.
3. Save the changes and restart the system.

The following table lists the **Startup** menu items.

**Notes:**

- Default values are in **boldface**.
- From each submenu, tap the default value to show selectable options and select a desired option.
- Some items are displayed on the menu only if the tablet supports the corresponding features.

Table 3. Startup menu items

Menu item	Value	Comments
<b>Boot</b>		See “Changing the startup sequence” on page 82.
<b>Internal Storage</b>	<ul style="list-style-type: none"> <li>• <b>On</b></li> <li>• Off</li> </ul>	Change the Boot order by dragging and dropping the icon.
<b>USB HDD</b>	<ul style="list-style-type: none"> <li>• <b>On</b></li> <li>• Off</li> </ul>	Change the Boot order by dragging and dropping the icon.
<b>USB CD/DVD</b>	<ul style="list-style-type: none"> <li>• <b>On</b></li> <li>• Off</li> </ul>	Change the Boot order by dragging and dropping the icon.
<b>USB FDD</b>	<ul style="list-style-type: none"> <li>• <b>On</b></li> <li>• Off</li> </ul>	Change the Boot order by dragging and dropping the icon.
<b>SD Card0</b>	<ul style="list-style-type: none"> <li>• <b>On</b></li> <li>• Off</li> </ul>	Change the Boot order by dragging and dropping the icon.
<b>Network Adapter</b>	<ul style="list-style-type: none"> <li>• <b>On</b></li> <li>• Off</li> </ul>	Change the Boot order by dragging and dropping the icon.

## Restart menu

If you want to close the ThinkPad Tablet Setup program and restart the system, tap **Restart** from the ThinkPad Tablet Setup main menu. The following items are displayed:

- **Exit Saving Changes:** Exit system setup and save the changes.
- **Exit Discarding Changes:** Exit system setup without saving the changes.
- **Load Setup Defaults:** Restore to the factory default settings.
- **Discard Changes:** Discard the changes.
- **Save Changes:** Save the changes.

**Note:** Changes on the following items are saved automatically during your configuration:

- Any items included in the **Security** menu
- System date and time

These changes cannot be discarded even you select an option to discard the changes or restore to the factory default settings when exiting the ThinkPad Tablet Setup program. To discard the changes or make new changes, you must enter the ThinkPad Tablet Setup program again and reset the corresponding items according to your needs.

## Updating your system UEFI BIOS

The Unified Extensible Firmware Interface (UEFI) BIOS is a part of the system programs that make up the basic layer of software built into your tablet. The UEFI BIOS translates the instructions from other software layers.

You can update the UEFI BIOS and the ThinkPad Tablet Setup program by starting your tablet with a flash update application running in the Windows environment.

In some instances when you add software, hardware, or a device driver, you might be informed that you need to update your UEFI BIOS in order for the new addition to work properly.

To update your UEFI BIOS, go to the following Web site and follow the instructions on the screen:  
<http://www.lenovo.com/ThinkPadDrivers>

---

## Using system management

This section is intended primarily for network administrators.

Your tablet is designed for manageability, so that you can redirect more of your resources to better meet your business objectives.

This manageability, or “Total Cost of Ownership” (TCO), enables you to remotely operate client tablets in the same way as you operate your own tablet, such as turning on a client tablet, formatting hard disk drive, and installing software.

Once the tablet is configured and operational, you can manage it by use of software and manageability features already integrated into the client system and the network.

## System management

Read this topic to learn more about features of system management.

### Desktop Management Interface

The system UEFI BIOS of your tablet supports an interface called System Management BIOS Reference Specification (SMBIOS) V2.6.1. SMBIOS provides information about the hardware components of your system. It is the responsibility of the BIOS to supply this database with information about itself and the devices on the system board. This specification documents the standards for getting access to this BIOS information.

### Asset ID EEPROM

The Asset ID EEPROM contains information about the system, including its configuration and the serial numbers of key components. It also includes a number of blank fields in which you can record information about the end users in your network.

### Preboot eXecution Environment

The Preboot eXecution Environment (PXE) technology makes the tablet more manageable by enabling the tablet to start from a server. For example, with the appropriate LAN card, your tablet can be started from the PXE server.

**Note:** The Remote Initial Program Load (RIPL or RPL) function cannot be used with your tablet.

---

## Chapter 8. Troubleshooting problems

This chapter describes on what to do if you experience a problem with your tablet.

---

### Diagnosing problems

If you experience problems with your tablet, use the Lenovo Solution Center program as a starting point for solving them.

The Lenovo Solution Center program enables you to troubleshoot and resolve tablet problems. It combines diagnostic tests, system information collection, security status, and support information, along with hints and tips for maximum system performance.

**Note:** The Lenovo Solution Center program can be downloaded from <http://www.lenovo.com/diags>.

To run the Lenovo Solution Center program, do the following:

1. Swipe in from the right edge of the screen to display the charms.
2. Tap the **Search** charm to search for **Lenovo Solution Center**.
3. Tap **Lenovo Solution Center**.

For additional information, refer to the Lenovo Solution Center help system.

**Note:** If you are unable to isolate and repair the problem yourself after running the program, save and print the log files. You will need the log files when you speak to a Lenovo technical support representative.

---

### Troubleshooting

The problems and solutions described in this section are meant only as a guide. They are not definitive problem solving techniques. For some problems, you might need help from Lenovo, your reseller, or your service provider.

When you observe a problem, stop operation immediately, because taking further action might result in data loss or damage. Take a note of what the system is doing and what actions you performed before the problem occurred. Provide detailed information to Lenovo or your service provider for quicker problem resolution.

#### Internet problem

- **Problem:** Unable to connect to the wireless network.

**Suggested solution:** Ensure that:

- The micro SIM card is valid and workable if you are using a mobile network (3G or 4G).
- You are within the network's service range and the signal strength is good.
- Your tablet is not in Airplane mode.

If the problem persists, contact Lenovo for technical support.

#### Screen problems

- **Problem:** The multi-touch screen responds slowly or improperly.

**Suggested solution:** Do the following:

1. Ensure that your hands are clean and dry when touching the screen.
2. Restart your tablet to try again.

If the problem persists, contact Lenovo for technical support.

- **Problem:** My screen keeps blanking when I do not want it to.

**Solution:** You can disable any system timers, such as the LCD turn-off timer or the blank timer by doing the following:

1. Go to the desktop and tap the battery-status icon in the Windows notification area.
2. Tap **More power options** → **Balanced**.

- **Problem:** When I turn on the tablet, nothing is displayed on the screen and the tablet does not beep while starting up.

**Note:** If you are not sure whether you heard any beeps, turn off the tablet by pressing and holding the power button for four seconds or more. Turn it on and listen again.

**Solution:** Ensure that:

- The tablet is connected to the ac power adapter by the supplied USB cable and the ac power adapter is plugged into a working electrical outlet.

The tablet is turned on. (Turn the power button on again for confirmation.)

If these items are correctly set, and the screen remains blank, have the tablet serviced.

- **Problem:** When I turn on the tablet, only a white pointer is displayed on a blank screen.

**Solution:** Do the following:

1. Turn off the tablet, and then turn it on again.
2. If you still see only the pointer on the screen, use the recovery solutions to restore the system to the factory state.

If the problem persists, have the tablet serviced.

- **Problem:** My screen goes blank while the tablet is on.

**Solution:** Your screen saver or power management might have been enabled. Do either of the following:

- Tap the tablet screen to exit the screen saver.
- Press the power button to resume from sleep or hibernation mode.

## Battery problem

- **Problem:** The battery does not charge correctly.

**Suggested solution:** Check if the ac power adapter is connected correctly. If the connection is good but the battery still does not charge, contact Lenovo to replace with a new battery.

## System problem

- **Problem:** Unable to turn the tablet on.

**Suggested solution:** Connect your tablet to an ac power outlet to see if the problem is caused by a drained battery. If the problem persists, insert a needle or a straightened paper clip into the emergency-reset hole. To locate the emergency-reset hole, see “Front view and side view” on page 1. If the problem still persists, contact Lenovo for technical support.

## Media problems

- **Problem:** The audio quality is poor or there is no sound output.

**Suggested solution:** Check and ensure that:

- The speaker is not covered.

- The speaker mute function is disabled.
- If you are using a headset, unplug it, then plug it in again.
- The volume is not turned to the lowest level.

If the problem persists, contact Lenovo for technical support.

- **Problem:** A song, video, or other media file cannot be played.

**Suggested solution:** Check and ensure that the media file is not corrupted.

### External device connection problems

- **Problem:** A connection is not established when you connect the tablet to a computer.

**Suggested solution:** Ensure that the tablet USB cable you are using is the one that is shipped with your tablet.

- **Problem:** Bluetooth devices cannot be located.

**Suggested solution:** Ensure that:

- Your tablet Bluetooth is switched on.
- The Bluetooth feature is activated on the device to which you want to connect.
- Your tablet and the Bluetooth device are within the maximum Bluetooth range (10 m).

If the problem persists, contact Lenovo for technical support.

---

## Recovering from a severe software problem

If your tablet stops responding and you cannot turn off the tablet by pressing and holding the power button, insert a needle or a straightened paper clip into the emergency-reset hole to reset the tablet. Then restart your tablet. To locate the emergency-reset hole, see “Front view and side view” on page 1.

If you still encounter the same problem after you restart your tablet, reset your tablet and restart it again, you can perform a factory data reset operation. For more information, refer to “Resetting your tablet to the factory default settings” on page 89.

---

## Error messages

- **Message:** 0177: Bad SVP data, stop POST task.  
**Solution:** Checksum of the supervisor password in the EEPROM is not correct. The system board should be replaced. Have the tablet serviced.
- **Message:** 0183: Bad CRC of Security Settings in EFI Variable. Enter ThinkPad Tablet Setup.  
**Solution:** Checksum of the Security settings in the EFI Variable is not correct. Enter ThinkPad Tablet Setup to check security settings, and restart the system. If you still have a problem, have the tablet serviced.
- **Message:** 0187: EAIA data access error.  
**Solution:** The access to EEPROM is failed. Have the tablet serviced.
- **Message:** 0188: Invalid RFID Serialization Information Area.  
**Solution:** The EEPROM checksum is not correct (block # 0 and 1). The system board should be replaced, and the box serial number needs to be reinstalled. Have the tablet serviced.
- **Message:** 0189: Invalid RFID configuration information area  
**Solution:** The EEPROM checksum is not correct (block # 4 and 5). The system board should be replaced, and the universally unique identifier (UUID) needs to be reinstalled. Have the tablet serviced.
- **Message:** 0190: Critical low-battery error

**Solution:** The tablet turned off, because the battery power is low. Connect the ac power adapter to the tablet and charge the batteries.

- **Message:** 0191: System Security - Invalid remote change requested

**Solution:** The system configuration change has failed. Confirm the operation and try again. To clear the error, enter ThinkPad Tablet Setup.

- **Message:** 0199: System Security - Security password retry count exceeded.

**Solution:** This message is displayed if you enter a wrong supervisor password more than three times. Confirm the supervisor password and try again. To clear the error, enter ThinkPad Tablet Setup.

- **Message:** 1802: Unauthorized network card is plugged in - Power off and remove the network card.

**Solution:** The wireless network card is not supported on this tablet. Remove it.

- **Message:** 1820: More than one external fingerprint readers are attached.

**Solution:** Power off and remove all but the reader that you set up within your main operating system.

- **Message:** 2101: Detection error on SSD1 (M.2)

**Solution:** The M.2 SSD device is not working. Have the M.2 SSD device serviced.

- **Message:** 2102: Detection error on SSD2 (M.2)

**Solution:** The M.2 SSD device is not working. Have the M.2 SSD device serviced.

- **Message:** 2111: Read error on SSD1 (M.2)

**Solution:** The M.2 SSD device is not working. Have the M.2 SSD device serviced.

- **Message:** 2112: Read error on SSD2 (M.2)

**Solution:** The M.2 SSD device is not working. Have the M.2 SSD device serviced.

- **Message:** 2200: Machine Type and Serial Number are invalid.

**Solution:** Machine Type and Serial Number are invalid. Have the tablet serviced.

- **Message:** 2201: Machine UUID is invalid.

**Solution:** Machine UUID is invalid. Have the tablet serviced.

- **Message:** Fan error

**Solution:** Cooling fan has failed. Shut down the tablet immediately and have the tablet serviced.

- **Message:** Thermal sensing error

**Solution:** The thermal sensor has problem. Shut down the tablet immediately and have the tablet serviced.

- **Message:** Error: The System UEFI Variable Storage is nearly full.

**Note:** This error indicates that the operating system or applications cannot create, modify, or delete data in the non-volatile system UEFI variable storage due to insufficient storage space after POST.

The non-volatile system UEFI variable storage is used by the UEFI BIOS and by the operating system or applications. This error occurs when the operating system or applications store large amounts of data in the variable storage. All data needed for POST, such as BIOS setup settings, chipset or platform configuration data, are stored in a separate UEFI variable storage.

**Solution:** Enter ThinkPad Tablet Setup after the error message is displayed. A dialog asks the user for confirmation to clean up the storage. If the user selects “Yes”, all data that were created by the operating system or applications are deleted except global variables defined by the Unified Extensible Firmware Interface Specification. If the user selects “No”, all data is kept, but the operating system or applications will not be able to create, modify, or delete data in the storage.

If this error happens at a service center, Lenovo authorized service personnel will clean up the non-volatile system UEFI variable storage using the above solution.



---

## Chapter 9. Recovery information

This section provides information about the recovery solutions.

A Windows recovery image is preinstalled in the recovery partition on your tablet. The Windows recovery image enables you to refresh your tablet, or reset your tablet to the factory default settings.

You can create recovery media as backups or replacement for the Windows recovery image. With the recovery media, you can troubleshoot and fix the problems on your tablet even if you cannot start the operating system. It is recommended that you create recovery media as early as possible. For more information, see “Creating and using recovery media” on page 90.

---

### Refreshing your tablet

If your tablet does not perform well and the problem might be caused by a recently installed program, you can refresh your tablet without losing your personal files or changing your settings.

**Attention:** If you refresh your tablet, the programs that came with your tablet and the programs that you installed from Windows Store will be reinstalled, but all other programs will be removed.

To refresh your tablet, do the following:

1. Swipe in from the right edge of the screen to display the charms.
2. Tap **Settings** → **Change PC settings**.
3. In the navigation panel, tap **Update and recovery** → **Recovery**.
4. In the **Refresh your PC without affecting your files** section, tap **Get started**.
5. Follow the instructions on the screen to refresh your tablet.

---

### Resetting your tablet to the factory default settings

If you want to recycle your tablet or just start over, you can reset your tablet to the factory default settings. Resetting the tablet will reinstall the operating system, reinstall all the programs that came with your tablet, and reset all the settings to the factory default settings.

**Attention:** If you reset the tablet to the factory default settings, all your personal files and settings will be deleted. To avoid data loss, make a backup copy of all the data that you want to keep.

To reset your tablet to the factory default settings, do the following:

1. Swipe in from the right edge of the screen to display the charms.
2. Tap **Settings** → **Change PC settings**.
3. In the navigation panel, tap **Update and recovery** → **Recovery**.
4. In the **Remove everything and reinstall Windows** section, tap **Get started**. Then tap **Next** to confirm the operation.
5. Depending on your needs, do one of the following:
  - To perform a quick format, tap **Just remove my files** to start the process. The process will take several minutes.
  - To perform a complete format, tap **Fully clean the drive** to start the process. The process will take several hours.
6. Follow the instructions on the screen to reset your tablet to the factory default settings.

---

## Using the advanced startup options

With the advanced startup options, you can change the firmware settings of the tablet, change the startup settings of the Windows operating system, start the tablet from an external device, or restore the Windows operating system from a system image.

To use the advanced startup options, do the following:

1. Swipe in from the right edge of the screen to display the charms.
2. Tap **Settings** → **Change PC settings**.
3. In the navigation panel, tap **Update and recovery** → **Recovery**.
4. In the **Advanced startup** section, tap **Restart now** → **Troubleshoot** → **Advanced options**.
5. Select a desired startup option, then follow the instructions on the screen.

---

## Recovering your operating system if Windows 8.1 fails to start

The Windows recovery environment on your tablet is capable of operating independently from the Windows 8.1 operating system. This enables you to recover or repair the operating system even if the Windows 8.1 operating system fails to start.

After two consecutive failed boot attempts, the Windows recovery environment starts automatically. Then you can choose repair and recovery options by following the instructions on the screen.

**Note:** Ensure that your tablet is connected to ac power during the recovery process.

---

## Creating and using recovery media

You can create recovery media as backups for the Windows recovery environment and the Windows recovery image. If you cannot start the tablet, you can use recovery media to troubleshoot and fix the problems on your tablet.

It is recommended that you create recovery media as early as possible. Once you create recovery media, keep them in a safe place and do not use them to store other data.

### Creating recovery media

To create recovery media, you need a USB drive with at least 16 GB of storage. The required USB capacity depends on the size of the recovery image.

**Attention:** Creating recovery media will delete anything stored on the USB drive. To avoid data loss, make a backup copy of all the data that you want to keep.

To create recovery media, do the following:

**Note:** Ensure that your tablet is connected to ac power.

1. Swipe in from the right edge of the screen to display the charms.
2. Tap the **Search** charm.
3. Type **recovery** in the **Search** field. Then tap **Create a recovery drive**.
4. Tap **Yes** in the User Account Control window to allow the Recovery Media Creator program to start.
5. Ensure that you select the **Copy the recovery partition from the PC to the recovery drive** option. Then tap **Next**.

**Important:** If you clear the **Copy the recovery partition from the PC to the recovery drive.** option, you will create recovery media without the recovery partition content. You still can start the tablet from the recovery media, but you might be unable to recover your tablet if the recovery partition on your tablet is damaged.

6. Connect a proper USB drive, then tap **Next**.
7. Tap **Create** in the Recovery Drive window. The creation of the recovery media starts.
8. When the creation of the recovery media finishes, do one of the following:
  - To keep the recovery partition on your tablet, tap **Finish**.
  - To delete the recovery partition on your tablet, tap **Delete the recovery partition**.

**Attention:** If you delete the recovery partition on your tablet, do keep the recovery media in a safe place. The Windows recovery image will not be stored in your tablet anymore, and you will need the recovery media to refresh or reset your tablet.

9. Remove the USB drive. The recovery media are created successfully.

### Using recovery media

If you cannot start your tablet, or if you cannot start the Windows recovery image on your tablet, use recovery media to recover your tablet.

To use recovery media, do the following:

**Note:** Ensure that your tablet is connected to ac power.

1. Press the power button and the volume-up button at the same time when you turn on the tablet. The ThinkPad Tablet Setup program menu opens.
2. Tap **Startup**.
3. In the **Boot** submenu, drag the recovery drive to the first place to select it as the boot device.
4. Save configuration changes and restart the tablet.
5. Following the instructions on the screen to recover the tablet.

For more information about the recovery solutions provided by the Windows 8.1 operating system, go to: <http://go.microsoft.com/fwlink/?LinkID=263800>



---

## Chapter 10. Getting support

This chapter provides information about getting help and support from Lenovo.

---

### Locating important product information

This section provides information to help you locate the machine type and model (MTM) label, the Federal Communications Commission (FCC) ID and IC Certification label.

#### Locating the MTM number and the serial number

When calling for technical assistance, you are requested to provide the MTM number and the serial number. To get the MTM number and the serial number, check the MTM label on your product.

#### For the tablet:

**Note:** Depending on the model, your tablet might look different.



#### For the ThinkPad Helix Ultrabook Keyboard:



### For the ThinkPad Helix Ultrabook Pro Keyboard:



### Locating the FCC ID and IC Certification numbers

You can find the FCC ID and IC Certification numbers for the installed transmitter cards on the bottom of your tablet.

**Note:** Depending on the model, your tablet might look different.



---

## Lenovo technical support

After you buy a ThinkPad Helix, register your tablet with Lenovo. Using the registered information, Lenovo can contact you in case of a recall or other severe problems. After you register your tablet with Lenovo, you will receive quicker service when you call Lenovo for help. In addition, some locations offer extended privileges and services to registered users.

To register your tablet with Lenovo, go to <http://www.lenovo.com/register> and follow the instructions on the screen.

Technical support information is available on the Lenovo Support Web site at <http://www.lenovo.com/support>.

This Web site is updated with the latest support information such as the following:

- Drivers and software
- Diagnostic solutions
- Product and service warranty

- Product and parts details
- Guides and manuals
- Knowledge base and frequently asked questions

If you want to call the Lenovo Customer Support Center, go to <http://www.lenovo.com/support/phone> for the latest telephone numbers and hours of operation.

During the warranty period, you can get the following services from the Customer Support Center:

- **Problem determination:** Trained personnel are available to assist you with determining if you have a hardware problem and deciding what action is necessary to fix the problem.
- **Lenovo hardware repair:** If the problem is determined to be caused by Lenovo hardware under warranty, trained service personnel are available to provide the applicable level of service.
- **Engineering change management:** Occasionally, there might be changes that are required after a product has been sold. Lenovo or your reseller, if authorized by Lenovo, will make selected Engineering Changes (ECs) that apply to your hardware available.

For the terms and conditions of the Lenovo Limited Warranty that applies to your tablet, refer to the *Safety, Warranty, and Setup Guide* that comes with your tablet.

---

## Lenovo user forums

Lenovo provides user forums on the World Wide Web to provide you with a place to search the community knowledge base for information about your tablet, share information with other users, make suggestions to Lenovo, ask questions, and get technical support from Lenovo.

To go to Lenovo user forums, do the following:

1. Go to <http://www.lenovo.com/register> and follow the instructions on the screen to create an account.
2. Go to <http://www.lenovo.com/support>.
3. Tap **Community Forums**.

---

## Finding ThinkPad options

If you want to expand the capabilities of your tablet, Lenovo has a number of hardware accessories and upgrades to meet your needs.

You can shop at Lenovo 24 hours a day, 7 days a week directly over the World Wide Web. All you need is an Internet connection and a credit card.

To shop at Lenovo, go to:

<http://www.lenovo.com/essentials>

---

## Purchasing additional services

During and after the warranty period, you can purchase additional services, such as support for Lenovo and non-Lenovo hardware, operating systems, and application programs; network setup and configuration services; upgraded or extended hardware repair services; and custom installations services. Service availability and service name might vary by country.

For more information about these services, go to:

<http://www.lenovo.com/essentials>





---

## Appendix A. Regulatory information

This appendix provides regulatory information.

---

### Wireless related information

#### Wireless interoperability

The M.2 wireless LAN card is designed to be interoperable with any wireless LAN product that is based on Direct Sequence Spread Spectrum (DSSS), Complementary Code Keying (CCK), and/or Orthogonal Frequency Division Multiplexing (OFDM) radio technology, and is compliant to:

- The 802.11b/g Standard, 802.11a/b/g, 802.11n, or 802.11ac on Wireless LANs, as defined and approved by the Institute of Electrical and Electronics Engineers.
- The Wireless Fidelity (Wi-Fi) certification as defined by the Wi-Fi Alliance.

The Bluetooth card in your tablet is designed to be interoperable with any Bluetooth product that is compliant to Bluetooth Specification 4.0 as defined by the Bluetooth SIG. The following profiles are supported by your Bluetooth card:

**Note:** Depending on the Bluetooth card, some profile might not be available.

- Advanced Audio Distribution Profile (A2DP)
- A/V Remote Control Profile (AVRCP)
- Dial-Up Networking Profile (DUN)
- File Transfer Profile (FTP)
- Generic Access Profile (GAP)
- Generic A/V Distribution Profile (GAVDP)
- Hardcopy Cable Replacement Profile (HCRP)
- Headset Profile (HSP)
- Hands-Free Profile (HFP)
- Human Interface Device Profile (HID)
- Message Access Profile (MAP)
- Object Exchange Protocol (OBEX)
- Object Push Profile (OPP)
- Personal Area Networking Profile (PAN)
- Phone Book Access Profile (PBAP)
- Service Discovery Protocol (SDP)
- Synchronization Profile (SYNC)
- Video Distribution Profile (VDP)
- Generic Attribute Profile (GATT)
- Proximity Profile

## Usage environment and your health

Integrated wireless cards emit radio frequency electromagnetic energy like other radio devices. However, the level of energy emitted is far much less than the electromagnetic energy emitted by wireless devices such as mobile phones.

Due to the fact that integrated wireless cards operate within the guidelines found in radio frequency safety standards and recommendations, Lenovo believes they are safe for use by consumers. These standards and recommendations reflect the consensus of the scientific community and result from deliberations of panels and committees of scientists who continually review and interpret the extensive research literature.

In some situations or environments, the use of integrated wireless cards might be restricted by the proprietor of the building or responsible representatives of the organization. These situations and areas might for example include:

- Using the integrated wireless cards onboard of airplanes, in hospitals or near petrol stations, blasting areas (with electro-explosive devices), medical implants or body-worn electronic medical devices.
- In any other environment where the risk of interference to other devices or services is perceived or identified as harmful.

If you are uncertain of the policy that applies on the use of wireless devices in a specific organization, you are encouraged to ask for authorization to use integrated wireless cards prior to turning on the tablet.

## Locating the UltraConnect™ wireless antennas

ThinkPad Helix features an antenna system built into the display for optimal reception, which enables you to establish wireless communications wherever you are.

The following illustration shows the location of each built-in wireless antenna.

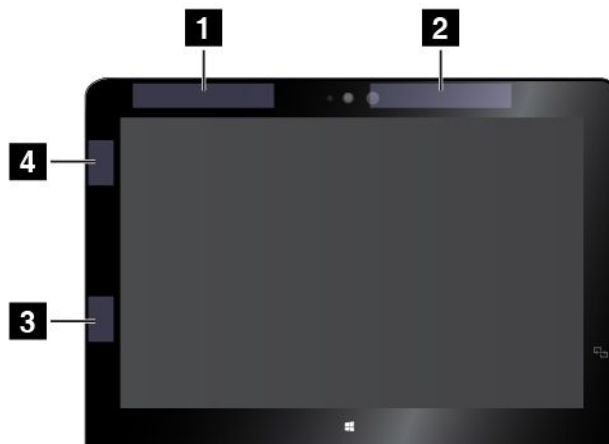

- 1 Wireless-WAN antenna (auxiliary)
- 2 Wireless-WAN antenna (main)
- 3 Wireless-LAN antenna (auxiliary)
- 4 Wireless-LAN antenna (main)

**Note:** Wireless-WAN antennas are available only on some models.

## Locating wireless regulatory notices

For more information about the wireless regulatory notices, refer to the *Regulatory Notice* shipped with the tablet.

If the tablet is shipped without the *Regulatory Notice*, you can find it on the Web site at:  
<http://www.lenovo.com/UserManuals>

---

## Export classification notice

This product is subject to the United States Export Administration Regulations (EAR) and has an Export Classification Control Number (ECCN) of 5A992.c. It can be re-exported except to any of the embargoed countries in the EAR E1 country list.

---

## Electronic emission notices

### Federal Communications Commission Declaration of Conformity

The following information refers to the ThinkPad Helix tablet, machine types 20CG and 20CH.

This equipment has been tested and found to comply with the limits for a Class B digital device, pursuant to Part 15 of the FCC Rules. These limits are designed to provide reasonable protection against harmful interference in a residential installation. This equipment generates, uses, and can radiate radio frequency energy and, if not installed and used in accordance with the instructions, may cause harmful interference to radio communications. However, there is no guarantee that interference will not occur in a particular installation. If this equipment does cause harmful interference to radio or television reception, which can be determined by turning the equipment off and on, the user is encouraged to try to correct the interference by one or more of the following measures:

- Reorient or relocate the receiving antenna.
- Increase the separation between the equipment and receiver.
- Connect the equipment into an outlet on a circuit different from that to which the receiver is connected.
- Consult an authorized dealer or service representative for help.

Lenovo is not responsible for any radio or television interference caused by using other than specified or recommended cables and connectors or by unauthorized changes or modifications to this equipment. Unauthorized changes or modifications could void the user's authority to operate the equipment.

This device complies with Part 15 of the FCC Rules. Operation is subject to the following two conditions: (1) this device may not cause harmful interference, and (2) this device must accept any interference received, including interference that may cause undesired operation.

Responsible Party:  
Lenovo (United States) Incorporated  
1009 Think Place - Building One  
Morrisville, NC 27560  
Phone Number: 919-294-5900



### Industry Canada Class B emission compliance statement

CAN ICES-3(B)/NMB-3(B)

## European Union - Compliance to the Electromagnetic Compatibility Directive

This product is in conformity with the protection requirements of EU Council Directive 2004/108/EC on the approximation of the laws of the Member States relating to electromagnetic compatibility. Lenovo cannot accept responsibility for any failure to satisfy the protection requirements resulting from a nonrecommended modification of the product, including the installation of option cards from other manufacturers.

This product has been tested and found to comply with the limits for Class B Information Technology Equipment according to European Standard EN 55022. The limits for Class B equipment were derived for typical residential environments to provide reasonable protection against interference with licensed communication devices.

EU Contact: Lenovo, Einsteinova 21, 851 01 Bratislava, Slovakia



### German Class B compliance statement

#### Deutschsprachiger EU Hinweis:

##### **Hinweis für Geräte der Klasse B EU-Richtlinie zur Elektromagnetischen Verträglichkeit**

Dieses Produkt entspricht den Schutzanforderungen der EU-Richtlinie 2004/108/EG (früher 89/336/EWG) zur Angleichung der Rechtsvorschriften über die elektromagnetische Verträglichkeit in den EU-Mitgliedsstaaten und hält die Grenzwerte der EN 55022 Klasse B ein.

Um dieses sicherzustellen, sind die Geräte wie in den Handbüchern beschrieben zu installieren und zu betreiben. Des Weiteren dürfen auch nur von der Lenovo empfohlene Kabel angeschlossen werden. Lenovo übernimmt keine Verantwortung für die Einhaltung der Schutzanforderungen, wenn das Produkt ohne Zustimmung der Lenovo verändert bzw. wenn Erweiterungskomponenten von Fremdherstellern ohne Empfehlung der Lenovo gesteckt/eingebaut werden.

#### Deutschland:

##### **Einhaltung des Gesetzes über die elektromagnetische Verträglichkeit von Betriebsmitteln**

Dieses Produkt entspricht dem „Gesetz über die elektromagnetische Verträglichkeit von Betriebsmitteln“ EMVG (früher „Gesetz über die elektromagnetische Verträglichkeit von Geräten“). Dies ist die Umsetzung der EU-Richtlinie 2004/108/EG (früher 89/336/EWG) in der Bundesrepublik Deutschland.

##### **Zulassungsbescheinigung laut dem Deutschen Gesetz über die elektromagnetische Verträglichkeit von Betriebsmitteln, EMVG vom 20. Juli 2007 (früher Gesetz über die elektromagnetische Verträglichkeit von Geräten), bzw. der EMV EG Richtlinie 2004/108/EC (früher 89/336/EWG), für Geräte der Klasse B.**

Dieses Gerät ist berechtigt, in Übereinstimmung mit dem Deutschen EMVG das EG-Konformitätszeichen - CE - zu führen. Verantwortlich für die Konformitätserklärung nach Paragraf 5 des EMVG ist die Lenovo (Deutschland) GmbH, Gropiusplatz 10, D-70563 Stuttgart.

Informationen in Hinsicht EMVG Paragraf 4 Abs. (1) 4:

**Das Gerät erfüllt die Schutzanforderungen nach EN 55024 und EN 55022 Klasse B.**

## Korea Class B compliance statement

B급 기기 (가정용 방송통신기자재)
이 기기는 가정용(B급) 전자파적합기기로서 주로 가정에서 사용하는 것을 목적으로 하며, 모든 지역에서 사용할 수 있습니다

## Japanese VCCI Class B statement

この装置は、クラスB情報技術装置です。この装置は、家庭環境で使用することを目的としていますが、この装置がラジオやテレビジョン受信機に近接して使用されると、受信障害を引き起こすことがあります。

取扱説明書に従って正しい取り扱いをして下さい。

VCCI-B

## Japan compliance statement for products which connect to the power mains with rated current less than or equal to 20 A per phase

日本の定格電流が 20A/相 以下の機器に対する高調波電流規制  
高調波電流規格 JIS C 61000-3-2 適合品

## Lenovo product service information for Taiwan

台灣 Lenovo 產品服務資訊如下：  
荷蘭商聯想股份有限公司台灣分公司  
台北市內湖區堤頂大道二段89號5樓  
服務電話：0800-000-702

---

## Eurasian compliance mark



Модели, относящиеся к настоящей серии (семейству) продуктов и впервые выпущенные в обращение до 14 февраля 2013 года, сертифицированы по требованиям Системы сертификации ГОСТ Р и/или по требованиям единой системы сертификации Таможенного Союза, действовавшим в момент сертификации, и маркируются знаком соответствия ГОСТ Р.

Модели, относящиеся к настоящей серии (семейству) продуктов и впервые выпущенные в обращение после 14 февраля 2013 года, сертифицированы в единой системе сертификации Таможенного Союза на соответствие требованиям применимых Технических Регламентов и маркируются знаком EAC.

---

## Brazil regulatory notice

Ouvir sons com mais de 85 decibéis por longos períodos pode provocar danos ao sistema auditivo.

---

## Mexico regulatory notice

**Advertencia:** En Mexico la operación de este equipo está sujeta a las siguientes dos condiciones: (1) es posible que este equipo o dispositivo no cause interferencia perjudicial y (2) este equipo o dispositivo debe aceptar cualquier interferencia, incluyendo la que pueda causar su operación no deseada.



---

## Appendix B. WEEE and recycling information

Lenovo encourages owners of information technology (IT) equipment to responsibly recycle their equipment when it is no longer needed. Lenovo offers a variety of programs and services to assist equipment owners in recycling their IT products. For information on recycling Lenovo products, go to:  
<http://www.lenovo.com/recycling>

---

### Important WEEE information

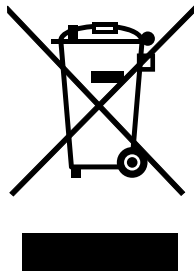

The WEEE marking on Lenovo products applies to countries with WEEE and e-waste regulations (for example, European Directive 2012/19/EU, India E-Waste Management & Handling Rules, 2011). Appliances are labeled in accordance with local regulations concerning waste electrical and electronic equipment (WEEE). These regulations determine the framework for the return and recycling of used appliances as applicable within each geography. This label is applied to various products to indicate that the product is not to be thrown away, but rather put in the established collective systems for reclaiming these end of life products.

Users of electrical and electronic equipment (EEE) with the WEEE marking must not dispose of end of life EEE as unsorted municipal waste, but use the collection framework available to them for the return, recycle, and recovery of WEEE and to minimize any potential effects of EEE on the environment and human health due to the presence of hazardous substances. For additional WEEE information go to:  
<http://www.lenovo.com/recycling>

---

### Recycling information for China

#### 《废弃电器电子产品回收处理管理条例》提示性说明

联想鼓励拥有联想品牌产品的用户当不再需要此类产品时，遵守国家废弃电器电子产品回收处理相关法律法规，将其交给当地具有国家认可的回收处理资质的厂商进行回收处理。更多回收服务信息，请点击进入

<http://support.lenovo.com.cn/activity/551.htm>

---

### Recycling information for Japan

#### Collecting and recycling a disused Lenovo computer or monitor

If you are a company employee and need to dispose of a Lenovo computer or monitor that is the property of the company, you must do so in accordance with the Law for Promotion of Effective Utilization of Resources. Computers and monitors are categorized as industrial waste and should be properly disposed of by an industrial waste disposal contractor certified by a local government. In accordance with the Law

for Promotion of Effective Utilization of Resources, Lenovo Japan provides, through its PC Collecting and Recycling Services, for the collecting, reuse, and recycling of disused computers and monitors. For details, visit the Lenovo Web site at <http://www.lenovo.com/recycling/japan>.

Pursuant to the Law for Promotion of Effective Utilization of Resources, the collecting and recycling of home-used computers and monitors by the manufacturer was begun on October 1, 2003. This service is provided free of charge for home-used computers sold after October 1, 2003. For details, go to <http://www.lenovo.com/recycling/japan>.

### **Disposing of Lenovo computer components**

Some Lenovo computer products sold in Japan may have components that contain heavy metals or other environmental sensitive substances. To properly dispose of disused components, such as a printed circuit board or drive, use the methods described above for collecting and recycling a disused computer or monitor.

### **Disposing of disused lithium batteries from Lenovo computers**

A button-shaped lithium battery is installed inside your Lenovo computer to provide power to the computer clock while the computer is off or disconnected from the main power source. If you need to replace it with a new one, contact your place of purchase or contact Lenovo for service. If you need to dispose of a disused lithium battery, insulate it with vinyl tape, contact your place of purchase or an industrial-waste-disposal operator, and follow their instructions.

Disposal of a lithium battery must comply with local ordinances and regulations.

### **Disposing of a disused battery pack from Lenovo notebook computers**

Your Lenovo notebook computer has a lithium ion battery pack or a nickel metal hydride battery pack. If you are a company employee who uses a Lenovo notebook computer and need to dispose of a battery pack, contact the proper person in Lenovo sales, service, or marketing, and follow that person's instructions. You also can refer to the instructions at <http://www.lenovo.com/jp/ja/environment/recycle/battery/>.

If you use a Lenovo notebook computer at home and need to dispose of a battery pack, you must comply with local ordinances and regulations. You also can refer to the instructions at <http://www.lenovo.com/jp/ja/environment/recycle/battery/>.

---

## **Recycling information for Brazil**

### **Declarações de Reciclagem no Brasil**

#### **Descarte de um Produto Lenovo Fora de Uso**

Equipamentos elétricos e eletrônicos não devem ser descartados em lixo comum, mas enviados à pontos de coleta, autorizados pelo fabricante do produto para que sejam encaminhados e processados por empresas especializadas no manuseio de resíduos industriais, devidamente certificadas pelos órgãos ambientais, de acordo com a legislação local.

A Lenovo possui um canal específico para auxiliá-lo no descarte desses produtos. Caso você possua um produto Lenovo em situação de descarte, ligue para o nosso SAC ou encaminhe um e-mail para: [reciclar@lenovo.com](mailto:reciclar@lenovo.com), informando o modelo, número de série e cidade, a fim de enviarmos as instruções para o correto descarte do seu produto Lenovo.



---

## Battery recycling information for Taiwan



廢電池請回收

---

## Battery recycling information for the United States and Canada



US & Canada Only

---

## Battery recycling information for the European Union

EU

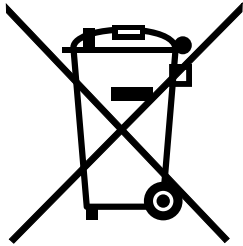

**Notice:** This mark applies only to countries within the European Union (EU).

Batteries or packaging for batteries are labeled in accordance with European Directive 2006/66/EC concerning batteries and accumulators and waste batteries and accumulators. The Directive determines the framework for the return and recycling of used batteries and accumulators as applicable throughout the European Union. This label is applied to various batteries to indicate that the battery is not to be thrown away, but rather reclaimed upon end of life per this Directive.

In accordance with the European Directive 2006/66/EC, batteries and accumulators are labeled to indicate that they are to be collected separately and recycled at end of life. The label on the battery may also include a chemical symbol for the metal concerned in the battery (Pb for lead, Hg for mercury, and Cd for cadmium). Users of batteries and accumulators must not dispose of batteries and accumulators as unsorted municipal waste, but use the collection framework available to customers for the return, recycling, and treatment of batteries and accumulators. Customer participation is important to minimize any potential effects of batteries and accumulators on the environment and human health due to the potential presence of hazardous substances. For proper collection and treatment, go to:  
<http://www.lenovo.com/recycling>

---

## China recycling information for Waste Electrical and Electronic Equipment (WEEE)

### 《废弃电器电子产品回收处理管理条例》提示性说明

联想鼓励拥有联想品牌产品的用户当不再需要此类产品时，遵守国家废弃电器电子产品回收处理相关法律法规，将其交给当地具有国家认可的回收处理资质的厂商进行回收处理。更多回收服务信息，请点击进入 <http://support.lenovo.com.cn/activity/551.htm>。

## Appendix C. Restriction of Hazardous Substances Directive (RoHS)

### European Union RoHS

Lenovo products sold in the European Union, on or after 3 January 2013 meet the requirements of Directive 2011/65/EU on the restriction of the use of certain hazardous substances in electrical and electronic equipment (“RoHS recast” or “RoHS 2”).

For more information about Lenovo progress on RoHS, go to:  
[http://www.lenovo.com/social\\_responsibility/us/en/RoHS\\_Communication.pdf](http://www.lenovo.com/social_responsibility/us/en/RoHS_Communication.pdf)

### China RoHS

产品中有毒有害物质或元素的名称及含量

部件名称	有毒有害物质或元素					
	铅(Pb)	汞(Hg)	镉(Cd)	六价铬 (Cr(VI))	多溴连苯 (PBB)	多溴二苯醚 (PBDE)
印刷电路板组件*	X	O	O	O	O	O
硬盘	X	O	O	O	O	O
光驱	X	O	O	O	O	O
内存	X	O	O	O	O	O
电脑I/O 附件	X	O	O	O	O	O
电源	X	O	O	O	O	O
键盘	X	O	O	O	O	O
鼠标	X	O	O	O	O	O
机箱/ 附件	X	O	O	O	O	O

○:表示该有毒有害物质在该部件所有均质材料中的含量均在SJ/T11363-2006标准规定的限量要求以下  
 ×:表示该有毒有害物质至少在该部件的某一均质材料中的含量超出SJ/T11363-2006标准规定的限量要求  
 表中标有“×”的所有部件都符合欧盟RoHS 法规。

印刷电路板组件\*: 包括印刷电路板及其零部件、电容和连接器  
 根据型号的不同, 可能不会含有以上的所有部件, 请以实际购买机型为准



在中华人民共和国境内销售的电子信息产品必须标识此标志, 标志内的数字代表在正常使用状态下的产品的环保使用期限

### Turkish RoHS

The Lenovo product meets the requirements of the Republic of Turkey Directive on the Restriction of the Use of Certain Hazardous Substances in Electrical and Electronic Equipment (EEE).

### **Търkiye EEE Үцнетmelipine Uygunluk Beyanэ**

Бу Lenovo ьгьль, Т.С. Зевре ve Orman Bakanлэре'nэн “Elektrik ve Elektronik Eюyalarda Bazэ Zararlэ Maddelerin Kullanэмэнэн Сэнэрlandэгэлмасэна Dair Үцнетmelik (EEE)” direktiflerine uygundur.

EEE Үцнетmelipine Uyгundur.

---

### **Ukraine RoHS**

Цим пiдтверджуємо, що продукцiя Леново вiдповiдає вимогам нормативних актiв України, якi обмежують вiмiст небезпечних речовин

---

### **India RoHS**

RoHS compliant as per E-Waste (Management & Handling) Rules, 2011.

---

## Appendix D. Notices

Lenovo might not offer the products, services, or features discussed in this document in all countries. Consult your local Lenovo representative for information on the products and services currently available in your area. Any reference to a Lenovo product, program, or service is not intended to state or imply that only that Lenovo product, program, or service might be used. Any functionally equivalent product, program, or service that does not infringe any Lenovo intellectual property right might be used instead. However, it is the user's responsibility to evaluate and verify the operation of any other product, program, or service.

Lenovo might have patents or pending patent applications covering subject matter described in this document. The furnishing of this document does not give you any license to these patents. You can send license inquiries, in writing, to:

*Lenovo (United States), Inc.  
1009 Think Place - Building One  
Morrisville, NC 27560  
U.S.A.  
Attention: Lenovo Director of Licensing*

LENOVO PROVIDES THIS PUBLICATION "AS IS" WITHOUT WARRANTY OF ANY KIND, EITHER EXPRESS OR IMPLIED, INCLUDING, BUT NOT LIMITED TO, THE IMPLIED WARRANTIES OF NON-INFRINGEMENT, MERCHANTABILITY OR FITNESS FOR A PARTICULAR PURPOSE. Some jurisdictions do not allow disclaimer of express or implied warranties in certain transactions, therefore, this statement might not apply to you.

This information could include technical inaccuracies or typographical errors. Changes are periodically made to the information herein; these changes will be incorporated in new editions of the publication. Lenovo might make improvements and/or changes in the product(s) and/or the program(s) described in this publication at any time without notice.

The products described in this document are not intended for use in implantation or other life support applications where malfunction might result in injury or death to persons. The information contained in this document does not affect or change Lenovo product specifications or warranties. Nothing in this document shall operate as an express or implied license or indemnity under the intellectual property rights of Lenovo or third parties. All information contained in this document was obtained in specific environments and is presented as an illustration. The result obtained in other operating environments might vary.

Lenovo might use or distribute any of the information you supply in any way it believes appropriate without incurring any obligation to you.

Any references in this publication to non-Lenovo Web sites are provided for convenience only and do not in any manner serve as an endorsement of those Web sites. The materials at those Web sites are not part of the materials for this Lenovo product, and use of those Web sites is at your own risk.

Any performance data contained herein was determined in a controlled environment. Therefore, the result obtained in other operating environments might vary significantly. Some measurements might have been made on development-level systems and there is no guarantee that these measurements will be the same on generally available systems. Furthermore, some measurements might have been estimated through extrapolation. Actual results might vary. Users of this document should verify the applicable data for their specific environment.

---

## Trademarks

The following terms are trademarks of Lenovo in the United States, other countries, or both:

- Lenovo
- Lenovo logo
- ThinkPad
- ThinkPad logo
- UltraConnect

Microsoft and Windows are trademarks of the Microsoft group of companies.

Intel and Intel Atom are trademarks of Intel Corporation in the U. S. and/or other countries.

Mini DisplayPort (mDP) is a trademark of the Video Electronics Standards Association.

iPhone is a trademark of Apple Inc., registered in the U.S. and other countries.

The terms HDMI and HDMI High-Definition Multimedia Interface are trademarks or registered trademarks of HDMI Licensing LLC in the United States and other countries.

Other company, product, and service names may be trademarks or service marks of others.



**ThinkPad®**