

# TETRA COMPUTER

## Rugged Mobile Solutions

designed for **HARSH** environments

# Tpad

**USER'S HANDBOOK**



**LOGIC INSTRUMENT**  
 URL: <http://www.logic-instrument.com>

**LOGIC INSTRUMENT S.A**  
 TEL: +33 (0) 1 34 28 61 61  
 FAX: +33 (0) 1 34 28 00 50  
 71 ROUTE DE SAINT-DENIS- BP116  
 95170 DEUIL LA BARRE  
 FRANCE  
 E-mail : [Sales@logic-instrument.com](mailto:Sales@logic-instrument.com)  
 URL: <http://www.tetra-computer.com>

**LOGIC INSTRUMENT (DEUTSCHLAND) GMBH**  
 TEL: +49 (0) 89 666 287-6  
 FAX: +49 (0) 89 666 287-87  
 WALLBERGSTRASSE 5  
 D-82024 TAUFKIRCHEN  
 DEUTSHLAND  
 E-mail : [Sales@logic-instrument.de](mailto:Sales@logic-instrument.de)  
 URL: <http://www.logic-instrument.de>

**LOGIC INSTRUMENT USA INC.**  
 TEL: +1 410-833-25-96  
 FAX: +1 410-833-29-76  
 BALTIMORE MARYLAND  
 3240 MURRAY RD  
 FINKSBURG, MD 21048 - USA  
 E-mail: [Sales@logic-instrument-us.com](mailto:Sales@logic-instrument-us.com)  
 URL: <http://www.logic-instrument-us.com>

TETRA<sup>®</sup> computer has made every effort to ensure the accuracy and completeness of this document; however, because ongoing development efforts are made to continually improve the capabilities of our products, we cannot guarantee the accuracy of the contents of this document. We disclaim liability for errors, omissions, or future changes herein.

Tetra and the Tetra logo are registered trademarks of Logic Instrument SA ; Tpad is a trademark of Logic Instrument SA

Bluetooth is a registered trademark of Bluetooth SIG, Inc.

Microsoft and Windows are registered trademarks of Microsoft Corporation.

All other brands, product names, company names, trademarks and service marks used herein are property of their respective companies.

Copyright © 2006 Logic Instrument SA All rights reserved. No part of this publication may be copied, reproduced, or translated, without the prior written consent of Logic Instrument. No part of this publication may be stored or transmitted in any electronic form without the prior consent of Logic Instrument. Any unauthorized use is a violation of copyright laws.

PN: \_\_\_\_\_

Edition: 3, July 2006

DECLARATION OF CONFORMITY according to FCC Part 15

Responsible Party Name: Logic Instrument Address: 71 Route de Saint-Denis,  
BP 116, 95170, DEUIL LA BARRE, France  
Telephone: +33 1 34 28 61 61

Declares that product: Model Series: Tpad complies with Part 15 of the FCC Rules

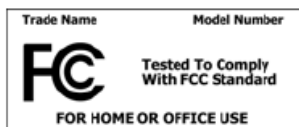

This device complies with Part 15 of the FCC rules. Operation is subject to the following two conditions: (1) This device may not cause harmful interference, and, (2) This device must accept any interference received, including interference that may cause undesired operation.

**WARNING**

Changes or modifications to this unit not expressly approved by the party responsible for compliance may void the user's authority to operate this equipment.



**Before you use the Tpad, read these safety instructions and the operation instructions in this handbook.**

**Failure to observe all these instructions voids the Limited Warranty and may lead to suspension or denial of services to the offender, or legal action, or both.**

Follow any special regulations governing the use of the Tpad and, if radioenabled, always switch it off in areas where radio devices are forbidden or when the radio device can cause interference or danger.

Always follow any safety laws and regulations pertaining to the use of cell phones and two-way radios, because these laws and regulations typically apply to the use of the Bluetooth Tpad.

Observe all restrictions on the use of radio equipment in fuel depots (fuel storage and distribution areas), chemical plants, and wherever blasting operations are in progress or in any area in which restrictions on radio transmissions are imposed.

Switch off the Tpad when in an aircraft. The Tpad is not FAA-approved for use on aircraft. The effect of the use of the Tpad in aircraft is unknown. Using the Tpad in an aircraft may affect aircraft instrumentation, communication, and performance; may disrupt the network; and may be illegal.

Radio signals from your Tpad will not affect the operation of most modern equipment, but certain electronic equipment, including automotive systems, may not be shielded against radio signals from your Tpad. Check with the manufacturer of your motor vehicle or the manufacturer's representative to determine whether using the Tpad will present any safety issues.

Avoid using the Tpad in any environment that requires your full attention, such as when driving a vehicle. If you need to use your Tpad while driving, have a passenger use it for you or find a safe location to halt your vehicle.



**WARNING**

Use only battery types specified in this handbook. Using any other type of battery can be dangerous and can disable the Tpad.



**WARNING**

Do not use any dock or any other accessory or attachment that is not manufactured or supplied by TETRA computer or an authorized Tetra accessories supplier. Use of any accessory or attachment that is not supplied or approved for use with the Tpad by TETRA computer is not permitted because it may cause hazards.

Operate the Tpad only from the type of power source indicated on the marking label. Route power supply cords so that they are not likely to be walked on or pinched by items placed upon or against them.

Pay particular attention to cords at plugs and convenience receptacles, and at the point where cords exit from the Tpad or its docking station.

Do not overload wall outlets, extension cords, or integral convenience receptacles because this can cause fire or electric shock.

Unplug the Tpad and refer the Tpad and docking station for service to qualified service personnel if any of the following conditions occur:

- The power supply cord or plug is damaged.
- The Tpad or docking station does not operate normally when you follow the instructions in this book.
- The Tpad or docking station exhibits a distinct change in performance.

Adjust only controls for which there are instructions in this book. An improper adjustment of other controls can result in damage and may require extensive work by a qualified technician to restore the Tpad or docking station to normal operation

**CAUTION**

Avoid prolonged physical contact with the exposed metal surfaces on the front and back of the Tpad. While the Tpad may not feel hot to the touch, if you maintain physical contact with the Tpad for a long time, your skin may suffer low-heat injury. In addition, be careful when you remove a PC card that has been used for a long time, because the card may be hot.



# Contents

---

|          |  |           |
|----------|--|-----------|
|          | <b>Welcome</b>                                 | <b>11</b> |
|          | ABOUT THE TPAD                                 | 12        |
|          | PACKAGE CONTENTS                               | 13        |
|          | QUICK CHECK                                    | 13        |
|          | OPTIONAL ACCESSORIES                           | 14        |
|          | CONTACTING LOGIC INSTRUMENT                    | 17        |
| <b>1</b> | <b>Getting Started</b>                         | <b>19</b> |
|          | GETTING TO KNOW THE TPAD                       | 20        |
|          | FEATURES AND CONTROLS                          | 20        |
|          | FRONT VIEW                                     | 20        |
|          | STATUS INDICATOR                               | 22        |
|          | BACK VIEW                                      | 24        |
|          | SIDE VIEW                                      | 25        |
|          | OPERATING ENVIRONMENT AND RUGGEDNESS           | 26        |
| <b>2</b> | <b>Using the Tpad</b>                          | <b>27</b> |
|          | TURNING ON AND OF THE TPAD                     | 27        |
|          | USING THE STYLUS                               | 28        |
|          | TO GET THE BEST RESULTS WHEN USING YOUR STYLUS | 28        |
|          | VIRTUAL KEYBOARD                               | 29        |
|          | TRANSCRIBER                                    | 29        |
|          | START PROGRAMS                                 | 30        |
|          | CALIBRATE THE TOUCH SCREEN                     | 30        |
|          | SETTING LCD BRIGHTNESS                         | 30        |
|          | DISABLING AUTOMATIC BACKLIGHT CONTROL          | 30        |
|          | SETTING POWER                                  | 31        |
|          | ADJUST VOLUME                                  | 31        |
|          | USING THE CURSOR CONTROL BUTTON                | 32        |
|          | USING THE FUNCTION KEYS                        | 33        |
|          | SET YOUR OWN BUTTONS FUNCTIONS                 | 34        |
|          | USING THE DOCKING STATION                      | 35        |
|          | DOCKING THE TPAD                               | 36        |
|          | UNDOCKING THE TPAD                             | 37        |
|          | MOUNTING THE DOCKING CRADLE ON THE WALL        | 38        |
|          | USING THE DESK STAND                           | 39        |

---

|   |    |
|---|----|
| CONNECTING DEVICES                          | 40 |
| DOCKING CRADLE EXPANSION                    | 41 |
| ACTIVATING THE EXTERNAL MONITOR             | 41 |
| ACTIVESYNC                                  | 42 |
| REMOTE DISPLAY CONTROL                      | 43 |
| BACKUP DATA                                 | 44 |
| RESTORE DATA                                | 45 |
| CHARGING THE TPAD BATTERY                   | 46 |
| CHARGING THE BATTERY IN THE DESK STAND      | 46 |
| CHARGING THE BATTERY OUTSIDE THE DESK STAND | 47 |
| INSTALLING MEMORY OR MULTIMEDIA CARDS       | 48 |

---

### **3 Using the Bluetooth 50**

|                   |    |
|-------------------|----|
| GENERAL FEATURE   | 50 |
| INSTALLATION      | 50 |
| BLUETOOTH MANAGER | 50 |
| PERIPHERAL SEARCH | 51 |

---

### **5 Troubleshooting and FAQ 56**

|     |  |    |
|-----|--|----|
|     | Combination KEY table ( Function key)                        | 57 |
| 1-  | How could we have a larger virtual keyboard?                 | 57 |
| 2-  | How to Calibrate the touchscreen                             | 57 |
| 3-  | How to display a presentation on PC monitor                  | 58 |
| 4-  | Could we connect the TPad and/or Cradle directly to vehicle? | 58 |
| 5-  | What are the Compact Flash Cards available?                  | 58 |
| 6-  | Could we use Bluetooth printer?                              | 59 |
| 7-  | Alphanumeric keys and joystick life?                         | 59 |
| 8-  | How To Extend Your PDA's Battery Life                        | 59 |
| 9-  | How long does it take to charge the battery                  | 59 |
| 10- | RMA Service  | 60 |
| 11- | Cleaning & Maintenance                                       | 61 |



|          |                                   |           |
|----------|-----------------------------------|-----------|
| <b>6</b> | <b>Specification</b>              | <b>62</b> |
|          | CPU                               | 62        |
|          | MEMORY                            | 62        |
|          | DISPLAY                           | 62        |
|          | TOUCH SCREEN                      | 62        |
|          | I/O PORTS                         | 62        |
|          | SYSTEM UNIT DIMENSIONS AND WEIGHT | 63        |
|          | AC ADAPTER                        | 63        |
|          | BATTERY                           | 63        |
|          | ENVIRONMENTAL RATINGS             | 63        |
| <b>A</b> | <b>Glossary</b>                   | <b>65</b> |



# Welcome

---

Welcome to the TETRA computer Technologies® Tpad™, the rugged, multipurpose handheld device designed, tested, and manufactured to meet the environmental and physical real-world challenges faced by today's mobile workers. The Tpad not only works the way you do, but can also take the abuses of everyday wear and tear.

Advanced technology and an innovative, rugged design provide true mobility in harsh operating conditions. Equally important is Logic Instrument's commitment to ensuring that you are treated with the same respect and honesty you offer to your customers and peers every day.



## About the Tpad

---

The Tpad is a high-performance, handheld personal digital assistant (PDA) that runs on the Microsoft® Windows® CE. NET operating system.

Your Tpad includes the following features:

- Small and light-weight ergonomic design for true mobility
- Ruggedized for portable and mobile applications in harsh operating environments
- High-performance Intel processor
- High-resolution, daylight-readable, full-color VGA LCD display with integrated touchscreen
- Open architecture for support of multiple internal and external expansion options
- Compact Flash slot and extra features options
- Extended operating time provided by user-replaceable, high capacity lithium-ion battery pack
- Versatile docking station with optional battery charger for desktop, wall, and mobile applications
- Integrated bluetooth

---

## Package contents

---

### Quick check

Check to make sure your package includes the following items:

- Base Unit and Battery Pack

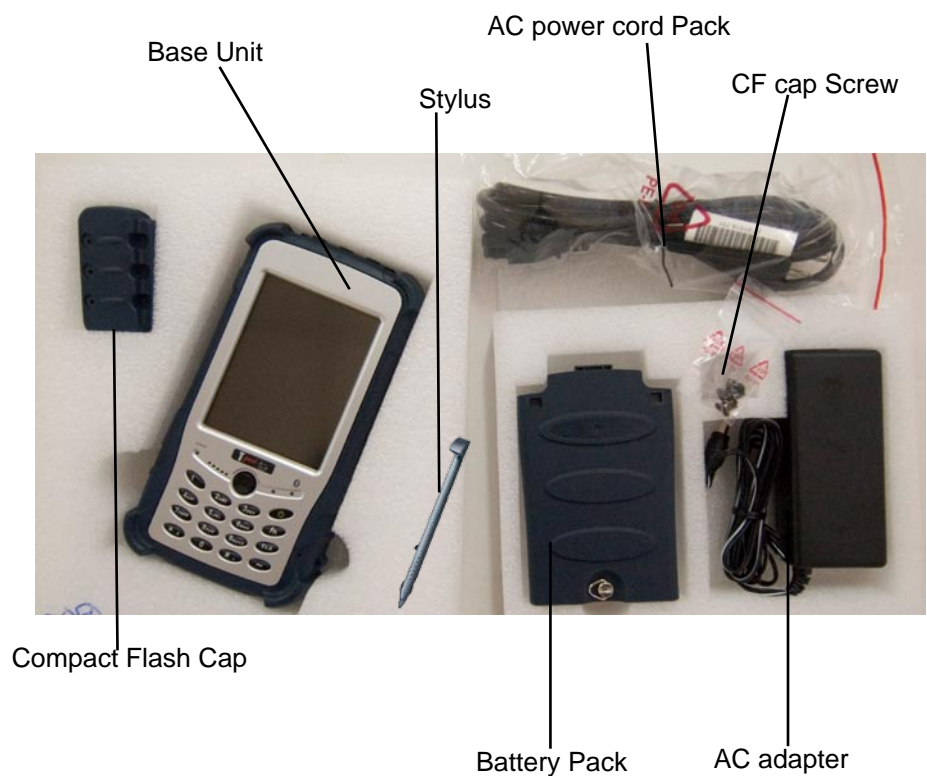

- Install the battery and then plug in the adapter to handheld device.
- Attach the AC adapter to AC outlet. The adapter LED indicates the power is ready. Charge LED will light up till the battery is full. Charging time will be about 2 hours.
- Press the power button momentarily to turn on this device.
- Follow up the instruction on screen to finish the basic setting.
- Press power button momentarily to turn OFF

## Optional accessories

---

- Docking station

Desk stand

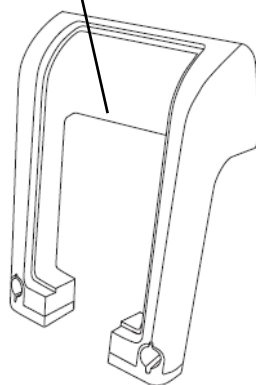

Docking cradle

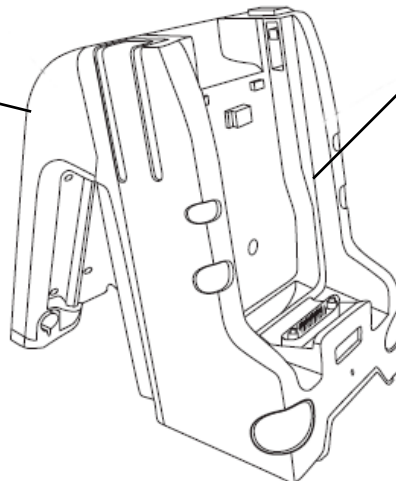

Data sync cable (USB)



- Battery charger

Battery charger

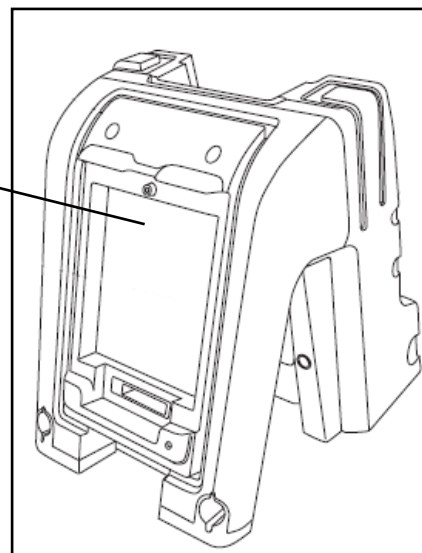

- Quick Start Guide
- This handbook

Your package also includes any optional accessories you ordered.

- Power adapter
- Secure Data (SD) card
- MultiMedia (MMC) card
  
- Handstrap/carrying case
- Stylus
- Expansion modules
- Battery charger
- Universal Compact Flash cover

---



---

## Contacting Logic Instrument

---

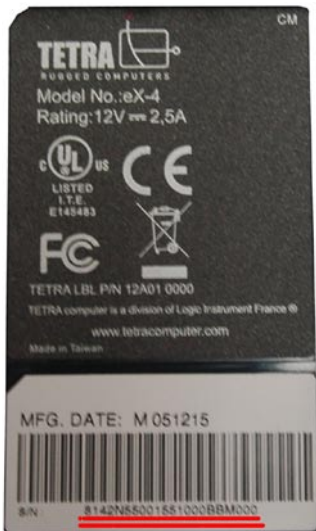

The serial number is on the back of the Tpad

If you purchased your Tpad from an authorized TETRA computer dealer, contact the dealer for service and support.

If you purchased your Tpad directly from Logic Instrument, use any of the following methods to contact Logic Instrument for service and support:

Tel +33-1-34286161

Fax +33-1-34286150

E-mail [techsupport@logic-instrument.com](mailto:techsupport@logic-instrument.com)

Web site <http://www.tetracomputer.com>

Before you contact Logic Instrument, have the following information ready so that the customer support representative can quickly provide a solution:

- Product name: Tpad
- Product serial number
- Purchase date
- Conditions under which the problem occurred
- Any error messages that were displayed
- Type of device connected, if any



# 1 Getting Started

---

This chapter provides basic information about your Tpad.



## Getting to Know The T pad

For more information about each component, see Chapter 2. This section shows the locations of some of the Tpad's important components.

### Features and controls

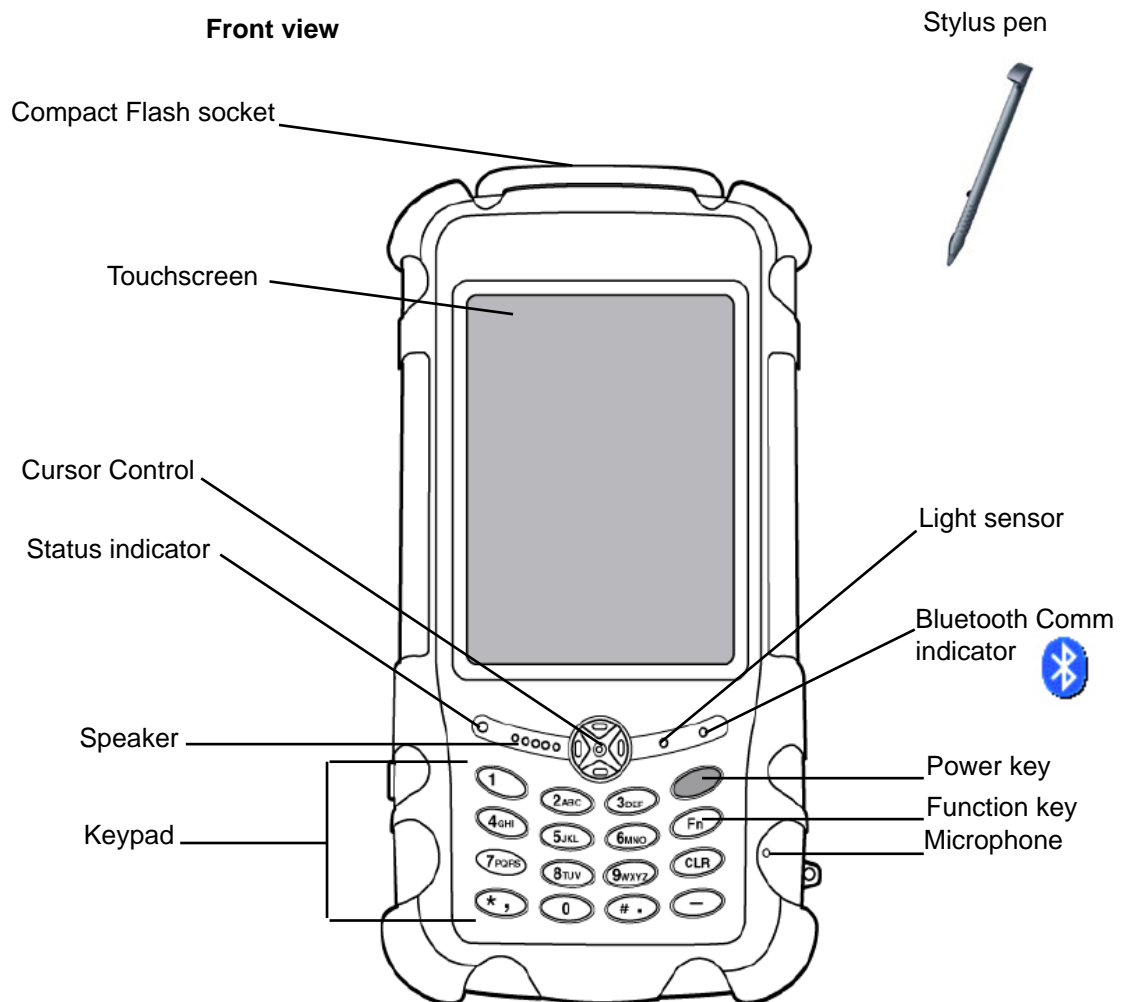

| <b>Feature</b>        | <b>Function</b>  |
|-----------------------|--|
| Compact Flash socket  | Enables you to use a compact flash card.   |
| Touchscreen           | Enables you to use your finger or a stylus to enter data and control applications.               |
| Cursor Control button | Lets you move the cursor up, down, left, and right. Also performs the functions of an Enter key. |
| Status indicator      | Indicates system mode and charge status. (See page 16.)  |
| Speaker               | Provides mono audio output.  |
| Keypad                | Provides alphanumeric keys you press to enter data.  |
| Photo sensor          | Automatically optimizes the LCD backlight.   |
| Comm indicator        | Indicates Bluetooth® activity.   |
| Power key             | Turns the Tpad on and off.   |
| Microphone            | Enables you to input mono audio.   |
| Stylus pen            | Enables you to enter data and control applications directly on the touchscreen.                  |

**Status indicator**

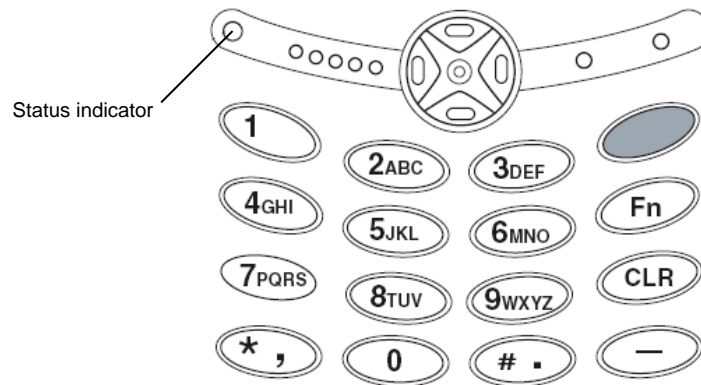

The following table shows the meanings of the Status indicator light

| System Mode | Battery Power | External Power  |              | Fault        |             |
|-------------|---------------|-----------------|--------------|--------------|-------------|
|             |               | Charging        | Not Charging | Low Battery  | Temperature |
| Run/Idle    | Solid green   | Flashing green  | Solid green  | Flashing red | Solid red   |
| Standby     | Solid orange  | Flashing orange | Solid orange | Flashing red | Solid red   |
| Suspend     | Off           | Off             | Off          | Off          | Off         |

**Back view**

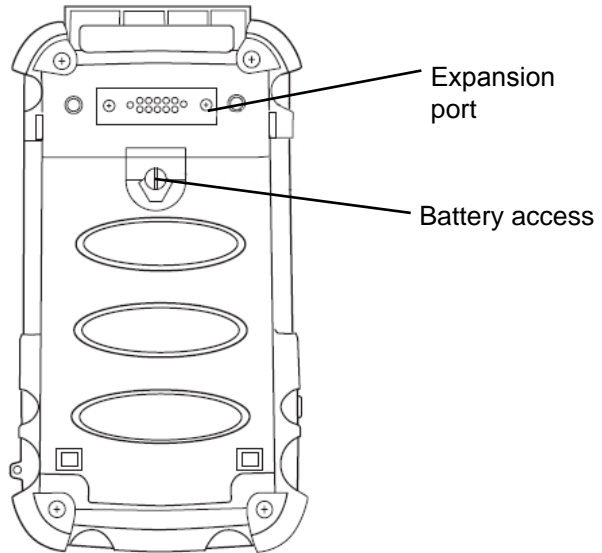

| <b>Feature</b> | <b>Function</b>   |
|----------------|---|
| Expansion port | Available for expansion module  |
| Battery access | Provides access to the replaceable battery. turn clockwise to dismount battery module |

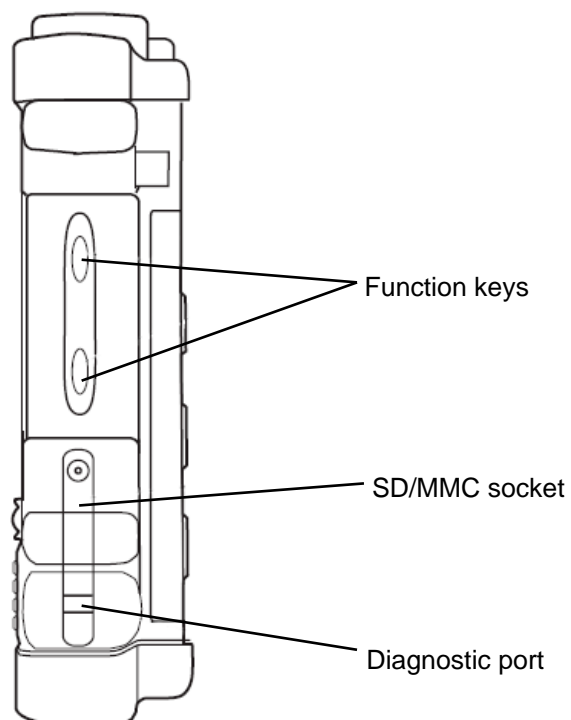
**Side view**

| <b>Feature</b>                              | <b>Function</b>   |
|---|---|
| Function keys                               | Shortcut to access pre-programmed application.  |
| Secure Data/MultiMedia Card (SD/MMC) socket | Supports memory cards and multimedia cards (16 MB to 2 GB).   |
| Diagnostic port                             | For use by technicians only.<br>1 x UART convertible to RS232 with adapter provided by logic instrument |



## Operating Environment and Ruggedness

---

This section contains instructions to provide appropriate protection for using your Tpad.

A clean and moisture-free environment is preferred.

If it is necessary to work in a hostile environment, please make sure all ports are well protected from dust, moisture, or water.

Proper isolation from extreme hazardous exposure is recommended. The handheld device is designed with rugged features of vibration, shock, dust, and rain/water protection. However, it is still necessary to provide appropriate protection while exposing to harsh environments.

All connectors will decay or corrode if exposed to water or moisture.

Corrosion is accelerated if the power is ON.

Please take proper water-resistant measures for cable connections.

All port caps should be in place when no cable is attached.

Regularly maintain the computer by cleaning dust, water, etc. will help keeping it in optimal condition.



There is no isolated compartment in SD slot. These ports must be tightly sealed while working with dust/water.

## 2 Using the Tpad

---

This chapter contains instructions for using your Tpad.

### Turning on and off the Tpad

---

1. Make sure the Tpad is off.

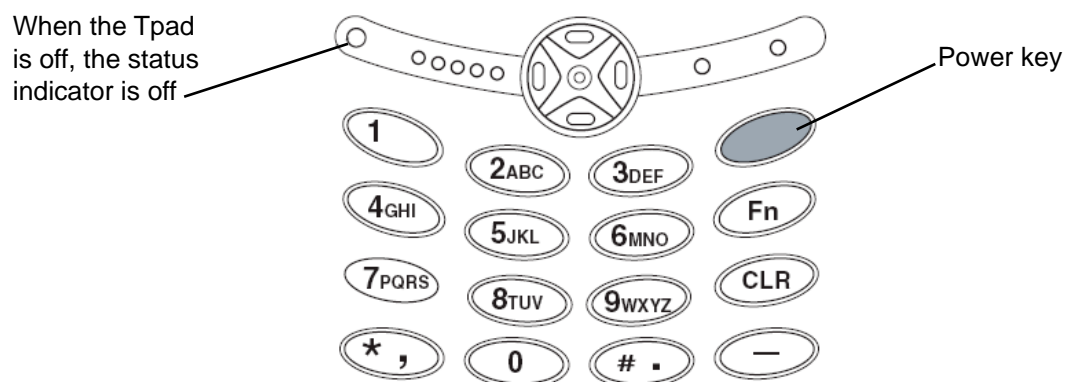

2. Make sure the battery is charged or that the Tpad is plugged in to an external power source.
3. Press the Power key to run the Tpad.
4. Press the Power key to switch to suspend mode.

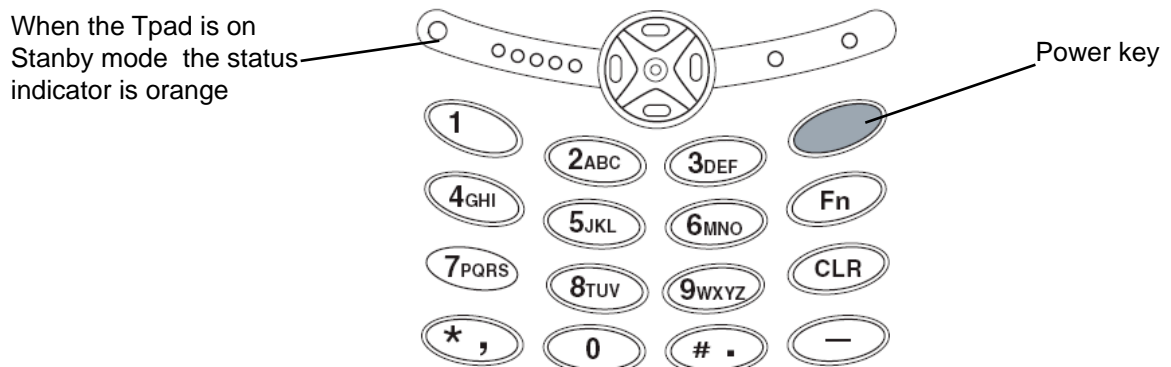

## Using the stylus

Stylus compartment



Use the stylus supplied by Logic instrument with the Tpad since it has been designed with a non-abrasive material that neither scratches nor deteriorates the touch screen.

Use the stylus to type with the on-screen keyboard, write on the writing pad, and navigate by pointing and tapping.



- Double-tap on a folder to open it.
- To move a file to a folder, touch the file with your stylus and drag it to the folder.
- To navigate in a window, slide your Stylus/Pen on the Navigation Bar or Click the Navigation Arrows

## To get the best results when using your stylus



- Do not rest your hand on the Touchscreen. The screen is sensitive to touch; pressure from your hand prevents your Display from functioning properly.
- Hold the stylus perpendicular to the touchscreen.
- Press and tap firmly when using the stylus. The screen is designed to handle the stress of tapping and dragging with the stylus.
- Keep the stylus smooth and clean.
- Realign the screen and reset the double-tap speed if the touch screen stops responding to your stylus taps. (Tap the mouse icon  on the control panel Display.)
- Never use a pen, pencil, or other object in place of your stylus. Such objects can damage your touchscreen.

## Virtual Keyboard

By clicking the Keyboard icon at the bottom right of the Task Bar, the Virtual Keyboard will appear.  The Virtual Keyboard may also appear automatically in data entry fields image  
Select Hide Input Panel to disengage the Virtual keyboard



### Standard Keyboard

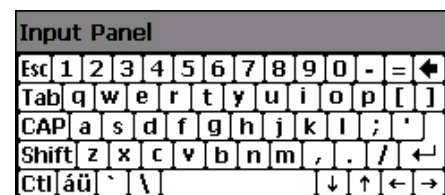

### Extended Language keyboard

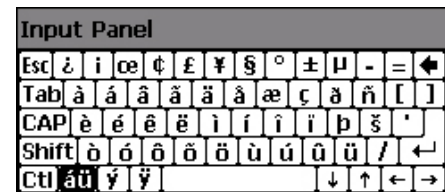

Pressing  toggles between the Standard Keyboard and the Extended Language keyboard

NOTE: Press the Shift key to access additional characters.

## Transcriber

Transcriber  lets you take down a phone number, take notes and more, just as easily and naturally as writing on a piece of paper.

Transcriber recognizes all handwriting, be it cursive, printed or a combination of both.

To work correctly some setting should be set.

To know how Transcriber works, select the Transcriber option and click the Help button.



## Start programs

Tap Start  ➔ Programs ➔ desired programs

## Calibrate the Touch Screen

Tap Start  ➔ Settings ➔ Control Panel ➔ Stylus ➔ calibration. and tap recalibrate

Use pen to touch the center of mark " + " and repeat the action when the mark " + " moves.  
Tap the enter button to confirm when finished.

This function can also be launch by pressing Fn and 2 then click Calibration and Recalibrate

## Setting LCD brightness Touch Screen

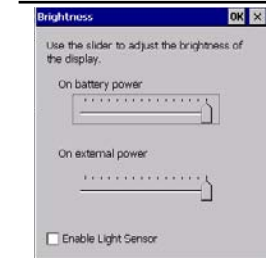

To dim / increase the brightness of the LCD backlight:



Enter brightness menu in the control panel options to adjust the brightness level as desire.

Setting backlight timeout:



Enter display menu in the control panel options and select the backlight tab to adjust the timeout period as desired.

Timeout is the idle time that the LCD backlight would turn OFF automatically.

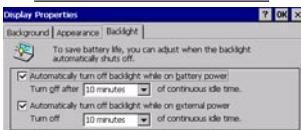

## Disabling automatic backlight control

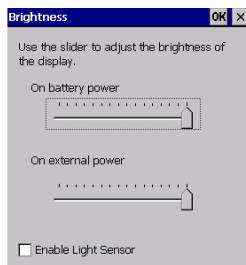

When the ambient light sensor is enabled, the Tpad automatically controls the amount of backlight sent to the screen to provide optimum brightness for the lighting conditions in which you are working.

To disable / enable automatic backlight control

Enter brightness menu in the control panel options to disable / enable the backlight sensor.

## Setting power

Enter Power menu  in the control panel options to adjust the idle time to switch to suspend mode.

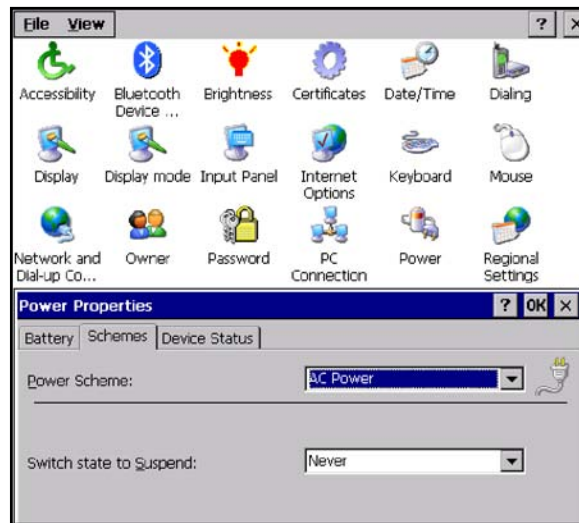

Select desired timeout configuration.

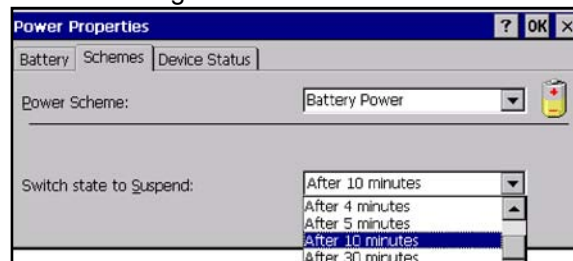

## Adjust volume

Enter Volume and Sounds menu  in the control panel options to adjust the volume level as desired.

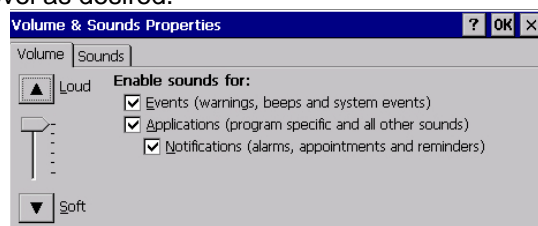

## Using the Cursor Control button

---

Press the edge of the Cursor Control button to move the cursor:

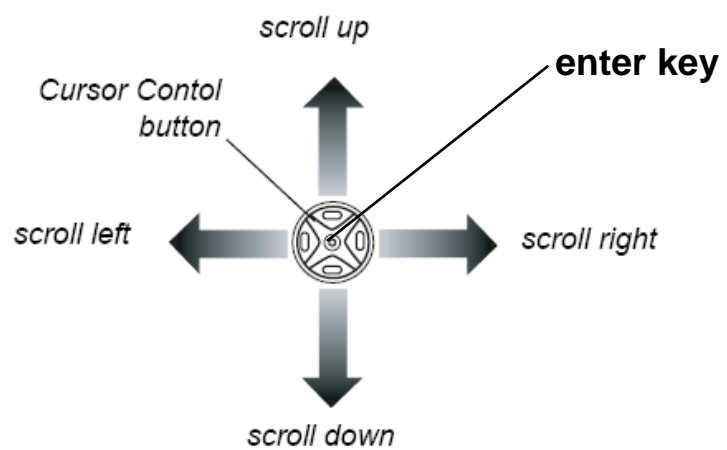

## Using the function keys

---

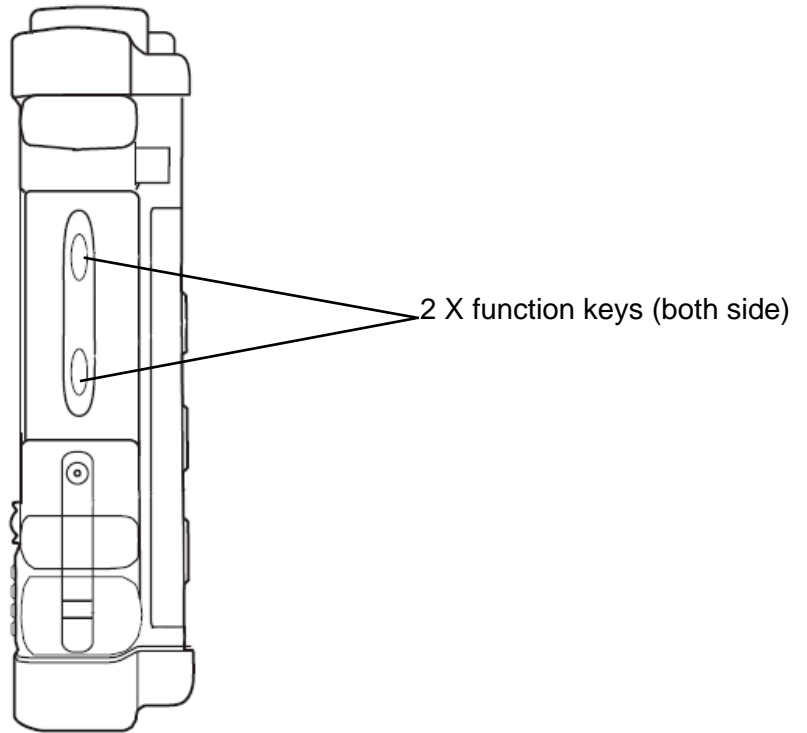





## Set your own buttons functions

---

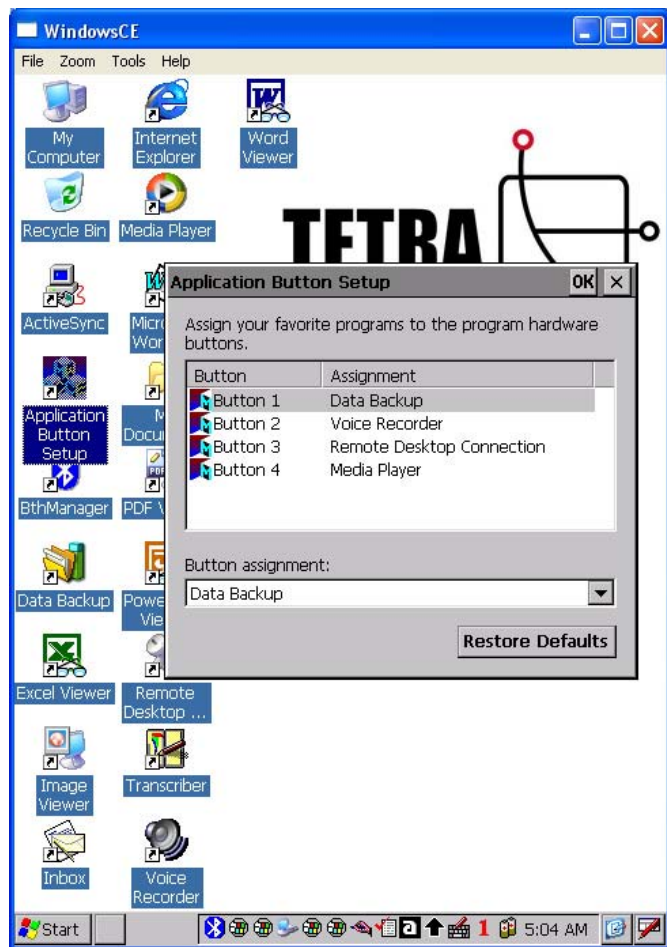
The four buttons functions at the side of the Tpad are user-definable.



Use the application button setup on Tpad desktop  
or tap  ➔ programs ➔ Application button setup   
➔ Define the button functions as you want from the selection list. Other buttons are not user-programmable.

## Using the docking station

---

The TPAD docking station is a modular and multipurpose platform intended for desktop, wall or mobile applications. The docking station concept is shown in the figure below and consists of a docking cradle, battery charger, and application specific mounting adapters.

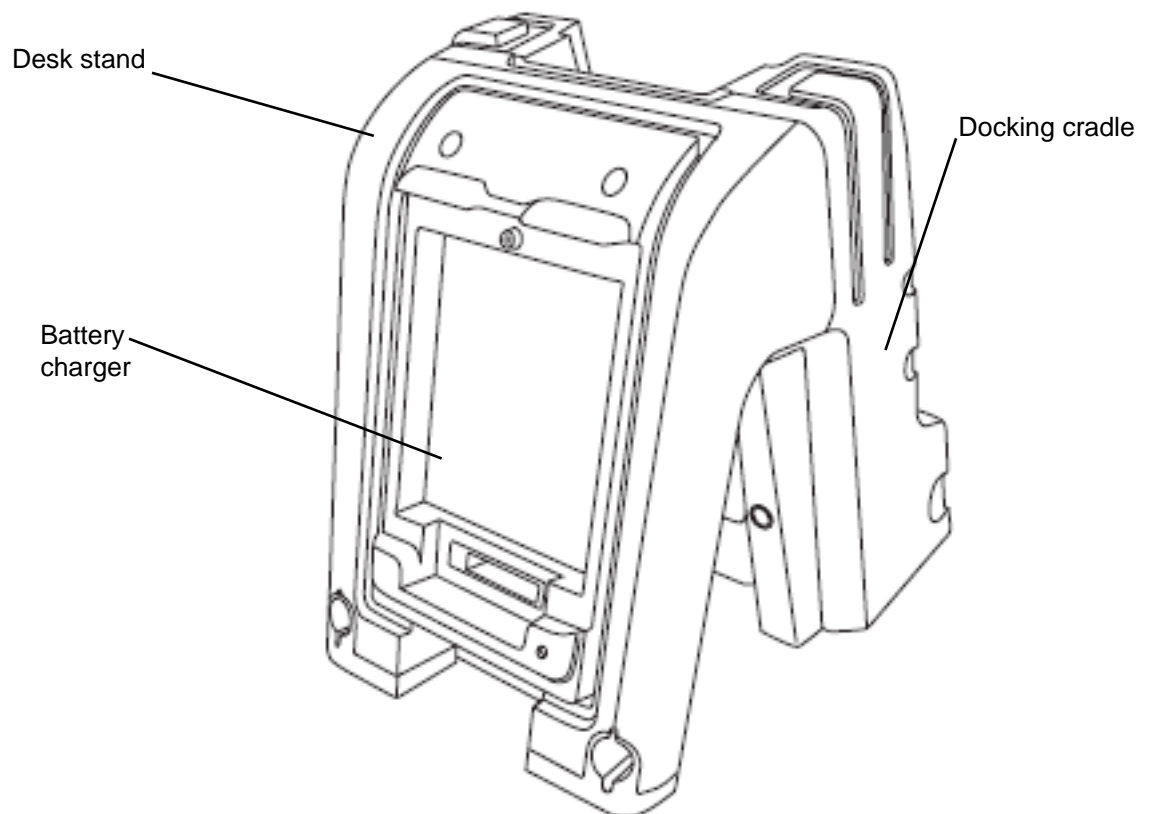

The docking cradle and battery charger are both stand-alone devices that may be used independently of one another with individual mounting adapters for wall or mobile applications or in conjunction with one another using a passive desktop mounting platform.

### Docking the Tpad

---

Align the Tpad into the docking cradle connectors and firmly push the computer down and then push forward to engage the docking connector until the locking pins click.

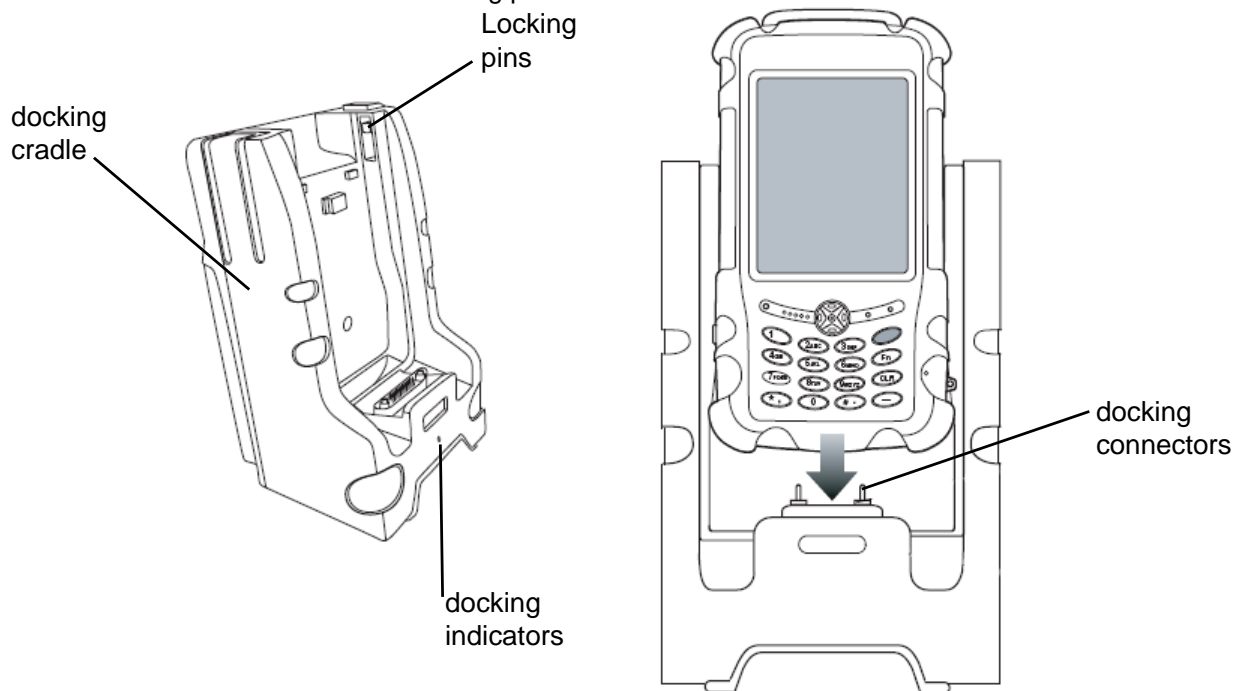

Solid green = power + Tpad docked  
Flashing green = Power + Tpad not docked

Align the computer with cradle docking connector

---

### Undocking the Tpad

---

Push the Eject button; then pull the Tpad up and away from the cradle.

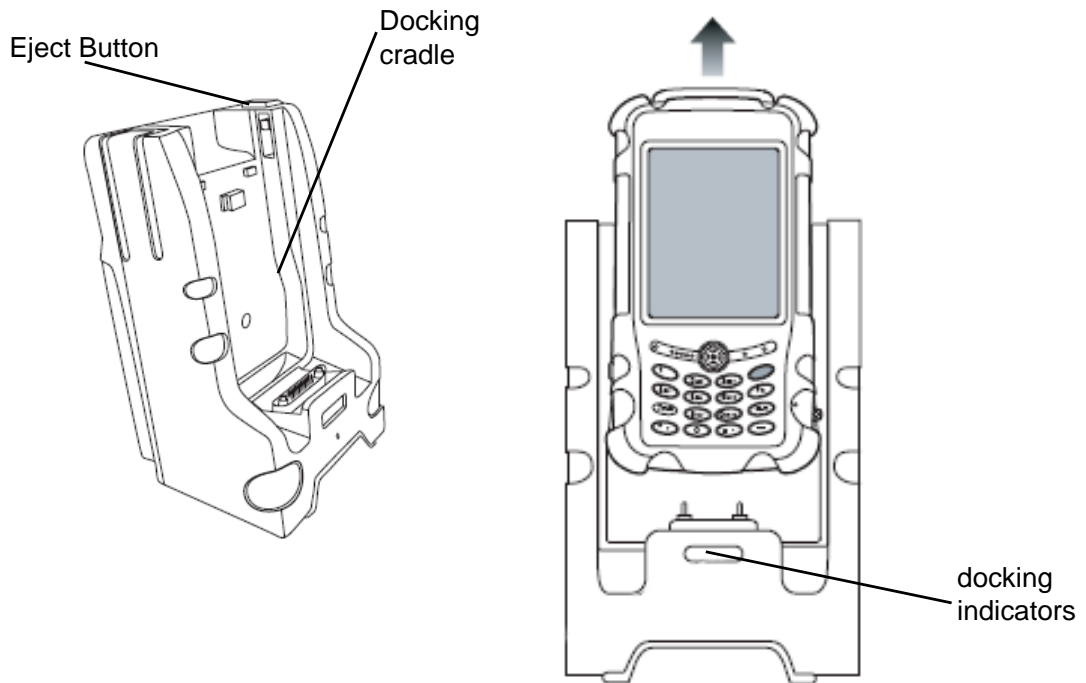

### Mounting the docking cradle on the wall

---

1. Mark the location for one of the keyhole slots on the wall; then measure the distance to the other keyhole and mark that location.

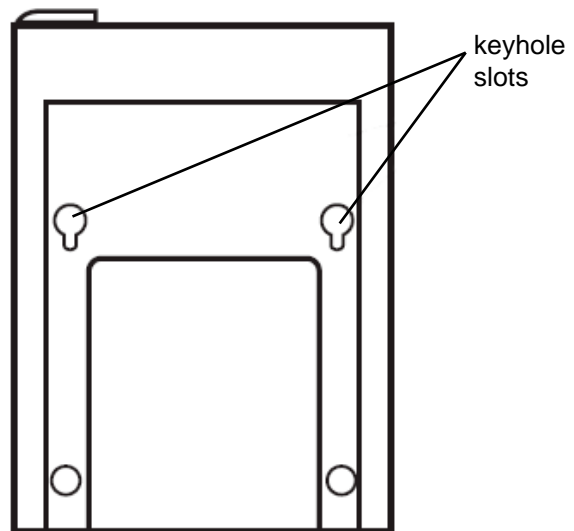

2. Screw the mounting screws into the wall at the locations you marked.
3. Mount the docking cradle on the two screws.

### Using the desk stand

---

The desk stand attaches to the back of the docking cradle provides a stable platform for the Tpad.

Snap the desk stand to the back of the docking cradle as shown in the illustration.

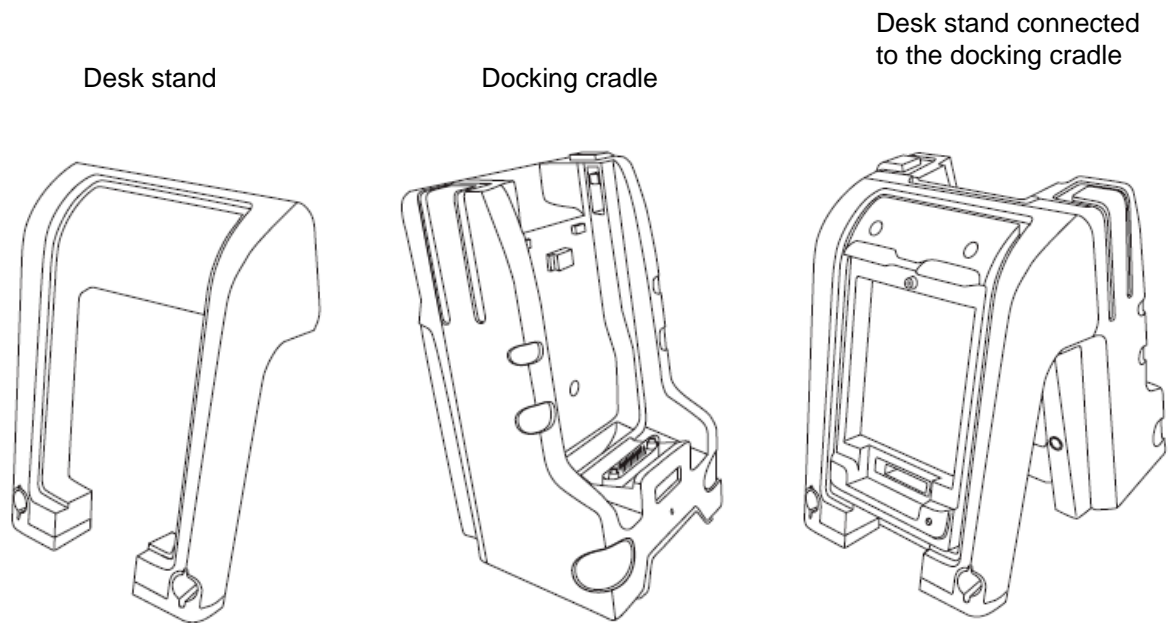

## Connecting devices

---

Refer to the following subsections for information about connecting external devices to your Tpad.

---

## Docking Cradle expansion

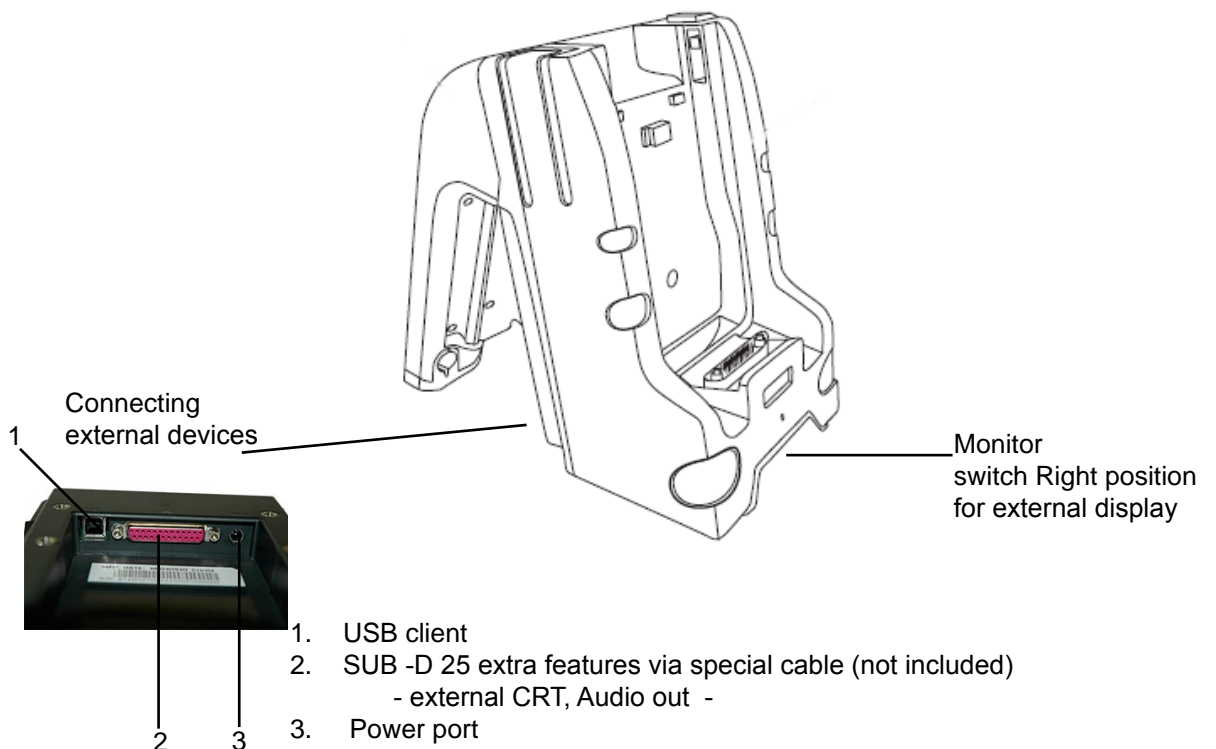

## Activating the monitor or projection panel

After you connect the external monitor to the Video port on the PRM (cable not included) slide the External Monitor switch to the right position as shown in the illustration above.  
Contact your local help desk or TETRA computer reseller.

### **Note**

When activating external display switch (left or right) the handheld device reset automatically.  
make sure to back up your data.



## ActiveSync

---

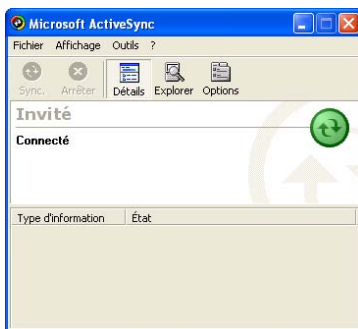

You may transmit/receive data between this handheld computer and other computers via ActiveSync.

Install Microsoft ActiveSync 3.8 or above on host computer.

Connect handheld computer and host computer with the USB cable. Follow the prompt to execute data sync. Perform Copy, Paste, Cut, Delete, etc. same as PC.

Make sure you have administrative rights on the desktop PC before installing or re-installing ActiveSync. Do not connect the Tpad to the desktop PC until after you have completed installing Microsoft ActiveSync.

The latest version of Microsoft ActiveSync can be obtained from the following website - <http://www.microsoft.com/windowsmobile/default.msp>

Microsoft ActiveSync version 3.8 or higher is required to connect to the computer.

## Remote display control

With the Remote Display Control application, you can display actions, including user input, remotely on the display of a desktop computer.

Remote Display Control uses TCP/IP, and it can work with ActiveSync® connections via USB client.

download remote display control : <http://www.microsoft.com/technet/prodtechnol/wce/downloads/ppctoys.msp>

The software is installed automatically C:\Program Files\Remote Display Control\cerhost.exe. We recommend creating a shortcut on the desktop.

- Software Utilisation:

You could find a user guide under C:\Program Files\Remote Display Control\readme.txt.

Three steps are necessary:

- Connect the peripheral (on) to the PC. Please check that ActiveSync detect the connexion.
- On the PC launch Remote Display Control (cerhost.exe)
- On the TPad execute \Windows\cerdisp.exe, click on Connect, use default parameter (PPP\_PEER), and click Ok. 

All data displayed on the TPad are immediately visible on the PC monitor. We could zoom this window.

Consequently, if a retro projector is connected to the PC; whole assistance could see the displayed data on the TPad.

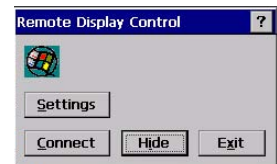
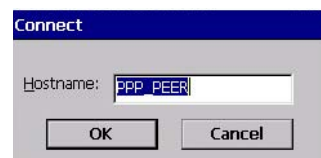

## Backup Data

There are two types memory on the computer: Temporary memory RAM (Random Access Memory) and permanent memory ROM (Read Only Memory).

Most data of ongoing program are stored in RAM. It would stay intact when power turns OFF. (Actually pressing power button OFF/ON is "suspend/resume" only.

Part of the PDA is still running, power supply to memory is always ON.) However, data or program in RAM will be lost when hardware reset. And if primary battery been removed for too long time (for example, swap battery for > 1 hours), there are risks to lose RAM data as back up battery may run exhausted.

Long time storage will drain primary and backup battery to exhaust thus unable to keep memory data.

To avoid data loss you may move data into ROM or memory card as follows:

1. Select Data Backup program on the desktop or tap start / programs / data backup.
2. select the way you want to backup data / inbox / file / folders
3. then select Scheduled.... tab to automatically backup data and tick the box enable Scheduled Backup



Enable scheduled backup

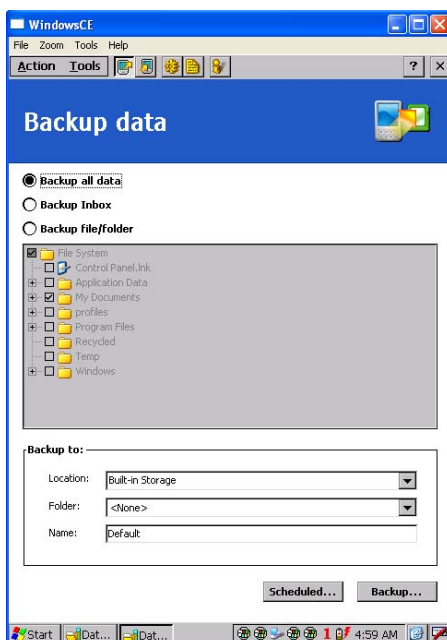

you can protect your settings with password encryption

1. select the TOOLS tabs in the data backup main page
2. select options
3. Tick the box Encrypt backup file

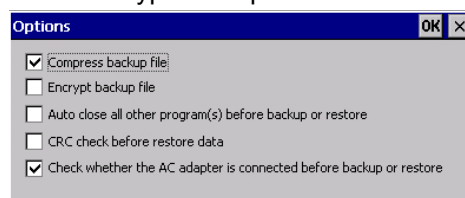

4. Select Backup... tab   then choose a password and confirm

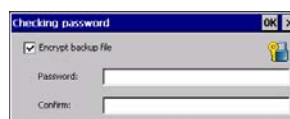

## Restore Data

To restore Data follow those step :

1. select the Action tab and the select Restore



2. select desired files / folders you want to restore and enter password if you activated this option

## Charging the Tpad battery

---

You can charge the Tpad battery directly with the AC/DC adapter, or you can connect the battery directly to the battery charger when the Tpad is not in the desk stand.

### Using the desk stand

---

Charging the battery in the desk stand

1. Place the battery in the battery charger.

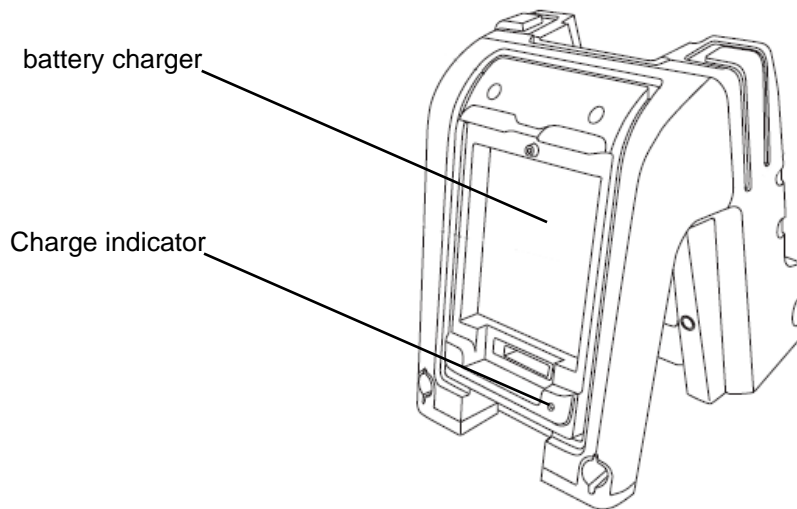

2. Place the battery charger in the desk stand.
3. plug-in the power adapter on the battery charger

The Charge indicator flashes to indicate that the battery is charging.  
When the battery is fully charged, the Charge indicator glows solid green.

---

## Charging the battery outside the desk stand

---

Charging the battery outside the desk stand

1. Place the battery in the battery charger.



2. Connect the AC/DC adapter to the battery charger's Power connector.
3. Connect the AC/DD adapter to an electrical socket.

The Charge indicator flashes to indicate that the battery is charging.

When the battery is fully charged, the Charge indicator glows solid green.

**Note:** During battery swap the memory data is sustained by a small backup battery.

Please swap battery within 1 hours to avoid data loss.

### Installing memory, multimedia cards or Compact Flash card

---

You can install additional memory or multimedia cards in the Tpad's SD/MCC socket.

The computer accepts one SD card (Secured Digital Card). Insert the card firmly into the slot and fix the rubber cover for water/dust protection. To remove the card, push the SD card to release it.

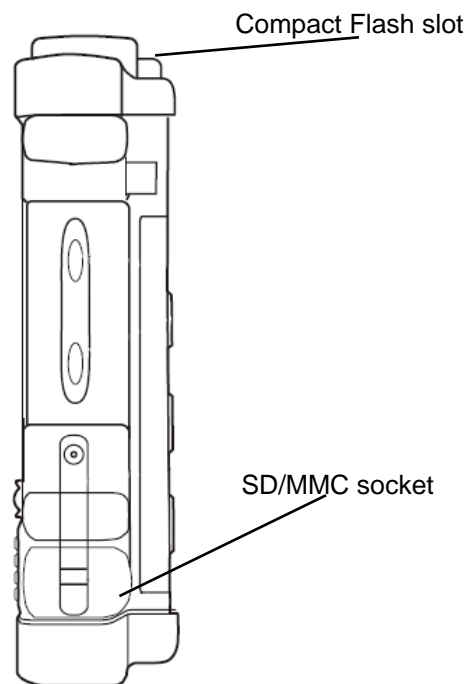

You can install Compact Flash card on the Tpad. please refer to TETRA reseller or contact [support@logic-instrument.com](mailto:support@logic-instrument.com) for supported Compact Flash cards.

Note :



If the CF card does not fit onto the Tpad with the CF cover installed then the Tpad is not sealed and loose its protection depending on the size of the Compact Flash card.

---

---

# Using the Bluetooth

---

This section describes how to use the BlueTooth Manager for Windows CE. This section is for users and developers who need to use BlueTooth functions:

This document describes:

- Software Installation.
- Bluetooth Manager utilisation (with print screen)

## ACRONYMS

---

FTP : File Transfer Profile. Bluetooth service used for File Transfer.

OPP : Object Push Profile. Bluetooth service used to send a file or card.

SPP : Serial Port Profile. Bluetooth service used to open a virtual serial communication between two peripherals.

---

### 1. Installation

Bluetooth manager is already installed on the Tpad.

By default, the installation installs “\Program Files\BthManager “and creates the following directories: “\My Documents\Bluetooth\Ftp”, “\My Documents\Bluetooth\Opp”, and “\My Documents\Bluetooth\Sync”.

### 2. BlueTooth Manager

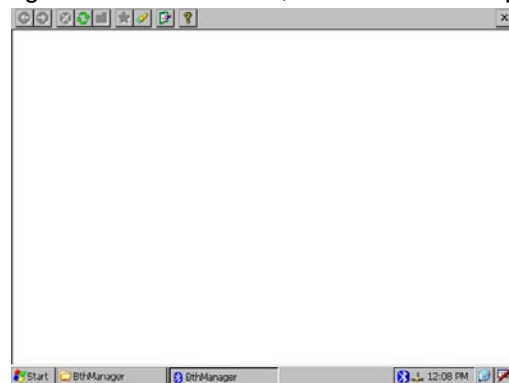

When the BTh Manager is run in a window, icons are then displayed in the tools bar:



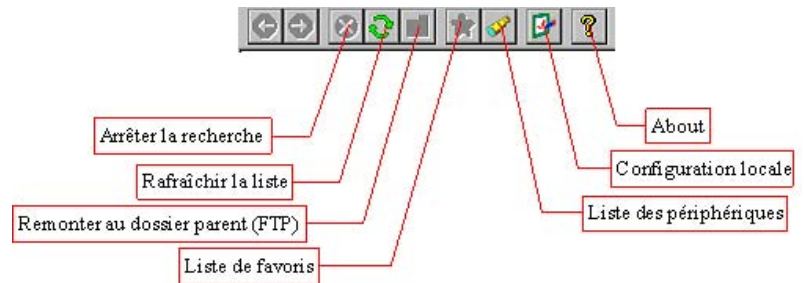



### 3 Peripheral search

On the initial start of the application, you need to click on  to start the search of the remote Bluetooth peripherals. Then all peripherals will always be displayed to decrease search time. To refresh the list click on  .

The search is done first on coupled peripherals and then it looks at distant peripherals.

During the search, the name or its class of the peripheral may not be found. You could then update the peripheral settings by:



The search time could be lengthy, but it can be stopped by the  icon.

### 3.2 Coupling of peripheral

The coupling could be done in two ways:

Could be requested by a peripheral or by the TPAD BlueTooth Manager, or the request is done by a right click and then choose «Pair».



In both cases, you need to enter the password :



After the password is entered, the request is applied to the two peripherals, you then could see if the peripherals are coupled:



Peripheral coupled



Peripheral coupled

### 3.3 Proprieties and configuration

Click on , to see the local peripheral proprieties (MAC address, name and peripheral type) and it's possible to modify the security settings. You could choose if you want to set the peripheral to be detectable, un-detectable or set the couple to be mandatory for access of local services.

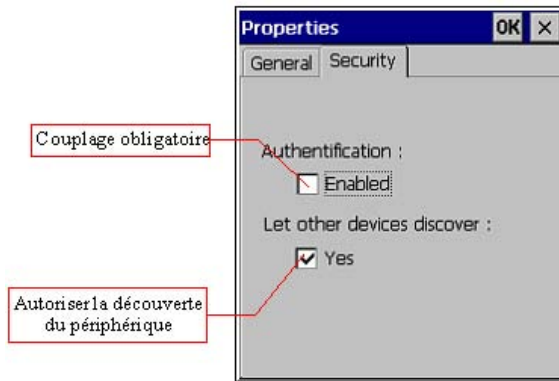

With the contextual menu on the icons, you could see the properties. (of a peripheral, a service, ...).





### 3.4 Services Search

For Service search, just double click on the peripheral icon, then the Blue-Tooth manager will display if the peripheral has FTP, OPP, and SPP services.



For the initial search, the BlueTooth Manager asks for the request of each service.

It's possible to stop the search with  or refresh the service search list with .

### 3.5 Service Utilisation

#### 3.5.1 File Transfer

To use this service, double click on the FTP icon or choose connect on the contextual menu. The BlueTooth Manager displays the directory shared by the distant peripheral. Then you can browse or choose the parent directory with .

To get a file, double-click or choose "Get File" from the contextual menu. A window is displayed with transfer time information.



The file transferred is located on the following "My Documents\Bluetooth\Ftp". The path can change in the FTP properties.

The following window is displayed when you want to add a file to the distant peripheral with a right-click on the folder or current folder.

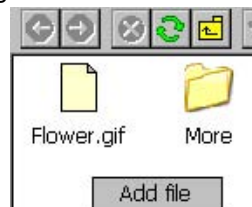

Then, it's possible to delete a file when "Delete" is selected on the contextual menu.

### 3.5.2 Object Push

To use this service, double-click or select "Push file" from the contextual menu. Then choose the file to transfer.

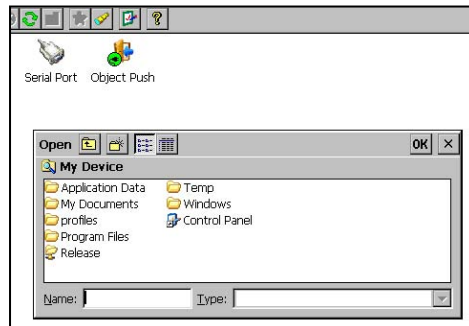

### 3.5.3 Serial Port

To use this serial service, double-click on the icon or choose "Connect " from the contextual menu. The information is displayed if the service is enabled or not.



Service connected



Service not connected

When the service is on, all applications could use the virtual COM port. To know the COM port setting, select properties in the contextual menu.

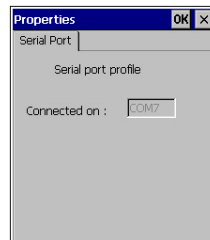

### 3.6 Stop the Bluetooth Manager

When the BlueTooth Manager window is closed, in fact the application is still running. To re-display or stop it, click on the BlueTooth icon on the Windows bar and select : "Show" or "Exit" .





---

## **5 Troubleshooting and FAQ**

---

Should the computer fail to function properly, you may try the following troubleshooting steps: (Please backup your data before troubleshooting)

- Check AC adapter, battery, and the power source.
  - Press hardware reset to re-boot the computer.
- Turn OFF the master switch for a while then turn ON and re-boot.
- Remove the software suspected.

### Combination key table

Pressing the Fn Key  (Function Key) as a preliminary key allows entering a shifted character. The Fn icon will appear on the task bar and disappear when the second key is entered



reset button

| Keys             | Function  |
|------------------|---|
| CLR              | ESC   |
| Fn+ "1"          | Lock Keyboard and Touchscreen                                   |
| Fn+ "2"          | Calibration   |
| Fn+ "*"          | Soft Reset  |
| Fn               | toggles between numeric, alpha lower case, and alpha upper case |
|                  | CLR key toggles between CLR and ESC                             |
| P3 + P4 + Reset  | Run Diagnostic utility  |
| Reset + Power-on | Hard Reset, default settings loose unsaved data                 |

#### 1- How could we have a larger virtual keyboard?

=> 3 Steps to launch Soft Keyboard Options

- 1 - Launch Control Panel
- 2 - Launch «Input Panel»
- 3 - Click «Options...» button to launch «Soft Keyboard Options»

#### 2- How to **Calibrate the touchscreen**

=> After a reset, the Touchscreen needs to be re-calibrated.

There two different ways to access re-calibration.

- 1- enter in Control Panel / Stylus / Calibration and click on Recalibrate.
- 2- access directly to the calibration tool by pressing simultaneously Fn+ '2' combination keys to launch calibration

### **3- How to display a presentation on PC monitor**

Example: Projection on a retro projector connected to a PC and TPad for software demonstration:

- Install the software Microsoft ActiveSync from the following link:  
<http://www.microsoft.com/downloads/details.aspx?FamilyID=d2645c21-8a85-45a2-8d13-653beb6cdddc&DisplayLang=en>

- The software PowerToys Remote Display Control could be downloaded on Microsoft following link:

<http://www.microsoft.com/technet/prodtechnol/wce/downloads/ppctoys.mspx>

The software is installed automatically C:\Program Files\Remote Display Control\cerhost.exe. We recommend creating a shortcut on the desktop.

- Software Utilisation:

You could find a user guide under C:\Program Files\Remote Display Control\readme.txt.

Three stapes are necessary:

- Connect the peripheral (on) to the PC. Please check that ActiveSync detect the connexion.

- On the PC launch Remote Display Control (cerhost.exe)

- On the TPad execute \Windows\cerdisp.exe, click on Connect, use default parameter (PPP\_PEER), and click Ok.

All data displayed on the TPad are immediately visible on the PC monitor.

You can now zoom the window.

Consequently, if a retro projector is connected to the PC; whole assistance could see the displayed data on the TPad.

### **4- Could we connect the TPad and/or Cradle directly to vehicle?**

NOT directly but only with specific optional adapter provided by Logic Instrument.

### **5- What are the Compact Flash Cards available?**

The Tpad accept almost all CF cards available on the market however not all of them will fit in the Tpad due to Compact Flash cover size.

If you do not sealed the CF cover then the Tpad is not protected and severe injury may occur.

To know if a CF card fit with the Tpad please contact our local representative or e-mail us at [support@logic-instrument.com](mailto:support@logic-instrument.com)



**6- Could we use Bluetooth printer?**

Normally all BT printers or BT/USB/Parallel adapter should work properly if at least SPP profile is available, as BPP, BIP, OPP, HCRP profiles could also be used.

**7- Alphanumeric keys and joystick life?**

- Power-key is 65,000 times.
- Keyboard (each key) is 260,200 times.
- Reset-key is 6,500 times.
- Function-key are 65,000 times.
- 5 ways SW (each direction) is 260,200 times.

**8- How To Extend Your PDA's Battery Life**

Your PDA is a valuable tool for mobile work. When the battery begins to fail or has failed, mobile users can be stuck. Take steps to protect and extend your PDA's battery life.

Here's How:

1. Use the AC adapter whenever you can. This not only charges the battery but extends the battery life.
2. Set your PDA to power down after a set period of inactivity.
3. Adjust the brightness of the screen. You don't need it to be 100% bright and it will consume less power.
4. Set the backlighting to turn off after a certain period of time.
5. Set your PDA on the lowest setting possible when not in use.
6. Remove any unused devices such as Compact Flash and PC cards.

**9- How long does it take to charge the battery**

It takes two hours to charge the battery at 25°C.

## 10- RMA Service

If troubleshooting is unsuccessful, please consult your dealer for service. If it is necessary to send in the Handheld device for repairs, please follow the dealer's instructions for RMA# procedure.

Shipping instructions:

1. Use the original shipping container and packing materials, if possible.
2. If the original packing materials are not available, wrap the equipment with soft material (e.g., PU/ PE form) then put the wrapped equipment into a hard cardboard shipping box.
3. Include a sheet with the following information: (Note: please keep a copy for your record)
  - Name
  - Address
  - Unit serial number
  - Place and date of purchase or the original invoice number
  - Date of failure
  - A DETAILED description of the problems you have encountered
  - A list of the hardware/software configuration, if applicable.
4. Clearly mark the outside of the shipping box with the RMA number. This will facilitate faster processing and avoid faulty return.
5. Unless prior arrangements have been made, the customer is responsible for all shipping costs. Unauthorized use of the company's shipping accounts is not permitted.

**11- Cleaning & Maintenance**

Always turn OFF the power, unplug the power cord and remove the battery before cleaning. The exterior of the system and display may be wiped with a clean, soft, and lint-free cloth. If there is difficulty removing dirt, apply non-ammonia, non-alcohol based glass cleaner to the cloth and wipe.

An air gun is recommended for cleaning water and dust. For salty water please wipe with fresh water then blow-dry with an air gun.

Close all caps tightly before water cleaning.

---

## 6 SPECIFICATIONS

---

### **CPU**

Intel XScale PXA263 CPU speed 400MHz  
Operating system Windows CE NET 4.2

### **MEMORY**

SDRAM 64MB  
ROM 64MB

### **DISPLAY**

Type: Resistive Touchscreen 4" Active TFT Full VGA  
Resolution (480x640), 64k/16-Bit colors  
Backlight: YES  
Transmissive, outdoor readable, integrated backlight, Automatic/Manual brightness controller

### **I/O PORTS**

Mono speaker  
DC jack x 1  
Docking port  
XPM port  
Compact Flash slot (type II x 1)  
SD slot  
serial port (optional)

### **Bluetooth COMMUNICATION**

Built-in Bluetooth

### SYSTEM UNIT DIMENSIONS AND WEIGHT

Width: 102.8mm  
Depth: 46.5mm  
Height: 186.1mm  
Weight: 600g

### AC ADAPTER

Voltage: AC 110~220 V  
Frequency: 50/60 Hz

### BATTERY

Type: Lithium Ion  
Capacity: 7.4V 2400mAH  
Back up battery: NiMH 20mAH

### ENVIRONMENTAL RATINGS

MIL-STD-810F: Operating Temperature ; Storage Temperature ;  
Thermal Shock ; Relative Humidity ; Solar Radiation  
Salt Fog ; Corrosive Agents ; Integrity Vibration ;  
Vehicle Vibration ; Functional Shock ; Crash Shock  
Drop Test ; Transit Drop  
IP65 (IEC 60529): Dust impenetrable, jet water proof  
Regulatory Compliance: CE, FCC part 15, EC 60950, CSA C2.2,  
designed to be ATEX 94/9/EC zone 2  
Temperature: -20° C (-4° F) to +50° C (122° F) operating  
-40° C (-40° F) to +85° C (185° F) storage  
Humidity: 95% @ 60° C (140) F



---

# A Glossary

---

**Adapter.** A device that provides an interface between two dissimilar electronic devices. For example, the AC adapter modifies the power from a wall outlet for use by the computer.

**Advanced Power Management (APM).** A facility consisting of one or more layers of software that support power management. The APM software interface enables applications, operating systems, device drivers, and the APM BIOS to work together to reduce power consumption.

**Alternating Current (AC).** Electric current that reverses its direction of flow at regular intervals.

**Analog signal.** A signal with characteristics such as amplitude and frequency that vary in proportion to (are an analog of) the value to be transmitted. Voice communications are analog signals.

**Application.** A program that performs specific tasks on your computer, such as word processing or creating spreadsheets.

**BIOS.** Programs that contain such basic hardware operations as an interaction with diskette drives, hard disk drives, and the memory.

**Board.** A circuit board. An internal card containing electronic components called chips, which perform a specific function or increase the capabilities of the system.

**Boot.** To load a program or operating system into system memory.

**Bits Per Second (BPS).** In serial transmission, the instantaneous bit speed with which a device or channel transmits a character.

**Card.** Synonym for board; see board.

**Compatibility.** 1.The ability of one computer to accept and process data in the same method as another computer without modifying the data or the media upon which it is being transferred. 2.The ability of one device to connect or communicate with another system or component.

**Configuration.** The specific combination of hardware components of the computer, and their operating status. The configuration of your computer includes pre-defined memory, type and speed of microprocessor, type of and size of hard disk drive, etc.

**Default.** The preset parameter value automatically selected by the computer when you or a program do not provide instructions.

**Device driver.** A program that controls communication between a specific peripheral device and the computer.

**Display.** An image-producing device used to view computer output.

**Double-click.** To press and release the pen/stylus twice within a time frame you define, without moving the pointer off the choice.

**Driver.** Software that allows an application program to communicate with a particular piece of equipment, such as a printer or the pen/stylus.



**Hardware.** The physical electronic and mechanical components of a computer system. typically, the computer itself, CPU, memory, etc.

**Hertz.** A unit of wave frequency that equals one cycle per second.

**Interface.** 1. Hardware and/or software components used specifically to connect one computer or device to another. 2. To physically connect one system or device to another to exchange information. 3. The point of contact between user, the computer, and the program (for example, the pen/stylus or a menu).

**Kilobyte (KB).** A unit of 1024 bytes measuring storage space, typically in memory or on storage media such as a diskette or hard disk drive.

**Local area network (LAN).** Assembly of separate computers into an integrated network that connects the various computers together and to common devices such as printers and fax machines.

**Light Emitting Diode (LED).** A semiconductor device that emits light when a current is applied.

**Liquid Crystal Display (LCD).** liquid crystal sealed between two sheets of glass coated with transparent conducting material. Applying a voltage between the glass sheets darkens the liquid crystal to provide contrast to lighted portions of the display.

**Megabyte (MB).** A unit of data storage equal to 1024 kilobytes.

**Megahertz (MHz).** a unit of wave frequency that equals 1 million cycles per second.

**Modem.** A device that connects your computer to a telephone line, allowing it to communicate with another computer at another location.

**Pen.** See stylus.

**Peripheral device.** An input/output device that is external to the central processor and/or main memory such as a printer or scanner.

**Pixel.** Picture elements (tiny dots) that compose a screen image.

**Port.** The electrical connection through which the computer sends and receives data to and from devices or other computers.

**Program.** A set of instructions a computer can execute to tell the system what to do and how to do it.

**Random Access Memory (RAM).** A hardware component of your computer that temporarily stores active program code and data.

**Reset.** The act of reloading the operating system.

**Resolution.** The number of pixels displayed on the screen. A higher resolution provides greater clarity and allows more information to be displayed on the screen at once.

**Restart.** Resetting a computer without turning it off (also called warm boot or soft reset).

**Resume.** The act of returning the computer to an active, operational state.

**Read Only Memory (ROM).** The portion of your computer's memory that contains permanent instructions, and which cannot be modified.

**Status Indicator (LED).** a light above the LCD screen which indicates the current status of a particular device or hardware component.

**Stylus.** A writing instrument. For pen computers, the stylus is used to interface with the LCD and digitizer.

**Suspend mode.** A power conservation mode in which electrical current is removed from most components of the computer.

**Universal Serial Bus.** A serial interface that enables communication between devices and the computer.

## Important safety information

Before you use the Tpad, read these safety instructions and the operation instructions in this handbook.

Failure to observe all these instructions voids the Limited Warranty and may lead to suspension or denial of services to the offender, or legal action, or both.

Follow any special regulations governing the use of the Tpad and, if radioenabled,

always switch it off in areas where radio devices are forbidden or when the radio device can cause interference or danger.

Always follow any safety laws and regulations pertaining to the use of cell phones and two-way radios, because these laws and regulations typically apply to the use of the BluetoothTpad.

Observe all restrictions on the use of radio equipment in fuel depots (fuel storage and distribution areas), chemical plants, and wherever blasting operations are in progress or in any area in which restrictions on radio transmissions are imposed.

Switch off the Tpad when in an aircraft. The Tpad is not FAA-approved for use on aircraft. The effect of the use of the Tpad in aircraft is unknown. Using the Tpad in an aircraft may affect aircraft instrumentation, communication, and performance; may disrupt the network; and may be illegal.

Operating the Bluetooth Tpad may interfere with the functioning of inadequately protected medical devices such as pacemakers. Consult a physician or the manufacturer of the medical device if you have any questions.

This transmitter must not be co-located or operating in conjunction with any other antenna or transmitter.