

Bluetooth Speaker

TITAN

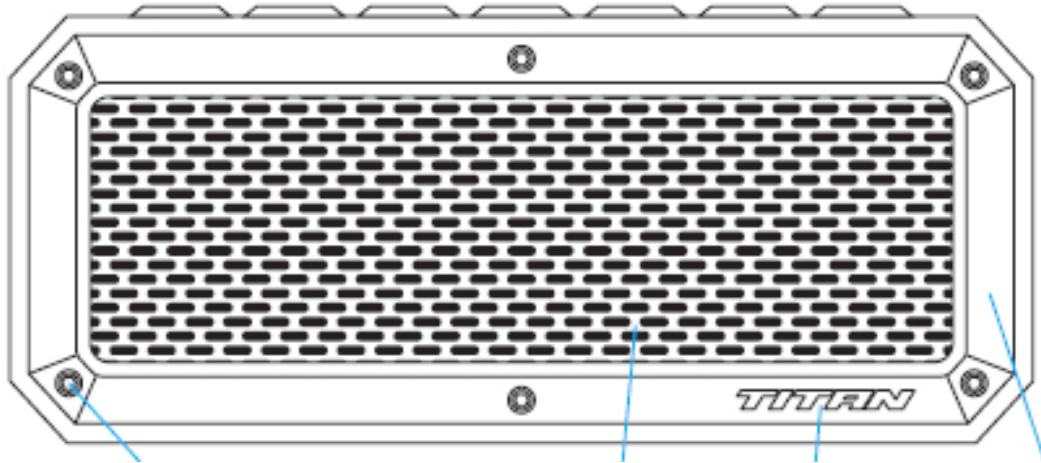

Thank you to have chosen our product. This product has been created by our professional team and according to the USA regulation. For a better use of your new device, we recommend you to read carefully this user manual and keep it for record.



Specifications

- Model No.: SP58086
- Speaker size : 172x50x73.5mm
- Power by USB cable :DC 5V
- Rechargeable Li-ion battery included
- Battery capacity: 3.7V 1000MAH
- Battery life: 4Hrs (Volume at 75%)
- Output power: 1.75W X 2 (THD=10%)
- Working distance: < 10 M (Distance differs from different cellphone Bluetooth devices and the environments)

Product sketch map

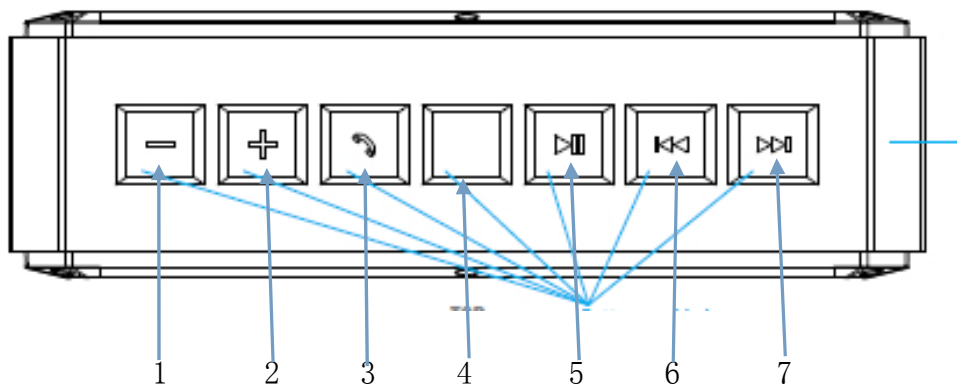

1. Volume Down
2. Volume up
3. handsfree button
4. Bluetooth indicator
5. Play./Pause
6. Prev tune
7. Next tune

Status	Indicator
Bluetooth pairing	Blue light flash quickly
Paired	Blue light keep lighting
Aux-in mode	Red
Charging	Red light
Fully Charged	Green Light

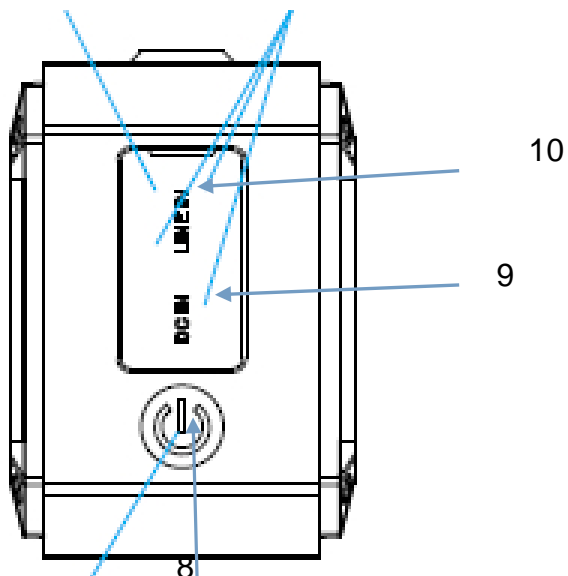





8. Power button
9. USB port
10. Line in port

Pairing Bluetooth Speaker

1. Long press the power button  to turn on the speaker. The speaker will enter Bluetooth searching mode auto and Blue indicator is flashing fast.
2. Turn on your bluetooth device, search "TITAN" in your bluetooth searching list, then pair your bluetooth device with the speaker. (If your bluetooth device ask for password, please insert "0000".)
3. After paired successfully, the mode indicator will be solid blue.

Playing Audio Wirelessly

1. Follow the instruction of Pairing Bluetooth Device
2. Adjust the volume by press or hold on the **-** or **+** buttons on speaker; or native controls on the Bluetooth device.
3. Press Pause button  on the speaker to Play/Pause the tune or just control the tune by press Play/Pause on your Bluetooth device.
4. Press  is the Prev tune ,Press  is the Next tune or just control the tune by press prev/next on your bluetooth device
- 5.If there is a coming call on your phone, short press  to pick up or hang up call ,long press  to reject call.
6. When do not play music, please long press the power button to turn off the speaker,

Using the 3.5mm Audio Input

1. Plug one end of a 3.5mm Audio cable into the unit. The mode indicator light will display **a red light**.
2. Plug the other end of the 3.5mm Audio cable into other audio devices.

3. Turn on the speaker, it will play music from the audio device.
4. Press and hold on the **-** or **+** buttons to adjust the volume.
5. If you want to Play/pause the tune, or want to change Previous/Next tune just control the native buttons on your audio device.

FCC Statement:

This device complies with part 15 of the FCC Rules. Operation is subject to the following two conditions: (1) This device may not cause harmful interference, and (2) this device must accept any interference received, including interference that may cause undesired operation.

Caution: Any changes or modifications not expressly approved by the party responsible for compliance could void the user's authority to operate the equipment.