

harman/kardon®
Power for the Digital Revolution.®

4/20/04
Ver 1

AVR 7300

AUDIO/VIDEO RECEIVER
OWNER'S MANUAL

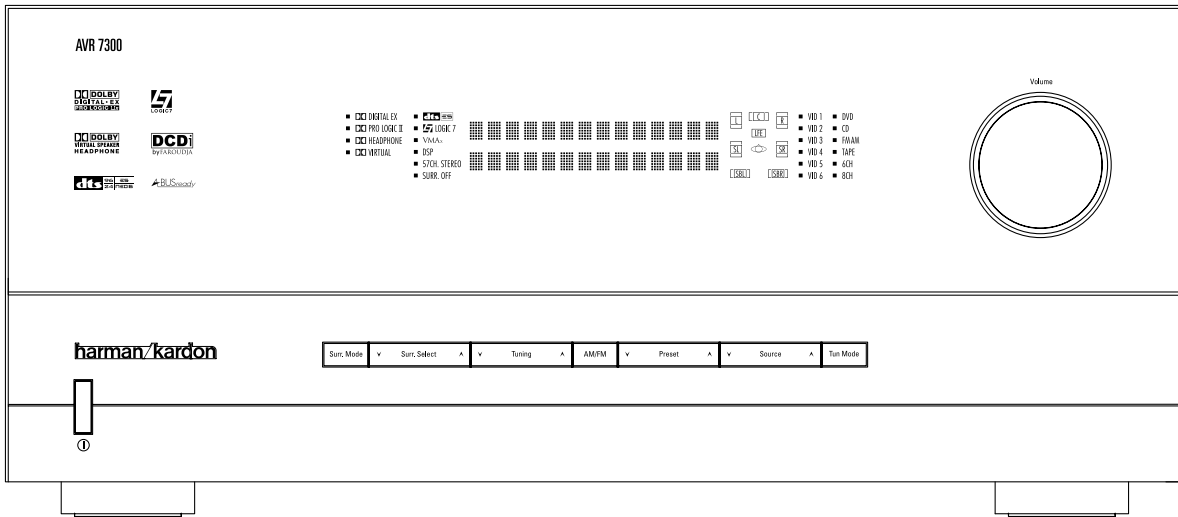

AVR 7300 DIGITAL PATH RECEIVER

3	Introduction
4	Important Safety Information
4	Unpacking
5	Front-Panel Controls
8	Rear-Panel Connections
11	Main Remote Control Functions
15	Zone II Remote Control Functions
16	Installation and Connections
19	System Configuration
19	Speaker Placement
19	System Setup
20	Input Setup
22	Audio Setup
22	Surround Setup
24	Speaker Setup
26	Delay Settings
27	Output Level Adjustment
27	Using EzSet
28	Manual Output Level Adjustment
30	Operation
30	Basic Operation
30	Source Selection
30	6/8-Channel Direct Input
30	Volume and Tone Control
31	Surround Mode Selection
31	Digital Audio Playback
32	Surround Mode Chart
35	Tuner Operation
35	Tape Recording
35	Front-Panel Connections
36	Output Level Trim Adjustment
37	Advanced Features
37	Front-Panel Display Fade
37	Display Brightness
37	Turn-On Volume Level
37	Semi-OSD Settings
38	Full-OSD Time-Out Adjustment
39	Multiroom Operation
39	Multiroom Setup
39	Surround Amplifier Channel Assignment
40	Multiroom Operation
41	Configuring the Remote
41	Programming Remote Codes
41	Preprogrammed Code Entry
42	Automatic Code Entry
42	Learning Commands
43	Changing Devices
44	Macro Programming
46	Punch-Through Configuration
47	EzSet Configuration
48	Renaming
49	Resetting the Remote
51	Troubleshooting Guide
51	Processor Reset
52	Technical Specifications

See trademark acknowledgements on page 52.

CAUTION

RISK OF ELECTRIC SHOCK DO NOT OPEN

CAUTION: To prevent electric shock, do not use this (polarized) plug with an extension cord, receptacle or other outlet unless the blades can be fully inserted to prevent blade exposure.



The lightning flash with arrowhead symbol, within an equilateral triangle, is intended to alert the user to the presence of uninsulated "dangerous voltage" within the product's enclosure that may be of sufficient magnitude to constitute a risk of electric shock to persons.



The exclamation point within an equilateral triangle is intended to alert the user to the presence of important operating and maintenance (servicing) instructions in the literature accompanying the appliance.

Typographical Conventions

In order to help you use this manual with the remote control, front-panel controls and rear-panel connections, certain conventions have been used.

EXAMPLE – (bold type) indicates a specific remote control or front-panel button, or rear-panel connection jack

EXAMPLE – (OCR type) indicates a message that is visible on-screen or on the front-panel information display

EXAMPLE – (Synchro type) indicates a message that is displayed on the remote control's LCD screen

1 – (number in a square) indicates a specific front-panel control

▲ – (number in a triangle) indicates a front-panel control that is behind the drop-down door

A – (letter in a circle) indicates a rear-panel audio connection

A – (letter in a square) indicates a rear-panel video or system connection

1 – (number in an oval) indicates a button or indicator on the remote

A – (letter in an oval) indicates a button on the Zone II remote

HDCD®, **HDCD**®, High Definition Compatible Digital® and Pacific Microsonics™ are either registered trademarks or trademarks of Pacific Microsonics, Inc., in the United States and/or other countries. HDCD system manufactured under license from Pacific Microsonics, Inc.

Thank You for Choosing Harman Kardon®

Packed with state-of-the-art features to bring out the best in any audio or video programming, the AVR 7300 will be the centerpiece of your home entertainment system for years to come. The sophisticated technology that makes the AVR 7300 possible is able to accommodate virtually any combination of program sources, speakers and room sizes, yet is easy to setup and operate. In order to take advantage of the power of your new receiver we strongly recommend that you take a few minutes to read this owner's manual and follow the instructions that pertain to the specifics of your listening and viewing environment.

If you have any questions about this product, its installation or its operation we recommend that you contact your dealer or installer, as they are best source of local information. You may also access a wealth of information and assistance by visiting our web site at www.harmankardon.com.

Description and Features

The AVR 7300 is the latest in Harman Kardon's 50 year tradition of flagship products, establishing a new benchmark for audio video receivers. Along with a powerful seven channel amplifier, extensive digital processing and decoding for virtually any surround mode, a wealth of multi-zone options, upgradeable software and an easy-to-use LCD remote, the AVR 7300 breaks new ground with its built-in video processing using award winning technology from Faroudja

Designed to serve as the hub of your home entertainment system, the AVR 7300 accommodates a wide range of inputs. Multiple digital audio inputs are available for use with the latest program sources, along with standard analog audio inputs that may be used as an automatic fall-back when a digital input stream is interrupted. Of course, a full set of audio inputs is available for use with high-resolution audio sources such as DVD-Audio and SACD, while preamp outputs and a trigger jack make it easy to add optional, external power amplifiers. On the video side, three 100 MHz, wide-bandwidth component video inputs are at your disposal for use with the high-definition products, able to be assignable to any video source. All five video inputs may also be renamed in the on-screen displays to reflect a product or source device name. Digital and analog outputs make it easy to integrate recorders, with discrete digital outputs and switchable analog audio/video jacks ready for connection to portable recorders behind a front panel door.

Harman Kardon leads the way in audio processing with the latest modes from Dolby Laboratories and DTS including Dolby ProLogic IIx and DTS 96/24. For installations where less than a full complement of surround speakers is available, the AVR 7300 offers both Dolby Virtual Speaker and Harman International's own VMAx technology. A Harman Kardon exclusive in receivers is the latest version our proprietary Logic 7® processing, as found in both high-end processors and the premium sound systems in

many of the world's greatest automobiles. Logic 7 creates a wider, more enveloping sound field and more defined channel positioning from both conventional two-channel and matrix-encoded surround programming. Advanced sound technology even extends to the headphone jack, where Dolby Headphone circuitry is available to create an amazing sense of openness with headphones.

Recognizing the importance of video in advanced home theater systems, the AVR 7300 offers a wide range of video processing options thanks to Faroudja® DCDi™ processing. This allows all incoming video to be upsampled to 480P component for simple connections with today's "digital ready" HDTV displays. A wide range of special video processing options may be used to improve the quality of your video sources, and exclusive to Harman Kardon, these settings may be individually customized for each video input, rather than applied globally. This is particularly important when a system mixes older video sources such as a VCR or analog cable tuner with the latest digitally-based sources such as DVD. Closing the loop between audio and video, the AVR 7300 recognizes that the use of multiple digital video processors in set-top boxes, personal video recorders and video displays may cause the video to lag behind the audio, the AVR 7300 includes an A/V Sync feature to delay the audio for each input so that it is brought back into sync with the picture.

The AVR 7300's multizone options and a standard Zone II remote make it easy to extend your music and video enjoyment throughout your home, listening to one source in the main home theater area and a second, separate source in other rooms. Thanks to assignable rear surround channel amplifiers, you may create a basic remote room listening zone with only the addition of speakers and some wire. The unit's multiroom outputs may also be used to feed an external power amplifier with individual in-room volume controls. For one-cable connectivity, the AVR 7300 is A-Bus Ready® requiring only a single Category 5/5e cable and an optional in-wall module to deliver volume control, remote control capability for compatible IR controlled devices, and amplifier power to two rooms. The AVR 7300 routes both video and audio to a remote room, and thanks to the "downmix" option, you may even send an analog feed to remote rooms even when the original source is digital audio.

Finishing touches for the AVR 7300 include all the extras you expect from a flagship receiver: Harman Kardon's patented EzSet remote with an LCD display, a trigger jack for controlling remote screens or blinds, an RS-232 port for bi-directional remote control and software upgradeability and much, much more. Combining state-of-the-art digital audio and video processing with the proven performance of Harman Kardon's high-current, ultrawide bandwidth amplifier design in a elegant design that complements the latest source components and video displays, the AVR 7300 is truly the latest landmark product in Harman Kardon's 50-year history of delivering the finest in home audio/video products.

For Canadian model

This class B digital apparatus complies with Canadian ICES-003.

For models having a power cord with a polarized plug: CAUTION: To prevent electric shock, match wide blade of plug to wide slot, fully insert.

Modèle pour les Canadien

Cet appareil numérique de la classe B est conforme à la norme NMB-003 du Canada.

Sur les modèles dont la fiche est polarisée: ATTENTION: Pour éviter les chocs électriques, introduire la lame la plus large de la fiche dans la borne correspondante de la prise et pousser jusqu'au fond.

- Faroudja DCDi video processing and upscaling custom tailors the video output to match your display for the highest video quality regardless of the input source. All video parameters adjustable separately for each video input.
- Video up-conversion for single-input connection to video displays.
- All popular digital and matrix surround modes, including Dolby® Digital, Dolby Digital EX, Dolby Pro Logic® IIx, DTS®, DTS-ES® Discrete and Matrix, DTS Neo:6® and DTS 96/24
- Harman Kardon's exclusive Logic 7® processing, along with a choice of either Dolby Virtual Speaker or VMAx® processing for use when only two speakers are available
- Dolby Headphone to create spacious, open sound fields when using headphones
- HDCD® decoding for enhanced CD playback, and MP3 decoding for use with compatible computers
- High-bandwidth, HDTV-compatible component video inputs may be assigned to any video input
- Full bass management for all inputs, including the analog direct inputs for DVD-Audio and SACD players, including Quadruple Crossover and individual settings for each input
- A/V Sync delay adjustable for each input delivers perfect lip sync with digital programs or video displays
- Front-panel digital audio and analog audio/video jacks may be used as either inputs or outputs for connection to portable products or video game consoles
- Extensive Multiroom options, including a standard Zone II remote, assignable rear-channel amplifier channels and A-BUS Ready® capability for listening to a separate source in a remote zone
- Easy-to-program EzSet® remote with two-line LCD display automatically sets output levels for optimal performance

SAFETY INFORMATION

Important Safety Information

Verify Line Voltage Before Use

Your AVR 7300 has been designed for use with 120-volt AC current. Connection to a line voltage other than that for which it is intended can create a safety and fire hazard and may damage the unit.

If you have any questions about the voltage requirements for your specific model, or about the line voltage in your area, contact your selling dealer before plugging the unit into a wall outlet.

Do Not Use Extension Cords

To avoid safety hazards, use only the power cord attached to your unit. We do not recommend that extension cords be used with this product. As with all electrical devices, do not run power cords under rugs or carpets or place heavy objects on them. Damaged power cords should be replaced immediately by an authorized service center with a cord meeting factory specifications.

Handle the AC Power Cord Gently

When disconnecting the power cord from an AC outlet, always pull the plug; never pull the cord. If you do not intend to use the unit for any considerable length of time, disconnect the plug from the AC outlet.

Do Not Open the Cabinet

There are no user-serviceable components inside this product. Opening the cabinet may present a shock hazard, and any modification to the product will void your guarantee. If water or any metal object such as a paper clip, wire or a staple accidentally falls inside the unit, disconnect it from the AC power source immediately, and consult an authorized service center.

CATV or Antenna Grounding

If an outside antenna or cable system is connected to this product, be certain that it is grounded so as to provide some protection against voltage surges and static charges. Section 810 of the National Electrical Code, ANSI/NFPA No. 70-1984, provides information with respect to proper grounding of the mast and supporting structure, grounding of the lead-in wire to an antenna discharge unit, size of grounding conductors, location of antenna discharge unit, connection to grounding electrodes and requirements of the grounding electrode.

NOTE TO CATV SYSTEM INSTALLER: This reminder is provided to call the CATV (Cable TV) system installer's attention to article 820-40 of the NEC that provides guidelines for proper grounding and, in particular, specifies that the cable ground shall be connected to the grounding system of the building, as close to the point of cable entry as possible.

Installation Location

- To ensure proper operation and to avoid the potential for safety hazards, place the unit on a firm and level surface. When placing the unit on a shelf, be certain that the shelf and any mounting hardware can support the weight of the product.
- Make certain that proper space is provided both above and below the unit for ventilation. If this product will be installed in a cabinet or other enclosed area, make certain that there is sufficient air movement within the cabinet. Under some circumstances, a fan may be required.
- Do not place the unit directly on a carpeted surface.
- Avoid installation in extremely hot or cold locations, or in an area that is exposed to direct sunlight or heating equipment.
- Avoid moist or humid locations.
- Do not obstruct the ventilation slots on the top of the unit, or place objects directly over them.
- There is the remote possibility that the rubber padding on the bottom of the unit's feet may leave marks on certain wood or veneer materials. Use caution when placing the unit on soft woods or other materials that may be damaged by heat or heavy objects.

Cleaning

When the unit gets dirty, wipe it with a clean, soft, dry cloth. If necessary, wipe it with a soft cloth dampened with mild soapy water, then a fresh cloth with clean water. Wipe dry immediately with a dry cloth. NEVER use benzene, aerosol cleaners, thinner, alcohol or any other volatile cleaning agent. Do not use abrasive cleaners, as they may damage the finish of metal parts. Avoid spraying insecticide near the unit.

Moving the Unit

Before moving the unit, be certain to disconnect any interconnection cords with other components, and make certain that you disconnect the unit from the AC outlet.

Important Information for the User

This equipment has been tested and found to comply with the limits for a Class-B digital device, pursuant to Part 15 of the FCC Rules. The limits are designed to provide reasonable protection against harmful interference in a residential installation. This equipment generates, uses and can radiate radio-frequency energy and, if not installed and used in accordance with the instructions, may cause harmful interference to radio communication. However, there is no guarantee that harmful interference will not occur in a particular installation. If this equipment does cause harmful interference to radio or television reception, which can be

determined by turning the equipment off and on, the user is encouraged to try to correct the interference by one or more of the following measures:

- Reorient or relocate the receiving antenna.
- Increase the separation between the equipment and receiver.
- Connect the equipment into an outlet on a circuit different from that to which the receiver is connected.
- Consult the dealer or an experienced radio/TV technician for help.

This device complies with Part 15 of the FCC Rules. Operation is subject to the following two conditions: (1) this device may not cause harmful interference, and (2) this device must accept interference received, including interference that may cause undesired operation.

NOTE: Changes or modifications may cause this unit to fail to comply with Part 15 of the FCC Rules and may void the user's authority to operate the equipment.

Unpacking

The carton and shipping materials used to protect your new receiver during shipment were specially designed to cushion it from shock and vibration. We suggest that you save the carton and packing materials for use in shipping if you move, or should the unit ever need repair.

To minimize the size of the carton in storage, you may wish to flatten it. This is done by carefully slitting the tape seams on the bottom and collapsing the carton. Other cardboard inserts may be stored in the same manner. Packing materials that cannot be collapsed should be saved along with the carton in a plastic bag.

If you do not wish to save the packaging materials, please note that the carton and other sections of the shipping protection are recyclable. Please respect the environment and discard those materials at a local recycling center.

At this time you should remove the protective plastic film from the front-panel lens. Leaving the film in place will affect the performance of your remote control.

FRONT-PANEL CONTROLS

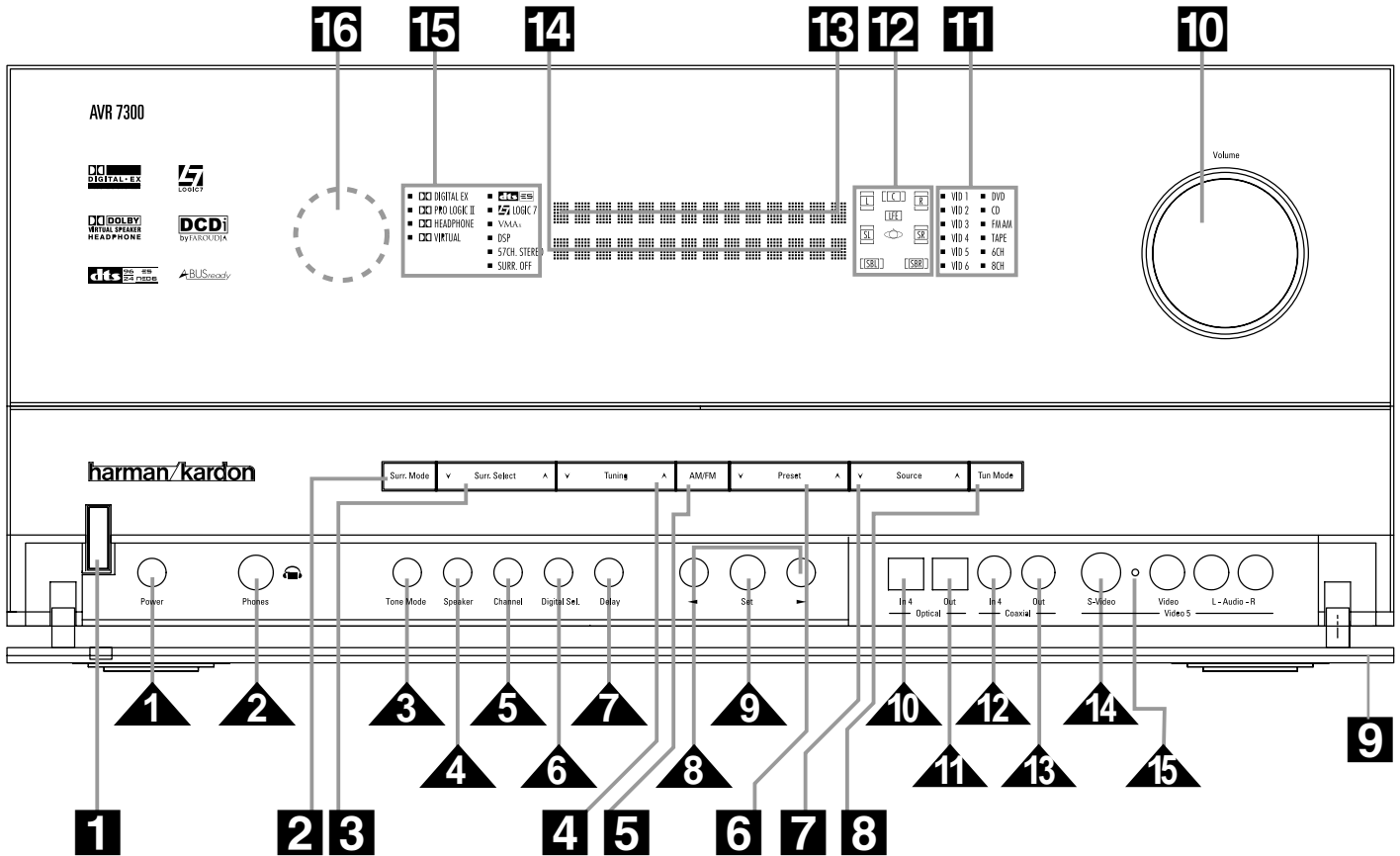

NOTE: To make it easier to follow the instructions that refer to this illustration, a larger copy may be downloaded from the Product Support section for this product at www.harmankardon.com.

The following controls and indicators are available on the AVR 7300's front panel:

- | | | |
|---------------------------------------|--|------------------------------------|
| 1 Standby/On Button | 7 Input Source Selector | 13 Upper Display Line |
| 2 Surround Mode Group Selector | 8 Tuner Mode Selector | 14 Lower Display Line |
| 3 Surround Mode Selector | 9 Front Panel Control Door | 15 Surround Mode Indicators |
| 4 Tuning Selector | 10 Volume Control | 16 Remote Sensor Window |
| 5 Tuner Band Selector | 11 Input Indicators | |
| 6 Preset Station Selector | 12 Speaker/Channel Input Indicators | |

The following controls and jacks are located behind the front panel door. To open the door gently press left or right bottom corner edge of the door in and gently swing the door down towards you.

- | | | |
|----------------------------------|-----------------------------------|-------------------------------------|
| 1 Main Power Switch | 6 Digital Input Selector | 11 Optical Digital Output |
| 2 Headphone Jack | 7 Delay Adjust Selector | 12 Coaxial 4 Digital Input |
| 3 Tone Mode Button | 8 ◀▶ Buttons | 13 Coaxial Digital Output |
| 4 Speaker Selector Button | 9 Set/Video Button | 14 Video 5 Audio/Video Jacks |
| 5 Channel Adjust Selector | 10 Optical 4 Digital Input | 15 Input/Output Indicator |

FRONT - PANEL CONTROLS

1 Standby/On Button: When the Main Power Switch  is pressed in so that it is in the "ON" position, press this button to turn on the AVR 7300. When the unit is in the Standby mode, the switch is surrounded by amber lighting. When the unit is on, the lighting around the button is blue.

2 Surround Mode Group Selector: Press this button to select the top-level group of surround modes. Each press of the button will select one of the surround mode categories. Once the button is pressed so that the name of the desired surround mode category appears in the on-screen display and in the **Lower Display Line 14**, press the **Surround Mode Selector 3** to cycle through the individual modes available. For example, press this button to select Dolby modes, and then press the **Surround Mode Selector 3** to choose from the various mode options.

3 Surround Mode Selector: Press this button to select from among the available surround mode options for the surround mode category selected. The specific modes will vary based on the number of speakers available, the surround mode category and whether the input source is digital or analog. For example, press the **Surround Mode Group Selector 2** to select a category such as Dolby or Logic 7, and then press this button to see the specific mode choices that are available. For more information on mode selection, see page XX.

4 Tuning Selector: Press the left side of the button to tune lower-frequency stations and the right side of the button to tune higher-frequency stations. When the tuner is in the **MANUAL / MONO** mode, each tap of the Selector will increase or decrease the frequency by one increment. When the tuner receives a strong-enough signal for adequate reception, **MANUAL TUNED** will appear in the **Lower Display Line 14** and in the on-screen display. When the tuner is in the **AUTO / STEREO** mode, press the button once, and the tuner will scan for a station with acceptable signal strength. When the next higher or lower frequency station with a strong-enough signal is tuned, the frequency scan will stop and the **Lower Display Line 14** and the on-screen display will indicate **AUTO TUNED**. When an FM Stereo station is tuned, the display will read **AUTO ST TUNED**. See page XX for more information on using the tuner.

5 Tuner Band Selector: Pressing this button will automatically switch the DPR 2005 to the Tuner mode. Pressing it again will switch between the AM and FM frequency bands. (See page XX for more information on the tuner.)

6 Preset Stations Selector: Press this button to scroll up or down through the list of stations that have been entered into the preset memory. (See page XX for more information on tuner programming.)

7 Input Source Selector: Press this button to change the input by scrolling up or down through the list of input sources.

8 Tuning Mode Selector: Press this button to select Auto or Manual tuning. When the button is pressed so that **AUTO / STEREO** appears in the **Upper Display Line 13**, the tuner will search for the next station with an acceptable signal when the **Tuning Selector 5 23 E** is pressed. When the button is pressed so that **MANUAL / MONO** appears in the **Upper Display Line 13**, each press of the **Tuning Selector 4 23 E** will increase the frequency. (See page XX for more information on using the tuner.) This button may also be used to switch between Stereo and Mono modes for FM radio reception. When weak reception is encountered, select the Manual/Mono tuning mode. Press and hold again to switch back to Stereo mode. (See page XX for more information on using the tuner.)

9 Front-Panel Control Door: To open the door so that the front-panel jacks and controls behind this door may be accessed, gently pull the door down and towards you using either lower corner of the door.

10 Volume Control: Turn this knob clockwise to increase the volume, counterclockwise to decrease the volume. If the AVR 7300 is muted, adjusting the volume control will automatically release the unit from the silenced condition.

11 Input Indicators: One of these indicators will light to identify the currently selected input. Note that the entire list will light briefly each time the unit is turned on as a test.

12 Speaker/Channel Input Indicators: These indicators are multipurpose, indicating both the speaker type selected for each channel and the incoming data-signal configuration. The left, center, right, right surround and left surround speaker indicators light as a single outline around the speaker position indicator when a "small" speaker is selected and as a larger icon with three connected boxes when "large" speakers are selected. When only the speaker position letters appear, no speaker has been assigned that position. (See page XX for more information on configuring speakers.) The letters inside each box also indicate the active input channels. For standard analog inputs, only the L and R will light, indicating a stereo input. For a digital source, the indicators will light to display

the channels being received at the digital input. When the letters flash, the digital input has been interrupted and an **UNLOCK** message may appear in the **Lower Display Line 14**. (See page XX for more information on the Channel Indicators.)

13 Upper Display Line: Depending on the unit's status, a variety of messages will appear here. In normal operation, this line will show the current input source and identify whether an analog or digital input is in use. When the tuner is selected as the input, this line will identify the station as AM or FM and show the frequency and preset number, if any.

14 Lower Display Line: Depending on the unit's status, a variety of messages will appear here. In normal operation, the current surround mode will appear on this line.

15 Surround Mode Indicators: One of these indicators will light to show the surround mode in use. Depending on the specific combination of input sources and surround mode selected, more than one indicator may light. (See page XX for more information.)

16 Remote Sensor Window: The sensor behind this window receives infrared signals from the remote control. Aim the remote at this area and do not block or cover it unless an external remote sensor is installed.

FRONT-PANEL CONTROLS

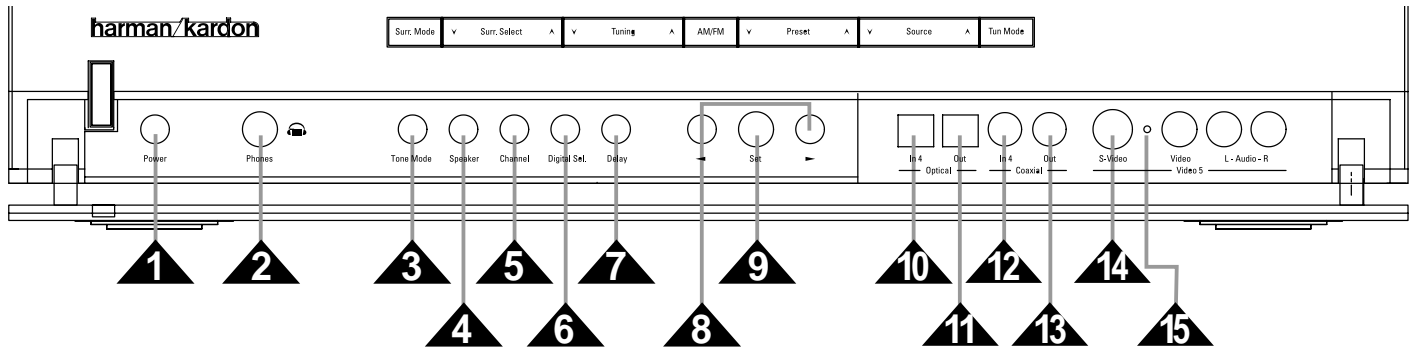

NOTE: To make it easier to follow the instructions that refer to this illustration, a larger copy may be downloaded from the Product Support section for this product at www.harmankardon.com.

The following controls and jacks are located behind the front-panel door. To open the door, place the edge of a finger on the left or right bottom edge of the panel and gently swing the door down towards you.

- | | | |
|-----------------------------|------------------------------|--------------------------------|
| ▲ 1 Main Power Switch | ▲ 6 Digital Input Selector | ▲ 11 Optical Digital Output |
| ▲ 2 Headphone Jack | ▲ 7 Delay Adjust Selector | ▲ 12 Coaxial 4 Digital Input |
| ▲ 3 Tone Mode Button | ▲ 8 ◀▶ Buttons | ▲ 13 Coaxial Digital Output |
| ▲ 4 Speaker Selector Button | ▲ 9 Set/Video Button | ▲ 14 Video 5 Audio/Video Jacks |
| ▲ 5 Channel Adjust Selector | ▲ 10 Optical 4 Digital Input | ▲ 15 Input/Output Indicator |

▲ **1 Main Power Switch:** Press this switch to apply power to the AVR 7300. When the switch is pressed in, the unit is placed in a Standby mode, as indicated by the lighting around the **Standby/On Indicator 1** turning amber. The switch **MUST** be pressed in to operate the unit. To turn the unit off and prevent the use of the remote control, this switch should be pressed until it pops out from the front panel so that the word "OFF" may be read at the top of the switch.

NOTE: This switch is normally left in the "ON" position.

▲ **2 Headphone Jack:** This jack may be used to listen to the AVR 7300's output through a pair of headphones. Be certain that the headphones have a standard 1/4" stereo phone plug, or that you use an adapter, as needed, to convert the plug on your headphones to the 1/4" jack used on the AVR. When the headphone jack is in use, the main room speakers will automatically be turned off and the unit will output a

standard stereo signal. You may also use one of the Dolby Headphone modes for an enhanced listening experience. For more information on headphone listening, see page XX.

▲ **3 Tone Mode Button:** This button controls the tone mode settings, enabling adjustment of the bass and treble boost/cut. You may also use it to take the tone controls out of the signal path completely for "flat" response. The first press of the button displays a **TONE MODE** message in the **Lower Display Line 14** and in the on-screen display. To take the controls out of the signal path, press either of the **▼/▲ Buttons 8** until the display reads **TONE OUT**. To change the bass or treble settings, press the button again until the desired option appears in the **Lower Display Line 14** and in the on-screen display and then press either of the **◀▶ Buttons 8** to enter the desired boost or cut setting. See page XX for more information on the tone controls.

▲ **4 Speaker Selector Button:** Press this button to begin the process of configuring the AVR 7300 for the type of speakers it is being used with. For complete information on configuring the speaker settings, see page XX.

▲ **5 Channel Adjust Selector:** Press the button to begin the process of adjusting the channel level outputs using the source currently playing through your DPR. For complete information on adjusting the channel output level, see page XX.

▲ **6 Digital Input Selector:** Press this button to begin the process of selecting a digital source for use with the currently selected input. Once the button has been pressed, use the **▼/▲ Buttons 8** to choose the desired input and then press the **Set/Video Button 9** to enter the setting into the unit's memory. See page XX for more information on digital audio.

FRONT - PANEL CONTROLS

7 **Delay Adjust Selector:** Press this button to begin the process of adjusting the delay settings. See page XX for more information on delay adjustments.

8 **▼/▲ Buttons:** When making system configuration changes using the front-panel controls, press these buttons to scroll through the available choices for the option being adjusted.

9 **Set/Video Button:** This button has two functions. Press it to turn the video processing circuits on or off, as indicated by **FAROUJJA : ON** or **FAROUJJA : OFF** messages in the **Lower Display Line 14** and semi-OSD display. (See page XX for more information on the video processing circuits.) The button is also used when making many of the configuration and setup adjustments from the front panel. When selecting a specific item to adjust, or after selection a configuration setting with the **◀/▶ Buttons 9**, press this button to enter the setting information to the unit's memory.

10 **Optical 4 Digital Input:** Connect the optical digital output of an audio or video product to this jack.

11 **Optical Digital Output:** Connect this jack to the optical digital audio input of a compatible digital recorder.

12 **Coaxial 4 Digital Jack:** Connect the coaxial digital input or output for a digital audio product such as a portable audio player or video game to this jack. The jack is normally an input, but may be switched to an output for recording using the menu system. See page XX for more information.

13 **Coaxial Digital Output:** Connect this jack to the digital digital audio input of a compatible digital recorder.

14 **Video 5 Input/Output Jacks:** These audio/video jacks may be used as either an input or output for temporary connection to video games or portable audio/video products such as camcorders and portable audio players. (See page XX for more information on switching these jacks between an input and output.)

15 **Input/Output Status Indicator:** This LED indicator will normally light green to show that the front-panel **Video 5 Input/Output Jack 15** is operating as an input. When this jack is configured for use as an output, the appropriate indicator will turn red to show that the jack may be used as an output for recording. (See page XX for more information on configuring the front-panel jacks as outputs, rather than inputs.)

REAR-PANEL AUDIO CONNECTIONS

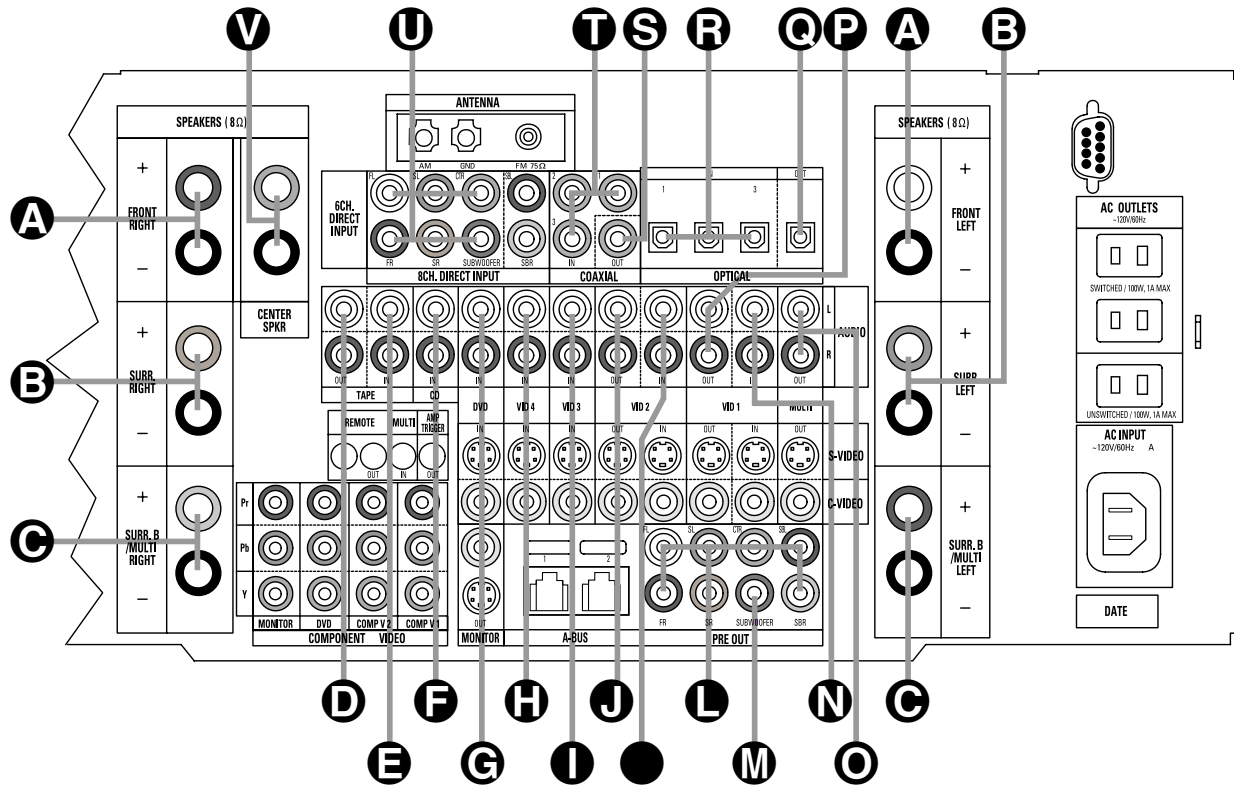

NOTE: To make it easier to follow the instructions that refer to this illustration, a larger copy may be downloaded from the Product Support section for this product at www.harmaninternational.com.

- | | | |
|--|----------------------------------|--|
| A Front Speaker Outputs | I Video 3 Audio Inputs | Q Optical Digital Audio Output |
| B Surround Speaker Outputs | J Video 2 Audio Outputs | R Optical Digital Audio Inputs |
| C Surround Back/Multiroom Speaker Outputs | K Video 2 Audio Inputs | S Coaxial Digital Output |
| D Tape Outputs | L Preamp Outputs | T Coaxial Digital Audio Inputs |
| E Tape Inputs | M Subwoofer Output | U 8 Channel Direct Audio Inputs |
| F CD Inputs | N Video 1 Audio Inputs | V Center Speaker Output |
| G DVD Audio Inputs | O Multiroom Audio Outputs | |
| H Video 4 Audio Inputs | P Video 1 Audio Outputs | |

NOTE: To assist in making the correct connections for multichannel input, output and speaker connections, all connection jacks and terminals are color-coded in conformance with the CEA standards as follows:

Front Left:	White	Subwoofer:	Purple
Front Right:	Red	Digital Audio:	Orange
Center:	Green	Composite Video:	Yellow
Surround Left:	Blue	Component Video "Y":	Green
Surround Right:	Gray	Component Video "Pr":	Red
Surround Back Left:	Brown	Component Video "Pb":	Blue
Surround Back Right:	Tan		

REAR-PANEL AUDIO CONNECTIONS

A Front Speaker Outputs: Connect these outputs to the matching + or – terminals on your left and right speakers. When making speaker connections always make certain to maintain correct polarity by connecting the color-coded (white for front left and red for front right) (+) terminals on the DPR 2005 to the red (+) terminals on the speakers and the black (–) terminals on the DPR 2005 to the black (–) terminals on the speakers. See page 16 for more information on speaker polarity.

B Surround Speaker Outputs: Connect these outputs to the matching + and – terminals on your surround channel speakers. In conformance with the CEA color-code specification, the blue terminal is the positive, or “+” terminal that should be connected to the red (+) terminal on the Surround Left speaker with older color-coding, while the gray terminal should be connected to the red (+) terminal on the Surround Right speaker with the older color-coding. Connect the black (–) terminal on the AVR to the matching black negative (–) terminals for each surround speaker. (See page XX for more information on speaker polarity.)

C Surround Back/Multiroom Speaker Outputs: These speaker terminals are normally used to power the surround back left/surround back right speakers in a 7.1-channel system. However, they may also be used to power the speakers in a second zone, which will receive the output selected for a multiroom system. To change the output fed to these terminals from the default of the Surround Back speakers to the Multiroom Output, you must change a setting in the **MULTI-ROOM SETUP** menu of the OSD system. See page XX for more information on configuring this speaker output. In normal surround system use, the brown and black terminals are the surround back left channel positive (+) and negative (–) connections and the tan and black terminals are the surround back right positive (+) and negative (–) terminals. For multiroom use, connect the brown and black SBL terminals to the red and black connections on the left remote zone speaker and connect the tan and black SBR terminals to the red and black terminals on the right remote zone speaker.

D Tape Outputs: Connect these jacks to the Record/Input jacks of an audio recorder.

E Tape Inputs: Connect these jacks to the Play/Out jacks of an audio recorder.

F CD Audio Inputs: Connect these jacks to the left/right analog audio output of a compact disc player or CD changer or other audio source.

G DVD Audio Inputs: Connect the left/right analog audio jacks of a DVD player or other video source to these jacks. When digital audio and/or component video outputs are used with a DVD player and the AVR 7300, the default connection points are the **Coaxial 1 Digital Audio Input**

H and the **DVD Component Video Inputs F**. If other jacks are used to connect a DVD player, the AVR may be reconfigured to accommodate the hookup by using the **IN/OUT SETUP** menu as shown on page XX.

H Video 4 Audio Inputs: Connect the left/right analog audio outputs of a video device to these jacks. The AVR 7300's remote control has a satellite receiver as the default for this input, but you may connect any video source such as a VCR, HDTV receiver, personal video recorder, or other device to these inputs. Note that if the source device offers either digital audio or component video capability, those connections must be made separately, and the AVR 7300 configured accordingly. (See page XX for more information on configuring an input for various source options.)

I Video 3 Audio Inputs: Connect the left/right analog audio outputs of a video device to these jacks. The AVR 7300's remote control has a cable set-top as the default for this input, but you may connect any video source such as a VCR, HDTV or satellite receiver, personal video recorder, or other device to these inputs. Note that if the source device offers either digital audio or component video capability, those connections must be made separately, and the AVR 7300 configured accordingly. (See page XX for more information on configuring an input for various source options.)

J Video 2 Audio Outputs: Connect the left/right analog audio RECORD/IN jacks of a video recording device such as a VCR, DVD-Recorder or personal video recorder to these jacks.

K Video 2 Audio Inputs: Connect the left/right analog audio PLAY/OUT jacks of a video recording device such as a VCR, DVD-Recorder or personal video recorder to these jacks. The AVR 7300's remote control has a “TV” as the default for this input, but you may connect any video source such as a VCR, HDTV or cable set-top box, personal video recorder, or other device to these inputs. Note that if the source device offers either digital audio or component video capability, those connections must be made separately, and the AVR 7300 configured accordingly. (See page XX for more information on configuring an input for various source options.)

L Preamp Outputs: Connect these jacks to an optional, external power amplifier for applications where higher power is desired.

M Subwoofer Output: Connect this jack to the line-level input of a powered subwoofer. If an external subwoofer amplifier is used, connect this jack to the subwoofer amplifier input.

N Video 1 Audio Outputs: Connect the left/right analog audio RECORD/IN jacks of a video recording device such as a VCR, DVD-Recorder or personal video recorder to these jacks.

O Multiroom Audio Outputs: Connect these jacks to the optional external audio power amplifier that delivers the source selected for multizone distribution.

P Video 1 Audio Inputs: Connect the left/right analog audio PLAY/OUT jacks of a video recording device such as a VCR, DVD-Recorder or personal video recorder to these jacks.

The AVR 7300's remote control has a VCR as the default for this input, but you may connect any video source such as a VCR, HDTV or cable set-top box, personal video recorder, or other device to these inputs. Note that if the source device offers either digital audio or component video capability, those connections must be made separately, and the AVR 7300 configured accordingly. (See page XX for more information on configuring an input for various source options.)

Q Optical Digital Audio Output: Connect this jack to the optical digital input connector on a CD-R/RW, MiniDisc or other compatible digital recorder.

R Optical Digital Audio Inputs: Connect the optical digital output from a DVD player, HDTV receiver, the S/P-DIF output of a compatible computer sound card playing MP3 files or streams, LD player or CD player to these jacks. The signal may be a Dolby Digital signal, a DTS signal or a standard PCM digital source.

S Coaxial Digital Audio Output: Connect this jack to the coaxial digital input of a CD-R/RW, MiniDisc or other compatible digital recorder.

T Coaxial Digital Audio Inputs: Connect the coax digital output from a DVD player, HDTV receiver, the S/P-DIF output of a compatible computer sound card playing MP3 files or streams, LD player or CD player to these jacks. The signal may be a Dolby Digital signal, DTS signal or a standard PCM digital source. Do not connect the RF digital output of an LD player to these jacks.

U 8-Channel Direct Inputs: These jacks are used for connection to source devices such as DVD-Audio or SACD players with discrete analog outputs. Depending on the source device in use, all eight jacks may be used, though in many cases only connections to the front left/right, center, surround left/right and LFE (subwoofer input) jacks will be used for standard 5.1 audio signals.

V Center Speaker Outputs: Connect these outputs to the matching + and – terminals on your center channel speaker. In conformance with the CEA color-code specification, the green terminal is the positive, or “+” terminal that should be connected to the red (+) terminal on speakers with the older color-coding. Connect the black (–) terminal on the DPR to the black negative (–) terminal on your speaker. (See page 16 for more information on speaker polarity.)

VIDEO AND SYSTEM CONNECTIONS

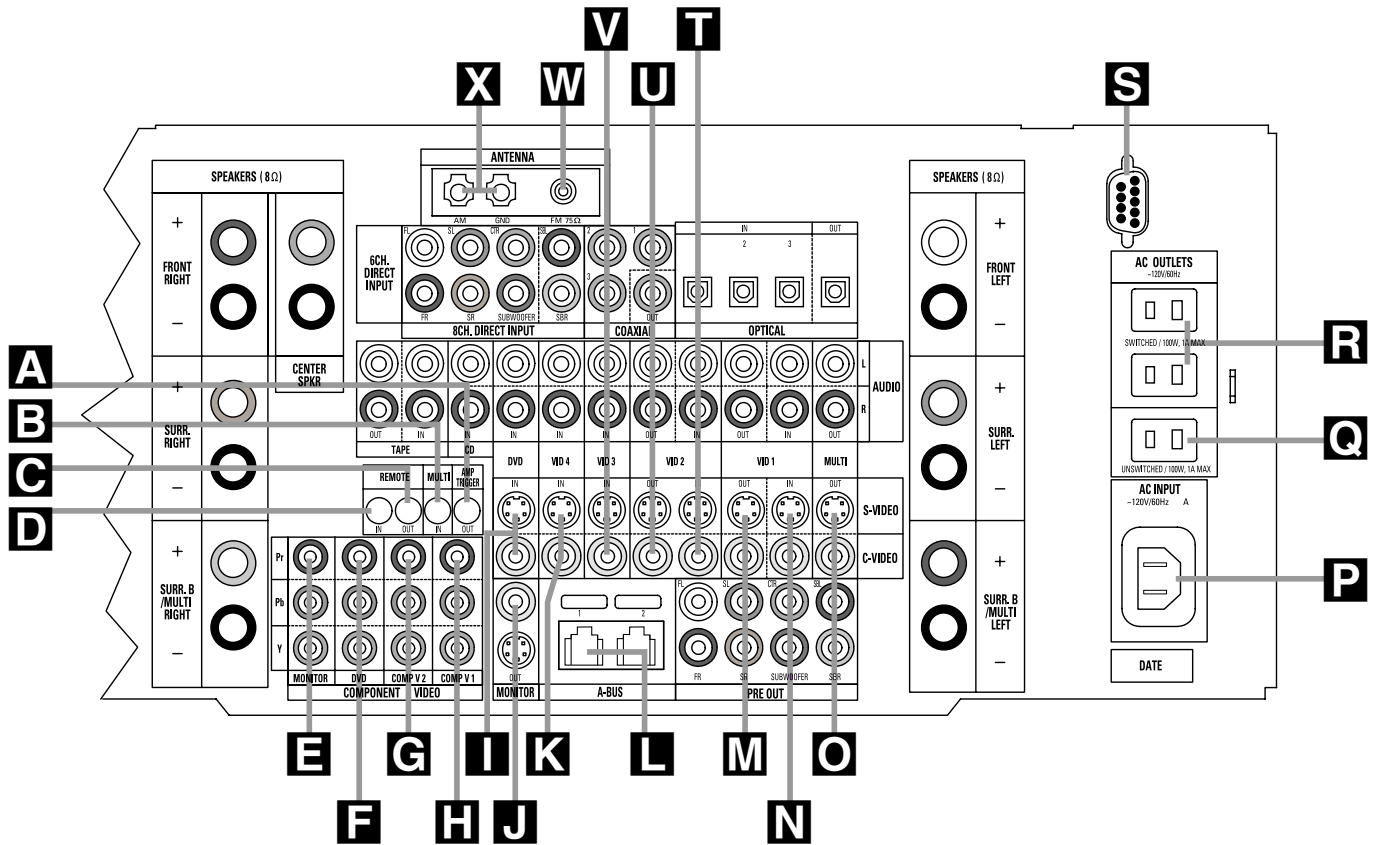

NOTE: To make it easier to follow the instructions that refer to this illustration, a larger copy may be downloaded from the Product Support section for this product at www.harmanardon.com.

- | | | |
|--|----------------------------------|--------------------------------|
| A Amp Trigger | I DVD Video Inputs | Q Unswitched AC Outlet |
| B Multiroom IR Input | J Video Monitor Outputs | R Switched AC Outlets |
| C Remote IR Output | K Video 4 Video Inputs | S RS-232 Port |
| D Remote IR Input | L A-Bus Connectors | T Video 2 Video Inputs |
| E Component Video Monitor Outputs | M Video 1 Video Outputs | U Video 2 Video Outputs |
| F DVD Component Video Inputs | N Video 1 Video Inputs | V Video 3 Video Inputs |
| G Component Video 2 Inputs | O Multiroom Video Outputs | W FM Antenna Jack |
| H Component Video 1 Inputs | P AC Power Cord Jack | X AM Antenna Terminals |

NOTE: To assist in making the correct connections for multichannel input, output and speaker connections, all connection jacks and terminals are color-coded in conformance with the CEA standards as follows:

Front Left:	White	Subwoofer:	Purple
Front Right:	Red	Digital Audio:	Orange
Center:	Green	Composite Video:	Yellow
Surround Left:	Blue	Component Video "Y":	Green
Surround Right:	Gray	Component Video "Pr":	Red
Surround Back Left:	Brown	Component Video "Pb":	Blue
Surround Back Right:	Tan		

VIDEO AND SYSTEM CONNECTIONS

A Amp Trigger: Connect this jack to a the "Trigger In" jack of an optional, external power amplifier that is equipped for remote turn-on via a xx volt signal. When this connection is used, the AVR 7300 will automatically send a low voltage signal that turns on the amp when the AVR is on, and since the signal is not present when the AVR is turned off, the amplifier will also turn off with the AVR 7300.

B Multiroom IR Input: Connect the output of an IR sensor in a remote room to this jack to operate the AVR's multiroom control system.

C Remote IR Output: This connection permits the IR sensor in the receiver to serve other remote controlled devices. Connect this jack to the "IR IN" jack on Harman Kardon (or other compatible) equipment.

D Remote IR Input: If the AVR 7300's front-panel IR sensor is blocked due to cabinet doors or other obstructions, an external IR sensor may be used. Connect the output of the sensor to this jack.

E Component Video Monitor Outputs: Connect these outputs to the component video inputs of a video projector or monitor. When a source connected to one of the **Component Video Inputs EGH** is selected the signal will be sent to these jacks.

F DVD Component Video Inputs: Connect the component video outputs of a DVD player or any other video source equipped with Y/Pr/Pb or RGB component video outputs to these jacks. The factory default is for these jacks to be linked to the **DVD audio inputs G** and the **Coaxial 1 Digital Audio Input H**, but you may change the setting at any time through the **IN/OUT SETUP** Menu. See page XX for more information on configuring the component video inputs.

G Component Video 2 Inputs: These inputs may be used with any video source device equipped with analog Y/Pr/Pb or RGB component video outputs. The factory default is for these jacks to be linked to the Video 2 through Video 4 inputs, but you may change the setting at any time through the **IN/OUT SETUP** menu. See page XX for more information on configuring the component video inputs.

H Component Video 1 Inputs: These inputs may be used with any video source device equipped with analog Y/Pr/Pb or RGB component video outputs. The factory default is for these jacks to be linked to the Video 1 input, but you may change the setting at any time through the **IN/OUT SETUP** menu. See page XX for more information on configuring the component video inputs.

I DVD Video Inputs: These inputs may be used with any video source device equipped with analog

~~Y/Pr/Pb or RGB component video outputs. The factory default is for these jacks to be linked to the Video 1 input, but you may change the setting at any time through the **IN/OUT SETUP** menu. See page XX for more information on configuring the component video inputs.~~

J Video Monitor Outputs: Connect these jacks to the composite or S-Video input of a TV monitor or video projector to view the on-screen menus and the output of any standard video source selected by the receiver's video switcher. Note that if both standard composite and S-Video sources are used, you must make connections from both Video Monitor Output jacks to your video display. In addition, if component video sources are used, you must also connect the **Component Video Outputs E** to the video display.

K Video 4 Video Inputs: Connect the composite or S-Video jacks of a video device to these jacks. The AVR 7300's remote control has a satellite receiver as the default for this input, but you may connect any video source such as a VCR, HDTV receiver, personal video recorder, or other device to these inputs. (See page XX for more information on configuring an input for various source options.)

L A-BUS Connectors: Connect these jacks to an optional A-BUS®-certified remote modules to extend the multiroom capabilities of your AVR 7300. See page XX for more information on A-BUS.

M Video 1 Outputs: Connect the composite or S-Video RECORD/IN jacks of a video recording device such as a VCR, DVD-Recorder or personal video recorder to these jacks.

N Video 1 Inputs: Connect the composite or S-Video PLAY/OUT jacks of a video recording device such as a VCR, DVD-Recorder or personal video recorder to these jacks. The AVR 7300's remote control has a VCR as the default for this input, but you may connect any video source such as a VCR, HDTV or cable set-top box, personal video recorder, or other device to these inputs. (See page XX for more information on configuring an input for various source options.)

O Multiroom Video Outputs: : Connect these jacks to an the cabling and/or an optional, external video distribution amplifier that delivers the video source selected for the multizone distribution to the remote rooms.

P AC Power Cord Jack: Connect the AC power cord to this jack when the installation is complete. To ensure safe operation, use only the power cord supplied with the unit. If a replacement is required, it must be of the same type and capacity.

Q Unswitched AC Outlet: This outlet may be used to power any AC device. The power will remain on at

this outlet regardless of whether the DPR 2005 is on or off.

R Switched AC Outlets: These outlets may be used to power any device you wish to have turned on when the DPR 2005 is turned on with the **Standby/On Switch 1**.

S RS-232 Port: This jack may be used to control the AVR 7300 over a bi-directional RS-232 serial control link to a compatible computer or programmable remote control system. Due to the complexity of programming RS-232 commands we strongly recommend that connections to this port for control purposes be made by a trained and qualified technician. This jack may also link to a compatible computer to upgrade the software and operating system of the AVR 7300 when appropriate upgrades are available.

T Video 1 Inputs: Connect the composite or S-Video PLAY/OUT jacks of a video recording device such as a VCR, DVD-Recorder or personal video recorder to these jacks. The AVR 7300's remote control has a VCR as the default for this input, but you may connect any video source such as a VCR, HDTV or cable set-top box, personal video recorder, or other device to these inputs. (See page XX for more information on configuring an input for various source options.)

U Video 2 Outputs: Connect the composite or S-Video RECORD/IN jacks of a video recording device such as a VCR, DVD-Recorder or personal video recorder to these jacks.

V Video 3 Video Inputs: Connect the composite or S-Video jacks of a video device to these jacks. The AVR 7300's remote control has a satellite receiver as the default for this input, but you may connect any video source such as a VCR, HDTV receiver, personal video recorder, or other device to these inputs. (See page XX for more information on configuring an input for various source options.)

W FM Antenna: Connect the supplied indoor or an optional external FM antenna to this terminal.

X AM Antenna: Connect the AM loop antenna supplied with the receiver to these terminals. If an external AM antenna is used, make connections to the **AM** and **GND** terminals in accordance with the instructions supplied with the antenna.

NOTE: The total power consumption of all devices connected to the rear panel AC outlets should not exceed 100 watts.

MAIN REMOTE CONTROL FUNCTIONS

- 1 Power Off Button
- 2 Power On Button
- 3 LCD Information Display
- 4 Input Selectors
- 5 AVR Selector
- 6 DSP Surround Mode Selector
- 7 Test Button
- 8 Video Processing On/Off Button
- 9 Direct Button
- 10 Clear Button
- 11 Numeric Keys
- 12 Tuning Mode Button
- 13 Dim Button
- 14 Channel Select Button
- 15 Navigation Button
- 16 Digital Select Button
- 17 Set Button
- 18 Volume Up/Down Buttons
- 19 Transport Fast-Play/Scan Buttons
- 20 Main Transport Controls
- 21 Track Skip Up/Down Buttons
- 22 Preset Up/Down Button
- 23 Tuning Up/Down Button
- 24 Disc Skip Button
- 25 Program Button
- 26 Light Button
- 27 Multiroom Button
- 28 Macro Buttons
- 29 Sleep Button
- 30 Night Mode Button
- 31 OSD Button
- 32 Tone Control Button
- 33 Mute Button
- 34 AM/FM Button
- 35 Channel Up/Down Selector
- 36 Transport Play Buttons
- 37 Delay Select Button
- 38 Speaker Select Button
- 39 Memory Button
- 40 Stereo Mode Select Button
- 41 DTS Neo:6 Mode Select Button
- 42 Logic 7 Mode Select Button
- 43 DTS Digital Mode Select Button
- 44 Dolby Mode Select Button
- 45 6/8-Channel Input Select
- 46 SPL Select Button
- 47 EzSet Microphone Sensor
- 48 Lens

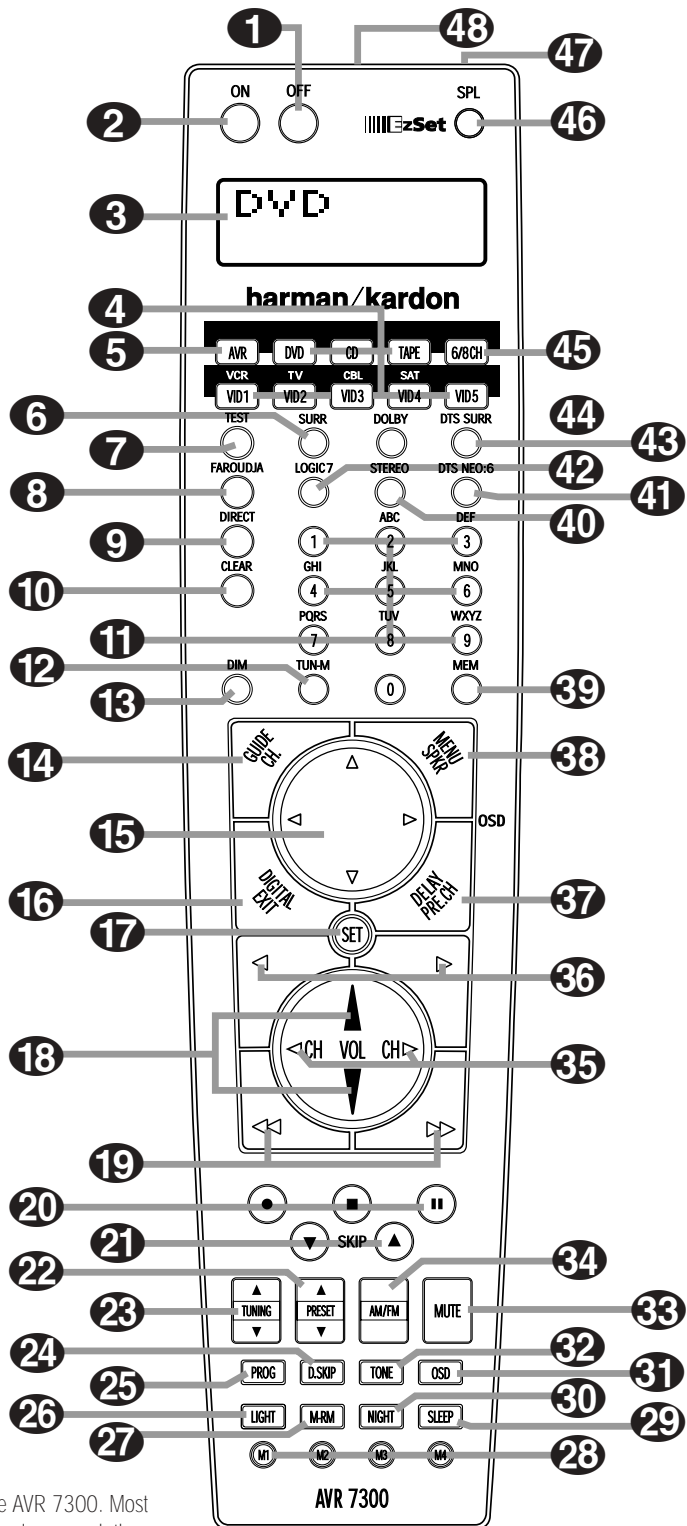

NOTES:

- The function names shown here are each button's feature when used with the AVR 7300. Most buttons have additional functions when used with other devices. When a button is pressed, the function name will appear in the bottom line of the LCD Information Display 3.
- The jack on the upper right side of the remote is reserved for future use. Do not remove the plug provided or connect any device to the jack.
- To make it easier to follow the instructions that refer to this illustration, a larger copy may be downloaded from the Product Support section for this product at www.harmankardon.com.

MAIN REMOTE CONTROL FUNCTIONS

IMPORTANT NOTE: The AVR 7300's remote may be programmed to control up to nine devices, including the AVR 7300. Before using the remote, it is important to remember to press the **Input Selector Button 4** that corresponds to the unit you wish to operate. In addition, the AVR 7300's remote is shipped from the factory to operate the AVR 7300 and most Harman Kardon CD or DVD players and cassette decks. The remote is also capable of operating a wide variety of other products using the control codes that are part of the remote. Before using the remote with other products, follow the instructions on pages XX – XX to program the proper codes for the products in your system.

It is also important to remember that many of the buttons on the remote take on different functions, depending on the product selected using the **Input Selectors 4**. The descriptions shown here primarily detail the functions of the remote when it is used to operate the AVR 7300.

- 1 Power Off Button:** Press this button to place the AVR 7300 or a selected device in the Standby mode. Note that this will turn off the main room functions, but if the Multiroom system is activated, it will continue to function.
- 2 Power On Button:** Press this button to turn on the power to a device selected by first pressing one of the **Input Selectors 4**.
- 3 LCD Information Display:** This two-line screen displays various information depending on the commands that have been entered into the remote.
- 4 Input Selectors:** Pressing one of these buttons will perform three actions at the same time. First, if the AVR 7300 is not turned on, this will power up the unit. Next, it will select the source shown on the button as the input to the AVR 7300. Finally, it will change the remote control so that it controls the device selected. After pressing one of these buttons you must press the **AVR Selector Button 5** again to operate the AVR 7300's functions with the remote.
- 5 AVR Selector:** Pressing this button will switch the remote so that it will operate the AVR 7300's functions. If the AVR 7300 is in the Standby mode, it will also turn the AVR 7300 on.
- 6 DSP Surround Mode Selector:** Press this button to select one of the DSP surround modes, such as VMAx, Hall 1, Hall 2 or Theater. Each press of the button selects another mode. (See page XX for more information on surround modes.)

7 Test Button: Press this button to begin the sequence used to calibrate the AVR 7300's output levels. (See page XX for more information on calibrating the AVR 7300.)

8 Video Processing On/Off Button: Press this button to turn the video processing circuits on or off. See page xx for more information.

9 Direct Button: Press this button when the tuner is in use to start the sequence for direct entry of a station's frequency. After pressing the button, simply press the proper **Numeric Keys 11** to select a station. (See page XX for more information on the tuner.)

10 Clear Button: When programming the remote or using the EzSet feature, press this button to cancel the current function. When using the remote to enter frequencies for direct tuner access, press this button to clear previous entries.

11 Numeric Keys: These buttons serve as a ten-button numeric keypad to enter tuner preset positions. They are also used to select channel numbers when TV, Cable or SAT has been selected on the remote, or to select track numbers on a CD, DVD or LD player, depending on how the remote has been programmed. These buttons are also used to enter letters and numbers when renaming devices in the LCD Information Display. (See page XX for more information on renaming devices and keys.)

12 Tuning Mode Button: Press this button to change the tuner mode between manual and automatic. When the button is pressed so that **AUTO / STEREO** appears in the **Upper Display Line 13** and in the on-screen display, only stations with acceptable signal quality will be tuned, and the tuner will play FM stations in stereo, when available. In the **AUTO** mode, when the **Tuning Up/Down Buttons 8 23 E** are pressed, the unit will automatically search for the next available station with good signal strength. When this button is pressed so that **MANUAL / MONO** appears in the **Upper Display Line 13** and in the on-screen display each press of the **Tuning Up/Down Buttons 8 23 E** will move the frequency up or down in single-step increments. When the FM band is in use, pressing the button so that the **MANUAL** mode is activated will enable you to tune stations with weak signals by changing to monaural reception. (See page XX for more information on tuner operation.)

13 Dim Button: This button activates the Dimmer function, which reduces the brightness of the front-panel display, or turns it off entirely. Press the button once to reduce the display brightness by 50%, and press it again within five seconds and the main display will go completely dark. Note that this setting is temporary; regardless of any changes, the display will always return to full brightness when the AVR is turned on. The blue accent lighting inside the volume control will go out when the panel lights are at half brightness or when they are fully dimmed.

14 Channel Select Button: This button is used to start the process of setting the AVR 7300's output levels to an external source. Once this button is pressed, press the **▲/▼** on the **Navigation Button 15** to select the channel being adjusted, then press the **Set Button 17**, followed by the **▲/▼** on the **Navigation Button 15** again, to change the level setting. (See page XX for more information.)

15 Navigation Button: This single disc-like button is used to navigate through the on-screen configuration menus, to scroll through the options list and to select choices for the various settings such as delay, speakers, surround modes, digital inputs, etc. To use the button, simply press it left, right, up or down in the direction indicated by the **▲▼◀▶** icons printed on the button disc. Depending on the menu being used, pressing the button will either change a specific menu or configuration choice or it will change the option shown in the on-screen or front-panel display. The sections in this manual describing the unit's individual features and configuration options contain specific information on how the navigation controls are used.

16 Digital Select Button: Press this button to assign one of the digital inputs **F T 10 12** to a source. (See page 33 for more information on using digital inputs.)

17 Set Button: This button is used to enter settings into the AVR 7300's memory. It is also used in the setup procedures for delay time, speaker configuration and channel output level adjustment.

18 Volume Up/Down Buttons: These controls share the disc in the lower portion of the remote with the **Channel Up/Down Selector 35**. To raise the volume, press the button marked **▲** by pressing towards the top of the remote. To lower the volume, press the button marked **▼** by pressing towards the bottom of the remote. The **◀▶** buttons on the left and right sides of this disc change channels up or down when the TV, cable box or satellite **Input Selectors 4** have been pressed.

MAIN REMOTE CONTROL FUNCTIONS

19 Transport Fast-Play/Scan Buttons: These buttons have no direct function on the AVR 7300, but they are used when the remote is programmed for a compatible DVD, CD or tape player. Pressing these buttons will transmit a fast-play forward, fast-play reverse, or fast-forward or fast-reverse scan command, according to the capabilities of the player being controlled. In the factory default setting, these buttons are preprogrammed with the remote codes for Harman Kardon DVD players so that you may control a compatible player even when the remote is directly controlling the DPR, a TV set, or a cable or satellite set-top box.

20 Main Transport Controls: These buttons have no direct function on the AVR 7300 but are used when the remote is programmed for a compatible DVD, CD or tape player. Pressing these buttons will transmit a stop (■), record (●), or pause (⏸) command, according to the capabilities of the player being controlled. In the factory default setting, these buttons are programmed with the remote codes for Harman Kardon DVD players so that you may control a compatible player even when the remote is directly controlling the AVR, a TV set, or a cable or satellite set-top box.

21 Track Skip Up/Down Buttons: These buttons do not have a direct function with the AVR 7300, but when used with a compatibly programmed CD or DVD changer will change the track or chapter currently being played. In the factory default setting, these buttons are programmed with the remote codes for Harman Kardon DVD players so that you may control a compatible player even when the remote is directly controlling the AVR, a TV set, or a cable or satellite set-top box.

22 Preset Up/Down Button: When the tuner is in use, press this button to scroll through the stations programmed into the AVR 7300's memory.

23 Tuning Up/Down Button: Press this button when the tuner is in use to change the station to one with a higher or lower frequency. When the tuner is in the **MANUAL / MONO** mode, each tap of the Selector will increase or decrease the frequency by one increment. When the tuner receives a strong-enough signal for adequate reception, **MANUAL TUNED** will appear in the Lower Display Line 14 and in the on-screen display. When the tuner is in the **AUTO / STEREO** mode, press the button

once, and the tuner will scan for a station with acceptable signal strength. When the next higher- or lower-frequency station with a strong enough signal is tuned, the frequency scan will stop and the Lower Display Line 14 and the on-screen display will indicate **AUTO TUNED**. When an FM Stereo station is tuned, the display will read **AUTO ST TUNED**. See page 35 for more information on using the tuner.

24 Disc Skip Button: This button has no direct function for the AVR 7300 but may be used to change the disc in a CD or DVD changer when the remote is programmed for that type of device.

25 Program Button: This button is used to begin the process of programming the remote. Press and hold this button for three seconds to place the remote in the programming mode. Once the red LED under the Set Button 17 lights, release the button. You may then select from the desired option. (See pages XX – XX for more information on configuring the remote.)

26 Light Button: Press this button to activate the remote's backlight for ease of use in darkened rooms.

27 Multiroom Button: Press this button to begin the process of activating the multiroom system or to change the input or volume level for the second zone. (See page XX for more information on the multiroom system.)

28 Macro Buttons: Press these buttons to store or recall a "Macro", which is a preprogrammed sequence of commands stored in the remote. (See page XX for more information on macros.)

29 Sleep Button: Press this button to place the unit in the Sleep mode. After the time shown in the display, the AVR 7300 will automatically go into the Standby mode. Each press of the button changes the time until turn-off in the following order:

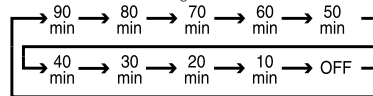

When the Sleep timer is in use, the front-panel displays and other indicators will dim to half-brightness.

30 Night Mode Button: Press this button to activate the Night mode. This mode is available in specially encoded Dolby Digital sources, and it preserves dialogue (center channel) intelligibility at low volume levels.

31 OSD Button: Press this button to activate or turn off the On-Screen Display (OSD) system used to set up or adjust the AVR 7300's parameters.

32 Tone Control Button: This button controls the tone mode settings, enabling adjustment of the bass and treble boost/cut. You may also use it to take the tone controls out of the signal path completely for "flat" response. The first press of the button displays a **TONE IN** message in the Lower Display Line 14 and in the on-screen display. To take the controls out of the signal path press either of the ▲/▼ Navigation Buttons 15 until the display reads **TONE OUT**. To change the bass or treble settings, press the button again until the desired option appears in the Lower Display Line 14 and on-screen display and then press either of the ▲/▼ Navigation Buttons 15 to enter the desired boost or cut setting. See page XX for more information on the tone controls.

33 Mute Button: Press this button to momentarily silence the AVR 7300 or TV set being controlled, depending on which device has been selected.

34 AM/FM Button: Press this button to select the AVR 7300's tuner as the listening choice. Pressing this button when the tuner is already in use will select between the AM and FM bands.

35 Channel Up/Down Selector: These selectors share the disc in the lower portion of the remote with the Volume Up/Down Buttons 18. They have no function when the DPR is being controlled, but when programmed for use with a VCR, TV, cable box, satellite receiver or other similar product they will change the channel up or down. See pages XX – XX for more information on programming the remote.

36 Transport Play Buttons: These buttons have no direct function on the AVR 7300, but they are used when the remote is programmed for a compatible DVD, CD or tape player. Pressing these buttons will transmit a forward- or reverse-play command, according to the capabilities of the player being controlled. In the factory default setting, these buttons are programmed for Harman Kardon DVD players so that you may control a compatible player even when the remote is directly controlling the AVR, a TV set or a cable or satellite set-top box.

MAIN REMOTE CONTROL FUNCTIONS

37 Delay Select Button: This button selects adjustments to the A/V Sync Delay and the individual channel delays. The first press of the button displays an **A / V SYNC DELAY** message in the **Lower Display Line 14** and in the on-screen display, which means that you may change the amount of time that all channels are delayed together behind the video. This enables you to compensate for the loss of lip sync that may be caused by digital video processing in your display or by television stations. To change the A/V Sync Delay, press the **Set Button 17** while the **A / V SYNC DELAY** message is visible and then use the **▲/▼ Navigation Button 15** to change the setting so that the sound and the video image are in sync. To change the delay for an individual output channel, press the **▲/▼ Navigation Button 15** until the desired channel name is shown, and then press the **Set Button 17**. Use the **▲/▼ Navigation Buttons 15** to change the delay amount. (See page XX for more information on delay options.)

38 Speaker Select Button: Press this button to begin the process of configuring the AVR 7300's bass management system. Then press the **▲/▼ Navigation Button 15** to select the channel you wish to set up. Press the **Set Button 17** and then select another channel to configure. When all adjustments have been completed, press the **Set Button 17** twice to exit the settings and return to normal operation. (See page XX for more information on speaker setup.)

39 Memory Button: Press this button to enter a radio station to the AVR 7300's preset memory. First, tune the desired station, and then press this button. Within five seconds of when you see the station's frequency flash in the **Upper Display Line 16** and in the on-screen display, press the numeric keys for the preset number between 01 and 30 that you wish to assign to the station. (See page XX for more information.)

40 Stereo Mode Select Button: Press this button to select a stereo listening mode. When the button is pressed so that **SURROUND OFF** appears in the **Lower Display Line 17**, the AVR will operate in a bypass mode with true, fully analog, two-channel

left/right stereo mode with no surround processing or bass management, as opposed to other modes where digital processing is used. When the button is pressed so that **SURROUND OFF** appears in the **Lower Display Line 17**, and the **DSP** and **SURROUND OFF Surround Mode Indicators 18** are lit, you will enjoy a two-channel presentation of the sound along with the benefits of bass management. Depending on whether your system is configured for 5.1 or 6.1/7.1 channels, the next press of the button will cause either **5 CH STEREO** or **7 CH STEREO** to appear, and the stereo signal will be routed to all five (or seven) speakers. (See page XX for more information on stereo playback modes.)

41 DTS Neo:6 Mode Select Button: Press this button as needed to select one of the DTS Neo:6 modes. (See page XX for the available DTS Neo:6 options.)

42 Logic 7 Mode Select Button: Press this button to select from among the available Logic 7 surround modes. (See page XX for the available Logic 7 options.)

43 DTS Digital Mode Select Button: When a DTS-encoded digital source is playing, each press of this button will scroll through the available DTS modes. The specific choice of modes will vary according to the type of encoding on the disc and your system's speaker configuration. When a DTS source is not in use, this button has no function. (See page XX for the available DTS digital options.)

44 Dolby Mode Select Button: This button is used to select from the available Dolby Surround modes. Each press of this button will select one of the Dolby Pro Logic II or Dolby Pro Logic IIx modes. When a Dolby Digital-encoded source is in use, the Dolby Digital mode may also be selected. (See page XX for the available Dolby surround mode options.)

45 8-Channel Input Select: Press this button to select the device connected to the **8-Channel Direct Inputs 40**. (See page XX for more information.)

46 SPL Select Button: This button activates the EzSet function to quickly and accurately calibrate the AVR 7300's output levels. When the button is pressed you will then need to select between automatic EzSet

operation or using the remote as a manual SPL meter by pressing the **▲/▼ Navigation Button 15** until your choice appears in the remote's LCD display. Press the **Set Button 17** to enter the setting, and then follow the instructions as displayed in the LCD display. (For complete information, see page XX.)

47 EzSet Microphone Sensor: The microphone sensor that is used by the EzSet system is behind the three slots at the top of the remote control. When using EzSet to calibrate the AVR 7300, be certain that the slots are not covered. (See page XX for more information on using EzSet.)

48 Lens: The infrared emitters behind the plastic lens at the top of the remote communicate the remote codes to the AVR 7300. Be certain that the lens is not covered when using the remote, and point the lens toward the AVR for best results. In learning mode, the remote receives IR codes to be learned through a sensor behind the lens.

NOTE: DO NOT remove the rubber plug that is supplied to cover the jack on the upper right side of the remote. The jack is not active and is reserved for future use.

ZONE II REMOTE CONTROL FUNCTIONS

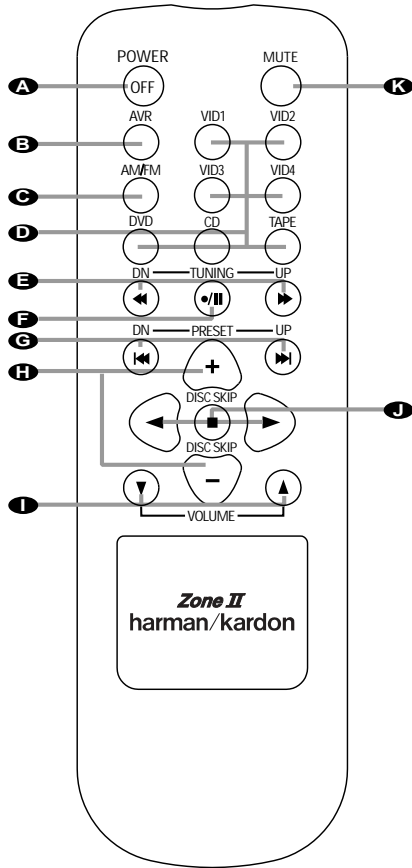

To make it easier to follow the instructions that refer to this illustration, a larger copy may be downloaded from the Product Support section for this product at www.harmankardon.com.

- A** Power Off Button
- B** AVR Selector Button
- C** AM/FM Tuner Selector
- D** Input Selectors
- E** Tuning Up/Down – Fast Play Buttons
- F** Record/Pause Button
- G** Preset Up/Down – Track Skip Buttons
- H** Disc Skip Button
- I** Volume Up/Down Buttons
- J** Play Forward/Reverse/Stop Buttons
- K** Mute Button

The Zone II remote may be used either in the same room where the AVR 7300 is located or in a separate room with an optional infrared sensor that is connected to the AVR 7300's **Multiroom IR Input 31** jack. When it is used in the same room as the DPR 2005, it will control the functions of the DPR 2005 or any compatible Harman Kardon products in that room. When it is used in a separate room via a sensor connected to the **Multiroom IR Input B** jack, the buttons for Power, Input Source, Volume and Mute will control the source and volume for the second zone, as connected to the **Multiroom Audio and Video Outputs O O** jacks. (See page XX for complete information on using the Multiroom system.)

A Power Off Button: When used in the room where the AVR 7300 is located, press this button to place the unit in Standby. When it is used in a remote room with a sensor that is connected to the **Multiroom IR Input B** jack, this button turns the Multiroom system on and off.

B AVR Selector Button: Press this button to turn on the DPR 2005. The input in use when the unit was last on will be selected.

C AM/FM Tuner Selector: Press this button to select the Tuner as the input to the Multiroom system. Press it again to change between the AM and FM bands.

D Input Selectors: When the DPR 2005 is off, press one of these buttons to select a specific input and turn the unit on. When the unit is already in use, pressing one of these buttons will change the input.

NOTE: The Zone II remote may not be used to select the **Front-Panel Video 5 Input 14**. However, you may assign a source connected to these jacks to the Multiroom System using the **Multiroom Button 27** on the remote or the **MULTI-ROOM SETUP** menu. See page 39 for more information.

E Tuning Up/Down – Fast Play Buttons: When the Zone II remote is used in the same room as the DPR 2005, these buttons may be used to change the

frequency of the tuner. These buttons may also control the Fast Play or Fast Reverse functions of compatible Harman Kardon CD, DVD or cassette decks in the same room, or from a remote room when an IR link is connected to the DPR 2005.

F Record/Pause Button: Press this button to activate the Record or Pause function on compatible Harman Kardon CD, DVD or cassette deck products.

G Preset Up/Down – Track Skip Buttons: When the DPR 2005's tuner is selected as the input source, these buttons will move up or down through the list of stations that have been stored in the preset memory. When a CD or DVD changer or player is selected, these buttons activate the Forward or Reverse Track or Chapter Skip functions.

H Disc Skip Buttons: Press these buttons to change discs on a compatible Harman Kardon CD or DVD changer or player.

I Volume Up/Down Buttons: When the Zone II remote is used in the room where the AVR 7300 is located, press this button to raise or lower the volume in that room. When it is used in a remote room with a sensor that is connected to the **Multiroom IR Input B** jack, this button will raise or lower the volume in the remote room.

J Play Forward/Reverse/Stop Buttons: Press these buttons to control compatible Harman Kardon CD, DVD or cassette players.

Mute Button: When the Zone II remote is used in the room where the DPR 2005 is located, press this button to temporarily silence the unit. When it is used in a remote room with a sensor that is connected to the **Multiroom IR Input B** jack, this button will temporarily silence the feed to the remote room only. Press the button again to return to the previous volume level.

INSTALLATION AND CONNECTIONS

System Installation

After unpacking the unit, locating it in a place with adequate ventilation and placing it on a solid surface capable of supporting its weight, you will need to make the connections to your audio and video equipment.

IMPORTANT NOTE: For your personal safety and to avoid possible damage to your equipment and speakers, it is always good practice to turn off and unplug the DPR and ALL source equipment from the AC output before making any audio or video system connections.

Audio Equipment Connections

We recommend that you use high-quality interconnect cables when making connections to source equipment and recorders to preserve the integrity of the signals.

1. Connect the analog output of a CD player to the **CD Inputs F**.

NOTE: If your CD player has both fixed and variable audio outputs, it is best to use the fixed output unless you find that the input to the receiver is so low that the sound is noisy, or so high that it is distorted.

2. Connect the analog Play/Out jacks of a cassette deck, MD, CD-R or other audio recorder to the **Tape Inputs D**. Connect the analog Record/In jacks on the recorder to the **Tape Outputs W** on the AVR 7300.
3. Connect the output of any digital audio source such as such as a CD or DVD changer or player, advanced video game, a digital satellite receiver, HDTV tuner or digital cable set-top box or the output of a compatible computer sound card to the **Optical and Coaxial Digital Audio Inputs RS 10 12**.
4. Connect the coaxial or optical **Digital Audio Outputs 18 19** on the rear panel of the DPR 2005 to the matching digital input connections on a CD-R or MiniDisc recorder.
5. Assemble the AM loop antenna supplied with the unit so that the tabs at the bottom of the antenna loop snap into the holes in the base. Connect it to the **AM and GND Screw Terminals X**.

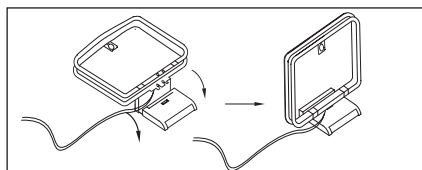

6. Connect the supplied FM antenna to the **FM (75-Ohm) Connection W**. The FM antenna may be an external roof antenna, an inside powered or wire-lead antenna or a connection from a cable TV system. If the antenna or connection uses 300-

ohm twin-lead cable, you must use an optional 300-ohm-to-75-ohm adapter to make the connection.

7. Connect the front, center, surround and surround back speaker outputs **ABCV** to the respective speakers.

To ensure that all the audio signals are carried to your speakers without loss of clarity or resolution, we suggest that you use high-quality speaker cable. Many brands of cable are available and the choice of cable may be influenced by the distance between your speakers and the receiver, the type of speakers you use, personal preferences and other factors. Your dealer or installer is a valuable resource to consult in selecting the proper cable.

Regardless of the brand of cable selected, we recommend that you use cable with a gauge of 14 or smaller. Remember that in specifying cable, the lower the number, the thicker the cable.

Cable with a gauge of 16 may be used for short runs of less than ten feet. We do not recommend that you use cables with an AWG equivalent of 18 or higher, due to the power loss and degradation in performance that will occur.

Cables that are run inside walls should have the appropriate markings to indicate listing with UL, CSA or other appropriate testing agency standards. Questions about running cables inside walls should be referred to your installer or a licensed electrician who is familiar with the NEC and/or the applicable building codes in your area.

When connecting wires to the speakers, be certain to observe proper polarity. Note that the positive (+) terminal of each speaker connection now carries a specific color code, as noted on page 8. However, most speakers still use a red terminal for the positive connection. Connect the "negative" or "black" wire to the same terminal on both the receiver and the speaker.

NOTE: While most speaker manufacturers adhere to an industry convention of using black terminals for negative and red ones for positive, some may vary from this configuration. To ensure proper phase and optimal performance, consult the identification plate on your speaker or the speaker's manual to verify polarity. If you do not know the polarity of your speaker, ask your dealer for advice before proceeding, or consult the speaker's manufacturer.

We also recommend that the length of cable used to connect speaker pairs be identical. For example, use the same length piece of cable to connect the front-left and front-right or surround-left and sur-

round-right speakers, even if the speakers are a different distance from the AVR 7300.

8. Connections to a subwoofer are normally made via a line-level audio connection from the **Subwoofer Output M** to the line-level input of a subwoofer with a built-in amplifier. When a passive subwoofer is used, the connection first goes to a power amplifier, which will be connected to one or more subwoofer speakers. If you are using a powered subwoofer that does not have line-level input connections, follow the instructions furnished with the speaker for connection information.
9. If an external multichannel audio source with 5.1 outputs such as an external digital processor/decoder, DVD-Audio or SACD player is used, connect the outputs of that device to the **8-Channel Direct Inputs 4**.

Video Equipment Connections

Video equipment is connected in the same manner as audio components. Again, the use of high-quality interconnect cables is recommended to preserve signal quality.

1. Connect the analog left/right audio composite video or S-Video Play/Out jack of a VCR, Personal Video Receiver (PVR) or DVD-Recorder to the **Video 1 or Video 2 Audio and Video Input Jacks N** on the rear panel. Although any other video device may also be connected to these jacks, we particularly recommend that VCRs and PVRs be connected to the Video 1 Input Jacks so that you are able to take advantage of the remote control codes for these devices that are programmed for the "Video1/VCR" button of the unit's remote control.
2. Connect the analog left/right audio composite video or S-Video Record/In jacks of a VCR, Personal Video Recorder (PVR) or DVD-Recorder to the **Video 1 or Video 2 Audio and Video Output Jacks JPMU** on the rear panel. Although any other video device may also be connected to these jacks, we particularly recommend that VCRs and PVRs be connected to the Video 1 Output Jacks so that you are able to take advantage of the remote control codes for these devices that are programmed for the "Video 1/VCR" button of the unit's remote control.
3. Connect the analog left/right audio composite video or S-Video Play/Out jacks of any video playback device to the **Video 3 or Video 4 Audio and Video Input Jacks HOKV** on the rear panel. Although any type of video source device may be connected to these jacks, the remote control has the commands for the Video 3 inputs set to control a cable set-top box and the commands for

the Video 4 inputs set to control a satellite receiver. However, you may reassign the commands for any type of device to either button on the remote using the instruction shown for "Changing Devices" as shown on page XX. You may also learn the codes for the device connected to any input by following the instructions for "Learning Codes" shown on page XX.

4. Connect the analog left/right audio and composite video or S-Video and analog left/right audio outputs of a DVD player to the **DVD Audio and Video Input Jacks 6 J** on the rear panel.
5. Connect the optical or coaxial digital audio outputs of a DVD player, satellite receiver, cable box, HDTV tuner or video game to any of the **Optical or Coaxial Digital Inputs 2 5 10 12**. The recommended connection for a DVD player is to use a Coaxial digital link connected to the Coaxial Digital Audio Input 1, but you may change the digital audio input assignment for any source using the **IN/OUT SETUP** menu as described on page 21 or the **Digital Input Selector 6 16** on the front panel or remote, as described on page XX.

NOTE: When connecting a device such as a digital cable box or other set-top tuner product with a digital audio output, we recommend that you connect both the digital and analog outputs of the product to your AVR. The audio input polling feature of the AVR will then be able to make certain that you have a constant audio feed, since it will automatically switch the audio input to the analog jacks if the digital feed is interrupted or not available for a particular channel.

6. Connect the **Video Monitor Output 9** jacks on the receiver to the composite or S-Video input of your television monitor or video projector.
7. If your DVD Player has Y/Pr/Pb analog component video outputs, connect them to the **DVD Component Video Inputs 15**. Although this set of inputs may be assigned to any of the five video inputs on the AVR 7300, the factory default is for this input to be assigned to the DVD. Remember to make a digital audio connection between the DVD player and the AVR, with the **Coaxial Digital Input 1 1** being the factory default. For information on changing the input assignments for either the component video jacks or the DVD player's audio connection, see page XX.
8. If you have other devices with Y/Pr/Pb or RGB component video outputs, connect the source device to the **Component Video 1 or 2 Inputs GH**. The audio connections may be made to any of the ?????? panel audio inputs or the

Optical or Coaxial Digital Inputs RS

10 12. When using either of the Component Video Inputs, make certain that the audio and video inputs are properly configured in the **IN/OUT SETUP** menu, as described on page XX.

9. If the component video inputs are used, connect the **Component Video Monitor Outputs E** to the component video inputs of your TV, projector or other display device.
10. If you have a camcorder, video game or other audio/video device that is connected to the DPR on a temporary, rather than permanent, basis, connect the audio, video and digital audio outputs of that device to the **Front-Panel Inputs 10 12 14**. A device connected here is selected as the Video 5 input, and the digital inputs must be assigned to the Video 5 input. (See page 21 for more information on input configuration.)

Video Connection Notes:

- When connecting the AVR 7300 to a "digital ready," "HDTV compatible" or High Definition display, which is any device capable of accepting an input signal of 480P or higher, you are able to take advantage of the unit's advanced video processing circuitry converts all incoming video signals, regardless of the way they are connected to the AVR. Since the AVR 7300 is also among the very few products that display the on-screen menus with up-converted video, the connection from the AVR 7300 to the display need only be one set of Y/Pr/Pb component video cables.
- When source devices such as a progressive scan DVD player or HDTV set-top box are connected to the AVR 7300 via component video connections, it is also necessary to connect the standard, composite or S-Video outputs of the source device to the AVR 7300 if you wish to take advantage of the record outputs or have video routed to a second room. The record outputs and multiroom system cannot accept component inputs, nor are component inputs down converted for use with these outputs.
- When connecting the AVR 7300 to a standard, analog video display that has standard composite and S-Video inputs only, component video inputs may not be used. If you have a mix of composite and S-Video input sources, note that the AVR 7300 will down convert S-Video inputs to a composite output, but it will not convert composite video to S-Video.

System and Power Connections

The AVR 7300 is designed for flexible use with multiroom systems, external control components and power amplifiers.

Main Room Remote Control Extension

If the receiver is placed behind a solid or smoked glass cabinet door, the obstruction may prevent the remote sensor from receiving commands. In this event, an optional remote sensor may be used. Connect the output of the remote sensor to the **Remote IR Input D** jack.

If other components are also prevented from receiving remote commands, only one sensor is needed. Simply use this unit's sensor or a remote eye by running a connection from the **Remote IR Output C** jack to the Remote IR Input jack on Harman Kardon or other compatible equipment.

Multiroom IR Link

The remote room IR receiver should be connected to the **Multiroom IR Input D** jack on the AVR 7300's rear panel.

If other Harman Kardon compatible source equipment is part of the main room installation, the **Remote IR Output C** jack on the rear panel should be connected to the IR IN jack on source equipment. This will enable the remote room location to control source equipment functions.

NOTE: All remotely controlled components must be linked together in a "daisy chain." Connect the **IR OUT** jack of one unit to the **IR IN** of the next to establish this chain.

Multiroom Connections

The AVR 7300 is equipped with multizone capabilities that allow it to send an audio and/or video source to a remote zone that is different from the one selected for use in the main room. Please note that this capability applies to analog inputs from sources such as the AVR's tuner, tape decks or VCRs. If you wish to use a source such as a DVD or CD player that is normally connected via a digital connection, it is necessary to run an analog connection from the source to the AVR or to use the Main Downmix input option, as explained on page XX.

Depending on your system's requirement, three options are available for remote room audio connection:

Option 1: Use high-quality, shielded audio interconnect cable from the AVR 7300's location to the remote room. In the remote room, connect the interconnect cable to an optional external stereo power amplifier. The amplifier will be connected to the room's speakers. At the AVR 7300, plug the audio interconnect cables into the **Multiroom Audio Outputs 9** on the DPR 2005's rear panel.

INSTALLATION AND CONNECTIONS

Option 2: Connect the **Multiroom Audio Outputs** **Ⓞ** on the DPR 2005 to the inputs of an optional stereo power amplifier. Run high-quality speaker wire from the amplifier to the speakers in the remote room.

Option 3: Taking advantage of the AVR 7300's built-in seven-channel amplifier, it is possible to use two of the amplifier channels to power speakers in the remote room. When using this option you will not be able to use the full 7.1-channel capabilities of the AVR 7300 in the main listening room, but you will be able to add another listening room without external power amplifiers. To use the internal amplifiers to power a remote zone, connect the speakers for the remote room location to the **Surround Back/Multiroom Speaker Outputs** **Ⓒ**. Before using the remote room you will need to configure the amplifiers for surround operation by changing a setting (following the instructions shown on page 39) in the **MULTI-ROOM SETUP** menu.

NOTE: For all options, you may connect an optional IR sensor in the remote room to the AVR 7300 via an appropriate cable. Connect the sensor's cable to the **Multiroom IR Input** **Ⓜ** on the AVR 7300 and use the Zone II remote to control the room volume. Alternatively, you may install an optional volume control between the output of the amplifiers and the speakers.

Multiroom Video Connections

The AVR 7300's multiroom system is designed to send both video and audio signals to a remote room location. This may be the same source that is in use in the main room, or you may select a separate input source through the Multiroom menus or remote, as explained on page xx.

The only additional connection required to add video capabilities to your multiroom system is to connect the Multiroom Video Outputs [square O] either directly to the video display in the remote room or to any optional video distribution amplifiers that may be required when the length of the connection cable is such that additional amplification is required.

The following items may be of additional assistance when using video as part of a multiroom system with the AVR 7300:

- When connecting the AVR 7300 to a "digital ready," "HDTV compatible" or High Definition display, which is any device capable of accepting an input signal of 480P or higher, you are able to take advantage of the unit's advanced video processing circuitry converts all incoming video signals, regardless of the way they are connected to the AVR. Since the AVR 7300 is also among the very few products that display the on-screen menus with up-converted video, the con-

nection from the AVR 7300 to the display need only be one set of Y/Pr/Pb component video cables.

- Component video sources may not be routed through the multi-room system. When using a component video device, you should also make a composite or S-Video connection to permit use of the multiroom system.
- As with all cable installations, when running any wiring inside a wall be certain that the cable carries the proper NEC rating for the application. The use of improperly rated cables may present a safety hazard. Consult a qualified installer or licensed electrician should you have any questions about the use of in-wall cables for video or audio.

A-BUS® Installation Connections

The AVR 7300 is among the very few receivers available today that offer built-in A-BUS Ready operation. When used with an optional A-BUS keypad or control module, you have all the benefits of remote zone operation without the need for an external power amplifier.

To use the AVR 7300 with an approved A-BUS product, simply connect the keypad or module that is in the remote room to the AVR 7300 using standard Category 5 wiring that is properly rated for the in-wall use specific to the installation. Terminate the wiring at the receiver end to a standard RJ-45 connector in compliance with the instructions furnished with the A-BUS module.

No further installation or adjustment is needed, as the A-BUS jacks on the AVR 7300 routes the signals in and out of the keypad to their proper destination for power, signal source and control. The output fed to the A-BUS jack is determined by the AVR 7300's multiroom system and menus.

RS-232 Connections

The AVR 7300 is equipped with an **RS-232 Port** **Ⓢ** that may be used for two purposes. When the port is connected to a compatible, optional, external computer, keypad or control system the AVR 7300 is capable of bi-directional communications that enable the external system to control the AVR, and for the AVR to report status and handshake data back to the controller. Use of the RS-232 port for this type of control requires specific technical knowledge, and we recommend that any connection and programming for control be made by a trained installer or technician familiar with the equipment being used.

The RS-232 port may also be used as an access point through which the AVR 7300's operating system and surround mode memories may be updated via connection to a compatible computer. At the time that an upgrade is available, instructions for making the connection and installing the upgrade will be

available through the Product Support area of the Harman Kardon Web site at harmankardon.com.

The physical connection to the AVR 7300's RS-232 port is a standard D-SUB 9 connection but to assure compatible and proper operation, specific software commands and pin wiring schemes may be required.

Trigger Jack Connection

The AVR 7300 is equipped with a low voltage trigger jack that may be used to activate optional, external power amplifiers, screen motors, motorized blinds or other compatible products that may be part of a home theater installation. Once the connections are made, operation is seamless in that the low voltage control signal is sent to the screen, blinds or other device when the AVR 7300 is turned on, and it is turned off along with the AVR. **Due to the complexity of interfacing with power-controlled devices, we strongly recommend that the installation be done by a qualified installer.**

The AVR 7300's trigger jack is a 3.5mm mono mini-plug that delivers a 6 volt DC signal to the center pin ("tip") of the plug ("+") with the outer shaft ("ring") of the plug as the negative ("-") or ground connection. After checking for polarity, voltage and current draw compatibility between the AVR and the product to be controlled, simply connect the mini plug to the Trigger Jack [square A] on one end and to the device to be controlled on the other. No further programming is required.

The **Switched AC Accessory Outlet** **Ⓓ** is powered only when the unit is on. This is recommended for devices that have a mechanical power switch that may be left in the "ON" position.

NOTE: Many audio and video products go into a Standby mode when they are used with switched outlets. This type of product may not operate properly when used with the switched outlet.

The **Unswitched AC Accessory Outlet** **Ⓔ** is powered as long as the DPR is plugged into a powered AC outlet.

The AVR 7300 features a removable power cord that allows wires to be run in advance to a complex installation so that the unit itself need not be installed until it is ready for connection. When all needed connections have been made, connect the AC Power cord to the **AC Power Cord Jack** **Ⓙ**.

The AVR 7300 draws significantly more current than other household devices, such as computers, that use removable power cords. For that reason, it is important that only the cord supplied with the unit (or a direct replacement of identical capacity) be used.

Once the power cord is connected, you are almost ready to enjoy the AVR 7300's incredible power and fidelity!

When all audio, video and system connections have been made, there are a few configuration adjustments that must be made. A few minutes spent to correctly configure and calibrate the unit will greatly add to your listening experience.

Speaker Selection and Placement

The placement of speakers in a multichannel home theater system can have a noticeable impact on the quality of sound reproduced.

No matter which type or brand of speakers is used, the same model or brand of speaker should be used for the left front, center and right front speakers. This creates a seamless front soundstage and eliminates the possibility of distracting sonic disturbances that occur when a sound moves across mismatched front-channel speakers.

Speaker Placement

Depending on the type of center channel speaker in use and your viewing device, place the center speaker either directly above or below your TV, or in the center behind a perforated front-projection screen.

Once the center channel speaker is installed, position the front left and front right speakers so that they are as far away from one another as the center channel speaker is from the preferred listening position. Ideally, the front channel speakers should be placed so that their tweeters are no more than 24" above or below the tweeter in the center channel speaker.

Depending on the specifics of your room acoustics and the type of speakers in use, you may find that imaging is improved by moving the left front and right front speakers slightly forward of the center channel speaker. If possible, adjust all front loudspeakers so that they are aimed at ear height when you are seated in the listening position.

Using these guidelines, you'll find that it takes some experimentation to find the correct location for the front speakers in your particular installation. Don't be afraid to move things around until the system sounds correct. Optimize your speakers so that audio transitions across the front of the room sound smooth, and that sounds from all speakers appear to arrive at the listening position at the same time (without delay from the center speaker compared to the left and right speakers).

When the AVR 7300 is used in 5.1-channel operation, the preferred location for surround speakers is on the side walls of the room, at or slightly behind the listening position. In a 7.1-channel system, both side surround and back surround speakers are required. The center of the speaker should face into the room.

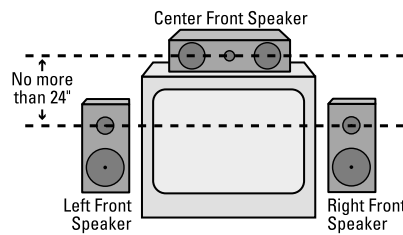

A) Front-Channel Speaker Installation With Direct-View TV Sets or Rear-Screen Projectors

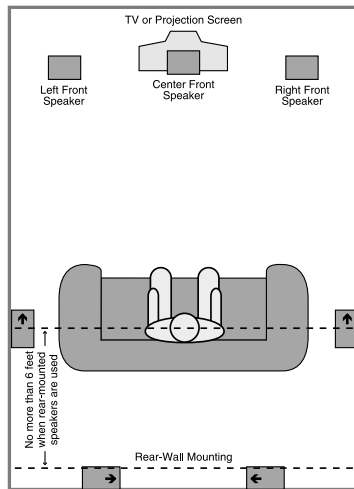

B) Rear speaker mounting is an alternate location for 5.1 systems. It is required for 7.1 operation.

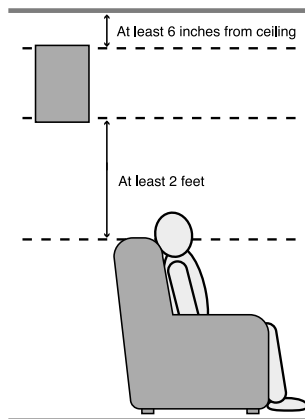

The speakers should be located so that the bottom of the cabinet is at least two feet higher than the listeners' ears when the listeners are seated in the desired area.

Rear surround speakers are required when a full 7.1-channel system is installed, and they may also be used in 5.1 channel systems as an alternative mounting position when it is not practical to place the main surround speakers on the sides of the room. Speakers

may be placed on a rear wall, behind the listening position. As with the side speakers, rear surrounds should be located so that the bottom of the cabinet is at least two feet higher than the listeners' ears. The speakers should be no more than six feet behind the rear of the seating area.

If dipole-type speakers are used on either the side or rear walls of the room, please note that if there are arrows on the speakers they should face the front of the room for the side speakers, or towards the center of the wall for the rear speakers.

Subwoofers produce nondirectional sound, so they may be placed almost anywhere in a room. Actual placement should be based on room size and shape and the type of subwoofer used. One method of finding the optimal location for a subwoofer is to begin by placing it in the front of the room, about six inches from a wall, or near the front corner of the room.

Another method is to temporarily place the subwoofer at your normal listening position, and then walk around the room until you find a spot where the subwoofer sounds best. Place the subwoofer in that spot. You should also follow the instructions of the subwoofer's manufacturer, or you may wish to experiment with the best location for a subwoofer in your listening room.

System Setup

Once the speakers have been placed in the room and connected, the remaining steps in the setup process are to assign input and output connections, select a surround mode, program the DPR 2005's bass management system for the type of speakers used in your system, set the delay times used by the surround sound processor and calibrate the output levels.

You are now ready to power up the AVR 7300 to begin these final adjustments.

1. Make certain that the AC power cord is firmly inserted into the **AC Power Cord Jack** **P** and plug the cord into an unswitched AC outlet. To maintain the unit's safety rating, DO NOT substitute the power cord for one with lower current capacity.
2. Open the **Front-Panel Control Door** **9** by gently pushing at the corners of the door. Locate the **Main Power Switch** **▲** and push it in until it latches and the word "OFF" on the top of the switch disappears inside the front panel. Note that the lighting around the **Standby/On Button** **1** will turn amber, indicating that the unit is in the Standby mode.

SYSTEM CONFIGURATION

- Carefully remove the protective plastic film from the front-panel lens. If left in place, the film will prevent proper operation of the remote control.
- Install the four supplied AAA batteries in the remote as shown. Be certain to follow the (+) and (-) polarity indicators that are in the battery compartment.

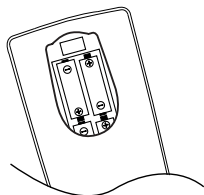

- Turn the AVR 7300 on by pressing the **Standby/On Button 1** on the front panel, or via the remote by pressing the **Power On Button 2**, the **AVR Selector 5 B** or any of the **Input Selectors 4 3A 4A C D** on the remote. The lighting around the **Standby/On Button 1** will turn blue to confirm that the unit is on.

Using the On-Screen Display

When making the following adjustments, you may find it easier to use the DPR 2005's on-screen display system. These easy-to-read displays give you a clear picture of the current status of the unit and make it easy to see which speaker, delay, input or digital selection you are making.

To the on-screen menus, make certain that you have made a connection between either the Component Video Outputs [square E] or the Video Monitor Outputs [square O] and the matching inputs on your TV, display or projector. In order to view the menus, make certain that the proper video input type has been selected on the display, and that any configuration required for the display, such as selection of interlace or progressive scan has been made. To take advantage of the AVR 7300's advanced video circuitry, when a component video connection is in use, make certain that the display is configured for "480P" or progressive scan inputs, if available.

IMPORTANT NOTE: When viewing the on-screen menus using a CRT-based projector, plasma display or direct-view CRT monitor or television, it is important that they not be left on for an extended period of time. The constant display of a static image such as these menus may cause the image to be permanently "burned into" the projection tubes, plasma screen or CRT. This type of damage is not covered by the AVR 7300 warranty and may not be covered by the projector/TV set's warranty.

The AVR 7300 has two on-screen display modes, "Semi-OSD" and "Full-OSD." When making configuration adjustments, it is recommended that the full-OSD mode be used. This will place an easily viewed list of the available options on the screen.

Making Configuration Adjustments

The full-OSD system is available by pressing the **OSD Button 31**. When this button is pressed, the **MASTER MENU** (Figure 1) will appear, and adjustments are made from the individual menus.

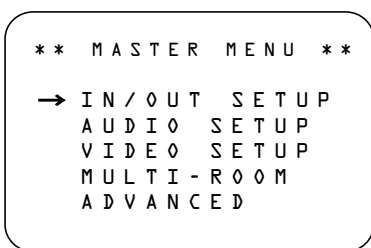

Figure 1

The semi-OSD system is also available, allowing you to make adjustments directly, by pressing the appropriate buttons on the front panel or remote control for the specific parameter to be adjusted. For example, to change the digital input for any of the sources, press the **Digital Select Button 7** and then press the **▲/▼ Navigation Button 15** to scroll through the list of options as they appear in the on-screen display or in the **Lower Display Line 14**.

To use the full-OSD menu system, press the **OSD Button 31**. When the menu is on the screen, press the **▲/▼ Navigation Button 15** until the on-screen **→** cursor is next to the item you wish to adjust, and then press the **Set Button 17** to adjust that item. The menu will remain on the screen for 20 seconds, and then they will "time-out" and disappear from the screen. The time-out may be increased to as much as 50 seconds by going to the **ADVANCED SELECT** menu, and changing the item titled **FULL OSD TIME OUT**.

When the full-OSD system is in use, the menu selections are not shown in the **Upper** or **Lower Display Lines 13/14**. When the full-OSD menu system is used, **OSD ON** will appear in the **Upper Display Line 13** to remind you that a video display must be used. When the semi-OSD system is used in conjunction with the discrete configuration buttons, the on-screen display will show a single line of text with the current menu selection. That selection will also be shown in the **Upper** or **Lower Display Lines 13/14**, depending on which parameter is being adjusted.

Setting the System Configuration Memory

The AVR 7300 features an advanced memory system that enables you to establish audio and video parameters for each input source. This flexibility enables you to custom-tailor the way in which you listen to each source and have the DPR 2005 memorize those settings. This means, for example, that you may set different speaker configurations with the resultant changes to the bass management system. Thanks to the use of exclusive Harman Kardon circuitry and software along with DCDi by Faroudja® technology, you may also custom tailor the video settings for each input source to display consistent, high quality video images when the AVR 7300 is used in conjunction with a digital or high definition display. Once these settings are made, they will automatically be recalled whenever you select that input.

The factory default settings for audio have all inputs expect for DVD and Video 3 configured for their analog inputs. The default for DVD is **Coaxial Digital Audio Input 1 1** and the default for Video 3 is **Optical Digital Input 1 6**. Additionally, the default for all speaker settings is "Small" with the Subwoofer on. Logic 7 Music is the default surround mode for all sources, with Dolby Digital or DTS being selected automatically when an appropriate digital source is in use and a digital bitstream is detected.

The factory defaults for the video settings are listed in the Appendix to this manual on page XX. Note, however, that most of the video default settings are only applicable when a component connection to a digital ready or HDTV monitor is in use. Both the video and audio settings for all inputs may be changed as shown in the following pages.

Before using the unit, you may want to change the settings for some inputs so that they are properly configured to reflect the use of digital or analog inputs, the type of speakers installed and the surround mode specifics of your home theater system. Remember that since the DPR 2005 memorizes the settings for each input individually, you will need to make these adjustments for each input used. However, once they are made, further adjustment is only required when system components are changed.

To make this process as quick and as easy as possible, we suggest that you use the full-OSD system with the on-screen menus, and step through each input. Once you have completed the settings for the first input, many settings may be duplicated for the remaining inputs. It is also a good idea to set the configuration data in the order these items are listed in the **MASTER MENU**, as some settings require a specific entry in a prior menu item.

Input Setup

The first step is to configure each input. Once an input is selected, the settings for the Digital Input, Component Video assignment and Surround Mode will "attach" themselves to that input and be stored in a nonvolatile memory. This means that once made, the selection of an input will automatically recall those settings. For that reason, the procedures described below must be repeated for each input source so that you have the opportunity to custom tailor each source to your specific listening requirements. However, once made they need not be changed again unless you need to alter a setting. The configuration settings for speaker "size" may be set once and applied to all inputs, or you may select a different speaker configuration for each input using the **INDEPENDENT** setting, as described on page 26. When using the full-OSD system to make the setup adjustments, press the **OSD Button 31** once so that the **MASTER MENU** (Figure 1) appears. The **→** cursor will be next to the **IN/OUT SETUP** line. Press the **Set Button 17** and the **IN/OUT SETUP** menu (Figure 2) will appear on the screen. Press the **◀/▶ Navigation Button 15** until the desired input name appears in the highlighted video, as well as being indicated in the front-panel **Input Indicators 14**. When you are scrolling through the list of available inputs you may hear a slight click. This is normal, as it is caused by the relay that is used to switch between the two Component Video Inputs.

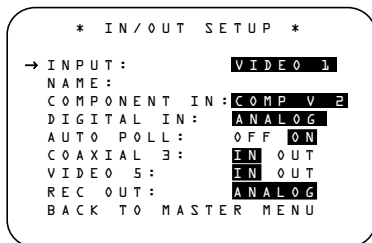

Figure 2

When a Video input is selected as the source, you have the option of changing the name that appears in the on-screen and front-panel messages. This is helpful if you have more than one VCR, if you wish to associate a specific product brand name with the input, or to simply enter any name that will help you to remember which source is being selected.

To change the input name, press the **▲/▼ Navigation Button 15** on the remote so that the **→** cursor is pointing to **NAME**. Next, press and hold the **Set Button 17** for a few seconds until a flashing box appears to the right of the colon. Immediately release the **Set Button 17**, as you are now ready to enter the device name.

Press the **▲/▼ Navigation Button 15** and a complete set of alpha-numeric characters will be available with the start of the alphabet in capital letters followed by the lower-case letters and then numbers and symbols. Press the button either way until the first letter of the desired name appears. If you wish to enter a blank space as the first character, press the **▶ Navigation Button 15**.

When the desired character appears, press the **▶ Navigation Button 15** and repeat the process for the next letter. Continue until the desired name is entered, up to fourteen characters. When the name is complete, press the **Set Button 17** to enter it into the system memory.

If your system includes sources equipped with Y/Pr/Pb component video outputs, the DPR is able to switch them to send the proper signals to a video display. Either **Component Video Input 23/29** may be assigned to any source for added system flexibility. The default setting is for the **Component Video 1 Jack 28** to be assigned to the DVD and 6/8-Channel Direct Inputs, with the **Component Video 2 Jack 29** assigned to all other inputs. If your system doesn't include component video, or if you do not need to change these defaults, press the **▼ Navigation Button 15** to go to the next setting.

To change the Component Video assignment, first make certain that the **→** cursor is pointing to the **COMPONENT IN** line on the menu screen; then press the **◀/▶ Navigation Button 15** until you see the desired input in the highlighted video. When the desired component input has been selected, press the **▼ Navigation Button 15** to go to the next setting.

Some digital video input sources, such as a cable box or HDTV set-top may change between analog and digital outputs, depending on which channel is in use. The AVR 7300's Auto Polling feature allows you to avoid losing the audio feed when this happens by permitting both analog and digital connections to the same source on the DPR. Digital audio is the default, and the unit will automatically switch to the analog audio if the digital audio stream stops.

In cases where only a digital source is used, you may wish to disable the Auto Polling feature to prevent the DPR from trying to "find" an analog source when the digital source is paused. To turn Auto Polling off for any input, first make certain that the **→** cursor is pointing to the **AUTO POLL** line on the menu screen. Next, press the **◀/▶ Navigation Button 15** so that **OFF** is highlighted in reverse video. Repeat the procedure at any time by highlighting **ON** to restore the Auto Polling feature.

When any changes to the Auto Polling configuration are complete, press the **▼ Navigation Button 15** to go to the next setting.

If you wish to associate a digital input with an input source or change the default digital input selection, press the **▼ Navigation Button 15** while the **IN/OUT SETUP** menu (Figure 2) is on the screen, until the cursor moves to the **DIGITAL IN** line. Press the **◀/▶ Navigation Button 15** until the desired digital input appears. To return to the analog input, press the button until **ANALOG** appears.

To change the digital input at any time using the discrete function buttons and the semi-OSD system, press the **Digital Select Button 16** on the remote. Within five seconds, make your input selection using the **▲/▼ Navigation Button 15** until the desired digital or analog input is shown in the **Upper Display Line 16** and in the lower line of the on-screen display. Press the **Set Button 17** to enter the new digital input assignment.

An exclusive Harman Kardon feature is the ability to switch the front-panel coaxial digital audio and analog audio/video jacks from their normal use as inputs to output connections so that portable recording devices may easily be connected. On the AVR 7300, the **Coaxial 3 Digital Jack J** is normally an input, but this may also be switched to a digital output for use with CD-R/RW decks, MD recorders or other digital recorders. To change the jack to an output, press the **▲/▼ Navigation Button 15** while the **IN/OUT SETUP** menu is on the screen until the **→** cursor is next to **COAXIAL 3**. Then press the **◀/▶ Navigation Button 15** so that **OUT** is highlighted. The **Input/Output Status Indicator 11** will turn red, indicating that the jack is now a record output.

NOTE: A signal will be sent to this jack only when a digital input is selected. Digital signals will be passed through, regardless of their format and which digital input (optical or coax) they are fed from.

The front-panel analog **Video 5 Inputs K** are normally set as an input for use with camcorders, video games and other portable audio/video products, but they may be switched to an output for connection to audio/video recorders. To temporarily switch them to outputs, you must first be at the **IN/OUT SETUP** menu. Press the **▼ Navigation Button 15** until the on-screen **→** cursor is pointing to the **VIDEO 5** line. Press the **▶ Navigation Button 15** so that the word **OUT** is highlighted. The **Input/Output Status Indicator 11** between the S- and composite video jacks will turn red, indicating that the analog Video 5 jacks are now record outputs.

SYSTEM CONFIGURATION

Selection of the front-panel jacks as an output will remain effective as long as the DPR 2005 is on. Once the unit is turned off, the jacks will revert to their normal use as an input when the unit is turned on again.

When changes to the Video 5 setting are complete, press the **Navigation Button 15** to go to the next setting, or press the **Navigation Button 15** until the **→** cursor is next to **BACK TO MASTER MENU** to continue.

The **REC OUT** line gives you the opportunity to select which type of signal is directed to the **Record Output jacks** (associated with the **Tape 11**, **Video 1 5** and **Video 2 3** sources). The default setting is **ANALOG**, which will send the analog signal from any source to all three sets of analog record outputs.

In cases where you wish to have the output of a digital source selected as the record output feed, while the **→** cursor is next to the **REC OUT** line, press the **Navigation Button 15** so that **DSP DOWNMIX** appears in highlighted video. When this indication is shown, the DPR will feed a downmixed, analog version of a Dolby Digital or DTS encoded signal to the **Record Output jacks** (associated with the **Tape 11**, **Video 1 5** and **Video 2 3** sources and the Video 5 jacks when they are configured as an output). This enables you to make an analog recording (where permitted by copyright laws) of the soundtrack from a digital source.

As a reminder, to ensure that a signal feed is always available to the record output jacks, we recommend that an analog connection be made as a fallback for all digital sources. This is key with sources such as cable set-tops to ensure that a record feed will continue in the event that the digital audio stream is not available when channels are changed.

When all needed adjustments have been made, press the **Navigation Button 15** until the **→** cursor is next to **BACK TO MASTER MENU** to continue with the system configuration.

Audio Setup

This menu allows you to configure the tone controls and to turn the upsampling on or off. If you do not wish to change any of those settings at this time, proceed to the next menu screen. However, to make configuration changes to those parameters, make certain that the **MASTER MENU** is on the screen with the **→** cursor pointing to the **AUDIO SETUP** line, and press the **Set Button 17**. The **AUDIO SETUP** menu (Figure 3) will appear.

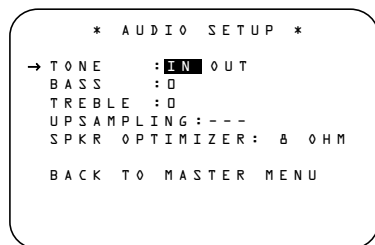

Figure 3

The first line controls whether the bass/treble tone controls are in the signal path. The normal default is for them to be in-line, but if you wish to remove them from the circuit for “flat” response, first make certain that the **→** cursor is pointing to the **TONE** line on the menu and press the **Navigation Button 15** so that **OUT** is highlighted in reverse video.

When the tone controls in the signal path, the amount of boost or cut for bass and treble may be adjusted by pressing the **Navigation Button 15** so that the **→** cursor is next to the line for the setting you wish to adjust. Next, press the **Navigation Button 15** until the desired setting is shown.

This menu also includes a setting to turn the unit's upsampling feature on or off. In normal use, this feature is turned off, which means that digital sources are processed at their native sample rate. For example, a 48kHz digital source will be processed at 48kHz. However, the AVR 7300 allows you to upsample the incoming 48kHz signals to 96kHz for added resolution.

To take advantage of this feature, press the **Navigation Button 15** so that the **→** cursor is next to the **UPSAMPLING** line and press the **Navigation Button 15** so that **ON** is highlighted in reverse video. Note that this feature is only available for the Dolby Pro Logic II and Dolby Pro Logic IIx Movie and Music and Dolby Pro Logic modes.

Speaker Optimizer

The Speaker Optimization function is critical to ensure optimal performance of the DPR, as it tells the digital amplifier section how to best match its operation to your specific speakers. Note that this adjustment is electronic, not electrical, and unlike the “8-ohm/4-ohm” switches on older analog amplifiers, you do not need to turn the DPR off to change the setting. However, we do suggest that you do not have any program material playing through the DPR when the setting is changed.

Before making this adjustment you will need to find the impedance specification for your speakers. This information is often found on a label attached to the speaker, and it is usually shown in the owner's manual that came with your speakers. If you cannot find the information for your speakers, consult the manufacturer's Web site or customer service department.

In cases where the speakers in a system have different impedance ratings, such as 8 ohms for the front left/right and center speakers and 6 ohms for the surround speakers, use the setting for the front speakers, as they are used most often for all types of program material.

If you cannot determine the speaker's impedance, there is no harm in using the factory default setting of 8 ohms, as most home speakers are in that range. However, if it appears that your system's performance in the high-frequency range sounds constricted at high volume levels, you may want to experiment with the 6-ohm or 4-ohm setting.

If your speakers match the factory default setting of 8 ohms, no further adjustment is needed, and you may exit this menu by pressing the **Navigation Button 15** so that the **→** cursor is pointing to the **BACK TO MASTER MENU** line and then press the **Set Button 17**. If you do need to change the setting, press the **Navigation Button 15** until the desired impedance setting appears.

When all desired changes have been made on this menu, press the **Navigation Button 15** so that the **→** cursor is next to the **BACK TO MAIN MENU** line and press the **Set Button 17**.

Surround Setup

The next step is to set the surround mode you wish to use with the input that was previously selected in the **IN/OUT SETUP** menu. Since surround modes are a matter of personal taste, feel free to select any mode you wish – you may change it later. However, to make it easier to establish the initial parameters for the DPR 2005, it is best to select Dolby Pro Logic II (Movie or Music) or Logic 7 (Cinema or Music) for most analog inputs and Dolby Digital for inputs connected to digital sources. In the case of inputs such as a CD Player, Tape Deck or Tuner, you may wish to set the mode to Stereo (“Surround Off”) as they are not typically used with multichannel program material, and it is unlikely that surround-encoded material will be used. Alternatively, the Logic 7 Music mode is a good choice for stereo-only source material. See page 32 for more information on available surround modes.

For digital program material, the DPR will always examine the data stream and automatically select a Dolby Digital or DTS mode as applicable.

It is easiest to complete the surround setup using the full-OSD on-screen menus. From the **MASTER MENU** (Figure 1), press the **▲/▼ Navigation Button 15** until the **→** cursor is next to the **SURROUND SELECT** line. Press the **Set Button 17** until the **SURROUND SELECT** menu (Figure 4) is on the screen.

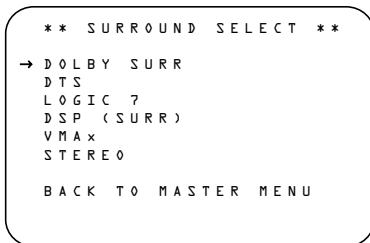

Figure 4

Each of the option lines on this menu (Figure 4) selects the surround mode category, and within each of those categories there will be a choice of the specific mode options.

The choice of modes will vary according to the speaker configuration in your system. When the **SURR BACK** line of the **SPEAKER SETUP** menu (Figure 7) is set to **NONE** the AVR 7300 will be configured for 5.1-channel operation, and only the modes appropriate to a five-speaker system will appear. When the **SURR BACK** line of the **SPEAKER SETUP** menu (Figure 7) is set to **SMALL** or **LARGE**, the DPR 2005 will be configured for 6.1/7.1-channel operation, and additional modes such as Dolby Digital EX, Dolby Pro Logic IIx and DTS-ES will appear, as they are only available when seven main speakers are present. In addition, some of the modes available in the AVR 7300 will not appear unless a digital source is selected and is playing the correct bitstream.

To select the mode that will be used as the initial default for an input, first press the **▲/▼ Navigation Button 15** until the on-screen cursor is next to the desired mode's master category name, such as **DOLBY SURROUND**, **DTS**, **DSP (SURR)** or **VMAX**. Next, press the **Set Button 17** to view the submenu. Press the **◀/▶ Navigation Button 15** to scroll through the available choices, and then press the **▼ Navigation Button 15** so that the cursor is next to **BACK TO MASTER MENU** to continue the setup process.

The following paragraphs detail the instructions needed for modes with multiple choices.

On the **DOLBY SURROUND** menu (Fig. 5), choices include Dolby Digital, Dolby Pro Logic II, Dolby Pro Logic IIx, Movie and Music, Dolby Pro Logic and Dolby Virtual Speaker Reference or Wide. For a complete description of the different Dolby Surround modes, see page 32. The Dolby Digital EX and Dolby Pro Logic IIx modes are only available when the system is set for 6.1/7.1 operation by configuring the Surround Back speakers to "Small" or "Large" as described on page 24. When a disc is playing with a Dolby Digital soundtrack that contains a special "flag" signal in the data stream, the Dolby Digital EX mode will be selected automatically. It may also be selected using this menu or through the front-panel or remote controls as shown on page 31. A complete explanation of these modes is found on page 32.

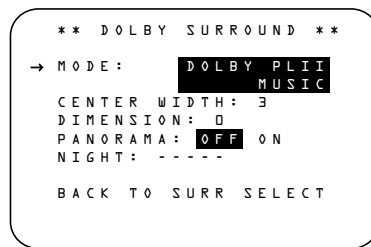

Figure 5

When the **→** cursor is pointing to the **MODE** line, press the **◀/▶ Navigation Buttons 15** to select the desired Dolby surround mode, again remembering that the choice of available modes will vary with the type of program material being played and the number of speakers in your system configuration.

When Dolby Pro Logic II Music or Dolby Pro Logic IIx Music is selected as the listening mode, three special settings are available to tailor the sound field to your listening room environment and your individual taste and preferences. (When other Dolby Surround modes are selected, dotted lines will indicate that these settings are not active.)

- **Center Width:** This setting adjusts the balance of the vocal information in the front soundstage between the center and front left/right speakers. The lower settings spread the center channel sound more broadly into the left and right channels. A higher number (up to "7") produces a tighter center channel presentation.
- **Dimension:** This setting alters the perceived depth of the surround field by creating a shallower presentation that appears to move sounds toward the front of the room, or a deeper presentation that appears

to move the center of the sound field toward the back of the room. The setting of "0" is a neutral default, with the range of adjustment shown as "R-3" for a deeper, rear-oriented sound to "F-3" for a shallower, front-oriented sound.

- **Panorama:** Switch this setting on or off to add an enveloping wrap-around presentation that increases the perception of sound along the sides of the room.

To change these parameters, press the **▼/▲ Navigation Buttons 15** while the **DOLBY SURROUND** menu is on the screen until the **→** cursor is pointing to the line on the menu with the parameter you wish to change. Then, press the **◀/▶ Navigation Buttons 15** to alter the setting to your taste.

When the **DOLBY DIGITAL** mode is selected, there are additional settings available for the Night mode, as shown in Figure 6.

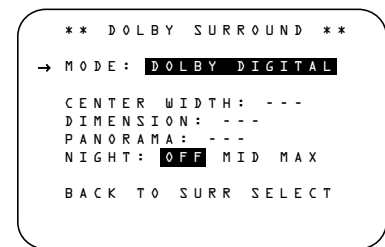

Figure 6

The Night mode is a feature of Dolby Digital that preserves the dynamic range and full intelligibility of a movie soundtrack while reducing the peak level. This prevents abruptly loud transitions from disturbing others, without reducing the sonic impact of a digital source. The Night mode is only available when specially encoded Dolby Digital signals are played.

To adjust the Night mode setting, make certain that the **→** cursor is on the **NIGHT** line of the **DOLBY** menu. Next, press **◀/▶ Navigation Button 15** to choose between the following settings, as they appear in the on-screen display:

OFF: When **OFF** is highlighted, the Night mode will not function.

MID: When **MID** is highlighted, a mild compression will be applied.

MAX: When **MAX** is highlighted, a more severe compression algorithm will be applied.

We recommend that you select the **MID** setting as a starting point and change to the **MAX** setting later, if desired.

SYSTEM CONFIGURATION

The Night mode may also be adjusted directly any time a Dolby Digital source is playing by pressing the **Night Mode Button 30**. When the button is pressed, **D-RANGE** will appear in the lower third of the video screen and in the **Lower Display Line 17**. Press the **▲/▼ Navigation Button 15** within three seconds to select the desired setting.

When all settings for the surround setup have been made, press the **▲/▼ Navigation Button 15** so that the **▶** cursor is next to **BACK TO MASTER MENU**, and press the **Set Button 17** to return to the **MASTER MENU**.

On the **DTS** menu, the selection choices made with the **◀/▶ Navigation Button 15** on the remote are determined by a combination of the type of program material in use and whether the 5.1- or 6.1/7.1-channel configuration is in use.

When a DTS digitally encoded source is playing, the choice of modes for 7.1 systems will vary according to the program source (DTS 5.1, DTS-ES Matrix or DTS-ES Discrete). Press the **◀/▶ Navigation Button 15** to scroll through the choices available for your system and the program in use. The DTS Neo:6 Music mode is available with analog and PCM digital stereo sources and the DTS Neo:6 Cinema mode may be used with matrix surround-encoded sources for an enhanced 5.1-channel sound field.

When the 5.1 configuration is in use, the DPR will automatically select the 5.1 version of DTS processing when a DTS data stream is detected. When the 6.1/7.1 mode is selected, the DTS-ES Discrete mode will automatically be activated for DTS sources with the ES Discrete "flag." When a non-ES DTS disc is in use, you may select the DTS-ES Matrix mode to create a full 7.1 surround mode. See page 32 for an explanation of the DTS modes.

When an analog or two-channel PCM source is playing, the DTS Neo:6 modes are available, which creates a three-, five- or six-channel presentation of the sound. The exact modes available will depend on the number of speaker positions established in the **SPEAKER SETUP** menu. (See page 25 to configure the system for the number and type of speakers in your system.)

On the **LOGIC 7** menu, the choices available made with the **◀/▶ Navigation Button 15** are determined by whether the 5.1- or 6.1/7.1-channel configuration is in use. In either case, the selection of a Logic 7 mode enables Harman Kardon's exclusive Logic 7 processing to create multichannel surround from two-channel stereo- or matrix-encoded programming such as VHS cassettes or television broadcasts produced with Dolby Surround.

With 5.1 configurations, you may select the Logic 7/5.1 Music, Cinema or Enhance modes. They work best with surround-encoded programs or two-channel programming of any type. For 6.1/7.1 configurations, the Music and Cinema modes may be selected. The Logic 7 modes are not available when either Dolby Digital or DTS Digital soundtracks are in use. See page 32 for an explanation of the Logic 7 modes.

On the **DSP (SURR)** menu, the choices made with the **◀/▶ Navigation Button 15** select one of the DSP surround modes designed for use with two-channel stereo programs to create a variety of sound field presentations. The Hall and Theater modes are designed for multichannel installations, while the two VMAX modes are optimized for use in delivering a full surround field when only front left and front right speakers are installed. See page 32 for an explanation of the DSP surround modes.

On the **STEREO** menu, the selection choices made with the **◀/▶ Navigation Button 15** on the remote may select a traditional two-channel presentation that uses only the left and right front speakers by choosing **SURROUND OFF+DSP**. You may also select a **5 CH STEREO** and **7 CH STEREO** mode, depending on how many speakers are available. These two modes feed a two-channel presentation to the front left/right and surround speakers, as stereo pairs, with a mix of the left and right channels fed to the center speakers. See page 32 for a complete explanation of the stereo modes.

After the selections are made on the Dolby, DTS, Logic 7, DSP (Surround) or Stereo menus, press the **▲/▼ Navigation Button 15** so that the cursor moves to the **BACK TO MASTER MENU** line and press the **Set Button 17**.

Speaker Setup

This menu tells the AVR 7300 which type of speakers are in use. This is important as it adjusts the settings that decide whether your system will use the "5-channel" or "6-channel/7-channel" modes, as well as determining which speakers receive low-frequency (bass) information.

For each of these settings, use the **LARGE** setting if the speakers for a particular position are traditional full-range loudspeakers. Use the **SMALL** setting for smaller, frequency-limited satellite speakers that do not reproduce sounds below 200Hz. Note that when "small" speakers are used, a subwoofer is required to reproduce low-frequency sounds. Remember that the "large" and "small" descriptions do not refer to the actual physical size of the speakers, but to their ability to reproduce low-frequency sounds. If you are in

doubt as to which category describes your speakers, consult the specifications in the speakers' owner's manual, or ask your dealer.

This menu screen also allows you to enter the settings for the AVR 7300's Quadruple Crossover feature which allows a different crossover point to be used for the front left/right, center, surround and surround back speakers. In systems where full-range or tower speakers are used for the front soundstage or where different brands or models are in use at the various speaker positions, this feature allows you to customize the bass management and redirection circuits with a precision not previously possible.

It is easiest to enter the proper settings for the speaker setup through the **SPEAKER SETUP** menu (Figure 7). If that menu is not already on your screen from the prior adjustments, press the **OSD Button 31** to bring up the **MASTER MENU** (Figure 1), and then press the **▼ Navigation Button 15** until the cursor is on the **SPEAKER SETUP** line. Press the **Set Button 17** to bring up the **SPEAKER SETUP** menu (Figure 7).

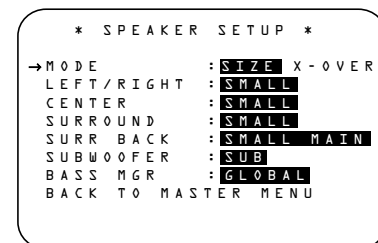

Figure 7

The first line of the **SPEAKER SETUP** menu (Figure 7) allows you to switch the menu to change either the underlying speaker size setting or the exact crossover point used for that speaker group. For the first pass through the menu, leave the setting at its default option of **SIZE**, and then proceed as outlined below. Once the speaker choices have been set, you may wish to return to this line to change the option so that the crossover settings may be adjusted.

Begin the speaker setup process by making certain that the cursor is pointing at the **LEFT/RIGHT** line, which sets the configuration for the front left and right speakers. If you wish to make a change to the front speakers' configuration, press the **◀/▶ Navigation Button 15** so that either **LARGE** or **SMALL** appears, matching the appropriate description from the definitions shown above.

When **SMALL** is selected, low-frequency sounds will be sent only to the subwoofer output. If you choose this option and no subwoofer is connected, you will not hear any low-frequency sounds from the front channels.

When **LARGE** is selected, a full-range output will be sent to the front left and front right outputs. Depending on the choice made in the **SUBWOOFER** line in this menu, bass and/or LFE information may also be directed to the subwoofer.

When you have completed your selection for the front channels, press the **▼ Navigation Button 15** to move the cursor to **CENTER**.

Press the **◀/▶ Navigation Button 15** on the remote to select the option that best describes your system, based on the speaker definitions shown below.

When **SMALL** is selected, low-frequency center channel sounds will be sent only to the subwoofer output. If you choose this option and no subwoofer is connected, you will not hear low-frequency sounds from the center channel.

When **LARGE** is selected, a full-range output will be sent to the center speaker output, and NO center channel signal will be sent to the subwoofer output.

NOTE: If you choose Logic 7 as the surround mode for the particular input source for which you are configuring your speakers, the AVR 7300 will not make the **LARGE** option available for the center speaker. This is due to the requirements of Logic 7 processing, and does not indicate a problem with your receiver.

When **NONE** is selected, no signals will be sent to the center channel output. The receiver will operate in a "phantom" center channel mode and center channel information will be sent to the left and right front channel outputs. When only front left and right speakers are used, with no center or surround speakers, VMAx is a good alternative mode.

When you have completed your selection for the center channel, press the **▼ Navigation Button 15** to move the cursor to **SURROUND**.

Press the **◀/▶ Navigation Button 15** to select the option that best describes the surround speakers in your system based on the definitions shown on this page.

When **SMALL** is selected, low-frequency surround channel sounds will be sent to the subwoofer output only. If you choose this option and there is no subwoofer connected, you will not hear any low-frequency sounds from the surround channels.

When **LARGE** is selected, a full-range output will be sent to the surround channel outputs, and NO surround channel signals will be sent to the subwoofer.

When **NONE** is selected, surround sound information will be split between the front left/right outputs. For optimal performance with no surround speakers, use the Dolby Virtual Speaker mode.

When you have completed your selections for the main surround channels, press the **▼ Navigation Button 15** to move the cursor to **SURR BACK**. This line serves two functions: It not only configures the setting for the surround back channels if present; it also tells the AVR 7300's processing system to set the unit for either 5.1 or 6.1/7.1 operation.

In addition to the speaker "size," **MAIN** or **MULTI** will appear on this line to display the Surround Back channel amplifier status. When **MAIN** appears, the unit is set for 7.1-channel operation. When **MULTI** appears, the Surround Back amplifier channels have been reconfigured so that they are fed by the output of the Multiroom system. See page 39 for more information on configuring the Surround Back amplifier channels.

Press the **◀/▶ Navigation Button 15** on the remote to select the option that best describes the speakers in use at the left and right back surround positions based on the definitions on this page:

When **NONE** is selected, the system will adjust so that only 5.1-channel modes are available. When this is the case for your system, you may wish to use the surround back amplifier channels to power a second set of speakers whose source is selected by the AVR 7300's multiroom system. See page 39 for more information.

When **SMALL** is selected, the system will adjust so that the full complement of 6.1/7.1 modes are available, and low-frequency information below the crossover point will be sent to the subwoofer output. If you choose this option and there is no subwoofer connected, you will not hear any low-frequency sounds from the surround back channels.

When **LARGE** is selected, the system will adjust so that the full complement of 6.1/7.1 surround processing/decoding modes are available, and a full-range signal will be sent to the surround back channels, with no low-frequency information sent to the subwoofer output.

When you have completed your selection for the surround back channels, press the **▼ Navigation Button 15** to move the cursor to **SUBWOOFER**.

Press the **◀/▶ Navigation Button 15** to select the option that best describes your system.

The choices available for the subwoofer position will depend on the settings for the other speakers, particularly the front left/right positions.

If the front left/right speakers are set to **SMALL**, the subwoofer will automatically be set to **SUB**, which is the "on" position.

If the front left/right speakers are set to **LARGE**, three options are available:

- If no subwoofer is connected to the DPR 2005, press the **◀/▶ Navigation Button 15** until **NONE** appears. With this option, all bass information will be routed to the front left/right "main" speakers.
- If a subwoofer is connected to the AVR 7300, you have the option to have the front left/right "main" speakers reproduce bass frequencies at all times, and have the subwoofer operate only when the DPR 2005 is being used with a digital source that contains a dedicated low-frequency effects, or LFE soundtrack. This allows you to use both your main and subwoofer speakers to take advantage of the special bass sounds created for some movies. Press **◀/▶ Navigation Button 15** until **SUB (LFE)** appears.
- If a subwoofer is connected and you wish to use it for bass reproduction in conjunction with the main front left/right speakers, regardless of the type of program source or Surround mode you are listening to, press the **◀/▶ Navigation Button 15** until **SUB L/R+LFE** appears. When this option is selected, a full-range signal will be sent to the front left/right "main" speakers, and the subwoofer will receive LFE information and the bass frequencies under the selected crossover point.

When all initial speaker "size" settings have been made, you now have the option to take advantage of the AVR 7300's Quadruple Crossover system, which allows individual crossover settings to be made for each speaker group. The low-frequency crossover point is set by the design of your speakers. Depending on the design and driver complement of your speakers, it is defined as the frequency which is either the lowest possible frequency the speaker is capable of reproducing, or the frequency at which sound is sent to the speaker's internal low-frequency driver, as opposed to the midrange driver.

Before making any changes to the settings for the crossover point, we suggest that you find the crossover point for the speakers in each of the four groupings, front left/right, center front, surround and surround back, by looking at the specifications page of each speaker's owner's manual, by getting that information from the manufacturer's Web site, or by contacting your dealer or the manufacturer's customer service department. You will need this figure to accurately configure the next group of settings.

SYSTEM CONFIGURATION

Note that when any speaker group other than the front left/right speakers is set to **LARGE**, the crossover may not be adjusted, as the feed will be full-range, with no sound being derived for the subwoofer from that position.

The factory default setting for all speaker positions is 100Hz. If that setting is acceptable for all channels, then no adjustments are needed and you may skip this section. However, should you wish to change one of the settings, please proceed by pressing the **▲ Navigation Button 15** so that the cursor moves back up to the **MODE** line. Press the **◀/▶ Navigation Button 15** so that **X-OVER** is highlighted and the menu data will change to the screen shown in Figure 8.

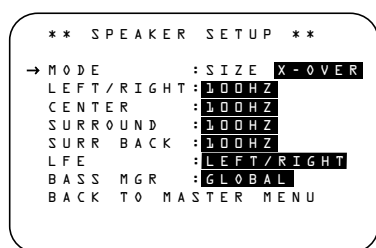

Figure 8

To change the setting for any of the four speaker groups, press the **▲/▼ Navigation Button 15** until the cursor is next to the speaker group where you wish to make a change and then press the **◀/▶ Navigation Button 15** until the desired setting appears. The available choices for low-frequency information to be sent to the subwoofer, rather than to the main speaker channel, are 40Hz, 60Hz, 80Hz, 100Hz, 120Hz and 200Hz. Pick the choice that is identical to the information for the speakers, or if an exact match is not possible, pick the closest choice that is ABOVE the speaker's low-frequency limit or crossover point to avoid the creation of a low-frequency "hole" where your system will have no bass information.

The setting for the crossover point for the LFE channel, which is created to provide specific low-frequency information in many movies with digital soundtracks, may be set to match the crossover for any of the four speaker groups. Since the crossover point commonly used in the creation of the LFE channel is 120Hz, we recommend that you select the speaker group whose crossover point is closest to 120Hz. To do this, press the **▲/▼ Navigation Button 15** until the cursor is next to the **LFE** line, and then press the **◀/▶ Navigation Button 15** until the name of the speaker group with the desired crossover frequency appears. Of course, you may also experiment with different settings to find the one that provides the

smoothest and most complete bass response in your particular listening environment.

When all crossover settings have been made, or in those cases where none are needed, press the **▼ Navigation Button 15** so that the cursor is next to the **BASS MGR** line to make the final setting on this menu.

This setting allows you to use the same speaker configuration and crossover settings for all inputs, or to have different settings for each input. In most cases, the factory default setting of **GLOBAL** will be appropriate, as most systems do not need individual speaker settings. However, when full-range front speakers are used for both movies and music, different bass management settings may be used when listening to music through a CD player as opposed to a movie from a DVD player, VCR or cable/satellite set-top.

To customize the speaker-size configurations to each input, make certain that the **MODE** line of the **SPEAKER SETUP** menu is set to **SIZE**, and that the cursor is on the **BASS MGR** line. Press the **◀/▶ Navigation Button 15** so that **INDEPENDENT** appears in highlighted video. When this choice is entered by exiting the menu, the settings just entered will apply to the current input ONLY, and you will need to go back to the **IN/OUT** menu to select another input, and then return to this menu page to change the settings for the next input. Repeat the procedure for any input where you wish to have a different set of speaker configuration and crossover settings.

NOTE: The independent feature allows you to select a different speaker size configuration (Large, Small or None, as appropriate) for each input source. However, the individual crossover point setting may only be set once, and the selection made during the initial setup will be used for all inputs, regardless of any changes made to the "Large" or "Small" settings for the speaker groups attached to any input. The reason is that while you may prefer different settings for the bass redirection (that is, which signals go to the subwoofer or the speaker group), the actual crossover point remains the same since the actual loudspeakers themselves remain the same regardless of any other setting.

When all speaker selections have been made, press the **▼ Navigation Button 15** and then the **Set Button 17** to return to the **MASTER MENU**.

Delay Settings

Due to the different distances between the listening position and each speaker position, the amount of time it takes for sound to reach your ears from each

channel is different. You may compensate for this difference through the use of the delay settings to adjust the timing for the speaker placement and acoustic conditions in your listening room or home theater.

The AVR 7300's advanced software enables you to quickly and easily set delay times without the need to calculate them using a complex formula. Instead, all you need to do is measure the approximate distance between your listening position and each of the speakers in your system. When you enter those distances into the DPR's memory as shown below, the DPR's microprocessor does the rest of the work, calculating the proper delay time. The measurements need not be accurate to the inch, as the system is designed to accommodate a typical listening area rather than require the precise measurement to one "sweet spot" position.

In addition to adjusting the delay time for each individual speaker position, the AVR 7300 is among the few receivers that allows you to adjust the delay for the combined output of all speakers as a group. This feature is called A/V Sync Delay; it allows you to compensate for delays to the video image that may be caused by the processing in products such as digital video displays, video scalars, digital cable or satellite systems, or personal video recorders. With proper adjustment of the setting for A/V Sync Delay, you can eliminate the loss of lip sync that may be caused by digital video applications.

Due to the differences between the way surround modes operate, some modes allow for a greater range of delay times than others. To avoid problems, we recommend that delay times be adjusted using the Dolby Digital mode. If a different mode is selected at a later time, the AVR 7300 will automatically select the closest delay settings available for the surround mode in use.

Delay times are adjustable only for the Dolby and DTS modes, so you will notice that the **DELAY** menu may not be accessed for other modes, such as Logic 7. In addition, when a non-Dolby Digital mode such as Pro Logic II is selected, adjustments may be made to the Surround speakers only.

To set the delay time for a specific input, the **DELAY ADJUST** menu (Figure 9) should be visible on your on-screen display. If the system is not already at that point, press the **OSD Button 31** to bring up the **MASTER MENU**, press the **▼ Navigation Button 15** until the on-screen cursor is pointing at the **DELAY ADJUST** line. Press the **Set Button 17** to call up the menu.

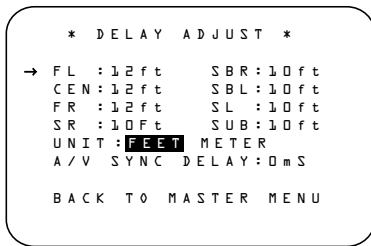

Figure 9

Once the **DELAY ADJUST** menu is on your screen, note that the default for distance settings is in feet. If your measurements are in feet, proceed to the next step; if your measurements are made in meters, press the **Navigation Button 15** until the on-screen **→** cursor is at the **UNIT** line on the menu. Then, press the **Navigation Button 15** so that **METER** is highlighted. When the change in measurement units is made, press the **Navigation Button 15** to return the **→** cursor to the **FL** position.

With the on-screen **→** cursor pointing to **FL**, press the **Navigation Button 15** until the distance from the front left speaker to the preferred listening position is entered. Next, press the **Navigation Button 15** to move the cursor to the **NEXT** line and use the **Navigation Button 15** again to enter the distance from the main listening position to the center speaker. Repeat the procedure for all active speaker positions, first using the **Navigation Button 15** to change to the next position, and then use the **Navigation Button 15** to change the setting. Note that only the speaker positions that have been set to **LARGE** or **SMALL** in the **SPEAKER SETUP** menu, as shown on page 24, may be adjusted. The appearance of three dashes next to a speaker position in place of a distance setting indicates that you have not configured an active speaker for that location.

When the delay time for all speaker positions has been set you may return to the master menu by pressing the **Navigation Button 15** until the **→** cursor is pointing to **BACK TO MASTER MENU** and then pressing the **Set Button 17**. However, when a digital video source or a digital video display causes lack of lip sync, you may use the A/V Sync Adjust feature to delay the audio signal as it is sent to all channels (as opposed to the individual channels) so that the picture and sound are brought back into sync. We recommend that this adjustment be made using the direct access controls on the remote, as shown below. That enables you to see the image while making the adjustment. However, you may also adjust it here using the menu system.

To adjust the A/V Sync delay, press the **Navigation Button 15** so that the **→** cursor is pointing to **A/V SYNC DELAY** on the menu; then press the **Navigation Button 15** to delay the sound sufficiently so that it matches the on-screen video.

The delay settings may be adjusted at any time using the remote control and while viewing an on-screen image by pressing the **Delay Select Button 37**. The A/V Sync Delay setting is first, and it may be adjusted by pressing the **Set Button 17** within five seconds of when the **A/V SYNC DELAY** message appears in the on-screen display and the **Lower Display Line 17**. Then, press the **Navigation Button 15** to enter the desired delay setting that brings the video and sound back in sync. Press the **Set Button 17** again to enter the setting.

Note that the A/V Sync delay setting is unique to each video input source, so you may enter a different setting to compensate for the differences between any product attached to the DVD or Video inputs.

To change one of the individual speaker positions directly, press the **Delay Select Button 37**, followed by the **Navigation Button 15** to select the desired position as that name appears in the on-screen display and the **Lower Display Line 17**. When the name of the speaker position to be adjusted appears, press the **Set Button 17** within 5 seconds. Press the **Navigation Button 15** to enter the desired delay setting for that speaker; then press the **Set Button 17** to enter the setting. The **Navigation Button 15** may be used to select another position, or you may wait 5 seconds for the system to time out and return to normal operation.

When all delay settings made using the menu system have been completed, press the **Navigation Button 15** until the **→** cursor is pointing to the **BACK TO MASTER MENU** line and press the **Set Button 17**.

Output Level Adjustment

Output level adjustment is a key part of the configuration of any surround sound product. It is particularly important for a digital receiver such as the AVR 7300, as correct outputs ensure that you hear soundtracks with the proper directionality and intensity.

IMPORTANT NOTE: Listeners are often confused about the operation of the surround channels. While some assume that sound should always be coming from each speaker, most of the time there will be little or no sound in the surround channels. This is because they are only used when a movie director or sound mixer specifically places sound there to create ambi-

ence, a special effect or to continue action from the front of the room to the rear. When the output levels are properly set, it is normal for surround speakers to operate only occasionally. Artificially increasing the volume to the rear speakers may destroy the illusion of an enveloping sound field that duplicates the way you hear sound in a movie theater or concert hall.

Before beginning the output level adjustment process, make certain that all speaker connections have been properly made. The system volume should be set to the level that you will use during a typical listening session. While the AVR 7300 allows you to set output levels manually, we recommend that the EzSet system be used when the DPR is first installed to establish the initial level settings.

Using EzSet

Harman Kardon's exclusive EzSet remote makes it possible to quickly and accurately set the DPR 2005's output levels without the use of a sound-pressure meter, although manual adjustment is also available. However, for the easiest setup, follow these steps while seated in the listening position that will be used most often:

1. Make sure all speaker positions have been configured for their "large" or "small" settings (see pp. 24–26) and turn off the OSD system if it is in use.
2. Adjust the volume so that it is at **-15dB**, or a level that is closest to the setting you prefer for a typical listening session, as shown in the on-screen display or **Lower Display Line 17**.
3. Press and hold the **SPL Select Button 45** until the red LED under the **Set Button 17** lights and the LCD screen in the remote changes to the display shown in Figure 10.
4. Press the **Set Button 17** within five seconds to move to the next step.
5. Press the **Navigation Button 15** until the lower line of the remote's LCD display shows the number of speakers in your system. (Don't count the subwoofer or speakers that are part of a multizone system.) For example, if you have left, center, right, surround left and right, and surround back left and right speakers for a full 7.1 system, press the button twice so that the bottom line reads **7 CHANNELS**, as shown in Figure 11.



Figure 10



Figure 11

SYSTEM CONFIGURATION

6. Hold the remote in front of you at arm's length, being sure not to cover the **EzSet Microphone Sensor 46** at the top of the remote, and press the **Set Button 17** within five seconds to begin the EzSet calibration process. At this point, EzSet will take control of your DPR, starting the test tone at the front left speaker, and automatically adjusting the output level so that it is correct. During the adjustment the on-screen display and the **Lower Display Line 17** will display the speaker position on the left side of the display and the offset from reference level on the right side of the display. As the levels are adjusted, the speaker position and a level indication will appear in the bottom line of the remote's LCD display (Figure 12).

```
EzSet CHANNELS: 7
SPEAKER: 1 68dB
```

Figure 12

- The channel position being adjusted will flash in the **Speaker/Channel Input Indicators 15**. If the test noise is heard from a channel other than the one shown in the indicator, there is an error in the speaker connections. If this is the case, press the **Test Button 6** TWICE to stop the adjustment. Then turn the unit off and verify that all speakers are connected to the proper **Speaker Outputs 24, 25, 26, 27** and that any connections made to speakers powered by optional amplifiers through the **Preamp Outputs 13** are correct.
- During the adjustment process for each channel, you will see indications of **LOW**, **HIGH** and a level readout in **dB**. This is normal, and it confirms that EzSet is doing its job of changing the levels to match the desired reference.
- If a channel cannot be adjusted to the proper reference level, you will see **FAIL** displayed in the remote's bottom LCD line before the test tone moves to the next channel. This is usually an indication that the volume control was set too low. When EzSet stops circulating the tone through all channels and returns to normal, adjust the volume level and repeat the procedure from Step 3.

7. After the test noise has circulated once through each channel, it will send the tone to each channel once again, to verify the settings.

8. After two complete circulations of the tone, the levels are set. Upon completion of the second circulation, the **LCD Information Display 3** will flash **COMPLETE** three times and then go out. The tone will stop and the DPR 2005 will return to normal operation.

If you find that the output levels chosen by EzSet are either uncomfortably low or high, you may repeat the procedure. Return to Step 2 and adjust the master volume either slightly higher or lower to accommodate your particular room layout and your tastes. You may repeat this procedure as many times as necessary to achieve a desired result. In order to prevent possible damage to your hearing or your equipment, it is important to avoid setting the master volume above 0dB.

NOTE: The subwoofer output is not adjusted when the test tone is in use. To adjust the subwoofer output, you must use an external source (see page 36).

Manual Output Level Adjustment

Output levels may also be adjusted manually, either to set them to a specific level with an SPL meter, or to make fine tuning adjustments to the levels obtained using the EzSet remote.

```
* CHANNEL ADJUST *
→ FL : 0 dB SBR : 0 dB
CEN : 0 dB SBL : 0 dB
FR : 0 dB SL : 0 dB
SR : 0 dB SUB : 0 dB
CHANNEL RESET : OFF ON
TEST TONE SEQ : AUTO
TEST TONE : OFF ON
BACK TO MASTER MENU
```

Figure 13

Manual output level adjustment is most easily done through the **CHANNEL ADJUST** menu (Figure 13). If you are already at the **MASTER MENU**, press the **▼ Navigation Button 15** until the on-screen **→** cursor is next to the **CHANNEL ADJUST** line. If you are not at the **MASTER MENU**, press the **OSD Button 31** to bring up the **MASTER MENU** (Fig. 1), and then press the **▼ Navigation Button 15** until the on-screen **→** cursor is next to the **CHANNEL ADJUST** line. Press the **Set Button 17** to bring the **CHANNEL ADJUST** menu (Figure 13) to the screen.

When the **CHANNEL ADJUST** menu first appears the test tone is off. If desired, you may immediately use the **▲/▼ Navigation Button 15** to select any channel for adjustment using an external source, such as a test disc, from which to judge the output levels. After the **→** cursor is pointing to the channel to be adjusted, press the **◀/▶ Navigation Button 15** to raise or lower the output level. However, before proceeding with any manual adjustment we recommend that you first use the DPR's internal test tone generator and automatic sequencer to send a tone to each channel so that you may verify that all speaker connections have been properly made.

To turn the test tone on and have it automatically circulate among the channels where a speaker has previously been configured (see page 24), press the **▲/▼ Navigation Button 15** until the **→** cursor is pointing to the **TEST TONE** line on the menu. Next, press the **◀/▶ Navigation Button 15** until **AUTO SEQ** is shown in highlighted video. At this time the test tone will immediately begin to circulate clockwise around the room, playing for two seconds in each speaker before switching to the next speaker position. The **→** cursor will blink next to the active speaker to indicate which speaker the sound should be coming from.

As the test noise circulates, listen to make certain that the sound comes from the speaker position shown in the **Lower Display Line 17**. If the sound from a speaker location does NOT match the position indicated in the display, turn the DPR 2005 off using the **Main Power Switch A** and check the speaker wiring or connections to external power amplifiers to make certain that each speaker is connected to the correct output terminal.

After checking for speaker placement, let the test noise circulate again, and listen to see which channels sound louder than the others. Using the front left speaker as a reference, press the **◀/▶ Navigation Button 15** to bring all speakers to the same volume level. When the **◀/▶ Navigation Button 15** is pushed, the test noise circulation will pause on the channel being adjusted to give you time to make the adjustment. When you release the button, the circulation will resume after five seconds.

Continue to adjust the individual channels until the volume level sounds the same from each speaker. Adjustments should be made with the **◀/▶ Navigation Button 15** only, NOT the main volume controls. If you are using a sound-pressure level (SPL) meter for precise level adjustment, set the volume so that the meter reads 75dB, C-Weighting Slow.

You may also make these same adjustments with complete manual control over the channel being adjusted by pressing the **▲/▼ Navigation Button 15** until the **→** cursor is pointing to the **TEST TONE SEQ** line on the menu and then using the **◀/▶ Navigation Button 15** to select **MANUAL** in the highlighted video. In the **MANUAL** mode, the test tone will also start immediately, but the tone will only be moved to another channel by pressing the **▲/▼ Navigation Button 15**. When the manual sequencing mode is active, the tone is turned off by pressing the **▲/▼ Navigation Button 15** until the **→** cursor is pointing to the **TEST TONE** line and the **◀/▶ Navigation Button 15** is then pressed to select **OFF** in the highlighted video.

The DPR's EzSet feature may also be used as an SPL meter to assist in accurate setting of the output levels, when either the internal test tone or an external source such as a test disc is used. To use the remote as an SPL meter, follow these steps:

1. Press and hold the **SPL Select Button 45** until the red LED under the **Set Button 17** lights and the LCD screen in the remote changes to the display shown in Figure 10.
2. Press the **▲ Navigation Button 15** once to change the bottom line of the remote's LCD display to read **MANUAL SPL** as shown in Figure 14.

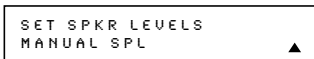

Figure 14

3. Press the **Set Button 17** within five seconds to activate the remote's manual mode, so that it functions as an SPL meter. The right corner of the bottom line of the remote's display will show the output level of the speakers as the test tone circulates. The level will show as a direct SPL indication between **66dB** and **79dB**. Below **66dB** the remote will read **LOW** and above **79dB** it will read **HIGH**.
4. When you are finished with all adjustments, press the **Clear Button 10** to return the remote to normal operation.

NOTE: The subwoofer level is not adjustable when the normal test tone is in use. The subwoofer output level may also be adjusted when the channel levels are being trimmed to a program source rather than the test tone, as shown on page 36.

When all channels have an equal volume level, the adjustment is complete. To exit this menu, press the **▲/▼ Navigation Button 15** until the on-screen **→** cursor is next to the **BACK TO MASTER MENU** line, and then press the **Set Button 17** to return to the **MASTER MENU**.

To adjust the output levels at any time using the remote control and semi-OSD messages, first press the **Test Button 6**. As soon as the button is pressed, the test tone will begin to circulate as indicated earlier. The correct channel from which the test noise should be heard will be shown on the video screen and the **Lower Display Line 17**. While the test noise is circulating, the proper channel position will also be indicated in the **Speaker/Channel Input Indicators 15** by a blinking letter within the correct channel.

To adjust the output level, press the **▲/▼ Navigation Button 15** until the desired level is heard. Once the buttons are released, the test noise will begin to circulate again in five seconds.

When all channels have the same output level, press the **Test Button 6** again to complete the process.

NOTE: Output level adjustment is not available for the VMAx or Surround Off modes.

Additional Input Adjustments

After one input has been adjusted for Surround mode, digital input (if any), speaker type, and output levels, go back to the **IN/OUT SETUP** line on the **MASTER MENU** (Figure 1) and enter the settings for each input you will use. In most cases, only the digital input and surround mode will be different from one input to the next, while the other settings will usually be the same.

If you wish to have different speaker "size" and crossover settings for an input, remember to change the **BASS MGR** setting to **INDEPENDENT**, as shown on page 26. When all settings and adjustments have been made, press the **OSD Button 31** to return to normal operation of the DPR.

Once the settings outlined on the previous pages have been made, the AVR 7300 is ready for operation. While there are some additional settings to be made, these are best done after you have had an opportunity to listen to a variety of sources and different kinds of program material. These advanced settings are described on pages 37 and 38 of this manual. In addition, any of the settings made in the initial configuration of the unit may be changed at any time. As you add new or different sources or speakers, or if you wish to change a setting to better reflect your listening taste, simply follow the instructions for changing the settings for that parameter as shown in this section.

Having completed the setup and configuration process for your AVR 7300, you are about to experience the finest in music and home theater listening. Enjoy!

OPERATION

Basic Operation

Once you have completed the initial setup and configuration of the AVR 7300, it is simple to operate and enjoy. The following instructions will help you maximize the enjoyment of your new receiver:

Turning the DPR 2005 On or Off

- When using the AVR 7300 for the first time, you must press the **Main Power Switch A** to turn the unit on. This places the unit in a Standby mode, as indicated by the **Standby/On Indicator 1** turning amber. Once the unit is in Standby, you may begin a listening session by pressing the **Standby/On Button 2** on the front panel, or the **Power On Button 2** or **AVR Selector 5 B** on the remote. This will turn the unit on and return the DPR to the input source that was last used. The unit may also be turned on from Standby by pressing any of the **Input Selector Buttons 4 34 44 C D** on the remote or the **Input Source Selector Button 8** on the front panel.

Whenever the DPR is turned on, you will see all of the front-panel indicators light up for a few seconds. This is normal, and it is part of the unit's power-on self test.

NOTE: After pressing one of the **Input Selector Buttons 4 34 44 C D** to turn the unit on, press the **AVR Selector 5 B** to set the remote control to the DPR 2005 functions.

To turn the unit off, simply press the **Standby/On Switch 1** on the front panel or the **Power Off Button 1 A** on the remote. Power will be shut off to any equipment plugged into the rear-panel **Switched AC Accessory Outlet 25** and the **Standby/On Indicator 1** will turn amber.

When the remote is used to turn the unit "off," it is actually placing the system in a Standby mode, as indicated by the amber lighting of the **Standby/On Indicator 1**.

- To program the AVR 7300 for automatic turn-off, press the **Sleep Button 29** on the remote. Each press of the button will decrease the time before shut-down in the following sequence:

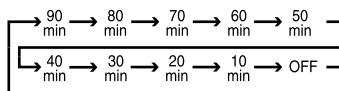

The sleep time will be displayed in the **Lower Display Line 17** and it will count down until the time has elapsed.

The front-panel display will dim to half brightness when the Sleep function is programmed. To cancel the Sleep function, press and hold the **Sleep Button 29** until the information display returns to normal brightness; and the words **SLEEP OFF** will appear in

the **Lower Display Line 17**. When the programmed sleep time has elapsed, the unit will turn off.

When you will be away from home for an extended period of time, it is always a good idea to turn the unit off with the front-panel **Main Power Switch A**.

NOTE: All preset memories are lost if the unit is left turned off by using the **Main Power Switch A** for more than four weeks.

Source Selection

- To select a source, press any of the **Input Selector Buttons 4 34 44 C D** on the remote.
 - The input source may also be changed by pressing the front-panel **Input Source Selector Button 8**. Each press of the button will move the input selection through the list of available inputs.
 - When a new input is selected, the DPR will automatically switch to the digital input (if selected), surround mode, component video input, A/V Sync Delay and Night Mode configurations that were in effect the last time that input was used. If the **BASS MGR** line on the **SPEAKER SETUP** menu (Fig. 7) was set to **INDEPENDENT**, as described on page 26, the settings for speaker size will also change to the preset values.
 - The front-panel **Video 5 Inputs K**, **Optical Digital 3 Input H** or the **Coaxial Digital 3 Input J** may be used to connect a device such as a video game or camcorder to your home entertainment system on a temporary basis.
 - As the input source is changed, the new input name will appear momentarily as an on-screen display in the lower third of the video display. The input name will also appear in the **Upper Display Line 16** and in the front-panel **Input Indicators 14**.
 - When an audio source is selected, the last video input used remains routed to the **Video 1/Video 2 Outputs 3 5** and **Video Monitor Outputs 8**. This permits simultaneous viewing and listening to different sources.
 - When a composite or S-Video source is selected, the video signal for that input will be routed to the **Video Monitor Output 8** and will be viewable on a TV monitor connected to the AVR 7300.
- ### 6-Channel/8-Channel Direct Input
- There are two input choices available for use with sources such as a DVD-Audio or SACD player that are connected to the **8-Channel Direct Inputs 15**. Select the appropriate input for your system and source equipment:

- The **6 CH DVD AUDIO** input should be used when the SBR and SBL inputs are not in use. When this input is used, the analog source is converted to digital so that you may use the same bass-management options for the direct input as you do with all other outputs. This input also mutes the unused SBL and SBR input jacks to prevent unwanted noise from interfering with system performance.

- The **8 CH DVD AUDIO** input should be used when an input is connected to all eight **8-Channel Direct Inputs 15**. When this input is in use, the analog source is converted to digital so that you may use the same Quadruple Crossover bass-management options for the direct input as you do with all other outputs.

Volume and Tone Control

- Adjust the volume to a comfortable level using the front-panel **Volume Control 13** or remote **Volume Up/Down Buttons 18 1**.
- To temporarily silence all speaker outputs, press the **Mute Button 33 K**. This will interrupt the output to all speakers and the headphone jack, but it will not affect any recording or dubbing that may be in progress. When the system is muted, the word **MUTE** will flash in the on-screen display and **Upper Display Line 16**, press the **Mute Buttons 33 K** again to return to normal operation.
- The unit's tone controls may be taken out of the signal path by pressing the **Tone Mode Button** on the front panel **B** or the remote **32**. The first press of either button will show a message in the on-screen display and **Lower Display Line 17** with the current status of the tone controls. The system default is **TONE IN**, which indicates that the bass and treble controls are active. Press the **▲/▼ Navigation Button 15** on the remote or the **▲/▼ Button 11** on the front panel to change the setting to **TONE OUT**, which is "flat" response without the tone controls being active.
- When the tone controls are active, the bass and treble boost/cut may be adjusted by first pressing the **Tone Mode Button** on the front panel **B** or the remote **32** until the desired setting (**BASS MODE** or **TREBLE MODE**) appears in the on-screen display and the **Lower Display Line 17**. Next, use the **▲/▼ Navigation Button 15** on the remote or the **▲/▼ Button** on the front panel **11** to change the setting as desired. The unit will return to normal operation within five seconds after the setting is changed.
- For private listening, simply place a standard 1/4" stereo headphone plug or adaptor into the

Headphone Jack **6** behind the door **12** on the front panel. The speakers will automatically mute and a two-channel stereo signal will be sent to the headphones. The **Lower Display Line** **17** will read **DOLBY H: BP**, indicating that the headphone output is in the Bypass mode, and to confirm that no processing is being used.

- When the headphones are in use, you may take advantage of the Dolby Headphone modes to bring added spaciousness to headphone listening. Press the **Dolby Mode Select Button** **43** or the **Surround Mode Selector** **4** to cycle through the three Dolby Headphone modes to select the one that you prefer.

Surround Mode Selection

One of the most important features of the AVR 7300 is its ability to reproduce a full multichannel sound field from digital sources, analog matrix surround-encoded programs and standard stereo programs.

Selection of a surround mode is based on personal taste, as well as the type of program source material being used. For example, motion pictures or TV programs bearing the logo of one of the major surround-encoding processes, such as Dolby Surround or DTS Stereo may be played in either the Dolby Digital, Dolby Pro Logic II Cinema, Dolby Pro Logic IIx Cinema, DTS Neo:6 Cinema, or Logic 7 Cinema surround modes, depending on the source material.

NOTE: Once a program has been encoded with matrix surround information, it retains the surround information as long as the program is available in stereo. Thus, movies with surround sound may be decoded via any of the analog surround modes such as Pro Logic II or IIx Cinema, Logic 7 Cinema or DTS Neo:6 Cinema, when they are broadcast via conventional TV stations, cable, pay-TV and satellite transmission. Also, a growing number of TV programs, sports broadcasts and radio dramas are also recorded in surround sound.

Even when a program is not listed as carrying intentional surround information, you may find that the Pro Logic II, Logic 7 Enhanced or DTS Neo:6, VMaX and the Hall or Theater modes often deliver enveloping surround presentations through the use of the natural information present in all stereo recordings.

Surround modes may be changed at any time by using either the front panel or remote control. To select a new surround mode from the front panel, first press the **Surround Mode Group Selector Button** **3** until the desired major surround mode group such as Dolby, DTS or Logic 7 is selected. Next, press the **Surround Mode Selector Button** **4** to choose the specific individual surround mode.

To select a surround mode using the remote, press the button for the surround mode group that includes the mode you wish to choose: **Dolby** **43**, **DTS Digital** **42**, **DTS Neo:6** **41**, **Logic 7** **8**, **Stereo** **40** or **DSP Surround** **7**. The first press of the button will show the current mode from that group if it is already in use, or the first available mode if you are currently using another mode. To cycle through the available modes in that group, press the button again until the desired mode appears in the **Lower Display Line** **17**, the on-screen display and in the front-panel **Surround Mode Indicators** **18**.

The Dolby Digital, Dolby Digital EX, DTS 5.1, DTS-ES Matrix and DTS-ES Discrete modes may only be selected when a digital input is in use. In addition, when a digital source is present, the AVR 7300 will automatically select and switch to the correct mode, regardless of the mode that has been previously selected. For more information on selecting digital sources, see the Digital Audio Playback section below.

When the 6-Channel/8-Channel direct inputs are in use, there is no surround processing, as these inputs take the analog output signals from an optional, external DVD-Audio or SACD player, or another source device, and carry them straight through to the volume control.

To listen to a program in traditional two-channel stereo, using the front left and front right speakers only (plus the subwoofer, if installed and configured), press the **Stereo Mode Select Button** **40** until **SURROUND OFF** appears in the **Lower Display Line** **17**. From the front panel, press the **Surround Mode Group Selector** **3** until the Stereo modes appear in the on-screen display and **Lower Display Line** **17**. Next, press the **Surround Mode Selector Button** **4** until **SURROUND OFF** appears in the on-screen display and **Lower Display Line** **17**.

Digital Audio Playback

Digital audio is a major advancement over analog surround processing systems. It delivers up to six discrete channels, and each channel reproduces full frequency range (20Hz to 20kHz) and offers dramatically improved dynamic range and significant improvements to signal-to-noise ratios. In addition, digital systems have the capability to deliver an additional channel that is specifically devoted to low-frequency information. This is the ".1" channel referred to when you see these systems described as "5.1," "6.1" or "7.1." The bass channel is separate from the other channels, but since it is intentionally bandwidth-limited, sound designers have given it that unique designation.

Dolby Digital

Dolby Digital is a standard part of DVD, and is available on specially encoded LD discs and satellite broadcasts and it is a part of the high-definition television (HDTV) system.

An optional, external RF demodulator is required to use the AVR 7300 to listen to the Dolby Digital soundtracks available on laser discs. Connect the RF output of the LD player to the demodulator and then connect the digital output of the demodulator to the **Optical or Coaxial Inputs** **16/17 H/J** of the AVR 7300. No demodulator is required for use with DVD players or DTS-encoded laser discs.

DTS

DTS is a digital audio system capable of delivering 5.1 or 6.1 discrete or matrix sound field reproduction. Although both DTS and Dolby Digital are digital, they use different methods of encoding the signals, and thus they require different decoding circuits to convert the digital signals back to analog.

DTS-encoded soundtracks are available on select DVD and LD discs, as well as on audio-only DTS discs. You may use any LD or CD player equipped with a digital output to play DTS-encoded discs with the DPR 2005. All that is required is to connect the player's output to either an **Optical or Coaxial Input** on the rear panel **16/17** or front panel **H/J**.

In order to listen to DVDs encoded with DTS soundtracks, the DVD player must be compatible with the DTS signal, which is indicated by the "DTS Digital Out" logo on the player's front panel. Some early DVD players were not able to play DTS-encoded DVDs. This does not indicate a problem with the AVR 7300, as those players cannot pass through the DTS signal. If you're in doubt as to the capability of your DVD player to handle DTS discs, consult the player's owner's manual.

IMPORTANT NOTE: Many DVD players have a default setting that does not pass through the DTS data, even though the machine is capable of doing so. If your DVD player has the "DTS Digital Out" logo but does not trigger DTS playback in the AVR 7300, change the player's settings in the "Audio" or "Bitstream" configuration menu so that DTS playback is enabled. The method for doing this will vary with each player. In some cases, the proper menu choice will be "Original" while in others it will be "DTS." Consult the owner's manual for your player to find the specific information to find the proper setting.

OPERATION

Surround Mode Chart

MODE	FEATURES
Dolby Digital	Available only with digital input sources encoded with Dolby Digital data. It provides up to five separate main audio channels and a special dedicated low-frequency effects channel.
Dolby Digital EX	Available when the receiver is configured for 6.1/7.1 channel operation, Dolby Digital EX is the latest version of Dolby Digital. When used with movies or other programs that have special encoding, Dolby Digital EX reproduces specially encoded soundtracks so that a full 6.1/7.1 soundfield is available. When the receiver is set for 6.1/7.1 operation and a Dolby Digital signal is present, the EX mode is automatically selected. Even if specific EX encoding is not available to provide the additional channel, the special algorithms will derive a 6.1/7.1 output.
DTS 5.1	When the speaker configuration is set for 5.1-channel operation, the DTS 5.1 mode is available when DVD, audio-only music or laser discs encoded with DTS data are played. DTS 5.1 provides up to five separate main audio channels and a special dedicated low-frequency channel.
DTS-ES 6.1 Matrix DTS-ES 6.1 Discrete	When the speaker configuration is set for 6.1/7.1 operation, playback of a DTS-encoded program source will automatically trigger the selection of one of the two DTS-ES modes. Newer discs with special DTS-ES discrete encoding will be decoded to provide six discrete, full-bandwidth channels plus a separate low-frequency channel. All other DTS discs will be decoded using the DTS-ES Matrix mode, which creates a 6.1-channel sound field from the original 5.1-channel soundtrack.
Dolby Pro Logic II Movie Music Pro Logic	Dolby Pro Logic II decodes full-range, discrete, left, center right, right surround and left surround channels from either matrix surround-encoded programs or conventional stereo sources when an analog input is in use. The Dolby Pro Logic II Movie mode is optimized for movie soundtracks, while the Pro Logic II Music mode should be used with musical selections. The Pro Logic mode re-creates original Pro Logic processing for those who prefer that presentation.
Dolby Pro Logic IIx Music Movie	Dolby Pro Logic IIx is the latest extension of Dolby Pro Logic II technology that creates a discrete 6.1 and 7.1 sound field from matrix surround or two-channel stereo sources in systems configured for surround back speakers. Both Movie and Music versions of Pro Logic IIx are available. These modes may also be applied to a six-channel source connected to the 8-Channel Direct Inputs  so that the sound field is enhanced by adding back surround channels, as well as to enable the MAIN DOWNMIX option in the multiroom system so that a six channel direct input may be used as a source for the remote room.
Logic 7 Cinema Logic 7 Music Logic 7 Enhance	Exclusive to Harman Kardon for receivers, Logic 7 is an advanced mode that extracts the maximum surround information from either surround-encoded programs or conventional stereo material. When your system has been configured for use with Surround Back Speakers (see page 25), you may choose between either 7.1 or 5.1 versions of the Logic 7 modes, while only the 5.1 versions are available when there are no Surround Back Speakers. The Logic 7 C (or Cinema) mode should be used with any source that contains Dolby Surround or similar matrix encoding. Logic 7 C delivers increased center channel intelligibility, and more accurate placement of sounds with fades and pans that are much smoother and more realistic than with other decoding techniques. The Logic 7 M or Music mode should be used with analog or PCM stereo sources. Logic 7 M enhances the listening experience by presenting a wider front soundstage and greater rear ambience. Both Logic 7 modes also direct low-frequency information to the subwoofer (if installed and configured) to deliver maximum bass impact. The Logic 7 E (or Enhance) mode, available only when the 5.1 option is chosen, is an extension of the Logic 7 modes that is primarily used with musical programs. Logic 7 adds additional bass enhancement that circulates low frequencies in the 40Hz to 120Hz range to the front and surround speakers to deliver a less localized soundstage that appears broader and wider than when the subwoofer is the sole source of bass energy.
DTS Neo:6 Cinema DTS Neo:6 Music	These two modes are available with analog sources playing to create a three-channel, five-channel or six-channel surround presentation from matrix-encoded or stereo sources. Select the Cinema version of Neo:6 when a program with matrix surround encoding is present. Select the Music version of Neo:6 for optimal processing when a nonencoded, two-channel stereo program is being played.
Theater	The Theater mode creates a sound field that resembles the acoustic feeling of a standard live performance theater.
Hall 1, Hall 2	The two Hall modes create sound fields that resemble a small- (Hall 1) or medium-sized (Hall 2) concert hall.
VMAx Near VMAx Far	When only the two front-channel loudspeakers are used, VMAx delivers a three-dimensional sound space with the illusion of "phantom speakers" at the center and surround positions. The VMAx N, or "Near Field" mode should be selected when your listening position is less than five feet from the speakers. The VMAx F, or "Far Field," mode should be selected when your listening position is greater than five feet from the speakers.
Dolby Virtual Speaker Reference Wide	Dolby Virtual Speaker uses advanced technology to simulate the sonic signature of a speaker location even when there is no speaker physically present in that location. The Reference ("REF") mode activates the front left/right or front left/center/right speakers to simulate a 5.1 presentation with accurate localization. The Wide mode virtualizes additional front-channel speakers to create a wider image and a more enveloping sound field. It is available no matter how many speakers are present.
5-Channel Stereo 7-Channel Stereo	These modes take advantage of multiple speakers to place a stereo signal at both the front and back of a room. They place the same signal at the front-left and surround-left, and front-right and surround-right speakers. The center channel is fed a summed mono mix of the in-phase material of the left and right channels.
Surround Off (Stereo)	This mode turns off all surround processing and presents the pure left- and right-channel presentation of two-channel stereo programs.
Dolby Headphone DH1 DH2 DH3	Dolby Headphone enables ordinary stereo headphones to portray the sound of a five-speaker surround-playback system. The DH1 mode creates headphone presentation that resembles a small, well-damped room and is appropriate for use with both movies and music-only recordings. The DH2 mode creates a more acoustically live room particularly suited to music listening. The DH3 mode creates a larger room, more like a concert hall or movie theater.

Selecting a Digital Source

To utilize either digital mode, you must have properly connected a digital source to the DPR 2005. Connect the digital outputs from DVD players, HDTV receivers, satellite systems or CD players to the **Optical** or **Coaxial Inputs** **16****17****H****J**. In order to provide a backup signal and a source for analog stereo recording, the analog outputs provided on digital source equipment should also be connected to their appropriate inputs on the AVR 7300 rear panel (e.g., connect the analog stereo audio output from a DVD to the **DVD Inputs** **7** on the rear panel when you connect the source's digital outputs).

If you have not already configured an input for a digital source using the on-screen menus as shown on page 21, first select the desired input using the remote or front-panel controls, as outlined in this manual. Next, press the **Digital Select Button** **16****E** and then using the **▲/▼ Navigation Button** **15** on the remote or the **▲/▼ Buttons** **11** on the front panel, choose any of the **OPTICAL** or **COAXIAL** inputs, as they appear in the **Upper Display Line** **16** or on-screen display. When the digital source is playing, the AVR 7300 will automatically detect which type of digital data stream is being decoded and display that information in the **Upper Display Line** **16**.

When both a digital and an analog connection are made between a source device and the DPR, the digital input is the default. If the digital stream is not present or is interrupted, the unit will automatically switch over to the analog inputs for the selected source.

Digital Bitstream and Surround Mode Indications

When a digital source is playing, the DPR senses the type of bitstream data that is present. Using this information, the correct surround mode will automatically be selected. For example, DTS bitstreams will cause the unit to switch to DTS decoding, and Dolby Digital bitstreams will enable Dolby Digital decoding. When the unit senses PCM data from CDs or LDs, you may select any of the standard surround modes, such as Dolby Pro Logic II or Logic 7. Since the range of available surround modes is dependent on the type of digital data that is present, the AVR 7300 shows you what type of signal is present. This will help you to understand the choice of modes.

When a digital source is first detected, the AVR 7300 will display a message to indicate the type of bitstream being received. This message will appear shortly after an input or surround mode is changed, and will remain in the **Lower Display Line** **17** for about five seconds before that portion of the display returns to the normal surround mode indication.

For Dolby Digital and DTS sources, a three-digit indication will appear, showing the number of channels present in the data. An example of this type of display is 3/2/1.

The first number in the display message indicates how many discrete front-channel signals are present.

- A "3" tells you that separate front left, center and front right signals are available. This will be displayed for Dolby Digital 5.1 and DTS 5.1 programs.
- A "2" tells you that separate front left and right signals are available, but there is no discrete center channel signal. This will be displayed for Dolby Digital bitstreams that have stereo program material.
- A "1" tells you that there is only a mono channel available in the Dolby Digital bitstream.

The middle number in the display message indicates how many discrete surround channel signals are present.

- A "3" tells you that separate, discrete left surround, center surround and right surround signals are present. This is available only on discs with DTS-ES digital audio.
- A "2" tells you that separate surround left and right signals are available. This will be displayed for Dolby Digital 5.1 and DTS 5.1 programs.
- A "1" tells you that there is only a single, surround-encoded surround channel. This will appear for Dolby Digital bitstreams that have matrix encoding.
- A "0" indicates that there is no surround channel information. This will be displayed for two-channel stereo programs.

The last number indicates whether there is a discrete low-frequency effects (LFE) channel. This is the ".1" in the common abbreviation of "5.1" sound and it is a special channel that contains only bass frequencies.

- A ".1" tells you that an LFE channel is present. This will be displayed for Dolby Digital 5.1 and DTS 5.1 programs, as available.
- A "0" indicates that there is no LFE channel information available. However, even when there is no dedicated LFE channel, low-frequency sound will be present at the subwoofer output when the speaker configuration is set to show the presence of a subwoofer.
- The information in the right side of the display will tell you if the digital audio data contains a special flag signal that will automatically activate the appropriate 6.1 or 7.1 mode. This will be shown as EX-ON or EX-OFF for Dolby Digital bitstreams and ES-ON or ES-OFF for DTS bitstreams.

When Dolby Digital 3/2/1 or DTS or DTS-ES signals are being played, the DPR will automatically switch to the proper surround mode, and no other processing may be selected. When a Dolby Digital signal with a 3/1/0 or 2/0/0 signal is detected, you may select any of the Dolby surround modes.

It is always a good idea to check the channel data to make certain that it matches the audio logo information shown on the back of a DVD package. In some cases, you will see an indication for "2/0/0" even when the disc contains a full 5.1, or 3/2/1, signal. When this happens, check the audio output settings for your DVD player or the audio menu selections for the specific disc being played to be sure that the player is sending the correct signal to the DPR.

An **UNLOCK** message may appear in the **Lower Display Line** **17**. This is your indication that the digital audio data stream has been interrupted or is no longer present. When that occurs, the unit's digital signal processor has no signal to lock onto, and is thus "unlocked." You may see this message when a DVD is first started until the stream is playing and the processor determines which mode to apply; or any time the data stream is stopped or paused, such as when the menus of some discs are displayed or when the player is switching between the different sections of a disc. You may also see the message when a satellite receiver, cable set-top or HDTV tuner is in use if the digital audio is temporarily interrupted when channels are changed or when a cable box switches from a channel with a digital data stream to a channel with analog audio only. The **UNLOCK** message is normal, and does not indicate any problem with your receiver. Rather, it tells you that the incoming data has simply been paused or is not present for a variety of possible reasons.

PCM Playback

PCM is the abbreviation for Pulse Code Modulation, which is the type of digital signal used for standard CD playback, and other non-Dolby Digital and non-DTS digital sources such as Mini-Disc. When a PCM signal is detected, the **Lower Display Line** **17** will briefly show a message with the letters PCM, in addition to a readout of the sampling frequency of the digital signal.

In most cases, this will be **PCM 44.1kHz** or **PCM 48kHz**, though in the case of specially mastered, high-resolution audio discs, you will see a **PCM 96kHz** indication. Note that the sampling rate displayed is that of the incoming digital signal, and not the upsampled rate that may be applied to PCM sources when Dolby Pro Logic, Pro Logic II or Pro Logic IIx processing is applied, as shown on page 22.

During PCM playback you may select any surround mode except one of the Dolby Digital or DTS/DTS-ES modes. However, when a CD with HDCD encoding is being played you must select the Surround Off (stereo) mode to take advantage of the HDCD process.

HDCD Playback

High Definition Compatible Digital,[®] or HDCD, discs are recorded using a 20-bit encoding and other proprietary processing for the ultimate in CD listening. When

OPERATION

an HDCD-encoded disc is playing and the CD player is connected using a digital connection, the DPR 2005 will automatically recognize the HDCD encoding and activate the circuits required for proper playback, provided that the Surround Off mode is selected. An HDCD message will appear in the **Lower Display Line 17** to confirm the HDCD playback. HDCD playback is limited to two-channel stereo only.

Speaker/Channel Indicators

In addition to the bitstream indicators, the AVR 7300 features channel-input indicators that show how many channels of digital information are being received and/or whether the digital signal is interrupted (see Figure 15).

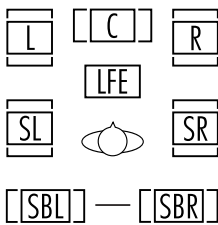

Figure 15

These indicators are the L/C/R/LFE/SL/SR/SBL/SBR letters that are inside the center boxes of the **Speaker/Channel Input Indicators 15** on the front-panel. When a standard analog signal is in use, only the "L" and "R" indicators will light, as analog signals have only left and right channels.

Digital signals, may have two, five, six or seven channels; depending on the program material, its method of transmission and the way in which it was encoded. When a digital signal is playing, the letters in these indicators will light in response to the signal being received. It is important to note that although Dolby Digital, for example, is referred to as a "5.1" system, not all Dolby Digital DVDs or programs are encoded for 5.1. Thus, it is sometimes normal for a DVD with a Dolby Digital soundtrack to trigger only the "L" and "R" indicators.

NOTE: Many DVD discs are recorded with both "5.1" and "2.0," and Dolby Digital and DTS versions of the same soundtrack. When playing a DVD, always be certain to check the type of material on the disc. Most discs show this information using icons on the back of the disc jacket. When a disc offers multiple soundtrack choices, you may have to make some adjustments to your DVD player (usually with the "Audio Select" button or in a menu screen on the disc) to send a full 5.1 feed to the AVR 7300 or to select between Dolby Digital or DTS. It is also possible for the type of signal feed to change during the course of a DVD's playback. In some cases, the previews or special material will be recorded in 2.0 audio, while the main feature is

available in 5.1 audio. The AVR 7300 will automatically sense changes to the bitstream and channel count and reflect them in these indicators.

The letters used by the **Speaker/Channel Input Indicators 15** also flash to indicate when a bitstream has been interrupted. This will happen when a digital input source is selected before the playback starts, or when a digital source such as a DVD is paused. The flashing indicators, along with the **UNLOCK** message in the **Lower Display Line 17**, remind you that the playback has stopped due to the absence of a digital signal and not through any fault of the DPR 2005. This is normal, and the digital playback will resume once the playback is started again.

Night Mode

A special feature of Dolby Digital is the Night mode, which enables specially encoded Dolby Digital input sources to be played back with full digital intelligibility while reducing the minimum peak level by 1/4 to 1/3. This prevents abruptly loud transitions from disturbing others, without reducing the impact of the digital source. The Night mode is available only when Dolby Digital signals with special data are being played.

The Night mode may be engaged when a Dolby Digital DVD is playing by pressing the **Night Mode Button 30** on the remote. Next, press the **▲/▼ Navigation Button 15** to select either the middle range or full compression versions of the Night mode. To turn the Night mode off, press the **▲/▼ Navigation Button 15** until the message in the lower third of the video display and in the **Lower Display Line 17** reads **D - RANGE OFF**.

The Night mode may also be selected to always be on at either level of compression using the options in the **DOLBY SURR** menu. See page 23 for information on using the menus to set this option.

MP3 Audio Playback

The AVR 7300 is one of the few receivers equipped for onboard decoding for the MP3 audio format used by computers and portable audio devices. By offering MP3 decoding, the AVR 7300 is able to deliver precise conversion of the digital signals to an analog output, along with the benefits of listening to the MP3 audio through the DPR 2005's high-power amplifier and the speakers from your surround system, rather than the smaller speakers and low-powered amplifiers typically used with computers.

To take advantage of the DPR 2005's MP3 capabilities, simply connect the S/P-DIF output of a computer's sound card or the S/P-DIF output of a portable digital audio device to either the rear panel **Digital Inputs 16/17** or the front-panel **Digital Inputs 16/17**. When the digital signal is available, the **Lower**

Display Line 17 will indicate that an MP3 bitstream is present, and the audio will begin playing.

NOTES:

- The AVR 7300 is only capable of playing signals in the MP3 (MPEG 1/Layer 3) format. It is not compatible with other computer audio codecs.
- The digital audio input signal may be either optical or coaxial, but the signal must be in the S/P-DIF format. Direct connection of USB or serial data outputs is not possible, even though the signals are in the MP3 format. If you have any questions about the data output format from your computer or a sound card, check with the device's owner's manual.
- If your computer or sound card's digital output is not capable of direct connection to the AVR 7300, you may use an optional, external transcoder to convert the USB output of a computer to a format compatible with the DPR.
- Due to the wide variation in MP3 formats and encoding speeds, it is possible that the AVR 7300 may not be compatible with all MP3 input signals. Some may produce unacceptable results or may not be decoded. This is not a fault of either the computer or the AVR 7300, but rather a by-product of the unpredictable nature of MP3 playback.
- Even when your computer does not have a digital output that is compatible with the AVR 7300, you may connect the analog audio output available on virtually all computers to one of the DPR's analog audio inputs using an optional adaptor cable that converts the stereo mini plug commonly used for computer audio connections to the left/right RCA jacks used on the DPR. Connecting your computer to the DPR will enable you to take advantage of the high-quality audio reproduction possible with a home theater system, as well as enable the use of surround processing modes such as Logic 7, to greatly enhance downloaded or streaming audio playback.

IMPORTANT NOTES ON DIGITAL PLAYBACK:

- When the digital playback source is stopped, or in a pause, fast forward or search mode, digital audio data will momentarily stop, and the channel position letters inside the **Speaker/Channel Input Indicators 15** will flash and an **UNLOCK** message may appear. This is normal and does not indicate a problem with either the AVR 7300 or the source machine. The AVR 7300 will return to digital playback as soon as the data is available.

- Some source devices, particularly cable set-top boxes, will switch back and forth between digital and analog audio outputs, depending on the channel being watched. To avoid losing sound with this type of product, it is recommended that you connect both the digital and analog audio outputs of the source to the DPR 2005, with the digital audio input set as the default following the steps shown on page 21. The DPR will monitor the digital data stream and when it is interrupted the sound will mute briefly and possibly display an **UNLOCK** message while it switches to the analog audio input. This switching is not a fault of either the DPR or the cable box, as it is caused by the use of different audio technologies on different channels by the cable company or program supplier.
- Although the AVR 7300 will decode virtually all current DVD movies, CDs and HDTV sources, it may not be compatible with future digital sources.
- When a digital source is playing, you may not be able to select some of the analog surround modes such as Dolby Pro Logic II, Dolby Pro Logic IIx, Hall, Theater or Logic 7.
- When a Dolby Digital or DTS source is playing, it is not possible to make an analog recording using the **Tape Outputs 11** and **Video 1 or Video 2 Audio Outputs 35**. However, the digital signals will be passed through to the **Digital Audio Outputs 1819J**.

Tuner Operation

The AVR 7300's tuner is capable of tuning AM, FM and FM Stereo broadcast stations. Stations may be tuned manually, or they may be stored as favorite station presets and recalled from a 30-position memory.

Station Selection

1. Press the **AM/FM Button 34** on the remote to select the tuner as an input. The tuner may be selected from the front panel by either pressing the **Input Source Selector 8** until the tuner is active or by pressing the **Tuner Band Selector 6**.
2. Press the **AM/FM Button 34** or **Tuner Band Selector 6** again to switch between AM and FM so that the desired frequency band is selected.
3. Press the **Tuning Mode Selector 9 12** to select manual or automatic tuning.

When the button is pressed so that **AUTO** or **AUTO / STEREO** appears in the **Upper Display Line 16**, each press of the **Tuning Selectors 523** will put the tuner in a scan mode that seeks the next higher or lower frequency

station with acceptable signal strength. An **AUTO ST TUNED** indication will momentarily appear when the station stops at a stereo FM station, and an **AUTO TUNED** indication will momentarily appear when an AM or monaural FM station is tuned. Press the Tuning buttons again to scan to the next station.

When the button is pressed so that **MANUAL** or **MANUAL / MONO** appears in the **Upper Display Line 16**, each tap of the **Tuning Selectors 523** will increase or decrease the frequency by one increment. When the tuner receives a strong enough signal for adequate reception, **MANUAL TUNED** will appear in the **Lower Display Line 17**.

4. Stations may also be tuned directly in either the automatic or manual mode. To enter a station's frequency directly, first select the AM or FM band as desired by pressing the **AM/FM Button 6 34**. Next, press the **Direct Button 9**. Within five seconds of when **DIRECT IN** scrolls in the **Upper Display Line 16**, enter the station frequency by pressing the **Numeric Keys 11**. If you press an incorrect button while entering a direct frequency, press the **Clear Button 10** to start over.

NOTE: When the FM reception of a station is weak, audio quality will be increased by switching to Mono mode by pressing the **Tuning Mode Button 9 12** so that **MANUAL / MONO** appears momentarily in the **Upper Display Line 16** and then goes out. This will also activate manual tuning mode.

Preset Tuning

Using the remote, up to 30 stations may be stored in the AVR 7300's memory for easy recall using the front-panel controls or the remote.

To enter a station into the memory, first tune the station using the steps outlined above. Then:

1. Press the **Memory Button 39** on the remote; the station's frequency will flash.
2. Within five seconds, press the **Numeric Keys 11** corresponding to the memory location where you wish to store this station's frequency. Once entered, the preset number will appear in the **Upper Display Line 16**.
3. Repeat the process after tuning any additional stations to be preset.

Recalling Preset Stations

- To manually select a station previously entered in the preset memory, press the **Numeric Keys 11** for the desired station's memory location.

- To manually scroll through the list of preset stations, press the **Preset Stations Selector Button 7 22** on the front panel or remote.

Tape Recording

In normal operation, the audio or video source selected for listening through the AVR 7300 is sent to the record outputs. This means that any program you are watching or listening to may be recorded simply by placing machines connected to the outputs for **Tape Outputs 11** or **Video 1/Video 2 Outputs 35** in the record mode.

When a digital audio recorder is connected to the **Digital Audio Outputs 1819J**, you are able to record the digital signal using a CD-R, MiniDisc or other digital recording system.

NOTES:

- The digital outputs are active only when a digital signal is present, and they do not convert an analog input to a digital signal, or change the format of the digital signal. In addition, the digital recorder must be compatible with the output signal. For example, the PCM digital input from a CD player may be recorded on a CD-R or MiniDisc, but Dolby Digital or DTS signals may not.
- The **Front-Panel Video 5 K** and **Coaxial 3 J** jacks may be configured for use as an output, allowing connection to a recorder, when the steps shown in the section below are followed.
- Please obey the copyright restrictions on any material you copy. Unauthorized duplication of copyrighted materials is prohibited by law.

Front-Panel Connections

In addition to the rear-panel digital and analog outputs, the AVR 7300 offers Harman Kardon's exclusive configurable front-panel output-jack feature. For easy connection of portable devices, you may switch the front-panel **Video 5 Jacks K** or the **Coaxial Digital 3 Jack J** from an input to an output by following these steps:

1. Press the **OSD Button 31** to view the **MASTER MENU** (Figure 1).
2. Press the **Set Button 17** to enter the **IN/OUT SETUP** menu (Figure 2).
3. Press the **Navigation Button 15** so that the on-screen **→** cursor is next to **VIDEO 5** or **COAXIAL 3**, depending on which jack you wish to switch to an output.

OPERATION

4. Press the **Set Button** **17** and then press the **◀/▶ Navigation Button** **15** so that the word **OUT** is highlighted.
5. Press the **Set Button** **17** to enter the change.
6. Press the **OSD Button** **31** to exit the menus and return to normal operation.

Once the setting is made, the **Input/Output Status Indicator** **1** will turn red, indicating that the jacks are now an output, instead of in the default setting as an input. Once changed to an output, the setting will remain as long as the DPR 2005 is turned on, unless the setting is changed in the OSD menu system, as described above. However, once the DPR 2005 is turned off, the setting is cancelled. When the unit is turned on again, the front-panel jacks will return to their normal default setting as an input. If you wish to use the jacks as an output at a future time, the setting must be changed again using the OSD menu system, as described above.

Output Level Trim Adjustment

Normal output level adjustment for the AVR 7300 is established using the test tone, as outlined on pages 27 – 29. In some cases, however, it may be desirable to adjust the output levels using program material such as a test disc, or a selection you are familiar with. Additionally, the output level for the subwoofer can only be adjusted using this procedure.

To adjust the output levels using program material, first set the reference volume for the front left and front right channels using the **Volume Control** **13 18 1**.

If you are using a disc with test signals or an external signal generator as the source used when the output levels are being trimmed, you may use the remote as an SPL meter to guide you to the correct level settings. To use the EzSet remote as an SPL meter, follow the instructions on page 29.

Once the reference level has been set, press the **Channel Select Button** **14** and **FRONT LEVEL** will appear in the **Lower Display Line** **17**. To change the level, first press the **Set Button** **17**, and then use the **▲/▼ Navigation Button** **15** to raise or lower the level. DO NOT use the volume control, as this will alter the reference setting.

Once the change has been made, press the **Set Button** **17** and then press the **▲/▼ Navigation Button** **15** to select the next output-channel location that you wish to adjust. To adjust the subwoofer level, press the **▲/▼ Navigation Button** **15** until **SUBWOOFER LEVEL** appears in the **Lower Display Line** **17** or on-screen display.

Repeat the procedure as needed until all channels requiring adjustment have been set. When all adjustments have been made and no further adjustments are made for five seconds, the AVR 7300 will return to normal operation.

The channel output for any input may also be adjusted using the full-OSD on-screen menu system. First, set the volume to a comfortable listening level using the **Volume Control** **13 18 1**. Then, press the **OSD Button** **31** to bring up the **MASTER MENU** (Fig. 1). Press the **▼ Navigation Button** **15** until the on-screen **→** cursor is next to the **CHANNEL ADJUST** line. Press the **Set Button** **17** to activate the **CHANNEL ADJUST** menu (Fig. 13).

Once the menu appears on your video screen, first use the **▲/▼ Navigation Button** **15** to move the on-screen **→** cursor so that it is next to the **TEST TONE** line. Press the **◀/▶ Navigation Button** **15** so that **OFF** is highlighted. This will turn off the test tone and allow you to use your external test disc or other source material as the reference. Then, use the **▲/▼ Navigation Button** **15** to select the channels to be adjusted. At each channel position, use the **◀/▶ Navigation Button** **15** to change the output level. Remember, the goal is to have the output level at each channel be equal when heard at the listening position.

If you wish to reset all the levels to their original factory default of 0dB offset, press the **▲/▼ Navigation Button** **15** so that the on-screen cursor is next to the **CHANNEL RESET** line and press the **◀/▶ Navigation Button** **15** so that the word **ON** is highlighted. After the levels are reset, resume the procedure outlined above to reset the levels to the desired settings. When all adjustments are done, press the **▲/▼ Navigation Button** **15** to move the on-screen **→** cursor so that it is next to **BACK TO MASTER MENU** and then press the **Set Button** **17** if you wish to go back to the main menu to make other adjustments. If you have no other adjustments to make, press the **OSD Button** **31** to exit the menu system.

NOTE: Output levels may be separately trimmed for each surround mode. If you wish to have different trim levels for a specific mode, select that mode and then follow the instructions shown above.

Dim Function

Since the AVR 7300 will often be used when movies or other video programming is viewed under low-light conditions, you may wish to lower the brightness of the front-panel displays and indicators so that they do not distract from the video presentation. You may dim the displays using the menu system, as shown on

page 37, or you may control the brightness directly from the remote.

Simply press the **Dim Button** **13** once to dim the front panel to half the normal brightness level; press it again to turn the displays off. Note that when the displays are dimmed or turned off, the **Standby/On Indicator** **1** will remain lit as a reminder that the DPR is still turned on.

Note that all changes to the front-panel brightness level remain in effect only until the DPR is turned off; the displays will return to full brightness after the DPR is turned on again. To return the displays to full brightness without turning the unit off, press the **Dim Button** **13** as needed until the displays are on.

In addition to lowering the brightness of the displays or turning them off completely, you may wish to have them appear whenever a button on the remote or front panel is pushed, and then gradually fade out after a set time period. You may do this by making the appropriate settings in the **VFD FADE TIME OUT** line of the **ADVANCED SELECT Menu** (Figure 16), as shown on page 37.

Memory Backup

This product is equipped with a memory backup system that preserves the system configuration information and tuner presets if the unit is accidentally unplugged or subjected to a power outage. This memory will last for at least four weeks, after which time all information must be reentered.

The AVR 7300 is equipped with a number of advanced features that add extra flexibility to the unit's operation. While it is not necessary to use these features to operate the unit, they provide additional options that you may wish to use.

Front-Panel Display Fade

In normal operation, the front-panel displays and indicators remain on at full brightness, although you may also dim them or turn them off as shown on page 36. As an additional option, you may also set the DPR so that the displays are on whenever a button is pressed on the front panel or remote, but then fade out after a set period of time.

To set the front-panel displays to the Fade mode, press the **OSD Button 31** to bring the Master Menu to the screen. Press the **▲/▼ Navigation Button 15** so that the **→** cursor is pointed to the **ADVANCED** line, and press the **Set Button 17** to enter the **ADVANCED SELECT** menu (Figure 16).

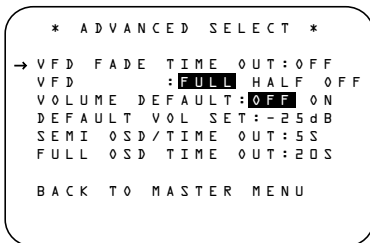

Figure 16

With the **ADVANCED SELECT** menu on your video display, press the **▲/▼ Navigation Button 15** so that the **→** cursor is pointed to the **VFD FADE TIME OUT** line. Next, press the **◀/▶ Navigation Button 15** so that the amount of time that you wish the displays to fade out after a button is pressed is shown.

Once this time is set and the unit returned to normal operation, the displays will remain on for the time period selected whenever a button is pressed on the front panel or remote. After that time, they will gradually fade out, with the exception of the **Standby/On Indicator 1**, which remains on to remind you that the DPR is turned on.

If you wish to make adjustments to other items on the **ADVANCED SELECT** menu, press the **▲/▼ Navigation Button 15** to place the **→** cursor next to the desired item, or place the **→** cursor next to the **BACK TO MASTER MENU** line and press the **Set Button 17** to make an adjustment to another menu. If you have completed all adjustments, press the **OSD Button 31** to exit the menu system.

Display Brightness

The AVR 7300's front-panel displays and indicators are set at a default brightness level that is sufficient for viewing in a normally lit room. However, you may wish to occasionally lower the brightness of the display, or turn it off completely.

To change the display brightness setting for a specific listening session, use the Dim function as shown on page 36 in the Operation Section of this manual, or make an adjustment in the **ADVANCED SELECT** menu. To start the adjustment, press the **OSD Button 31** to bring the **MASTER MENU** to the screen. Press the **▼ Navigation Button 15**, until the on-screen **→** cursor is next to the **ADVANCED** line. Press the **Set Button 17** to enter the **ADVANCED SELECT** menu (Figure 16).

To change the brightness setting, at the **ADVANCED SELECT** menu, make certain that the on-screen **→** cursor is next to the **VFD** line, and press the **▶ Navigation Button 15** until the desired brightness level is highlighted in the video display. When **FULL** is highlighted, the display is at its normal brightness. When **HALF** is highlighted, the display is at half the normal brightness level, but the blue lighting inside the **Volume Control 13** will go out. When **OFF** is highlighted, all of the front-panel indicators will go dark.

Once the desired brightness level is selected, it will remain in effect until it is changed again or until the unit is turned off.

If you wish to make other adjustments, press the **▲/▼ Navigation Button 15** until the on-screen **→** cursor is next to the desired setting or the **BACK TO MASTER MENU** line and press the **Set Button 17**. If you have no other adjustments to make, press the **OSD Button 31** to exit the menu system.

Turn-On Volume Level

As is the case with most audio/video receivers, when the AVR 7300 is turned on, it will always return to the volume setting in effect when the unit was turned off. However, you may prefer to always have the DPR 2005 turn on at a specific setting, regardless of what was last in use when the unit was turned off. To change the default condition so that the same volume level is always used at turn-on, you will need to make an adjustment in the **ADVANCED SELECT** menu. To start the adjustment, press the **OSD Button 31** to bring the **MASTER MENU** (Figure 1) to the screen. Press the **▼ Navigation Button 15**, until the on-screen **→** cursor is next to the **ADVANCED** line. Press the **Set Button 17** to enter the **ADVANCED SELECT** menu (Fig. 16).

At the **ADVANCED SELECT** menu, make certain that the on-screen **→** cursor is next to the **VOLUME DEFAULT** line by pressing the **▲/▼ Navigation Button 15** as needed. Next, press the **▶ Navigation Button 15** so that the word **ON** is highlighted in the video display. Next, press the **▼ Navigation Button 15** once so that the on-screen **→** cursor is next to the **DEFAULT VOL SET** line. To set the desired turn-on volume, press the **◀/▶ Navigation Button 15** until the desired volume level is shown on the **DEFAULT VOL SET** line. This setting may NOT be made with the regular volume controls.

NOTE: Since the setting for the turn-on volume cannot be heard while the setting is being made, you may wish to determine the setting before making the adjustment. To do this, listen to any source and adjust the volume to the desired level using the regular **Volume Controls 13 18 1**. When the desired volume level to be used at turn-on is reached, make a note of the setting as it appears in the lower third of the video screen or in the **Lower Display Line 17**. (A typical volume level will appear as a negative number such as -25dB .) When making the adjustment, use the **◀/▶ Navigation Button 15** to enter this setting.

Unlike some of the other adjustments in this menu, the turn-on volume default will remain in effect until it is changed or turned off in this menu, even when the unit is turned off.

If you wish to make other adjustments, press the **▲/▼ Navigation Button 15** until the on-screen **→** cursor is next to the desired setting or the **BACK TO MASTER MENU** line, and press the **Set Button 17**. If you have no other adjustments to make, press the **OSD Button 31** to exit the menu system.

Semi-OSD Settings

The semi-OSD system places one-line messages at the lower third of the video display screen whenever the Volume, Input Source, Surround mode, tuner frequency or any of the configuration settings is changed. The semi-OSD system is helpful in that it enables you to have feedback on any control changes or remote commands using the video display when it is difficult to view the front-panel displays. However, you may also prefer to turn these displays off permanently. You may also want to adjust the length of time the displays remain on the screen. Both of those options are possible with the AVR 7300.

ADVANCED FEATURES

To adjust the on-screen appearance of the semi-OSD system, press the **OSD Button 31** to bring the **MASTER MENU** to the screen. Press the **▼ Navigation Button 15**, until the on-screen **→** cursor is next to the **ADVANCED** line. Press the **Set Button 17** to enter the **ADVANCED SELECT** menu.

When the **ADVANCED SELECT** menu appears, press the **▲/▼ Navigation Button 15** so that the on-screen **→** cursor is pointing to the **SEMI OSD/TIME OUT** line. Select one of these options:

- To keep the semi-OSD system activated, but to adjust the length of time the displays remain on the screen, press the **◀/▶ Navigation Button 15** until the desired time-out is shown. The default setting is 5 seconds.
- To turn the semi-OSD system off so that it does not appear at any time, press the **◀/▶ Navigation Button 15** so that **OFF** is shown on the right side of the line.

If you wish to make other adjustments, press the **▲/▼ Navigation Button 15** until the on-screen **→** cursor is next to the desired setting or the **BACK TO MASTER MENU** line and press the **Set Button 17**. If you have no other adjustments to make, press the **OSD Button 31** to exit the menu system.

Full-OSD Time-Out Adjustment

The **FULL OSD** menu system is used to simplify the setup and adjustment of the DPR 2005 by using a series of on-screen menus. The factory default setting for these menus leaves them on the screen for 20 seconds after a period of inactivity before they disappear from the screen (Time-Out). Time-Out is a safety measure to prevent image retention of the menu text in your monitor or projector, which might happen if it were left on indefinitely. However, some viewers may prefer a slightly longer or shorter period before the on-screen display disappears.

To change the full-OSD Time-Out, you will need to make an adjustment in the **ADVANCED SELECT** menu (Figure 16). To start the adjustment, press the **OSD Button 31** to bring the **MASTER MENU** to the screen. Press the **▼**

Navigation Button 15, until the on-screen **→** cursor is next to the **ADVANCED** line. Press the **Set Button 17** to enter the **ADVANCED SELECT** menu (Figure 16).

At the **ADVANCED SELECT** menu (Fig. 16) make certain that the on-screen **→** cursor is next to the **FULL OSD TIME OUT** line by pressing the **▲/▼ Navigation Button 15** as needed. Next, press the **◀/▶ Navigation Button 15** until the desired time is displayed in seconds. Unlike most of the other options in this menu, this is a permanent setting change, and the Time-Out entry will remain in effect until it is changed, even if the unit is turned off.

If you wish to make other adjustments, press the **▲/▼ Navigation Button 15** until the on-screen **→** cursor is next to the desired setting or the **BACK TO MASTER MENU** line and press the **Set Button 17**. If you have no other adjustments to make, press the **OSD Button 31** to exit the menu system.

The AVR 7300 is fully equipped to operate as the control center for a complete multiroom system that is capable of sending one source to a second zone in the house while a separate source is listened to in the main room. In addition to providing for control over the selection of the remote source and its volume, the AVR 7300 offers a comprehensive range of options for powering the speakers in the second zone.

- Using the line-level **Multiroom Audio Outputs 9**, the selected source may be fed to optional, external power amplifiers that may be matched to the specifics of the installation.
- When the main room system is configured for 5.1 operation, the Surround Back Left/Right amplifier channels may be used to power the remote zone so that no additional amplifiers are required.
- Using built-in A-BUS Ready technology, optional A-BUS modules may be connected to the DPR 2005 via a single Category 5/5e or higher wire, so that remote zone speakers may be powered directly from the A-BUS module without the need for additional power, IR sensor or volume control wires to be run to the second zone.

In addition, the AVR 7300 includes a remote IR sensor input so that remote control commands from the Zone II remote included with the unit may be transmitted to the unit, while standard IR input/output jacks allow the remote zone's commands to be sent to compatible IR-controlled source devices.

Installation

Although simple remote room systems may be installed by the average do-it-yourself hobbyist, the complexity of many multizone/multiroom systems involves running wires inside walls where the services of a specially trained installer may be required. Regardless of who does the work, please remember that local building codes govern in-wall electrical work, including proper specification of any wiring used and the way in which it is connected. You are responsible for making certain that all multiroom installation work is done properly and in compliance with all applicable codes and regulations.

For installations using optional, external amplifiers in Option 1 or Option 2, follow the instructions shown on page 17.

For installations where the Surround Back Left/Right amplifier channels are used to power the remote zone, make certain that the system is installed and configured for that type of operation, as shown. In Option 3 on page 17 and in the **MULTI-ROOM SETUP** menu as shown on this page.

For installations where A-BUS modules are used, follow the instructions provided with the A-BUS remote modules or keypads.

RS-232 Control

The AVR 7300 is rare among A/V receivers in that it provides the capability for full bidirectional remote control with confirmation control acknowledgement from compatible computers or specialized remote control systems. RS-232 programming requires specialized programming knowledge and for that reason we recommend that it only be done by qualified installers. For more information on using the RS-232 port for remote control, visit the Harman Kardon Web site at www.harmankardon.com or contact a custom installer trained in RS-232 controlled systems.

Multiroom Setup

Once the audio and IR link connections have been made, the AVR 7300 needs to be configured for multiroom operation. Press the **OSD Button 31** to bring the **MASTER MENU** (Figure 1) to the screen. Press the **Navigation Button 15**, until the on-screen **→** cursor is next to the **MULTI-ROOM** line. Press the **Set Button 17** to enter the **MULTI-ROOM SETUP** menu (Figure 17).



Figure 17

When the **MULTI-ROOM SETUP** menu appears, the on-screen **→** cursor will be at the **MULTI-ROOM** line. Since this line is used to turn the system on and off, don't make an adjustment here unless you wish to turn the system on at this time. To turn the system on, press the **Navigation Button 15** so that **ON** is highlighted. If you do not wish to turn the system on at this time or to proceed to the next step, press the **Navigation Button 15** once so that the **→** on-screen cursor is next to the **MULTI IN** line.

At the **MULTI IN** line, press the **Navigation Button 15** until the desired input to the multiroom system appears in the highlighted video.

In addition to the standard inputs, a choice is available labeled **MAIN DOWNMIX**. In all other cases, the feed to the multiroom system may be different from the input selected for the main room, but the

input must be analog. When **MAIN DOWNMIX** is selected as the multiroom system input you may listen to an "Lt/Rt" stereo version of any digital source playing in the main room, such as Dolby Digital or DTS. You may also use this mode to listen to a source connected to the **8-Channel Direct Inputs 15** in the remote zone, as long as the Dolby Pro Logic IIx mode is activated. Note, however, that when **MAIN DOWNMIX** is selected as the input for the multiroom system, the source sent to the remote room will change any time the main room input is changed.

When the selection has been made, press the **Navigation Button 15** once so that the **→** on-screen cursor is next to the **MULTI VOL** line.

At the **MULTI VOL** line, press the **Navigation Button 15** until the desired volume level for the multiroom system is entered. DO NOT use the regular volume control knobs for this setting. When all settings for the multiroom setup have been made, press the **Navigation Button 15** until the on-screen **→** cursor is next to the **BACK TO MASTER MENU** line.

However, if you have connected both the digital and analog outputs of a source such as a DVD player to the DPR, you may select that source for the remote room. The DPR will automatically switch to the analog connection for playback in the remote room without affecting multichannel playback from the digital link in the main room.

Surround Amplifier Channel Assignment

The AVR 7300 is equipped with seven full-power amplifier channels to allow for complete 7.1-channel operation without the need for additional external amplifiers. However, in some installations you may wish to use the traditional 5.1-channel configuration for the main listening room, which allows the surround back left/right amplifier channels to be used to power speakers placed in a remote zone location.

If you wish to use the Surround Back amplifier channels to power the remote zone, press the **Navigation Button 15** until the **→** cursor is pointing to the **SB AMPS** line on the **MULTI-ROOM SETUP** menu. Press the **Navigation Button 15** until **MULTI** is highlighted in reverse video and press the **Set Button 17**.

Remember that once this setting is made, you will not be able to take advantage of any of the 6.1/7.1-channel decoding or processing modes, and that the speakers used for the remote zone must be connected to the **Surround Back/Multiroom Speaker Outputs 26**. The volume for these speakers is set by the multiroom system, as explained on this page.

MULTIROOM OPERATION

Once this setting is made, you may press the ▲/▼ **Navigation Button 15** to make any of the other adjustments available on this menu. If no other adjustments are needed, press the **OSD Button 31** to exit the menu system.

Multiroom Operation

When operating the DPR 2005 from a remote room location where an IR sensor link has been connected to the DPR 2005's rear-panel **Multiroom IR Input 31**, you may use either the main remote control or the Zone II remote. To turn on the multiroom feed, press the **AVR Selector 5 B** to turn the unit on to the last source, or any of the other **Selector Buttons C D 4 34 44** to turn on to a specific source.

As long as an IR feed to the DPR 2005 has been established from the remote room, using any of the buttons on either remote will control the remote location volume **18 I**, change the tuner frequency **23 E**, change the tuner preset **22 G** or mute the output **33 ●**.

If the **Remote IR Output Jack 35** on the DPR 2005 is connected to an IR Input jack on compatible Harman Kardon audio components such as CD, DVD or cassette players, the transport functions of those machines may also be controlled using the **Transport Controls 20 21 F G H J** on either remote control.

To turn the system off from the remote room, press the **Power Off Button 1 A**. Remember that the DPR 2005 may be turned on or off from the remote room, regardless of the system's operation or status in the main room.

NOTE: When the tuner is selected as the source for the remote zone, any change to the frequency or preset will also change the station being listened to in the main room, if the tuner is in use there. Similarly, if someone in the main room changes the station, the change will also have an impact on the remote room.

To turn on the Multiroom system from the main listening room, press the **Multiroom Button 27** on the remote. When the **MULTI ON/OFF** message appears in the on-screen display and the **Lower Display Line 17**, press the **Set Button 17** and then press the ▲/▼ **Navigation Button 15** so that display changes to **MULTI ON**. Press the **Set Button 17** again to activate the setting. Note

that this method may be used to turn the Multiroom system on or off even when the DPR is in the Standby mode in the main listening room.

When the Multiroom system is turned on, the input selected using the Multiroom menu will be fed to the **Multiroom Audio Outputs 9** on the rear panel as well as the **A-BUS Connector 34**. The volume will be as set in the previous selection, although it may also be adjusted using an optional IR sensor and the Zone II remote in the remote location, or the A-BUS keypad, or on the optional audio power amplifier connected to the **Multiroom Audio Outputs 9**.

Although changes to the input source or remote room volume will normally be made using an IR sensor in the remote room that is connected to the DPR, it is also possible to change those settings from the main listening room. This is useful for situations where some or all of the remote rooms do not have an IR sensor, or to take control over the remote room without actually being in that room.

In addition to using the **MULTI-ROOM SETUP** menu, as shown on the previous page, you may change the source or volume in the remote zone using the remote. Press the **Multiroom Button 27** on the remote, and when the **MULTI ON/OFF** message appears in the on-screen display and the **Lower Display Line 17**, press the **Set Button 17** and then press the ▲/▼ **Navigation Button 15** to toggle past that message to **MULTI LEVEL** or **MULTI INPUT**.

To change the remote room's input source, when **MULTI INPUT** appears, press the **Set Button 17**, and then press the ▲/▼ **Navigation Button 15** until the desired input appears in the on-screen display and in the **Lower Display Line 17**.

To change the remote room's volume, when **MULTI LEVEL** appears, press the **Set Button 17**, and press the ▲/▼ **Navigation Button 15** to change the volume setting. Note that this volume adjustment controls the level for the output to the **Multiroom Audio Outputs 9** and for any speakers connected to the **Surround Back/Multiroom Speaker Outputs 26** when the Surround Back amplifier channels are configured for Multiroom use, as shown on page 39. This adjustment does NOT change the volume level for any room where an A-BUS module is used, as that setting is only

adjustable using the A-BUS module's volume control or built-in IR sensor.

Once the Multiroom system is turned on, it will remain on even if the AVR 7300 is placed in the Standby mode in the main room by pressing the **Power Off Button A** or the **Main Power Switch A** on the front panel.

The Multiroom system will remain on even if the unit is turned off in the main room. In that event, although front-panel indicators and the accent lighting around the volume control will turn off, a **MULTI-ROOM ON** message will remain in the **Lower Display Line 17** to remind you that power is still applied to the unit, and that it is being used for Multiroom operation elsewhere in the house. Remember that if you turn the unit completely off by pressing the **Main Power Switch A**, the feed to the second zone will also be turned off.

When the DPR 2005 is turned off in the main room, the Multiroom system may be turned on at any time by pressing the **Multiroom Button 27**, or any of the **Selector Buttons B C D** in the remote room.

NOTES ON MULTIROOM OPERATION:

- The Zone II remote does not contain a button for the front-panel Video 5 input, but you may select that source for the Multiroom system using the **MULTI-ROOM SETUP** menu or an optional remote that has been programmed with the code for the Video 5 button from the DPR's main remote control.
- In addition to the Zone II remote supplied with your DPR, you may use the main remote control or any remote programmed with Harman Kardon codes. Note, however, that only the remote codes applicable to the remote room system or the operation of source devices will function. Buttons used to change other "Main Room" listening functions such as surround mode changes will not work with the multiroom system.

The AVR 7300 remote is factory-programmed for all functions needed to operate the unit. In addition, it is also preprogrammed to operate most recent Harman Kardon DVD players and changers, CD players and changers, CD recorders and cassette decks. The codes for other brand devices may be programmed into the AVR 7300 remote using its extensive library of remote codes or a head-to-head learning process for codes not in the internal library.

Programming Remote Codes

Thanks to the remote's advanced technology and two-line LCD display, it is no longer necessary to look up cumbersome codes when programming the remote; following the steps outlined below, you simply search for the brand name from the remote's memory. We recommend that you first try the preprogrammed code entry method. If that procedure is not successful, then try the code-learning method.

Preprogrammed Code Entry

The easiest way to program the remote for operation with a source device from another brand is to follow these steps:

1. Turn on the power to the device you wish to program into the DPR remote. This is important, as in a later step you will need to see whether the device turns off to determine whether the remote has been programmed for the proper remote codes.
2. Press and hold the **Program Button** **25** for about three seconds while the message shown in Figure 18 appears in the remote's **LCD Information Display** **3**. Release the button when the red light under the **Set Button** **17** appears.

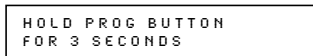

HOLD PROG BUTTON
FOR 3 SECONDS

Figure 18

3. The remote's **MAIN MENU** message (Figure 19), will appear in the LCD display and the **Set Button** **17** will remain illuminated in red. Press the **Set Button** **17** to begin the process of selecting a device and locating the proper remote codes.

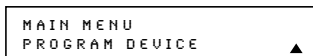

MAIN MENU
PROGRAM DEVICE

Figure 19

4. **SELECT A DEVICE** will appear in the LCD display (Figure 20). Press the **▲/▼ Navigation Button** **15** to scroll through the list of device categories and press the **Set Button** **17** when the device you wish to set the codes for appears. For this example, we will select "TV" to enter the codes needed to operate your TV.



SELECT A DEVICE
TV

Figure 20

NOTE: The codes for both stand-alone and satellite-based hard-drive recorder products (PVR) such as TiVo® and Replay TV® are found regardless of their brand by selecting VCR as the device.

5. At the next menu screen on the remote (Figure 21), press the **Set Button** **17** to enter the Manual mode, which means that you will select the brand name of the device from the list programmed into the remote's memory.

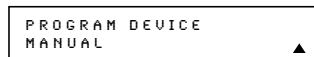

PROGRAM DEVICE
MANUAL

Figure 21

6. The next menu screen on the remote (Figure 22) will show the start of the list of available brands. Press the **▲/▼ Navigation Buttons** **15** until the brand name of the device you are programming into the remote appears on the lower line of the display and then press the **Set Button** **17**.



SELECT BRAND
RCA

Figure 22

NOTE: If the brand name for the product you wish to program does not appear in the list, the codes may still be available, as some manufacturers share codes. If the desired brand is not listed, press the **Clear Button** **10** to exit the programming process, and skip to the instructions shown on page 42 for the "Automatic" method of programming the remote. If desired, or if the codes for your brand are not part of the remote's library at all, you may still use the remote to program most infrared-controlled products by "learning" the commands from the product's original remote into the DPR remote. The instructions for Learning Commands are on page 42.

7. The next step is important, as it determines which codes will operate the source device or display. Point the DPR remote at the device being programmed and, following the instructions shown in the remote's **LCD Information Display** **3**, press and release the **Numeric Keys** **11** shown on the menu screen (Figure 23) one at a time, starting with the "1" button. After you press the "1" **Button** **11**, the remote's LCD screen will briefly go blank as the code is being transmitted, but you will see the "transmit" icon  in the upper right corner of the display to serve as confirmation that the remote is sending out commands.

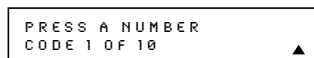

PRESS A NUMBER
CODE 1 OF 18

Figure 23

8. After you press and release the number key, watch the device being programmed to see whether it turns off. As shown in the instructions that will appear on the next menu screen (Figure 24), if your device has turned off, press the **Set Button** **17**, and then skip to Step 10. If the unit does *not* turn off, proceed to the next step.

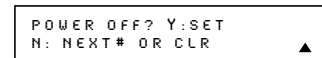

POWER OFF? Y:SET
N: NEXT# OR CLR

Figure 24

9. If the device being programmed into the DPR remote does *not* turn off after you have pressed the "1" **Button** **11**, repeat Steps 7 and 8 by pressing the available numeric keys shown until the device turns off. If the device still does not turn off after all choices have been tried, or if there is only one number key shown as available to try, the code for this specific device is not in the DPR remote library under that brand name. If that is the case, press the **Clear Button** **10** to exit the manual programming mode. Remember that the codes may still be stored in the DPR remote's library under another brand, and you can have the remote control search for them by following the instructions below for automatic programming. You may also manually "learn" the codes for most devices into the DPR remote by following the Learning Commands instructions on page 42.
10. When the device being programmed does turn off after a numeric key has been pressed, you must press the **Set Button** **17** within five seconds to enter the setting into the remote's memory. After you press the **Set Button** **17**, the top line of the LCD display will read **SAVING...** and then the word **SAVED** will flash four times in the center of the bottom line.
11. When the codes are saved, the remote will return to normal operation, and whenever you press the **Input Selector Button** **4** that was just programmed, the codes for the new device will be used.

NOTE: Some brands share a common remote control code for "Power Off" for many models. For that reason it is possible that even though the remote appears to be properly programmed, you may find that some buttons do not appear to issue the correct command. If this is the case, repeat the procedure outlined above, but if more than one numeric key selection is suggested in Step 7, try a different number to see whether the remote operates correctly. Although the DPR remote is preprogrammed with an extensive library of codes for many major brands, it is also possible that you may have attempted to program a product that is too new or too old, and thus not all of its commands will be in the code library. You may fill in the codes for any button

CONFIGURING THE REMOTE

that does not operate properly by using the learning technique shown on page 42.

Automatic Code Entry

In addition to manual code selection using the brand name list, it is also possible to automatically search through all the codes that are stored in the DPR remote's library to see whether a device will respond even if it is not listed among the brands that appear when you program the remote manually. To automatically search through the codes that are available for a specific device type (e.g., DVD, VCR), follow these steps:

1. Turn on the power to the device you wish to program into the DPR remote. This is important because in a later step you will need to see whether the device turns off to determine whether the remote has been programmed for the proper remote codes.
2. Press and hold the **Program Button 25** for about three seconds while the message shown in Figure 18 appears in the remote's **LCD Information Display 3**. Release the button when the red light under the **Set Button 17** appears.
3. The remote's **MAIN MENU** message (Figure 19) will appear in the LCD display and the **Set Button 17** will remain illuminated in red. Press the **Set Button 17** to begin the process of selecting a device and locating the proper remote codes.
4. **SELECT A DEVICE** will appear in the LCD display (Figure 20). Press the **▲/▼ Navigation Button 15** to scroll through the list of device categories and press the **Set Button 17** when the device for which you wish to set the codes appears. For this example, we will select "TV" to enter the codes needed to operate your TV.
5. At the next menu screen on the remote, press the **▲ Navigation Button 15** so that the bottom line of the LCD display reads **AUTO** (Figure 25) and then press the **Set Button 17** to enter the Automatic programming mode.



The LCD display shows "PROGRAM DEVICE" on the top line and "AUTO" on the bottom line. A small triangle cursor is positioned to the right of "AUTO".

Figure 25

6. As instructed on the next menu screen, press the **▲ Navigation Button 15** to begin the automatic code search process. Your confirmation that the remote is sending out commands is the movement of a square block across the top line of the LCD display screen while the bottom line reads **PLEASE WAIT...** You will also see the transmit icon in the upper right corner of the LCD display's top line to remind you that the remote is

working even though you may not see anything happening to the device being programmed.

7. It will take a few seconds for the remote to send out the first group of commands, after which you will see a new display in the LCD screen, as shown in Figure 26. Following the instructions, if the device being programmed has *not* turned off, press the **▲ Navigation Button 15** again to send another group of codes. If the device being programmed *has* turned off, skip to Step 9.

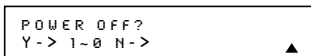

The LCD display shows "POWER OFF?" on the top line and "Y-> 1-0 N->" on the bottom line. A small triangle cursor is positioned to the right of "N->".

Figure 26

8. By pressing the **▲ Navigation Button 15** again, the remote will send out a new set of commands. When it pauses, follow the instructions shown in Step 7. Depending on how many codes are stored for a specific device type, you may have to repeat this process as many as fifteen times. Remember, if the device turns off, skip to Step 9. When all the codes for the device being programmed have been tried, the instruction shown in Figure 27 will appear. This means that the codes for the product you are trying to program are not in the DPR remote library and you will have to "learn" them into the remote following the instructions shown in the next section. Press the **Set Button 17** as instructed to exit the programming process.



The LCD display shows "REACH END POINT" on the top line and "EXIT -> SET KEY" on the bottom line.

Figure 27

9. If the device being programmed *does* turn off after following the instructions in Step 7, you will need to verify the code set by pressing the **Numeric Keys 11** in sequence, as instructed in Figure 26. Point the remote at the device being programmed, and press the **"1" Button 11** to see whether the device turns back on.
10. After pressing and releasing the **"1" Button 11**, check to see whether the device has turned back on. If it has, skip to Step 12. If it does not turn off, press the **"2" Button 11**, or the next button in the numeric sequence if you are repeating the procedure, as instructed by the LCD screen in Figure 28.
11. When pressing the "1" button does not turn the device being programmed back on, repeat the procedure by trying the remainder of the **Numeric Keys 11** in sequence, each time

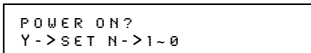

The LCD display shows "POWER ON?" on the top line and "Y-> SET N-> 1-0" on the bottom line.

Figure 28

pressing and then releasing the button to see whether the new device turns back on. When it does, skip to the next step. However, if you try all 10 numeric keys and find that the unit will not turn on, you won't be able to use this method to program the device. Press the **Clear Button 10** to exit the programming process. You'll need to follow the Learning Commands instructions below to enter the codes for this device into the DPR remote.

12. When pressing one of the numeric keys in Step 10 or 11 causes the device being programmed to turn back on, follow the instructions shown in Figure 26 and press the **Set Button 17** within five seconds of the device turning on. After you press the Set button, the top line of the LCD display will read **SAVING...** and then the word **SAVED** will flash four times in the center of the bottom line.
13. When the codes are saved, the remote will return to normal operation, and whenever you press the **Input Selector Button 4** that was just programmed, the codes for the new device will be used.

Learning Commands

On occasions when the DPR remote does not contain the codes for a particular product's remote in its built-in library, or when you wish to program a missing or special function into one button of a device, the DPR remote's learning capability allows you to do that. To teach commands from one product's remote into the DPR remote, follow the steps below:

The process requires that both the device's original remote and the DPR remote be available. Before pressing any buttons on either remote, place them so that the IR transmitter on the remote from the device to be programmed is facing the **Infrared Lens 47** on the DPR remote. The two remotes should be no more than an inch apart, and there should not be any direct sunlight or other bright light source near the remotes.

1. Press and hold the **Program Button 25** for about three seconds while the message shown in Figure 18 appears in the remote's **LCD Information Display 3**. Release the button when the red light under the **Set Button 17** appears.
2. The remote's **MAIN MENU** message (Figure 19), will appear in the LCD display and the **Set Button 17** will remain illuminated in red. Press the **▲ Navigation Button 15** once so that **LEARN** appears on the bottom line of the LCD screen, as shown in Figure 29. Press the **Set Button 17** to begin the process of learning

commands from another device's remote into the DPR remote.

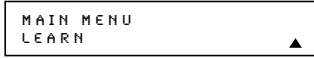

Figure 29

- The **SELECT A DEVICE** message will appear in the LCD display (Figure 20). Press the **▲/▼ Navigation Buttons 15** to scroll through the list of device categories and press the **Set Button 17** when the device for which you wish to set the codes appears. For this example, we will select "TV" to enter the codes needed to operate your TV.

- The next menu screen (Figure 30) will prompt you to select the button, or "key," on the DPR remote that you wish to program. Press that button on the DPR remote.

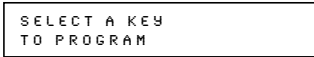

Figure 30

- Once you press the button to be programmed on the DPR remote, press and hold the button on the remote control for the device to be programmed within five seconds, as instructed on the next menu screen (Figure 31).



Figure 31

- Continue to hold the button on the original remote until the menu on the DPR remote's LCD screen changes. If the code is successfully learned, you will see the display shown in Figure 32.



Figure 32

If you see that menu, proceed to Step 9. If the code is *not* successfully learned, you will see the display shown in Figure 33. If that menu appears, proceed to Steps 7 and 8.

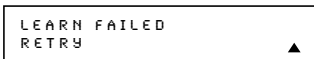

Figure 33

- If the message shown in Figure 33 appears in the display, press the **Set Button 17** to try programming the button again. When the remote prompts you to press and hold the key on the original remote again by showing the display shown in Figure 31, immediately press the button on the source remote again. To avoid another failed attempt, make certain that the windows on the two remotes are facing one another.

- Continue to hold the button on the original remote until the LCD display changes again. If the code was successfully learned, you will see the display shown in Figure 32. In that case, go to Step 9. If the **LEARN FAILED** display (Figure 33) appears again, you may either try to program the key again, or press the **▲ Navigation Button 15** to stop the process. It is possible that some remotes may use code sequences or infrared frequencies that are not compatible with the DPR remote, and those codes cannot be learned. When the display shown in Figure 34 appears, press the **Set Button 17** to exit the Learning system.



Figure 34

- When a code has been learned successfully, you have three options. When the display shown in Figure 32 is on the LCD screen on the DPR remote, you may press the **Set Button 17** to learn additional codes from the buttons on a source remote into the DPR remote. Follow Steps 4 through 6 as often as needed to complete the code-learning process.

- If you wish to change the name that appears in the LCD display when the button that has just had a new code learned is pressed, press the **▲ Navigation Button 15** so that the display shown in Figure 35 appears in the LCD display. Press the **Set Button 17** to be taken to a **RENAME KEY** display. Enter the new name for the key following the instructions shown in the Renaming Individual Keys section of this manual on page 49. If you find it more convenient to rename the buttons at a later time, you may do that separately by following the instructions on page 48.

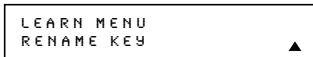

Figure 35

- When you have programmed all keys for the desired device, press the **▲ Navigation Button 15** twice when the **LEARN MENU** (Figure 32) appears so that you see the display shown in Figure 36. Press the **Set Button 17** to return the remote to normal operation.

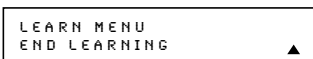

Figure 36

- If you wish to program the codes for another device, repeat the procedure outline above, but select a different device in Step 3.

Changing Devices

In the factory default settings, the DPR remote is programmed so that the commands transmitted correspond to the device selected by pressing one of the **Input Selectors 4**. This is logical, as you want the remote to control the device you have selected. However, in some circumstances you may have configured your system so that the devices connected to the AVR 7300 do not correspond to the default device settings and the legends printed on the remote. For example, if your system has two VCRs you may connect the second VCR to the VID 2 input. There is no problem in doing that, but in normal operation the commands issued after selecting the VID 2 input are for a television, not a VCR.

The DPR remote allows you to correct that situation through the "Changing Devices" process. This enables you to assign the codes from one type of device to a different button. For example, in the steps below, we will explain how to program the VID 2 buttons to provide the commands to operate a VCR. Of course, you may program the remote to have any of the devices take on the code set of any other device, as your system requires. And, with the DPR remote's "Rename" function, you can even change the way the name of the device appears on the remote's LCD display so that you see exactly which commands are being sent.

To program the buttons normally assigned to one device for the commands of another, follow these steps:

- Press and hold the **Program Button 25** for about three seconds while the message shown in Figure 18 appears in the remote's **LCD Information Display 3**. Release the button when the red light under the **Set Button 17** appears.
- The remote's **MAIN MENU** message (Figure 18), will appear in the LCD display and the **Set Button 17** will remain illuminated in red. Press the **▲ Navigation Button 15** twice so that **CHANGE DEVICE** appears on the bottom line of the LCD screen, as shown in Figure 37. Press the **Set Button 17** to begin the process of reassigning the commands used for a particular device.

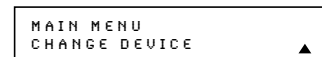

Figure 37

- The next menu display is where you select the Input Select, or device, that you wish to change. When the display shown in Figure 38 appears, press the **▲/▼ Navigation Button 15** to scroll through the list to find the device you wish to use for another function. In this case we will select

CONFIGURING THE REMOTE

"TV," and show how to change it to take on the codes for operating a VCR. When that device's name appears, press the **Set Button 17**.



Figure 38

- Once the "old" device type has been selected, you need to tell the remote which set of remote codes to use as a replacement for the device just selected. When the instructions shown in Figure 39 appear, press the **▲/▼ Navigation Button 15** to scroll through the list of device categories to find the name of the device that you wish to use. The old device name will remain on the left side of the LCD screen, while the replacement device list will scroll to its right. For example, press the **▲ Navigation Button 15** until the display screen reads **TU<-VCR** to have the VID 2/TV Button transmit the commands used to control a VCR. Press the **Set Button 17** when the desired device combination appears.

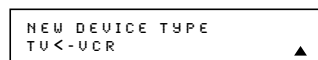

Figure 39

- Once the new device is selected, the remainder of the process will select the codes for the specific brand to be used, and for that reason they are identical to the way a device is programmed using manual entry. Continue the process as outlined in the next few steps, remembering that if the codes for your specific device are not found, you may select any brand and then "learn" the proper codes into the DPR remote using the process outlined on page 42. To begin the process, start by selecting the brand of device, as shown in Figure 22. Press the **▲/▼ Navigation Button 15** until the brand name of the device you are programming into the remote appears on the lower line of the display and then press the **Set Button 17**.
- The next step is important, as it determines which codes will operate the source device or display. Point the DPR remote at the device being programmed and, following the instructions shown on the remote's **LCD Information Display 3**, press and release the **Numeric Keys 11** one at a time, starting with the "1" **Button 11**. After you press the "1" **Button 11**, the remote's LCD screen will briefly go blank as the code is being transmitted, but you will see the "transmit" icon in the upper right corner of the display to serve as confirmation that the remote is sending out commands.



- After you press and release the number key, watch the device being programmed to see whether it turns off. As shown in the instructions that will appear on the next menu screen (Figure 24), press the **Set Button 17**, and then skip to Step 9. If the unit does *not* turn off, proceed to the next step.
- If the device being programmed into the DPR remote does *not* turn off after you have pressed the "1" **Button 11**, continue Steps 6 and 7 by pressing the available numeric keys shown until the device turns off. If the device still does not turn off after all choices have been tried, the code for this specific device is not in the DPR remote library under that brand name. If that is the case, we suggest that you press the **Set Button 17** to accept the codes from another brand so that the programming is completed, but remember that you will then have to program the remote manually by following the Learning Commands instructions on page 42.
- When the device being programmed does turn off after a numeric key has been pressed, you must press the **Set Button 17** within five seconds to enter the setting into the remote's memory. After you press the Set button, the top line of the LCD display will read **SAVING...** and then the word **SAVED** will flash four times in the center of the bottom line.
- When the codes are saved the remote will return to normal operation, and whenever you press the **Input Selector Button 4** that was just programmed, the display will show the original device type code at the far left side of the display, with the name of the new code set type in brackets. For example, the display will read **TU<-VCR** in our example of replacing the TV codes with those for a VCR.

Macro Programming

Macros enable you to easily repeat frequently used combinations of multiple remote control commands with the touch of a single button. Once a macro is programmed, you may send up to 20 commands with one press of the Power On or Macro buttons. This will greatly simplify the process of turning on your system, changing devices or other common tasks. Thanks to the remote's two-line display, it is easier than ever for you to take advantage of the power of macro commands.

Recording a Macro

To record a macro into the remote's memory, follow these steps:

- Press and hold the **Program Button 25** for about three seconds while the message shown in Figure 18 appears in the remote's **LCD Information Display 3**. Release the button when the red light under the **Set Button 17** appears.
 - The remote's **MAIN MENU** message (Figure 19), will appear in the LCD display and the **Set Button 17** will remain illuminated in red. Press the **▲ Navigation Button 15** three times so that **MACRO** appears on the bottom line of the LCD screen, as shown in Figure 40. Press the **Set Button 17** to enter the main macro menu branch.
- 
- Figure 40
- At the next menu screen (Figure 41) press the **Set Button 17** to begin recording a macro.
- 
- Figure 41
- The next display screen (Figure 42) is where you select the button that will be used to recall the macro. The choices are the **Power On Button 2** or one of the discrete **Macro Buttons 28**. Press the **▲/▼ Navigation Button 15** until the name of the button you wish to program the macro into is shown. For this example we will show how to program a series of commands that will automatically be sent out every time the Power button is pressed.
- 
- Figure 42
- The next screen that appears (Figure 43) is where you select the device for the first command that will be sent out as part of the macro. Press the **▲/▼ Navigation Button 15** until the name of the device appears on the left side of the lower line in the LCD display. For this example, the first button we want to have the macro "press" is the Power On button, so the DPR device is selected. Press the **Set Button 17** when the desired device name appears to move to the next programming step.
- 
- Figure 43
- The next display (Figure 44) is where you begin entering the individual commands for the macro, in the order you wish them to be transmitted. Remember that when you want to change devices,

you must first press the **Input Selectors** 4 for that button, and then press the Command or Function key. Since we want to program a series of events that occur each time the Power On button is pressed, press the DPR button. In your specific macro, this is the first command button.



Figure 44

- The next display (Figure 45) and the subsequent screens are where the actual macro programming takes place. The words at the left side of the top line of the display show the button that is being programmed (e.g., the **Power On Button** 2 or one of the **Macro Buttons** 23) and the indication at the right side of the top line shows the number of macro steps available of 20 possible steps. Following the instructions on the remote's LCD screen, press the first key you wish to be transmitted in the macro. In our example, we first want the DPR 2005 to turn on, so the **Power Button** 2 should be pressed.

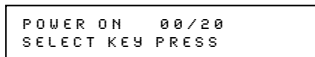

Figure 45

- Once the first command button for the macro has been pressed, continue to press the buttons you wish to be part of the macro, in the order they will be used. Press each button within five seconds of the last button, remembering to press the **Input Selector** 4 when you are changing device functions. As the buttons on the remote are pressed, the remote's display screen will show the steps in the macro as they are programmed (Figure 46).



Figure 46

- For our example, we first want the DPR Power On button pressed, followed by the TV Power On, followed by the Cable Box On, followed by the selection of the Logic 7 mode. To do that, press the buttons in this order:

- Power On 2
- VID 2/TV 4
- Power On 2
- VID 3/Cable 4
- Power On 2
- DPR 5
- Logic 7 8

As each button is pressed to enter it into the macro, you will see the button names appear and then scroll up on the LCD display as your confirmation of the key entry (Figure 46).

- When all commands for the macro have been entered, press the **Set Button** 17 to save the macro. The display screen will show the button to which the macro has been programmed and the number of steps used, and the word **SAVED** will blink four times in the lower line of the LCD display. When the display returns to normal, the macro has been entered and the remote is ready for operation.

- If a macro has been programmed into the **Power On Button** 2, it will play back anytime the Power On button is pressed. As the macro plays, you will see the steps appear in the remote's LCD display. Macros programmed into one of the four discrete Macro buttons may be activated at any time by pressing the appropriate button.

Erasing a Macro

Once a macro has been created and stored in the DPR remote's memory, you have the option of erasing it. You may do this at any time by following these steps:

- Press and hold the **Program Button** 25 for about three seconds while the message shown in Figure 18 appears in the remote's **LCD Information Display** 3. Release the button when the red light under the **Set Button** 17 appears.
- The remote's **MAIN MENU** message (Figure 19), will appear in the LCD display and the **Set Button** 17 will remain illuminated in red. Press the **Navigation Button** 15 three times so that **MACRO** appears on the bottom line of the LCD screen, as shown in Figure 40. Press the **Set Button** 17 to enter the main macro menu branch.
- At the next menu screen (Figure 47), press the **Navigation Button** 15 until the bottom line in the remote's LCD display reads **ERASE A MACRO**. Press the **Set Button** 17 to begin the process of erasing a macro.



Figure 47

- The next display screen (Figure 48) is where you select which macro will be erased. Press the **Navigation Button** 15 until the number of the macro you wish to erase appears. For this example we will erase the Power On macro created in the previous section. When the name of the macro to be erased appears, press the **Set Button** 17.

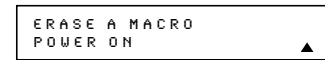

Figure 48

- The word **ERASED** will flash four times in the bottom line of the remote's LCD display, and then the display will return to its normal condition. When that happens, the macro is erased and the remote is returned to normal operation.

Read a Macro

To check the commands stored in the remote's memory for one of the buttons, follow these steps:

- Press and hold the **Program Button** 25 for about three seconds while the message shown in Figure 18 appears in the remote's **LCD Information Display** 3. Release the button when the red light under the **Set Button** 17 appears.
- The remote's **MAIN MENU** message (Figure 18), will appear in the LCD display and the **Set Button** 17 will remain illuminated in red. Press the **Navigation Button** 15 three times so that **MACRO** appears on the bottom line of the LCD screen, as shown in Figure 40. Press the **Set Button** 17 to enter the main macro menu branch.
- At the next menu screen (Figure 49), press the **Navigation Button** 15 until the bottom line in the remote's LCD display shows **READ A MACRO**. Press the **Set Button** 17 to begin the process of reading a macro.

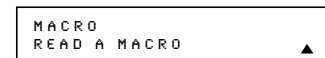

Figure 49

- The next display screen (Figure 50) is where you select the macro to be read. Press the **Navigation Button** 15 until the name of the macro you wish to read appears. For this example, we will read back the Power On macro created in a previous section. When the name of the macro to be read appears, press the **Set Button** 17.



Figure 50

- As soon as the Set button is pressed, the first two steps in the macro will be appear in the remote's LCD screen. You may then use the **Navigation Button** 15 to step up or down through the list of commands stored as the macro. As you read the display, you will see **Input Selector Buttons** 4 appear in brackets, (e.g., [DPR]). When the step in the macro is a function, navigation or any other button, it will appear

CONFIGURING THE REMOTE

next to the bracketed read-out of the underlying device (e.g., **[AUR] POWER ON**).

- When you are finished reviewing the macro's contents, press the **Set Button 17** to return the remote to normal operation.

Punch-Through Configuration

Punch-through is a capability of the remote that allows the Volume controls, Channel Up/Down buttons or Transport keys (Play, Stop, Record, Fast Forward and Reverse, and Skip Up/Down) to link to a different device. For example, if your TV, cable box or satellite receiver is connected through the AVR 7300, you will most likely want to use the AVR 7300's volume control commands even when the remote has been set to issue all other commands for the video device. "Punch-through" enables you to easily program the remote to do this.

Volume Punch-Through

Follow these steps to enable the Volume Up/Down and Mute controls from one device to be used when the remote is otherwise programmed for a different device.

NOTE FOR VOLUME PUNCH-THROUGH: The remote's default settings are for the AVR 7300's volume controls, to be used when any input or device is selected, with the exception of the VID 2/TV button. There is no need to program the remote for volume punch-through for the AVR 7300's controls with other sources, such as DVD. To have the AVR 7300's volume commands used when the TV device is selected, follow these steps:

- Press and hold the **Program Button 25** for about three seconds while the message shown in Figure 18 appears in the remote's **LCD Information Display 3**. Release the button when the red light under the **Set Button 17** appears.
- The remote's **MAIN MENU** message (Figure 19), will appear in the LCD display and the **Set Button 17** will remain illuminated in red. Press the **▲/▼ Navigation Button 15** until **PUNCH-THROUGH** appears on the bottom line of the LCD screen, as shown in Figure 51. Press the **Set Button 17** to enter the main punch-through menu branch.

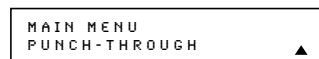

Figure 51

- At the next menu screen (Figure 52) press the **Set Button 17** to begin programming the remote for Volume punch-through.

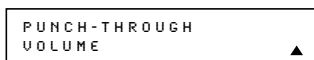

Figure 52

- The next display screen (Figure 53) is where you select the device that will receive the punch-through commands. In our example, that is the VID 2/TV button, as that is where we want the DPR 2005's volume controls to be active. Press the **▲/▼ Navigation Button 15** until the name of the base device appears and then press the **Set Button 17**.

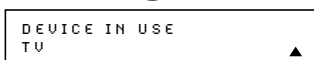

Figure 53

- At the next display screen (Figure 54), you will select the device whose Volume Up/Down and Mute commands will be used. Press the **▲/▼ Navigation Button 15** until the desired device's name appears to the right of the device in use. In our example, that is the DPR 2005 (indicated by **DPR**). When the desired combination of devices appears, press the **Set Button 17**.



Figure 54

- When the Set button is pressed, the display will change to show you that the new combination of control commands is being saved to the unit's memory, as shown in Figure 55. The word **SAVED** will flash four times and then the remote will return to normal operation.

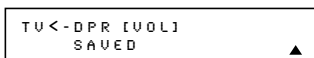

Figure 55

- Once the punch-through is programmed, the Volume Up/Down and Mute buttons of the second device named will be used when those buttons **18 33** are pressed while the master device is in use.

Returning the Volume Control Settings to Default Operation

If you wish to remove the Volume punch-through so that the commands for Volume and Mute are returned to the factory default setting, follow the steps shown above, except that in Steps 4 and 5, select the same device for both the **DEVICE IN USE** on the left side of the bottom line and the **PUNCH-THROUGH** device. In the example used, the display to return the remote to default settings will appear as shown in Figure 56.



Figure 56

Channel Punch-Through

Channel punch-through allows the Channel Up/Down buttons to send commands to a different device than the one that has been selected for other commands. For example, you may wish to use a cable box or satellite receiver as the source for a VCR, so you would want the **Channel Up/Down Buttons 35** to transmit commands to the cable box even though the other button commands are programmed to operate the VCR.

To program the remote for channel punch-through, follow these steps. This example will show how to program channel punch-through so that the commands programmed for Channel Up/Down for the VID 3/ Cable device will be transmitted when the VID 1/VCR device has been selected as the current device.

- Press and hold the **Program Button 25** for about three seconds while the message shown in Figure 18 appears in the remote's **LCD Information Display 3**. Release the button when the red light under the **Set Button 17** appears.
- The remote's **MAIN MENU** message (Figure 19), will appear in the LCD display and the **Set Button 17** will remain illuminated in red. Press the **▲/▼ Navigation Button 15** until **PUNCH-THROUGH** appears on the bottom line of the LCD screen, as shown in Figure 51. Press the **Set Button 17** to enter the main punch-through menu branch.
- At the next menu screen, press the **▲/▼ Navigation Button 15** until **CHANNEL** appears on the bottom line of the LCD screen, as shown in Figure 57. Press the **Set Button 17** to begin programming the remote for channel punch-through.

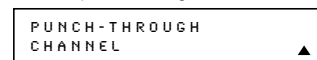

Figure 57

- The next display screen (Figure 58) is where you select the device that will receive the punch-through commands. In our example, that is the VID 1/VCR button, as that is where we want the cable box's channel controls to be active. Press the **▲/▼ Navigation Button 15** until the name of the base device appears and then press the **Set Button 17**.

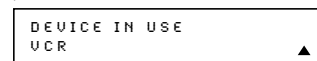

Figure 58

- At the next display screen (Figure 59), you will select the device whose Channel Up/Down commands will be used. Press the **▲/▼ Navigation**

Button **15** until the desired device name appears to the right of the device in use. In our example, that is the cable box. When the desired combination of devices appears, press the **Set Button 17**.



Figure 59

- When the Set button is pressed, the display will change to show you that the new combination of control commands is being saved to the unit's memory, as shown in Figure 60. The word **SAVED** will flash four times and then the remote will return to normal operation.



Figure 60

- Once the punch-through is programmed, the **Channel Up/Down Buttons** of the second device named will be used when those buttons **35** are pressed while the master device is in use.

Returning the Channel Control Settings to Default Operation

If you wish to remove the Channel Punch-Through so that the commands for Channel Up/Down are returned to the factory default setting, follow the steps shown above, except that in Steps 4 and 5, select the same device for both the **DEVICE IN USE** on the left side of the bottom line and the **PUNCH-THROUGH** device. In the example used, the display to return the remote to default settings will appear as shown in Figure 61.



Figure 61

Transport Punch-Through

The **Play 36**, **Stop 20**, **Fast Forward/Reverse 19**, **Pause 20**, **Record 20** and **Skip Up/Down 21** Transport Controls are set at the factory to operate your DVD player, or the controls of a specific device such as a VCR or CD player when they are selected. However, by using the Transport Punch-Through feature you may program these controls to transmit the commands for a different device. For example, you may wish to operate the transport of a VCR connected to the VID 1/VCR input as the default, rather than the button for a DVD player, as shown in the following example.

- Press and hold the **Program Button 25** for about three seconds while the message shown in Figure 18 appears in the remote's **LCD Information Display 3**. Release the button

when the red light under the **Set Button 17** appears.

- The remote's **MAIN MENU** message (Figure 17), will appear in the LCD display and the **Set Button 17** will remain illuminated in red. Press the **▲/▼ Navigation Button 15** until **PUNCH-THROUGH** appears on the bottom line of the LCD screen, as shown in Figure 51. Press the **Set Button 17** to enter the main punch-through menu branch.
- At the next menu screen, press the **▲/▼ Navigation Button 15** until **TRANSPORT** appears on the bottom line of the LCD screen, as shown in Figure 62. Press the **Set Button 17** to begin programming the remote for transport punch-through.



Figure 62

- The next display screen (Figure 63) is where you select the device that will receive the punch-through commands. In our example, that is the TV button, as that is where we want the VCR's transport controls to be active. Press the **▲/▼ Navigation Button 15** until the name of the base device appears and then press the **Set Button 17**.

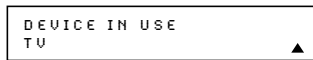

Figure 63

- At the next display screen (Figure 64), you will select the device whose transport commands will be used. Press the **▲/▼ Navigation Button 15** until the desired device name appears to the right of the device in use. In our example, that is the VCR. When the desired combination of devices appears, press the **Set Button 17**.



Figure 64

- When the Set button is pressed, the display will change to show you that the new combination of control commands is being saved to the unit's memory, as shown in Figure 65. The word **SAVED** will flash four times and then the remote will return to normal operation.

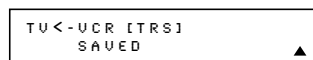

Figure 65

- Once the punch-through is programmed, the transport buttons of the second device named

will be used when those buttons are pressed while the master device is in use.

Returning the Transport Control Settings to Default Operation

If you wish to remove the Transport Punch-Through so that the transport commands are returned to the factory default setting, follow the steps shown above, except that in Steps 4 and 5, select the same device for both the **DEVICE IN USE** on the left side of the bottom line and the **PUNCH-THROUGH** device. In the example used, the display to return the remote to default settings will appear as shown in Figure 66.

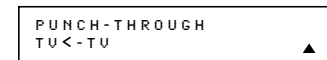

Figure 66

EzSet Configuration

Harman Kardon's patented EzSet feature makes it easier than ever to calibrate the output levels on your new receiver for maximum playback accuracy. In addition to automatically setting the levels, the DPR remote's LCD display allows the unit to be used as a direct read-out SPL meter. Complete instructions for using the EzSet features of the DPR remote are found on pages 27 – 29 of this owner's manual.

In most cases you will find it easier to access the EzSet capabilities directly by pressing the **SPL Select Button 45** and following the menu prompts as detailed on pages 27 and 28. However, there is one function of the remote that is only available through the remote's menu system being described in this section.

To avoid having the calibration settings created with EzSet changed accidentally, the remote allows you to disable the **SPL Select Button 45** on the remote. To de-activate the button, follow these steps:

- Press and hold the **Program Button 25** for about three seconds while the message shown in Figure 18 appears in the remote's **LCD Information Display 3**. Release the button when the red light under the **Set Button 17** appears.
- The remote's **MAIN MENU** message (Figure 19), will appear in the LCD display and the **Set Button 17** will remain illuminated in red. Press the **▲/▼ Navigation Button 15** until **SET SPKR LEVELS** appears on the bottom line of the LCD screen, as shown in Figure 67. Press the **Set Button 17** to enter the main EzSet menu branch.



Figure 67

CONFIGURING THE REMOTE

- At the next menu screen (Figure 68) press the **▲/▼ Navigation Buttons 15** once so that **EzSet DISABLE** appears in the lower line of the LCD display.



Figure 68

- Within five seconds, press the **Set Button 17** to disable the **SPL Select Button 45**. Once the **Set Button 17** is pressed the word **EXITING** will flash four times in the lower line of the LCD display and then it will return to normal operation.

Once these steps are completed, when the **SPL Select Button 45** is pressed the remote will show **EzSet DISABLE** and it will not be activated.

To restore the EzSet feature to normal operation, repeat the procedure outlined above, except that in Step 3 you should press the **▲/▼ Navigation Button 15** so that **EzSet ENABLE** appears in the lower line of the LCD display. When that display appears, press the **Set Button 17** and the EzSet feature will be reactivated. You may then press the **Clear Button 10** to exit the remote's menu system and return to normal operation or press the **Set Button 17** again to immediately use the EzSet feature to calibrate the system as shown on pages 27 and 28.

Renaming

While the names given to the buttons and inputs on the remote represent recognizable categories of audio/video products, system operation may be easier if the displays shown in the remote's LCD screen are customized to reflect the specific characteristics of a playback source's brand name or the new function given to a specific button when one remote's controls are programmed into the DPR remote. The DPR remote allows you to change the name of either a master device or any button on the remote using the following steps.

Renaming a Device

To rename a specific device/input source button, follow these steps. For this example, we will show you how to rename the Device/Input Selector normally shown as "TV" to "HDTV TUNER."

- Press and hold the **Program Button 25** for about three seconds while the message shown in Figure 16 appears in the remote's **LCD Information Display 3**. Release the button when the red light under the **Set Button 17** appears.
- The remote's **MAIN MENU** message (Figure 17), will appear in the LCD display and the **Set Button**

- 17** will remain illuminated in red. Press the **▲/▼ Navigation Button 15** until **RENAME** appears on the bottom line of the LCD screen, as shown in Figure 69.

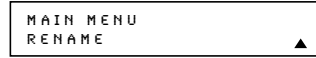

Figure 69

- At the next menu screen press the **▲/▼ Navigation Button 15** until **RENAME DEVICE** appears on the bottom line of the LCD screen, as shown in Figure 70. Press the **Set Button 17** to begin renaming a device.

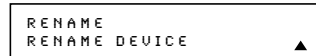

Figure 70

- The next display screen (Figure 71) is where you select the device that will be renamed. In our example, that is the TV button. Press the **▲/▼ Navigation Button 15** until the name of the base device appears and then press the **Set Button 17**.



Figure 71

- At the next menu screen you will see the device name on the bottom line of the display with a blinking cursor box to the right of the device name. Press the **◀ Navigation Button 15** to return the blinking cursor to the far left side of the display line. You may then retile the device name as shown in the next step.
- To enter the new name, press the **Numeric Keys 11**. The letters above the numbered buttons indicate which letter or symbol will appear when the button is pressed during the renaming process. The first press of the button will enter the first letter shown, subsequent presses of the same button will change the display to the other letters above that numbered key. For example, since the first letter we need to rename the input to HDTV Tuner is an "H", you would locate the "H" above the "4" button, and press the button twice. The first press shows a "G," the second press changes it to an "H." Consult the table at the end of this section to see which characters pressing a particular button generates.
- After you enter the first letter of the new device name, there are three options for entering the next character:

- To enter a letter that requires a different numeric key to be pressed, simply press that button. The cursor will automatically move to the next position and the first letter accessed

by the new button will appear. Following our example, the next letter needed is a "D," so you would press the "3" button once.

- To enter a letter that uses the same numeric key, you must first press the **▶ Navigation Button 15** to move the blinking cursor block to the next position. Then press the **Numeric Key 11** as required to enter the desired letter.
 - To enter a blank space, press the **▶ Navigation Button 15** twice. The first press will move the cursor to the right, and the second press will move the cursor one more space to the right, leaving a blank space between the last letter and the next one.
- Repeat Step 7 as needed to enter all the needed letters, numbers, characters and spaces.
 - When the text entry is complete, press the **Set Button 17**. The LCD display will blink **DEVICE RENAMED** three times and then return to normal operation.

Once a device is renamed you will see the new name on the top line of the remote's LCD display whenever the **Input/Device Selector 4** is pressed, or when any other command/function button on the remote is pressed after the main Device Selector is pressed. Note that renaming a device in the remote will *not* change the name of the input used by the on-screen menu system of the AVR 7300.

NOTES ON RENAMING DEVICES:

- To move the cursor to the right or left of the display during the renaming process, press the **◀▶ Navigation Buttons 15** as required.
- The table below shows the letters, numbers and characters that may be accessed by pressing the Numeric Keys:

Key	Characters	Key	Characters
1	[], /, 1	6	M, N, O, 6
2	A, B, C, 2	7	P, Q, R, S, 7
3	D, E, F, 3	8	T, U, V, 8
4	G, H, I, 4	9	W, X, Y, Z, 9
5	J, K, L, 5	0	- , #, 0
- Renaming a device changes the name of the device only, not any of the individual key functions within that device memory. To change the name of an individual device, follow the instructions in the next section.

Renaming Individual Keys

Thanks to the programming flexibility of the DPR remote, an individual button on the remote may be assigned a feature or function that is different from the name that appears as the factory default when the button is pressed. However, with the Rename Key function it is possible to rename almost any button on the remote so that when the button is pressed you will see a more descriptive or appropriate name displayed.

To rename a specific button on the remote, follow these steps. For instance, this example will show you how to program the remote so that **ZOOM** appears in the remote's LCD display when you press the **Tone Button 32** since it does not have a preprogrammed function for DVD players. Of course, remember that you will first have to learn the codes for that function into the Tone button, following the instructions shown on page 42.

1. Press and hold the **Program Button 25** for about three seconds while the message shown in Figure 18 appears in the remote's **LCD Information Display 3**. Release the button when the red light under the **Set Button 17** appears.
2. The remote's **MAIN MENU** message (Figure 17), will appear in the LCD display and the **Set Button 17** will remain illuminated in red. Press the **▲/▼ Navigation Button 15** until **RENAME** appears on the bottom line of the LCD screen, as shown in Figure 69.
3. At the next menu screen press the **▲/▼ Navigation Button 15** until **RENAME KEY** appears on the bottom line of the LCD screen, as shown in Figure 72. Press the **Set Button 17** to continue.

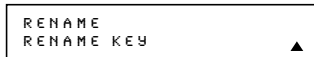

Figure 72

4. The next display screen (Figure 73) is where you select the device within which the key to be renamed exists. Press the **▲/▼ Navigation Buttons 15** until the name of the base device appears. In our example, since we want to rename a button within the DVD device memory, **DVD** should appear in the lower line of the LCD. When the desired device name appears, press the **Set Button 17**.

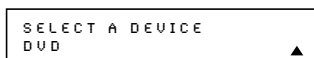

Figure 73

5. At the next menu screen you will select the first button within the device to be renamed, as instructed in the display shown in Figure 74.

Select the button (in this case, the **Tone Button 32**) by simply pressing it on the remote.



Figure 74

6. Depending on whether or not the button pressed already has a named function within the device selected, one of two things will happen.
 - a. If the button to be renamed already has a pre-programmed, or previously renamed title in the remote's memory, you will see that name on the top line of the LCD display, and a blinking block cursor will appear on the far left side of the bottom line of the display.
 - b. If the button to be renamed does not have a function in the device selected, the top line of the LCD screen will be blank, and a blinking block cursor will appear on the far left side of the bottom line of the display, as shown in Figure 76.

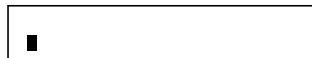

Figure 76

7. To enter the new name for the key, press the **Numeric Keys 11**. The letters above the numbered buttons indicate which letters or symbols will appear when the button is pressed during the renaming process. The first press of the button will enter the first character shown, subsequent presses of the same button will change the display to the other letters above that numbered key. For example, since the first letter we need to rename the Tone button to Zoom is a "Z," you would locate the "Z" above the "9" button, and press the button four times. The first press shows a "W," the subsequent presses step through the other letters available until the "Z" appears. Consult the table on page 48 to see which characters are available by pressing a particular button.
8. After you enter the first letter of the new device name, there are three options for entering the next character:
 - a. To enter a letter that requires a different numeric key to be pressed, simply press that button. The cursor will automatically move to the next position and the first letter accessed by the new button will appear. Following our example, the next letter needed is an "O," so you would press the "6" button once.

- b. To enter a letter that uses the same numeric key, you must first press the **► Navigation Button 15** to move the blinking cursor block to the next position. Then press the **Numeric Key 11** as required to enter the desired letter. This is the way you would enter the second "O" in the word ZOOM, and again for the letter "M."
 - c. To enter a blank space, press the **► Navigation Button 15** twice. The first press will move the cursor to the right, and the second press will move the cursor one more space to the right, leaving a blank space between the last letter and the next one.
9. Repeat Steps 7 and 8 as needed to complete entering the needed letters, numbers, characters and spaces.
 10. When the text entry is complete, press the **Set Button 17**. The new name will be entered into the remote's memory, replacing the default name.
 11. At this point you have two options:
 - a. If you wish to program an additional key within the same device, press the **Set Button 17** as instructed by the bottom line of the LCD display reading **ANOTHER KEY**. The remote will return to the **SELECT A KEY** menu option as shown in Step 6. Repeat the instructions in Steps 6 through 11 to rename the next key.
 - b. If you have no additional keys to rename, press the **▲ Navigation Button 15** once so that the menu screen displays **EXIT** on the bottom line of the display. Press the **Set Button 17** to return the remote to normal operation.

NOTES ON RENAMING KEYS:

- Renaming a key does not change its function. You may change the function of an individual key by learning a new code into the remote. See page 42 for more information.
- When a key is renamed it will only apply to the specific device selected in Step 4. The same key may be renamed as needed for each individual device with which it is used.

Resetting the Remote

Depending on the way in which the remote has been programmed, there may be a situation where you wish to totally erase all changes that have been made to the remote and return it to the factory defaults. You may do that by following the steps shown below, but remember that once the remote is reset, ALL changes that have been made, including programming for use with other devices, learned keys, macros, punch-through settings and key names, will be erased and

CONFIGURING THE REMOTE

any settings you had previously made will have to be reentered.

To erase all settings and reset the remote to the original factory default settings and displays, follow these steps:

1. Press and hold the **Program Button 25** for about three seconds while the message shown in Figure 18 appears in the remote's **LCD Information Display 3**. Release the button when the red light under the **Set Button 17** appears.
2. The remote's **MAIN MENU** message (Figure 19), will appear in the LCD display and the **Set Button 17** will remain illuminated in red. Press the **▲/▼ Navigation Button 15** until **USER RESET** appears on the bottom line of the LCD screen, as shown in Figure 77.

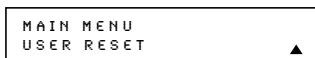

Figure 77

3. Press the **Set Button 17** to reset the remote. Note that once the Set Button is pressed the process may not be stopped. While the remote's memory is being cleared, a **RESETTING...** message will appear in the upper line of the remote's LCD screen as shown in Figure 78. It may take a few minutes for the reset process to take place, and the length of time will vary depending on how much customization and programming has taken place. Please be patient; as long as the message appears in the display the remote is functioning properly.



Figure 78

4. When the remote has been totally reset and returned to the factory default condition, a **REMOTE RESET COMPLETE** message will appear (Figure 79) briefly, and then the remote will return to normal operation.



Figure 79

Additional Notes on Configuring and Operating the Remote

- When the remote is being programmed, it will automatically time-out if no button is pressed within a thirty-second period. The message shown in Figure 80 will appear briefly, and the remote will then exit the feature being programmed and any data entered will be lost.



Figure 80

- The programming or configuration process may also be stopped at any time by pressing the **Clear Button 10**. The message shown in Figure 80 will appear, the data entered in the current process will be lost and the remote will return to normal operation. Any process that was underway when the button will be pressed must be restarted.
- Extensive use of the programming, learning and configuration functions of the remote may consume significantly more battery power than normal remote operation. While the batteries should last for four to six months in normal operation, you may find that they need to be changed sooner after the remote is programmed for the first time.
- When the batteries approach a level below which the remote will not function, the remote's LCD screen will display a **LOW BATTERY** warning as shown in Figure 81. We strongly recommend replacing the batteries as soon as this message appears to avoid the loss of programming and configuration settings. These settings are *not* lost when the batteries are changed quickly.

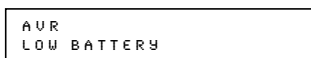

Figure 81

- The remote has a built-in backlight that may be activated by pressing the **Light Button 26**. This button is made from a special "glow" material so that it is easier to find in dark rooms. This glow feature does not consume any electricity, but the glow will fade when the remote is kept in a dark location for an extended period of time. The "glow" feature may be restored by placing the remote in normal room light for a few hours.
- The remote's backlight will remain lit for approximately five seconds after the **Light Button 26** is pressed, and it will stay lit for another five seconds if any key is pressed while the backlight is on. You may keep the backlight lit by holding the Light Button, but extensive use of the backlight will reduce battery life.
- The LCD display will remain on for ten seconds after a key is pressed and then turn off to conserve battery life.
- When any button is held for more than thirty seconds, the LCD will turn off and the remote will stop transmitting the codes to conserve battery life.

TROUBLESHOOTING GUIDE

SYMPTOM	CAUSE	SOLUTION
Unit does not function when Main Power Switch is pushed	<ul style="list-style-type: none"> No AC Power 	<ul style="list-style-type: none"> Make certain that the AC power cord is plugged into a live outlet Check to see whether the outlet is switch-controlled
Display lights, but no sound or picture	<ul style="list-style-type: none"> Intermittent input connections Mute is on Volume control is down 	<ul style="list-style-type: none"> Make certain that all input and speaker connections are secure Press Mute Button 33 Turn up the volume control
Unit turns on, but front-panel display does not light up	<ul style="list-style-type: none"> Display brightness is turned off 	<ul style="list-style-type: none"> Follow the instructions in the Display Brightness section on page 37 so that the display is set to VFD FULL
No sound from any speaker; light around power switch is red	<ul style="list-style-type: none"> Amplifier is in protection mode due to possible short Amplifier is in protection mode due to internal problems 	<ul style="list-style-type: none"> Check speaker wire connections for shorts at receiver and speaker ends Contact your local Harman Kardon service center
No sound from surround or center speakers	<ul style="list-style-type: none"> Incorrect surround mode Input is monaural Incorrect configuration Stereo or Mono program material 	<ul style="list-style-type: none"> Select a mode other than Stereo There is no surround information from mono sources Check speaker mode configuration The surround decoder may not create center- or rear-channel information from nonencoded programs
Unit does not respond to remote commands	<ul style="list-style-type: none"> Weak batteries in remote Wrong device selected Remote sensor is obscured 	<ul style="list-style-type: none"> Change remote batteries Press the DPR selector Make certain that the front-panel sensor is visible to the remote, or connect remote sensor
Intermittent buzzing in tuner	<ul style="list-style-type: none"> Local interference 	<ul style="list-style-type: none"> Move the unit or antenna away from computers, fluorescent lights, motors or other electrical appliances
An UNLOCK message appears in the display and/or the letters in the Channel Indicator display flash at the same time as the audio stops	<ul style="list-style-type: none"> The type of digital audio stream has been changed Digital audio feed paused 	<ul style="list-style-type: none"> Wait a second or two for the unit's processor to recognize the new data stream and automatically resume playback Resume DVD playback.

In addition to the items shown above, additional information on troubleshooting possible problems with your AVR 7300, or installation-related issues, may be found in the list of "Frequently Asked Questions" which is located in the Product Support section of our Web site at www.harmankardon.com.

Processor Reset

In the rare case where the unit's operation or the displays seem abnormal, the cause may involve the erratic operation of the system's memory or microprocessor.

To correct this problem, first unplug the unit from the AC wall outlet and wait at least three minutes. After the pause, reconnect the AC power cord and check the unit's operation. If the system still malfunctions, a system reset may clear the problem.

To clear the AVR 7300's entire system memory including tuner presets, output level settings, delay times and speaker configuration data, first put the unit

in Standby by pressing the **Standby/On Button** **2**. Next, press and hold the **Surround Mode Group Selector** **3** and the **Tuning Mode Selector** **9** buttons for three seconds.

The unit will turn on automatically and display the **RESET** message in the **Upper Display Line** **16**.

NOTE: Resetting the processor will erase any configuration settings you have made for speakers, output levels, surround modes, digital input assignments as well as the tuner presets. After a reset the unit will be returned to the factory presets, and all settings for these items must be reentered.

If the system is still operating incorrectly, there may have been an electronic discharge or severe AC line interference that has corrupted the memory or microprocessor.

If these steps do not solve the problem, consult an authorized Harman Kardon service center.

AVR 7300 TECHNICAL SPECIFICATIONS

Audio Section

Stereo Mode	
Continuous Average Power (FTC)	125 Watts per channel, 20Hz–20kHz, @ <0.07% THD, both channels driven into 8 ohms
Seven-Channel Surround Modes	
Power per Individual Channel	Front L&R channels: 110 Watts per channel @ <0.07% THD, 20Hz–20kHz into 8 ohms Center channel: 110 Watts @ <0.07% THD, 20Hz–20kHz into 8 ohms Surround (L & R Side, L & R back) channels: 110 Watts per channel @ <0.07% THD, 20Hz–20kHz into 8 ohms
High Instantaneous Current Capability (HCC)	±75amps
Input Sensitivity/Impedance	
Linear (High-Level)	200mV/47k ohms
Signal-to-Noise Ratio (IHF-A)	100dB
Frequency Response	
@1w (100dB/–30dB)	10Hz –100kHz
Surround System Adjacent Channel Separation	
Pro Logic I/II/IIX	40dB
Dolby Digital	55dB
DTS	55dB
Transient Intermodulation Distortion (TIM)	Unmeasurable
Slew Rate	40V/4Sec

FM Tuner Section

Frequency Range	87.5–108.0MHz
Usable Sensitivity	IHF 1.3µV/13.2dBf
Signal-to-Noise Ratio	Mono/Stereo 70/68dB
Distortion	Mono/Stereo 0.2/0.3%
Stereo Separation	40dB @ 1kHz
Selectivity	±400kHz, 70dB
Image Rejection	80dB
IF Rejection	90dB

AM Tuner Section

Frequency Range	520–1720kHz
Signal-to-Noise Ratio	45dB
Usable Sensitivity	Loop 500µV
Distortion	1kHz, 50% Mod 0.8%
Selectivity	±10kHz, 30dB

Video Section

Television Format	NTSC
Input Level/Impedance	1Vp-p/75 ohms
Output Level/Impedance	1Vp-p/75 ohms
Video Frequency Response (Composite and S-Video)	10Hz–8MHz (–3dB)
Video Frequency Response (Component Video)	10Hz–100MHz (–3dB)

General

Power Requirement	AC 120V/60Hz
Power Consumption	Standby: 8.9W Idle: 130W Max: 1360W (7 channels driven)
Dimensions	Product
Width	17.3 inches (440mm)
Height	7.6 inches (192mm)
Depth	20.5 inches (520mm)
Weight	55 lb (XX.Xkg) 47 lb (21.4kg)

Depth measurement includes knobs, buttons and terminal connections.
Height measurement includes feet and chassis.
All features and specifications are subject to change without notice.

Harman Kardon, Power for the Digital Revolution and Logic 7 are registered trademarks of Harman International Industries, Incorporated.

IIIIEzSet is a trademark of Harman International Industries, Incorporated (patent no. 5,386,478).

* Trademarks of Dolby Laboratories.

DTS, DTS Surround, DTS-ES and DTS Neo:6 are registered trademarks of Digital Theater Systems, Inc.

VMAX is a registered trademark of Harman International Industries, Incorporated, and is an implementation of Cooper Bauck Transaural Stereo under patent license.

HDCD system manufactured under license from Pacific Microsonics, Inc. This product is covered by one or more of the following: in the USA: 5,479,168; 5,638,074; 5,640,161; 5,808,574; 5,838,274; 5,854,600; 5,864,311; 5,872,531; and in Australia: 669114. Other patents pending.

A-BUS and A-BUS Ready are registered trademarks of Leisure Tech Electronics Pty Ltd Australia.

TIVO is a registered trademark of TIVO, Inc.

Replay TV is a registered trademark of Digital Networks North America, Inc.

Faroudja and DCDi are registered trademarks of Genesis Microchip, Inc.

harman/kardon®

250 Crossways Park Drive, Woodbury, New York 11797
www.harmankardon.com
© 2004 Harman International Industries, Incorporated
Part No. ZKD0501HA00-7