

Operator's Manual

MODEL **PORT I - W25**
(MOBILE PRINTER)

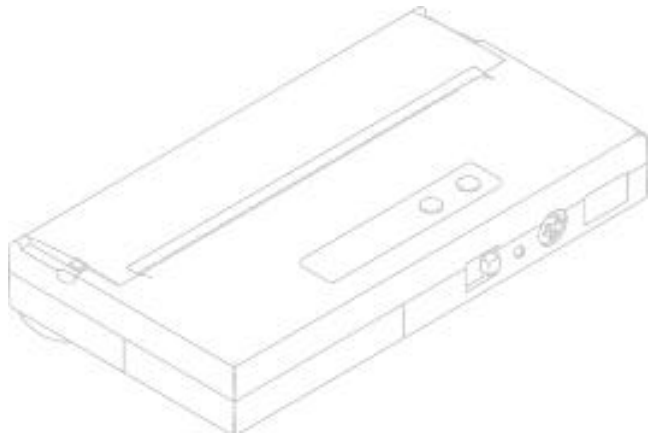

WOOSIM SYSTEM Inc.

#501, Daerung Technotown 3th,
448, Gasan-Dong, GeumChun-Ku,
Seoul, Korea

Tel : +82-2-2107-3700

Fax : +82-2-2107-3707

URL <http://www.woosim.com>

All specifications are subjected to change without notice



<http://www.woosim.com>

Copyright

PORTI-W25 Portable printer user ' s manual.

Copyright 2002 by Woosim System Inc.

All rights reserved.

The information contained in this manual is the property of Woosim System Inc. and may not be reproduced in whole or in part without the prior written permission of Woosim System Inc.

Trademark



a registered trademark of Woosim System Inc.

All other trademark are the properties of their respective companies.

Caution

Some semiconductor devices are easily damaged by static electricity. You should turn the printer " OFF " , before you connect or removed the cable on the rear side, in order to guard the printer against the static electricity.

If the printer is damaged by the static electricity, you should turn the printer " OFF "

Notice

The contents of this manual are subject to change without notice.

FCC CLASS A

FCC COMPLIANCE STATEMENT FOR AMERICAN USERS

This equipment has been tested and found to comply with the limits for a Class A digital device, pursuant to Part 15 of the FCC Rules. These limits are designed to provide reasonable protection against harmful interference when the equipment is operated in a commercial environment.

This equipment generates, uses and can radiate radio frequency energy and if not installed and used in accordance with the instruction manual, may cause harmful interference to radio communications. Operation of this equipment in a residential area is likely to cause harmful interference, in which case the user will be required to correct the interference at his own expense.

FOR CANADIAN USERS

This digital apparatus does not exceed the Class A limits for radio noise emissions from digital apparatus as set out in the radio interference regulations of the Canadian Department of Communications.

Le present appareil numerique n'emet pas de bruits radioelectriques de-
Passant les limites applicables aux appareils numeriques de Class A pre-
Scrites dans le reglement sur le brouillage radioelectrique edicte par le Min-
istere des Communications du Canada



Introduction

The PORTI-W25 mobile printer is suitable designed for use with a growing variety of mobile devices.

IrDA and RS-232C interfaces make the PORTI-W the perfect comrade for Applications such as point of transaction warehousing and distribution, point of sales, hospitality, gaming and healthcare.

The general features of PORTI-W25 printer are as follows:

- ↳ Pocket size (5.43 " x 3.46 " x 0.944 " , 138mm x 88mm x 24mm).
- ↳ Light weight(340g) for true mobility.
- ↳ Very silent printing thru direct thermal printing method.
- ↳ High speed (40mm/sec)
- ↳ High resolution (203dpi, 8dot/mm)
- ↳ IrDA Ver1.0(SIR) and serial interface for maximum flexibility.
- ↳ Easier paper roll loading by CLAMSHELL design.
- ↳ Easier maintenance with self-diagnostic.
- ↳ Microsoft Windows 98/ME/XP/2000 compatible.

☞ Operating Precaution

Please follow the precautions below to enjoy and maintain the full performance of the printer.

↳ Using the Printer

Be careful not to drop or bump the printer on a hard surface.

Do not install the printer in direct sunlight or such areas.

Suitable environment for the use of the printer is as follows :

Operating temperature : 0 ℃ to 40 ℃

Relative humidity : 10% to 80% (No condensation)

Do not install the printer near devices that generate strong electromagnetic fields such as a copy machine.

Do not open the platen cover during printing .

Do not remove or reinstall the communication cable during printing or transmission.

Do not touch the connectors of the communication cable and to close up the Infrared transmitter / receiver during printing.

Switch the POWER OFF when not in use.

Do not use alcohol or other solvent.

The AC adapter, the battery charger and the battery pack may become warm when in use. This is normal and is not a malfunction.

When the battery pack is used at low temperature, the length of time the printer can be used may be shortened.

↳ Thermal Paper Handling

Store the thermal paper in a cool, dry and dark place.

Do not rub the paper with hard object.

Do not leave the paper with hard object.

Do not allow plastic film, erasers, or adhesive tape to touch the paper for long periods.

Do not stack the thermal paper with diazo copies immediately after copying or wet-type copies.

Do not use chemical glue.

Always use the clean thermal paper.

CONTENTS

CHAPTER 1. PREPARATION	9
1.1. Unpacking.....	9
1.2. Outer appearances and parts name	10
1.3. Paper setting	11
1.4. Connecting the cable	14
1.5. Power connection	16
1.6. Recharging the battery pack	18
1.7. Adjustment and setting.....	19
CHAPTER 2. USING THE PRINTER	22
2.1. Control panel	22
2.2. Buttons	22
2.3. Indicator lights	23
2.4. Self test	23
2.5. Driver installation.....	25
CHAPTER 3. TROUBLESHOOTING	28
CHAPTER 4. SPECIFICATIONS	30
CHAPTER 5. CONSUMABLE PARTS	31
5.1. Recommended paper	31
5.2. Printing position	32

CHAPTER 6. PRINTER CONTROL COMMANDS	33
6.1. Print commands	35
6.2. Line spacing commands.....	37
6.3. Characters commands	38
6.4. Panel button commands	45
6.5. Print position commands	46
6.6. Bit-image commands	59
6.7. Status commands	64
6.8. Barcode commands	65
6.9. Macro function commands	69
6.10. Miscellaneous function commands	71
6.11. Line & box commands	74
CHAPTER 7. INTRODUCTION OF PROTOCOL IrDA	75
7.1. Frame structure	75
7.2. Process of printer status inquiry	76
7.3. Process of transmitting and receiving print data	77
7.4. Structure of print data frame	77
7.5. Structure of ENQ frame	79
Appendix80

Chapter 1. PREPARATION

1.1. Unpacking

When unpacking your printer box make sure it contains the printer and all accessories.

If any accessories is missing or damage, please contact your dealer for assistance.



PORT1-W25

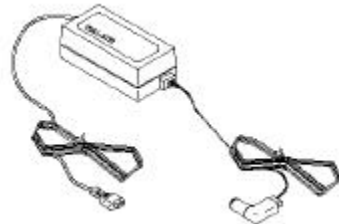

AC adapter for Battery Charge

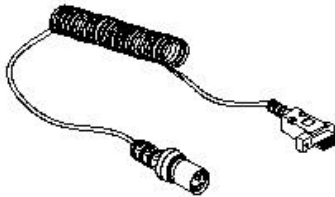

Communication Cable

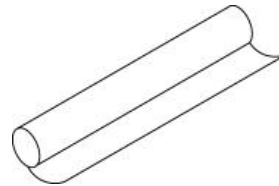

Roll Paper



User ' s Manual



Battery Pack

1.2. Outer appearances and parts name

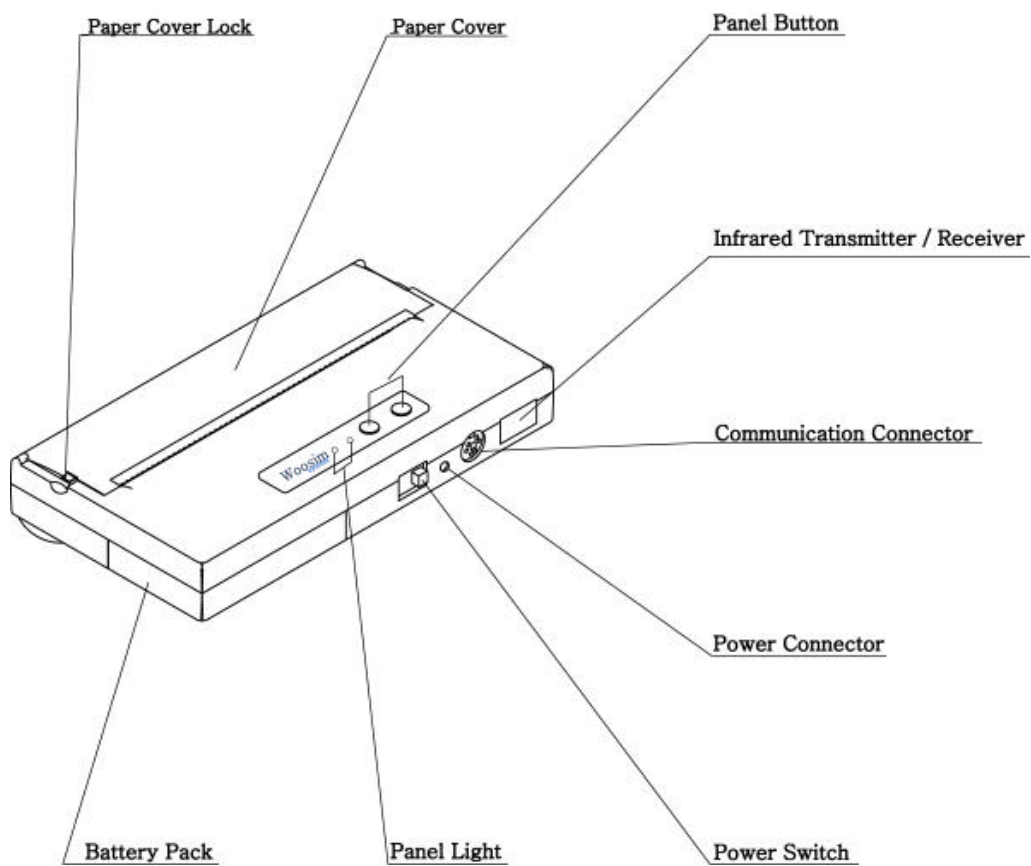

1.3. Paper setting

Installing or replacing the paper roll.

NOTE : Be sure to use paper rolls that meet the specifications.
Do not use paper rolls that have the paper glued to the core because the printer cannot detect the paper end correctly.
Take care not to get your fingers caught in the printer when installing or replacing the paper roll.

- 1) Make sure that the printer is not receiving data; otherwise, data may be lost.
- 2) Open the paper roll cover by applying your finger on both side of printer push it up when the lock is released as shown in the drawing.

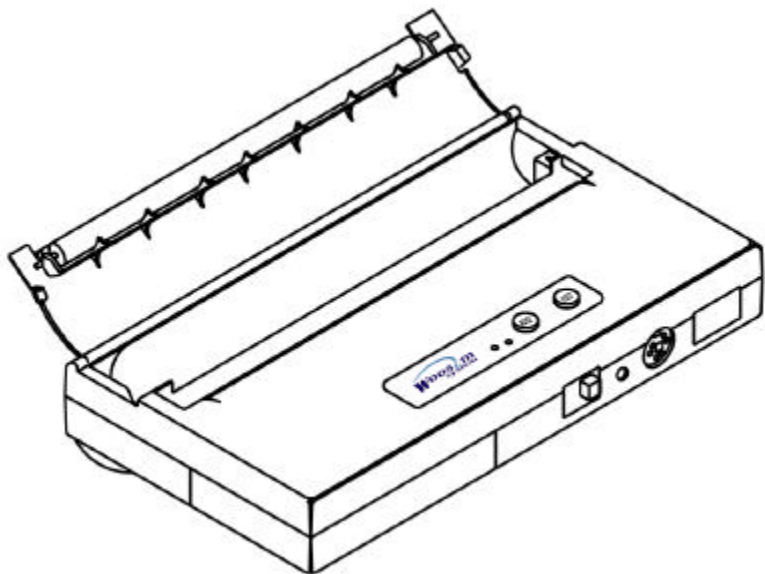

- 3) Remove the used paper roll core if there is one.

- 4) Insert the paper roll. Be sure to note the correct direction that the paper comes off the roll as shown.

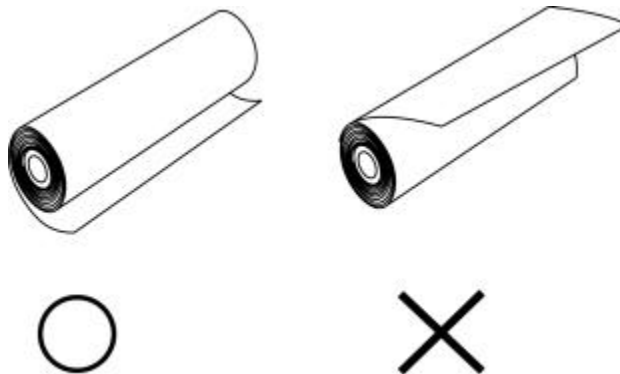
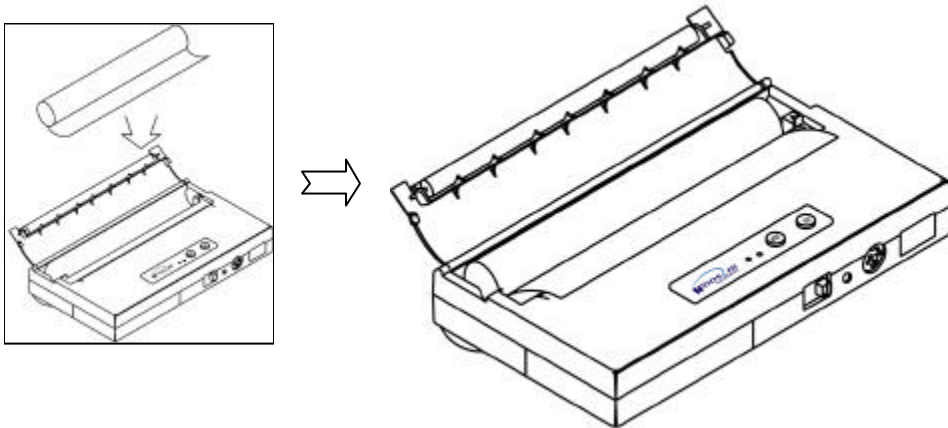

5) Pull out a small amount of paper and then close the cover, as shown.

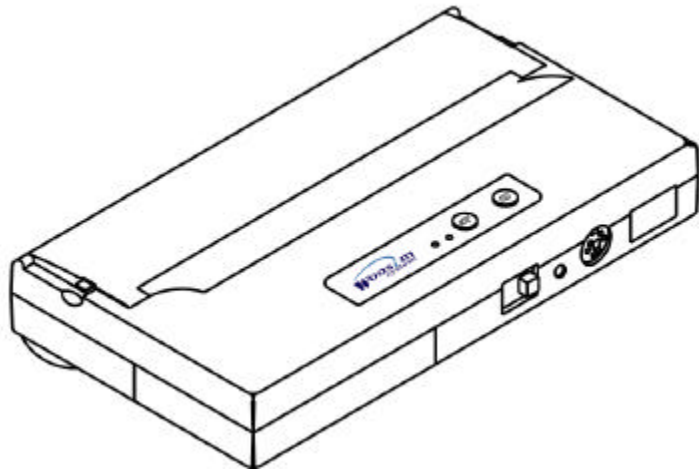

6) Tear off the paper as shown.

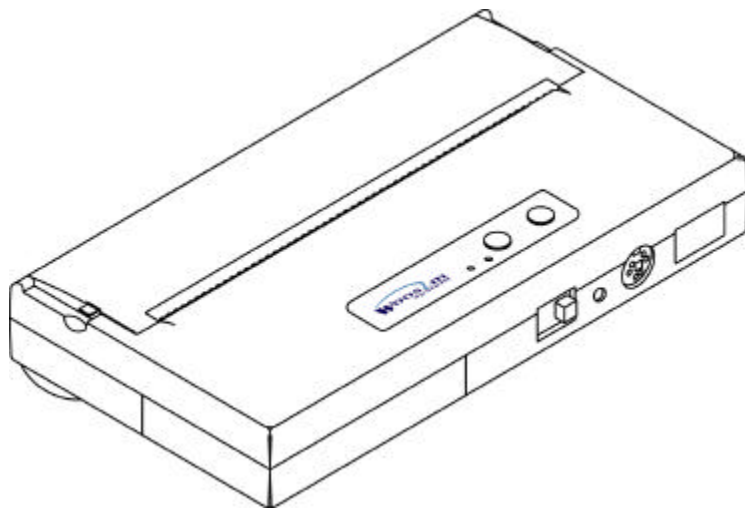

1.4. Connecting the cable

You can connect up to two cables to the printer. It connects to the connector part on the right and front side of the printer, which is shown below.

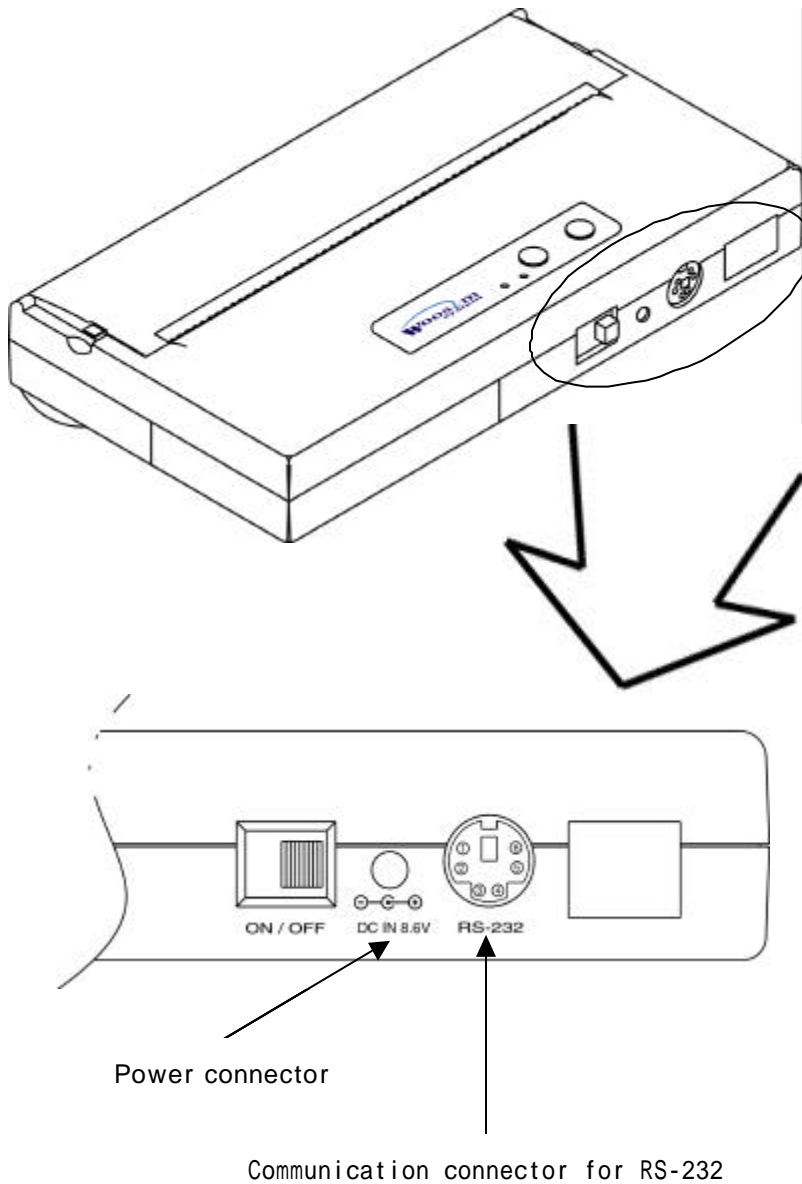

7 Communication Connector Specification

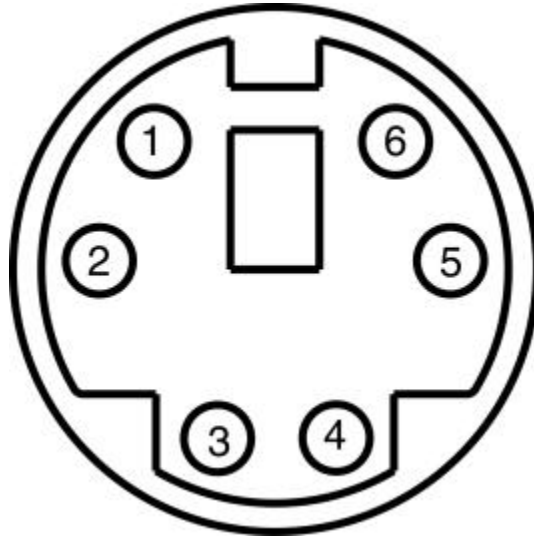

Pin no	Signal Name	Direction	Function
1	GND	-	Ground
2	RTS	Input	Request to send
3	CTS	Output	Clear to send
4	RxD	Input	Receive data
5	NC	-	-
6	TxD	Output	Transmit data

1.5. Power connection

NOTE : Before installing or removing the battery pack, turn the printer power off.

If the Printer is not used for a long time, remove the battery pack from the printer

1) Installing the battery pack

Insert the battery pack in the direction of the arrow at hole.

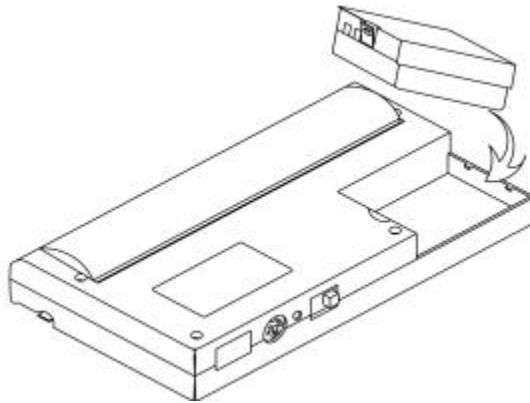

Push the top of the battery pack.

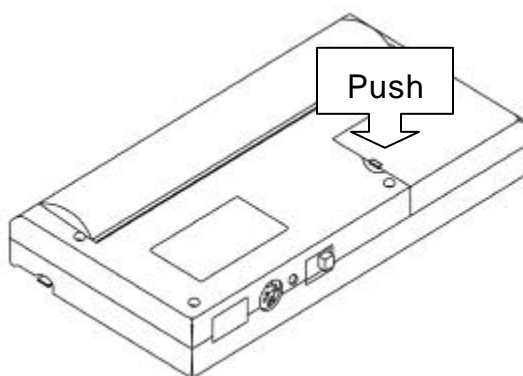

2) Removing the battery pack

Turn the printer power off.

Push the battery pack lock and to lift up the direction of the arrow.

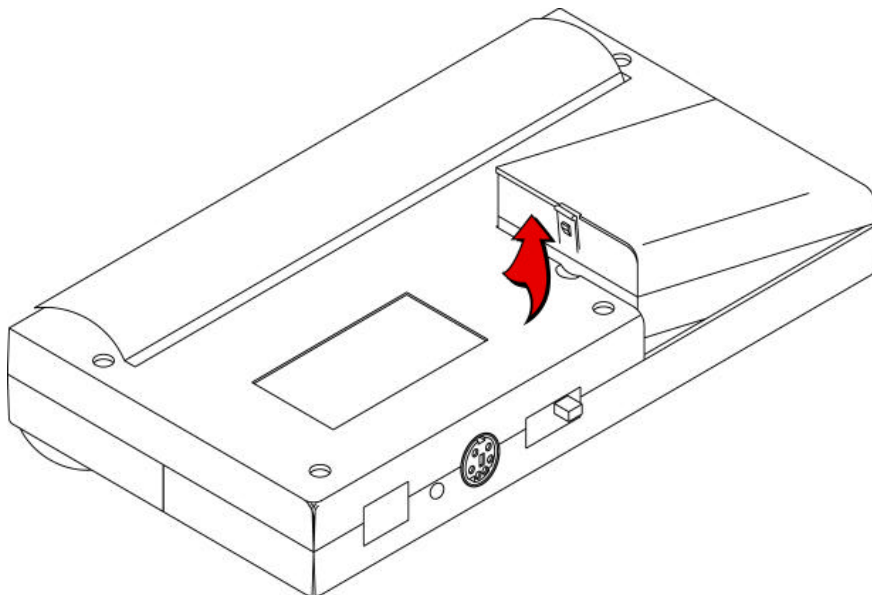
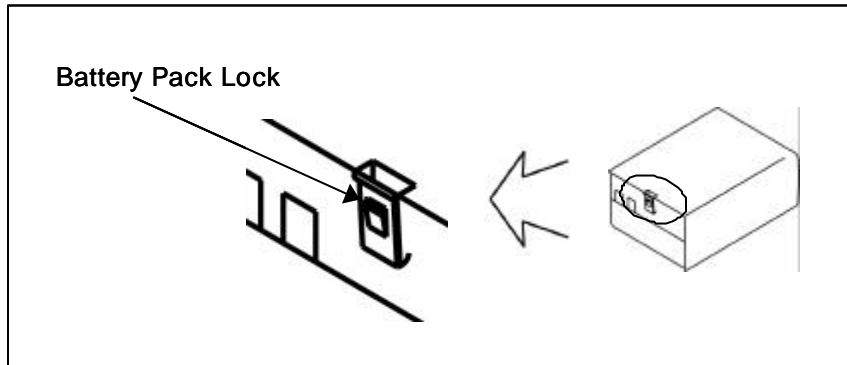

1.6. Recharging the battery pack

For recharging the battery pack, install the battery pack in the printer. Insert the DC jack of the AC adapter to the power connector of the printer.

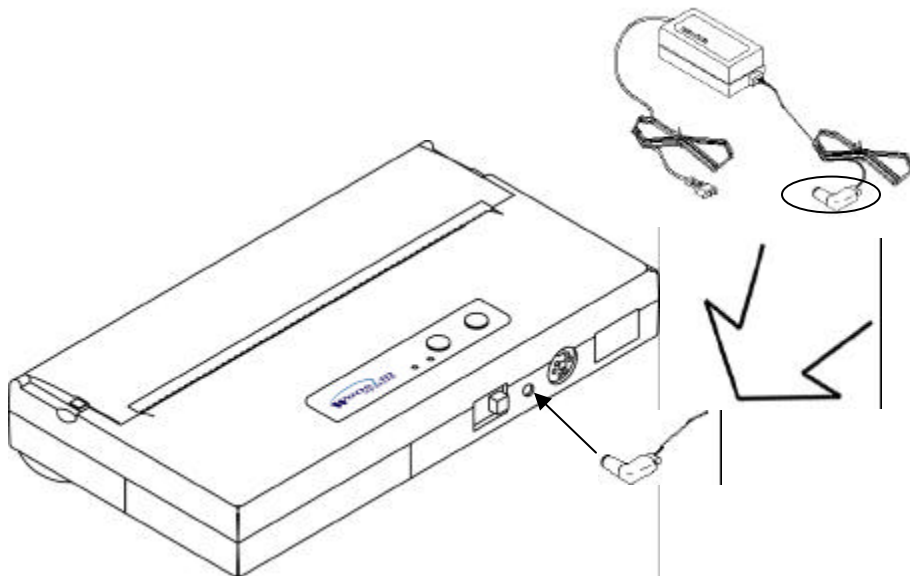

NOTE : Before installing or removing the AC adapter, turn the printer power off.

If the printer is not used for a long time, unplug the AC cable from the printer and outlet.

Do not remove the battery during charging.

Remove the communication cable from the connector during charging.

The recharging time depends on the voltage level and the ambient temperature of the battery pack. Normally, it takes about 4 to 5 hours to recharge a battery pack.

1.7. Adjustment and setting

1. Press the MODE Button until the **Error Lamp** twinkles 5 times
2. Change the mode and option using the MODE Button according to the MODE (Table1)

~~⚠~~ MODE button : use for changing OPTION status. (**Error Lamp**)

~~⚠~~ FEED button : use for changing MODE status. (**Power Lamp**)

Ex) The defaults of the printer are : RS-232C/ 1,200 bps/
8 data bit/ No parity/ Density Low

If a user wants to modify the defaults with Protocol IrDA/
9,600 bps/ 7 data bit/ even parity/ density high

↴ Press MODE Button until **Error Lamp** twinkles 5 times
and release the button

? You will see the **Power Lamp** twinkles one time and the
Error Lamp twinkles 1 time

? Press the MODE Button one time and the **Error Lamp** twinkles
twice

(The interface mode has set to Protocol IrDA mode)

↴ Press FEED button one time, **Power Lamp** twinkles twice and
Error Lamp twinkles 4 times

? Press MODE Button one time, **Error Lamp** twinkles 5 times
and press the MODE Button one more time, the **Error Lamp**
twinkles 6 times

(The baud rate has set to 38,400 bps)

- ↴ Press FEED Button one time, Power Lamp twinkles 3 times and Error Lamp twinkles 2 times
 - ? Press MODE Button one time, Error Lamp twinkles one time (The Data Bit has set to 7 data bit)

- ↴ Press FEED Button one time, Power Lamp twinkles 4 times and Error Lamp twinkles 1 time.
 - ? Press MODE Button one time, Error Lamp twinkles 2 times (The Parity bit has set to even parity bit)

- ↴ Press FEED Button one time, Power Lamp twinkles 5 times and Error Lamp twinkles 1 time
 - ? Press MODE Button one time, Error Lamp twinkles 2 times after then press MODE Button again, the Error Lamp will twinkle 3 times
(The density has set to High)

If all the mode have set, press the MODE Button and the FEED Button at the same time after then release the buttons at the same time.

The printer will print out the mode status which has modified.
(PROTOCOL IrDA/ 38,400 BAUD/ 7 DATA BIT/ EVEN PARITY/ DENSITY HIGH)

If the status is not correct, please try it again according to the procedure.

MODE	POWER Lamp (Green)	MODE Lamp (Red)	Option
Communication Port	1	1	RS-232C
		2	Protocol IrDA
		3	Standard IrDA
Baud Rate	2	1	1200 bps
		2	2400 bps
		3	4800 bps
		4	9600 bps
		5	19200 bps
		6	38400 bps
		7	57600 bps
		8	9600 bps
Data Bit	3	1	7 Data bit
		2	8 Data bit
Parity Bit	4	1	No Parity
		2	Even Parity
		3	Odd Parity
Density	5	1	Density Low
		2	Density Medium
		3	Density High
Not used	6	1	Not used
		2	Not used

Table 1-

Chapter 2. USING THE PRINTER

2.1. Control panel

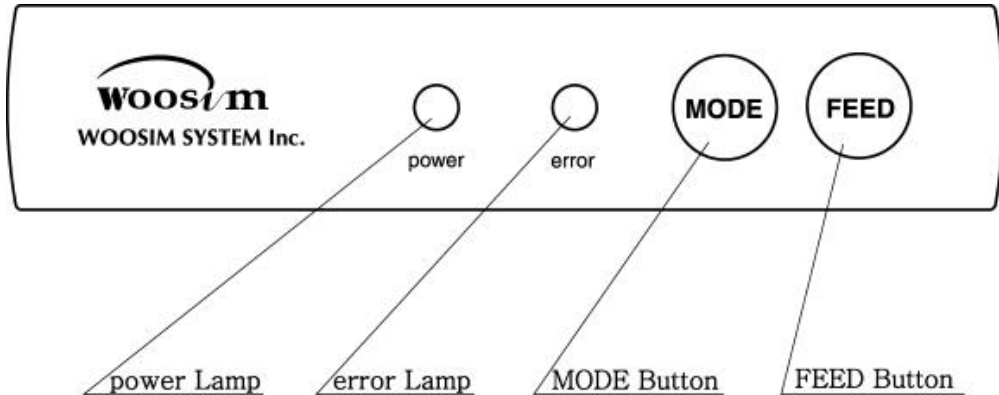

2.2. Buttons

1) MODE Button

MODE Button is for use to change communication mode.

(Refer to 1.7. ADJUSTMENT AND SETTING for details about mode conversion)

If you want to set to RS-232C Mode, just connect the communication cable to connector of the printer and then the mode will be changed automatically.

2) FEED Button

Press the FEED Button once to advance paper one line. You can also hold down the FEED Button to feed paper continuously.

2.3. Indicator lights

1) power Lamp

The power Lamp is on whenever the printer is on or mode conversion. But when the battery is almost exhausted, this Lamp flashes with red color occasionally.

In this case, you must recharge the battery by using the AC adapter.

2) error Lamp

This Lamp indicates an error such as paper end, or cover open, mode conversion etc.

2.4. Self test

The Self-Test checks whether the printer has any problems. If the printer does not function properly, contact your dealer. For Self-Test, turn on the power while holding down the FEED Button. The Self-Test checks the following :

- 1) Make sure paper roll has been installed properly.
- 2) The Self-Test prints the current printer status, which provides the control ROM version and the communication method setting.
- 3) After printing the current printer status, Self-Test will print a pattern using the built-in character set.
- 4) The Self-Test automatically ends.

The printer is ready to receive data as soon as it complete the Self-Test.

** PORTI-M25 (Battery) **
PRINTER STATUS
[Ver 2.0AK 2002/08/10]

MODE = STANDARD IRDA
SERIAL = 57600 BAUD
8 DATA BIT
NO PARITY
1 STOP BIT
DENSITY = HIGH

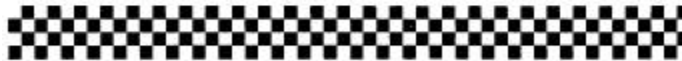

0123456789;<=>?@ABCDEFGHIJKLMN0PQRSTUVWXYZ[\]^_`abcdefghijklmnop
123456789;<=>?@ABCDEFGHIJKLMN0PQRSTUVWXYZ[\]^_`abcdefghijklmnop
23456789;<=>?@ABCDEFGHIJKLMN0PQRSTUVWXYZ[\]^_`abcdefghijklmnop
3456789;<=>?@ABCDEFGHIJKLMN0PQRSTUVWXYZ[\]^_`abcdefghijklmnop
456789;<=>?@ABCDEFGHIJKLMN0PQRSTUVWXYZ[\]^_`abcdefghijklmnop
56789;<=>?@ABCDEFGHIJKLMN0PQRSTUVWXYZ[\]^_`abcdefghijklmnop
6789;<=>?@ABCDEFGHIJKLMN0PQRSTUVWXYZ[\]^_`abcdefghijklmnop
789;<=>?@ABCDEFGHIJKLMN0PQRSTUVWXYZ[\]^_`abcdefghijklmnop
89;<=>?@ABCDEFGHIJKLMN0PQRSTUVWXYZ[\]^_`abcdefghijklmnop
9;<=>?@ABCDEFGHIJKLMN0PQRSTUVWXYZ[\]^_`abcdefghijklmnop
;<=>?@ABCDEFGHIJKLMN0PQRSTUVWXYZ[\]^_`abcdefghijklmnop
;<=>?@ABCDEFGHIJKLMN0PQRSTUVWXYZ[\]^_`abcdefghijklmnop
;<=>?@ABCDEFGHIJKLMN0PQRSTUVWXYZ[\]^_`abcdefghijklmnop
;<=>?@ABCDEFGHIJKLMN0PQRSTUVWXYZ[\]^_`abcdefghijklmnop
;<=>?@ABCDEFGHIJKLMN0PQRSTUVWXYZ[\]^_`abcdefghijklmnop
=>?@ABCDEFGHIJKLMN0PQRSTUVWXYZ[\]^_`abcdefghijklmnop

Sample of Self-Test

2.5. Driver installation

The driver installation instruction were written for the printer to be used with the Infrared port and serial port(RS -232C).

Make sure that your PC has built-in infrared device(IrDA Ver1.0).

Printer driver can download by Internet(<http://www.woosim.com>).

Installing the PORTI-W Printer Driver on Windows 98/ME/2000/XP.

1) You must install new driver after deleting old driver.

- Delete the old driver
- Reboot the computer

* If there is not any installed driver, you can install new driver immediately.

2) Run the setup.exe

Press the "Next" after checking the supported Operating System.

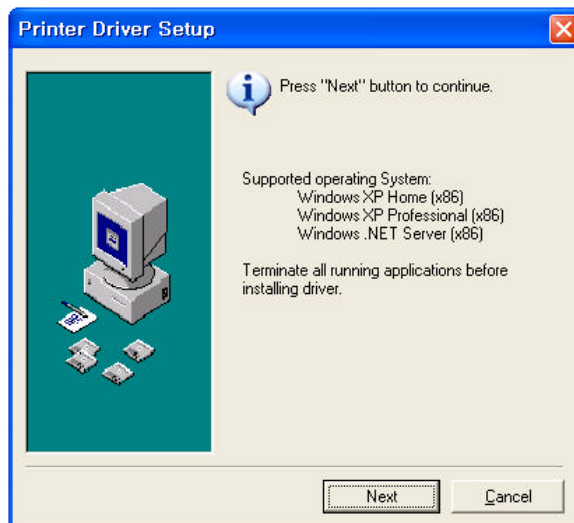

3) Select printer model to install, and press “Next”.

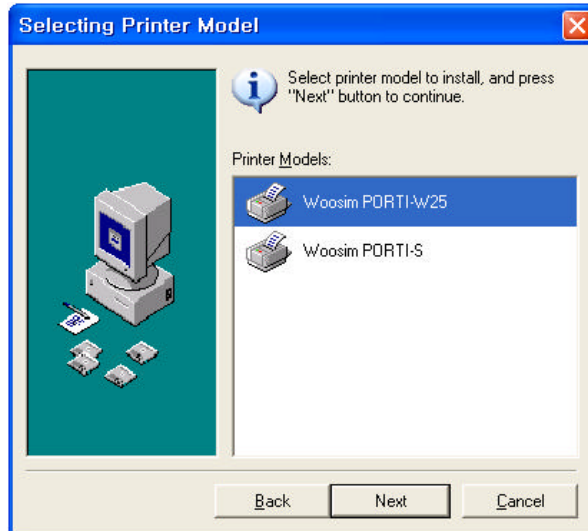

4) Select the port connected to printer, and press “Next”

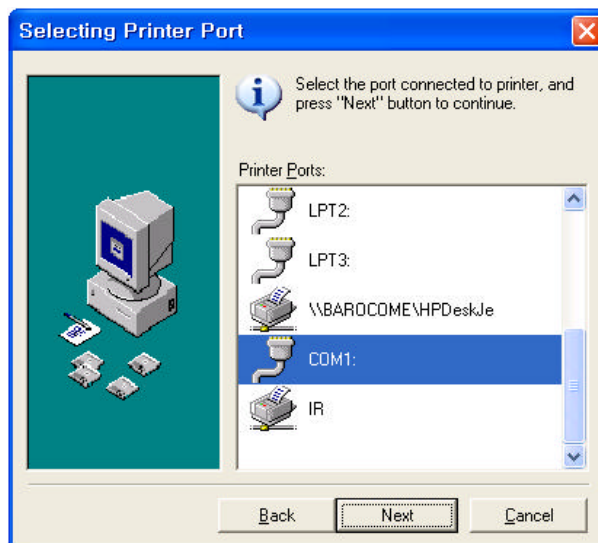

5) If the installation has done successfully, press “OK”.

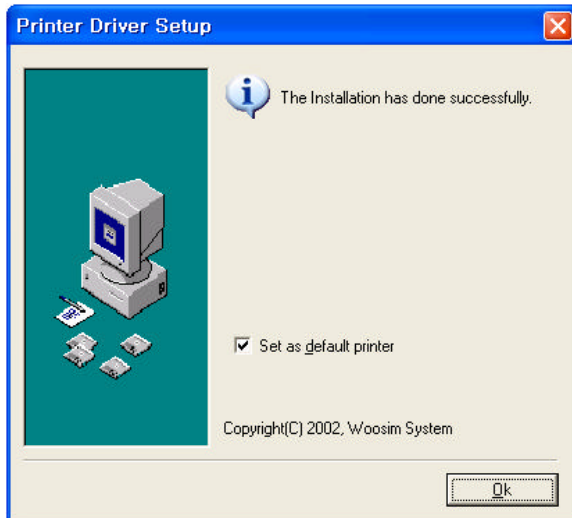

Chapter 3. TROUBLESHOOTING

Check the following points before you make a request for repair.

↴ The power does not turn on.

AC adapter or battery pack being used?

AC cable and AC adapter or batter pack is connected.

AC adapter is connected to the printer correctly?

Battery pack is fully recharged?

↴ The printer does not print.

Interface cable is connected correctly?

Interface cable that meets the Communication Connector specification list on page 15 of the Operator ' s Manual being used?

IrDA transmission status is good? (To closeup between Infrared Transmitter / Receiver and the host computer?)

Transmission conditions of the host computer is correct?
(IrDA port is activated and set-up correctly?)

Paper is not inserted?

Paper orientation(top/bottom) is correct?

⌄ error Lamp of the power Lamp is blinks.

Paper end or cover open ?

Battery is almost exhausted? (Recharge the battery by using the power supply.)

⌄ The battery pack is not installed.

Battery pack correctly oriented?

Correct battery pack being used?

Battery pack case damaged?

⌄ The battery runs out soon even if recharged.

Battery been recharged correctly?

If the battery is recharged correctly, but does not take a long time, it is almost dead. Replace it with a new one.

Chapter 4. SPECIFICATIONS

Printing method	Direct thermal line printing	
Characters per line	80cpl	
Character size	9 * 24dots, 16 * 24dots(Korean character)	
Resolution	203dpi, 8dots/mm	
Print width	4-inch (104mm, 832dots)	
Printing speed	40mm / sec	
Dimensions	138 * 88 * 24 mm (Standard model)	
Weight	340g	
Interface	Serial(RS-232C), IrDA Ver1.0 (SIR) (Standard model)	
Paper supplied	Thermal roll paper (118mm wide, 25 ϕ)	
Barcode supplied	PDF417(2-dimension), Code128, Code39, I2/5, Code93 UPC, EAN, KAN, JAN, CODABAR	
Receive buffer size	10K bytes	
Note	Printing speed may be slower, depending on the data transmission speed and the combination of control commands.	
Battery	Rechargeable 7.2V DC 1.4A(Li-ion)	
Battery duration	1 hour continuous printing	
AC adapter	Input (85~240V AC 50~60Hz) Output(8.6V DC), 4hours full charge time	
Environment conditions	Temperature	0 ℃ - 40 ℃ (operating) -10 ℃ - 50 ℃ (storage)
	Humidity	30% - 80% (operating) 10% - 90% (storage)
MCBF	Mechanical	37,000,000 lines
	Head	Approximately 50 Km

Chapter 5. CONSUMABLE PARTS

5.1. Recommended paper

Type	: Thermal Paper
Paper width	: 118mm
Paper thickness	: 70 ± 5 Mm
Outer diameter	: $\varnothing 25$ mm or less
Recording side	: Outside of roll

Cautions :

1. Do not paste the paper to the core, and the roll paper which has near end mark printing on its near end is recommended.
2. Chemicals or oil may change the color of paper, or printed characters may fade.
3. Change of paper color starts from approx. 70 C. Pay attention to heat, humidity and sun light.
4. Color of paper may be changed by being scratched by nail or hard metal, etc.

5.2. Printing position

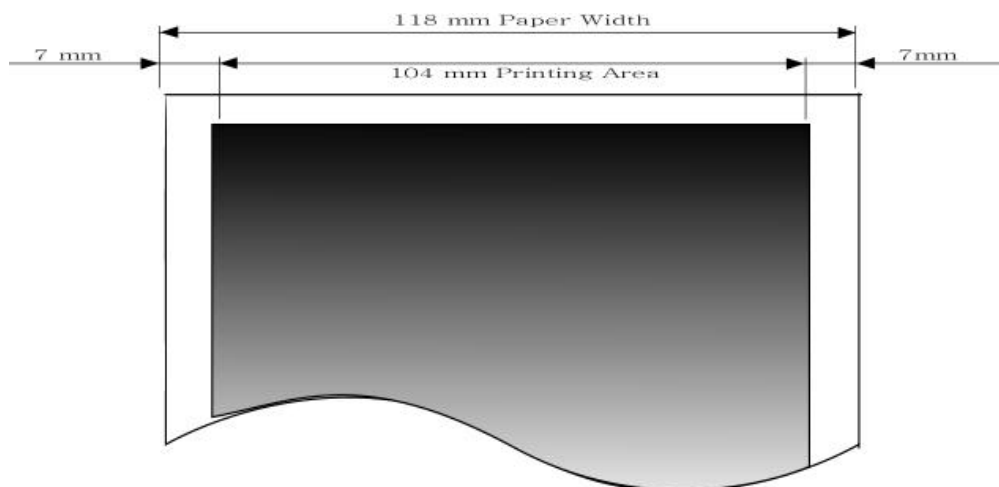

Chapter 6. Printer control function

Supported Commands List

<i>Command</i>	<i>Name</i>	<i>Function Type</i>	<i>Page</i>
<i>HT</i>	Horizontal tab	Print position	49
<i>LF</i>	Print and line feed	Print	35
<i>FF</i>	Print and return to standard mode	Print	36
<i>ESC FF</i>	Print data in page mode	Print	36
<i>ESC SP</i>	Set right-side character spacing	Character	39
<i>ESC !</i>	Select print mode	Character	40
<i>ESC \$</i>	Set absolute print position	Print position	46
<i>ESC *</i>	Select bit-image mode	Bit image	59
<i>ESC -</i>	Turn underline mode on/off	Character	41
<i>ESC 2</i>	Select default line spacing	Line spacing	37
<i>ESC 3</i>	Set line spacing	Line spacing	37
<i>ESC @</i>	Initialize printer	Miscellaneous function	72
<i>ESC D</i>	Set horizontal tab positions	Print position	50
<i>ESC E</i>	Turn emphasized mode on/off	Character	42
<i>ESC J</i>	Print and feed paper	Print	35
<i>ESC L</i>	Select page mode	Miscellaneous function	72
<i>ESC O</i>	Set print starting position.	Print position	58
<i>ESC R</i>	Select an international character set	Character	39
<i>ESC S</i>	Select standard mode	Miscellaneous function	73

<i>Command</i>	<i>Name</i>	<i>Function Type</i>	<i>Page</i>
ESC T	Select print direction in page mode	Print position	55
ESC W	Set printing area in page mode	Print position	53
ESC X 4	Define user-defined bit-image	Bit image	62
ESC \	Set relative print position	Print position	47
ESC Z	Print 2D barcode	Barcode	68
ESC a	Select justification	Print position	48
ESC c 5	Enable/disable panel buttons	Panel button	45
ESC d	Print and feed n lines	Print	36
ESC v	Transmit paper sensor status	Status	64
ESC {	Turn upside-down printing mode on/off	Character	42
GS !	Select characters size	Character	43
GS \$	Set absolute vertical print position in page mode	Print position	56
GS :	Start/end macro definition	Macro function	69
GS B	Turn white/black reverse printing mode On/off	Character	44
GS H	Select printing position of HRI characters	Barcode	68
GS L	Set left margin	Print position	51
GS P	Set horizontal and vertical motion units	Miscellaneous function	71
GS W	Set printing area width	Print position	52
GS i	Print box & line in page mode	Box & line command	74
GS \	Set relative vertical print position in page mode	Print position	57
GS ^	Execute macro	Macro function	70
GS h	Set barcode height	Barcode	65
GS k	Print bar code	Barcode	66
GS w	Set barcode width	Barcode	65

6.1. Print Command

The **PORTI-W25** supports the following commands for printing character and advancing paper:

Command	Name
LF	Print and line feed
ESC J	Print and feed paper
ESC d	Print and feed n lines
FF	Print and return to standard mode(in page mode)
ESC FF	Print data in page mode

LF

[Name]	Print and line feed
[Format]	ASCII LF HEX 0A Decimal 10
[Description]	Print the data in the print buffer and feeds one line based on the current line spacing.
[Note]	This command sets the print position to the beginning of the line.
[Reference]	ESC 2, ESC 3

ESC J n

[Name]	Print and feed paper.
[Format]	ASCII ESC J n HEX 1B 4A n Decimal 27 74 n
[Range]	0 n 255
[Description]	Prints the data in the print buffer and feeds the paper [n x (vertical or horizontal motion unit)] inches.

ESC d n

[Name]	Print and feed n lines			
[Format]	ASCII	ESC	d	n
	HEX	1B	64	n
	Decimal	27	100	n
[Range]	0	n	255	
[Description]	Prints the data in the print buffer and feeds n lines.			
[Note]	1) This command sets the print starting position to the beginning of the line. 2) This command does not affect the line spacing set by ESC 2 or ESC 3.			
[Reference]	ESC 2, ESC 3			

FF

[Name]	Print and return to standard mode in page mode.		
[Format]	ASCII	FF	
	HEX	0C	
	Decimal	12	
[Description]	Prints the data in the print buffer collectively and returns to standard mode.		
[Note]	1) The buffer data is deleted after being printed. 2) The Printing area set by ESC W is reset to the default setting. 3) This command sets the print position to the beginning of the line. 4) This command is enabled only in page mode.		
[Reference]	ESC FF, ESC L, ESC S		

ESC FF

[Name]	Print data in page mode.		
[Format]	ASCII	ESC	FF
	HEX	1B	0C
	Decimal	27	12
[Description]	In page mode, prints all buffered data in the printing area collectively.		
[Note]	This commands is enabled only in page mode. After printing the printer does not clear the buffered data, setting values for ESC T and ESC W, and the position for buffering.		
[Reference]	FF, ESC L, ESC S		

6.2. Line Spacing Command

The **PORTI-W25** supports the following commands for setting line spacing. These commands only set the line spacing; they do not actually advance the paper. The line spacing set using these commands affects the results of **LF** and **ESC d** and paper feeding by using the **FEED** button.

Command	Name
ESC 2	Select default line spacing
ESC 3	Set line spacing

ESC 2

[Name]	Select default line spacing
[Format]	ASCII ESC 2
	HEX 1B 32
	Decimal 27 50
[Description]	Selects 1/7 inch line (approximately 3.75mm) spacing.
[Note]	The line spacing can be set independently in standard mode and in page mode.
[Reference]	ESC 3

ESC 3 n

[Name]	Set line spacing
[Format]	ASCII ESC 3 n
	HEX 1B 33 n
	Decimal 27 51 n
[Range]	0 n 255
[Description]	Sets the line spacing to [n x vertical or horizontal motion until] inches.
[Note]	1) The line spacing can be set independently in standard mode and in page mode. 2) The horizontal and vertical motion unit are specified by GSP. Changing the horizontal or vertical motion unit does not affect the current line spacing.

3) The GS P command can change the horizontal (and vertical) motion unit.

However, the value cannot be less than the minimum vertical movement amount, and it must be in even units of the minimum vertical movement amount.

4) In standard mode, the vertical motion unit (y) is used.

5) In page mode, this command functions as follows, depending on the starting position of the printable area:

When the starting position is set to the upper left or lower right of the printable area using ESC T, the vertical motion unit(y) is used. When the starting position is set to the upper right or lower left of the printable area using ESC T, the horizontal motion unit(x) is used.

[Reference]

ESC 2, GS P

6.3. Character Commands

The PORTI-W25 supports the following commands for setting character font and size:

Command	Name
ESC SP	Set right-side character spacing
ESC R	Select an international character set
ESC !	Select print mode
ESC -	Turn underline mode on/off
ESC E	Turn emphasized mode on/off
ESC G	Turn double-strike mode on/off
ESC {	Turn upside-down
GS !	Select character size
GS B	Turn white/black reverse printing mode on/off

ESC SP n

[Name]	Set right-side character spacing.			
[Format]	ASCII	ESC	SP	n
	HEX	1B	20	n
	Decimal	27	32	n
[Range]	0	n	255	
[Description]	Sets the character spacing for the right side of the character to [n x horizontal or vertical motion units] inches.			
[Note]	1) The right side character spacing for double-width mode is twice the normal value. When characters are enlarged, the right side character spacing is n times normal value. 2) This command sets values independently in each mode. 3) The horizontal and vertical motion unit are specified by GS P. Changing the horizontal or vertical motion unit does not affect the current right-side spacing. 4) The maximum right side spacing is 255/180 inches, Any setting exceeding the maximum is converted to the maximum automatically.			
[Default]	n = 0			
[Reference]	GS P			

ESC R n

[Name]	Select an international character set.			
[Format]	ASCII	ESC	R	n
	HEX	1B	52	n
	Decimal	27	82	n
[Range]	0	n	10	
[Description]	Selects an international character set n from the following table.			

n	Character set	n	Character set
0	U.S.A	6	Sweden
1	France	7	Italy
2	Germany	8	Spain
3	U.K	9	Norway
4	Denmark	10	Denmark II

[Default] n = 0

ESC ! n

[Name] Select print mode.

[Format] ASCII ESC ! n
 HEX 1B 21 n
 Decimal 27 33 n

[Range] 0 n 255

[Description] Select print mode(s) using n as follows,.

Bit	Off / On	Hex	Decimal	Function
0	Off	00	0	Character font A (12 x 24)
	On	01	1	Character font B (9 x 24)
1	Off	-	-	Undefined
	On	-	-	Undefined
2	Off	-	-	Undefined
	On	-	-	Undefined
3	Off	00		Emphasized mode not selected
	On	10		Emphasized mode selected
4	Off	00		Double-height mode not selected
	On	20		Double-height mode selected
5	Off	00		Double-width mode not selected
	On	20		Double-width mode selected
6	Off	-	-	Undefined
	On	-	-	Undefined
7	Off	00	0	Underline mode not selected
	On	80	128	Underline mode selected

- [Note]
- 1) When both double-height and double-width modes are selected, quadruple size characters are printed.
 - 2) The printer can underline all characters, but can not underline the space set by **HT**.
 - 3) The thickness of the underline is that selected by ESC -, regardless of the character size.
 - 4) When some characters in a line are double or mode height, all the characters on the line are aligned at the baseline.
 - 5) ESC - can also turn on or off underline mode. However, the setting of the last received command is effective.
 - 7) GS ! can also select character size. However, the setting of the last received command is effective.

[Reference] **ESC -, ESC E, GS!**

ESC - n

- [Name] Turn underline mode on/off
- [Format]
- | | | | |
|---------|-----|----|---|
| ASCII | ESC | - | n |
| HEX | 1B | 2D | n |
| Decimal | 27 | 45 | n |
- [Range] 0 n 1
- [Description] Turns underline mode on or off, based on the following values of n;

n	Function
0, 48	Turns off underline mode
1. 49	Turns on underline mode (1 dot thick).
2, 50	Turns on underline mode (2 dot thick)

- [Notes]
- 1) The printer can underline all characters (including right-side character spacing), but cannot underline the space set by HT.
 - 2) The printer cannot underline white/black inverted characters.
 - 3) When underline mode is turned off by setting the value of n to 0 or 48, the

following data is not underlined, and the underline thickness set before the mode is turned off does not change. The default underline thickness is 1 dot.

4) Changing the character size does not affect the current underline thickness.

5) Underline mode can also be turned on or off by using ESC !.

Note, however, that the last received command is effective.

[Default] n = 0

[Reference] **ESC !**

ESC E n

[Name] Turn emphasized mode On/Off.

[Format]	ASCII	ESC	E	n
	HEX	1B	45	n
	Decimal	27	69	n

[Range] 0 n 255

[Description] Turns emphasized mode on of off.

When the LSB(least significant bit) is 0, emphasized mode is turned off.

When the LSB(least significant bit) is 1, emphasized mode is turned on.

[Note] 1) Only the least significant bit of n is enabled.

2) This command and ESC ! turn on and off emphasized mode in the same way. Be careful when this command is used with ESC !

[Default] n = 0

[Reference] **ESC !**

ESC { n

[Name] Turn On/Off upside-down printing mode

[Format]	ASCII	ESC	{	n
	HEX	1B	7B	n
	Decimal	27	123	n

[Range] 0 n 255

[Description] Turns upside-down printing mode on of off

When the LSB is 0, upside-down mode is turned off.

When the LSB is 1, upside-down mode is turned on.

[Note]

- 1) Only the lowest significant bit of n is valid.
- 2) This command is enabled only when processed at the beginning of a line in standard mode.
- 3) When this command is input in page mode, the printer performs only internal flag operations.
- 4) This command does not affect printing in page mode.
- 5) In upside-down printing mode, the printer rotates the line to be printed by 180 degree and then prints it.

[Default] n = 0

[Example]



GS ! n

[Name] Select character size

[Format] ASCII GS ! n
HEX 1D 21 n
Decimal 29 33 n

[Range] 0 n 255

[Description] (1 vertical number of times 8, 1 horizontal number of times 8)
Selects the character width using bits 0 to 2 and selects the character height using bits 4 to 7, as follows;

Hex	Decimal	Width
00	0	1 (normal)
01	1	2 (double width)
02	2	3
03	3	4
04	4	5
05	5	6
06	6	7
07	7	8

Character Width Selection

Hex	Decimal	Height
00	0	1 (normal)
10	16	2 (double height)
20	32	3
30	48	4
40	64	5
50	80	6
60	96	7
70	112	8

Character Height Selection

- [Notes]
- 1) This command is all characters effective
 - 2) If n is outside of the defined range, this command is ignored.
 - 3) In standard mode, the vertical direction is the paper feed direction, and the horizontal direction is perpendicular to the paper feed direction.
 - 4) In page mode, vertical and horizontal directions are based on the character orientation.
 - 5) When characters are enlarged with different sizes on one line, all the characters on the line are aligned at the baseline.
 - 6) The ESC ! command can also turn double width and double height modes on or off.

[Default] n = 0

[Reference] **ESC !**

GS B n

[Name] Turn white/black reverse printing mode On/Off.

[Format] ASCII GS B n
 HEX 1D 42 n
 Decimal 29 66 n

[Range] 0 n 255

[Description] Turns on or off White/Black reverse printing mode.

- [Notes]
- 1) When the LSB is 0, white/black reverse printing mode is turned on.
 - 2) When the LSB is 1, white/black reverse printing mode is turned off.
 - 3) Only the lowest bit of n is valid.
 - 4) This command is available for built in characters and user defined characters.
 - 5) When white/black reverse printing mode is on, it also applied to character spacing set by ESC SP.
 - 6) This command does not affect the space between lines.
 - 7) White/black reverse mode has a higher priority than underline mode. Even if underline mode is on, it is disabled (but not canceled) when white/black reverse mode is selected.

[Default] n = 0

6.4. Panel Button Command

The **PORTI-W25** supports the following command for enabling and disabling the panel button.

Command	Name
ESC c 5	Enable/disable panel buttons

ESC c 5 n

[Name]	Enable/Disable panel buttons				
[Format]	ASCII	ESC	c	5	n
	HEX	1B	63	35	n
	Decimal	27	97	53	n
[Range]	0	n	255		
[Description]	Enables or disables the panel buttons.				
	When the LSB is 0, the panel buttons are enabled.				
	When the LSB is 1, the panel buttons are disabled.				
[Notes]	1) Only the least significant bit of n is valid.				

- 2) When the panel buttons are disabled, none of them are usable when the printer cover is closed.
- 3) In this printer, the panel buttons is the FEED button.
- 4) In the macro ready mode, the FEED button are enabled regardless of the settings of this command; however, the paper cannot be fed by using these buttons.

[Default] n = 0

6.5. Print Position Commands

The **PORTI-W25** supports the following commands for setting the print position

Command	Name
ESC \$	Set absolute print position
ESC \	Set relative print position
ESC a	Select justification
HT	Horizontal tab
ESC D	Set horizontal tab positions
GS L	Set left margin
GS W	Set printing area width
ESC W	Set printing area in page mode
ESC T	Select print direction in page mode
GS \$	Set absolute vertical print position in page mode
GS \	Set relative vertical print position in page mode
ESC O	Set print starting position.

ESC \$ nL nH

[Name]	Set absolute print position				
[Format]	ASCII	ESC	\$	nL	nH
	HEX	1B	24	nL	nH
	Decimal	27	36	nL	nH
[Range]	0	nL	255		
	0	nH	255		

[Description]	Set the distance from the beginning of the line to the position at which subsequent characters are to be printed.
[Notes]	<p>1) The distance from the beginning of the line to the print position is [(nL + nH x 256) x (vertical or horizontal motion unit)] inches.</p> <p>2) Setting outside the specified printable area are ignored.</p> <p>3) The horizontal and vertical motion unit are specified by GS P.</p> <p>4) The GS P command can change the horizontal (and vertical) motion unit. However, the value cannot be less than the minimum horizontal movement amount, and it must be in even units of the minimum horizontal movement amount.</p> <p>5) In standard mode, the horizontal motion unit (x) is used.</p> <p>6) In page mode, horizontal or vertical motion unit differs depending on the starting position of the printable area as follows;</p> <ol style="list-style-type: none"> 1. When the starting position is set to the upper left or lower right of the printable area using ESC T, the horizontal motion unit (x) is used. 2. When the starting position is set to the upper right or lower left of the printable area using ESC T, the vertical motion unit (y) is used.
[Reference]	ESC\, GS\$, GS\, GS P

ESC \ nL nH

[Name]	Set relative print position				
[Format]	ASCII	ESC	\	nL	nH
	HEX	1B	5C	nL	nH
	Decimal	27	92	nL	nH
[Range]	0	nL	255,		
	0	nL	255		
[Description]	Set the print starting position based on the current position by using				
[Notes]	1) This command sets the distance from the current position to [(nL+nHx256) x horizontal or vertical motion unit]				

2) Any setting that exceeds the printable area is ignored

3) When pitch N is specified to the right; $nL + nH \times 256 = N$

When pitch N is specified to the left (the negative direction), use the complement of 65536.

4) The print starting position moves from the current position to [N x horizontal or vertical motion unit]

5) The horizontal and vertical motion unit are specified by GS P.

6) The GS P command can change the horizontal (and vertical) motion unit.

However, the value cannot be less than the minimum horizontal movement amount, and it must be in even units of the minimum horizontal movement amount.

7) In standard mode, the horizontal motion unit is used.

8) In page mode, the horizontal or vertical unit differs as follows, depending on the starting point of the printing area;

When the starting position is set to the upper left or lower right of the printable area using ESC T, the horizontal motion unit (x) is used. When the starting position is set to the upper right or lower left of the printable area using ESC T, the vertical motion unit (y) is used.

[Reference] **ESC \$, ESC P**

ESC a n

[Name] Select justification

[Format] ASCII ESC a n

HEX 1B 61 n

Decimal 27 97 n

[Range] 0 n 2

48 n 50

[Description] Aligns all the data in one line to the specified position. n selects the type of justification as follows;

n	Justification
0, 48	Left justification
1, 49	Center justification
2, 50	Right justification

- [Notes]
- 1) The command is enabled only when processed at the beginning of the line in standard mode.
 - 2) If this command is input in page mode, the printer performs only internal flag operations.
 - 3) This command has no effect in page mode.
 - 4) This command executes justification in the printing area.
 - 5) This command justifies the space area according to HT, ESC \$ or ESC \

[Default] n = 0

[Example]

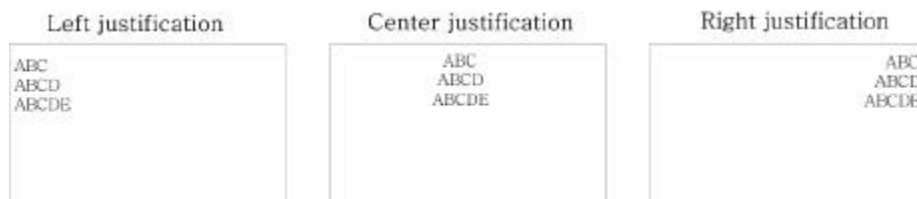

HT

[Name] Horizontal Tab

[Format] ASCII HT

HEX 09

Decimal 9

[Description] Moves the print position to the next horizontal tab position.

- [Note]
- 1) This command is ignored unless the next horizontal tab position has been set.
 - 2) If the next horizontal tab position exceeds the printing area, the printer sets the printing position to [Printing area width + 1]
 - 3) Horizontal tab positions are set with ESC D.
 - 4) If this command is received when the printing position is at [Printing area width + 1], the printer executes print buffer-full printing of the current line and horizontal tab processing from the beginning of the next line.
 - 5) The default setting of the horizontal tab position for the paper roll is every 0th character.

[Reference] **ESC D**

ESC D n1...nk NUL

[Name]	Set horizontal tab positions.				
[Format]	ASCII	ESC	D	n1...nk	NUL
	HEX	1B	44	n1...nk	00
	Decimal	27	68	n1...nk	0
[Range]	1 <= n <= 255				
	0 <= k <=32				
[Description]	Set horizontal tab position				
[Notes]	<ol style="list-style-type: none">1) n specifies the column number for setting a horizontal tab position from the beginning of the line.2) k indicates the total number of horizontal tab positions to be set.3) The horizontal tab position is stored as a value of [character width x n] measured from the beginning of the line. The character width includes the right-side character spacing, and double-width characters are set with twice the width of normal characters.4) This command cancels the previous horizontal tab settings.5) When setting n=8, the print position is moved to column 9 by sending HT.6) Up to 32 tab positions (k=32) can be set. Data exceeding 32 tab positions is processed as normal data.7) Transmit [n]k in ascending order and place a NUL code 0 at the end.8) When [n]k is less than or equal to the preceding value [n]k-1, tab setting is finished and the following data is processed as normal data.9) ESC D NUL cancels all horizontal tab positions.10) The previously specified horizontal tab positions do not change, even if the character width changes.11) The character width is memorized for each standard and page mode.				
[Default]	The default tab positions are at intervals of 0 characters.				
[Reference]	HT				

GS L nL nH

[Name]	Set left margin.				
[Format]	ASCII	GS	L	nL	nH
	HEX	1D	4C	nL	nH
	Decimal	29	76	nL	nH
[Range]	0	nL	255, 0	nH	255
[Description]	Set the left margin using nL and nH.				
[Notes]1)	The left margin is set to $[(nL+nH \times 256)] \times$ (horizontal motion unit) inches.				

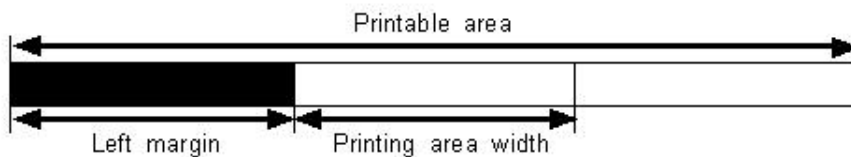

- 2) This command is effective only processed at the beginning of the line in standard mode.
 - 3) If this command is input in page mode, the printer performs only internal flag operations.
 - 4) This command does not affect printing in page mode.
 - 5) If the setting exceeds the printable area, the maximum value of the printable area is used.
 - 6) The horizontal and vertical motion units are specified by GS P.
- Changing the horizontal and vertical motion unit does not affect the current left margin.
- 7) The horizontal motion unit (x) is used for calculating the left margin.
- The calculated result is truncated to the minimum value of the mechanical pitch.

[Default] nL = 0, nH = 0

[Reference] **GS P, GS W**

GS W nL nH

[Name] Set printing area width

[Format]	ASCII	GS	W	nL	nH
	HEX	1D	57	nL	nH
	Decimal	29	87	nL	nH

[Range] 0 nL 255, 0 nH 255

[Description] Sets the printing area width to the area specified by nL and nH.

[Notes] 1) The printing area width is set to $[(nL+nH \times 256)] \times$ horizontal motion unit inches.

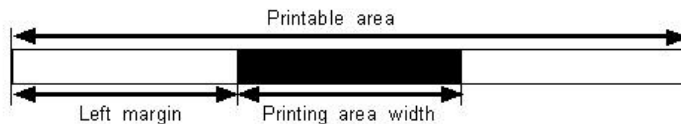

2) This command is effective only processed at the beginning of the line.

3) In page mode, the printer performs only internal flag operations.

4) This command does not affect printing in page mode.

5) If the [left margin + printing area width] exceeds the printable area, (printable area width - left margin) is used.

6) The horizontal and vertical motion units are specified by GS P.

Changing the horizontal and vertical motion units does not affect the current left margin.

7) The horizontal motion unit (x) is used for calculating the printing area width.

The calculated result is truncated to the minimum value of the mechanical pitch.

8) If the width set for the printing area is less than the width of one character, when the character data is developed, the following

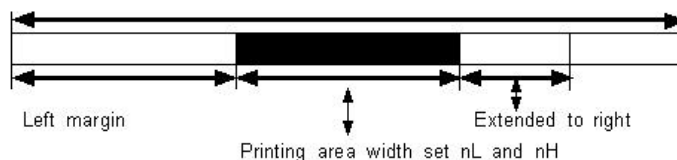

If the printing area width cannot be extended sufficiently, the left margin is reduced to accommodate one character.

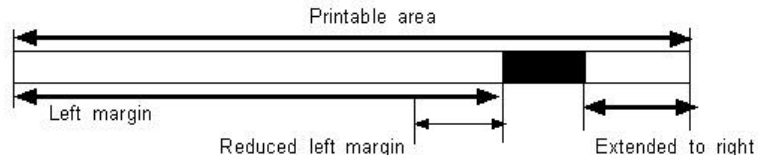

If the printing area width cannot be extended sufficiently, the right space is reduced.

9) If the width set for the printing area is less than one line in vertical, the following processing is performed only on the line in question when data other than character data(e.g., bit image, user defined bit image) is developed:

The printing area width is extended to the right to accommodate one line in vertical for the bit image within the printable area. If the printing area width cannot be extended sufficiently, the left margin is reduced to accommodate one line in vertical.

[Default] nL = 0, nH = 2

[Reference] **GS L, GS P**

ESC W xL xH yL yH dxL dxH dyL dyH

[Name]	Set printing area in page mode											
[Format]	ASCII	ESC	W	xL	xH	yL	yH	dxL	dxH	dyL	dyH	
	HEX	1B	57	xL	xH	yL	yH	dxL	dxH	dyL	dyH	
	Decimal	27	87	xL	xH	yL	yH	dxL	dxH	dyL	dyH	
[Range]	0 xL,xH,yL,yH,dxL,dxH,dyL,dyH 255											
	(except dxL=dxH=0 or dyL=dyH=0)											
[Description]	The horizontal starting position, vertical starting position, printing area width, and printing area height are defined as x0, y0, dx(inch), respectively.											
	$x0 = [(xL + xH * 256)] * (\text{horizontal motion unit})$											
	$y0 = [(yL + yH * 256)] * (\text{vertical motion unit})$											
	$dx = [(dxL + dxH * 256)] * (\text{horizontal motion unit})$											

$dy = [(dyL + dyH * 256)] * (\text{vertical motion unit})$

The printing area is set as shown in the figure below.

[Note]

- 1) If this command is input in standard mode, the printer executes only internal flag operation. This command does not affect printing in standard mode.
- 2) If the horizontal or vertical starting position is set outside the printable area, the printer stops command processing and processes the following data as normal data.
- 3) If the printing area width or height is set to 0, the printer stops command processing and processes the following data as normal data.
- 4) This command sets the position where data is buffered to the position specified by ESC T within the printing area.
- 5) If (horizontal starting position + printing area width) exceeds the printable area, the printing area width is automatically set to (horizontal printable area - horizontal starting position).
- 6) If (vertical starting position + printing area height) exceeds the printable area, the printing area height is automatically set to (vertical printable area - vertical starting position).
- 7) The horizontal and vertical motion unit are specified by GS P. Changing the horizontal or vertical motion unit does not affect the current printing area.
- 8) The GS P command can change the horizontal (and vertical) motion unit. However, the value cannot be less than the minimum horizontal movement amount, and it must be in even units of minimum horizontal movement amount.
- 9) Use the horizontal motion unit (x) for setting the horizontal starting position and printing area width, and use the vertical motion unit (y) for setting the vertical starting position and printing area height.
- 10) When the horizontal starting position, vertical starting position, printing area width, and printing area height are defined as X, Y, Dx, Dy respectively, the printing area is set as shown in the figure below.

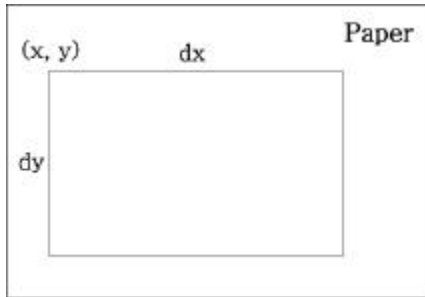

[Default] $xL = xH = yL = yH = 0$
 $dxL = 0, dxH = 2, dyL = 126, dyH = 6$

[Reference] **CAN, ESC L, ESC T, GS P**

ESC T n

[Name] Select print direction in page mode

[Format] ASCII ESC T n
 HEX 1B 54 n
 Decimal 27 84 n

[Range] 0 n 3 or 48 n 51

[Description] Selects the print direction and starting position in page mode.
 n specifies the print direction and starting position as follows;

n	Print direction	Starting position
0,48	Left to right	Upper left (A in the figure)
1,49	Bottom to top	Lower left (B in the figure)
2,50	Right to left	Lower right (C in the figure)
3,51	Top to bottom	Upper right (D in the figure)



[Notes] 1) When the command is input in standard mode, the printer executes only internal flag operation. This command does not affect printing in standard mode.

2) This command sets the position where data is buffered within the printing area set by ESC W.

3) Parameters for horizontal or vertical motion units (X or Y) differ as follows, depending on the starting position of the printing area;

If the starting position is the upper left or lower right of the printing area, data is buffered in the direction perpendicular to the paper feed direction.

Commands using horizontal motion unit: ESC SP, ESC \$, ESC \

Commands using vertical motion unit: ESC 3, ESC J, GS \$, GS \

If the starting position is the upper right or lower left of the printing area, data is buffered in the paper feed direction.

Commands using horizontal motion units : ESC 3, ESC J, GS \$, GS \

Commands using vertical motion units : ESC SP, ESC \$, ESC \

[Default] n = 0

[Reference] **ESC \$, ESC L, ESC W, ESC \, GS \$, GS P, GS **

GS \$ nL nH

[Name] Set absolute vertical print position in page mode.

[Format]

ASCII	GS	\$	nL	nH
HEX	1D	24	nL	nH
Decimal	29	36	nL	nH

[Range] 0 nL 255, 0 nH 255

[Description] Sets the absolute vertical print starting position for buffer character data in page mode.

[Notes]

- 1) This command sets the absolute print position to [(nL+nHx256)]x (vertical or horizontal motion unit) inches.
- 2) This command is effective only in page mode.
- 3) If the [(nL+nHx256)] x (vertical or horizontal motion unit) exceeds the specified printing area, this command is ignored.
- 4) The horizontal starting buffer position does not move.

- 5) The reference starting position is that specified by ESC T.
- 6) This command operates as follows, depending on the starting position of the printing area specified by ESC T; When the starting position is set to the upper left or lower right, this command sets the absolute position in the vertical direction. When the starting position is set to the upper right or lower left, this command sets the absolute position in the horizontal direction.
- 7) The horizontal and vertical motion unit are specified by GS P.
- 8) The GS P command can change the horizontal and vertical motion unit. However, the value cannot be less than the minimum horizontal movement amount, and it must be in even units of the minimum horizontal movement amount.

[Reference] **ESC \$, ESC T, ESC W, ESC \, GS P, GS **

GS \ nL nH

[Name] Set relative vertical print position in page mode

[Format]	ASCII	GS	\	nL	nH
		HEX	1D	5C	nL nH
		Decimal	29	92	nL nH

[Range] 0 nL 255
0 nH 255

[Description] Sets the relative vertical print starting position from the current position in page mode.

[Notes] 1) This command sets the distance from the current position to [(nL + nHx256)] x vertical or horizontal motion unit inches.

2) This command is ignored unless page mode is selected.

3) When pitch N is specified to the movement downward;

$$nL + nHx256 = N$$

When pitch N is specified to the movement upward (the negative direction), use the complement of 65536.

When pitch N is specified to the movement upward;

$$nL + nH \times 256 = 65536 - N$$

4) Any setting that exceeds the specified printing area is ignored.

5) This command function as follows, depending on the print starting position set by ESC T;

When the starting position is set to the upper left or lower right of the printing, the vertical motion unit (y) is used.

When the starting position is set to the upper right or lower left of the printing, the horizontal motion unit (x) is used.

6) The horizontal and vertical motion unit are specified by GS P.

7) The GS P command can change the horizontal (and vertical) motion unit. However, the value cannot be less than the minimum horizontal movement amount, and it must be in even units of the minimum horizontal movement amount.

[Reference] ESC \$, ESC T, ESC W, ESC \, GS \$, GS P

ESC O xL xH yL yH

[Name] Set print starting position.

[Format]	ASCII	ESC	O	xL	xH	yL	yH
	HEX	1B	4F	xL	xH	yL	yH
	Decimal	27	79	xL	xH	yL	yH

[Description] Set horizontal starting position and vertical starting position in page mode.

Horizontal starting position = $(xL + xH * 256) * (\text{horizontal motion unit})$

Vertical starting position = $(yL + yH * 256) * (\text{vertical motion unit})$

[Note] This command is effective only in page mode.

6.6. Bit-Image Commands

The PORT1-W25 supports the following bit-image command.

Command	Name
ESC *	Select bit image mode
ESC X 4	Define user-defined bit image

ESC * m nL nH d1 dk

[Name]	Select bit-image mode.
[Format]	ASCII ESC * m nL nH d1...dk HEX 1B 2A m nL nH d1...dk Decimal 27 42 m nL nH d1...dk
[Range]	m = 0,1,32,33 0 nL 255 0 nH 3 0 d 255
[Description]	Selects a bit-image mode using m for the number of dots specified by nL and nH, as follows:

m	mode	Vertical direction		Horizontal direction	
		Number of Dots	Dot density	Dot density	Number of Data
0	8 dot single	8	60 DPI	90 DPI	nL +nHx256
1	8 dot double	8	60 DPI	180 DPI	nL +nHx256
32	24 dot single	24	180DPI	90 DPI	(nL +nHx256)
33	24 dot double	24	180 DPI	180 DPI	(nL +nHx256)

- [Notes]
- 1) If the values of m is out of the specified range, nL and data following are processed an normal data.
 - 2) The nL and nH indicate the number of dots of the bit image in the horizontal direction.
 - 3) The number of dots is calculated by nL + nH x 256.

- 4) If the bit-image data input exceeds the number of dots to be printed on a line, the excess data is ignored.
- 5) d indicates the bit-image data. Set a corresponding bit to 1 to print a dot or to 0 to not print a dot.
- 6) If the width of the printing area set by GS L and GS W less than the width required by the data sent with the ESC * command, the following will be performed on the line in question (but the printing cannot exceed the maximum printable area): The width of the printing area is extended to the right to accommodate the amount of data.
If step does not provide sufficient width for the data, the left margin is reduced to accommodate the data.
- 7) After printing a bit image, the printer returns to normal data processing mode.
- 8) This command is not affected by print modes (emphasized, double-strike, underline, character size or White/Black reverse printing), except upside-down printing mode.
- 9) The relationship between the image data and the dots to be printed is as follows;

- When 8-dot bit image is selected

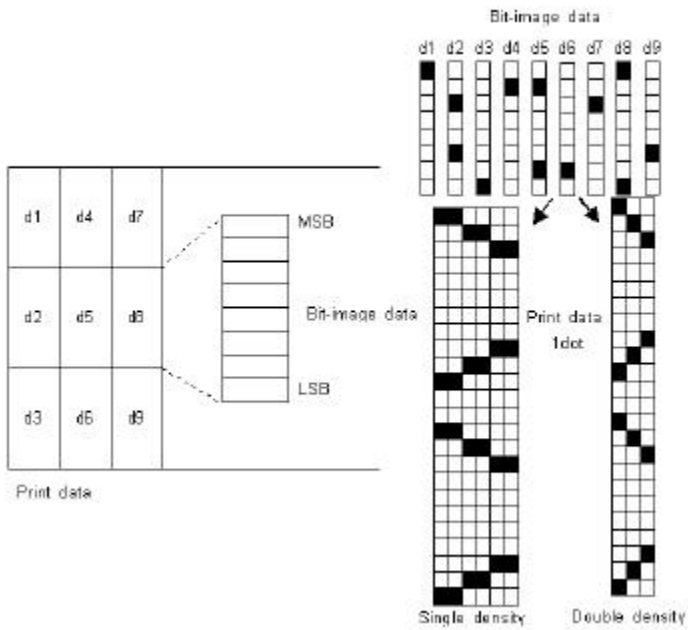

- When 24-dot bit image is selected

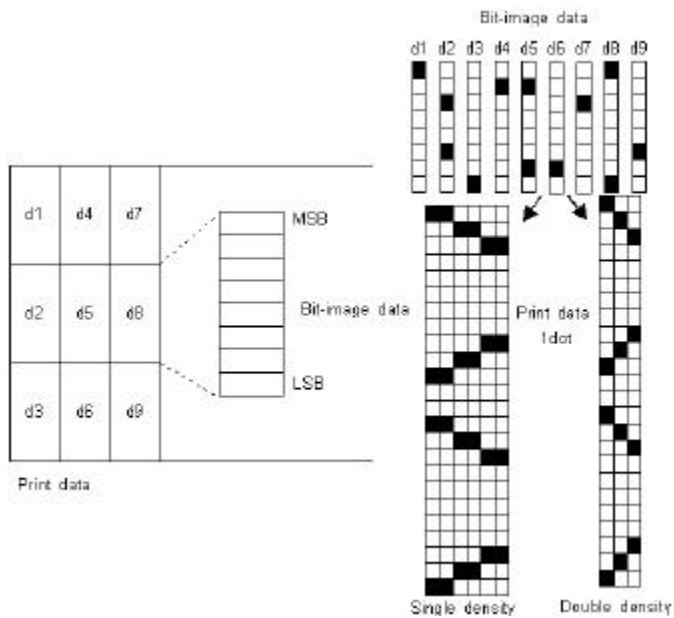

ESC X 4 x y d1...dk

[Name] Define user-defined bit-image

[Format] ASCII ESC X 4 x y d1...dk
 HEX 1B 58 34 x y d1...dk
 Decimal 27 88 52 x y d1...dk

[Description] **ESC X 4 x y d1 ... d(x ? y)** defines a user-defined bit image using x ? dots in the horizontal direction and y dots in the vertical direction.

- Horizontal direction dots = $(x * 8)$ dots

- Vertical direction dots = (y) dots

$x = 2, y = 20$

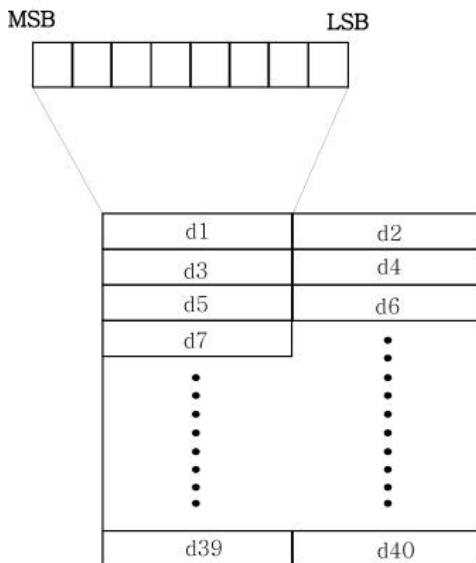

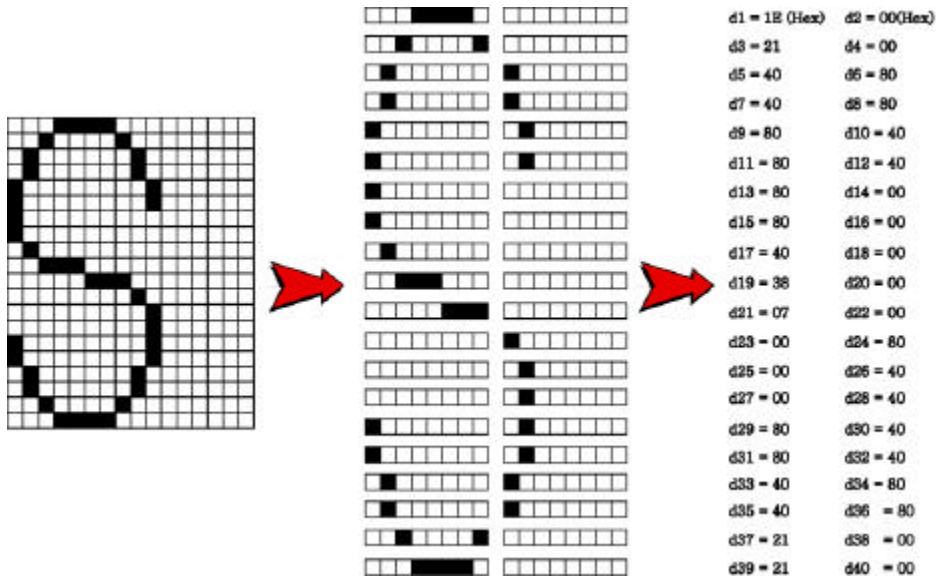

[Note] **ESC X 4** is supported in Porti_W,S produced after August,2002, but it's not supported in others yet.

[Reference] **ESC W, ESC O, FF**

6.7. Status Commands

The **PORTI-W25** supports the following status transmission command.

Command	Name
ESC v	Transmit paper sensor status

ESC v

[Name] Transmit paper sensor status

[Format] ASCII ESC v
 HEX 1B 76
 Decimal 27 118

[Description] ESC v transmits the status of a paper sensor as 1byte of data.

When the paper roll end sensor detects a paper, printer transmits the NULL(H00) data.

When the paper roll end sensor doesn't detect a paper, printer don't Transmit anything.

6.8. Barcode Commands

The PORTI-W25 supports the following barcode commands.

Command	Name
GS h	Set barcode height
GS w	Set barcode width
GS k	Print bar code
GS H	Select printing position of Human Readable Interpretation (HRI) characters

GS h n

[Name] Set barcode height

[Format] ASCII GS h n
 HEX 1D 68 n
 Decimal 29 104 n

[Range] 0 n 255

[Description] **GS h n** selects the height of a barcode.

n specifies the number of dots in the vertical direction.

One dot corresponds 1/8mm. The default setting is n = 80.

GS w n

[Name] Set barcode width

[Format] ASCII GS w n
 HEX 1D 77 n
 Decimal 29 119 n

[Range] n = 0, 3 n 5

[Description] **GS w n** selects the horizontal size of a barcode.

The default setting is n = 0.

GS k m d1...dk NUL GS k m n d1...dn

[Name] Print barcode

[Format] ASCII GS k m d1...dk NUL
 HEX 1D 6B m d1...dk 00
 Decimal 29 107 m d1...dk 0
 ASCII GS k m n d1...dn
 HEX 1D 6B m n d1...dn
 Decimal 29 107 m n d1...dn

[Range] 0 m 6 (k and d depends on the bar code system used.)
 0 m 6 (n and d depends on the bar code system used.)

[Description] **GS k m d1...dk NUL** selects a barcode system and print the barcode.
 m specifies a bar code system as follows;

m	Barcode System	Number of character	Remarks
0	UPC-A	11 k 12	48 d 57
1	UPC-E	11 k 12	48 d 57
2	EAN13	11 k 13	48 d 57
3	EAN8	7 k 8	48 d 57
4	CODE39	1 k	48 d 57, 65 d 90, d = 32, 36, 37, 43, 45, 46,47
5	ITF	1 k (even number)	48 d 57
6	CODABAR	1 k	48 d 57, 65 d 68, d = 36, 43, 45, 46, 47, 58

m	Barcode System	Number of characters	Remarks
65	UPC-A	11 n 12	48 d 57
66	UPC-E	11 n 12	48 d 57
67	EAN13	11 n 13	48 d 57
68	EAN8	7 n 8	48 d 57
69	CODE39	1 n 255	48 d 57, 65 d 90, d = 32, 36, 37, 43, 45, 46,47
70	ITF	1 n 255 (even number)	48 d 57
71	CODABAR	1 n 255	48 d 57, 65 d 68, d = 36, 43, 45, 46, 47, 58
72	CODE93	1 n 255	0 d 127
73	CODE128	2 n 255	0 d 127

[Notes]

- 1) This command ends with a NUL code.
- 2) When the bar code system used is UPC-A or UPC-E, the printer prints the bar code data after receiving 12 bytes bar code data and processes the following data as normal data.
- 3) When the bar code system used in EAN13, the printer prints the bar code after receiving 13 bytes bar code data and processes the following data as normal data.
- 4) When the bar code system used in EAN8, the printer prints the bar code after receiving 8 bytes bar code data and processes following data as normal data.
- 5) The number of data for ITF bar code must be even numbers.
When an odd number of data is input, the printer ignores the last received data.
- 6) n indicates the number of bar code data, and the printer processes n bytes from the next character data as bar code data.
- 7) If n is outside of the specified range, the printer stops command processing and

processes the following data as normal data.

8) Be sure to keep spaces on both right and left sides of a bar code.

Spaces are different depending on the types of the bar code.

[Reference] **GS h, GS w, GS H, ESC L, ESC W, ESC FF**

GS H n

[Name]	Turn HRI characters print mode ON/OFF			
[Format]	ASCII	GS	H	n
	HEX	1D	48	n
	Decimal	29	72	n
[Range]	n = 0, 1			
[Description]	GS H n turns HRI characters print mode on or off. When the LSB(least significant bit) of n is 1, HRI characters print mode is turned on; When it is 0, HRI character print mode is turned off. The default setting is n=0.			

ESC Z m n k d d1...dn

[Name]	Print 2D barcode			
[Format]	ASCII	ESC	Z	m n k d d1...dn
	HEX	1B	5A	m n k d d1...dn
	Decimal	27	90	m n k d d1...dn
[Range]	1	m	7	
	0	n	8	
	2	k	5	
	1	d	65535	
[Description]	Print 2D bar code (PDF417 format). <i>m</i> specifies column number of 2D bar code. <i>n</i> specifies security level to restore when bar code image is damaged. <i>k</i> is used for define horizontal and vertical ratio. <i>d</i> is consist of 2 byte. 1st byte is lower number. And 2nd byte is upper number.			

6.9. Macro Function Commands

The PORTI-W25 supports the following macro function commands;

Command	Name
GS :	Start/end macro definition
GS ^	Execute macro

GS :

[Name] Start/End macro definition

[Format] ASCII GS :
HEX 1D 3A
Decimal 29 58

[Description] Starts ends macro definition.

[Notes] 1) Macro definition starts when this command is received during normal operation. Macro definition ends when this command is received during macro definition.
2) When GS ^ is received during macro definition, the printer ends macro definition and clears the definition.
3) Macro is not defined when the power is turned on.
4) The defined contents of the macro are not cleared by ESC @. Therefore, ESC @ can be included in the contents of the macro definition.
5) If the printer receives GS : again immediately after previously receiving GS : the printer remains in the macro undefined state.
6) The contents of the macro can be defined up to 2048 bytes. If the macro definition exceed 2048 bytes, excess data is not stored.

[Reference] GS ^

GS ^ r t m

[Name] Execute macro.

[Format] ASCII GS ^ r t m
HEX 1D 5E r t m
Decimal 29 94 r t m

[Range] $0 \leq r \leq 255$
 $0 \leq t \leq 255$
 $m = 0, 1$

[Description] Executes a macro.

[Notes] 1) r specifies the number of times to execute the macro.
2) t specifies the waiting time for executing the macro.
3) m specifies macro executing mode.
When LSB of $m = 0$
The macro executes r times continuously at the interval specified by t.
When LSB of $m = 1$
After waiting for the period specified by t, the ERROR LED indicators blink and the printer waits for the FEED button to be pressed. After the button is pressed, the printer executes the macro once. The printer repeats the operation r times.
4) The waiting time is $t \times 100$ ms for every macro execution.
5) If this command is received while a macro is being defined, the macro definition is aborted and the definition is cleared.
6) If the macro is not defined or if is 0, nothing is executed.
7) When the macro is executed ($m=1$), paper always cannot be fed by using the FEED button.

[Reference] **GS :**

6.10. Miscellaneous function commands

The PORTI-W25 supports the following miscellaneous function commands;

Command	Name
GSP	Set horizontal and vertical motion units
ESC @	Initialize printer
ESC L	Select page mode
ESC S	Select standard mode

GS P x y

[Name]	Set horizontal and vertical motion units.															
[Format]	<table> <tbody> <tr> <td>ASCII</td> <td>GS</td> <td>P</td> <td>x</td> <td>y</td> </tr> <tr> <td>HEX</td> <td>1D</td> <td>50</td> <td>x</td> <td>y</td> </tr> <tr> <td>Decimal</td> <td>29</td> <td>80</td> <td>x</td> <td>y</td> </tr> </tbody> </table>	ASCII	GS	P	x	y	HEX	1D	50	x	y	Decimal	29	80	x	y
ASCII	GS	P	x	y												
HEX	1D	50	x	y												
Decimal	29	80	x	y												
[Range]	0 x 255, 0 y 255															
[Description]	<p>Sets the horizontal and vertical motion units to approximately 25.4/x mm(1/x inch) and approximately 25.4/y mm(1/y inch), respectively.</p> <p>When x and y are set to 0, the default setting of each value is used.</p>															
[Notes]	<p>1) The horizontal direction is perpendicular to the paper feed direction and the vertical direction is the paper feed direction.</p> <p>2) In standard mode, the following commands use x or y, regardless of character rotation (upside-down).</p> <p>Command using x : ESC SP, ESC \$, ESC \, GS L, GS W</p> <p>Command using y : ESC 3, ESC J</p> <p>3) In page mode, the following command use x or y, depending on character orientation;</p> <p>When the print starting position is set to the upper left or lower right of the printing area using ESC T(data is buffered in the direction perpendicular to the paper feed direction);</p> <p>Command using x : ESC SP, ESC \$, ESC W, ESC \</p> <p>Command using y : ESC 3, ESC J, ESC W, GS \$, GS \</p>															

When the print starting position is set to the upper right or lower left of the printing area ESC T (data is buffered in the paper feed direction);

Command using x : ESC 3, ESC J, ESC W, GS \$, GS \

Command using y : ESC SP, ESC \$, ESC W, ESC \

4) The command does not affect the previously specified values.

5) The calculated result from combining this command with others is truncated to the minimum value of the mechanical pitch.

[Default] x = 180, y = 360

[Reference] **ESC SP, ESC \$, ESC 3, ESC J, ESC W, ESC \, GS \$, GS L, GS W, GS **

ESC @

[Name] Initialize printer.

[Format] ASCII ESC @
HEX 1B 40
Decimal 27 64

[Description] Clears the data in the print buffer and resets the printer mode to the mode that was in effect when the power was turned on.

[Notes] 1) The data in the receive buffer is not cleared.
2) The macro definition is not cleared.

ESC L

[Name] Select page mode

[Format] ASCII ESC L
HEX 1B 4C
Decimal 27 76

[Description] Switches from standard mode to page mode.

[Notes] 1) This command is enabled only when processed at the beginning of a line in standard mode.
2) This command has no effect in page mode.
3) After printing by FF is completed or by using ESC S, the printer returns to standard mode.

4) This command sets the position where data is buffered to the position specified by ESC T within the printing area defined by ESC W.

5) This command switches the settings for the following commands (in which the values can be set independently in standard mode and page mode) to those for page mode;

Set right-side character spacing : ESC SP

Select default line spacing : ESC 2, ESC 3

6) Only valve settings is possible for the following commands in page mode; these commands are not executed.

Select justification : ESC a

Turn upside-down printing mode on/off : ESC {

Set left margin : GS L

Set printable area width : GS W

7) The printer returns to standard mode when power is turned on, the printer is reset, or ESC @ is used.

[Reference] **FF, CAN, ESC FF, ESC S, ESC T, ESC W, GS \$, GS **

ESC S

[Name] Select standard mode

[Format] ASCII ESC S

HEX 1B 53

Decimal 27 83

[Description] Switches from page mode to standard mode.

[Note]

- 1) This command is effective only in page mode.
- 2) Data buffered in page mode are cleared.
- 3) This command sets the print position to the beginning of the line.
- 4) The printing area set by ESC W are initialized.
- 5) This command switches the settings for the following commands (in which the values can be set independently in standard mode and page mode) to those for standard mode;

Set right-side character spacing : ESC SP

Select default line spacing : ESC 2, ESC 3

6) The following commands are enabled only to set in standard mode.

Set printing area in page mode : ESC W

Select print direction in page mode : ESC T

7) The following commands are ignored in standard mode.

Set absolute vertical print position in page mode : GS \$

Set relative vertical print position in page mode : GS \

8) Standard mode is selected automatically when power is turned on, the printer is reset, or command ESC @ is used.

[Reference] FF, ESC FF, ESC L

6.11. Line & box commands

The **PORTI- W25** supports the following line & box commands;

Command	Name
GS i	Print line & box in page mode

GS i

[Name]	Print line & box in page mode
[Format]	ASCII GS i xL xH yL yH n HEX 1D 69 xL xH yL yH n Decimal 29 105 xL xH yL yH n
[Description]	Print line & box in page mode Horizontal length : xL + xH *256(dot) Vertical length : yL+ yH*256(dot) Line thickness : n (dot) If the horizontal length is 0, it becomes vertical line If the vertical length is 0, it becomes horizontal line
[Range]	0 xL, xH, yL, yH 255 0 n 255

7 Introduction of Protocol IrDA

7.1. Frame structure



SOF : Start of frame (SOF code must be 0xC0)

TOF : Type of frame (See the table shown below)

Type of frame	Code	Data
ACK	0x06	X
NACK	0x15	X
ENQ	0x05	O
Print data	0x44	O
Require printer status	0x53	O
Response printer status	0x51	X
EOT	0x04	X

EOF : End of frame (EOF code must be 0xC1)

CHECKSUM : Checksum is necessary in case of the TOF code is 0x44.

DATA : Data is in need of the TOF code is 0x44, 0x05, 0x53.

1. If the code (0xC0, 0xC1, 0x7D) is included on sending data, first insert 0x7D code, then operate XOR with that code and 0x20.

Example : In case the send data is 0x20 0x7D 0xC1, the sending data will be 0x20 **0x7D** 0x5D
0x7D 0xE1.

Note : The bolded character is inserted data.

And the underlined character is the data operated XOR with 0x20.

2. If the code 0x7D is included on receiving, first remove 0x7D code, then operate XOR with next code and 0x20.

Example : In case the received data is 0x20 0x7D 0x5D 0x7D 0xE1, the real data will be 0x20 0x7D 0xC1.

Note : The underlined character is the data operated XOR with 0x20.

7.2. Process of printer status inquiry

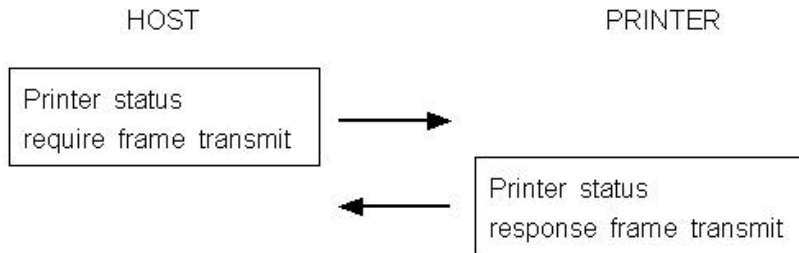

1. If there is no response from printer, after fifth times recheck with every 400ms, then display the error message such as "The printer cannot fined" on your display panel same like CRT, PDA, etc.

2. Structure of printer status response frame



- STATUS

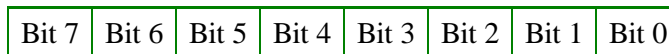

Bit	ON	OFF
0	Paper empty	Normal
1	Low battery	Normal
2	Head open	Normal
3	Not defined	Not defined
4	Not defined	Not defined
5	Not defined	Not defined
6	Not defined	Not defined
7	Not defined	Not defined

- Previous DATA ID : Finally used DATA ID

7.3. Process of transmitting and receiving print data

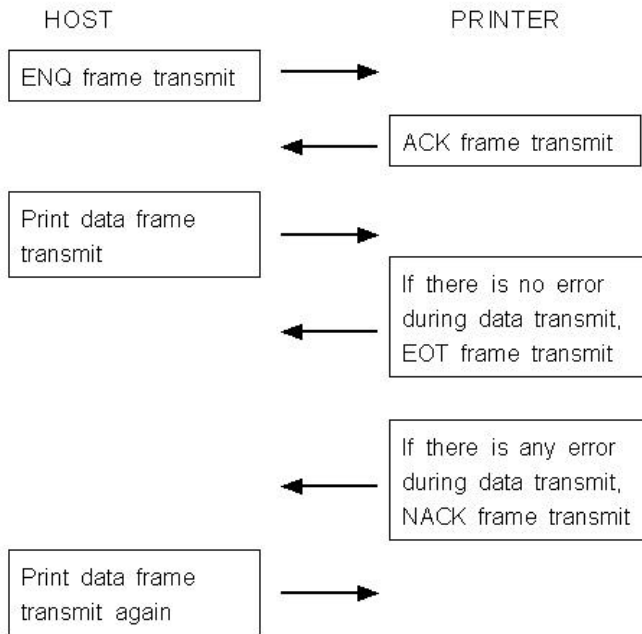

1. It is error condition shown below.

- Wrong checksum received
- No data received within 200ms after data receive.
- There is no 0xC1 code after checksum
- It is not number code (0x30 - 0x39) in data length field.

7.4 Structure of print data frame

SOF	0x44	DATA ID	DATA Length	Print DATA	CHECKSUM	EOF
-----	------	------------	----------------	---------------	----------	-----

1. DATA ID : It is made up 1 digit number.

The range is 0 - 9.

The number must be character code.

2. DATA Length : It consists of 4 digit numbers.

The range is 0001 - 9999.

The number must be character code.

Example - If you want to send 4 numbers data to printer, you must send 0x30 0x30 0x30 0x34 codes as data length.

3. CHECKSUM : It is composed of 2 bytes.

1st byte is operated XOR value with odd numbers of data.

And 2nd byte is operated XOR value with even numbers of data

Example - In case of print data is SAMPLE TEST, data length is 0011 (0x30 0x30 0x31 0x31), the 1st byte of checksum is operated XOR value with S, M, L, space, E, T, and 2nd byte checksum is operated XOR value with A, P, E, T, S.

Note :

- 1. Do not have time interval over 200ms on transmitting print data.**
- 2. If not receive EOT or NACK frame within 1 second after transmitting print data completely, jump to the transmitting ENQ frame.**
- 3. If receive EOT frame after print data transmitted, quit the print operation**
- 4. In case of receiving NACK frame, if receive NACK frame more than three times after transmit print data three times, display CHECK PRINTER STATUS on your display panel and wait operator's measures.**

7.5. Structure of ENQ frame

SOF	0x05	DATA ID	EOF
-----	------	---------	-----

1. If there is no response ACK frame after transmitting ENQ frame from host, transmit again ENQ frame after waiting 400ms.
2. In case of no response over 10 times from printer about ENQ frame, display PRINTER CANNOT FINDED message on the your display panel, and wait operator's measures.

Appendix

A. MISCELLANEOUS NOTES

1. Printer mechanism handling

- 1) Do not pull the paper out when the cover is closed.
- 2) Because the thermal elements of the print head and driver ICs are easy to break, so do not touch them with any metal objects.
- 3) Since the areas around the print head become very hot during and just after printing, do not touch them.
- 4) Do not use the cover open button except when necessary.
- 5) Do not touch the surface of the print head because dust and dirt can stick to the surface and damage the elements.
- 6) Thermal paper containing Na, K, Cl ions can harm the print head thermal elements.
Therefore, be sure to use only the specified paper.
- 7) If you want to use label paper, please contact your dealer for assistance.

2. Thermal paper handling

- Notes on using thermal paper

Chemicals and oil on thermal paper may cause discoloration and faded printing.

Therefore, pay attention to the following:

- 1) Use water paste, starch paste, polyvinyl paste, or CMC paste when gluing thermal paper.
- 2) Volatile organic solvents such as alcohol, ester, and ketone can cause discoloration.
- 3) Some adhesive tapes may cause discoloration or faded printing.
- 4) If thermal paper touches anything which includes phthalic acid ester plasticizer for a long time, it can reduce the image formation ability of the paper and can cause the printed image to fade. Therefore, when storing thermal paper in a card case or sample notebook, be sure to use only products made from polyethylene, polypropylene, or polyester.
- 5) If thermal paper touches diazo copy paper immediately after copying, the printed surface may be discolored.
- 6) Thermal paper must not be stored with the printed surfaces against each other because the printing may be transferred between the surfaces.

7) If the surface of thermal paper is scratched with a hard metal object such as a nail, the paper may become discolored.

- Notes on thermal paper storage

Since color development begins at 70 °C (158 °F), thermal paper should be protected from high temperature, humidity, and light, both before and after printing.

1) Store paper away from high temperature and humidity.

Do not store thermal paper near a heater or in enclosed places exposed to direct sunlight.

2) Avoid direct light Extended exposure to direct light may cause discoloration or faded printing.

3. Others

Because this printer uses plated steel, the manual cutting edge may be subject to rust.

However, this does not affect the printer performance.