

OWNER'S/ OPERATOR'S MANUAL

MODEL NO's

FM 560

FM 572

⚠ CAUTION

For Safe Operation
Read Rules And
Instructions Carefully

SINO LEEINGLES, PIDA AYUDA
A AIGUIEN QUE SI LO LEA
PARA QUE LE TRADUZCA LAS
MEDIDAS DE SEGURIDAD.

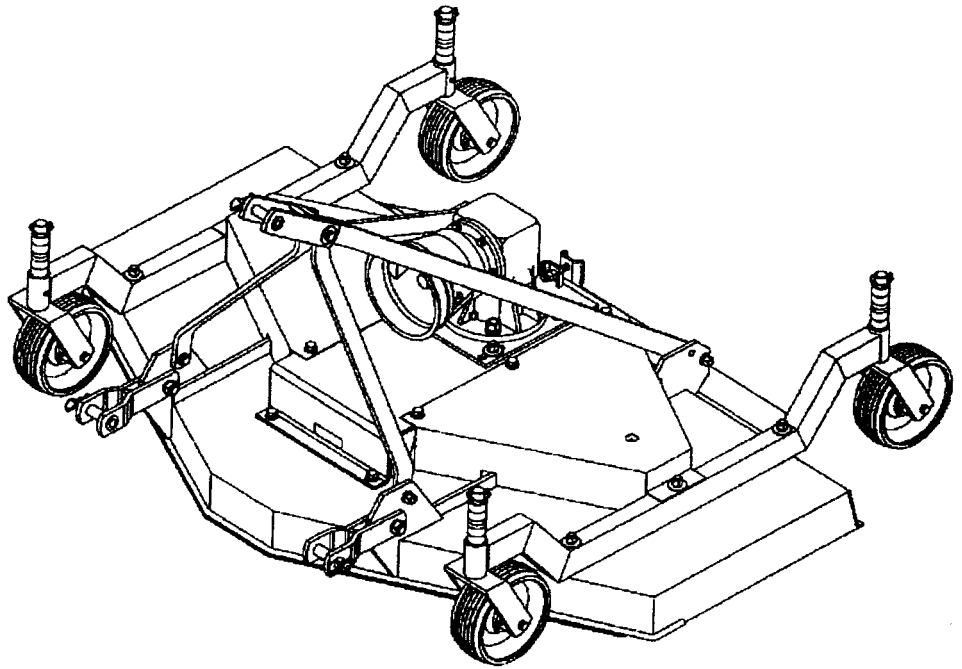

3 PT. REAR FINISHING MOWER

For Cat. I 3-Pt. Hitch Tractors up to 35 HP

**Safety Instructions
Tractor Preparation
Operating Instructions**

**Assembly & Mounting
Maintenance
Repair Parts**

⚠ CAUTION ⚠

**THE FOLLOWING SAFETY PRECAUTIONS SHOULD BE THOROUGHLY UNDERSTOOD
BEFORE ATTEMPTING TO BEGIN ASSEMBLING THIS MACHINE**

1. Select an area for assembly that is clean and free of any debris which might cause persons working on the assembly to trip.
2. Do not lift heavy parts or assemblies. Use crane, jack, tackle, fork trucks or other mechanical devices.
3. Preview the assembly instructions in your operator's manual before proceeding further.
4. If the assembly instructions call for parts or assemblies to be blocked up, use only blocking material that is in good condition and is capable of handling the weight of the assembly to be blocked. Also insure that the blocking material is on a clean, dry surface.
5. Never put hands, or any part of body, under blocked up assemblies if at all possible.
6. After completing assembly, thoroughly inspect the machine to be sure that all nuts, bolts, hydraulic fittings or any other fastened assemblies have been thoroughly tightened.
7. Before operating the machine, thoroughly read the operation section of your operator's manual.
8. Before operating, read the maintenance section of your operator's manual to be sure that any parts requiring lubrication, such as gearboxes, are full, to avoid any possible damage.
9. **Before operating equipment – If you have any questions regarding the proper assembly or operation, contact your dealer or representative.**

TABLE OF CONTENTS

CHECKLISTS	2
SAFETY INFORMATION	3
SAFETY SIGNS	14
INSTRUCTIONS	18
ASSEMBLY INSTRUCTIONS	19
OPERATION INSTRUCTIONS	20
TROUBLE-SHOOTING GUIDE	23
MAINTENANCE INSTRUCTIONS	27
REPLACEMENT PARTS	31

SINO LEEINGLES, PIDA AYUDA A AIGUIEN QUE SI LO LEA PARA QUE LE TRADUZCA LAS MEDIDAS DE SEGURIDAD.

STATEMENT OF POLICY

It is the policy of Worksaver to improve its products where it is possible and practical to do so. Worksaver reserves the right to make changes or improvements in design and construction at any time, without incurring the obligation to make these changes on previously manufactured units.

TO THE OWNER:

Read this manual before using your Finishing Mower. This manual is provided to give you the necessary operating and maintenance instructions for keeping your finishing mower in top operating condition. Please read this manual thoroughly. Understand what each control is for and how to use it. Observe all safety signs on the machine and noted throughout the manual for safe operation of implement. Keep this manual handy for ready reference.

Like all mechanical products, it will require cleaning and upkeep. Lubricate the Mower as specified.

Use only genuine Worksaver service parts. Substitute parts will void the warranty and may not meet standards required for safe and satisfactory operation. Record the model and serial number of your Mower here:

Model: _____ Serial Number: _____

RETAIL CUSTOMER'S RESPONSIBILITY

It is the Retail Customer and/or Operator's responsibility to read the Operator's Manual, to operate, lubricate, maintain, and store the product in accordance with all instructions and safety procedures. Failure of the operator to read the Operator's Manual is a misuse of this equipment.

It is the Retail Customer and/or Operator's responsibility to inspect the product and to have any part(s) repaired or replaced when continued operation would cause damage or excessive wear to other parts or cause a safety hazard.

It is the Retail Customer's responsibility to deliver the product to the authorized Worksaver Dealer, from whom he purchased it, for service or replacement of defective parts which are covered by warranty. Repairs to be submitted for warranty consideration must be made within forty-five (45) days of failure.

It is the Retail Customer's responsibility for any cost incurred by the Dealer for traveling to or hauling of the product for the purpose of performing a warranty obligation or inspection.

CHECKLISTS

DELIVERY CHECKLIST

Inspect the mower thoroughly after assembly to be certain it is set up properly. The following checklist is a reminder of points to inspect. Check off each item as it is found satisfactory or after proper adjustment is made.

- Check operator's manual and familiarize the operator with all sections of it.
- Check that all safety shielding is in place.
- Check all bolts to be sure they are tight or adjusted properly at hinged locations.
- Check that all cotter pins are properly installed.
- Check PTO driveline. Make sure it is the correct length to operate mower with intended tractor.
- Check that all lubrication points with grease fittings have been lubricated.
- Check that blades have been properly installed. Check all blade bolts.
- Check mower attitude, after mounting on tractor.
- Check that gearbox is properly serviced and seals are not leaking.
- Check shear bolt for proper grade and installation.
- All safety signs (decals) in place and readable.
- When the cutter is transported on a road or highway at night or during the day, safety devices should be used for adequate warning to operators of other vehicles.

PRE-OPERATION CHECKLIST

(OWNER/OPERATOR RESPONSIBILITY)

- _____ Review and follow safety rules and safety signs on pages 3 through 17.
- _____ Check that mower is properly and securely attached to tractor.
- _____ Make sure driveline spring-activated locking pin or locking balls operate freely and are seated firmly in tractor PTO spline groove.
- _____ Lubricate all grease fitting locations. Make sure PTO shaft slip joint is lubricated.
- _____ Check to be sure gear lube runs out the small check plug on side of gearbox.
- _____ Check that all hardware is properly installed.
- _____ Check to ensure blades are sharp and secure and cutting edge is positioned to lead in a counterclockwise rotation.
- _____ Check that all shields and guards are properly installed and in good condition.
- _____ Check cutting height, front to rear attitude and top link adjustment.
- _____ Place tractor PTO and transmission in neutral before starting engine.
- _____ Set tractor PTO gear select lever for 540 rpm operation.
- _____ Inspect area to be cut and remove stones, branches or other hard objects that might be thrown, causing injury or damage.
- _____ Check that PTO driveline shields are securely locked and clears the front of the mower frame.

IMPORTANT!

Gearbox was not filled at factory. It must be serviced before operating. Fill to proper level with SAE 90 oil. Failure to service will result in damage to gearbox.

To the Owner/Operator/Dealer

All implements with moving parts are potentially hazardous. There is no substitute for a cautious, safe-minded operator who recognizes the potential hazards and follows reasonable safety practices. The manufacturer has designed this implement to be used with all its safety equipment properly attached to minimize the chance of accidents.

BEFORE YOU START!!

Read the safety messages on the implement and shown in your manual.
Observe the rules of safety and common sense!



THIS SYMBOL MEANS

- ATTENTION!
- BECOME ALERT!
- YOUR SAFETY IS INVOLVED!

THIS SAFETY ALERT SYMBOL IDENTIFIES IMPORTANT SAFETY WARNING MESSAGES. CAREFULLY READ EACH WARNING MESSAGE THAT FOLLOWS. FAILURE TO UNDERSTAND AND OBEY A SAFETY WARNING, OR RECOGNIZE A SAFETY HAZARD, COULD RESULT IN AN INJURY OR DEATH TO YOU OR OTHERS AROUND YOU. THE OPERATOR IS ULTIMATELY RESPONSIBLE FOR THE SAFETY OF HIMSELF, AS WELL AS OTHERS, IN THE OPERATING AREA OF THE TRACTOR AND ATTACHED EQUIPMENT.

UNDERSTAND SIGNAL WORDS

Note the use of the signal words **DANGER**, **WARNING** and **CAUTION** with the safety messages. The appropriate signal word for each has been selected using the following guidelines:

DANGER: Indicates an imminently hazardous situation that, if not avoided, will result in death or serious injury. This signal word is to be limited to the most extreme situations typically for machine components which, for functional purposes, cannot be guarded.

WARNING: Indicates a potentially hazardous situation that, if not avoided, could result in death or serious injury, and includes hazards that are exposed when guards are removed. It may also be used to alert against unsafe practices.

CAUTION: Indicates a potentially hazardous situation that, if not avoided, may result in minor or moderate injury. It may also be used to alert against unsafe practices.

If you have questions not answered in this manual or require additional copies or the manual is damaged, please contact your dealer or the manufacturer directly.

IMPORTANT SAFETY INFORMATION!

Working with unfamiliar equipment can lead to careless injuries. Read this manual, and the manual for your tractor, before assembly or operating, to acquaint yourself with the machines. It is the implement owner's responsibility, if this machine is used by any person other than yourself, is loaned or rented, to make certain that the operator, prior to operating:

1. Reads and understands the operator's manuals.
2. Is instructed in safe and proper use.



The use of this equipment is subject to certain hazards which cannot be protected against by mechanical means or product design. All operators of this equipment must read and understand this entire manual, paying particular attention to safety and operating instructions, prior to using. If there is something in this manual you do not understand, ask your supervisor, or your dealer, to explain it to you.

SAFETY INSTRUCTIONS (continued)



EQUIPMENT SAFETY GUIDELINES



Safety of the operator is one of the main concerns in designing and developing a new piece of equipment. Designers and manufacturers build in as many safety features as possible. However, every year many accidents occur which could have been avoided by a few seconds of thought and a more careful approach to handling equipment. You, the operator, can avoid many accidents by observing the following precautions in this section. To avoid personal injury, study the following precautions and insist those working with you, or for you, follow them.



In order to provide a better view, certain photographs or illustrations in this manual may show an assembly with a safety shield removed. However, equipment should never be operated in this condition. Keep all shields in place. If shield removal becomes necessary for repairs, replace the shield prior to use.



Replace any CAUTION, WARNING, DANGER or instruction safety sign that is not readable or is missing. Location of such safety signs is indicated in this booklet.



Never use alcoholic beverages or drugs which can hinder alertness or coordination while operating this equipment. Consult your doctor about operating this machine while taking prescription medications.



Review the safety instructions with all users annually.



This equipment is dangerous to children and persons unfamiliar with its operation. The operator should be a responsible adult familiar with farm machinery and trained in this equipment's operations. **Do not allow persons to operate or assemble this unit until they have read this manual and have developed a thorough understanding of the safety precautions and of how it works.**



To prevent injury or death, use a tractor equipped with a Roll-Over Protective System (ROPS). Do not paint over, remove or deface any safety signs or warning signs on your equipment. Observe all safety signs and practice the instruction on them.



Never exceed the limits of a piece of machinery. If its ability to do a job, or to do so safely, is in question - **DON'T TRY IT.**



Do not modify the equipment in any way. Unauthorized modification may impair the function and/or safety and could affect the life of the equipment.







In addition to the design and configuration of this implement, including Safety Signs and Safety Equipment, hazard control and accident prevention are dependent upon the awareness, concern, prudence, and proper training of personnel involved in the operation, transport, maintenance, and storage of the machine. Refer also to Safety Messages and Operation Instructions in each of the appropriate sections of the Tractor and Mower Manuals. Pay close attention to the Safety Signs affixed to the Tractor and the Mower.







SAFETY INSTRUCTIONS (continued)



SAFETY SIGNS





-  Keep safety signs clean and legible at all times.
-  Replace safety signs that are missing or have become illegible.
-  Replaced parts that displayed a safety sign should also display the current sign.
-  Safety signs are available from your Distributor or Dealer Parts Department or the factory.

How to Install Safety Signs:

-  Be sure that the installation area is clean and dry.
-  Be sure temperature is above 50°F (10°C).
-  Decide on the exact position before you remove the backing paper.
-  Remove the smallest portion of the split backing paper.
-  Align the sign over the specified area and carefully press the small portion with the exposed sticky backing in place.
-  Slowly peel back the remaining paper and carefully smooth the remaining portion of the sign in place.
-  Small air pockets can be pierced with a pin and smoothed out using the piece of sign backing paper.



TIRE SAFETY

-  Failure to follow proper procedures when mounting a tire on a wheel or rim can produce an explosion which may result in serious injury or death.
-  Do not attempt to mount a tire unless you have the proper equipment and experience to do the job.
-  Inflating or servicing tires can be dangerous. Whenever possible, trained personnel should be called to service and/or mount tires.
-  Always order and install tires and wheels with appropriate capacity to meet or exceed the anticipated weight to be placed on the equipment.

SAFETY INSTRUCTIONS (continued)



SAFETY TRAINING



Safety is a primary concern in the design and manufacture of our products. Unfortunately, our efforts to provide safe equipment can be wiped out by a single careless act of an operator.



In addition to the design and configuration of equipment, hazard control and accident prevention are dependent upon the awareness, concern, prudence and proper training of personnel involved in the operation, transport, maintenance and storage of equipment.



It has been said, "The best safety device is an informed, careful operator." We ask you to be that kind of an operator. It is the operator's responsibility to read and understand ALL Safety and Operating instructions in the manual and to follow these. Accidents can be avoided.



Working with unfamiliar equipment can lead to careless injuries. Read this manual, and the manual for your tractor, before assembly or operating, to acquaint yourself with the machines. It is the rotary mower owner's responsibility, if this machine is used by any person other than yourself, is loaned or rented, to make certain that the operator, prior to operating:

1. Reads and understands the operator's manuals.
2. Is instructed in safe and proper use.



Know your controls and how to stop tractor, engine, and mower quickly in an emergency. Read this manual and the one provided with your tractor.



Train all new personnel and review instructions frequently with existing workers. A person who has not read and understood all operating and safety instructions is not qualified to operate the machine. An untrained operator exposes himself and bystanders to possible serious injury or death.





Do not allow children to operate this machine.

SAFETY INSTRUCTIONS (continued)





PREPARATION

-  Never operate the tractor and mower until you have read and completely understand this manual, the Tractor Operator's Manual, and each of the Safety Messages found on the safety signs on the tractor and mower.

-  Personal protection equipment including hard hat, safety glasses, safety shoes, and gloves are recommended during assembly, installation, operation, adjustment, maintaining, repairing, removal, or moving the implement. Do not allow long hair, loose fitting clothing or jewelry to be around moving parts.

-  **PROLONGED EXPOSURE TO LOUD NOISE MAY CAUSE PERMANENT HEARING LOSS!**
Tractors with or without Mowers attached can often be noisy enough to cause permanent, partial hearing loss. We recommend that you wear hearing protection on a full-time basis if the noise in the Operator's position exceeds 80db. Noise over 85db on a long-term basis can cause severe hearing loss. Noise over 90db adjacent to the Operator over a long-term basis may cause permanent, total hearing loss. **NOTE:** Hearing loss from loud noise (from tractors, chain saws, radios, and other such sources close to the ear) is cumulative over a lifetime without hope of natural recovery.

-  Operate the mower only with a tractor equipped with an approved Roll-Over Protective System (ROPS). Always wear your seat belt on tractors equipped with a ROPS. Serious injury or even death could result from falling off the tractor – particularly during a turnover when the operator could be pinned under the ROPS or the tractor. Keep foldable ROPS systems in “locked up” position at all times.

-  Clear area to be cut of stones, branches or other debris that might be thrown, causing injury or damage.

-  Operate only in daylight or good artificial light.

-  Ensure mower is properly mounted, adjusted and in good operating condition.

-  Make sure driveline spring-activated locking pin or balls operate freely and are seated firmly in tractor PTO stub shaft groove.

-  Ensure that all safety shielding and safety signs are properly installed and in good condition.

SAFETY INSTRUCTIONS (continued)



STARTING AND STOPPING SAFETY



Mower operating power is supplied from tractor PTO. Refer to your tractor manual for PTO engagement and disengagement instructions. Always operate the tractor PTO in the 540 rpm speed selection. **DO NOT OVER SPEED!** Know how to stop tractor and mower quickly in case of an emergency.



When engaging PTO, the engine RPM should always be low. Once engaged and ready to start cutting, raise PTO speed to 540 RPM and maintain throughout cutting operation.



Check the tractor master shield over the PTO stub shaft. Make sure it is in good condition and fastened securely to the tractor. Purchase a new shield if old shield is damaged or missing. (You may have to use a tractor salvage yard for replacement parts on older tractors.)



OPERATIONAL SAFETY



The use of this equipment is subject to certain hazards which cannot be protected against by mechanical means or product design. All operators of this equipment must read and understand this entire manual, paying particular attention to safety and operating instructions, prior to using. If there is something in this manual you do not understand, ask your supervisor, or your dealer, to explain it to you.



Most accidents occur because of neglect or carelessness. Keep all helpers and bystanders at least several hundred feet from an operating rotary mower. Only properly trained people should operate this machine.



The majority of accidents involve entanglement on the driveline, injury of bystanders by objects thrown by the rotating blades, and operators being knocked off the tractor by low hanging limbs and then being run over by the mower. Accidents are most likely to occur with machines that are loaned or rented to someone who has not read the owner's manual and is not familiar with a rotary mower.



Always stop the tractor, set brake, shut off the tractor engine, remove the ignition key, lower implement to the ground and allow cutter blades to come to a complete stop before dismounting tractor. **Never leave equipment unattended with the tractor running or with implement in raised position.**



Never place hands or feet under mower with tractor engine running or before you are sure all motion has stopped. Stay clear of all moving parts.















Do not reach or place yourself under equipment until it is blocked securely.

SAFETY INSTRUCTIONS (continued)



OPERATIONAL SAFETY (continued)

-  Take all possible precautions when leaving unit unattended: Disengage PTO, set parking brake, stop engine and remove key from ignition. Park in level area.
-  Do not allow riders on the rotary mower or tractor at any time. There is no safe place for any riders.
-  Disengage power takeoff (PTO) and place transmission into neutral before attempting to start engine.
-  Do not operate unless all personnel, livestock, and pets are 100 yards away to prevent injury by thrown objects. Never direct discharge toward anyone.
-  Install and secure all guards and shields before starting or operating.
-  Keep hands, feet, hair, and clothing away from moving parts.
-  This rotary mower is designed for use only on tractors with 540 RPM power takeoff.
-  Never operate tractor and mower under trees with low hanging limbs. Operators can be knocked off the tractor and then run over by the rotating blades.
-  The rotating parts of this machine have been designed and tested for rugged use. However, they could fail upon impact with heavy, solid objects such as steel guard rails, posts, and concrete abutments. Such impact could cause the broken objects to be thrown outward at very high velocities. To reduce the possibility of property damage, serious injury, or even death, never allow the cutting blades to contact such obstacles.
-  Frequently check mower blades. They should be sharp, free of nicks and cracks and securely fastened.
-  Many varied objects, such as wire, cable, rope, or chains, can become entangled in the operating parts of the mower head. These items could then swing outside the housing at greater velocities than the blades. Such a situation is extremely hazardous. Inspect the cutting area for such objects before mowing. Removing any like object from the site. Never allow the cutting blades to contact such items.
-  Pick up all rocks and other debris before mowing. Enter new areas carefully. Cut material higher at first, allowing cutter to clear hidden objects. Never assume an area is clear. **Always Check!**
-  Stop mower and tractor immediately upon striking an obstruction. Turn engine off, remove key, inspect and repair any damage before resuming operation.

SAFETY INSTRUCTIONS (continued)



OPERATIONAL SAFETY (continued)



The mower discharge deflectors, belt guards, driveline and gearbox shields should be used and maintained in good working condition. They should be inspected carefully at least daily. Missing, broken or worn items must be replaced at once and before operating mower to reduce the possibility of injury from thrown objects or entanglement.



Stay alert for holes, rocks, stumps and roots in the terrain and other hidden hazards. Keep away from drop-offs.



Use extreme care and maintain minimum ground speed when transporting on hillside, over rough ground and when operating close to ditches or fences. Be careful when turning sharp corners.



Reduce speed on slopes and sharp turns to minimize tipping or loss of control. Be careful when changing directions on slopes. Do not start or stop suddenly on slopes. Avoid operation on steep slopes.



When using a unit, a minimum 20% of tractor and equipment weight must be on tractor front wheels. Without this weight, tractor could tip over, causing personal injury or death. The weight may be attained with a front end loader, front wheel weights, ballast in tires of front tractor weights. When attaining a minimum 20% of tractor and equipment weight on the front wheels, you must not exceed the ROPS weight certification. Weigh the tractor and equipment. Do not guess or estimate!



Inspect the entire machine periodically as indicated in the Maintenance Section of this manual. Look for loose fasteners, worn or broken parts, pinched hydraulic hoses, and leaky or loose fittings. Make sure all pins have cotter pins and washers. Serious injury may occur from not maintaining this machine in good working order.



Be careful when operating tractor and mower on uneven ground to avoid upsetting.



In extremely uneven terrain, tractor rear wheel weights, front tractor weights, and/or tire ballast should be used to improve stability.



Pass diagonally through sharp dips and avoid sharp drops to prevent “hanging up” tractor and cutter. Practice will improve your skills in maneuvering rough terrain.



Avoid sudden starts and stops while traveling up or downhill.

















Always cut down slopes; never across the face. Avoid operation on steep slopes. Slow down on sharp turns and slopes to prevent tipping and/or loss of control.

SAFETY INSTRUCTIONS (continued)



TRANSPORT SAFETY

-  Comply with state and local laws governing highway safety and movement of farm machinery on public roads.
-  The use of flashing amber lights is acceptable in most localities. However, some localities prohibit their use. Local laws should be checked for all highway lighting and marking requirements.
-  When driving the tractor and equipment on the road or highway under 20 mph (32 kph) at night or during the day, use flashing amber warning lights and a slow moving vehicle (SMV) identification emblem.
-  Always be sure the implement is in the proper raised position for transport.
-  Reduce speed when transporting mounted implements to avoid bouncing and momentary loss of steering control.
-  Plan your route to avoid heavy traffic.
-  Always install transport locks, pins or brackets before transporting.
-  Do not drink and drive!
-  Watch for traffic when operating near or crossing roadways.
-  Turn curves or go up or down hills only at a low speed and at a gradual steering angle. Make certain that at least 20% of the tractor's weight is on the front wheels to maintain safe steering. Slow down on rough or uneven surfaces, and loose gravel.
-  Use extreme care and maintain minimum ground speed when transporting on hillside, over rough ground and when operating close to ditches or fences. Be careful when turning sharp corners.
-  Never allow riders on either tractor or mower. Falling off can kill.
-  Be a safe and courteous driver. Always yield to oncoming traffic in all situations, including narrow bridges, intersections, etc.
-  Do not exceed 20 mph (32 kph). Reduce speed on rough roads and surfaces.

SAFETY INSTRUCTIONS (continued)



MAINTENANCE SAFETY



Good maintenance is your responsibility. Poor maintenance is an invitation to trouble.



Follow good shop practices.

- Keep service area clean and dry.
- Be sure electrical outlets and tools are properly grounded.
- Use adequate light for the job at hand.



Make sure there is plenty of ventilation. Never operate the engine of the towing vehicle in a closed building. The exhaust fumes may cause asphyxiation.



Before working on this machine, drive to a level area, disengage the PTO, lower implement (or if working underneath, raise and block securely), shut off the engine, set the brakes, and remove the ignition keys.



Be certain all moving parts on attachments have come to a complete stop before attempting to perform maintenance.



Never work under equipment unless it is blocked securely. Never depend on hydraulic system to keep implement in raised position.



Keep all persons away from operator control area while performing adjustments, service, or maintenance.



Always use personal protection devices such as eye, hand and hearing protectors, when performing any service or maintenance.



Frequently check mower blades. They should be sharp, free of nicks and cracks and securely fastened.



Periodically tighten all bolts, nuts and screws and check that all cotter pins are properly installed to ensure unit is in a safe condition.









When completing a maintenance or service function, make sure all safety shields and devices are installed before placing unit in service.

SAFETY INSTRUCTIONS (continued)









MAINTENANCE SAFETY (continued)

-  After servicing, be sure all tools, parts and service equipment are removed.
-  Check to ensure all safety signs are installed and in good condition. (See safety sign section for location drawing.)
-  Do not allow grease or oil to build up on any deck or platform.
-  Never replace hex bolts with less than grade five bolts unless otherwise specified, i.e. shear bolts. Refer to bolt torque chart for head identification marking.
-  Where replacement parts are necessary for periodic maintenance and servicing, genuine factory replacement parts must be used to restore your equipment to original specifications. The manufacturer will not claim responsibility for use of unapproved parts and/or accessories and other damages as a result of their use.
-  If equipment has been altered in any way from original design, the manufacturer does not accept any liability for injury or warranty.
-  A fire extinguisher and first aid kit should be kept readily accessible while performing maintenance on this equipment.



STORAGE SAFETY

-  Following operation, or when unhooking, stop the tractor, set the brakes, disengage the PTO, shut off the engine and remove the ignition keys.
-  Store the unit in an area away from human activity.
-  Do not park equipment where it will be exposed to livestock for long periods of time. Damage and livestock injury could result.
-  Do not permit children to play on or around the stored unit.
-  Make sure all parked machines are on a hard, level surface and engage all safety devices.
-  If blocking is used, make sure it is solid and secure before leaving area.

SAFETY SIGN LOCATION

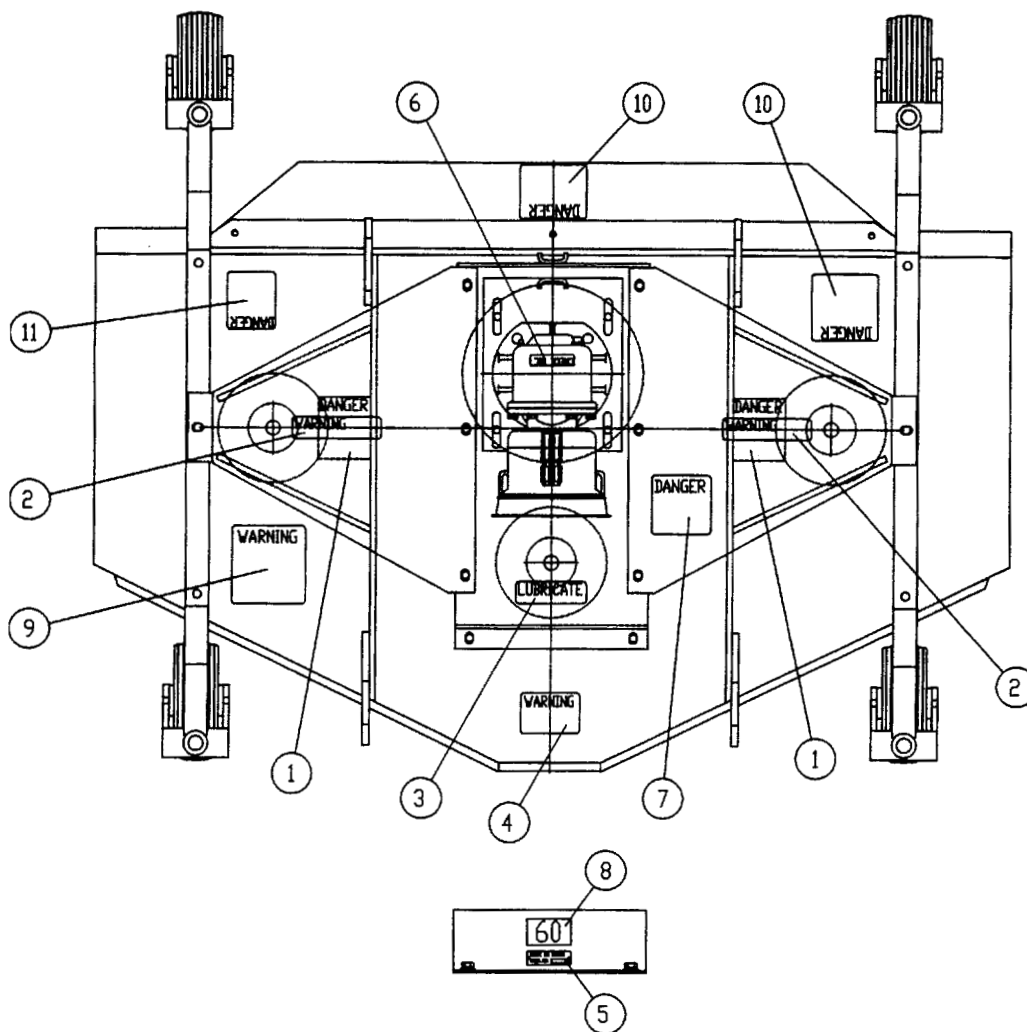

<u>ITEM</u>	<u>PART NO.</u>	<u>ITG REF.</u>	<u>QTY.</u>	<u>LEVEL</u>	<u>DESCRIPTION</u>
1	101106	13-006	2	Danger!	Guard missing
2	101175	13-009	2	Warning!	Rotating V-belt warning
3	101183	13-007	1	N/A	Greasing point
4	101101	13-008	1	Warning!	540 RPM max. input speed
5	101177	13-005	1	N/A	48" mower serial number tag
	101178	13-022	1	N/A	60" mower serial number tag
	101179	13-023	1	N/A	72" mower serial number tag
6	101174	13-013	1	N/A	Gearbox check oil level
7	101103	13-014	1	Danger!	Rotating PTO shaft warning
8	101180	13-010	1	N/A	48" mower decal
	101181	13-011	1	N/A	60" mower decal
	101182	13-012	1	N/A	72" mower decal
9	101157	13-017	1	Warning!	Warning sign
10	101176	13-015	2	Danger!	Rotating blade warning
11	101173	13-016	1	Danger!	Thrown object warning

SAFETY SIGNS



ITEM 1 – Part No. 101106



ITEM 7 – Part No. 101103



ITEM 11 – Part No. 101173



ITEM 4 – Part No. 101101

CHECK OIL LEVEL

BEFORE OPERATING, FILL TO LEVEL PLUG WITH EP-90 GEAR LUBE

ITG 500

ITEM 6 – Part No. 101174



ITEM 2 – Part No. 101175

SAFETY SIGNS (continued)



ITEM 10 – Part No. 101176

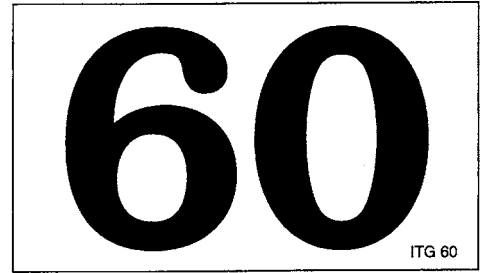

ITEM 8 – Part No. 101181

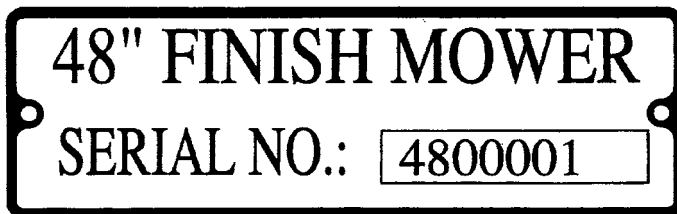

ITEM 5 – Part No. 101177
 – Part No. 101178
 – Part No. 101179

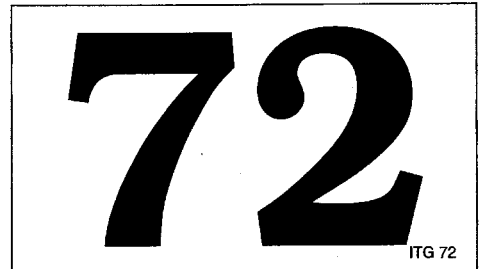

ITEM 8 – Part No. 101182

<p>LUBRICATE</p> <p style="text-align: center;">8 Hours</p> <p>Every 8 Hours</p>	<p>Driveline – 2 Places</p> <p>Caster Wheel – 2 Places on each</p> <p>Blade Shaft Housing – 1 Place on each</p>
---	--

Use Clean #2 Lithium – Based Bearing Grease

Notice: Blade Bolts Have Left Hand Threads ITG 400

ITEM 3 – Part No. 101183

SAFETY SIGNS (continued)



WARNING

To prevent serious injury or death:
Si no lee ingles, pida ayuda a alguien que si lo lea para que le traduzca las medidas de seguridad.

- Read and understand Operator's Manual before using. Review annually.
- Do not permit riders on the tractor or mower. Never carry children on tractor seat.
- Do not allow children to operate mower.
- Operate only with guards installed and in good condition.
- Keep away from moving parts.
- Operate only with tractor equipped with ROPS and seatbelts.
- Before mowing, clear debris from mowing area.
- Do not operate in the raised position.
- Stop engine, set brake and wait for all moving parts to stop before dismounting.
- Support mower securely before working beneath unit.
- Transport with clean reflectors, SMV and working lights as required by federal, state, and local laws.

M100

ITEM 9 – Part No. 101157

DRIVELINE SAFETY SIGNS

DANGER





SHIELD MISSING
DO NOT OPERATE

DANGER



SHIELD MISSING
DO NOT OPERATE



DANGER



ROTATING DRIVELINE
CONTACT CAN CAUSE DEATH
KEEP AWAY!

ALL DRIVELINE, TRACTOR AND
EQUIPMENT SHIELDS MUST BE
IN PLACE.

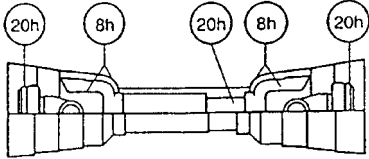
DRIVELINES MUST BE SECURELY
ATTACHED AT BOTH ENDS.
DRIVELINE SHIELDS MUST TURN
FREELY ON DRIVELINE.
GREASE JOINTS AND TELESCOPING
PARTS AS SPECIFIED:



INSTRUCTIONS

TRACTOR REQUIREMENTS AND PREPARATION

The models FM 560 and FM 572 Finishing Mowers are designed for light duty cutting such as lawn maintenance with a Category I, 3 pt. hitch and with a 540 rpm PTO. These mowers are not designed for tractors over 40 horsepower. The PTO must be in good working condition.

It is recommended that only tractors with wide front axles be used with this cutter. Tricycle front wheel arrangements are inherently unstable and tractor roll-over accidents are more likely to occur.

Tractor wheel tread spacing should be increased when working on inclines or rough ground to reduce the possibility of tipping.

The tractor also needs lift arm stabilizer bars or sway blocks to control side movement of the cutter.

Check the tractor's 3 pt. hydraulic lift system. Refer to your tractor operator's manual or dealer for any adjustments necessary to put the hydraulic system in good working order. (I & T shop manuals will list most specifications and adjustment instructions – available from most farm equipment dealers.)

Be sure tires and rims are in good condition. Inflate tires to the proper recommended air pressure.

Check the tractor master shield over the PTO stub shaft. Make sure it is in good condition and fastened securely to the tractor. Purchase a new shield if old shield is damaged or missing. (You may have to use a tractor salvage yard for replacement parts on older tractors.)

Shorten or remove the tractor drawbar so it will not interfere with the up and down movement of the mower.

Power unit must be equipped with ROPS or ROPS cab and seat belt. Keep seat belt securely fastened. Falling off power unit can result in death from being run over or crushed. Keep foldable ROPS systems in "locked up" position at all times. Contact your local dealer for a ROPS for your tractor.

! CAUTION! !

Be sure your tractor is in good condition. Read all the safety precautions and make sure all tractor operators are familiar with the safety rules of operation.

The operator is responsible for the safe operation of this mower. The operator must be properly trained. Operators should be familiar with the mower and tractor and all safety practices before starting operation. Read the safety rules and safety signs on pages 3-17.

Recommended mowing speed for most conditions is from two to five mph.

! WARNING! !

When using the unit, a minimum 20% of tractor and equipment weight must be on tractor front wheels. Without this weight, tractor could tip up, causing possible loss of control and possible personal injury or death. The weight may be attained with a front end loader, front wheel weights, ballast in tires or front tractor weights. When attaining a minimum 20% of tractor and equipment weight on the front wheels, you must not exceed the ROPS weight certification. Weigh the tractor and equipment. DO NOT GUESS OR ESTIMATE!

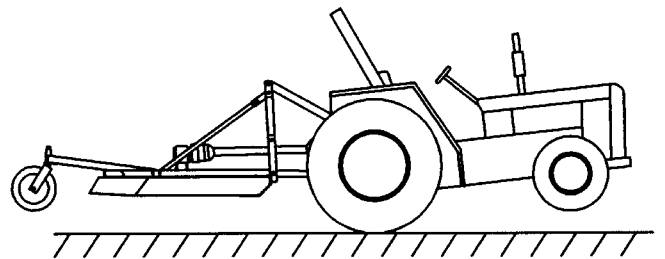

! WARNING! !

A heavy load can cause instability in driving a tractor. Make sure the front of the tractor is properly counterbalanced with weights. Always drive slowly – especially around turns. An unstable tractor could steer badly and possibly tip over, causing injury or death.

! DANGER! !

For non-agricultural applications, OSHA, ASAE SAE and ANSI standards require the use of chain guards, deflectors or solid skirts at all times. The mower manufacturer strongly recommends the use of chain guards, rubber belting or solid skirts for agricultural applications as well, to reduce the risk of property damage, serious bodily injury or even death from objects thrown or from contact with the cutting blades.

Front, rear, left and right are determined by the normal direction of travel, the same as when driving an automobile.

ASSEMBLY INSTRUCTIONS

The mower will attach to most tractors with a Category I, 3 pt. hitch system and a 540 RPM PTO. **Do not exceed horsepower recommendations.**



Operating with PTO speed over 540 RPM can cause excessive vibration and mower failure, which can result in serious injury or even death.

DEALER SET-UP INSTRUCTIONS

Assembly of this mower is the responsibility of the dealer. The mower should be delivered to the owner completely assembled, lubricated and adjusted for normal cutting conditions.

Set-up mower as received from the factory with these instructions.

- Remove mower from crate.
- Complete assembly of factory pre-assembled hitch.
- Refer to parts lists and exploded view drawings for more details.
- To complete assembly, it will be easier if components are aligned and assembled loosely before tightening hardware.



Always use personal protection devices such as eye and ear protection during assembly.

A-FRAME ATTACHMENT

Refer to the "exploded views" of this manual and **figure 1**. Attach the rear brace bars (1) to the lugs on the rear of the deck with the correct hardware. Attach the A-Frame bars (2) to the lugs on the front of the deck. Connect the upper ends of the A-Frame bars with the rear brace bars and swinging top link clevis together with the M12 bolt, washers, spacer and locknut.

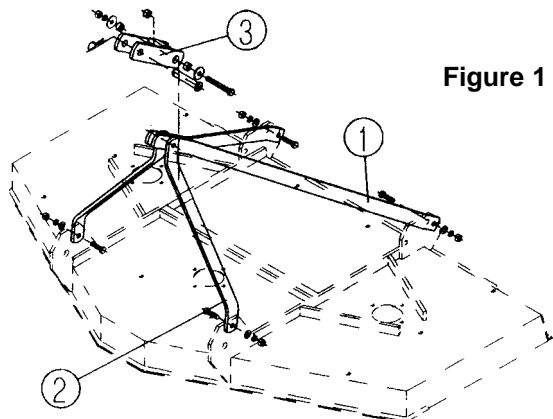

Figure 1

3 PT. HITCH ATTACHMENT

Remove bolt from hitch point location and assemble as shown in **figure 2**.

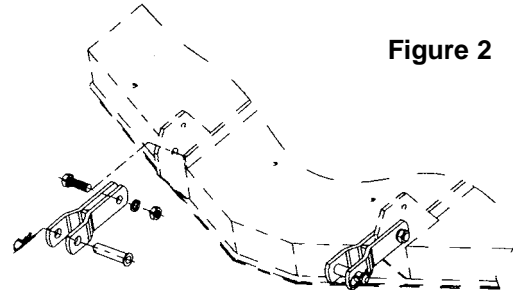

Figure 2

CASTER WHEEL ATTACHMENT

Some mowers will be supplied with all four wheels fully assembled. However, for models that do require assembly, please follow these instructions. Install two $\frac{3}{4}$ " spacers on each fork and wheel assembly shaft. Insert fork shaft into axle arm weldment. Additionally install two $\frac{3}{4}$ " and two $\frac{3}{8}$ " spacers on each axle shaft and retain using the snapper pins supplied. **See figure 3.**

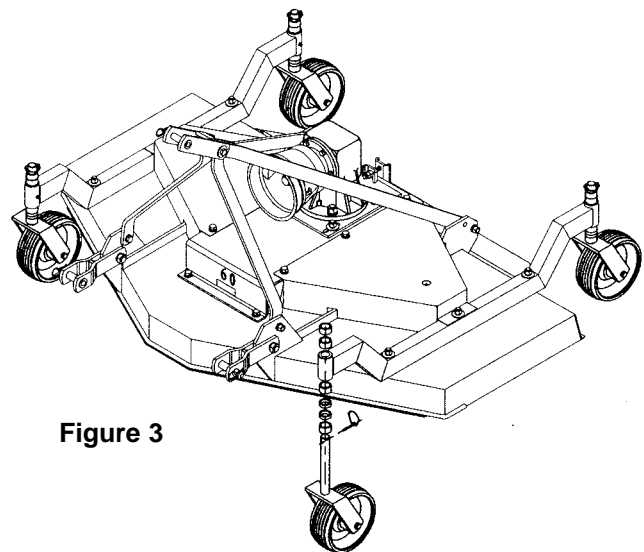

Figure 3

DRIVELINE TO MOWER GEARBOX ATTACHMENT

1. Grab and turn the yoke collar of the driveline end to be attached to the gearbox. **Note: Make sure that you connect the driveline end with the male shield tube to the mower.**
2. Slide the yoke with the collar turned onto the mower's gearbox input shaft. **Note: Make sure that the plastic protective cone is mounted on the gearbox.**
3. Move yoke back and forth until its locking pin has engaged on the gearbox input shaft groove.

OPERATION INSTRUCTIONS

The safe operation of this mower is the responsibility of the operator. Only qualified people familiar with this manual should operate this machine. The operator should be familiar with the machine, tractor and all safety practices before starting operation. **This mower is designed for lawn and grass mowing. It is not designed for rough conditions or heavy weed mowing.** The mower is equipped with suction type blades, which are best suited for lawn mowing.

Always operate tractor at 540RPM.

This chapter provides information for attaching mower to tractor and preparing it for field operation. Review this data prior to tractor hookup and operation.

TRACTOR PREPARATION

Do not install mower on a tractor over 40 HP.



Do not operate tractor with less than 20% of its gross unballasted mass on the front wheels with the mower in the transport position.

WHEEL TREADS

Tractor wheel tread spacing should be increased when working on inclines or rough ground to reduce the possibility of tipping.

STABILIZER BARS AND SWAY BLOCKS

Use stabilizer bars or sway blocks to prevent side sway of the mower.

DRAWBAR

Shorten or remove the tractor drawbar so it will not interfere with the up and down movement of the mower.



Do not get between tractor and mower when the engine is running.

ATTACHING THE MOWER TO TRACTOR (LIFT TYPE ONLY)

This mower is designed for tractors with 540 RPM and category I hitch. Back the tractor up to the mower so that the lower draft arms are in alignment with the mower lift pins. Stop the engine, lock the brakes or place the tractor in park. Connect the tractor and stabilizer bars to the lower lift pins. Adjust the top link so it will pin to the top holes in the A-Frame or into holes in floating top link.



Never allow children to operate, ride or come close to the mower or tractor. Usually, 15-16 year old children who are mature and responsible can operate the mower with reasonable safety if they have read the operator's manual, been trained in safe operation of the machine, and are physically large and strong enough to reach and operate the controls easily.

DRIVELINE ATTACHMENT TO TRACTOR

1. Grab and turn the collar on the end of the attaching yoke.
2. Slide yoke with the collar turned onto the tractor PTO shaft.
3. Move yoke back and forth until its locking pin has engaged on the PTO shaft groove.



When attaching the driveline yoke to the tractor PTO shaft, it is important that the spring activated locking collar turns freely and that it seats properly in the tractor PTO shaft groove.

CUTTING HEIGHT ADJUSTMENT



Avoid personal injury! Be sure tractor engine is off, that key is removed from ignition and allow blades to completely stop turning before dismounting to make adjustments.

Important: Avoid very low cutting heights. Striking the ground with the blades gives the most damaging shock loads a mower can encounter and will cause damage to it and the driveline.

1. Using the tractor, raise the mower off the ground and place supports underneath of it, so that it will not drift downwards while making adjustments or maintenance.
2. While supporting the wheel and yoke assembly off the ground, remove the snapper pin from the top of the gauge wheel spindle. Position the supplied spacers as required for achieving the desired cutting height.
3. Make sure all four wheels are adjusted the same.

OPERATION INSTRUCTIONS (continued)

STARTING AND STOPPING MOWER

The safe operation of this machine is the responsibility of the owner/operator. The operator should be familiar with the mower, tractor and all safety practices before starting operation. Read the safety rules on pages 3 thru 13.

The power required for operating the mower is supplied via the tractor PTO. Refer to your tractor's manual for instructions on engaging and disengaging the PTO.

1. Always engage the PTO at low engine RPM.
2. Operate the mower at 540 RPM PTO speed. Do not exceed 540 RPM PTO speed.
3. In case of emergency, you must learn how stop the tractor and mower quickly.

Important: Stop mower and tractor immediately upon striking an obstruction. Inspect the mower and repair any damage before resuming operation. Do not disengage PTO when the engine is at full PTO RPM. Always bring the tractor engine to idle speed before disengaging the PTO.

To start operation, reduce engine speed and engage the tractor PTO. Before starting to cut, gradually increase the engine speed to develop full PTO speed.

Enter the area to be cut with the mower operating at PTO speed and, if it becomes necessary to temporarily regulate engine speed during operation, increase or decrease the speed gradually.

To transport the mower, disengage the PTO and raise to full transport height.

Always turn off tractor engine, set parking brake, lower mower to ground and allow blades to come to a complete stop before dismounting tractor.

CUTTING SPEED

Proper ground speed for cutting will depend upon the height, type, and density of the grass to be cut.

Normally, ground speed will range from 1.5 to 3 MPH. Tall dense grass should be cut at low speeds, while thin medium height grass can be cut at faster ground speeds.

CUTTING TIPS

Always operate the PTO at the recommended RPM when cutting. This is necessary for correct blade speed, which creates a clean and even grass cut.

Under certain conditions the tractor tires may roll some grass blades down and prevent them from being cut at the same height as the surrounding area. If this occurs, reduce the tractor ground speed, but maintain 540 RPM PTO speed. The lower ground speed will allow grasses to be at least partially rebound and cut. Taking a partial cut and /or reversing the direction of travel may also produce a cleaner cut.

When people are passing by the area you are cutting, stop the cutting until the area has been cleared. Although the mower is shielded to prevent objects from being thrown by the blades, no shielding device is 100% effective. The mower operator has greater knowledge of

the hazards created by the machine than people on the street. Therefore, he must take every precaution possible when other people are around.



Avoid personal injury! Pick up all rocks and other debris before cutting. Enter new cutting areas carefully. Cut material higher the first time to allow the mower to clear unseen or hidden objects. Never assume that a cutting area is clear. Always check carefully before entering it.

Extremely tall grass should be cut in two stages. First, raise the mower above the desired cutting height and cut the grass in one direction. Second, adjust the mower to the desired cutting height and cut in a perpendicular (90 degree) direction from the first cut.

Remember, sharp blades produce cleaner cuts and require less power.

Before cutting analyze the area to determine the best cutting procedure. One must consider the grass height, its type and the terrain relief.

Grass is best cut when it is dry. Mowing wet grass can cause plugging, which results in grass clumps behind the mower.

DETACHING AND STORING

Lower the mower to the ground. Park the tractor with transmission in the correct gear (Automatic transmissions should be set on Park; Standard transmissions should be set on Neutral). Set the parking brake, turn off the engine and remove the keys from the ignition. Wait until the PTO stops rotating completely before dismounting the tractor.

Disconnect the driveline from the tractor PTO and store it to prevent contact from the ground and away from excessive moisture.

Always reinstall or lower into position the tractor PTO master shield. This shield should always remain in place except when connecting or disconnecting the driveline.

BEFORE OPERATING OR TRANSPORTING THE MOWER

Always display the SMV (slow moving vehicle) symbol on the rear of the tractor that transports the mower. The SMV symbol should be clearly visible to vehicles overtaking the tractor transporting the mower. Prominent display of this symbol will help the operator avoid accidents which could cause injury or possibly death. **See figure 4.**



Figure 4

OPERATION INSTRUCTIONS (continued)

FRONT GAUGE WHEEL INTERFERENCE CHECK

Do not operate the mower until this interference check has been performed. If you use the mower with a different tractor, you must perform the check for that particular mounting again.

1. Raise the mower with the tractor hydraulic system to the maximum height of lift.
2. Pivot both of the mower front gauge wheels forward and check that there is clearance between the gauge wheels and the tractor's rear tires.
3. If there is interference, lower the mower to the ground and move hitch to the extended position (see assembly chapter).
4. Move the tractor tires inward to obtain clearance or lower the mower until clearance exists.
5. Set the 3-point quadrant stop so the mower cannot be raised beyond the set point. See figure 5.

Figure 5

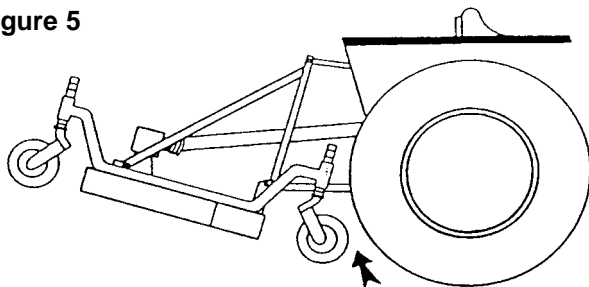

Front Gauge Wheel Clearance

DRIVELINE LENGTH CHECK PROCEDURE



WARNING!

A loose shaft could slip off and result in personal injury or damage to the mower. When attaching the driveline yoke to the tractor PTO shaft, it is important that the spring activated twist collar turns freely and that the locking pin is seated on the PTO shaft groove.



WARNING!

Before operating the mower check to make sure the driveline will not bottom out or become disengaged. See figure 6.

Figure 6

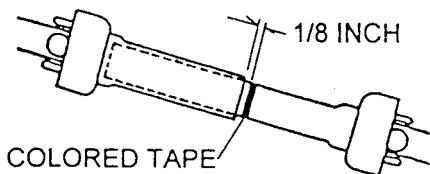

Driveline in maximum compressed position

ADJUSTING DRIVELINE LENGTH

1. Slide the driveline together until it "bottoms out."
2. Apply colored tape to the inner plastic shield tube $\frac{1}{8}$ " from the end of the outer shield tube.
3. Reconnect the driveline to the tractor PTO shaft.
4. Raise the mower to full transport position or until the driveline just hits the deck at front.
5. If the distance between colored tape and outer shield tube is $1\frac{9}{16}$ " or less, the metal drive tubes should be shortened per figure A.
6. Shorten the male and female plastic shield tubes equally. See figure B.
7. The metal drive tubes also have to be shortened in the same length as the plastic shield tubes. See figure C.
8. Round off all sharp edges and remove burrs. See figure D.
9. Apply grease to the metal drive tubes.
10. There should always be a minimum of $1\frac{9}{16}$ " clearance between the male and female drive and shield tubes when the driveline is operated in its shortest working position.
11. Lower the mower to the lowest position possible and check the distance of the colored tape to the end of the outer shield tube.
12. Driveline tube engagement or overlapping must always exceed 12".
13. If tubes do not overlap by 12" or more, consult with your dealer to obtain a longer driveline.

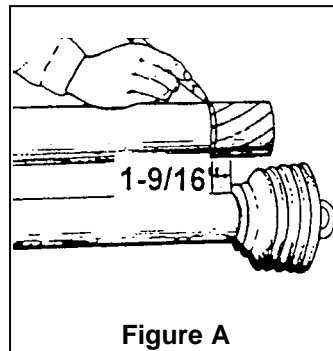

Figure A

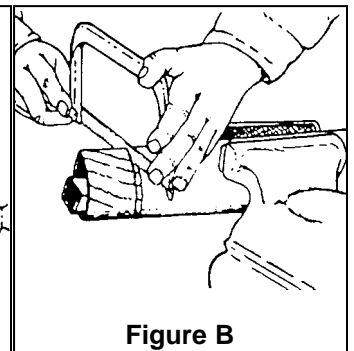

Figure B

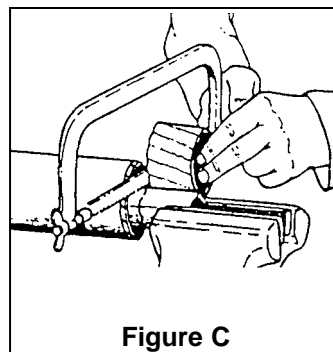

Figure C

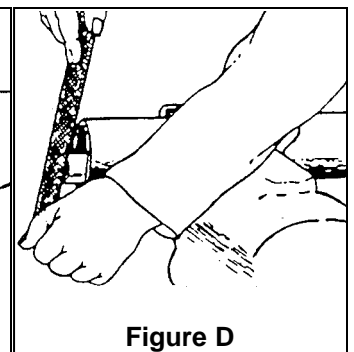

Figure D

TROUBLE-SHOOTING GUIDE

PROBLEM	POSSIBLE CAUSE	POSSIBLE REMEDY
Streaking.	1. Slow blade tip speed.	Operate PTO at 540 RPM.
	2. Worn blade tips.	Replace with correct specified blades.
	3. Dull blades.	Sharpen blades uniformly.
	4. Blades unable to cut that part of grass pressed down by tractor's tire path or mower's casters.	Slow tractor's ground speed but maintain 540 RPM PTO speed.
	5. Mowing too fast.	Slow down until cured.
	6. Drive belt loose.	Tighten per instructions on maintenance chapter.
	7. Belt glazed/slipping.	Apply belt dressing or replace it with a correct specified belt.
	8. Blade loose on spindle.	Tighten blade bolt securely. (Note: these are left-hand threads, tighten to 85 ft.lb. torque.)
	9. Conditions too wet for mowing.	Allow grass to dry before mowing.
Grass discharges from mower unevenly or bunches along a swath.	1. Grass is too high and too coarse.	Slow tractor's ground speed but maintain 540 RPM PTO speed. Raise the mower for the first pass and lower to the desired cutting height for the second and cut at 90 degrees to the first pass. Raise the rear of mower high enough to allow the grass to discharge, but not too high for streaking to occur.
	2. Belt slipping.	Tighten belt or replace with a correct specified belt.
	3. Grass is wet.	Allow grass to dry before mowing Slow tractor's ground speed but maintain 540RPM PTO speed Cut grass at a lower height.
Heavy vibration.	1. Blade speed is too fast.	Do not exceed 540 RPM PTO speed.
	2. Broken/bent blade.	Replace with correct specified blade.
	3. Worn/unbalanced blade.	Grind blade uniformly or replace.
	4. Bent/broken sheave.	Replace with correct specified part.
	5. Debris caught on blade.	Clean off blade.
Belt slipping.	1. Belt loose.	Tighten or replace with correct specified belt.
	2. Belt glazed.	Use belt dressing or replace it.
	3. Oil on belt.	Clean or replace.

TROUBLE-SHOOTING GUIDE (continued)

PROBLEM	POSSIBLE CAUSE	POSSIBLE REMEDY
Belt slippage.	1. Mower is overloading, grass is too tall or heavy.	Slow tractor's ground speed but maintain 540 RPM PTO speed. Cut grass twice. Raise the mower for the first pass and lower to the desired cutting height for the second and cut at 90 degrees to the first pass. Cut a partial swath only.
	2. Oil on belt from over lubrication.	Clean lubricant from belt and sheaves with a clean rag. Replace oil soaked belts. Be sure to follow operator's manual recommendations.
	3. Belt hung or rubbing.	Check belt for free travel in sheaves. Check under mower deck and spindles for debris or other foreign material and remove if any is present.
Belt rollover.	1. Sheave misalignment.	Consult with authorized dealer.
	2. Damaged belt.	Replace it with correct specified belt*.
	3. Foreign object in sheave groove.	Inspect all sheave grooves for rust, paint or other foreign material. Remove these if present.
	4. Worn sheave groove.	Replace with correct specified sheave.
Damaged belt.	1. Rollover, high shock loads or installation damage.	Replace it with correct specified belt*.
Belt breakage.	1. High shock loads.	Avoid abusive mowing. Avoid hitting ground with the mower and large obstructions.
	2. Belt came off sheave.	Check sheave for proper alignment and foreign material. Ensure proper belt tension. Avoid hitting the ground with mower and large obstructions.

* Check damaged belt for cause of damage by laying it flat on the floor. If the belt does not lie flat (check for humps, kinks, twists or other damage), this is an indication that it has broken or stretched cords. Do not reinstall this belt, replace it with a correct specified part.

TROUBLE-SHOOTING GUIDE (continued)

PROBLEM	POSSIBLE CAUSE	POSSIBLE REMEDY
Blade wears too fast.	1. Cutting in sandy conditions.	Increase cutting height.
	2. Cutting in rocky conditions.	Increase cutting height.
	3. Blades hitting ground.	Increase cutting height.
Mower seems to require excessive power.	1. Advancing into grass or brush too rapidly.	Reduce forward travel speed.
	2. Hitting ground.	Raise cutter and reset skids.
	3. Worn or dull blades.	Sharpen or replace blades.
	4. Tractor not large enough.	Use larger horsepower tractor.
	5. Grass too tall and heavy.	Make two passes. Raise cutter for first pass and lower for next pass.
Blade is scalping ground.	1. Mower too low.	Raise mower – reset gauge wheels.
	2. Lawn is ridged.	Cut lawn at a different angle.
	3. Lawn is too wet.	Stop and wait until it is drier.
Mower will not cut.	1. Tractor PTO not engaged.	Engage PTO.
	2. Tractor PTO clutch slipping.	Rebuild/replace clutch.
	3. Belts loose or worn.	Adjust belts or replace.
Mower moves from side to side when cutting.	1. Loose tractor sway chains or bars, or sway blocks improperly installed.	Adjust sway chains, bars, or sway blocks.
PTO contacts mower front frame when raised.	1. Raising cutter too high or incorrect adjustment of tractor top link.	Adjust top link or tractor lift stops. (See attachment instructions.)
Blade bolts come loose.	1. Bolts not tightened.	Tighten bolts.
	2. Blade bolt threads are worn or damaged.	Replace blade bolt, lockwasher, and nut.
	3. Spindle threads are worn or damaged.	Replace spindle.

TROUBLE-SHOOTING GUIDE (continued)

PROBLEM	POSSIBLE CAUSE	POSSIBLE REMEDY
Gearbox noisy.	1. Worn bearings.	Replace bearing.
	2. Low oil in gearbox.	Check level and add oil.
	3. Improper gearbox lubricant.	Replace with proper lubricant.
Gearbox leaking.	1. Damaged oil seal.	Replace seal.
	2. Bolts loose.	Tighten bolts.
	3. Gasket damaged.	Replace gasket.
	4. Oil seal installed wrong.	Replace seal.
	5. Oil seal not sealing in the housing.	Replace seal or use a sealant on outside diameter of seal.
	6. Oil level too high.	Drain oil to proper level.
	7. Hole in gearbox.	Replace gearbox.
	8. Shaft rough in oil seal area.	Replace or repair shaft.
	9. Bent shaft.	Replace oil seal and shaft.
Gearbox overheating.	1. Low on lubricant.	Fill to proper level.
	2. Improper type lubricant.	Replace with proper lubricant.
	3. Excessive trash build-up around gearbox.	Remove trash.
PTO driveline failure.	1. Driveline has not been properly lubricated.	Replace driveline worn parts.
	2. Engaging tractor PTO with engine at high rpm.	Replace driveline damaged parts. Always engage PTO with engine at low rpm.
	3. PTO is hitting swinging drawbar on tractor.	Remove drawbar or swing to one side.
	4. PTO contacts mower deck.	Raising too high or incorrect adjustment of tractor top link. Adjust top link or tractor lift stops.
Tractor stalls.	1. Advancing into grass too rapidly.	Reduce forward travel speed.
	2. Hitting ground.	Raise mower and adjust gauge wheels.
	3. PTO rpm too low.	Operate PTO at 540 rpm.
	4. Grass too tall and heavy.	Make two passes. Raise for first pass and lower for next pass.

MAINTENANCE INSTRUCTIONS

Before operating the mower, make sure that it is properly lubricated and thoroughly inspected. Only a minimum of time and effort is required to regularly lubricate and maintain it. Following a regular program will provide long life and trouble free operation.



WARNING!

Always disengage the tractor PTO before raising the mower for transport or making adjustments.

LUBRICATION

Do not let excess grease collect on or around parts, particularly when operating in sandy areas. The illustration below and on the next pages, show the location of all the lubrication fittings.

Use an SAE multi-purpose, lithium type grease for all the locations shown on figure 7. Be sure to clean the grease fittings before applying any grease. Daily lubrication of the driveline U-joints is necessary. Failure to maintain proper lubrication will result in premature wear and damage to the U-joints, gearbox and/or driveline.

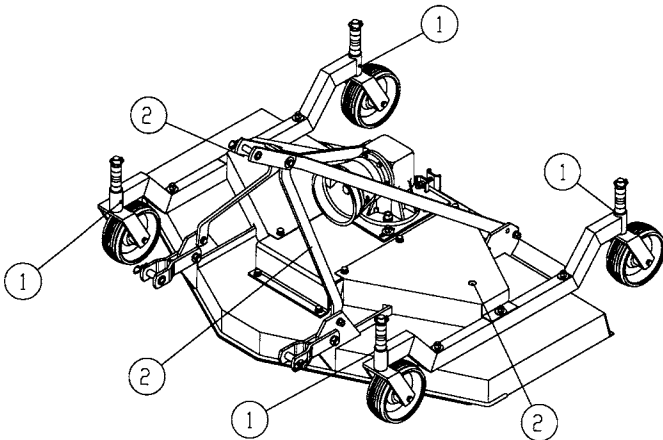

Figure 7

Lubrication fitting location

Item	Description	Frequency*
1	Gauge wheel pivots	Every 8 hours or daily
2	Blade spindle	Every 8 hours or daily
N/S	U-joints	Every 8 hours or daily

* Lubrication intervals shown are for mowers operating under normal conditions. Severe or unusual conditions may require more frequent lubrication.

GEARBOX LUBRICATION

The gearbox must be filled with SAE 90 EP oil before operating.

To fill gearbox to the correct operating level:

1. Place the mower on an even and leveled surface.
2. Remove filler and test level plug (see figure 8 for location of plugs).
3. Add oil through the filler plug until it starts running out of the test plug. (Pour oil slowly to make sure that the lower portion of the gearbox housing has been filled)
4. Screw the test and filler plugs back in their corresponding places.

It is recommended that the oil level plug be removed after every 8-10 hours of operation and oil added until it runs out of the test plug hole. The filler plug hole and test plug hole are both located on the back of side of the gearbox.

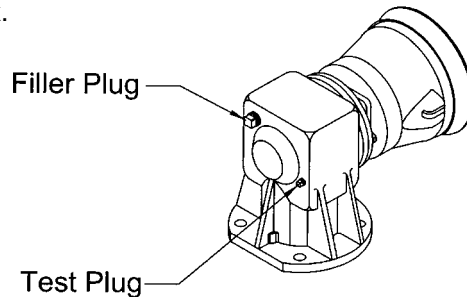

Figure 8

Note:

1. It is recommended that the test plug be removed after every 8-10 hours of operation, and oil added to the proper fill level if required.
2. Do not overfill the gearbox with oil. This will result in pressure build up inside the unit, which can cause the oil seals to leak.
3. If the gearbox suddenly starts making an unusual noise, stop at once, check for oil leaks and refill it as required.

GAUGE WHEEL ASSEMBLIES

The gauge wheels are equipped with bearings which require grease regularly. Grease fittings are provided in the gauge wheel pivot. It is recommended that these be lubricated after every 8 hours of operation. See figure 9.

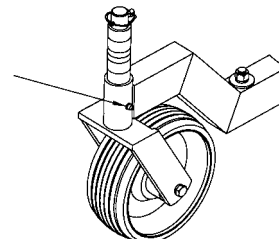

Figure 9

MAINTENANCE INSTRUCTIONS (continued)

DRIVELINE LUBRICATION

Grease fittings are located on the cross and bearing kit assemblies of both U-joints. U-joints should be greased after every 8 hours of operation. **See figure 10** for the location of the grease fittings. Do not force grease through the needle bearing cup assemblies.

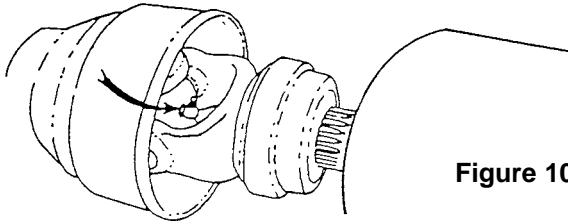

Figure 10

The metal telescoping drive tubes inside the plastic shield tubes must be lubricated before each use. **See figure 11.**

Disconnect the driveline from the tractor and pull halves apart (do not disconnect the driveline that is attached to the mower gearbox). Insert grease into drive tube and spread it evenly. Reconnect the two driveline halves together. Reconnect the driveline to the tractor PTO, raise and lower the mower several times so that the grease just applied spreads over the entire working area of the drive tubes.

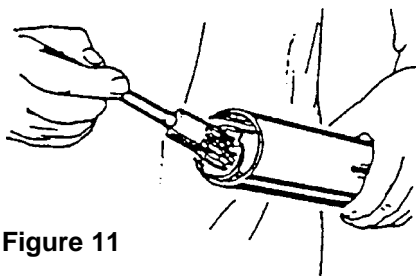

Figure 11



When attaching the driveline yoke to the tractor PTO shaft, it is important that the spring activated locking collar turns freely and that the locking pin is seated on the PTO shaft groove. A loose yoke could slip off and result in personal injury or damage to the mower.

BLADE SPINDLE LUBRICATION

Blade spindles must be lubricated after every 8 hours of operation. Access the lubrication fittings through the holes in the belt guards. Each spindle is supplied with a grease fitting on top, and it must be lubricated sufficiently so that a small amount of grease escapes through the bleed hole on their underside. Do not force large amounts of grease on the spindles, as it may get on the drive belts.

BLADE SERVICING

Use only correct specified blades on your mower. They are manufactured of special heat-treated alloy steel. Substitute blades may not meet specifications and may fail in a hazardous manner, which could cause injury.

BLADE SHARPENING

To maintain a proper blade balance, always sharpen both ends of the blade equally. Follow the sharpening pattern as shown **on figure 12**. Do not sharpen the blades to a razor edge, but leave a $1/32$ " blunt edge. Never sharpen the back side of the blades.



Avoid personal injury! Always support or block the mower when servicing the blades, carrier or any other component on the underside of the deck.

BLADE REMOVAL

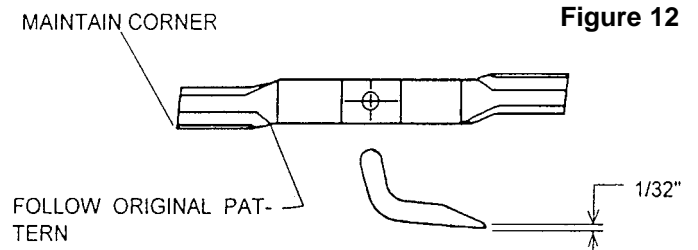

Hold the end of the blade using heavy leather gloves and remove the left hand threaded bolt.

MAINTENANCE INSTRUCTIONS (continued)

BLADE INSTALLATION

Install washer and lock washer on blade bolt, insert bolt into blade and bolt into the spindle shaft. **Note:** Always wear heavy leather gloves while tightening blade bolts. Blade bolt has left hand threads and it should be tightened to 85 ft. lb. torque. **See figure 13.**

Figure 13

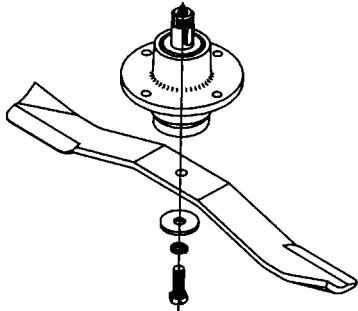

TORQUE BLADE BOLT
(LEFT HAND THREADS) TO 85 FT./LBS.

Figure 14

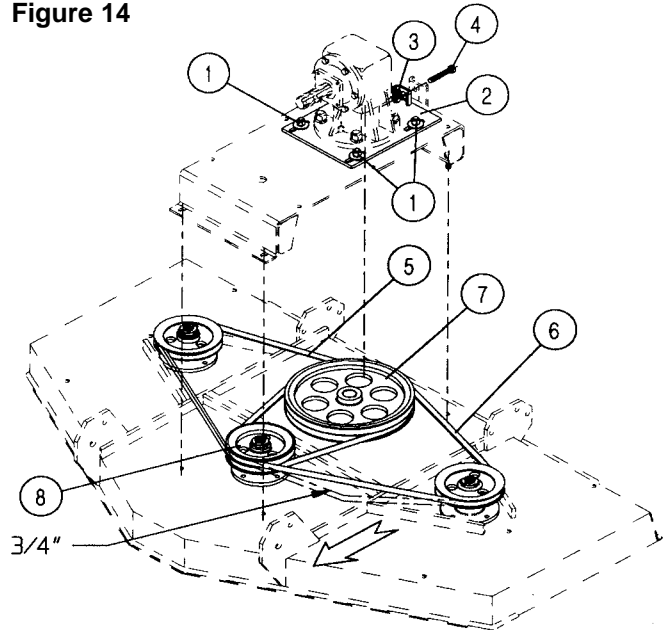

DRIVE BELT ADJUSTMENT

1. Shut off mower and tractor.
2. Loosen all four nuts (Item 1) on the gearbox slide plate (Item 2). **See figure 14.**
3. Loosen jam nut (Item 3) on the tension adjustment bolt (Item 4)
4. Tighten adjustment bolt (Item 4) until the belt deflection along the front side of the belts (Items 5 & 6) is $\frac{3}{4}$ " when approximately 10 pounds of pressure is applied to the center of the belt length.
5. **Do not overtighten belts!**
6. Tighten jam nut (Item 3) and nuts (Item 1) on gearbox slide plate.

DRIVE BELT REMOVAL AND INSTALLATION

1. Shut off mower and tractor.
2. Remove drive belt shield fasteners and belt shields.
3. Loosen gearbox slide plate bolts and gearbox adjustment bolt. **See figure 14.**
4. Slide gearbox to its forward most position
5. Slide belts under the gearbox sheave (Item 7) and over the center spindle sheave (Item 8).
6. Make sure that right hand belt (Item 5) is in the lower groove of the gearbox sheave and that the left hand belt (Item 6) is in the upper groove.
7. Slide the gearbox back to the full rear position and adjust according to the belt adjustment procedure described above.

- ✓ **Keep children away from danger all day, every day.**
- ✓ **Equip tractors with roll-over protection (ROPS) and keep all machinery guards in place.**
- ✓ **Please work, drive, play, and live each day with care and concern for your safety and that of your family and fellow citizens.**

MAINTENANCE INSTRUCTIONS (continued)

STORAGE

Your mower represents an investment from which you should get the greatest possible benefit and use. Therefore, when the cutting season is over, the mower should be thoroughly checked and prepared for storage so that a minimum amount of work will be required to put it back into operation for the next season.

We suggest the following storage procedures:

1. Thoroughly clean the mower
2. Lubricate the mower as recommended in the maintenance section of this manual.
3. Tighten all bolts and pins to the recommended torque.
4. Check the mower for worn or damaged parts and replace any require so.
5. Store the mower in a clean, dry place with the deck resting on blocks.
6. Use spray touch up enamel where necessary to prevent rust and maintain its appearance.

BLADE SPINDLE SERVICE INSTRUCTIONS DISASSEMBLY

(See figure 15)

1. Bend tab of lockwasher (item 7) out of the slot in the nut (item 8).
2. Remove the nut (item 8) from spindle shaft (item 3).
3. Support the spindle housing (item 1) and press the spindle (item 3) out of the housing.
4. Remove the bearings (item 2) and the spacer (item 5).

BLADE SPINDLE SERVICE INSTRUCTIONS ASSEMBLY

1. Inspect all parts for damage or wear and make sure that the bearings are in good condition. Replace any parts that show wear or any damage.
2. Clean all components and make sure that they are free of dirt, grease or any other contaminants.
3. Before assembly pack the ball bearings with quality bearing grease.
4. Press a bearing into the housing on the side that has the grease overfill hole. Make sure that the bearing's dirt seal is facing to the outside of the housing.
5. Install a flat washer (item 6), and the dust cap (item 4). Next press the spindle shaft through the already installed bearing and be certain that the bearing is seated properly.
6. Install the spacer (item 5) on the spindle shaft. Press the second bearing into the opposite side of the housing and make sure that it is properly seated, with the dirt seal facing outside.
7. Next install the flat washer (item 6) and key (item 10) on the shaft. Mount the proper sheave that corresponds with the spindle.
8. Install lockwasher (item 7) and nut (item 8) on the shaft and tighten to approximately 65 ft. lb. torque.
9. Align the slot in the nut with the lockwasher tab. Bend the tab into the nut so it locks in place.
10. Grease the spindle assembly through the grease fitting (item 9) until a small amount of grease comes out of the relief hole in the housing.

Figure 15

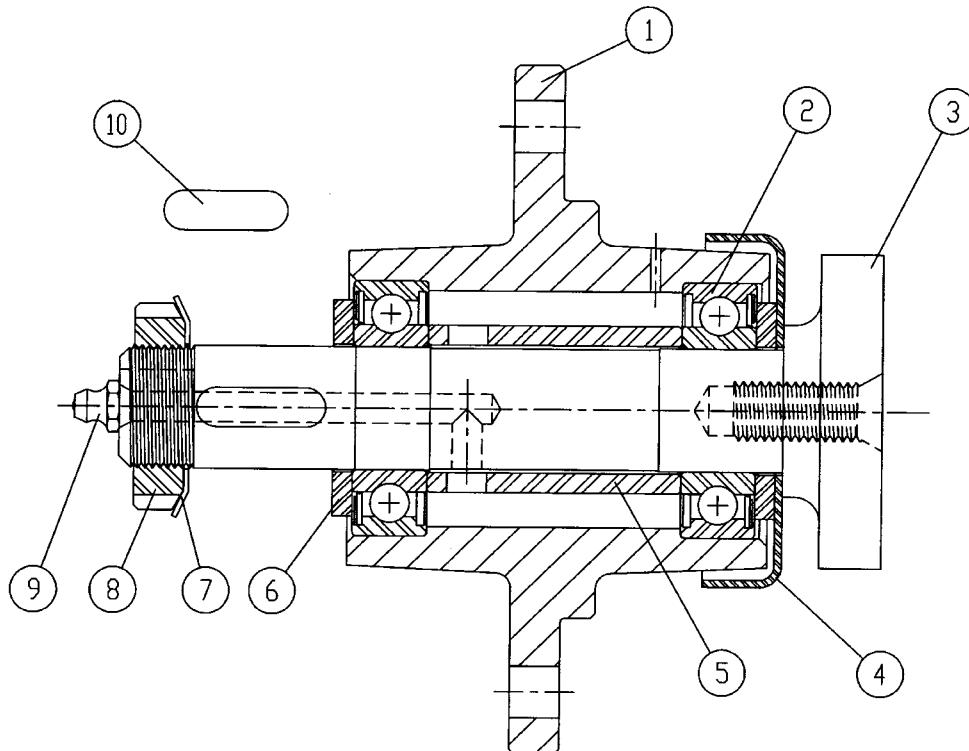

REPLACEMENT PARTS



For maximum safety and reliability, always use genuine replacement parts. The use of inferior replacement parts may cause premature or catastrophic failure which could result in serious injury or death. For questions regarding parts please contact your DEALER. The manufacturer reserves the right to substitute parts where applicable.

Note: Please make sure that your mower always has clearly legible safety decals as described in the mower safety chapter. When ordering replacement decals refer to the safety decals part numbers described on pages 15-17.

REPLACEMENT PARTS Table of Contents

General Mower Assembly	32
Driveline Assembly	33
Three-Point Lift Assembly	34
Gearbox Assembly 60" & 72"	35
Shield Assembly	36
Blade and Spindle Assembly	37
Pulley, Belt and Wheel Assembly	38

GENERAL MOWER ASSEMBLY

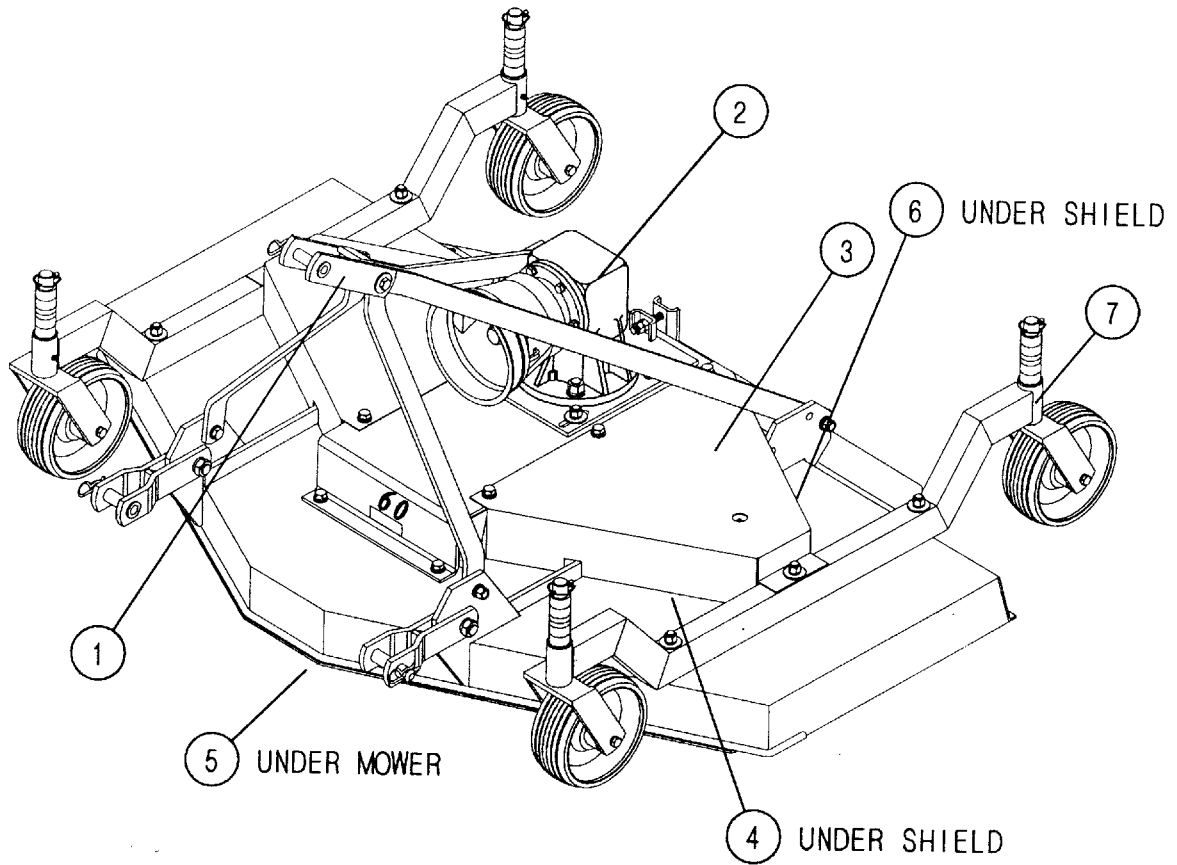

<u>ITEM</u>	<u>PAGE NO.</u>	<u>DESCRIPTION</u>
1	34	3-Point lift assembly
2	35	Gearbox assembly
3	36	Shield assembly
4	38	Belt assembly
5	37	Blade and spindle assembly
6	37	Spindle and housing assembly
7	38	Wheel and axle assembly

DRIVELINE AND DRIVELINE SHIELD ASSEMBLY

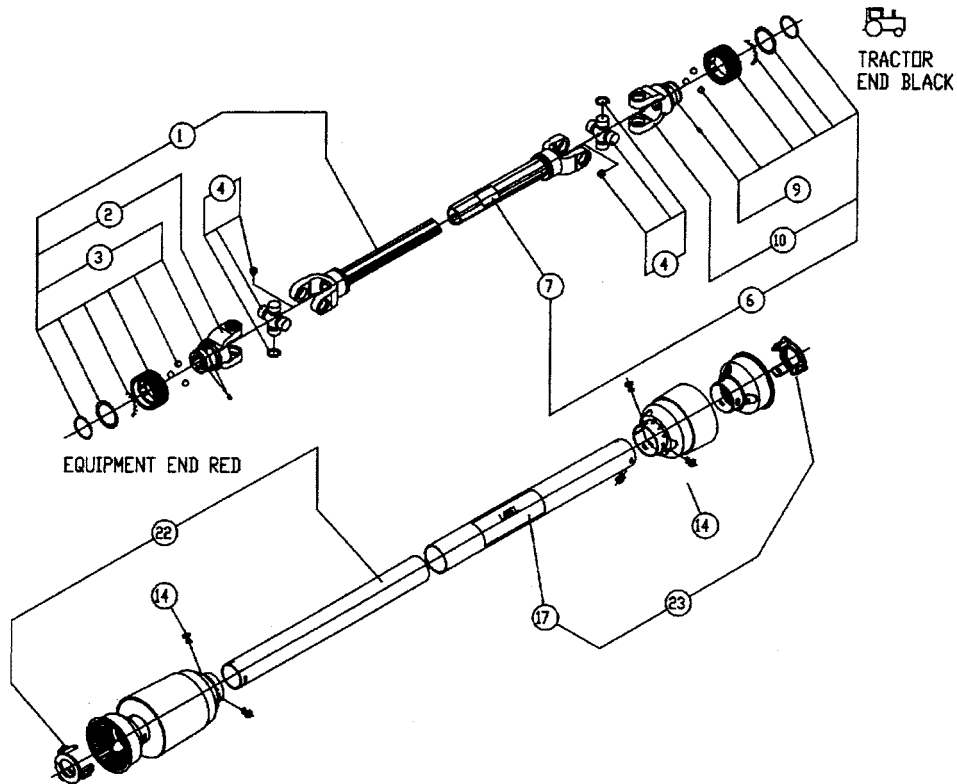

<u>Item</u>	<u>Part No.</u>	<u>ITG Ref.</u>	<u>Qty.</u>	<u>Description</u>
	650795	35-126	1	Assembly, complete driveline
1	650801	28-097	1	Assembly, inner shaft and shield
2	650802	26-020	1	Assembly, yoke 1 3/8" Q.D.
3	650803	26-017	1	Kit, twist collar - red
4	650804	26-001	2	Kit, cross and bearing
6	650805	28-081	1	Assembly, outer shaft and shield
7	650806	13-001	1	Label, warning
9	650807	26-021	1	Kit, twist collar - black
10	650808	26-015	1	Assembly, yoke 1 3/8" Q.D.
14	650929	12-014	6	Pin, locking
17	650810	13-002	1	Label, warning
	650809	27-067	1	Assembly, complete shield
22	650811	27-063	1	Assembly, inner half shield
23	650812	27-111	1	Assembly, outer half shield

3 POINT LIFT ASSEMBLY

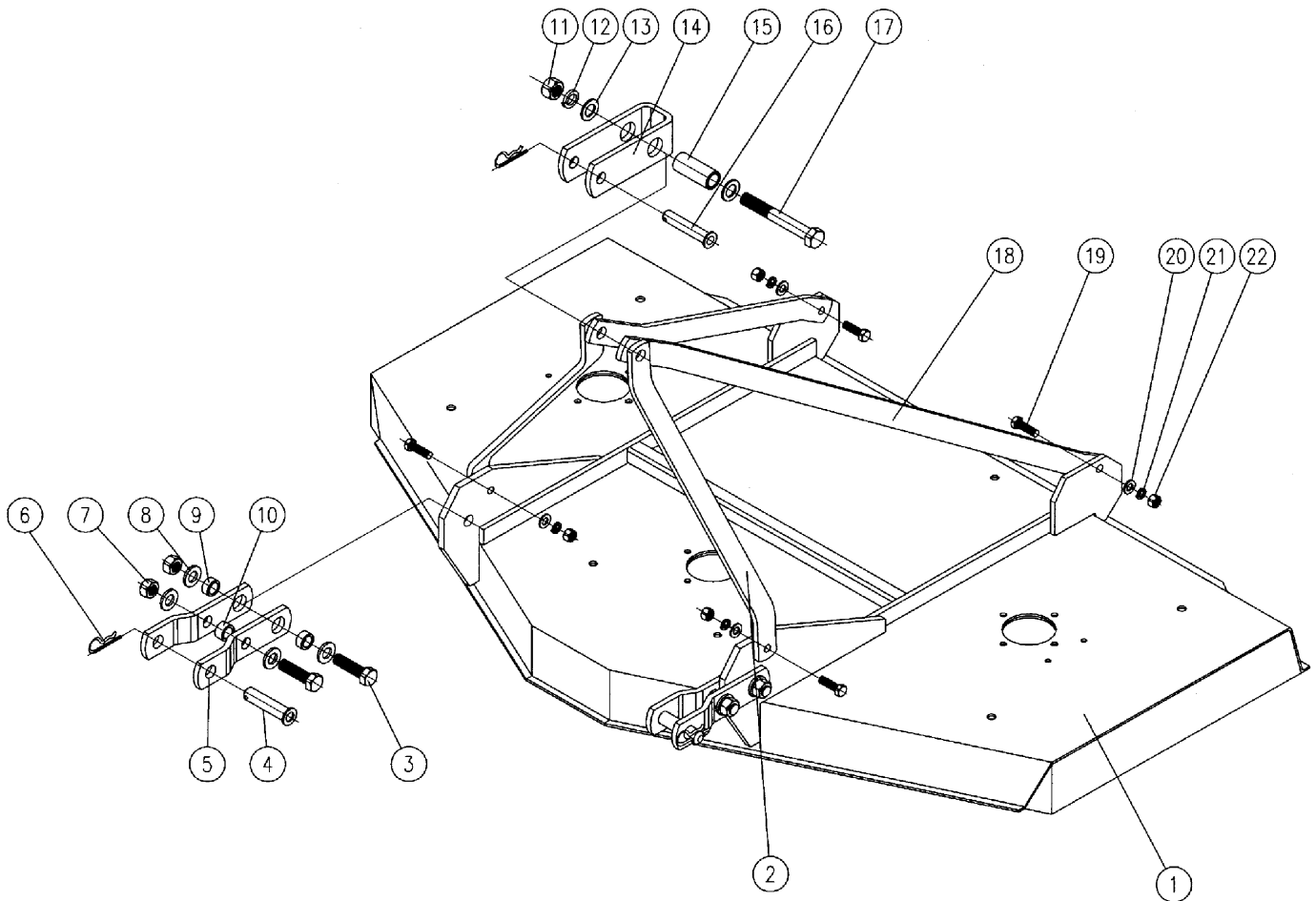

Item	Part No.	Ref No.	Description	Req'd.
1	651061	16-056	FM 60" DECK WELDMENT REAR DISCHARGE 60"	1
	651073	16-058	FM 72" DECK WELDMENT REAR DISCHARGE 72"	1
2	651040	19-185	FM FRONT HITCH BRACE	2
3	650826	06-055	M18 X 2.5 X 65 HEX HEAD BOLT	4
4	650823	12-033	Ø22 X 95 FM LOWER HITCH PIN	2
5	651041	19-213	FM LOWER HITCH BRACKET	4
6	650824	12-034	Ø4 HAIR PIN CLIP	3
7	650821	11-041	M 18 X 2.5 DEFORMED THREAD LOCK NUT	4
8	650822	07-037	Ø 18 X Ø36 X 4 FLAT WASHER ZINC PLATED	8
9	651042	10-081	FM LOWER HITCH BUSHING Ø18 X Ø28 X 13	4
10	651043	10-082	FM LOWER HITCH BUSHING Ø18 X Ø28 X 16	2
11	651044	11-042	M20 X 2.5 DEFORMED THREAD LOCK NUT	1
12	651045	07-043	Ø20 SPLIT TYPE LOCKWASHER	1
13	651046	07-041	Ø20 X Ø37 X 3 FLAT WASHER ZINC PLATED	10
14	651047	19-184	FM TOP HITCH BRACKET	1
15	651048	10-079	FM TOP HITCH BRACKET BUSHING	1
16	650832	12-032	Ø19 X 100 FM UPPER HITCH PIN	1
17	651049	06-061	M20 X 2.5 X 150 HEX HEAD BOLT	1
18	651067	19-186	FM REAR HITCH BRACE 60"	2
	651077	19-187	FM REAR HITCH BRACE 72"	2
19	650816	06-054	M12 X 1.75 X 40 HEX HEAD BOLT	4
20	650817	07-039	Ø12 X Ø24 X 2.5 FLAT WASHER ZINC PLATED	14
21	650818	07-002	Ø12 SPLIT TYPE LOCKWASHER	24
22	650819	11-039	M12 X 1.75 DEFORMED THREAD LOCK NUT	17

GEARBOX ASSEMBLY 560 & 572

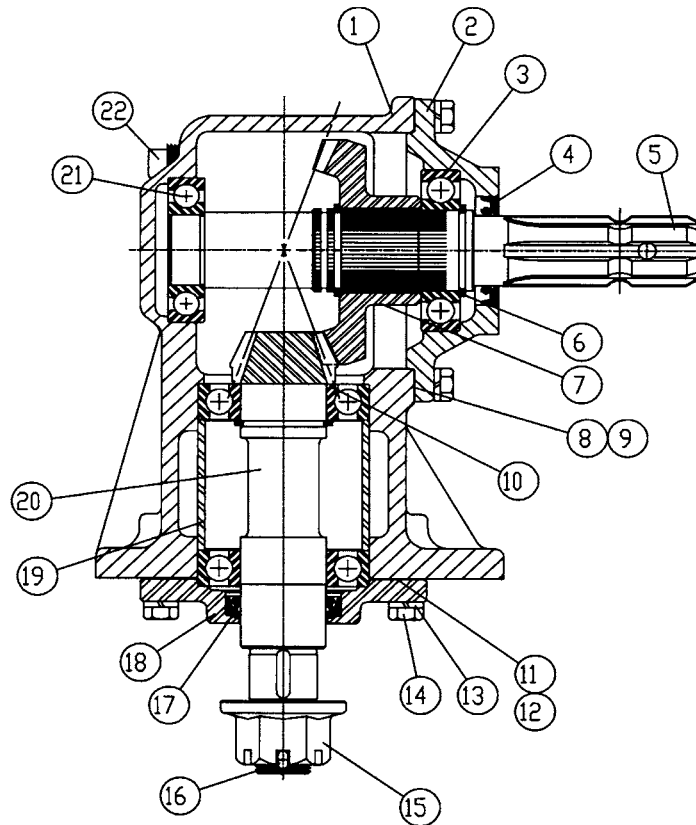

Item No.	Worksaver Part No.	Ref. No.	Description	No. Req'd.
	650876	01-193	Complete Gearbox Assembly	1
1	650835 *	18-010	Gearbox Housing	1
2	650836	20-007	Input Shaft Cap	1
3	650837	04-003	Ball Bearing 208	3
4	650838	05-002	Input Shaft Oil Seal	1
5	650839 *	02-034	Input Shaft	1
6	650840	21-012	Retaining Ring	3
7	650858 *	03-043	Input Gear (34 Tooth)	1
8	650842	08-004A	Input Shaft Gasket (0.30mm)	Var.
9	650843	08-004B	Input Shaft Gasket (0.13mm)	Var.
10	650844	17-004	Steel Shim (0.20mm)	1
11	650845	08-005A	Output Shaft Gasket (0.30mm)	Var.
12	650846	08-005B	Output Shaft Gasket (0.13mm)	Var.
13	650847	07-001	Lockwasher (10mm)	10
14	650848	06-063	Cap Screw M10 x 1.5 x 25 mm	10
15	650849	11-008	Slotted Nut, 1" - 14	1
16	650850	12-003	Cotter Pin	1
17	650851	05-005	Output Shaft Oil Seal	1
18	650852	20-003	Output Shaft Cap	1
19	650853 *	10-002	Output Shaft Bearing Spacer	1
20	650859 *	03-042	Output Shaft & Gear (12 Tooth)	1
21	650855	04-004	Ball Bearing 207	1
22	650856	09-002	Oil Fill Plug 1/2"	1
NS	650857	09-005	Level Plug 1/8"	1

Not Available *

* Must Purchase Complete Gearbox

SHIELD ASSEMBLY

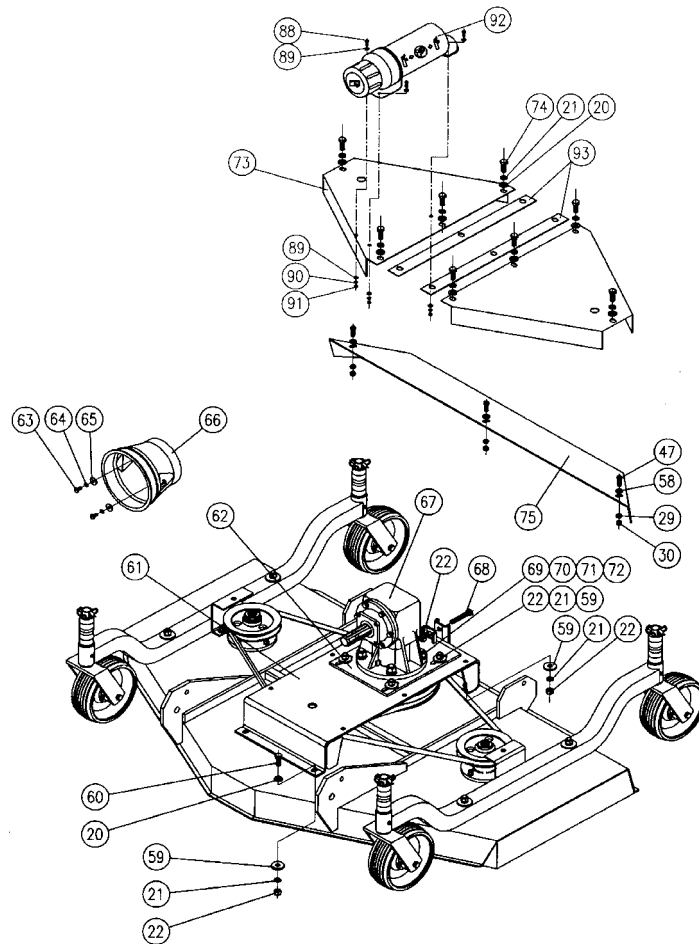

Item	Part No.	Ref No.	Description	Req'd.
20	650817	07-039	Ø12 x Ø24 x 2.5 FLAT WASHER ZINC PLATED	14
21	650818	07-002	Ø12 SPLIT TYPE LOCKWASHER	24
22	650819	11-039	M12 X 1.75 DEFORMED THREAD LOCK NUT	17
29	650847	07-001	Ø10 SPLIT TYPE LOCKWASHER	27
30	650866	11-019	M10 DEFORMED THREAD LOCKING NUT	19
47	650848	06-063	M10 X 1.5 X 25 HEX HEAD CAP SCREW	11
58	650865	07-015	Ø10 X Ø20 X 2 FLAT WASHER ZINC PLATED	7
59	650833	07-046	Ø12 X Ø37 X 5 FLAT WASHER ZINC PLATED	8
60	650932	06-062	M12 X 1.75 X 35 HEX HEAD BOLT	2
61	650869	19-165	GEAR BOX MOUNTING FRAME 60" MOWER	1
	650870	19-166	GEAR BOX MOUNTING FRAME 72" MOWER	1
62	650871	19-167	GEAR BOX SLIDE PLATE	1
63	650872	06-065	M8 X 1.25 X 25 HEX 13 BOLT	2
64	650873	07-025	Ø8 SPLIT TYPE LOCK WASHER	2
65	650874	07-040	Ø8 X Ø24 X 2 FLAT WASHER ZINC PLATED	2
66	650875	36-008	GEAR BOX INPUT PTO GUARD	1
67	650876	01-193	GEAR BOX 28S - 1:2.833 RATIO	1
68	650878	06-057	M12 X 1.75 X 70 HEX HEAD BOLT	1
69	650880	07-014	Ø16 X Ø30 X 3 FLAT WASHER ZINC PLATED	4
70	650881	07-017	Ø16 SPLIT TYPE LOCKWASHER	4
71	650882	11-020	M16 X 2.0 DEFORMED THREAD LOCKING NUT	4
72	650931	06-059	M16 X 2.0 X 50 ALLEN HEAD BOLT	4
73	651066	36-010	FM 560 BELT GUARD	2
	651076	36-012	FM 572 BELT GUARD	2
74	650864	06-015	M12 X 1.75 X 25 HEX HEAD BOLT	8
75	650884	36-001	FM 60" REAR DISCHARGE DEFLECTOR	1
	650885	36-003	FM 72" REAR DISCHARGE DEFLECTOR	1
88	651054	06-079	M6 X 1 X 20 HEX HEAD BOLT	3
89	651055	07-066	M6 FLAT WASHER	6
90	651056	07-029	Ø6 SPLIT TYPE LOCKWASHER	3
91	651057	11-052	M6 X 1 DEFORMED THREAD LOCKNUT	3
92	2504225	01-315	MANUAL HOLDER	1
93	651058	19-245	BELT GUARD FOAM PAD	2

BLADE AND SPINDLE ASSEMBLY

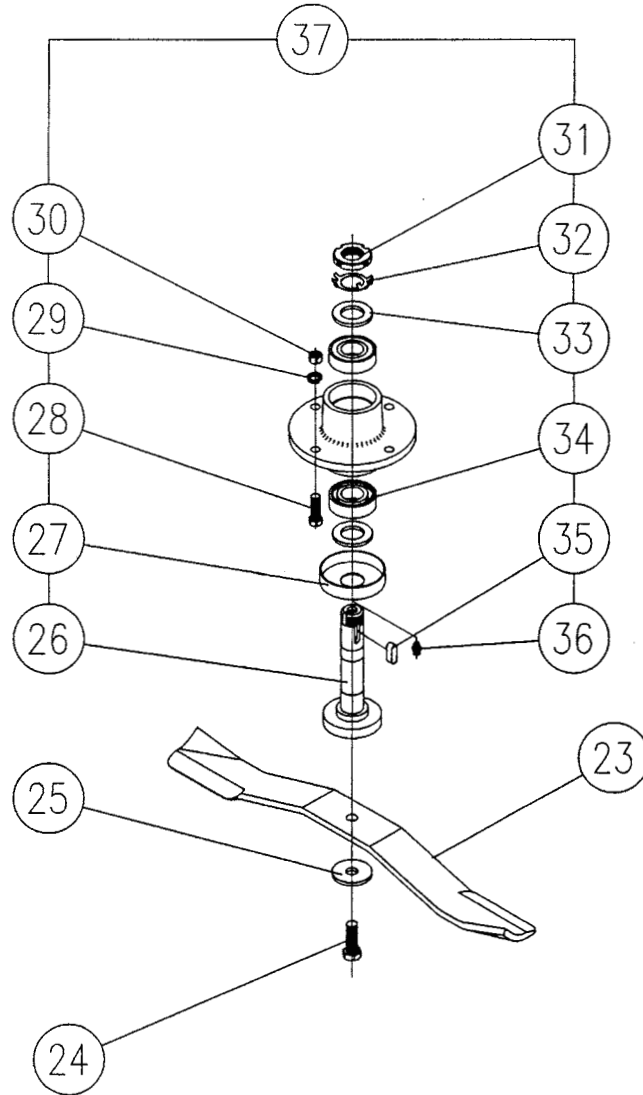

Item	Part No.	Ref No.	Description	Req'd.
23	651065	30-050	FM 560 BLADE (LEFT HAND)	3
	651075	30-052	FM 572 BLADE (LEFT HAND)	3
24	650902	06-056	M12 X1.75 X 35 HEX HEAD BOLT LEFT HAND THREAD	3
25	650903	07-044	Ø12 X Ø44 X4 PLAIN FLAT WASHER	11
26	650907	02-126	BLADE SPINDLE SHAFT	3
27	650908	20-071	BLADE SPINDLE DUST CAP	3
28	650904	06-064	M10 X 1.5 X 30 CAP SCREW	16
29	650847	07-001	Ø10 SPLIT TYPE LOCKWASHER	27
30	650866	11-019	M10 DEFORMED THREAD LOCKING NUT	19
31	650912	11-040	M25 X 1.5 BEARING LOCK NUT	3
32	650911	07-042	Ø25 BEARING LOCKWASHER	3
33	650910	07-038	Ø26 X Ø44 X 4 FLAT WASHER	6
34	650906	04-086	205 BALL BEARING, SHIELD AND SEAL ONE SIDE	6
35	650914	14-014	8 X 7 X 25 ROUND END KEY	3
36	650913	09-014	M8 X 1 GREASE ZERK - TB - 1 STRAIGHT	7
37	650897	01-252	SPINDLE ASSEMBLY / LESS BLADE AND PULLEY	3

PULLEY, BELT AND WHEEL ASSEMBLY

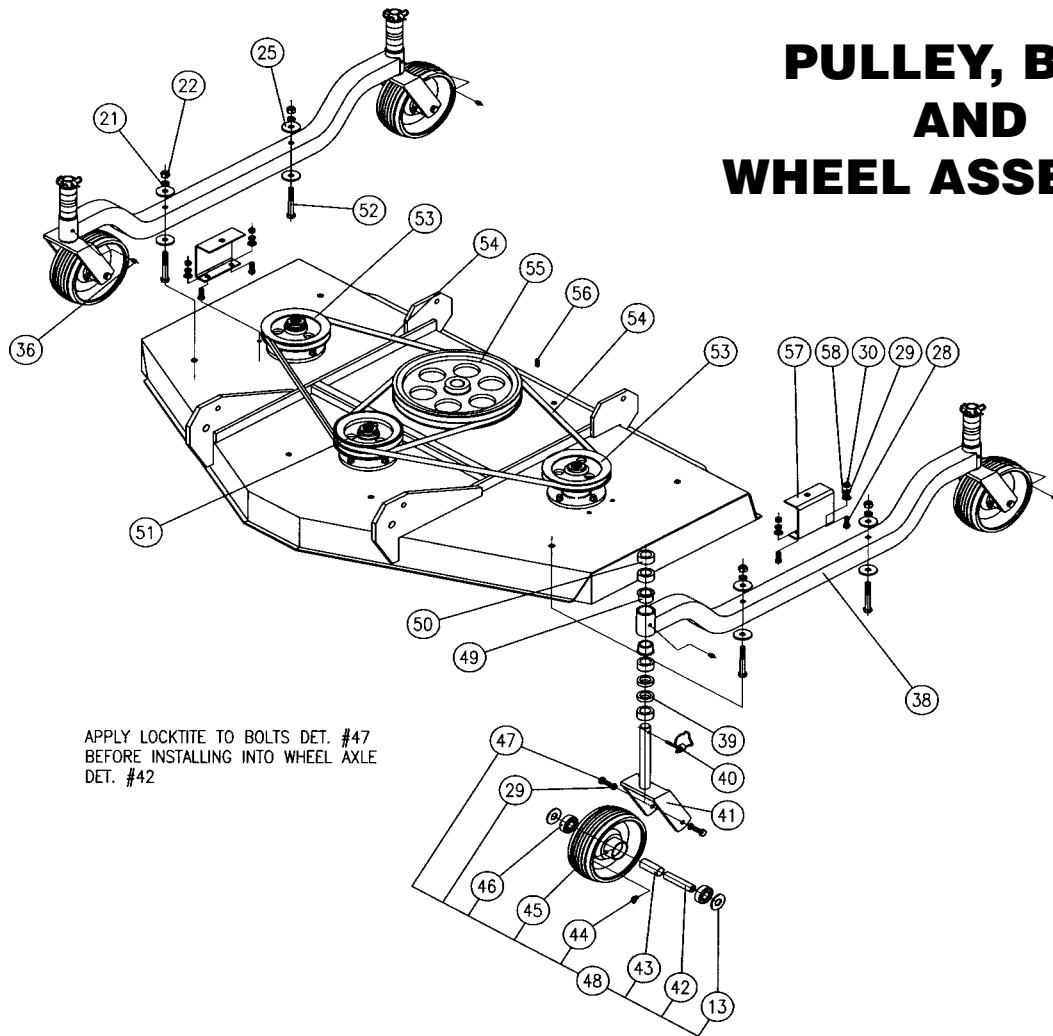

APPLY LOCKTITE TO BOLTS DET. #47
BEFORE INSTALLING INTO WHEEL AXLE
DET. #42

Item	Part No.	Ref No.	Description	Req'd.
13	650921	07-041	Ø20 x Ø37 x 3 FLAT WASHER ZINC PLATED	10
21	650818	07-002	Ø12 SPLIT TYPE LOCKWASHER	24
22	650819	11-039	M12 X 1.75 DEFORMED THREAD LOCK NUT	17
25	650903	07-044	Ø 12 x Ø 44 x 4 PLAIN FLAT WASHER	11
28	650904	06-064	M10 X 1.5 X 30 CAP SCREW	16
29	650847	07-001	Ø10 SPLIT TYPE LOCKWASHER	27
30	650866	11-019	M10 DEFORMED THREAD LOCKING NUT	19
36	650913	09-014	M8 X 1 GREASE ZERK - TB- 1 STRAIGHT	7
38	651068	19-181	FM 560 FORMED AXLE MOUNTING BAR	2
	651078	19-183	FM 572 FORMED AXLE MOUNTING BAR	2
39	650919	10-080	WHEEL HEIGHT ADJUSTING SPACER Ø26 X Ø40 X 9.5	8
40	651050	12-038	Ø6 SPRING LINCH PIN	4
41	650920	19-174	WHEEL YOKE	4
42	650922	02-125	WHEEL AXLE	4
43	650923	10-076	AXLE BEARING SPACER Ø22 X Ø25 X 58	4
44	650924	09-036	M8 X 1 X 45' GREASE ZERK	4
45	650933	19-175	Ø208 X 76 GAGE WHEEL	4
46	650925	04-085	204KP BALL BEARING SHIELD AND SEAL ONE SIDE	8
47	650848	06-063	M10 X 1.5 X 25 CAP SCREW, HEX HEAD	11
48	650926	16-059	Ø208 X 76 GAGE WHEEL AND AXLE ASSEMBLY	4
49	651051	04-061	PIVOT TUBE FLANGED BUSHING	8
50	650927	10-075	WHEEL HEIGHT ADJUSTING SPACER Ø26 X Ø40 X 19	16
51	650895	33-004	FM 60" - Ø156 CENTER DOUBLE PULLEY	1
	650896	33-006	FM 72" - Ø180 CENTER DOUBLE PULLEY	1
52	651052	06-067	M12 X 1.75 X 80 HEX HEAD BOLT	4
53	650887	33-005	FM 60" - Ø156 OUTER SINGLE PULLEY	2
	650888	33-007	FM 72" - Ø180 OUTER SINGLE PULLEY	2
54	650890	34-001	FM 60" V-BELT B75 (1950.72mm PITCH LENGTH)	2
	650891	34-003	FM 72" V-BELT B89 (2306.32mm PITCH LENGTH)	2
55	650892	33-001	FM Ø300 MAIN INPUT DOUBLE PULLEY	1
56	650893	14-013	1/4" X 1/4" X 1 1/8" ROUND END KEY	1
57	651053	19-214	FM OUTER SHIELD BRACKET	2
58	650865	07-015	Ø10 X Ø20 X 2 FLAT WASHER ZINC PLATED	7

⚠ SAFETY PRECAUTIONS ⚠

**MOST ACCIDENTS OCCUR BECAUSE OF NEGLIGENCE OR CARELESSNESS.
AVOID NEEDLESS ACCIDENTS BY FOLLOWING ALL OF THE SAFETY PRECAUTIONS LISTED BELOW.**

- Machinery should be operated only by those who are responsible and are authorized to do so.
- Stop the engine, lower all equipment, lock the brakes, and remove the ignition key before dismounting from the tractor.
- Never stand between tractor and implement while tractor is being backed to hitch.
- Loose fitting clothing should not be worn, to avoid catching on various parts.
- Detach implement in area where children normally do not play.
- When performing adjustments or maintenance on an implement, first lower it to the ground or block it securely at a workable height.
- Only a qualified operator should be permitted on tractor when in operation; no riders allowed.
- Make certain everyone is in the clear before starting tractor or raising or lowering equipment.
- Operate the tractor and implement only while seated in the driver's seat.
- Reduce speed when transporting mounted implements to avoid bouncing and momentary loss of steering control.
- A heavy load can cause instability of the tractor. Use extreme care during road travel. Slow down on turns and watch out for bumps. Tractor may need front counterweights to counter-balance the weight of the implement.
- Reduce speed on hillsides or curves so there is no danger of tipping.
- Avoid driving too close to the edge of ditches or creeks.
- Do not transport implement on public roads without reflectors and slow moving vehicle emblem in daylight and with approved warning lights at night and other periods of poor visibility.
- Due to the width of some implements, use extra caution on highways, farm roads, and when approaching gates.
- Always be sure the implement is in the proper position for transport.
- Keep alert and watch the front as well as the rear when working with the implement.

OWNER'S/ OPERATOR'S MANUAL

MODEL NO's

FM 560

FM 572

3 PT. REAR FINISHING MOWER

For Cat. I 3-Pt. Hitch Tractors up to 35 HP

WHEN ORDERING REPAIR PARTS, ALWAYS GIVE THE FOLLOWING INFORMATION:

- | | |
|---------------------|-----------------|
| 1. PART NUMBER | 3. MODEL NUMBER |
| 2. PART DESCRIPTION | 4. NAME OF ITEM |

WORKSAVER LIMITED WARRANTY

Worksaver warrants its implements, parts and accessories to be free from defects in materials and workmanship for a period of six (6) months from date of purchase. Upon written approval, Worksaver will repair or exchange without charge any part, which upon examination by Worksaver or its authorized agent, shall disclose to be defective.

This does not apply to (1) parts that have worn out in normal use, (2) parts broken because of improper assembly or operation by the customer, (3) parts accidentally damaged, (4) failure of parts traceable to improper care, (5) parts failing through use of implement for purposes other than those for which it was designed.

The obligations assumed by Worksaver and the limitations expressed herein are in lieu of all other warranties expressed or implied.

WORKSAVER

P.O. BOX 100 LITCHFIELD, IL 62056-0100 (217) 324-5973
WEB: <http://www.worksaver.com> E-MAIL: sales@worksaver.com