

RC SPY HUNTER

INSTRUCTION MANUAL

CAUTION:
Hair entanglement may result if child's hair comes in contact with moving parts of toy. Adult supervision is required.

Battery Requirements
Spy Hunter 4 x AA (not included)
Controller 1 x 9V (not included)

WARNING:
CHOKING HAZARD - Small parts.
Not for children under 3 years.

SPY HUNTER

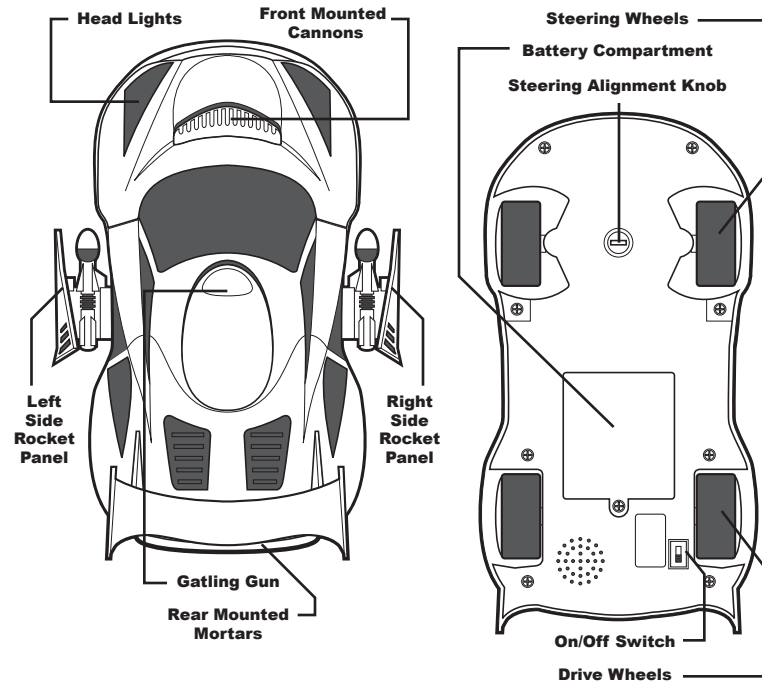

CONTROLLER

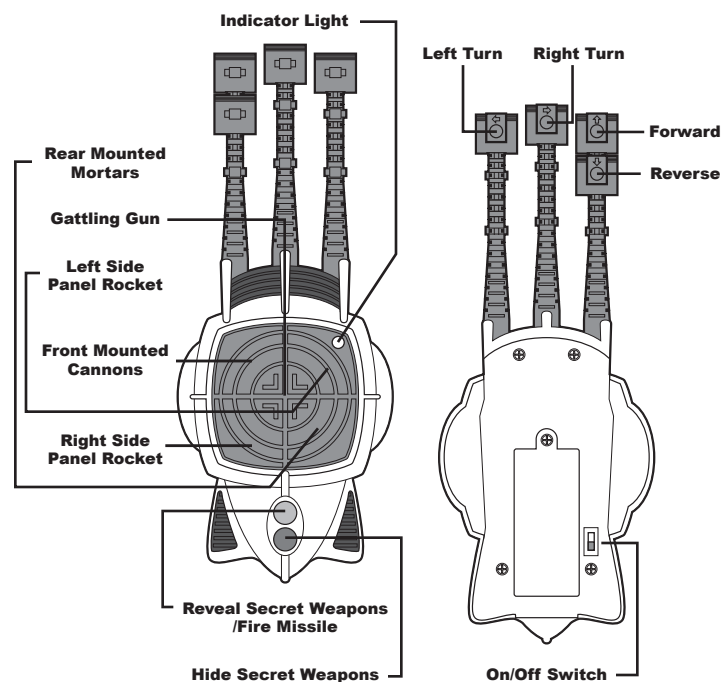

BATTERY INSTALLATION AND POWER ON/OFF

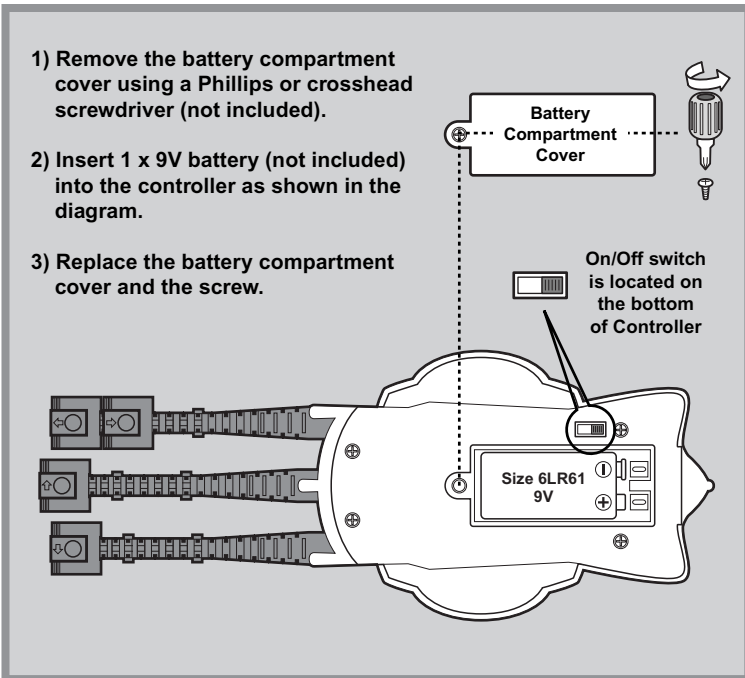
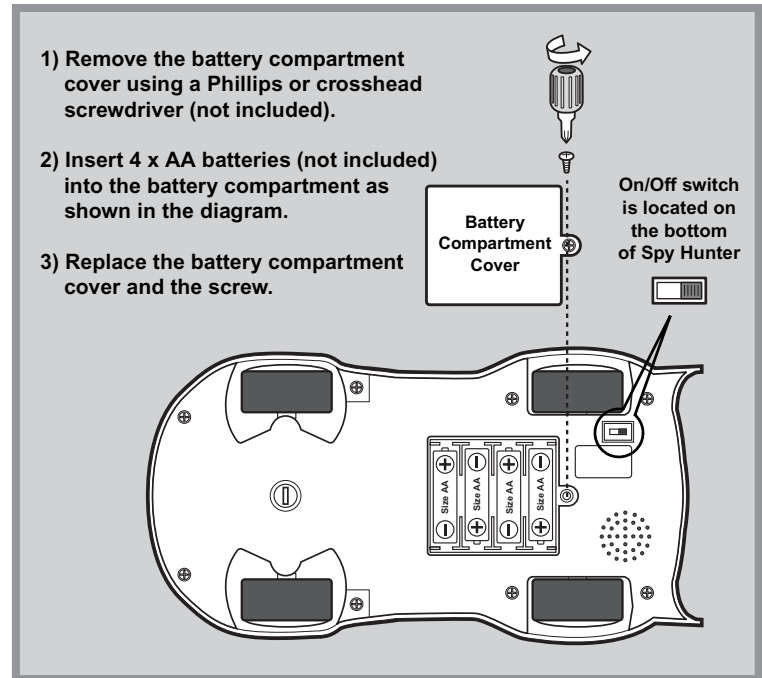

Attention: Important Battery Information

- Use only fresh batteries of the required size and recommended type.
- Do not mix old and new batteries, different types of batteries (standard alkaline, or rechargeable), or rechargeable batteries of different capacities.
- Remove rechargeable batteries from the toy before recharging them.
- Rechargeable batteries are only to be charged under adult supervision.
- Please respect the correct polarity, (+) and (-).
- Do not dismantle batteries of any type.

- Do not try to charge non-rechargeable batteries.
- Do not throw batteries into the fire.
- Replace all batteries of the same type/brand at the same time.
- Do not short-circuit the battery contacts.
- Remove exhausted batteries from the toy.
- Batteries should be replaced by adults because of small parts.
- Remove batteries if the toy is not going to be played with for some time.

USING THE CONTROLLER

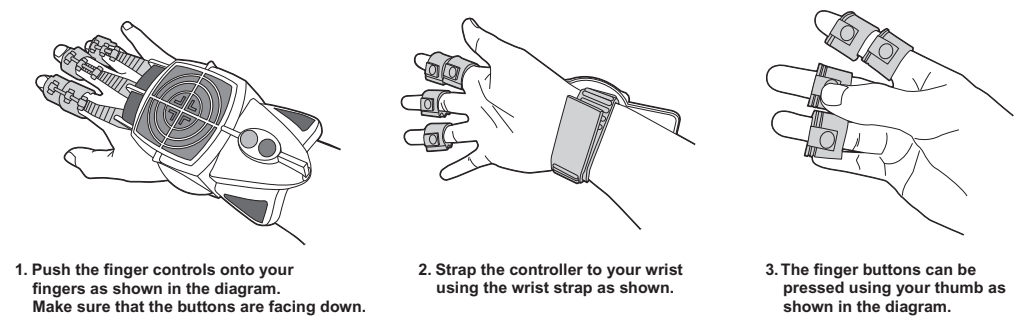

MOUNTING THE MISSILE



DRIVING THE SPY HUNTER

- Turn on the Spy Hunter and the controller using the On/Off switches.
- The Spy Hunter headlights will glow as long as the Spy Hunter battery has power. The Spy Hunter will power down after a few minutes of no action and the headlights will turn off. To use the car again, turn the On/Off switch off and back on again.
- The indicator light on the controller will glow when a button is pressed, as long as the controller has power.

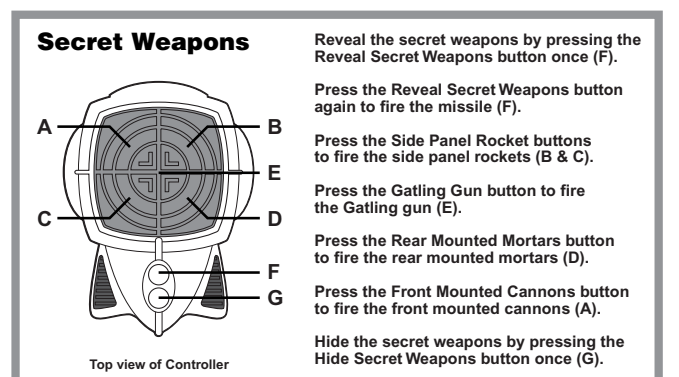
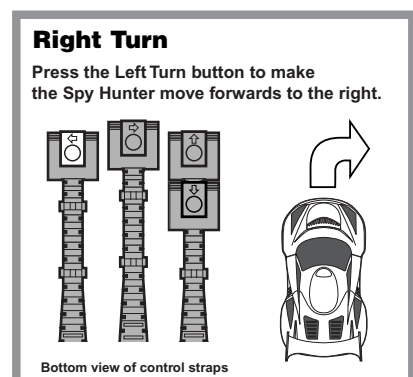
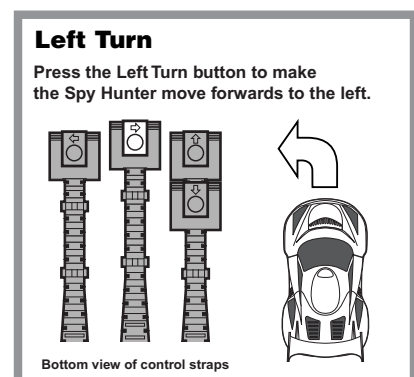
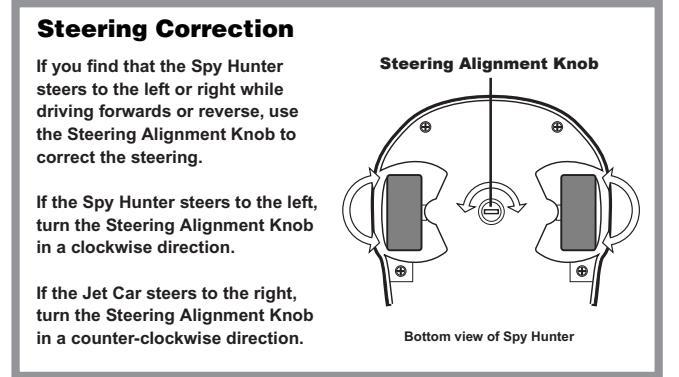
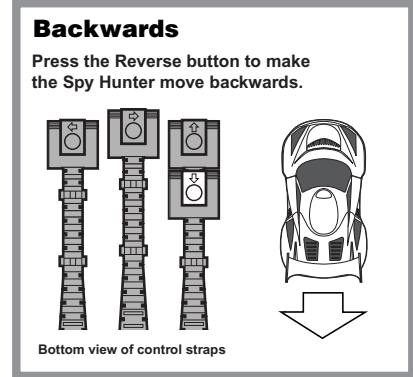
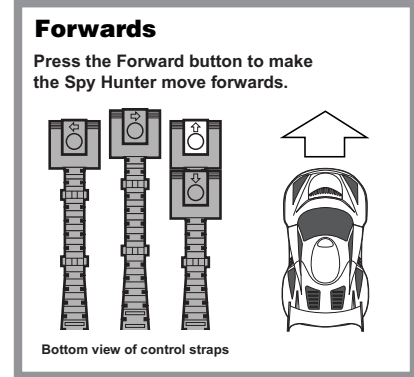

- Driving & Safety Tips:**
- Never fire the missile at other people or pets.
 - The missile is a small object, be careful not to let young children play with it.
 - When you have finished playing, make sure that you turn the On/Off switch on the controller and the Spy Hunter to "Off".
 - Remember that when the vehicle is coming towards you, it will steer in the opposite direction to the way you turn the wheel. Try to imagine that you are in the driver's seat to work out the direction it will turn in.
 - Keep fingers, hair and loose clothing away from the tires and wheels while the vehicle is in motion.
 - Never drive your Spy Hunter on the streets.
 - Do not pick up the vehicle while it is in motion.
 - Do not drive the vehicle through water.
 - For best results, hold the antenna up, not pointing down towards the vehicle.

This device complies with Part 15 of the FCC Rules. Operation is subject to the following two conditions: (1) This device may not cause harmful interference, and (2) This device must accept any interference received, including interference that may cause undesired operation.

NOTE: This equipment has been tested and found to comply with the limits for a Class B digital device, pursuant to Part 15 of the FCC Rules. These limits are designed to provide reasonable protection against harmful interference in a residential installation. This equipment generates, uses and can radiate radio frequency energy and, if not installed and used in accordance with the instructions, may cause harmful interference to radio communications. However, there is no guarantee that interference will not occur in a particular installation. If this equipment does cause harmful interference to radio or television reception, which can be determined by turning the equipment off and on, the user is encouraged to try to correct the interference by one or more of the following measures:

- Reorient or relocate the receiving antenna.
- Increase the separation between the equipment and the receiver.
- Connect the equipment into an outlet on a circuit different from that to which the receiver is needed.
- Consult the dealer or an experienced radio/TV technician for help.

WARNING: Changes or modifications to this unit not expressly approved by the party responsible for compliance could void the user's authority to operate the equipment.

Please keep these instructions as they contain important information



Manufactured and distributed by
© 2004 WowWee Ltd.
All Rights Reserved.

WowWee (Asia Office)
Unit 301A-C, 92 Granville Rd.,
T.S.T. East, Hong Kong

WowWee (North America Office)
4480 Cote de Liesse, Suite 320,
T.M.R. Quebec, H4N 2R1, Canada
Consumer Hotline: (514) 344-1250
www.wowwee.com

We recommend that you retain our address for future reference.
Printed in China.

EL0235US01