



Pro-Kart Racer

Instruction Manual

Item No.0223
Ages 4+
 PRO-KART RACER
4 x AA
 BATTERIES NOT INCLUDED
 REMOTE CONTROL
1 x 9V
 BATTERIES NOT INCLUDED

SAFETY AND PLAYING TIPS:

Please read instructions carefully before operating Pro-Kart Racer.

1. NEVER drive your vehicle on streets.
2. DO NOT pick up vehicle while in motion.
3. Keep fingers, hair, and loose clothing away from the tires and the wheel hubs while the vehicle is switched ON.
4. Keep vehicle and parts out of reach of very young children. Adult supervision is recommended.
5. Do not play outdoors during thunderstorms.
6. Do not drive your vehicle in sand or through water or snow.
7. Always turn your vehicle and transmitter "OFF" when not in use.
8. Do not store near heat or direct sunlight.

DRIVING YOUR PRO-KART RACER

To start up the engine, turn the Pro-Kart Racer and transmitter to ON. Then fully extend the antenna on the transmitter. Now you are ready to race!

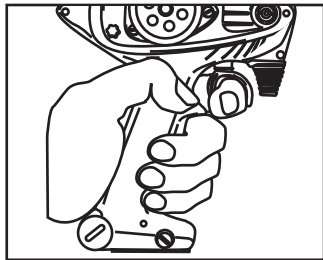

1. To go forward, pull the trigger.

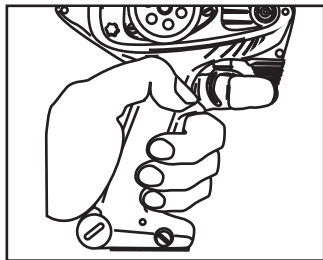
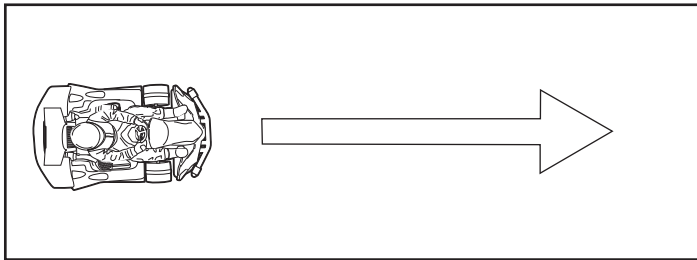

2. To go in reverse, push the trigger forward.

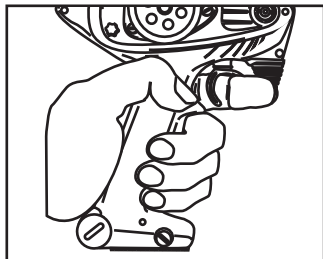
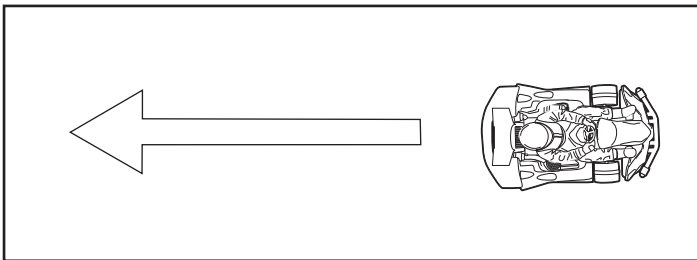

3. To stop, release the trigger.

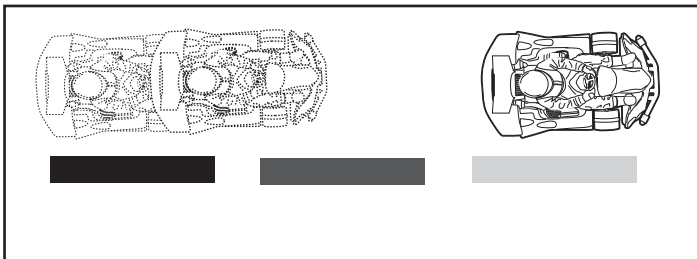

- Helpful tips:
- For maximum speed, fully pull the trigger.
 - Control the speed by releasing slowly.
 - Be a Pro! Practice at different speeds and stopping by varying the amount you pull the trigger.

TURNING

When the motor is running (trigger is pulled), Pro-Kart Racer turns with the turning angle of the steering wheel.

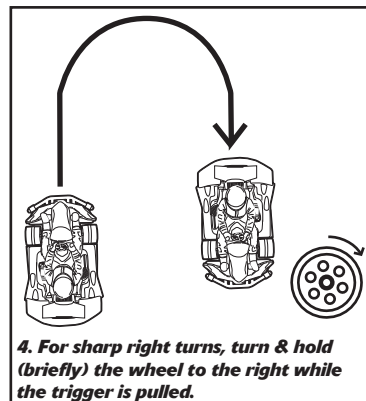
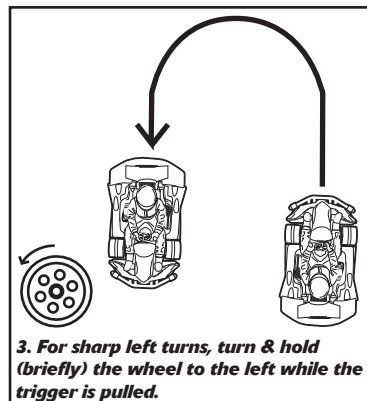
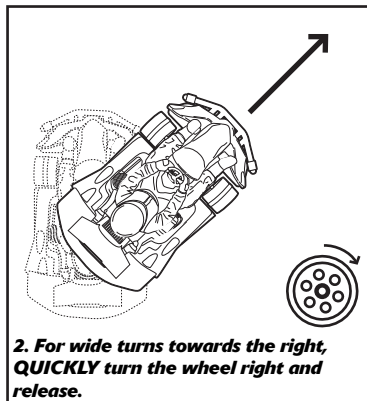
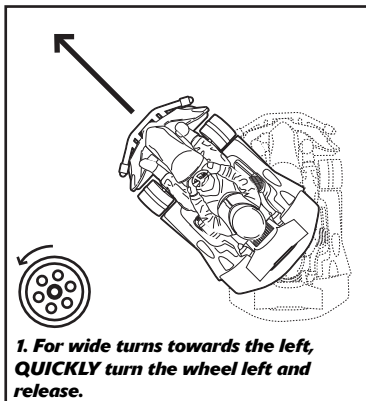

Helpful tip: Remember that when Pro-Kart Racer is coming towards you, the steering is opposite to the way you turn.

Please note: The illuminated red light on the hand controller indicates that the remote controller is in operation.

ASSEMBLY

1. Before you begin to play, screw-in the transmitter antenna into the transmitter. For further details see Battery and Power ON/OFF Diagram.

Contents

Pro-Kart Racer

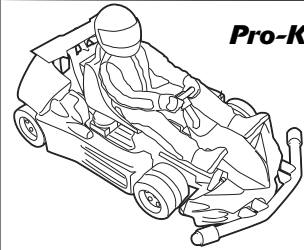

Transmitter (controller)

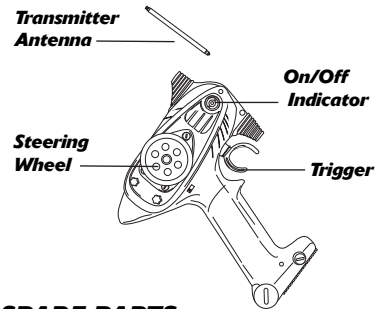

SPARE PARTS

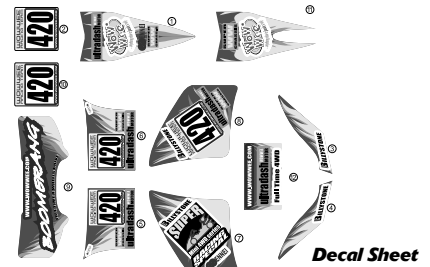
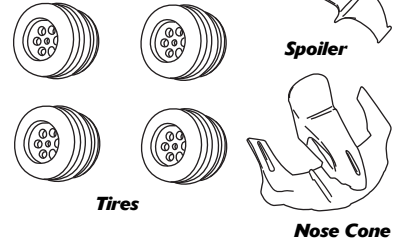

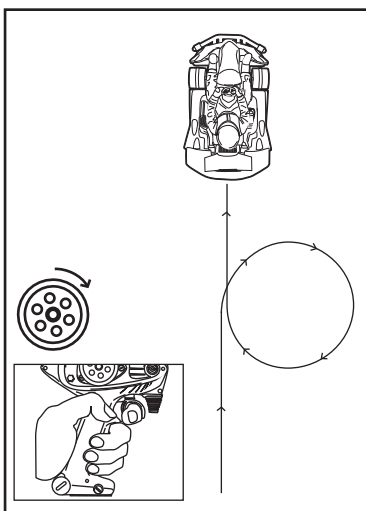

1. For super fast 360° spins, turn the wheel all the way to the right or left, while the trigger is fully pulled.

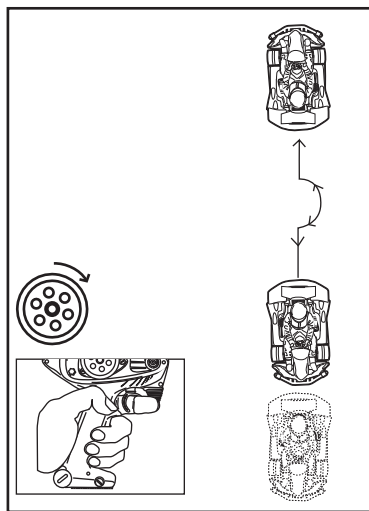

2. Do a reverse 180°! Drive in reverse, then spin the racer around 180° and drive forward! Drive like a PRO for this stunt!

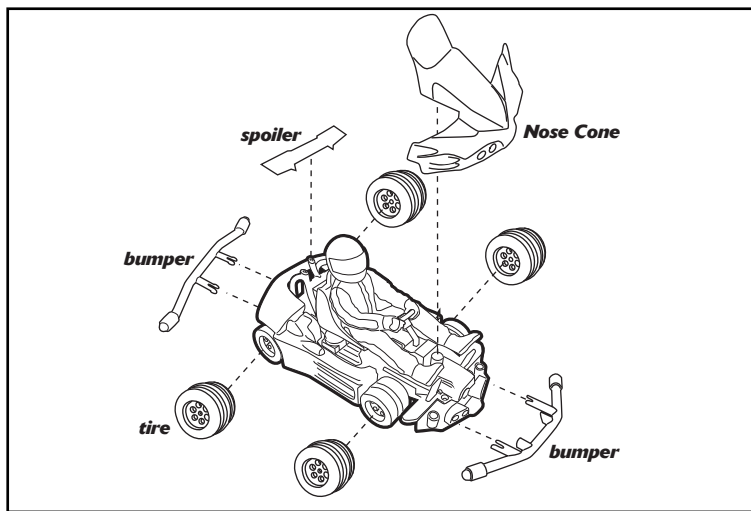

See how fast you can change all of the spare parts - the tires, spoiler and bumper! Use a phillips screw driver to change the tires. For the nose cone, gently remove the front bumper then replace the nose cone. Spoiler: gently remove and replace.

BATTERY AND POWER ON/OFF DIAGRAM

BATTERY REQUIREMENTS
 4x "AA" Batteries (Pro-Kart Unit)
 1x "9V" Battery (Remote Controller)
 Batteries not included

POWER ON / OFF SWITCH

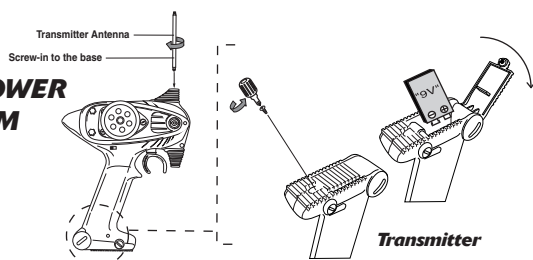

Transmitter

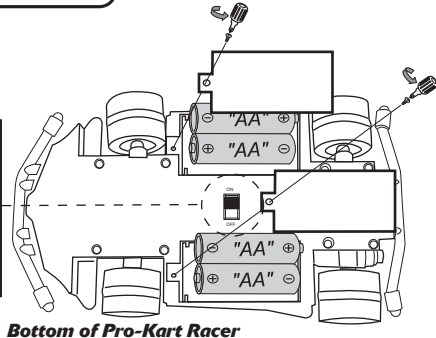

Bottom of Pro-Kart Racer

BATTERY INSTALLATION

- Remove the battery compartment cover using a screwdriver as shown.
- Insert correct battery - as shown in diagram, making sure to match the polarity direction.
- Replace the battery cover.

Note: •Quality of control function may deteriorate when battery power is low.

APPLYING DECALS

- Apply the decals as shown, in orderly sequence from 1

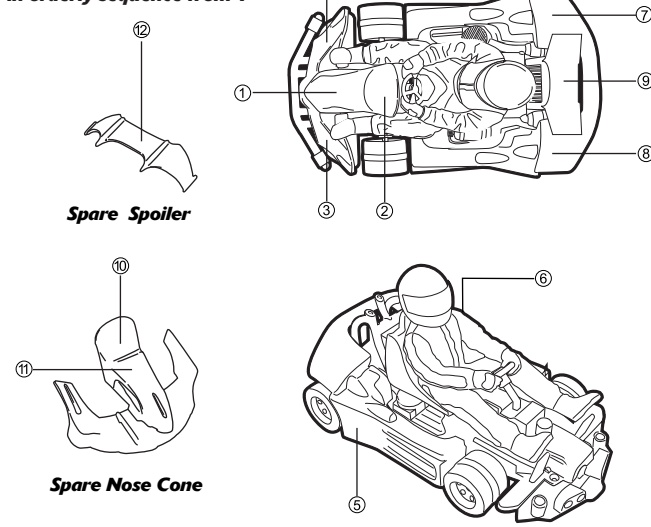

Spare Spoiler

Spare Nose Cone

ATTENTION !!! IMPORTANT BATTERY INFORMATION

- Use only fresh batteries of the required size and recommended type. Do not mix old and new batteries, different types of batteries (standard alkaline, or rechargeable), or rechargeable batteries of different capacities. We suggest the use of alkaline batteries for best results.
- Please respect the correct polarity (+) and (-)
- Do not try to recharge batteries, nor to open them.
- Do not throw batteries into the fire.
- Remove rechargeable batteries from the toy before being charged.
- Rechargeable batteries are only to be charged under adult supervision.
- Use only the battery types as recommended.
- Replace all batteries of same type/brand at the same time.
- Do not short-circuit the battery contacts.
- Remove exhausted batteries from the toy.

This device complies with Part 15 of the FCC Rules. Operation is subject to the following two conditions: (1)This device may not cause harmful interference, and (2)This device must accept any interference received, including interference that may cause undesired operation.

NOTE: This equipment has been tested and found to comply with the limits for a Class B digital device, pursuant to Part 15 of the FCC Rules. These limits are designed to provide reasonable protection against harmful interference in a residential installation. This equipment generates, uses and can radiate radio frequency energy and, if not installed and used in accordance with the instructions, may cause harmful interference to radio communications. However, there is no guarantee that interference will not occur in a particular installation. If this equipment does cause harmful interference to radio or television reception, which can be determined by turning the equipment off and on, the user is encouraged to try to correct the interference by one or more of the following measures:

- Reorient or relocate the receiving antenna.
- Increase the separation between the equipment and receiver.
- Connect one equipment into an outlet on a circuit different from that to which the receiver is needed.
- Consult the dealer or an experienced radio / TV technician for help.

WARNING:

Changes or modifications to this unit not expressly approved by the party responsible for compliance could void the user's authority to operate the equipment.



NG0223us01

AGES: 4 +
ITEM NO. 0223

Manufactured and Distributed by:
 © 2002 WowWee
 All rights reserved.
 WowWee (Asia Office)
 Unit 301A-C, 92 Granville Rd.,
 T.S.T. East, Kowloon, H.K.
 WowWee (North America Office)
 4480 Cote de Liesse, Suite 320,
 T.M.R. Quebec, H4N 2R1, Canada
 Consumer Hotline: (514) 344-1250
<http://www.wowwee.com>
 Printed in China