

Operator's Manual

P-2000 and C-2000/RT-2000

Transceiver Systems



P-2000

Part Number: 400-049200-11-xxx-xxxx-xxxx

Software Version: 1

C-2000

Part Number 400-049300-11-xxx

Software Version: 1

RT-2000

Part Number 400-049400-11-xxx-xxxx-xxxx

Software Version: 1

**P-2000/C-2000/RT-2000
Operator's Manual**

TABLE OF CONTENTS

INTRODUCTION	3
FEATURES	4
TRANSCEIVER OVERVIEW	5
BASIC OPERATIONS.....	6
FRONT PANEL & CONTROLS.....	6
KEYPAD BUTTONS.....	7
THE HOME PAGE	8
SETTING THE DISPLAY BRIGHTNESS.....	11
SETTING THE VOLUME LEVEL	11
SELECTING THE ACTIVE TRANSCEIVER	12
SELECTING A STANDBY CHANNEL USING THE CURSOR/VALUE KNOB.....	13
SELECTING A CHANNEL USING THE KEYPAD	13
SELECTING A CHANNEL BY ALPHANUMERIC IDENTIFIER	14
USING THE DIRECT/REPEAT FEATURE.....	14
RECEIVING/TRANSMITTING	15
ENABLING/DISABLING TRANSCEIVERS.....	15
QMEM OPERATIONS	16
MESSAGE PAGE.....	17
PROGRAMMING/EDITING A PRESET CHANNEL	19
EDITING A PRESET CHANNEL	20
CHANGING TRANSMIT POWER.....	20
ENHANCED SYSTEM FEATURES.....	21
RELAY MODE.....	21
SIMULCAST MODE.....	22
RELAY/SIMULCAST MODE	23
REPEATER MODE.....	24
XTS-EMULATION MODE	25
PHONE PATCH MODE	25
ENCRYPTION FEATURES	26
TURNING ENCRYPTION ON AND OFF	26
SELECTING AN ENCRYPTION KEY.....	26
PERFORMING AN OTAR	27
LOADING ENCRYPTION KEYS	29
ERASING ENCRYPTION KEYS WITH A KEYLOADER	30
CPS MODE	31
LOADING CHANNEL MEMORY	31
SYSTEM SETUP MODE.....	33
MAINTENANCE PAGES	35
FLASHPORT MODE.....	36
DIGITAL POT TUNING MODE	36
SOFTWARE VERSIONS DISPLAY PAGE	37
STEPS TO SUCCESSFUL SETUP AND OPERATION.....	39

RF Exposure Information

This radio is restricted to occupational/controlled applications where users have been made aware of the potential for exposure and can exercise control over their exposure.

Antennas used for the radio must not exceed the antenna gain shown below for each transmit frequency range. The antenna must be installed at least or exceeding the minimum distance away from any person(s) depending on the transmit frequency.

Frequency	Max Antenna Gain	Min Distance
136 – 174 MHz	0 dBi	21 cm (8.3 in)
403 - 470 MHz	3 dBi	25 cm (9.9 in)
450 – 520 MHz	3 dBi	25 cm (9.9 in)
806 – 870 MHz	3 dBi	21 cm (8.3 in)

Transmit no more than 50 % of the time. Measurable RF energy exposure occurs only when transmitting.

Failure to observe these restrictions will result in exceeding the FCC RF exposure limits.

P-2000/C-2000/RT-2000
Operator's Manual

Introduction

The Wulfsberg "2000" family of Flexcomm products are comprised of the P-2000 panel mount transceiver and the RT-2000 remote mount transceiver which is controlled by the C-2000 control head. The P-2000 and RT-2000 are capable of being populated with one or two **ITM's** (Internal Transceiver Modules) covering any combination of the following frequency bands: VHF 136-174 MHz, UHF -1 (403-470 MHz), UHF -2 (450-520 MHz) and UHF800 (806-870 MHz). For applications where multiple points of user operation are required, one or more C-2000's can be added.

For purposes of this manual the term "P-2000" shall be used to describe a P-2000 or C-2000/RT-2000 installation. In both systems, the features and user interface is identical.

Features

The P-2000 provides a host of powerful features, including:

- Multi-band operations: One or Two **ITM's** covering any combination of the following frequency bands:
 - 136 - 174 MHz (10/1 Watt Transmit Power)
 - 403 - 470 MHz (10/1 Watt Transmit Power)
 - 450 - 520 MHz (10/1 Watt Transmit Power)
 - 806 - 870 MHz (3/1 Watt Transmit Power)
- Clear and bright Color LCD display showing Active/Standby channel selection along with other critical operational information.
- 255 Preset channel memory in each internal transceiver module.
- The powerful yet incredibly simple user interface that allows the user to select channels using the firm tactile feedback keypad or rotary knobs.
- Modulation types available in the P-2000 include FM analog, P25 Digital conventional, P25 Trunking and Motorola 3600 Baud Trunking. Transceivers are capable of operating on 12.5 kHz, 20.0 kHz, and 25.0 kHz channels depending on options.
- Multiple types of encryption are available as options (AES, DES, DES-XL, DES-OFB, DVP and DVI). In addition, MDC1200 OTAR and P25 OTAR are standard in all models that include encryption capability.
- One or Two microphone/headset interfaces are supported. This provides retrofit applications the ability to use both transceivers even if only one microphone/headset port is available on the aircraft audio panel system. If two microphone/headset ports are used, the P-2000 is capable of independent operation of each **ITM**. In other words, one user can be operating on FM1 while the other user independently uses FM2.
- Advanced multi-radio modes, such as Relay, Simulcast and Relay-Simulcast.
- Programming port on the front of the panel allows for computer loading of channel information and encryption key loading.

**P-2000/C-2000/RT-2000
Operator's Manual**

- Wulfsberg's exclusive QMEM (Quick Memory) function allows for fast access to preset memory channels.

Transceiver Overview

The Wulfsberg 2000 family of radio products are FM Tactical transceivers that incorporates one or two transceiver modules and control functions into a single panel mount unit (P-2000) or a panel mount control head (C-2000) and remote mount RT-2000 Transceiver. Part number variations of the unit exist for any combination of the following frequency bands: 138-174 MHz, 403-470 MHz, 450-520 MHz, and 806-870 MHz. Each transceiver module with the exception of the 806-870 MHz band can transmit with 1 or 10 Watts transmit power. The 800 MHz unit produces 1 and 3 watts transmit power. The P-2000 can operate by itself or in conjunction with the C-2000 control display acting as a remote slave control. Input voltage is 28 volts DC and the keypad is backlit from either 28VDC, 5 VDC or 5 VRMS AC.

The Wulfsberg C-2000 is a control display unit that can be used as a slave control head with a P-2000 panel mount transceiver, or as a primary or slave control head for the RT- 2000 remote transceiver. Versions of the C-2000 include black faceplate and options for either Standard or NVG compatible displays. Input voltage is 28 volts DC and the keypad is backlit from either 28 VDC, 5 VDC or 5 VRMS.

The Wulfsberg RT-2000 is a remote mounted transceiver that incorporates one or two transceiver modules in a remote mounted unit. It must be controlled by at least one C-2000 control head. Additional C-2000's can be added to the system for multi-positional control of the transceiver. Part number variations of the unit exist for any combination of the following frequency bands: 138-174 MHz, 403-470 MHz, 450-520 MHz, and 806-870 MHz. Each transceiver module with the exception of the 806-870 MHz band can transmit with 1 or 10 Watts transmit power. The 800 MHz unit produces 1 and 3 watts transmit power.

Operationally a P-2000 or C-2000/RT-2000 system operates identically with the exception of the PC/Keyloading interface. For a P-2000 the interface is located on the front of the P-2000. In a C-2000/RT-2000 system, the connector on the RT-2000 is used for PC/Keyloading functions. The connector on the C-2000 is not currently used.

For the purposes of this operators manual the use of the phrase "P-2000" will be used to cover both P-2000 and C-2000/RT-2000 systems.

Basic Operations

Front Panel & Controls



DISPLAY - The P-2000 has a color LCD display. It provides the visual feedback for the system. Exactly what is displayed depends on the current operating mode of the P-2000. During normal operation, the top area shows information for FM #1 and the bottom line shows information for FM #2.

The keypad and cursor/value rotary knobs perform functions on the transceiver that is highlighted in blue. The blue highlight also indicates which transceiver has been selected for transmitting when the system is operating in MODE 1. This is the mode where there is only one audio panel position being shared between the two transceivers.

FM #1 SELECT – This button selects FM #1 as the active transceiver. This is depicted on the display by the FM1 area turning a bright blue color. The keypad and cursor/value knobs will now operate exclusively on the FM1 transceiver.

FM #2 SELECT - This button selects FM #2 as the active transceiver. This is depicted on the display by the FM2 area turning a bright blue color. The keypad and cursor/value knobs will now operate exclusively on the FM2 transceiver.

FM #1 TRANSFER – The button will transfer (Flip-flop) the active and standby channels for FM1.

FM #2 TRANSFER – This button will transfer (Flip-flop) the active and standby channels for FM2.

FM #1 VOLUME KNOB – This rotary switch is used to control the volume of FM #1. Pressing the button will perform a “Test” of the audio system by allowing audio from that transceiver to be sent to the

headset. This is used to vary volume levels of that transceiver.

FM #2 VOLUME KNOB – This rotary switch is used to control the volume of FM #2. Pressing the button will perform a “Test” of the audio system by allowing audio from that transceiver to be sent to the headset. This is used to vary volume levels of that transceiver.

CURSOR KNOB – This rotary switch is used to move the cursor around the display.

VALUE KNOB – This rotary knob is used to modify values at the cursor position.

ENTER/PWR button – Pushing the VALUE KNOB (Small rotary knob) button performs an “Enter” and power on/off operations.

DATA PORT – This connector is used to transfer data between the P-2000 and Encryption Keyloaders

**P-2000/C-2000/RT-2000
Operator's Manual**

or for loading preset channel information via the

Motorola CPS software(PC based).

Keypad Buttons



The P-2000 has a 12 button keypad. Each button's functions are described below.

1:DIR Toggles the active transceiver in and out of DIRECT mode. Use this button to enter a "1" during keypad entry mode.

2:MODE This button will cycle through the enhanced modes of operation. Use this button to enter a "2" during keypad entry mode.

3:PROG This button will display the PROGRAM PAGE. Use this button to enter "3" during keypad entry mode.

4:DIM This button will display the page used to control the display's brightness. Use this button to enter a "4" during keypad entry mode.

5:OTAR This button will initiate an "Over The Air Rekey" for the transceiver under cursor control. Use this button to enter a "5" during keypad entry mode.

#:CHAN This button will select channel entry mode using the keypad. Use this button to enter a "#" during keypad entry mode.

6:KEY This button will prompt the user for a transmit encryption key to override the preset value for the active transceiver. Use this button to enter a "6" during keypad entry mode.

7:MSG This button will allow the user to view system messages pages. Use this button to enter a "7" during keypad entry mode

8:SCAN This button will send the active transceiver into scan mode. Use this button to enter a "8" during keypad entry mode.

9:PVT ϕ This button will toggle the active transceiver in and out of private mode. Use this button to enter a "9" during keypad entry mode.

0:QMEM This button allows the user to quickly select a preset channel using the Quick Memory channel entry mode. Use this button to enter a "0" during keypad entry mode.

***:HOME** This button will display the HOME PAGE, except in some advanced modes of operation, where it will return the user to a previous page or mode of operation. Use this button to enter a "*" during keypad entry mode.

The Home Page

The HOME PAGE is the primary operational page of the P-2000. The HOME PAGE becomes visible when the P-2000 is ready for user input, immediately after the power up and initialization sequences have completed. When viewing the HOME PAGE, Radio 1 (Also called FM1 or transceiver #1) is always displayed on the top section. Radio 2 is always displayed on the bottom section. All keypad-initiated operations are performed on the active radio. The active radio easily distinguished by the bright blue color. The cursor is the square box that is located either around the channel number or around the channel alpha identifier. It can be quickly toggled between the channel number and alpha identifier using the cursor knob.

The following illustration is an example of what the HOME PAGE looks like.

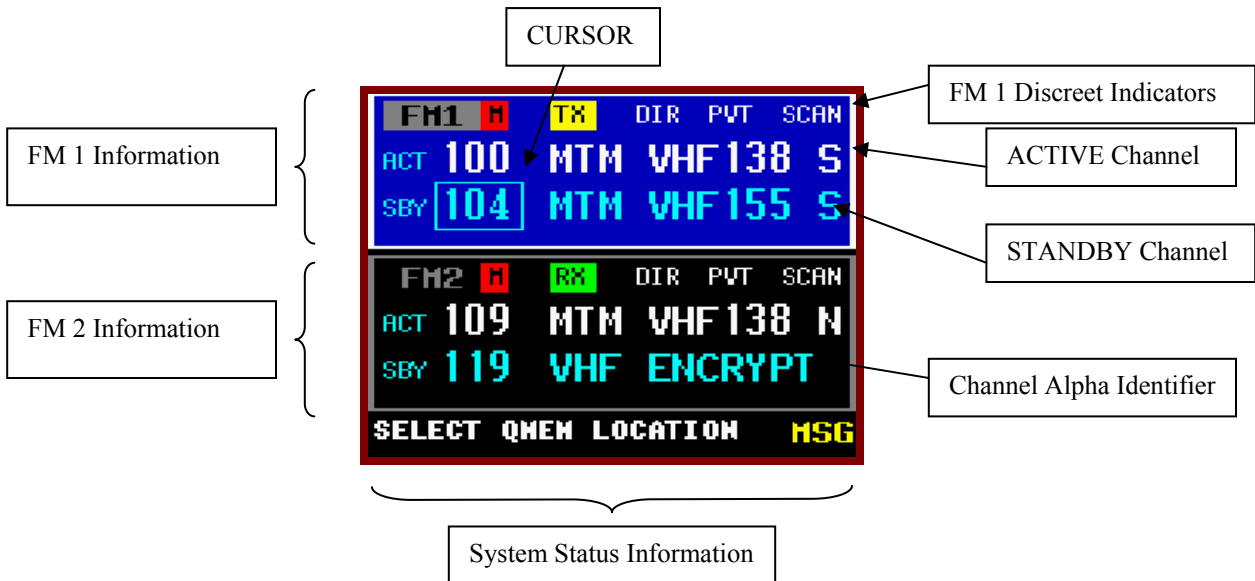

The home page is divided into 3 areas – FM 1 information (top), FM 2 information (middle), and an area for system status or system prompts (bottom). In the picture above notice that the area in blue contains the information for FM 1. FM 1 will always be on the top. The names “FM1”, “FM2” can be changed in the system setup so that users can change it to something more meaningful like “VHF”, or “MAIN”.

ACT/SBY - The normal operating mode of the P-2000 is very similar to most ATC COMM radios. The user tunes the Standby channel and then “Flip-flops” it into the Active channel position using the TRANSFER button. The radio is loaded with Active channel. **The standby channel is ONLY used as a scratchpad for selecting the next channel.**

As an alternative to using the ACTIVE/STANDBY mode, the operator can press and hold the transfer button for 3 seconds and the STANDBY channel will disappear and now the user can tune the active channel directly. Either mode can be selected in the System Setup Mode as the default mode of operation.





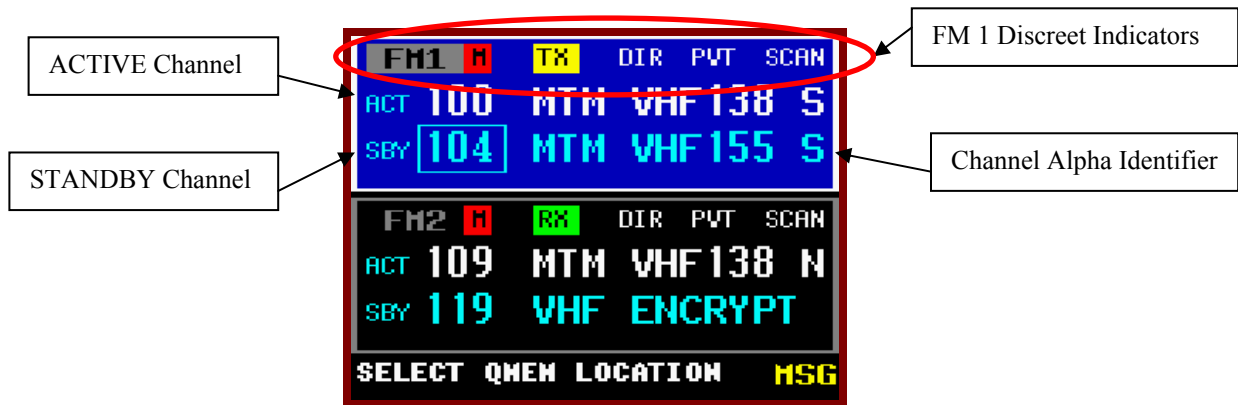

Notice the square box (CURSOR) around the SBY channel number 104. This indicates the system will tune the Standby channel number. The cursor can be moved around the alpha identifier and channels will be selected alphabetically using the Alpha Identifier.

STATUS LINE - The status line is located on the very bottom of the display and it is where the user will be prompted to either input more information via the keypad, or where the Message Indicator will show there is a system message to view. In this case the user should put the MSG button to show the Message page.

P-2000/C-2000/RT-2000
Operator's Manual

Discreet Indicators – The following discreet indicators apply to both FM1 and FM2.



-  This helps the user know the information in this block is for the transceiver located in FM #1 Position.
-  This indicates that the audio for that transceiver has been turned muted. To un-mute the audio, change the volume on that radio to something other than "0".
-  This indicates the transceiver is in the transmit mode.
-  This indicates the transceiver is receiving a signal.
-  This indicates the transceiver has been put into DIRECT mode. Direct mode is also called "Talk-around", "Car-to-Car", or "Simplex".
-  This indicates the transceiver has been put into Private mode and will use the encryption system embedded in the transceiver. This mode is not available if a channel is not programmed for encryption.
-  This indicates the transceiver has been put into Scan mode.



You can always get back to the HOME PAGE by pressing the HOME button one or more times.

**P-2000/C-2000/RT-2000
Operator's Manual**

Turning the System On and Off

To power-on the P-2000, press and hold the PWR button (push in the VALUE Knob) for approximately one second and release. Several version number and copyright pages appear on the display while the unit performs a self-test and initializes the attached radio systems. When initialization is complete, the HOME PAGE will appear on the display.



To power the P-2000 OFF, press and hold the PWR button for 3 seconds. The following message flashes on the display several times:

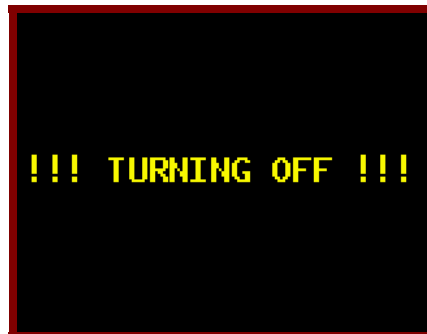

Continue to hold the PWR button until the message stops flashing and the display turns off.

If aircraft power is removed while the P-2000 is in operation, the P-2000 will store the following information to memory so that when power is re-applied the system will be at the same operating point:

1. Current active and standby channels for FM1 and FM2.
2. Current volume levels for FM1 and FM2.

If the operator releases the "PWR" button prior to 3 seconds elapsing, the display will return it's previous state.

P-2000/C-2000/RT-2000
Operator's Manual

Setting the Display Brightness

When the user presses the DIM button, the display brightness adjustment display appears. When the value knob is turned clockwise, the display brightness increases in intensity. When the value knob is turned counter clockwise, the display brightness decreases in intensity. The Brightness display disappears when no value knob activity has been present for more than 2 seconds.



Setting the Volume Level

When you first power on the P-2000, the volume levels for both transceivers will be reset to the level that was active when the unit was powered down. You can change the volume level as follows.

When the user turns either of the volume knobs, the volume adjustment display will appear. When the upper volume knob is turned, the volume adjustment display will appear on the upper half of the screen, and will adjust the volume on FM1 transceiver. Likewise, when the lower volume knob is turned, the volume adjustment display will appear on the lower half of the screen, and will adjust the volume on FM2 transceiver. The display below depicts the volume adjustment display when the upper volume knob has been turned. Turning the volume knob clockwise will increase the volume level, while turning the knob counter clockwise will decrease the volume level. The current volume level will be displayed within the display. If the volume is turned all the way down to the off position, the bar will turn red and the Mute indicator will be displayed on the main page.

To test the current volume level, press the volume knob and noise should be heard in the headset. The volume adjustment display will automatically disappear if when no knob turning activity has occurred for more than 2 seconds.

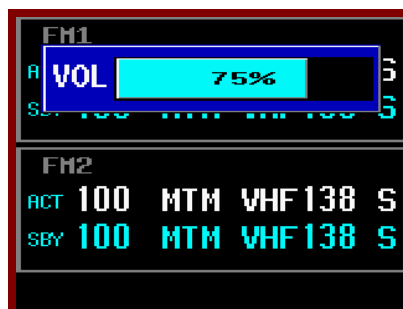

**P-2000/C-2000/RT-2000
Operator's Manual**

Selecting the Active Transceiver

To make FM1 or FM2 the “active transceiver” means that the keypad/rotary knobs will perform operations on that transceiver. The active transceiver is always highlighted in a bright blue color. As shown in the picture below, FM1 is the active transceiver.



To make FM1 the active transceiver push the FM #1 SELECT BUTTON as shown above. Pushing the FM #2 select button will make FM2 the active transceiver and the blue highlight will be moved to the FM2 area of the display as shown below.



When the P-2000 operating in MODE 1 (only one headset shared between two transceivers), the active transceiver is the one that will be used for transmitting. In mode 1, the transceivers (FM1 and FM2) will have their receive audio summed together and sent to the headset. The operator must chose which transceiver will be used when they want to transmit.

P-2000/C-2000/RT-2000
Operator's Manual

Selecting a Standby Channel Using the Cursor/Value Knob

When the P-2000 first powers on, the selected channels will be set to those that were active when the unit was powered down. To select a different preset channel, do the following:

Using the cursor knob, put the square cursor around the channel number. Turn the value knob until the channel is your desired channel. If you wish to make this your active channel, push the transfer button.



Selecting a Channel Using the Keypad

Occasionally, it is desirable to select a preset channel by entering its number via the keypad, rather than dialing it in with the cursor/value knobs. This can be performed as follows.

When the user presses the CHAN key, the keypad channel entry mode will begin. This mode allows the user to tune a channel by inputting the desired channel's number into a field via the keypad. The figure below depicts this mode of channel tuning. If no keypad input is received for more than 4 seconds, the operation will automatically cancel. If the user presses the HOME key, the operation will also cancel. When the user presses the ENTER key, the channel with the number input into the field will be loaded. If the input channel number is invalid, an error tone will sound, and the previous "good" channel will be reinstated.

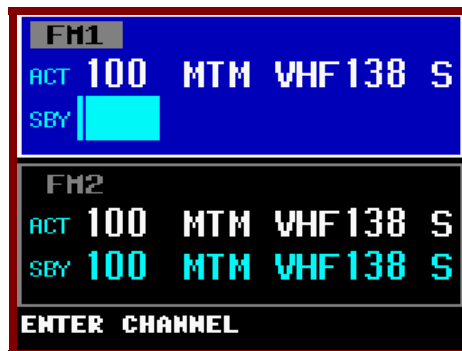

Selecting a Channel by Alphanumeric Identifier

To change the standby channel using the alpha identifier, use the cursor knob to move the cursor square around the alpha identifier as shown below. Turn the value knob until the channel is your desired channel. Notice that channels change alphabetically.

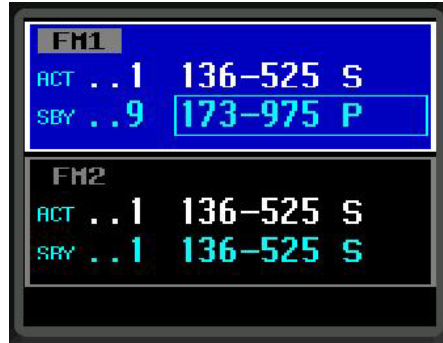

Using the Direct/Repeat Feature

The P-2000 supports both direct and repeat modes of operation. Any preset channel that has identical transmit and receive frequencies is considered a direct channel. If the transmit and receive frequencies are different, the P-2000 considers the channel a repeater channel. Repeater channels can be temporarily changed into direct channels by pressing the DIR button. This will temporarily copy the receive frequency into the transmit frequency. The direct mode indicator will light. The following illustration shows radio 1 in direct mode.

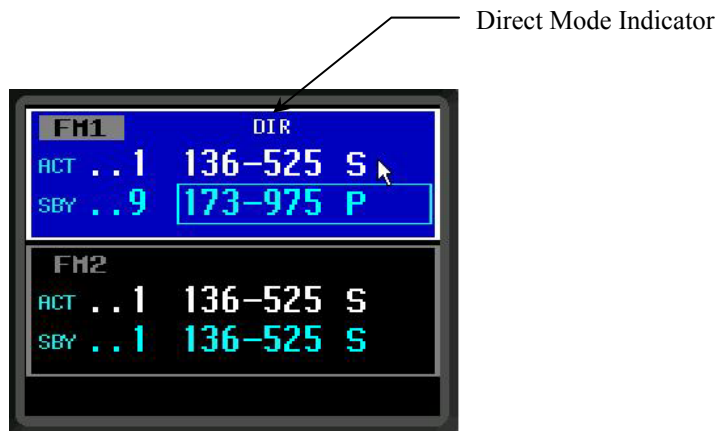

NOTE:

Pressing the DIR button on a direct channel has no effect.

P-2000/C-2000/RT-2000
Operator's Manual

Receiving/Transmitting

Transmitting

To transmit on a radio system, select the appropriate source on your audio panel, and key the microphone. Transmission will begin on the radio's currently selected Active channel. During the transmission, the radio's transmit indicator will light, and the channel's transmit frequency will be displayed. The following illustration depicts FM #1 transmitting.

Receiving

The P-2000 is constantly monitoring its radios for reception. When a signal is received, the P-2000 will light the receive indicator for the receiving radio, and route the audio to the operator's headset (Assuming the associated intercom switch is selected). The following illustration depicts FM #2 receiving.

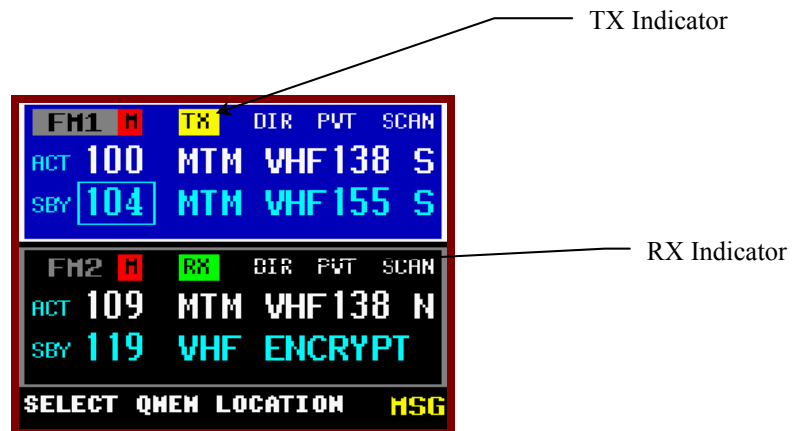

Enabling/Disabling Transceivers

Transceivers cannot be individually powered off on the P-2000, however the volume level of either transceiver can be reduced to zero, effectively turning off the transceiver. The screen below shows what the display looks like when the audio level of a transceiver is set to zero. Notice the mute indicator is displayed and the level indicator turns red.



QMEM Operations

When the user presses the QMEM key, the system will enter the QMEM mode. This mode allows the user to either select or program a QMEM location. When the user presses the QMEM key, then presses a keypad key (0-9), the channel programmed into the corresponding (0-9) QMEM location shall be loaded into the active channel, and the previously active channel shall be loaded into the standby channel. If the user presses the QMEM key, then presses and holds down a keypad key (0-9) for 3 or more seconds, the current active channel shall be programmed into the corresponding QMEM location. Should the user not press any key for more than 4 seconds after pressing the QMEM key, the QMEM operation shall automatically be canceled. The user can cancel the QMEM operation by pressing the HOME key. The figure below shows the QMEM operation in mid stream.

To store a channel into a QMEM position first put the desired channel in the active channel and press the QMEM button. The figure below shows what the display will look like.



At this point press and hold button 0-9 until the status line indicates the storage operation is completed, as shown in the picture below:



To load the active channel using QMEM, simply push the QMEM button followed by a 0-9 button and the programmed channel will be automatically loaded into the active channel. If that QMEM position has not been programmed with a channel, the status line will indicate to the user no channel is programmed.

MESSAGE PAGE

This page allows the user to manage text messages for the system. When no unread messages exist within the system, the MSG indicator will not be visible on the normal operation page. When the MSG key is pressed on the normal operation page and no messages are available, the no message page is displayed. This page is depicted below. The only selectable item on this page shall be the back button. Pressing ENTER will return to the HOME page.



When an unread message exists within the system, the MSG indicator will be visible on the HOME page. When the MSG key is pressed and messages are available, the message list page shall be displayed. An example of a message page that contains unread messages is shown below.



**P-2000/C-2000/RT-2000
Operator's Manual**

The cursor knob allows the selection of the message list, back button, erase button, and next button. Pressing ENTER while the back button is selected returns to the previous page. Pressing ENTER while the erase button is selected deletes the currently selected message from the message list. Pressing ENTER while the next button is selected invokes the message view page for the currently selected message in the message list. The message view page is depicted below

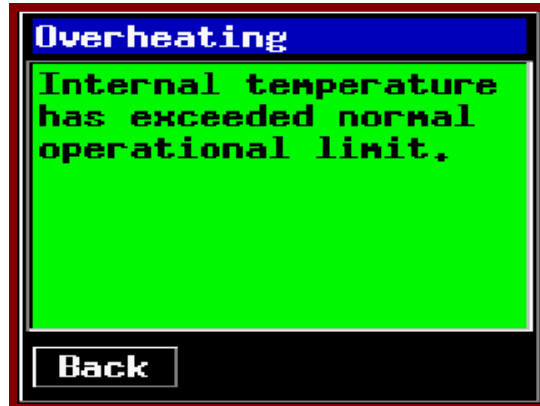

You can always get back to the HOME PAGE by pressing the HOME button one or more times.

Programming/Editing a Preset Channel

The EDIT PAGE allows the operator to temporarily change properties of a preset channel. Precisely which properties can be changed varies with channel and radio type. At a minimum, all information that can be determined by the system during the LEARN mode is displayed on this page.

While on the HOME page press the EDIT button and Programming Mode display page will be seen.

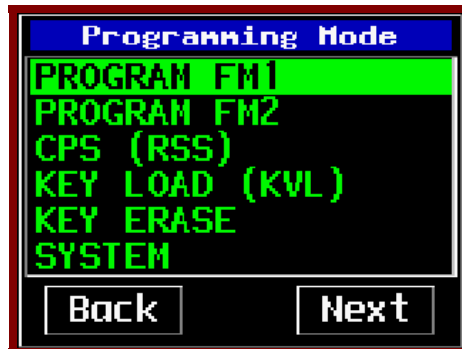

Select either of the first two options to program/edit preset channels for FM1 or FM 2 transceivers. Once a selection has been made the display will show the Channel Properties page will be displayed as seen below:

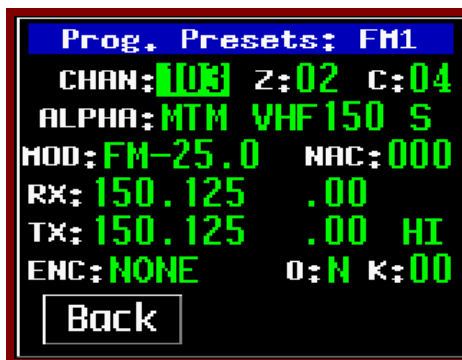

On this page field labels are shown in white characters and data fields are in green characters. The cursor/value knobs are used to move the cursor to the different fields and then changes and/or data entered via the value knob.

Below is a list of the data fields used on this display page:

Channel Identifier field (CHAN:) – This displays the currently selected channel, i.e. the channel you are editing.

Zone Number (Z:) – This displays which zone the preset channel is stored in.

Channel Number (C) – This displays which channel the preset channel is stored in.

ALPHA ID (ALPHA) – This field displays the alpha identifier for channel being programming.

**P-2000/C-2000/RT-2000
Operator's Manual**

Modulation Type Field – This field displays the current channel's modulation type. The modulation types are displayed as AM, FM, P (P25), and TK (trunking) and the channel bandwidth 12.5/20/25/30 kHz.

NAC Code (NAC) – This shows the NAC code number used on P-25 systems.

Receive Frequency Field (RX:) – This field displays the current channel's receive frequency.

Receive Tone Field – This field displays the current channel's receive CTCSS/DCS (PL/DPL) tone.

Transmit Frequency Field (TX:) – This field displays the current channel's transmit frequency.

Transmit Tone Field – This field displays the current channel's transmit tone.

Transmit Power Level Field – This field displays the current channel's transmit power level. Power level is displayed as HI for high power or LO for low power.

Encryption Type (ENC:) – This field displays if the preset channel is setup to use encryption.

OTAR Field (O:) – This field displays if the current channel is setup to be able to OTAR.

Encryption Key Field (K:) – This field displays the current channel's transmit encryption key. The encryption key will display as a number between 1 and 16, or “..” if no key has been specified for the channel.

Editing a Preset Channel

Currently only changing of the transmit power is allowed for editing a preset channel.

Changing Transmit Power

The P-2000 supports the selection of high and low transmit power. Normally high power is used, however, if interference or other transmit issues are experienced, low power may be selected to help remedy the issue. If you have a radio that supports multiple power levels, such as the RT-5000, you can alter the power setting from the EDIT PAGE as follows.

Move the cursor under the transmit power field, as depicted below.

Rotate the VALUE knob clockwise once. The power indicator will toggle between high and low with each turn of the VALUE knob.

Press the HOME button or the BACK button to exit the mode and return to the normal operating page.

Enhanced System Features

Relay Mode

Relay Mode allows your aircraft's P-2000-based transceiver system to automatically relay receiver audio from one transceiver and retransmit it out the transmitter. If a Relay Mode link is established between two locations, a message received from one location is automatically retransmitted to the other. You can establish relay operation as follows.

- From the HOME page select the desired channel for radio 1 and establish communications on that channel.
- From the HOME page select the desired channel for radio 2 and establish communication on the channel.
- Press the MODE button and the Mode Selection page will be displayed:

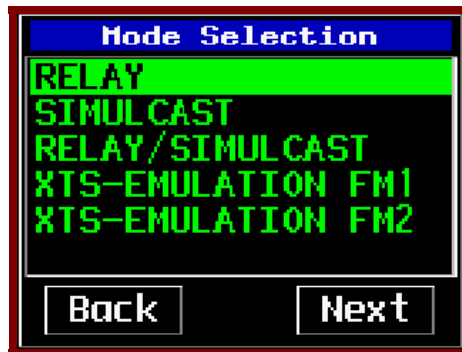

- Select the RELAY MODE by high-lighting the option and pressing the ENTER button. The unit will now enter the RELAY mode and the display will look like the one below:

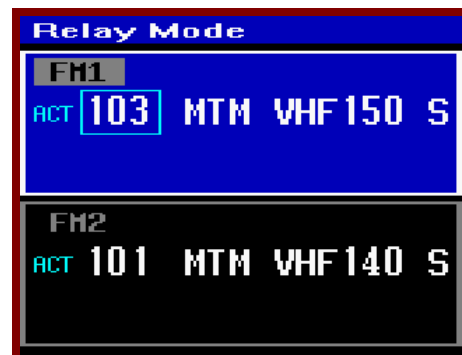

**P-2000/C-2000/RT-2000
Operator's Manual**

Simulcast Mode

Simulcast Mode allows you to transmit simultaneously to two other locations that have radios tuned to different frequencies. You can establish simulcast operation as follows.

- From the HOME page select the desired channel for radio 1 and establish communications on that channel.
- From the HOME page select the desired channel for radio 2 and establish communication on the channel.
- Press the MODE button and the Mode Selection page will be displayed:

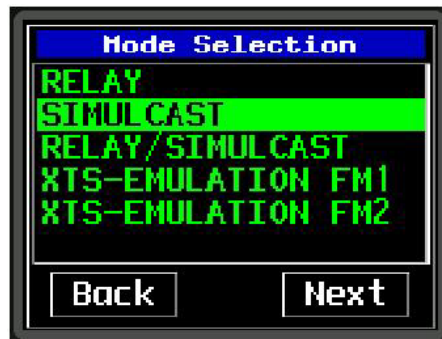

- Select the SIMULCAST MODE by high-lighting the option and pressing the ENTER button. The unit will now enter the SIMULCAST mode and the display will look like the one below:

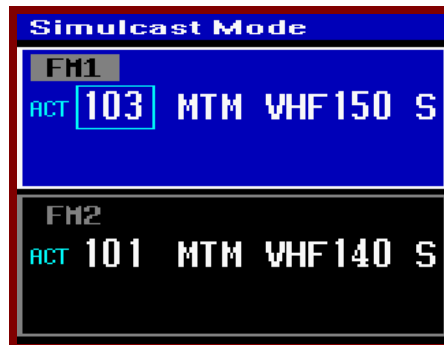

- Use either RT1 or RT2 mic position on the audio selector panel and initiate a transmission. Both Radios will transmit at the same time.
- To exit the SIMULCAST MODE, simply press the HOME button.

Relay/Simulcast Mode

Relay-Simulcast mode combines the functions of Relay Mode and Simulcast Mode. It allows you to establish an automatic radio link with two other locations that have radios tuned to different frequencies in different frequency bands, and allows you to transmit to those same locations simultaneously. You can establish relay/simulcast operation as follows.

- From the HOME page select the desired channel for radio 1 and establish communications on that channel.
- From the HOME page select the desired channel for radio 2 and establish communication on the channel.
- Press the MODE button until the following display page appears.



- Select the RELAY/SIMULCAST MODE by high-lighting the option and pressing the ENTER button. The unit will now enter the RELAY/SIMULCAST mode and the display will look like the one below:

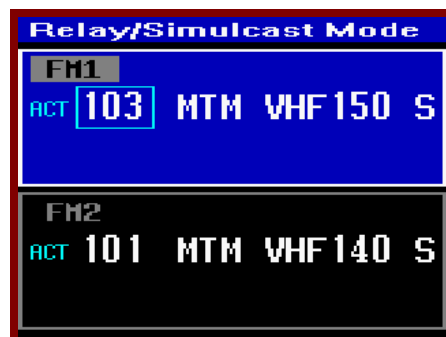

- Now the unit will RELAY between FM1/FM2 and it will also SIMULCAST on both transceivers when the operator chooses either FM1 or FM2 audio panel positions.
- To exit the RELAY/SIMULCAST MODE, simply press the HOME button.

**P-2000/C-2000/RT-2000
Operator's Manual**

Repeater Mode

Repeater mode is not a specific mode of the P-2000 but an airborne repeater can effectively be created by preprogramming specific channels and then using the RELAY MODE. It is also necessary for the two transceivers, FM1 and FM2 to use the same band. In other words, you cannot perform a repeater function with a P-2000 that has FM1 operating in the 136-174 MHz band and FM2 operating in the 800 MHz band.

Say a P-2000 channel normally uses a repeater that is not working and an area is without communications on that channel. To act like an airborne repeater the operator must program a special preset channel with the receive and transmit frequencies reversed. We suggest giving this channel a special ALPHA ID that helps the operator recognize it as a special repeater channel associated with the original channel. To operate as an airborne repeater perform the following steps:

- While on the HOME PAGE set the ACTIVE channel to the channel you normally use the repeater on FM 1.
- Put FM1 in DIRECT MODE by pressing the DIR button.
- Select the special channel associated with the repeater on FM2.
- Go into the RELAY MODE.
- If the operator wants to talk select FM2.



You can always get back to the HOME PAGE by pressing the HOME button one or more times.

**P-2000/C-2000/RT-2000
Operator's Manual**

XTS-Emulation Mode

This page shall allow the user to operate the RT-2000 in XTS-Emulation mode. In this mode of operation, the user can operate FM1 or FM2 transceivers very much like a Motorola handheld. This page is intended to be used when special functions of the internal transceivers cannot be accessed with P-2000 user interface. The figure below depicts the layout for this page.

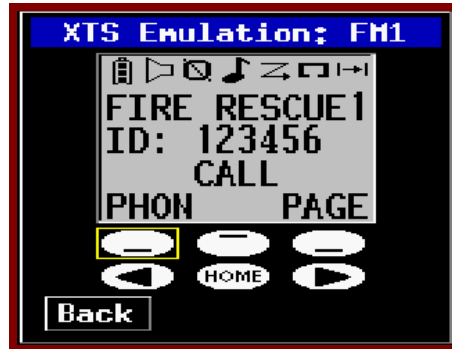

The XTS-Emulation page will show what the internal transceiver normally would show on its screen. The 6 soft keys on the handheld are accessed using virtual buttons selectable via the cursor knob. Pressing ENTER while one of these keys is selected shall send the appropriate "key pressed" message to the radio. Pressing any of the keypad keys sends the appropriate "key pressed" message to the radio. Pressing ENTER while the "back" button is selected returns the operator to the previous screen.

Phone Patch Mode

The P-2000 can patch into the phone systems only by using the XTS-Emulation mode. This is NOT a cellular phone.

Encryption Features

Turning Encryption On and Off

Select FM1 or FM2 depending on which transceiver you want to encrypt. Press the PVT button to toggle encryption on and off. If the P-2000 preset channel being used has been set up for encryption, the privacy indicator will light.



NOTE:

Encryption can only be turned on for channels that have been pre-programmed with an encryption key. Three error beeps will sound if the channel has not been setup for encryption.

Selecting an Encryption Key

The preset encryption key (sometimes called KEYMAT) for a channel can be temporarily changed as follows.

- Ensure you are on the HOME PAGE, and the radio you wish to select is active and encryption capable channel is also selected.
- Press the KEY button. The following illustrates the display when the KEY button was pressed with radio 1 active. If the KEY button is pressed on a channel that has not been preset to use encryption, three warning beeps will sound.



P-2000/C-2000/RT-2000
Operator's Manual

- Rotate the VALUE knob to change the encryption key. A value of “PSET” indicates you want to use the channel’s preset encryption key. A numeric value (1-16) indicates you want to override the preset key with the specified key.
- Press the ENTER button to accept the displayed key. The display will return to the HOME PAGE.
- When transmitting, a if encryption keys are properly loaded, a tone at the start of the transmission will be generated by the radio and heard by the operator. Begin speaking AFTER the tone or part of your transmission will be lost.
- When transmitting in the encrypted mode, if you hear a continuous warble tone, this indicates that the encryption key(s) have not been loaded. Either manually enter encryption keys or perform an OTAR if your system has that capability.
- The newly selected KEYMAT WILL REMAIN even if the channel is changed in effect until power down.

Performing an OTAR

- Ensure you are on the HOME PAGE, and the cursor is on the line of the radio you wish to select and an OTAR capable channel is also selected.
- Press the OTAR button. The following illustrates the display when the OTAR button was pressed with radio 1 under cursor control.



- To confirm the start of the OTAR, select YES and press the ENTER button to initiate the OTAR process. The status of the OTAR will be displayed on the radio’s display line. Status messages include “OTAR REQUESTED”, “OTAR IN PROGRESS”, “OTAR ABORTING”, “OTAR COMPLETE”, and “OTAR FAILED”.

**P-2000/C-2000/RT-2000
Operator's Manual**

- The following illustrates the display with an OTAR in progress.

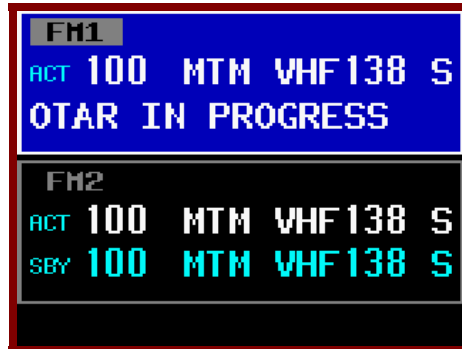

NOTE:

The OTAR process will automatically time-out after 2 minutes of unsuccessful OTAR attempts.

At anytime during the OTAR operation, or after the OTAR has completed, whether successfully or unsuccessfully, the user must press the OTAR or HOME key to cancel/exit the OTAR operation. Doing so shall display the OTAR cancel confirmation page, as depicted below. This page functions identically to the OTAR start confirmation page.



You can always get back to the HOME PAGE by pressing the HOME button one or more times.

**P-2000/C-2000/RT-2000
Operator's Manual**

Loading Encryption Keys

Before a transceiver will transmit encrypted messages, the user must load encryption keys into the transceiver. To accomplish this, the user must first put the transceiver into KEY LOAD mode, and then using a Motorola KVL, load the keys. Perform the following steps to load keys:

- From the HOME page press the PROG button. If prompted, enter the password #1 (In the system programming options, the user has the option of eliminating this password by setting it to "0000")



- Highlight the KEY LOAD option and press ENTER. Enter password #2 to get to the Transceiver Setup page.

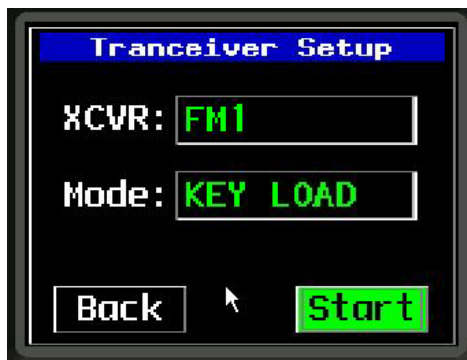

- In the XCVR field, select which transceiver (FM1 or FM2) to load keys.
- Highlight the START option and press the enter button to begin the encryption load process.
- Connect the KVL loader to the data port on the front of the P-2000 (or RT-2000, not the C-2000). Load keys for both FM1 and FM2 if desired. The keyloader will indicate successful loading.
- Press the HOME button several times to return to the HOME page.

Erasing Encryption Keys With A Keyloader

It may be desirable to erase the encryption keys contained in a P-2000 transceiver. For example, prior to sending the unit in for service. This can be accomplished as follows.

- Ensure you are on the HOME PAGE, and the cursor is on an encryption capable channel.
- Press the PROG button. If prompted, enter the password #1 (In the system programming, the user has the option of eliminating this password by setting it to "0000")



- When prompted, enter the password #2 and the Transceiver Setup page will be displayed as below:

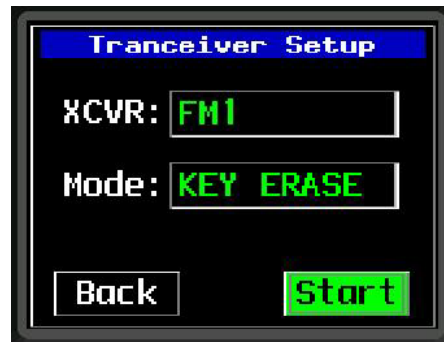

- In the XCVR field, select which transceiver (FM1 or FM2) to erase keys.
- Highlight the START option and press the enter button to erase the encryption keys.
- Press the HOME button several times to return to the HOME page. Verify keys have been erased by attempting to transmit on an encryption channel with PVT on. The transceiver will provide an audio tone to indicated encryption keys have been erased. As an alternative, use the XTS-EMULATION page for that transceiver and visually verify keys have been erased.

CPS MODE

Loading Channel Memory

Programming the preset channels of the P-2000 must be performed with PC based program available from MOTOROLA named CPS. Normally this procedure is accomplished by a technician familiar with this software package since extensive knowledge is required to operate the Motorola software. As a note to the technician, no RIB box is required between the PC and P-2000 since Wulfsberg has built this capability into its transceiver. The process to read and modify the transceiver preset channels is as follows:

- Ensure you are on the HOME PAGE.
- Press the PROG button. If prompted, enter the password #1 (In the system programming, the user has the option of eliminating this password by setting it to "0000"). The PROGAM page will be displayed as below:



- Highlight the CPS option and press the enter button. The Transceiver Setup page will be displayed with the CPS load already pre-selected as shown below:

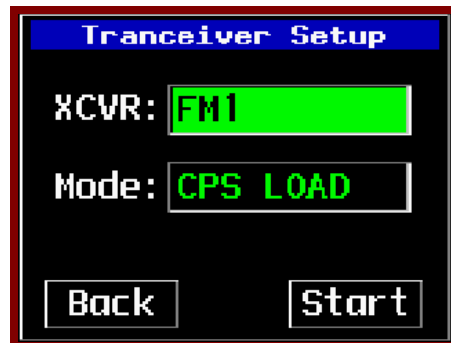

- Select XCVR FM1 or FM2, highlight the start option and press enter to begin.

**P-2000/C-2000/RT-2000
Operator's Manual**

- Connect the PC to the data port on the front of the P-2000(RT-2000 not C-2000).
- Using the CPS software, read the FM1 and save the file as sent by the Wulfsberg Factory for backup purposes.
- Perform any changes to the archive file such as adding/deleting channels, changing encryption options etc. For the P-2000 to function properly DO NOT change key button options or display options. Also, the Zone/Channel assignment must be made so that there no more than 16 channels per zone.
- Once all new channels have been entered, transfer the updated archive back into the P-2000. The Motorola software will indicate successful completion of this task.
- Perform the above actions on both FM1 and FM2.
- Press the HOME button once to enter the LEARN MODE. In this mode, the P-2000 computer interrogates the internal transceivers to determine what changes have been made and to update its internal memory. This process can take several minutes. The operator will be shown progress as the system completes its task. This task must be successfully performed or the P-2000 main processor will not be able to properly function with the internal transceivers.
- Upon successful completion of the LEARN mode, press the HOME button several times to return to the HOME page.



You can always get back to the HOME PAGE by pressing the HOME button one or more times.

**P-2000/C-2000/RT-2000
Operator's Manual**

SYSTEM SETUP MODE

The P-2000 comes the factory already configured for a normal installation, however, there are several options the operator can select. These options are very simple to update. The process is as follows.

- Ensure you are on the HOME PAGE and press the PROG button. If prompted, enter the password #1 (In the system programming, the user has the option of eliminating this password by setting it to "0000")



- Highlight the SYSTEM option and press the ENTER button. You will be prompted to enter the system password. After successful entry of the system password the SYSTEM SETUP page will be displayed.



- On System Setup Page 1, users can configure the Label field (instead of FM1 or FM2, the user could input VHF1, MAIN, OPS or anything that helps the operators properly select transceivers), and the passwords. Password #1 will not appear in any operations if it set to "0000".
- To display page 2, highlight the NEXT option and press enter.
- The second setup page allow the selection of the following

**P-2000/C-2000/RT-2000
Operator's Manual**

- **Enable Standby** – the active/standby channel operation can be set to active only by saying “YES” to this option. A “NO” will eliminate the standby channel and the user will tune active channels only. Factory default for this option is “YES”.
- **Lock QMEM** – To keep users from altering the QMEM settings, this option can be set to YES. Factory default for this option is “NO”.
- **Lock Volume** – The volume of the headset outputs can be locked in the maximum volume position by setting this option to “YES”. This would be used when the audio panel already has volume controls and it would eliminate the operator from having to manipulate both the P-2000 volume knobs and the audio panel volume knobs. Factory default for this option is “NO”.
- **Mic Mode** – If the audio panel connected to the P-2000 has only one position, set this option to “SINGLE”. If the audio panel has two positions, one for FM1 and another for FM2, set this option to “DUAL”. Factory default for this option is “DUAL”.



- To Save the changes made to the SYSTEM SETUP, highlight the “SAVE” option and press enter. The screen will indicate saving of the data is taking place. When the data save process is complete, press the HOME button several times until the HOME page is displayed.



You can always get back to the HOME PAGE by pressing the HOME button one or more times.

MAINTENANCE PAGES

The following information is not normally needed by an operator. The maintenance pages are used by a technician to make audio level adjustments and verify system operation via BITE (Built-In-Test).

- Ensure you are on the HOME PAGE and press the PROG button. If prompted, enter the password #1 (In the system programming, the user has the option of eliminating this password by setting it to "0000")

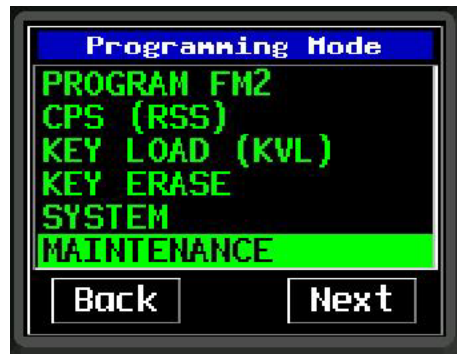

- Highlight the MAINTENANCE (Its located below the SYTEM option) option and press the ENTER button. You will be prompted to enter the system password. After successful entry of the system password the MAINTENANCE mode page will be displayed as seen below.

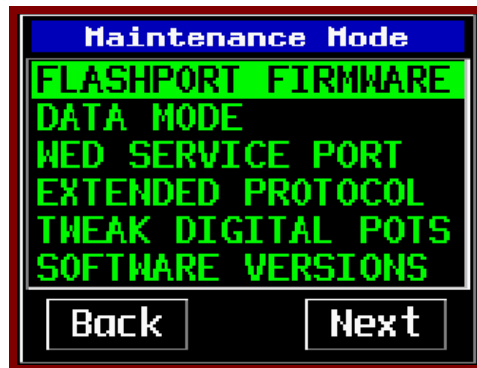

Selectable modes shall include Flashport firmware mode, Data mode, Service port mode, Extended protocol mode, Digital pot adjustment mode, and Software version reporting mode.

Flashport Mode

The flashport mode is one of the mode options available on the Transceiver Maintenance page. This mode allows the technician to upgrade the embedded software within the internal transceiver.

- Select the transceiver to perform the flash upgrade. Highlight START and press enter to begin. Perform the flash upgrade.

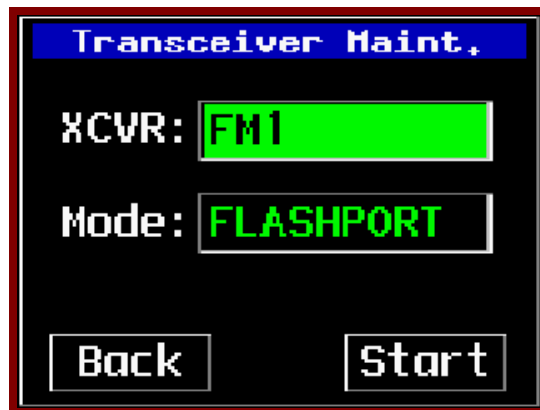

Data mode, WED service mode, Extended protocol mode are accessed using the same procedure.

Digital Pot Tuning Mode

This page allows a technician to adjust the digital pot settings on the P-2000. The cursor knob allows the selection of the pot name field, pot value field, the back button, and the save button. Turning the value knob while the pot name field is selected shall enumerate all the pot names: radio in 1, radio in 2, sidetone 1, sidetone 2, radio out 1, radio out 2, speaker, and alert tone. Turning the value knob while the pot value field is selected enumerates the range of values: 0-127. The display below shows the layout for this page.

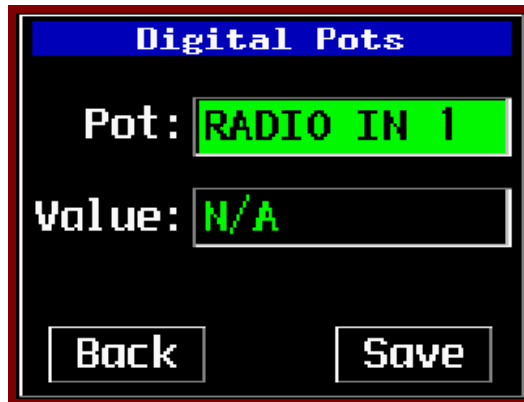

Software Versions Display Page

To view the software version of all programmed parts within the P-2000, select the Software Version page from the MAINTENANCE MODE page.

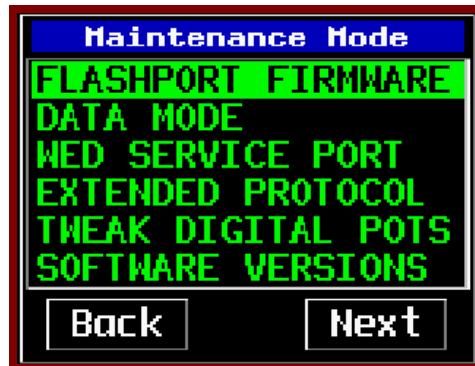

- From the MAINTENANCE MODE page, Highlight the SOFTWARE VERSIONS option and press ENTER.

This page shall allow the user to view the part numbers and/or version numbers of the software modules installed in the P-2000 radio system. The module versions that are reported are display board flash, CPU board internal flash, CPU board external flash, and CPU board CPLD. Should an error occur during the query, "N/A" shall be displayed in place of the software version. The back button will be the only selectable item on the page. Pressing the ENTER key shall return to the previous page.

**P-2000/C-2000/RT-2000
Operator's Manual**

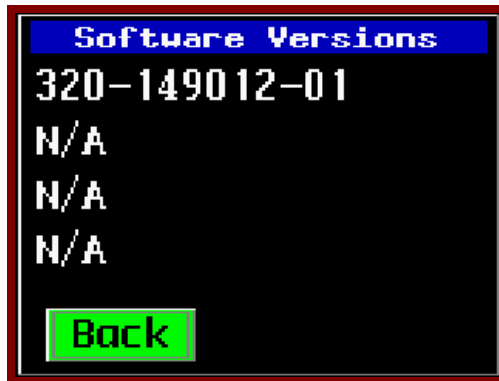

**P-2000/C-2000/RT-2000
Operator's Manual**

Steps to Successful Setup and Operation

While we would like to pull products out of the box and immediately start to use them, this system is one that takes just little work to get to that point. First READ THE OPERATORS MANUAL!!!! This will familiarize you with the buttons and display pages of the system. The following checklist will help installers setup the P-2000 or C-2000/RT-2000.

1. Note all part numbers of components in your system..

P-2000 Part Number = _____

C-2000 Part Number = _____

RT-2000 Part Number = _____

Please write down the frequency bands of the transceivers inside the P-2000/RT-2000.

FM #1 = _____

FM #2 = _____

2. Using the SYSTEM Programming page 2, select whether the unit will be operated in Mode 1 (only one mic/headset port) or Mode 2 (two independent mic/headset ports). Review the other options and configure as desired. Return to the HOME page.
3. Put the P-2000/RT-2000 in CPS mode for FM #1.
4. Connect a PC to the programming port of the P-2000/RT-2000 and run the Motorola CPS software.
5. Using the CPS software, read the codeplug of FM #1. Save this first in case you need to return to factory settings.
6. Program personalities and Zones/Channels. It is very important to use good channel identifiers so operators can efficiently determine the purpose of the channel. Whenever possible, use the same channel name the ground units use so that when calling out channel changes both the aircraft and the ground units can use the same channel names. These steps require significant knowledge of the Motorola software. We encourage enlisting the help of someone familiar with Motorola CPS software to successfully program the internal transceivers.
7. Save the modified codeplug on the harddrive and then download it into FM1.
8. Do the above for FM #2 if applicable.
9. Upon the exit from CPS mode, the P-2000/RT-2000 will automatically go into "LEARN" mode. At this time the unit is interrogating the internal transceiver modules for information about channels that were programmed during CPS operations. Wait until the display indicates successful completion of this process.
10. Validate that all channels programmed during CPS are now functional on both FM #1 and FM #2 transceivers.