

DEUS



USER'S MANUAL

TABLE OF CONTENTS

QUICK START — Page 60	CORDLESS HEADPHONES
	Menu — Page 29 / 30
TECHNICAL INTRODUCTION — Page 02	Discrimination-Sensitivity-Ground
	Frequency-Tones-Volume-Coil
LIST OF PARTS — Page 04	Pairing with a new coil — Page 30
ASSEMBLY — Page 05	Factory Programmes — Page 31
	Replacement of the backphone — Page 31
USE	
Remote control — Page 06	POWER SUPPLY - BATTERIES
Factory programs, Description — Page 07	Low battery lights — Page 32
Starting up — Page 08	Battery life — Page 32
	Charging time and charging progress — Page 32
MENU	Charge — Page 33
Discrimination — Page 09	Battery durability — Page 34
Sensitivity — Page 10	Replacement — Page 34
Frequency — Page 11	Precautions — Page 35
Iron Level — Page 12	
Reactivity — Page 13	EXPERT
Audio Response — Page 15	Multi-Tones — Page 36
Notch — Page 15	Pitch — Page 36
	Multi-Tones, thresholds and tones — Page 37
GROUND	TX Power — Page 38
General — Page 16	Frequency shift — Page 39
Manual Mode — Page 17	Silencer — Page 39
Pumping Mode — Page 18	Multi-Notch — Page 40
Tracking Mode — Page 18	
Beach Mode — Page 20	PRACTICAL INFORMATION — Page 41 / 42
	PRECAUTIONS FOR USE — Page 43
NONE MOTION — Page 21	TROUBLESHOOTING AND SOLUTIONS — Page 44 / 45
	SPECIFICATIONS — Page 46
OPTION	ACCESSORIES — Page 47
Programmes — Page 22	SPARE PARTS — Page 48
Coil — Page 23	RECOMMENDATIONS / LAW — Page 49
Pairing with a new coil — Page 24	FACTORY PROGRAMMES — Page 50 / 51
Configuration — Page 25	YOUR SETTINGS — Page 52 / 53
Speakers — Page 26	MENU STRUCTURE — Page 54 / 55
Back light — Page 26	DECLARATION OF CONFORMITY — Page 56 / 57
Contrast — Page 26	WARRANTY — Page 58
Clock setting — Page 27	
Update — Page 27	

CONGRATULATIONS ON THE PURCHASE OF YOUR XP METAL DETECTOR AND WELCOME TO THE WORLD OF RESEARCH AND EXPLORATION!

You have invested in a high-tech detector capable of exceptional performance, which was designed and developed in France. You are therefore helping our Company to further research in the field of metal detecting and we thank you for your contribution.

TECHNICAL INTRODUCTION

DĒUS®, the first fully wireless detector

Dēus is innovative in terms of metal detector design as it offers an architecture based on three elements communicating via a digital radio link. In this new design the coil, remote control and audio headphones have each been made independent through the integration of very compact, high-capacity lithium batteries.

An ultra-miniature electronic circuit, incorporated in the search coil, digitises and analyses the signals. Data is then sent to the headphones and remote control in real time via a digital radio link. With this method, the signal is processed at source and not conveyed via a wire link, which greatly improves data quality.

Incorporating components from leading-edge technologies such as scientific instrumentation has enabled us to produce a powerful, rapid, lightweight, compact and fully controllable digital detector.

Whether you are an experienced user or a beginner, Dēus lets you decide whether or not to modify any of its settings. Powerful pre-configured factory programmes enable all users to get started immediately, while expert detectorists can choose more advanced parameters via the intuitive interface.

What is described in this manual as the "Remote Control" is in fact the user interface, known as the 'control box' on conventional detectors.

It enables the detector's many functions to be precisely adjusted via a graphical interface. It can also receive programme updates (via internet) through its USB socket.

Dēus is also exceptional in being able to function without the remote control, with just the coil and the wireless headphones, for an even more compact, lightweight configuration (just 875 g)!

Like the remote control, the headphones contain all the components needed for detection, they are a genuine control unit in themselves, but on an ultra-miniature scale. They take over in the absence of the remote control for adjusting the detector settings.

With the headphones you can turn Dēus on and off, change the main detection settings such as sensitivity, discrimination, ground balance, tone, frequency (4 kHz, 8 kHz, 12 kHz, 18 kHz), volume, etc. as well as selecting the factory programmes or those previously configured with the remote control!

Performance is identical whether you are searching with or without the remote control!

Lastly, the new patented* XP stem has the combined advantages of an S-shaped stem and a straight telescopic stem.

It enables you to deploy or fold away the device in just a few seconds, and to change the coil in an instant.

Its user-friendly design ensures comfort and convenience for the user: length adjustable by millimetre increments, improved operating angle and shaped rubber handle for a firm, controlled grip.

So now you're ready for a new adventure!

*Patent application underway

LIST OF PARTS

The box for your Dēus metal detector contains the following parts:

- 1 One assembled fully telescopic stem
- 2 One set of wireless headphones with storage case
- 3 One 22.5 cm search coil with coil cover
- 4 One user interface (remote control) with case
- 5 One connection cable: USB / one mini-B plug
- 6 One connection cable: USB / three mini-B plugs
- 7 One power supply transformer-charger
- 8 One connection clamp for recharging the coil
- 9 One set of fastenings (2 screws, 2 wing nuts, 1 washer, 1 spacing washer)

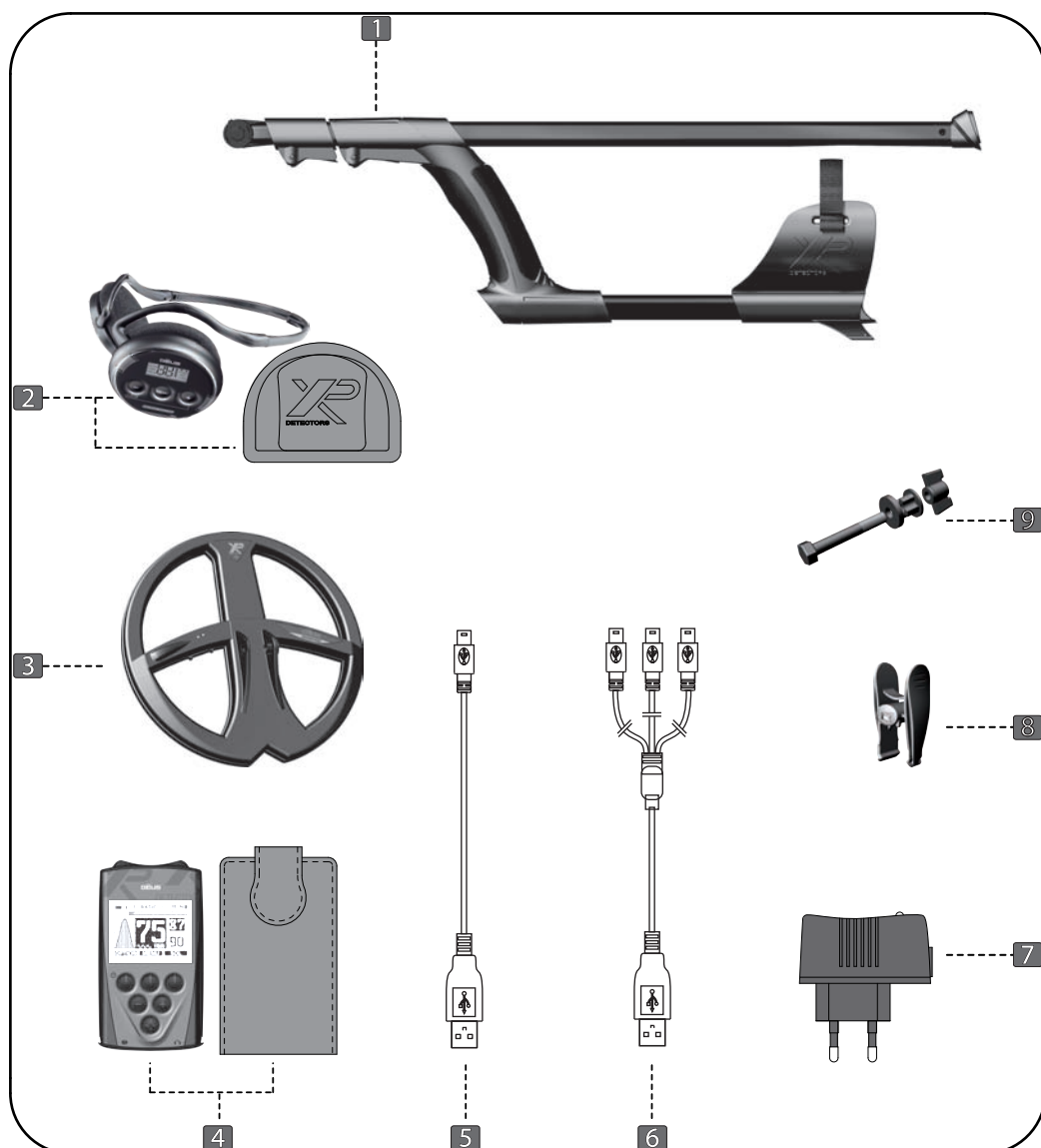

ASSEMBLY

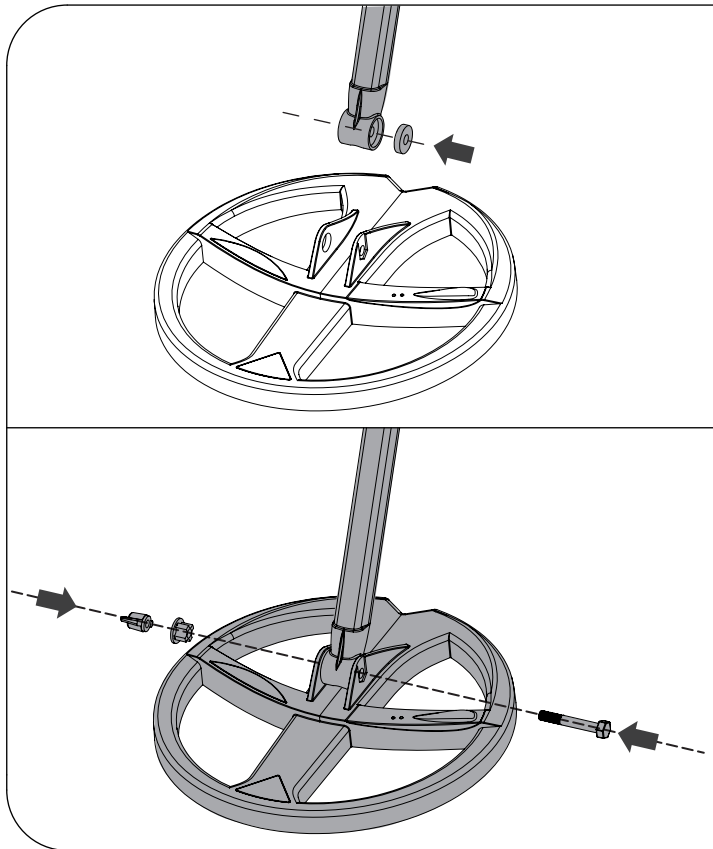

Fitting the coil on the stem

1 Insert the single rubber washer in the lower shaft.

2 Line up the stem with the coil and fit the two parts together. Install bolt and nut.

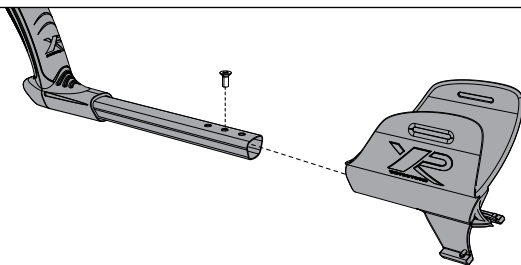

3 positions

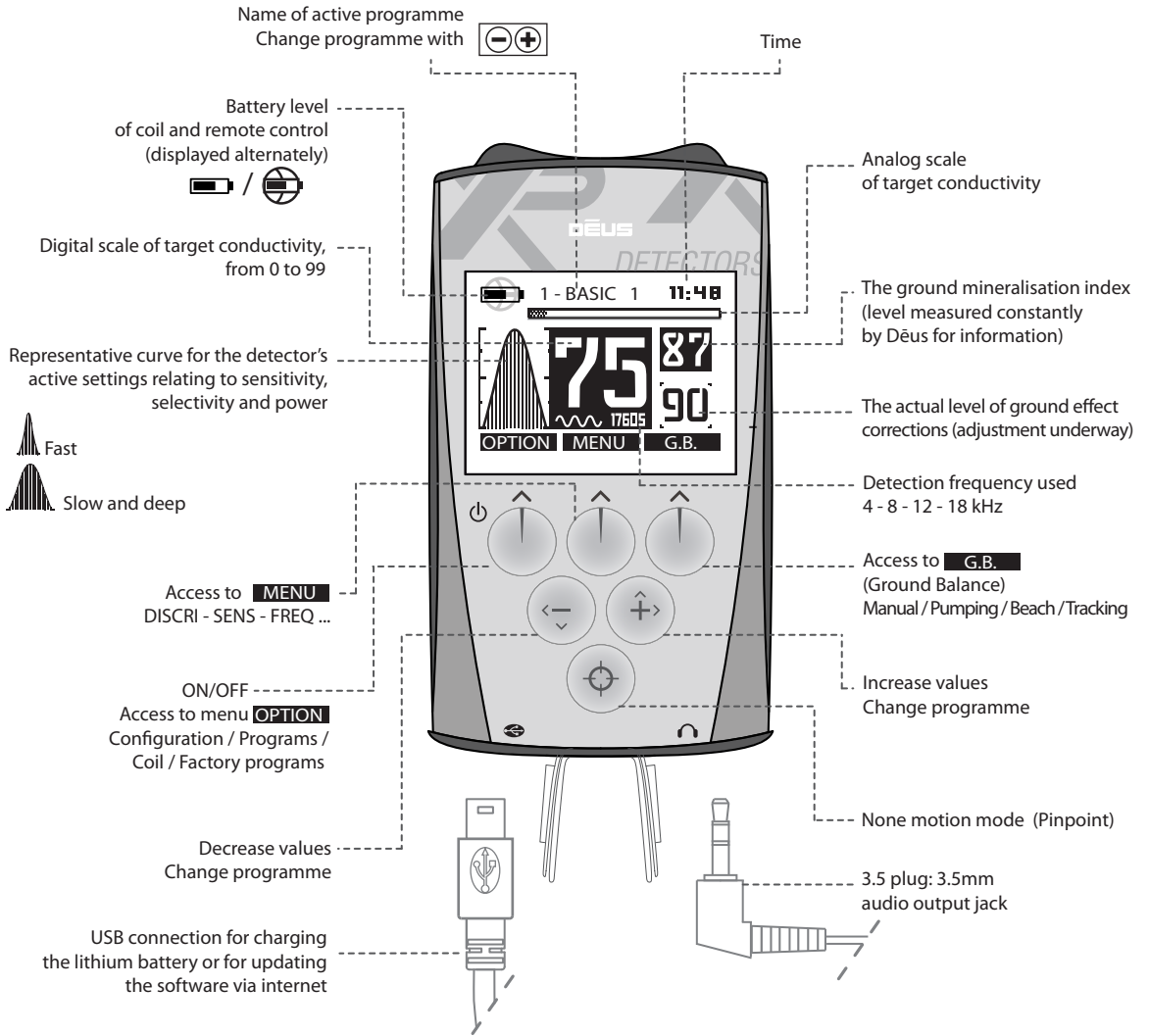

Example of secondary page

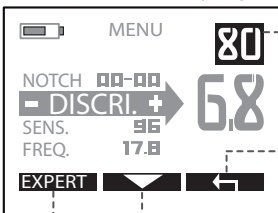

Reminds you of the target conductivity index to help you optimise your settings

Valid and return to main menu

To scroll through the menu

Access to expert menu

From the main menu navigate with  to change the programmes

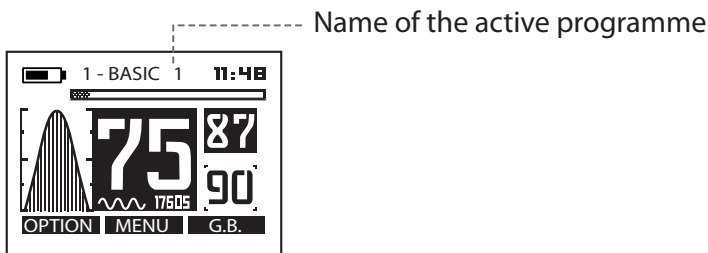

- 1 - BASIC 1 ----- General use (12 kHz).
- 2 - GM POWER ----- Similar settings to the XP Gold Maxx Power detector, powerful and fast.
- 3 - DEUS FAST ----- Faster than the Gold Maxx Power with small targets on iron-infested ground.
- 4 - PITCH ----- Responsive pitch that varies in frequency and amplitude according to the signal's strength, same speed as the Gold Maxx Power.
- 5 - G-MAXX ----- Similar settings to those of the XP G-Maxx1 detector, medium speed, particularly effective for large masses and highly conductive coins.
- 6 - RELIC ----- Slower than the G-Maxx1, adapted for large, deep masses in relatively uncontaminated ground.
- 7 - WET BEACH ----- Tuned to operate more effectively on wet beaches, although in situ adjustments are needed for the ground effect, either by pumping or manually (pg 17).
- 8 - ALL METAL ----- Suitable for deep searching for all targets, a motion all metals mode.
- 9 - BASIC 2 ----- Ease of operation with settings that offer greater stability, perfect for starting out while avoiding false signals.

(pg 50/51)

STARTING UP

After charging your device. (pg 33)



1 Switch on the remote control

Coil far from metal surfaces



2 Validate or not the use of the loudspeaker

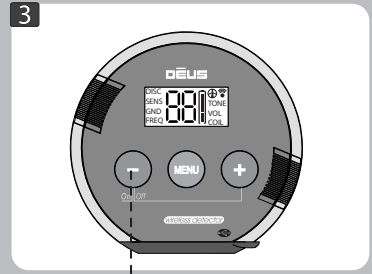

3 Switch on the headphones

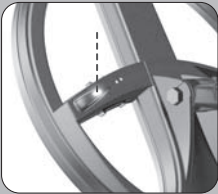

The LED on the coil gives 20 long, successive flashes to indicate that it is waking up and recalibrating.

Once recalibration is complete, the coil becomes operational and its LED flashes every second.

When the coil is on standby, its LED flashes every 4 seconds, whereas when it is on it flashes every second.

By default you begin by using the **1 - BASIC 1** factory programme which is suitable for general use.

If you wish to test one of the 9 other factory programmes,

simply scroll through them with



To switch off Dèus

1 Hold down Power for two seconds



on the remote control.

2 Press left- and right-hand buttons



on the headphones.

Note : Do not switch on Dèus when the coil is near a metal surface, inside a car, or when the stem has been folded away, as this may interfere with calibration and lead to abnormal performance.

If this should occur, switch Dèus off and move away from any metal masses before switching it on again. Nevertheless, this does not represent any risk to the equipment or its electronics!

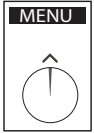

Configuring the main detection settings.

- 1 Press menu
- 2 Scroll through the menu by pressing

DISCRIMINATION

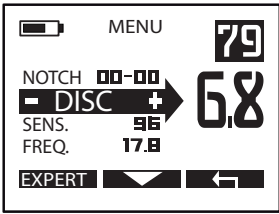

- 1 Adjust the Discrimination level (from 0 to 99) with
- 2 Exit with to return to the main menu.

Discrimination enables undesirable targets to be rejected by raising or lowering a threshold below which certain metals are differentiated. The conductivity scale (0 to 99) for metal targets shown below will help you better understand the discrimination range and its limits, and see how it corresponds to the **digital display** of target conductivity on the remote control main menu.

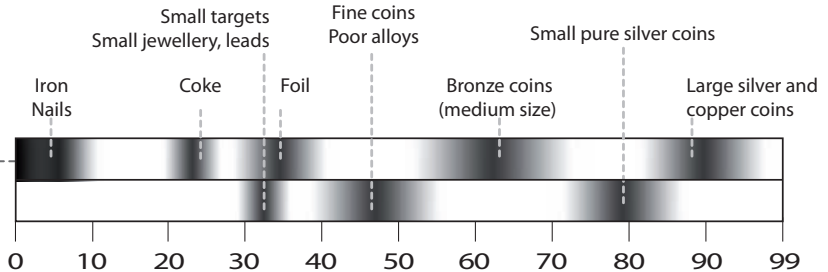
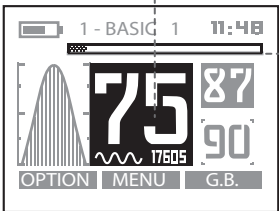

Increasing the discrimination value enables you to gradually reject any target whose conductivity is lower than the setting. For example, if you tune the discrimination level to 10, you will reject iron with a value of between 0 and 10. If you tune it to 40 you will also eliminate small pieces of aluminium foil whose conductivity is less than 40.

If you wish to reject other rubbish with higher conductivity, such as pull tabs from aluminium drinks cans, lead shot or copper hunting cartridges (whose conductivity is 60-75), you must also be prepared to accept the elimination of certain good metals with similar conductivity.

If you are particularly bothered by contamination registering as highly conductive on the digital screen, and you still wish to reject it, it is better to do so using the NOTCH rejection setting.

DISCRIMINATION continued...

Two alternatives involve selecting a low level of discrimination, between 5 and 10, then using either:

1/ The digital target display to more or less visually discriminate a target category.

2/ The Multi-tone mode to discriminate undesirable targets using a selected audio tone.

In both cases the decision then lies with you on whether or not to dig.

Note: Depending on the frequency setting used, a target's conductivity is perceived differently by the detector. The digital conductivity display may therefore vary depending on the frequency.

Note: The 0 to 10 range relates to the rejection of iron. To achieve greater precision in this range there is a digit after the decimal point (from 2.1 to 9.9), which in effect gives you 82 different levels for iron.

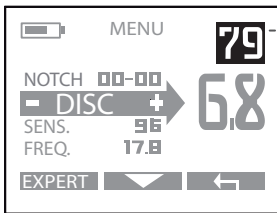

Note: In several menus, particularly at the top right of the Discrimination screen, a reminder of the target conductivity index is displayed, which helps you when adjusting the discrimination level.

SENSITIVITY

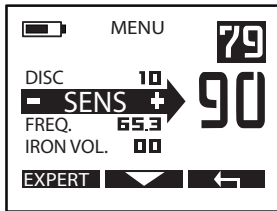

1 Adjust the Sensitivity level (from 0 to 99) with 

2 Exit with 

Sensitivity is often simplistically described as the setting which adjusts the device's power level. However this is incorrect. As its name indicates, it actually determines the device's sensitivity level. It reacts after receiving a signal via the receiver coil. Nevertheless, the results are somewhat similar in practice, as increasing a device's sensitivity enables it to detect the presence of more distant targets. However it must be noted that this setting has no effect on the power emitted.

The most commonly used sensitivity levels range from 70 to 90. It may be necessary to reduce the level if there is too much interference, as is often the case near overhead or buried power lines, fences, radio-relay stations, mobile telephones, computers, televisions, etc.



Do not test your device in your home as there is considerable electromagnetic and metal interference in urban environments.

FREQUENCY

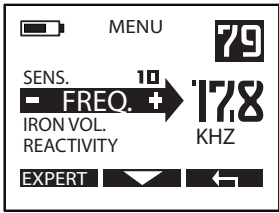

1 Scroll through the frequencies with

2 Exit with

Dêus gives you the choice of four detection frequencies (4 kHz, 8 kHz, 12 kHz and 18 kHz) which cover most detection needs.

They enable you to adapt your research more closely to the characteristics of the ground and the targets to be detected.

Here is a non-exhaustive list of the most likely targets that may be detected according to the frequency:

4 kHz	<p>Large, mainly ferrous and non-ferrous masses. Coins of sufficient conductivity and size. All other medium or relatively small targets in non-mineralised ground relatively uncontaminated by iron. Good for ferrous masses and militaria.</p>
8 kHz	<p>General use. Coins and large masses, militaria. Medium and small targets in low-mineralised ground.</p>
12 kHz	<p>General use, small coins. Coins of all sizes in medium to highly mineralised ground.</p>
18 kHz	<p>Small coins made from any alloy (gold, silver, copper, etc.) and bigger but very fine coins, low conductivity gold coins, lead, rings, sheet metal, aluminium foil. Small objects can be found even on mineralised ground contaminated with iron. Discriminates (distinguishes) coke more easily. More unstable on non-mineralised and moist ground.</p>

Note : Remember that generally speaking, all frequencies can detect all kinds of targets, so for example a frequency of 4 kHz will detect a very small target and a frequency of 18 kHz will detect a large, deep mass. However, the 18 kHz frequency will lead you to discover a relatively higher number of small targets that cannot compare with that achieved with a frequency of 4 kHz. Similarly, sometimes the 18 kHz frequency can be slightly less effective with a large mass. If you are just starting out, the 8 kHz frequency is a good compromise for general use. On a wet beach the 18 kHz frequency will be better at finding small gold jewellery such as chain necklaces and bracelets that are usually so difficult to detect.

IRON VOLUME



1 Adjust the Iron Volume (from 0 to 5) with 

2 Exit with 

You have the option of controlling the sound volume of the low-pitched tone which generally corresponds to iron. Depending on the circumstances, this enables more attention to be paid to other sounds, by reducing those generated by iron.

On the other hand, some users prefer that the low-pitched signals from iron are more audible, as they know that good targets at the detector's range limit in mineralised ground sometimes generate low amplitude, low-pitched sounds.

- At 0 the low-pitched tone is cut off.
- At 5 the low-pitched tone will have a sound level equivalent to other medium or high-pitched tones.

Note : If the discrimination threshold is too low, 0 or 2 for example, most iron will generate not low- but medium-pitched tones, as you will practically be in the All Metals mode. In this case, the iron level setting will not be of much use.

REACTIVITY

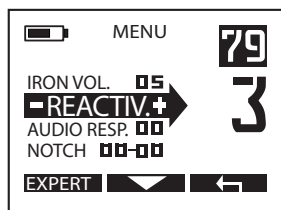

1 Adjust the Reactivity from 0 to 5 with

2 Exit with

Reactivity is a vital setting that determines the detector's performance in terms of speed of analysis and selectivity.

If a soil contains a great deal of iron, hot rocks or other mineralised debris, soil penetration is generally reduced, as is a detector's ability to identify targets similar to iron.

In these conditions, Dēus enables you to select a high degree of reactivity which will help you speed up the analysis of signals.

On the other hand, if the ground is "clean", it is better to reduce the reactivity and sweep more slowly, in order to be more sensitive to deep masses and obtain more thorough penetration.

Users familiar with the Gold Maxx Power have already had a foretaste of the Reactivity (recovery speed) of XP's detectors. And even though Dēus is a particularly fast and selective detector, you now have the option of adjusting the reactivity setting to make it even more selective!

By way of example, and to help you better understand the reactivity levels available, you should note that the reactivity of most detectors on the market is generally only equivalent to level 1 of the Dēus. This is true, for instance, of the Gold Maxx and earlier XP models. The Gold Maxx Power has a reactivity equivalent to level 2 of the Dēus.

Most likely finds with the recommended settings are as follows:

0	Large masses and coins, in ground uncontaminated by iron.
1	Large masses and coins, in ground with little iron contamination, and general use.
2	General use, and mineralised soils contaminated with iron.
3	Difficult soils contaminated with iron, hot rocks, etc.
4/5	Very difficult soils, highly contaminated with iron and hot rocks, sensitivity to small targets.

Note : Higher reactivity levels (3, 4, 5) enable the detector to tolerate fast sweeps better.

REACTIVITY continued...

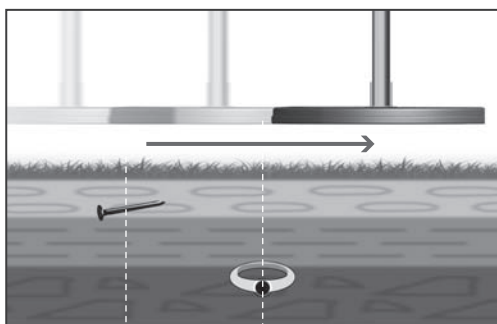

Example

Passing the coil over an iron object close to the surface then over a good metal target (ring).

R
E
A
C
T
I
V
I
T
Y

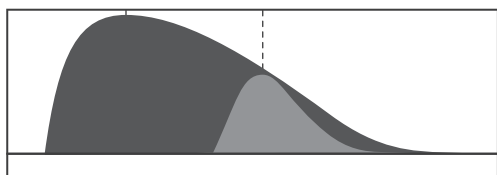

With a low Reactivity level, the iron is detected for a longer duration, to the extent that it completely hides the ring.

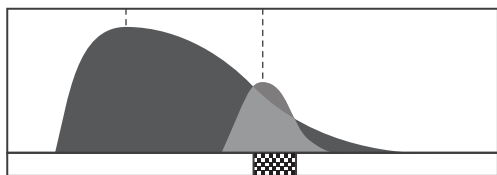

With a medium Reactivity level, you begin detecting the ring. The audio signal partially indicates the target.

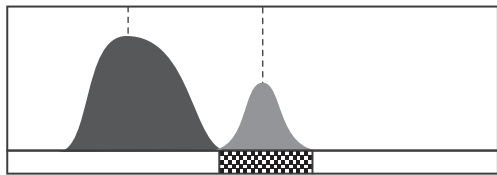

A high Reactivity level enables you to distinguish the ring completely from the iron. The audio signal fully indicates the target.

In terms of pure performance, the greatest detection ranges are obtained with low reactivity levels. However, you will find more targets on difficult ground with medium or high reactivity levels.

So do not just rely on performance in optimal conditions.

Depending on the reactivity level, you will notice that the length of the audio signal varies when it passes over a target:

Low reactivity (0, 1) = long sound



High reactivity (3, 4, 5) = short sound



Evidently the length of any false signals (the crackling of iron for example) will vary proportionately as well.

You are therefore advised not to constantly change the reactivity level, as this may interfere with your ability to distinguish good and bad sounds.

AUDIO RESPONSE

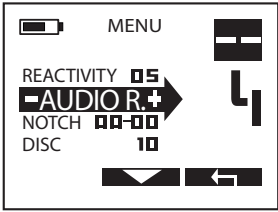

1 Adjust the Audio Response from 0 to 5 with

2 Exit with

The Audio Curve enables you to amplify the sound volume of distant targets and therefore to be more alert to them.

It gives the sensation of greater power, however it does not provide any additional depth as this setting only affects the sound curve (the dynamic range of sounds).

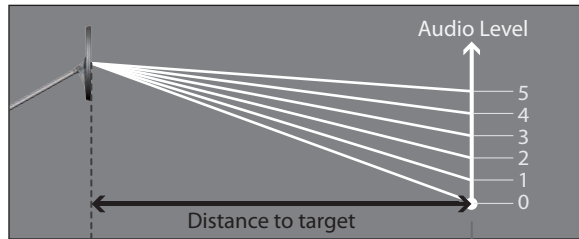

Note : By amplifying small signals you will also be amplifying small spurious false signals.

Note : By increasing the sound response you will compress the dynamic range and thus reduce the appreciation of a target's distance.

NOTCH

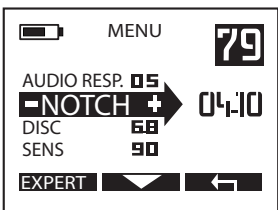

Notch complements discrimination: it enables a "window" of targets to be rejected whereas discrimination rejects all targets below a selected threshold.

For example, if you detect a redundant, undesirable target in the ground, you can decide just to reject the corresponding conductivity group and continue to detect targets whose conductivity is higher and lower than those in this group.

1 If the reference target has a conductivity of 37, adjust the Notch value to 34-40 using

All targets whose conductivity is between 34 and 40 will then be silenced.

2 Exit with

Note : By default, the width of the rejection window is 6 points.

General features

The different levels of soil mineralisation you encounter when prospecting can sometimes affect the performance of your detector.

For example, this may be due to natural magnetic mineralisation such as iron oxide, hot rocks and magnetite, or sporadic mineralisation from sites of former human settlement (also magnetic): hearths, pottery, hot rocks, slag, etc. At the seashore this may also involve mineralisation ranging from magnetic grade (black sand) to electrical conductor grade (salt water) depending on the beach or region.

If you are an experienced detectorist you may wish to optimise your searches to achieve better penetration in some of these mineralised soils.

In magnetic ground with relatively uniform mineralisation, a setting which is adjusted according to the ground effect will improve penetration by reducing the amplitude of the ground signals sent back by the receiver circuits. This 'adapted setting' involves adjusting your ground balance value to the average value of the ground being detected, while adding 1 so as not to hear the ground signals as much. The tracking and pumping modes do this automatically if the ground conditions allow it.



Attention: As the ground balance setting is the one requiring the most experience of the ground, we recommend that you read this chapter carefully and use the different ground balance modes carefully, while acquiring your own experience of the ground.

By default, remain in manual mode at level 90 on inland ground and on dry beach sand.

Note: If the ground is not mineralised there is no need to adjust your ground balance to a level other than 90: since the ground does not send back any significant spurious echo the performance will be optimal even at level 90 and you will reduce interference resulting from knocks to the coil.

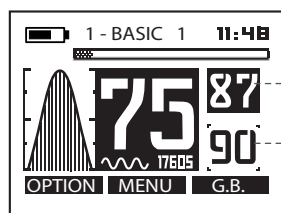

On the main menu, two values are permanently displayed:

----- The ground mineralisation index
(level measured constantly by DĒus for information).

----- The actual level of ground effect corrections
(adjustment underway).



1 Press Ground

4 modes are available:

MANUAL - PUMPING - TRACKING - BEACH (ON / OFF)

MANUAL Mode

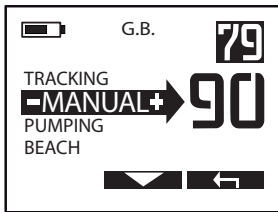

1 Go to **Manual** with

2 Adjust with

3 Exit with

You can manually adjust the ground rejection levels from 60 to 95 (Beach Off mode) or from 0 to 30 (Beach On mode).

90 is the default level, it is the most common level which enables you to reject all magnetic minerals found in the ground.

By reducing G.B. towards 87 you will begin detecting hot rocks, and knocks to the coil may result in false signals. Even lower, between 75/85, pottery and the ground itself will begin interfering with your device.

Note If you are inexperienced in working with ground effects, we strongly suggest that you limit yourself to a Ground Balance level of 90, which is the default setting, and is the most stable reference level recommended for inland ground. Levels lower than 90 will result in increasing instability.

PUMPING Mode

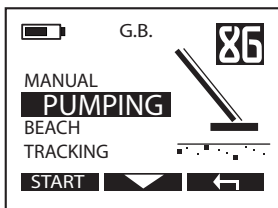

1 Go to **Pumping** with

2 Press **START** and pump the coil on the ground several times until you obtain the display **G.B OK**

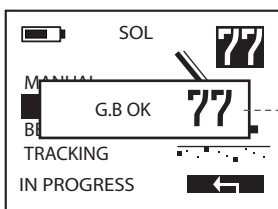

3 Exit with

PUMPING Mode

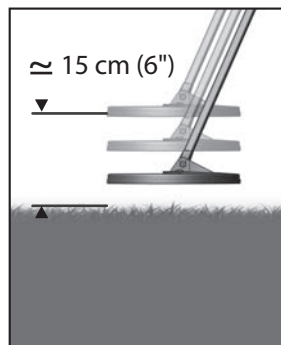

Pumping is a semi-automatic process which allows you to adjust the ground balance in a zone that you have determined as being representative of the mean level of the ground being prospected.

Henceforth, the measured value of the ground is entered in memory and used as the new active ground balance value.

If this value is unsuitable, or if it generates too much instability, you can repeat the process in a different zone or switch to manual mode in order to modify it by, for instance, adding several extra rejection points.

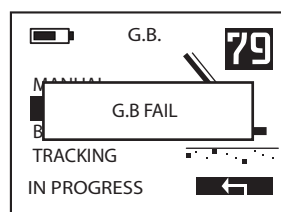

Note : If a metal target is detected while you are pumping, DĒus will recognise

this and display the message

G.B FAIL

It will then retain the previous ground balance value.

This problem is generally caused by iron being present. If this is the case then move to another location and restart the pumping mode.

Note : In low- or non-mineralised ground, there is no need to adjust the ground balance and you are advised to remain on 90 for greater stability.

TRACKING Mode

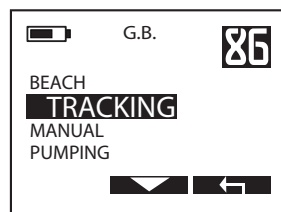

1 Go to **Tracking** with

2 Exit with

In this mode, DĒus repeatedly scans the ground and digitally filters the extracted signals to determine the mean value on a continual basis.

This mode may be useful in soils with relatively uniform mineralisation, and where the mineralisation varies gradually from zone to zone, which is often the case in naturally mineralised ground. In this case, DĒus automatically readjusts the ground balance according to the most recent value measured.

However, in ground where mineralisation has resulted from human presence (ancient settlements, for example) this mode may be unsuitable due to the disparity in the ground events.

TRACKING Mode continued...

Indeed, within the same sweep of just one metre, a considerable variety of ground events may be encountered, ranging from one extreme to the other (values between 70 and 90): hot rocks, brick, slag, pottery interspersed with soil that is neutral or characterised by diverse mineralisation. This may be to such an extent that any mean value would be meaningless. You must then determine an acceptable level of rejection for the ground based on your own experience of the site, your detection methods and the interference that you are prepared to tolerate.

Note : This mode is not available in Beach mode, in wet areas, as the Pumping mode is more effective.

Note : Low ground balance levels also generate the clearest signals on certain irons that are already difficult to eliminate.

Note : With some digital detectors on the market, you will note that when the ground balance settings are low – either in Manual, Pumping or Tracking mode – hot rocks do not register, as they have been somewhat ‘notched’ or inhibited. This trick gives you good stability regardless of the ground rejection level, however it also deprives you of the benefits of a well-adjusted ground balance, and worse, gives you the impression that your settings are well configured.

Very often the deepest targets in magnetic soil are identified with a signature similar to that of hot rocks, and are therefore detected poorly with this kind of device (as they are ‘notched’).

Dēus on the contrary gives you full control over the ground settings.

When you lower the ground balance (87-85-82 etc.) you fully accept hot rocks, which is the only way to obtain real gains in terms of penetration on certain magnetic soils.

BEACH Mode

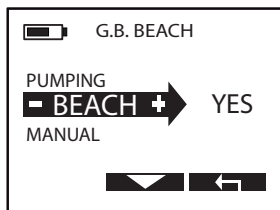

1 Go to **Beach** with

2 Choose **YES** (00-30)

Activates calculation of the ground balance on the zone corresponding to highly saline wet ground, so as to reduce interference caused by conducting salt water.

After selecting Beach ON, you need to adjust the ground balance manually or by pumping on the wet zone concerned, in order to cancel out the ground signal.

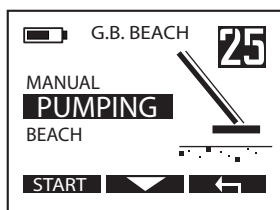

3 Go to **PUMPING** or go to **MANUEL** with

Press **START** and pump the coil on the ground several times until you

obtain the display



In Manual Mode, adjust it from 00 to 30 with

4 Exit with

Note : To improve stability on wet beach (salt water):

- Reduce Audio Response (0-1)
- Increase Reactivity (4-5)
- Power: Level 1 maximum.
- Sensitivity: (70-85).

Note : In wet zones (salt water), it is important to sweep while keeping the coil parallel to the ground, yet not touching it.

Note : In wet zones you can select the Wet Beach factory programme.

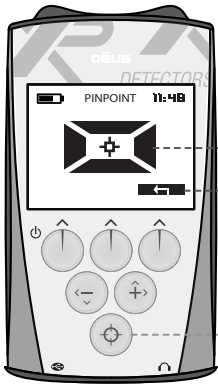

- Animated test card depending on the signal's amplitude
- Press the return button to go back to the home page
- Used to access the none motion (Pinpoint) menu and/or update the threshold

Dēus is designed to operate most of the time in Motion Mode, which means that a metal target will only be detected if the detector's coil is moving. However, the detector can also be operated in Pin Point mode, if required, which means that it will detect even if the coil is motionless above a target.

In modern detectors, none motion mode is most often used to locate a target more precisely (pinpointing).

However this mode is also very useful for detecting the presence of metal in cramped locations, where there is not enough space to swing the coil, or if there is too much interfering metal around the target.

For example, locating hiding places inside houses, cellars and walls.

None motion mode is also widely used in the construction industry to locate metal pipes, as it enables them to be continually tracked.

CALIBRATION OF TRESHOLD

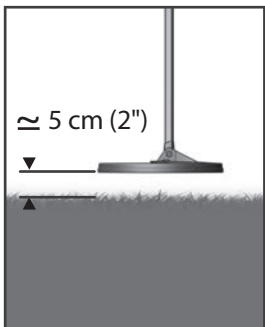

1 Place the coil at a height of approximately 5 cm (2") above the ground on a zone free of metal targets

2 Press  (**Pinpoint**)

The sound threshold is calibrated and you are switched to none motion mode. Calibration of the threshold can be repeated at any time by pressing the Pinpoint button again. If you are continually searching in none motion mode you will need to recalibrate this threshold at regular intervals. The stability and sensitivity of the none motion mode will depend on how effectively the detector has been calibrated:

If you recalibrate the threshold with the coil too far from the ground, then sensitivity will be lower but the device will be more stable.

If you recalibrate the threshold with the coil too close to the ground, then its sensitivity in none motion mode will be high but the device will be unstable on the ground.

The ground mineralisation should help you determine the best height for obtaining the desired level of sensitivity.

Note : In Motion Mode, very rapid crossed sweeps are usually sufficient to locate a target.

These enable you to save your settings, create new programmes and configure your equipment's basic parameters.

PROGRAMMES

Listed here are the nine detection programmes which were pre-configured at the factory. You can modify the name of a programme, save modifications made to a programme or restore a factory programme.

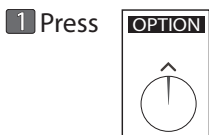
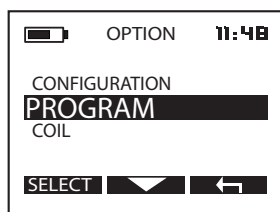

2 Choose **PROGRAM** with  then press **SELECT**

Modify the name of a programme

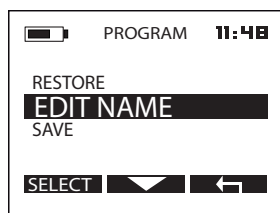

1 Press  to scroll through the menu and stop on the programme you wish to modify, then press **OPTION**

2 Press  and stop on **EDIT NAME**

3 Press **SELECT** and scroll with 

And  to advance to the next data entry zone

Or  to delete the previous character.

Press **VALID** and  X2 to return to the main menu.

Save a modified programme

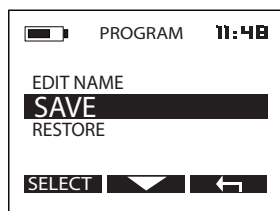

1 Press  to scroll through the menu and stop on the programme you wish to save, then press **OPTION**

2 Scroll with  and stop on **SAVE**

3 Press **SELECT** to save.

4 Choose either YES or NO to confirm.

5 Press  X2 to return to the main menu.

PROGRAMMES continued...

Restore a programme

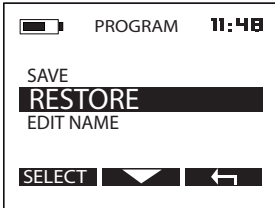

- 1 Press to scroll through the menu and stop on the programme you wish to restore, then press **OPTION**
- 2 Scroll with and stop on **RESTORE**
- 3 Press **SELECT** to restore.
- 4 Choose either YES or NO to confirm.
- 5 Press X2 to return to the main menu.

COIL

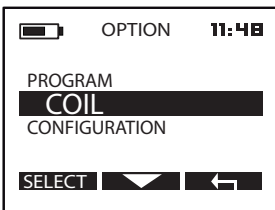

When first purchased, Dēus is only configured to operate with its original coil.

If you have one or more optional coils which have already been paired (pg 24), you can select which one you want to use for your detection session, from the list in the menu.

- 1 Press **OPTION**
- 2 Choose **COIL** with then press **SELECT**
- 3 Switch on the headphones close to the remote control.
- 4 On the remote control, press to scroll through the list of available coils and stop on the one you wish to activate. This coil automatically becomes active within 4 seconds, while the previous coil reverts to standby mode.
- 5 Press X2 to return to the main menu.

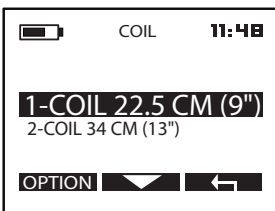

Example

Note : If you switch on the headphones after changing the coil via the remote control, the headphones will not automatically register this change. You will therefore need to change the coil manually via the headphones. (pg 24)

COIL continued...

Pairing the remote control and the headphones with a new coil

If you purchase an additional coil, you need to pair it with the remote control and the headphones the first time you use it, to enable Dēus to recognise and communicate with it. You can then switch between coils just with a simple click via the remote control.

To pair a new coil you have to give it a name (e.g: "34cm Coil") and enter its serial number in the remote control and headphones. The serial number is printed on the coil and is sometimes found on the invoice as well.

Before you pair a new coil, turn on the headphones and remote control.

Check that they both work correctly with your original coil.

Keep the headphones, remote control and also the new coil close to each other and follow the following steps:

Entering the name

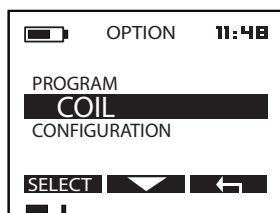

1 Press **OPTION**

2 Choose **COIL** with  then press **SELECT**

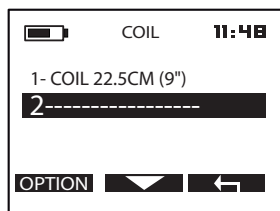

3 Select an unused slot (-----) with  then press **OPTION**

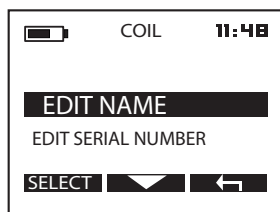

4 Choose **EDIT NAME** with  then press **SELECT**

At the point where the cursor is flashing, scroll through the characters using  to make your choice.

Press  to advance to the next character.

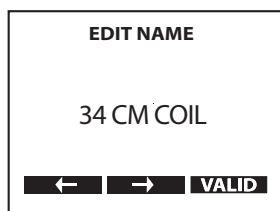

5 Once the name of the new coil has been entered (e.g: "34 cm Coil"), Press **VALID**

COIL continued...

Entering the serial number

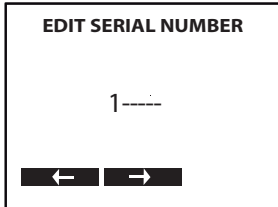

6 At the point where the cursor is flashing, scroll through the characters.

using and press to advance to the next digit.

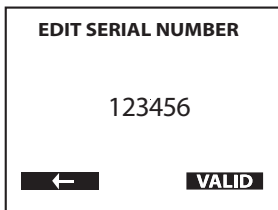

7 At the sixth digit press **VALID** then X2 to return to the main menu.

The remote control now adds this new coil to its list, then transfers the updated list to the headphones.



if the headphones do not recognise this coil, for example because they were switched off while the serial number was being entered in the remote control, You then have 2 options to pair it:

1: Turn on the headphones and the remote control with the previous coil (for example the original one). The list of coils from the remote control will be sent automatically to the headphones.

2: enter this new coil's serial number manually in the headphones as well (pg 30).



A coil's serial number is unique. The headphones or remote control cannot function with a coil if the number entered does not correspond to the actual serial number printed on the coil.

CONFIGURATION

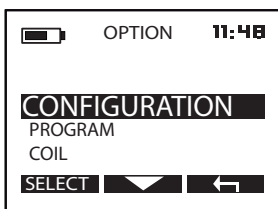

This allows you to modify the remote control's general technical settings.

1 Press **OPTION**

2 Choose **CONFIGURATION** with then press **SELECT**

CONFIGURATION continued ...

Loudspeaker

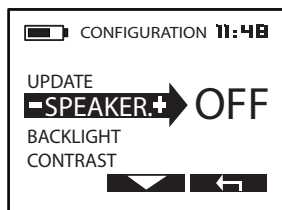

Enables the remote control's loudspeaker to be activated or deactivated.

- 1 Choose **SPEAKER** with
- 2 Press and choose ON or OFF
- 3 Press x2 to return to the main menu.

Duration of backlighting

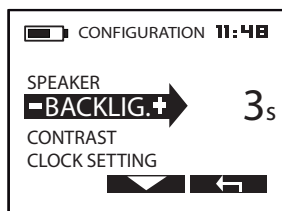

The remote control screen has a backlighting function which comes on as soon as any button is pressed and goes off automatically after a certain length of time. You can define this time in seconds:

OFF - 3s - 10s - 60s - 120s - ON (permanent)

- 1 Choose **BACKLIG** with
- 2 Press to change the duration of the backlighting.
- 3 Press x2 to return to the main menu.

Note : You can leave the backlighting on permanently (ON) as this function uses very little power and only affects the remote control's battery life by about 10%.

Contrast

To improve readability in all lighting conditions you can adjust the contrast of the display.

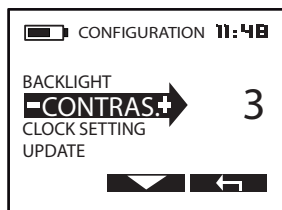

- 1 Choose **CONTRAS** with
- 2 Press to change the contrast value.
- 3 Press x2 to return to the main menu.

CONFIGURATION continued ...

Time

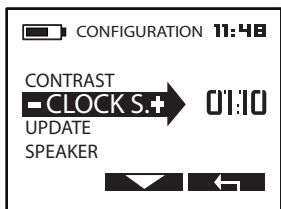

This changes the time that is displayed on the main menu.

- 1 Choose **CLOCKS** with
- 2 Press adjust the time.
- 3 Press x2 to return to the main menu.

Updates

The software can be updated via the Dēus USB interface and an internet connection.
Full information is available on our website:

www.xpmetaldetectors.com/deus/update

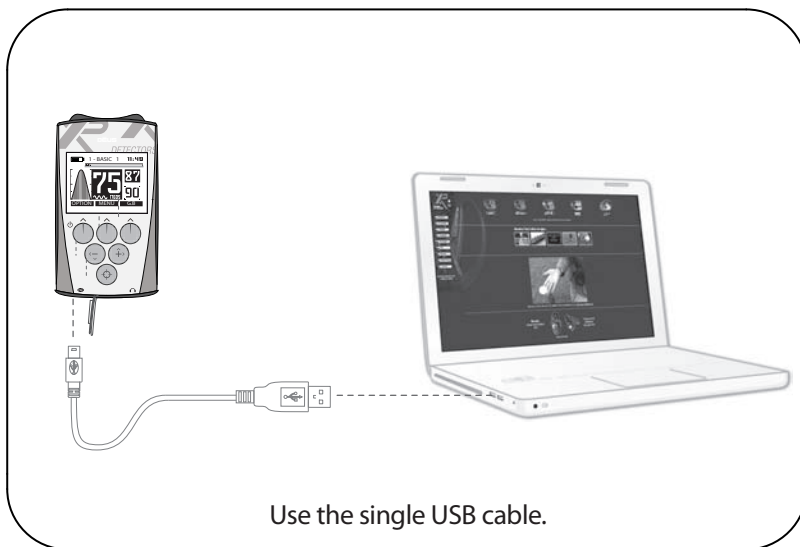



Indicates the battery charge level of the coil and the headphones (alternates every 4 seconds)

 **Displayed** : Coil battery level-----
Not displayed : Headphones battery level---

Indicates the setting value or the number of the factory programme P1, P2, etc

Indicates that the radio link with the coil is active

Control pads
Increase / decrease values

To switch ON : Press 

To switch OFF : Press simultaneously

 and 

USB/mini-B charging connection

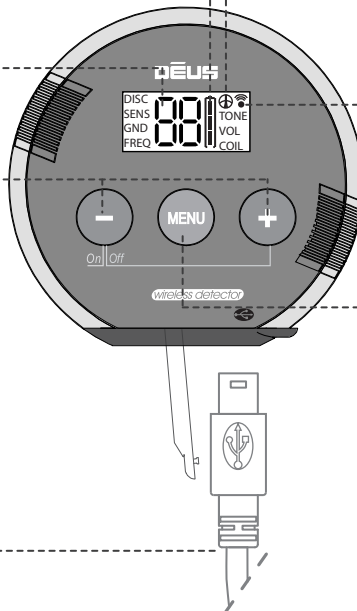

Used to scroll through the detection menus and their setting values:

- DISC ----- Discrimination
- SENS ----- Sensitivity
- GND ----- Ground
- FREQ ----- Frequency
- TONE ----- Tone number
- VOL ----- Audio volume
- COIL ----- Selected coil
- P1 to P9 ----- Factory programmes

MENU



Menus accessed via the headphones have the same range of settings as the remote control.

Remote control ON: Only the volume control can be adjusted.

Remote control OFF: All settings can be adjusted.

Press to access the different menus



DISC Discrimination: 0-99 (pg 09).

Adjusts with

-----A flashing digit represents a digit after the decimal point.



SENS Sensitivity: 0-99 (pg10).

Adjusts with



GND Ground balance (pg 17).

60-95: (inland ground)

0-30: (Only with program N°7, for beach, wet zone)

Adjusts with



FREQ Choice of frequency used: 4, 8, 12, 18kHz (pg 11).

Change with



TONE Choice of number of tones: 2, 3, 4 tons, P! (PITCH) (pg 36).

Change with



VOL Adjusts sound volume in headphones: 0-9.

Adjusts with

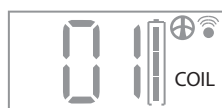

COIL Choice of coil used when several are available.

The coils are numbered according to the order in which they were entered:

01 = Original coil

02= Optional coil 1

03= Optional coil 2, etc.

MENU continued...

COIL continued

If you are detecting with the remote control and you use it to change to a new coil, the headphones will automatically register this change (if they are switched on). Otherwise it can be done manually with this menu.

Always leave the headphones switched on when you are changing the coil via the remote control, otherwise they will not register the change and will remain connected to the previous coil. If this should occur, use the remote control to return to the previous coil (with the headphones switched on) and switch to the new coil again to re-register it with the headphones.



Remember that before you can use a new coil for the first time, you need to enter its serial number in the headphones and remote control (pg 24/30).

Pairing the Headphones with a new Coil

When delivered, the headphones and remote control have already been paired with the original coil, so no action is required on your part.

However, if you purchase an additional coil, before using it for the first time you need to pair it with the remote control and the headphones, to enable it to recognise and communicate with them.

You can then change coils with a simple click using the remote control (pg 23) or your headphones (pg 30).

If you leave the headphones switched on when you pair the remote control with a new coil, they are also paired with this new coil, which is then added automatically to the list in the headphones menu (pg 24).

If you do not have the remote control, or in the event of a problem, you can manually pair the headphones with a new coil. To do this you need the serial number of the coil to be paired:





1 Press  until you reach COIL

2 Choose a free slot with   for example 02 (01 is already assigned to the original coil).

If this coil has already been paired with the remote control, ensure you choose the same slot number in the headphones.

3 Press  for 2 seconds to switch to serial number entry mode.

4 With   enter the first digit of the serial number then validate it with 

MENU continued...



5 With enter the second digit then validate it with

6 With enter the third digit then validate it with

Continue in this way until you reach the sixth digit.

The new coil is now operational in this slot and should become active.



A coil's serial number is unique.

Dēus cannot use a coil if the number entered does not correspond to the actual serial number printed on the coil (and sometimes appearing on the invoice as well).

Programs P1 to P9

Choice of one of the 9 pre-configured factory programmes.

1 Press and go to P1/9 screen.

2 Scroll with and choose the programme number.

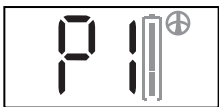

The programmes are identical to those in the remote control and are numbered in the same way from 1 to 9.

e.g. P3 headphone = factory programme 3 in the remote control.

Programme 7 is the remote control's wet beach mode and is designed to be used in the wet zone of a beach. Its ground balance settings range from 0 to 30, not 60 to 95 like the other settings.

Note: Each time that the remote control is switched on next to its accompanying headphones, all the remote control's settings are loaded into the headphones, which then store them in memory even when switched off. This only works if the headphones and remote control have both been paired and are using the same (serial number) coil.

Replacement of the backphone



The earphone of the wireless headphones contains all the electronics and the lithium battery, it represents your headphone's brain! (**ref: D091**). Fitted on a sliding support, it has the advantage of being able to disconnect from the backphone with a single click.

This backphone is an inexpensive wearing part that can easily be replaced by any of our resellers (**ref: D096**).

LOW BATTERY LIGHTS

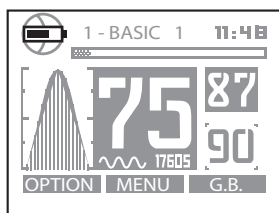

The remote control alternately displays :

The symbol  which indicates the coil's charge level.

The symbol  which indicates its own charge level.



If you only use the headphones without the remote control, you will also need to know the coil's charge level.

 **Displayed = coil's charge level**.....
Not displayed = headphone's charge level.....

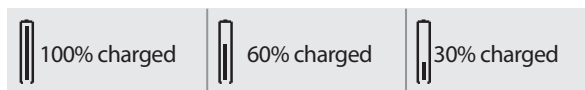
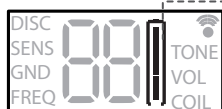

BATTERY LIFE

HEADPHONES: 20 hours / **REMOTE CONTROL:** 20 hours / **COIL :** ± 10 hours

The search coil's battery life may vary depending on the modes used. The table below shows battery life according to frequency and power selected.

	Power at 1	Power at 2	Power at 3
Frequency 4 kHz			7 hours (Fixed power)
Frequency 8 kHz	12 hours	8 hours	7 hours
Frequency 12 kHz	12 hours	8 hours	7 hours
Frequency 18 kHz	13 hours	9 hours	7 hours

May vary depending on the age of the battery.

Note : Dèus is regulated in such a way that avoids any deterioration in performance even when the battery level is lower!

CHARGING TIME

COIL: 90mn / **REMOTE CONTROL** and **HEADPHONES:** 120mn.

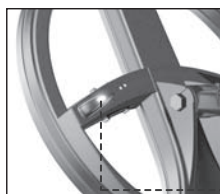

LiPo batteries (Lithium polymer) do not suffer from the 'memory effect' so you can recharge them at any time without first having to wait for them to fully discharge.

The LED on the coil is on continually when charging is underway. When charging is complete, the LED reverts to flashing intermittently.

(3 seconds ON, 3seconds OFF)

CHARGE

The search coil, remote control and headphones are all powered by identical lithium polymer batteries. These miniature, high-capacity batteries can be recharged quickly. The different Déus elements can be charged while switched on or off, but switching them off speeds up the process.

You should use the power adaptor supplied, which enables all three elements to be charged simultaneously when used with the USB/3 mini-B cable, also supplied.

- 1 Connect the **USB plug** to the power adaptor
- 2 Connect the **mini-B plugs** to the remote control, headphones and to the charging clamp.

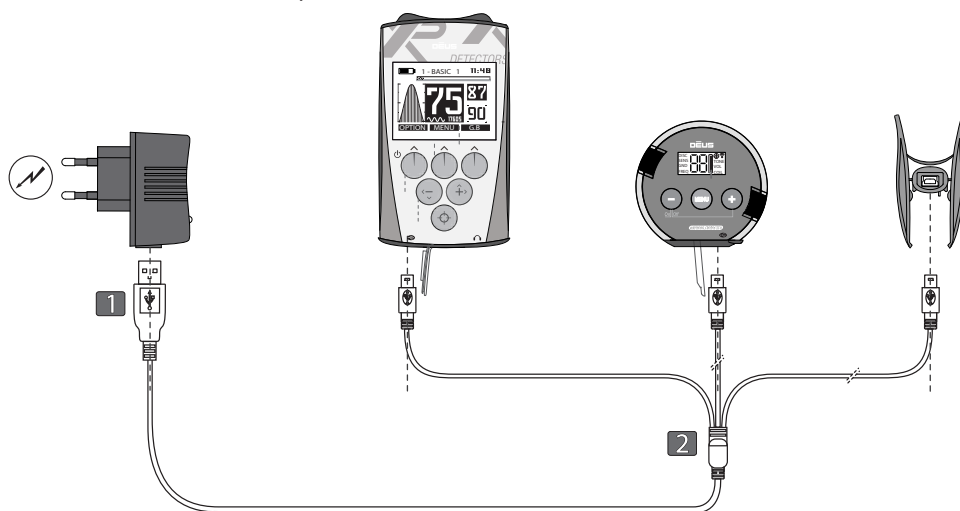

The search coil is charged via the connection clamp supplied, which is connected to the coil according to the grooves in the coil cover.

You will see that the clamp is shaped in such a way to prevent it being connected the wrong way round.

Correct

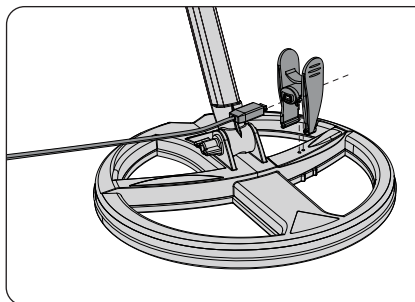

Incorrect

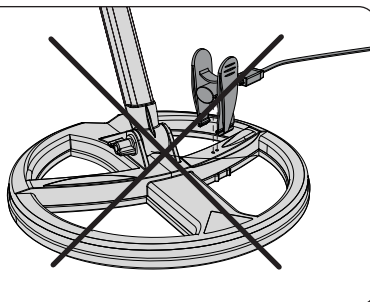

Ensure that the clamp is the right way round before connecting it to the coil

LITHIUM POLYMER (LIPO) BATTERY DURABILITY

The LiPo batteries are designed to bear hundreds of charges and to last several years in your detector, thus resulting in significant savings in terms of purchase of batteries.

After 300 to 400 charging cycles the battery still has 80% of its capacity, which then gradually begins to decrease over subsequent cycles.

As an indication, the batteries should last for around 3 to 4 years when used on a weekly basis.

Attention: long-term storage of discharged batteries may reduce their overall durability. If the detector has to be placed in storage, first charge the batteries to half of their capacity (40 to 70%). 

Ideally you should then discharge/recharge them at least once a month.



Do not store your device for long periods with discharged batteries!

REPLACING BATTERIES

The three Dēus batteries are identical.

The batteries for the wireless headphones and the remote control are easy to replace as they are connected to the circuit with a mini-connector and double-sided adhesive tape.

The search coil battery is sealed for obvious reasons of safety and impermeability. It must be returned to our service department or an **XP** distributor for replacement.

PRECAUTIONS RELATING TO USE OF THE POWER ADAPTOR AND BATTERY

Acceptable ambient temperature during charging: **0° to 40°C Maximum**

Recommended storage temperature: **25°C**

Batteries



- The batteries are fitted with internal protection systems which shield them from extreme overloads and discharges. They must not be dismantled or short-circuited, which is dangerous and could destroy the protection systems or cause the batteries to smoulder or ignite.

- Do not leave batteries charging unnecessarily and disconnect the power adaptor when the charge cycle is complete or after 120mn.

- If you notice any perforation, odour or other anomaly, please return the battery to the seller in a sealed plastic bag and don't try to charge again.

- Never dispose of lithium batteries with your household waste: return them to your XP seller or take them to a designated collection point.



- Do not place the batteries near heat sources and never throw them onto a fire. Never perforate the battery cover or try and weld/solder the battery.

- Do not short-circuit the battery terminals.

- Risk of explosion if battery is incorrectly replaced.

Replacing the battery with another of the incorrect type can lead to an explosion risk. Only use LiPo batteries supplied by **XP (ref : D088)**.

Power adaptor



- The power adaptor is only designed for indoor use and should not be exposed to water or humidity.

- Always connect your power adaptor in an accessible, visible place to ensure that it can be unplugged quickly in the event of overheating or other problems.

- Use the special XP chargers in the recommended charging method to charge the battery, do not use other charger, that will cause the battery internal short-circuit and make it heat, smoke or burn.



- Do not charge the devices during a thunderstorm and unplug the power adaptor from the supply.

- Do not charge close to inflammable parts.

Xplorer shall not be held liable for any consequences arising from a failure to comply with the precautions for use.

This section covers the advanced settings. You should ensure that you have studied all the basic parameters before moving on to this section.

MULTI TONES

2 TONES - 3 TONES- 4 TONES

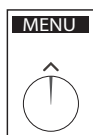

1 Press **MENU**

2 Choose DISCRI with

3 Press **EXPERT**

4 Choose 2 tones - 3 tones - 4 tones - Pitch using

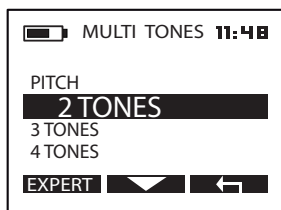

You can use the Multi-tones menu to sort targets into categories according to their conductivity, by assigning a specific audio tone to each category. The higher the target's conductivity, the higher the pitch of the tone. Take some time to become familiar with the 2 tones, 3 tones, 4 tones modes using different targets, such as an iron nail and some aluminium foil, different coins, etc. The lowest pitched tone is assigned to iron. If you do not wish to hear it, select "Iron Volume" from the menu and reduce its volume to 0.

Note: If you are in 2 tones mode (low/medium tone) and you reduce the iron level (low-pitched tone) to 0, you then find yourself in 1 tone mode (medium), which is why there is no 1 tone mode in this scrolling menu.

PITCH

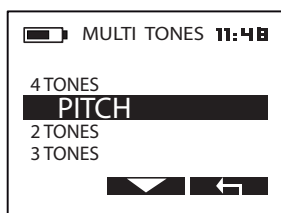

Pitch mode is completely different from the others. It does not take into account the target's conductivity: the strength of the signal generates an audio signal that varies both in amplitude and height (the audio frequency). This means that a more distant target will generate a low-pitched, weak sound whereas a closer target will generate a high-pitched, strong sound. Pitch mode gives signals particular dynamism and can be useful for locating targets.

It also makes the detector seem more reactive. However, it does not fundamentally affect reactivity, just the audio.

MULTI TONES, Thresholds and Tones

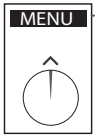

1 Press **MENU**

2 Scroll with and select **DISC**

3 Press **EXPERT**

4 Choose 2 tones - 3 tones - 4 tones - Pitch with

5 Once you have selected the number of tones (for example: 4 tones) Press **EXPERT**



You have the option of customising the sound partitioning of the discrimination range.

A sound frequency (comparatively low- or high-pitched) is assigned to each part of the discrimination range. In this example, a low-pitched sound (202 Hz) is assigned to the signals from 0 to 10, a higher-pitched sound (518 Hz) is assigned to the part from 10 to 60, then 644 Hz is assigned to 60 to 87 and lastly a very high-pitched sound (757 Hz) is assigned to the part from 87 to 99.

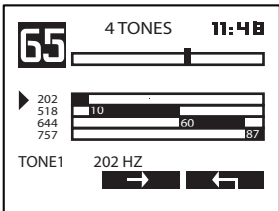

6 Press in order to move the cursor (black triangle) from one setting zone to another.

Note that the cursor first moves up and down to indicate the sound **frequencies** used, then from left to right to indicate each **threshold**.

7 Adjust the sound frequencies and thresholds with

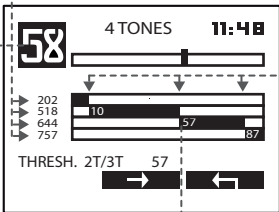

Example: If a coin type, which your device registers as 58 on the conductivity index, signals as "medium low" (518 Hz) and you wish it to be signalled as "medium high" (644 Hz), you simply lower the threshold from **60 to 57** or less.

Now, all coins with this conductivity value will register at 644 Hz.

Note : The black bar showing the index of the target is displayed in the top left of the screen (black bar) for help. This enables you to directly adjust the sound responses for targets you select as references.

THRESH 1T / 2T
 =
DISC.

Note : The threshold 1 separating the low-pitched tone (tone 1) from the medium tone (tone 2) is the same as the Discrimination value. These are the same settings.

TX POWER

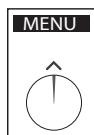

1 Press **MENU**

2 Scroll with and select **SENS**

3 Press **EXPERT**

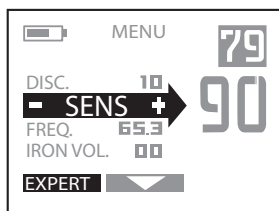

Dêus enables you to adjust the strength of the emitted electromagnetic field according to three levels (from 1 to 3).

4 It is adjusted using

5 Press x2 to return to the main menu.

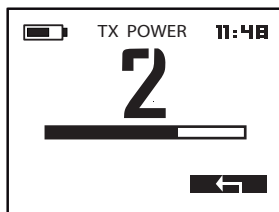

By default the power is set to level 2, which offers a very dependable performance level that is largely sufficient in most cases.

The power only has a subtle effect on the device's pure performance with regard to sensitivity. However, it increases your detector's power consumption as well as alter its stability on difficult ground.

On iron-infested, mineralised ground, there is no need to use a high power setting, level 1 will be sufficient as in any case it is impossible to detect deeply in this kind of ground.

It is therefore better to limit the saturation caused by iron and the ground by lowering the setting. In this way you will improve analysis and will ultimately find as many, if not more, targets since you will be better able to hear them.

Note : Power is set to maximum for the 4 kHz frequency.

You do not therefore have access to the Expert menu when you are on this frequency.

FREQUENCY SHIFT

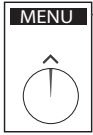

1 Press **MENU**

2 Scroll with and select **FREQ.**

3 Press **EXPERT**

4 Adjust the frequency with

5 Press x2 to return to the main menu.

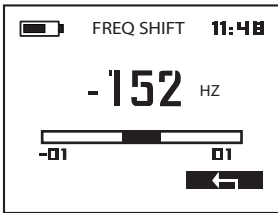

You can shift your operational frequency slightly to avoid occasional interference, particularly that generated by another detector nearby. Starting from the central frequency, two other frequencies are available.

Note: Wherever possible, remain on the central frequency, which is more closely attuned to the emitter coil.

During a rally or other group event, if you suffer from any interference do not hesitate to shift the frequency.

You can also simply change the basic frequency (4, 8, 12, 18kHz) to avoid interference from your team mate's detector

Note: 4kHz frequency is fixed and cannot be shifted.

SILENCER

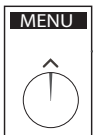

1 Press **MENU**

2 Scroll with and select **REACTIVITY**

3 Press **EXPERT**

4 Adjust the Silencer with

5 Press x2 to return to the main menu.

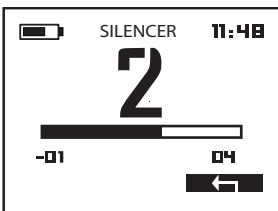

Iron is more easily discriminated than other metals because of its unique signature which is related to its ferromagnetic properties.

However, large iron objects or certain unusual shapes are often more difficult, or even impossible, to discriminate.

SILENCER continued

These partially discriminated iron objects often generate a few audible remnants of broken, inconsistent signals (crackling).

Depending on your abilities and preferences, you may wish to remove this crackling using the Silencer.

When you increase the value of the silencer you are applying a filter which eliminates the crackling caused by iron.

Level 2 represents a good compromise, but if you have difficulty distinguishing iron from non-iron, then use a higher level such as 2, 3 or 4.

Note : The Reactivity menu takes precedence over the silencer, so if you change the reactivity value this automatically imposes an appropriate silencer value. This is designed to avoid the silencer being set to a value that could reduce the effectiveness of the reactivity setting.

MULTI NOTCH AND WINDOW TH

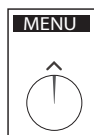

1 Press **MENU**

2 Scroll with and select **NOTCH**

3 Press **EXPERT** and go to NOTCH screen.

4 This advanced notch function enables you to widen the rejection window in the event that the undesirable target(s) have a wider conductivity range than the standard 6-point window.

For example, if the undesirable target is generating a signature ranging from 28 to 46, you can use this option to lower the value of Threshold 1 to 28 and increase Threshold 2 to 46.

5 Select threshold 1 or 2 with

6 Adjust the values with

7 Press X2 to return to the main menu.

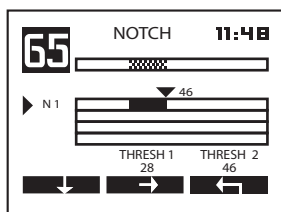

If several targets with different conductivity levels are bothering you, you can activate two other notches: N2 and N3

Use to select N2 or N3, and adjust as for N1.

To exit use

Note : You will note that the notched zones are greyed out in the conductivity bar on the main page.

ADVICE BEFORE BEGINNING DETECTING

Metal detecting is a fascinating leisure activity that can bring you a lot of satisfaction. However, it requires a minimum of learning in order to get the most enjoyment.

Begin by familiarising yourself with your equipment and its operation on a suitable practice ground.

To do this, we recommend that you take an assortment of different objects: coins, everyday items, metal rubbish, etc. Then find a patch of ground relatively free from metal pollution and far away from any electromagnetic interference (high voltage power lines, electric fences, domestic appliances, etc.). For instance your garden would probably be one of the most unsuitable places to begin as there is too much domestic waste in the vicinity.

To ensure that the site is suitable for practising, swing the coil over the ground as if detecting. If you hear a multitude of sounds then move to another place.

Once you have found a suitable spot, arrange your objects on the ground, spacing them approximately two coil widths apart. Before placing an object, use the device to check that there is no metal already in the ground.

Then, take some time to observe your device's reactions when it passes over each target. You can then sort them according to the sound response type and try and understand what makes them similar or different. If you feel comfortable with this exercise, you can also try out some of the pre-configured settings.

OPTIMISE YOUR SEARCHING

When detecting, it is important that you sweep the coil parallel to the ground, using wide movements, as close as possible to the surface (without actually touching it). Proximity to the ground will increase the likelihood of detecting a deep target and will enable the most discreet objects to be identified more easily. You are advised to avoid knocking the coil, as although it is designed to tolerate this kind of stress, careful treatment will prolong the life of the device and guarantee you better perception of targets.

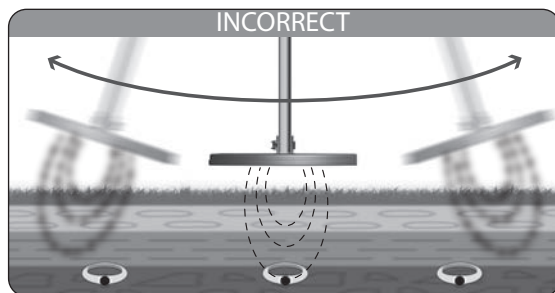
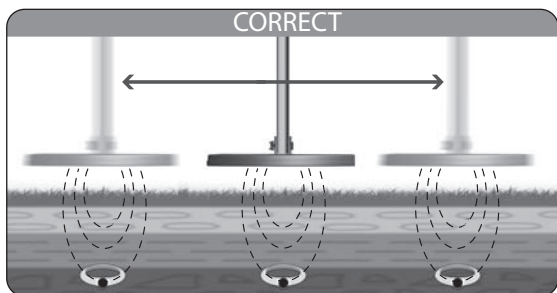

OPTIMISE YOUR SEARCHING (continued)

When you are detecting, you are free to choose the rate at which you move.

For example, if you prefer to cover a zone at high speed while detecting, this will certainly give you a global 'snapshot' of the site. However, it is clear that this way of detecting will also leave large areas of ground unexplored between each sweep. On the other hand, if you insist on closely scrutinising every inch of the ground, you should ensure that each sweep slightly overlaps the previous one, in order to reduce to a minimum the area that your coil has not scanned.

You should also bear in mind that you will further increase your chances of finding and identifying a target by sweeping more slowly. This particularly applies in metal-infested ground (when there are more targets to be sorted) or when you are searching for deeper targets.

LOCATING A TARGET USING CROSSED SWEEPS IN MOTION MODE

Once the detector has indicated the approximate presence of a target in Motion mode, if you are having difficulty locating the target then sweep the place where you heard the sound.

Slowly reduce the amplitude of your movements and make a mental note of the spot where the sound is loudest. If necessary, indicate it with a mark on the ground. Then move a quarter turn around the spot and begin sweeping again in the same way (at 90° to the first sweep).

You should then locate the precise zone containing your target at the intersection of the two sweeps, where the sound is loudest.

Continue with crossed sweeps over the target. The loudest and highest pitched audio signal indicates the centre of the coil and therefore the position of the target.

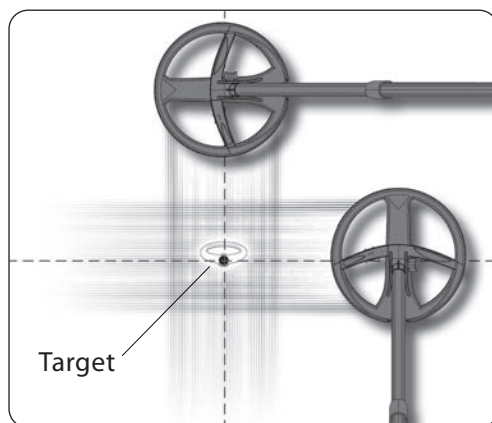

Dēus is a precision device, designed to better address any detection constraints and be as robust as possible. Despite this, it is important to take care of it and exercise certain precautions in order to prolong its life:



Do not store your device for long periods with discharged batteries. Ideally you should discharge/recharge the batteries at least once a month, and if possible store them 40 to 70% charged.



Do not expose your detector to extreme temperatures, particularly inside a car in full sun.



Do not expose your detector to the sun without reason when it is not being used.



When you switch on the detector ensure that the coil is not near any metal objects.



Neither the remote control nor the headphones are waterproof. In wet weather be sure to protect them!



Use the storage case that is supplied with the headphones and never carry them at the bottom of a bag without protection.



Use the case that is supplied with the remote control to protect it in adverse conditions, and when the detector is stored away.



Do not use solvents or alcohol to clean the detector. Soapy water is sufficient.



Depending on how you use your detector, it may be advisable to clean its elements regularly. A damp cloth can be used to clean the non-waterproof parts (headphones and remote control).



After use, remove any dirt from the stem's locking mechanisms.

You become aware of abnormal performance, instability, false signals, misplaced interference, for no apparent reason

CAUSES	SOLUTIONS
Sensitivity is too high.	Lower it.
You are in a zone with a lot of interference (high-voltage power lines, electric transformer, electric fence).	Lower the sensitivity or move to a different zone.
There is a storm nearby and the electromagnetic discharges of lightning are interfering with the detector.	Switch off and wait for the storm to pass
You are close to other working metal detectors.	Change or shift the frequency (pg 11/12).
You switched on the detector with the coil near a metal surface or near the stem's aluminium tube (in the folded-up position).	Switch it off, then on again with the coil in the air and the stem fully deployed, away from any sources of metal.
The ground balance is set too low.	In manual mode set it to 90.
The battery is discharged.	Recharge it.
The ground is heavily infested with iron and other metals.	Find a less infested place. Don't practice in your garden!

The coil does not switch on, unlike the remote control and the headphones

CAUSES	SOLUTIONS
You have a different coil selected in the menu : OPTION / Coil from the remote control or in the menu COIL from the headphones.	Select the corresponding coil (pg 24/29).
The serial number of the coil that you had entered in the remote control was incorrect or was changed inadvertently.	Check the coil's serial number (pg 24/30).
The coil battery is drained.	Recharge it.
The coil battery has reached the end of its lifespan.	Contact your reseller or XP .
The coil is defective.	Contact your reseller or XP .

There is no detection sound in the headphones despite them being switched on (and pressing the buttons generates an audible beep)

CAUSES	SOLUTIONS
Check that you do not have a different coil selected in the COIL menu (pg 29/30).	Select the right coil (pg 29/30).
The headphones have not yet been paired with the coil.	Pair them (pg 30).
The coil's serial number was changed inadvertently in the headphones and the headphones are no longer paired with the coil.	Pair them (pg 30).

There is no sound in the headphones when passing over a target and pressing the buttons generates no audible beep

CAUSES	SOLUTIONS
The backphone is faulty.	Change it, it is easy to replace (pg 31/48).
The earpiece is faulty, for example its keypad was poorly reconnected to the circuit after being dismantled, or the audio contacts are faulty or dirty.	Contact your reseller or XP .

Too many false signals when the coil is knocked

CAUSES	SOLUTIONS
The ground balance is set too low.	Adjust the ground balance to 90 then try again.
Difficult ground, highly mineralised and infested.	Change to a different zone.

The detectors beeps on pottery and "hot rocks"

CAUSES	SOLUTIONS
Ground control is too low.	Increase the ground balance level until false signals stop.

Radio	Link	Digital wireless
	Channels	36 automatic channels
Settings	Radio frequencies and Radio power	2.4 GHz / 0.56 mW
	Detection frequency	4 kHz, 8 kHz, 12 kHz, 18 kHz + shifts
	Sensitivity	99 levels
	Transmitter Power	3 levels
	Reactivity	6 levels
	Sound Curve	6 levels
	Iron level	6 levels
	Multi tones	1, 2, 3, 4 tones, Pitch,+ Expert
	Ground balance	Tracking, Pumping, Manual, Wet beach
	Multi-notch	Yes, with adjustable window width
	Mode	Motion/None Motion
	Pinpoint	Yes, audio and visual
	Discrimination	Audio and visual
	Iron discrimination range	82 levels
	Non-iron discrimination range	90 levels
	Factory programmes	x9 (can be modified and saved)
	Audio volume	Yes on wireless headphones
General Features	Display screen	8192 pixels
	Backlighting	Yes, very low power consumption
	Software updates	Yes, via USB / Internet connection
	Wireless headphones	Yes (can also serve as control unit)
	Coil	DD - Carbon fibre - Waterproof - Wireless
	Coil cover	Yes
	Belt-mounted remote control case	Yes
	Headphones storage case	Yes
	Stem	Fully telescopic, S-shaped
	Batteries	Lithium polymer, miniature x3
	Battery level indicator	Yes, for all 3 elements
	Remote control battery life	20 hours
	Wireless headphones battery life	20 hours
	Coil battery life	10 hours on average
	Mains power charger	Yes - rapid and simultaneous charging of all 3 elements. Input 100-200V 50/60Hz, Output 5V ---1A
	Field charger	Optional, with 1 AA battery + 5 LED torch function
	Car cigarette lighter charger	Optional
	Charging time	Coil: 90 mn, Headphones/Remote control: 120mn
	Total weight with batteries	979 g (880g without remote control)
	Total weight of stem	435 g
	Weight of remote control with battery	100 g
	Weight of headphones with battery	80 g
	Weight of coil	430 g with coil cover
	Length of folded stem	58 cm
	Length of deployed stem	130 cm
	Operating T°	-5°C to 45°C
	Max ambient T° during charging	0°C to 40°C
Recommended storage T°	25°C	
Waterproof coil	Yes, but need an optional accessory to work (2010)	
Guarantee	2 years parts and labour (mains power charger and batteries included)	
Patents	Registered and pending	

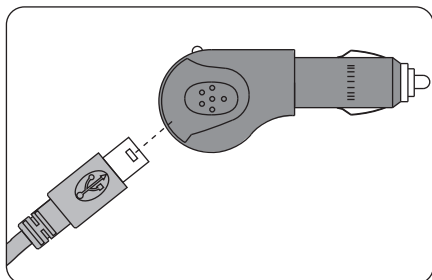

Car charger

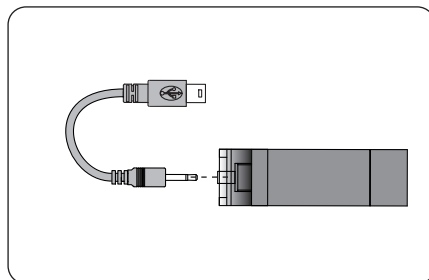

Emergency charger with AA battery (x1)
with 5 LED torch function
(Battery not provided)



Other optional coils 34 / 28 cm DD

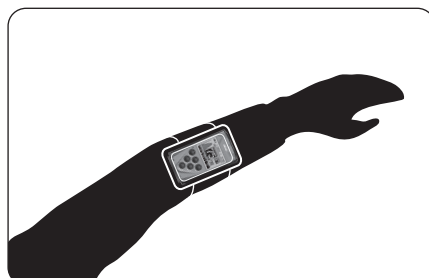

Armband case



Security Strap for remote control



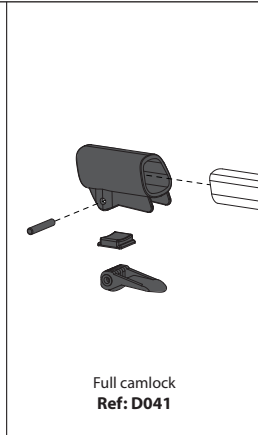
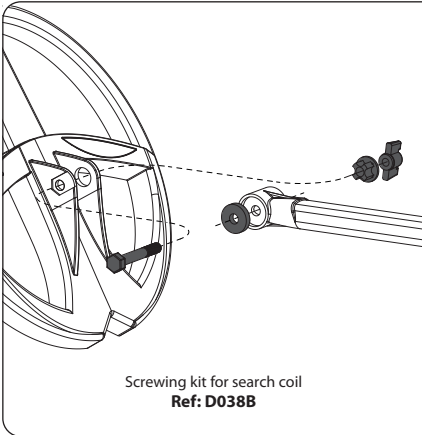
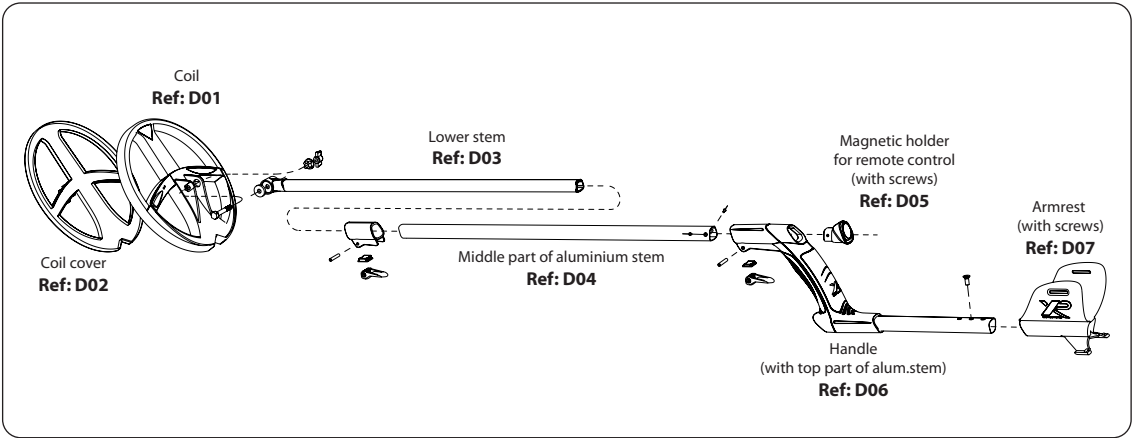

FULL REMOTE CONTROL - Ref: D08

FULL HEADPHONES - Ref: D09

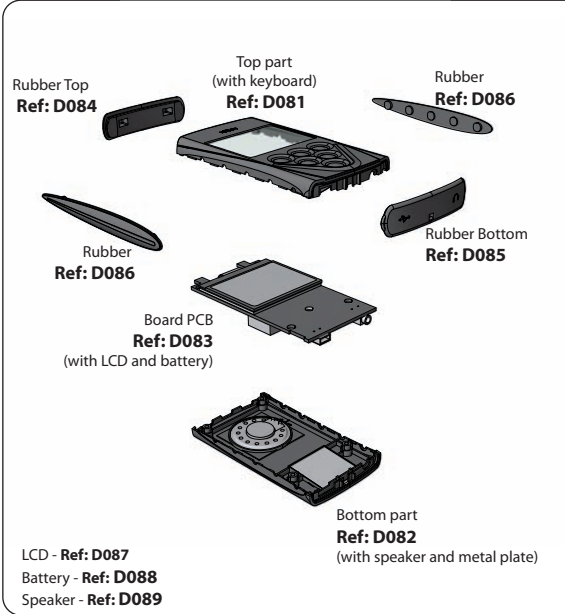

TO DETECTORISTS / THE LAW

Detecting is an activity which, like other leisure activities, requires a few general guidelines. These recommendations will enable everyone to enjoy their hobby to the full while respecting laws, places, the environment and other people.

- Ensure you are informed of current legislation relating to discovery of treasure in order to abide by the law.
- Declare any fortuitous archaeological discoveries to the local authorities (town hall) of the discovery site within 48 hours.
- Before prospecting on a site, obtain permission from its owner(s) or guardian(s).
- Respect the natural environment in which you are prospecting and any other places to which you need access.
- Systematically back-fill any holes you make so as to leave a site exactly how you found it.
- Keep any rubbish you find in order to dispose of it in a dustbin.

Avoid detecting in areas where battles are known to have taken place during wartime.

Exercise extreme caution with any suspect object resembling munitions, grenades, mines, shells, bombs, etc. and notify the relevant authorities (police, local authorities, etc.) of any such object you find.

Remember that you are an ambassador for metal detecting and it is important that you convey a positive image!

General use

Mineralised grounds
Smalls targets

			Programme 1	Programme 2
MENU	MENU EXPERT	SETTINGS	BASIC 1	GMPOWER
DISC.	DISC (threshold 1 TONE / 2 TONES)	0 to 99	10	6,8
	2 TONES	YES/NO	NO	NO
	3 TONES	YES/NO	YES	YES
	4 TONES	YES/NO	NO	NO
	PITCH	YES/NO	NO	76
	TRESHOLD 2T/3 TONES	0 to 99	76	95
	TRESHOLD 3T/4 TONES	0 to 99	95	202
	FREQUENCY "TONE 1"	200 to 791	202	518
	FREQUENCY "TONE 2"	200 to 791	518	644
	FREQUENCY "TONE 3"	200 to 791	644	757
	FREQUENCY "TONE 4"	200 to 791	757	90
SENSITIVITY		0 to 99	90	2
	TX POWER	1 to 3	2	18K
FREQUENCY		4K/8K/12K/18K	12K	0
	FREQUENCY SHIFT	-1 to 1	0	3
IRON LEVEL		0 to 5	0	2
REACTIVITY		0 to 5	2	2
	SILENCER	-1 to 4	2	4
AUDIO.R		0 to 5	4	00-00
NOTCH 1		00-00 to 99-99	00-00	00-00
	NOTCH 2	00-00 to 99-99	00-00	00-00
	NOTCH 3	00-00 to 99-99	00-00	90
GROUND	MANUAL	0-30 (Beach) 60-95(normal)	90	NO
	BEACH	YES/NO	NO	NO
	TRACKING (Except Beach mode)	YES/NO	NO	60s
BACKLIGHT *		OFF-3s-10s-60s-120s-ON	60 S	7
CONTRAST *		0 to 9	7	

* Settings common to all programs

Mineralised
and iron infested
grounds
Smalls targets
Faster than
GMPOWER

General use
Audio signal
varies both in
amplitude and height

For large
masses
and highly
conductive coins

Large, deep
masses
in relatively
uncontaminated
ground.

More effectively
for wet beach
area

All targets
Motion
all métal mode

Standard use
Greater stability
Beginner

Programme 3	Programme 4	Programme 5	Programme 6	Programme 7	Programme 8	Programme 9
DEUS FAST	PITCH	G-MAXX	RELIC	WET BEACH	ALL METAL	BASIC 2
6,8	6,8	8	8	10	0	10
NO	NO	NO	NO	NO	NO	NO
YES	NO	YES	YES	YES	YES	YES
NO	NO	NO	NO	NO	NO	NO
NO	YES	NO	NO	NO	NO	NO
76	76	76	76	76	76	76
95	95	95	95	95	95	95
202	202	202	202	202	202	202
518	518	518	518	518	518	518
644	644	644	644	644	644	644
757	757	757	757	757	757	757
90	90	90	90	85	90	80
2	2	2	3	1	2	2
18K	12K	8K	8K	18K	8K	8K
0	0	0	0	0	0	0
3	0	0	3	0	5	0
3	2	1	0	3	1	1
2	2	3	3	3	3	3
4	4	4	4	1	4	3
00-00	00-00	00-00	00-00	00-00	00-00	00-00
00-00	00-00	00-00	00-00	00-00	00-00	00-00
00-00	00-00	00-00	00-00	00-00	00-00	00-00
90	90	90	90	27	90	90
NO	NO	NO	NO	YES	NO	NO
NO	NO	NO	NO		NO	NO
60s	60s	60s	60s	60s	60s	60s
7	7	7	7	7	7	7

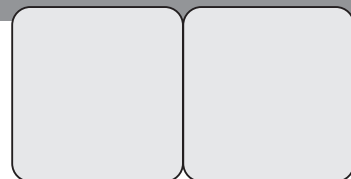

			Programme 1	Programme 2
MENU	MENU EXPERT	SETTINGS		
DISC.	DISC (Threshold 1 TONE / 2 TONES)	0 to 99		
	2 TONES	YES/NO		
	3 TONES	YES/NO		
	4 TONES	YES/NO		
	PITCH	YES/NO		
	TRESHOLD 2T/3 TONES	0 to 99		
	TRESHOLD 3T/4 TONES	0 to 99		
	FREQUENCY "TONE 1"	200 to 791		
	FREQUENCY "TONE 2"	200 to 791		
	FREQUENCY "TONE 3"	200 to 791		
FREQUENCY "TONE 4"	200 to 791			
SENSITIVITY		0 to 99		
	TX POWER	1 to 3		
FREQUENCY		4K/8K/12K/18K		
	FREQUENCY SHIFT	-1 to 1		
IRON LEVEL		0 to 5		
REACTIVITY		0 to 5		
	SILENCER	-1 to 4		
AUDIO.R		0 to 5		
NOTCH 1		00-00 to 99-99		
	NOTCH 2	00-00 to 99-99		
	NOTCH 3	00-00 to 99-99		
GROUND	MANUAL	0-30 (Beach) 60-95(normal)		
	BEACH	YES/NO		
	TRACKING (EXCEPT BEACH MODE)	YES/NO		
BACKLIGHT *		OFF - 3s - 10s - 60s - 120s - ON		
CONTRAST *		0 to 9		

* Settings common to all programs

MENU STRUCTURE

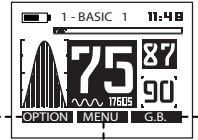

OPTION

MENU

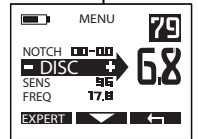
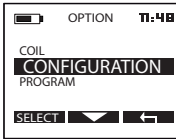
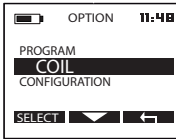
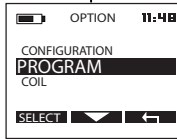

1 - BASIC 1	4 - PITCH	7 - WET BEACH
2 - GMPower	5 - G-MAXX	8 - ALL METAL
3 - DEUS FAST	6 - RELIC	9 - BASIC 2

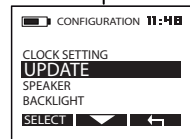
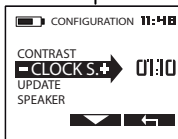
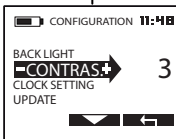
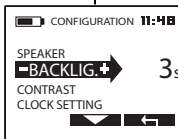
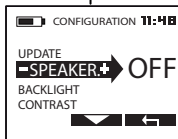
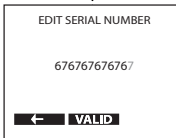
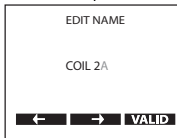
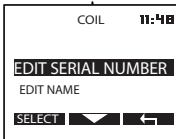
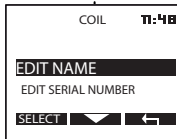
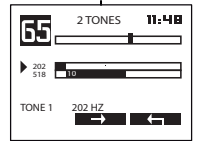
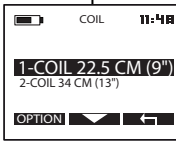
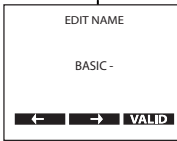
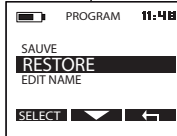
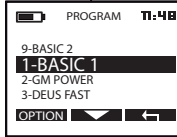

G.B.

<p>MENU 79</p> <p>DISC. 10</p> <p>SENS. → 90</p> <p>FREQ. 55.3</p> <p>IRON VOL. 00</p> <p>EXPERT</p>	<p>MENU 79</p> <p>SENS. 10</p> <p>FREQ. → 178</p> <p>IRON VOL. 00 KHZ</p> <p>REACTIVITY. 02</p> <p>EXPERT</p>	<p>MENU 79</p> <p>FREQ. 10</p> <p>IRON VOL. → 5</p> <p>REACTIVITY 00</p> <p>AUDIO RESP. 02</p> <p>EXPERT</p>	<p>MENU 79</p> <p>IRON VOL. 05</p> <p>REACTIVITY → 2</p> <p>AUDIO RESP. 04</p> <p>NOTCH. 00-00</p> <p>EXPERT</p>	<p>MENU 79</p> <p>REACTIVITY. 05</p> <p>AUDIO R. → 4</p> <p>NOTCH. 00-00</p> <p>DISC. 0</p> <p>EXPERT</p>	<p>MENU 79</p> <p>AUDIO RESP. 04</p> <p>NOTCH → 28-34</p> <p>DISC. 10</p> <p>SENS. 90</p> <p>EXPERT</p>
--	---	--	--	---	---

<p>TX POWER 11:48</p> <p>2</p> <p>01 03</p>	<p>FREQ. SHIFT 11:48</p> <p>17730 HZ</p> <p>-01 01</p>	<p>SILENCER 11:48</p> <p>2</p> <p>-01 04</p>	<p>NOTCH 11:48</p> <p>65</p> <p>N1</p> <p>THRESH 1 28 THRESH 2 46</p>
---	--	--	---

<p>MULTI TONES 11:48</p> <p>2 TONES</p> <p>3 TONES</p> <p>4 TONES</p> <p>PITCH</p> <p>EXPERT</p>	<p>MULTI TONES 11:48</p> <p>3 TONES</p> <p>4 TONES</p> <p>PITCH</p> <p>2 TONES</p> <p>EXPERT</p>	<p>MULTI TONES 11:48</p> <p>4 TONES</p> <p>PITCH</p> <p>2 TONES</p> <p>3 TONES</p>
--	--	--

<p>3 TONES 11:48</p> <p>65</p> <p>202 518 644</p> <p>10 80</p> <p>202 HZ</p> <p>TONE 1</p>	<p>4 TONES 11:48</p> <p>65</p> <p>202 518 644 757</p> <p>10 80 97</p> <p>202 HZ</p> <p>TONE 1</p>
--	---

<p>G.B. 86</p> <p>BEACH</p> <p>TRACKING</p> <p>MANUAL</p> <p>PUMPING</p>	<p>G.B. 79</p> <p>TRACKING</p> <p>MANUAL → 90</p> <p>PUMPING</p> <p>BEACH</p>	<p>G.B. 86</p> <p>MANUAL</p> <p>PUMPING</p> <p>BEACH</p> <p>TRACKING</p> <p>START</p>	<p>G.B. 25</p> <p>PUMPING</p> <p>BEACH → NO</p> <p>TRACKING</p> <p>MANUAL</p>
--	---	---	---

G.B. 25

MANUAL

PUMPING

BEACH

LANCER

G.B. 79

MANUAL

G.B. FAIL

TRACKING

IN PROGRESS

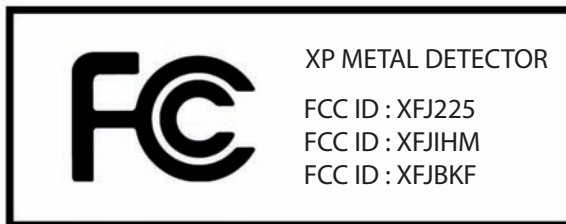

This device complies with part 15 and part 18 of the FCC Rules. Operation is subject to the following two conditions: (1) this device may not cause harmful interference, and (2) this device must accept any interference received, including interference that may cause undesired operation.

NOTE: This equipment has been tested and found to comply with the limits for a Class B digital device, pursuant to Part 15 of the FCC Rules. These limits are designed to provide reasonable protection against harmful interference in a residential installation. This equipment generates, uses and can radiate radio frequency energy and, if not installed and used in accordance with the instructions, may cause harmful interference to radio communications. However, there is no guarantee that interference will not occur in a particular installation.

If this equipment does cause harmful interference to radio or television reception, which can be determined by turning the equipment off and on, the user is encouraged to try to correct the interference by one or more of the following measures:

- Reorient or relocate the receiving antenna.
- Increase the separation between the equipment and receiver.
- Consult the dealer or an experienced radio/TV technician for help.

Changes or modifications not expressly approved by the party responsible for compliance could void the user's authority to operate the equipment.

Cet appareil ISM est conforme à la norme NMB-001 du Canada.

This ISM device complies with Canadian ICES-001.

IC:8392A-XP225

IC:8392A-XPIHM

IC:8392A-XPBKF

Responsible party: XPLORE SARL 31320 Castanet Tolosan

Safety relating to electromagnetic radio waves

This product complies with standards for user safety with regard to electromagnetic waves. The strength of the radio signals used is considerably weaker and on a much smaller scale than those emitted by mobile telephones (2,000 to 4,000 times weaker), as well as being much less than those used by Wi-Fi systems.

Moreover, when the complete system is used, the audio headphones only act as a passive radio receiver, and do not emit any signals.



If this symbol is displayed on the product or its packaging, it means that the product must not be disposed of with your household waste. You must take it to a designated collection point for recycling electrical and electronic waste. This selective waste sorting and recycling helps to preserve natural resources and avoid any potential risks for human health and the environment that could result from inappropriate scrapping, due to the possible presence of dangerous substances in the electric and electronic equipment. For more information on places where you can take your electrical waste, please contact the shop where you purchased this product.

Alternatively you can return it to your supplier, or directly to **XP**.

The same is true for the lithium batteries which must be recycled appropriately, or returned to your supplier or directly to **XP**.

WARNING

The accessories delivered with these detectors may vary, and similarly the menus and certain features described in this manual may differ slightly from the product purchased.

This detector is not suitable for applications involving the search for dangerous targets such as munitions, mines, etc.

© 2009 Xplorer sarl

This document contains information that is protected by existing legislation on copyright, brands and royalties.

Any reproduction, even partial, of this document, the logos or the XP and Dēus brands is prohibited without the agreement of:

**XPLORER SARL - 8 rue du Développement – F-31320 CASTANET-TOLOSAN
FRANCE**

In addition to the statutory guarantee ensuing from Articles 1641 et seq. of the French Civil code, due in any case for flaws and latent defects, Xplorer provides a contractual warranty which takes effect from the purchase date:

■ **Of 24 months on the entire product, including the lithium batteries and charger.**

In the event of a malfunction, the complete device must be returned to your reseller, accompanied by the purchase invoice and a note explaining the fault detected, with postage being payable by you. If a faulty device has been replaced by a new or reconditioned one, the guarantee will continue to apply as if the device was the one originally purchased.

This guarantee for parts and labour does not cover:

- Breaks caused by falls or impacts
- Accidental damage
- Damage caused by abnormal use
- Degradation resulting from non-compliance with the conditions of use stipulated in the device's instructions.
- Alteration of the electronic circuit by any unauthorised person.
- The guarantee does not cover the normal reduction in battery life due to batterie ageing.

Contacts

Website : www.xpmetaldetectors.com

e-mail : info@xpmetaldetectors.com

XPLORER sarl
8 rue du développement
F-31320 CASTANET TOLOSAN
France
Tel : 33 (0)5.61.73.63.29
Fax : 33 (0)5.61.73.48.39

XP and DĒus are trademarks of Xplorer sarl.

Xplorer reserves the right to modify its detectors' characteristics or specifications without notice.

After charging your device. (pg 33)



1 Switch on the remote control
Coil far from metal surfaces



2 Validate or not the use of the loudspeaker

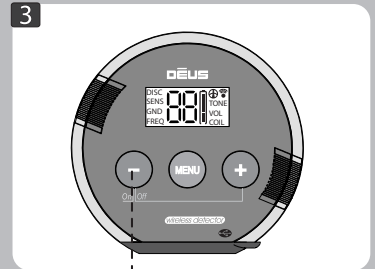

3 Switch on the headphones

You're now ready for detecting!

By default you begin by using the 1 - BASIC 1 factory programme which is suitable for general use.

If you wish to test one of the 9 other factory programmes,

simply scroll through them with



To switch off Dēus

1 Hold down Power for two seconds



on the remote control

2 Press left and right buttons



on the headphone.

If you wish to change the main detection settings:

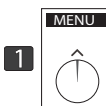

1 Press Menu

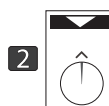

2 Press arrow to scroll through the functions



3 Set with - / +



4 Press return arrow to return to the main menu

Note Do not switch on Dēus when the coil is near a metal surface, inside a car, or when the stem has been folded away, as this may interfere with calibration and lead to abnormal performance. If this should occur, switch Dēus off and move away from any metal masses before switching it on again. Nevertheless, this does not represent any risk to the equipment or its electronics!