

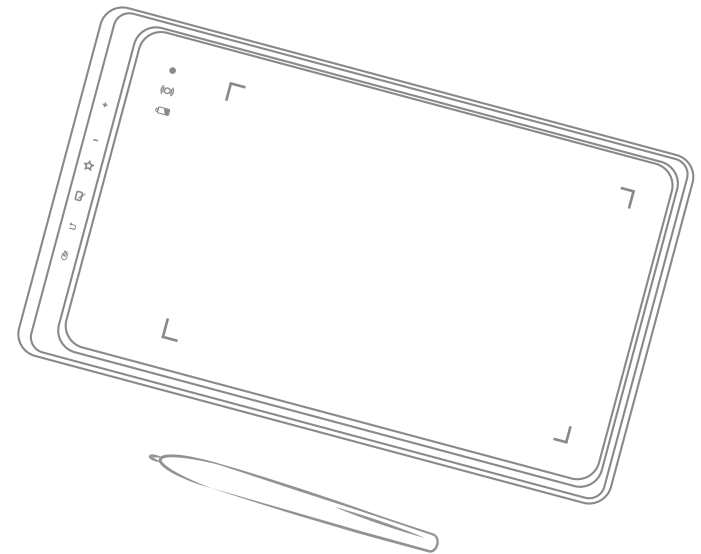

Graphic Pen Tablet Star05 Manual

Windows 10,8,7 and Vista Mac 10.7 or above



Web site: www.xp-pen.com
Mail: service@xp-pen.com

Please contact us with any questions



Designed by XPPEN Technology CO. in California, Assembled in China

M/N: STAR05

www.xp-pen.com

FCC Notice:

NOTE: This equipment has been tested and found to comply with the limits for a Class B digital device, pursuant to Part 15 of the FCC Rules. These limits are designed to provide reasonable protection against harmful interference in a residential installation. This equipment generates uses and can radiate radio frequency energy and, if not installed and used in accordance with the instructions, may cause harmful interference to radio communications. However, there is no guarantee that interference will not occur in a particular installation. If this equipment does cause harmful interference to radio or television reception, which can be determined by turning the equipment off and on, the user is encouraged to try to correct the interference by one or more of the following measures:

- Reorient or relocate the receiving antenna.
- Increase the separation between the equipment and receiver.
- Connect the equipment into an outlet on a circuit different from that to which the receiver is connected.
- Consult the dealer or an experienced radio/TV technician for help.

WARNING: Changes or modifications not expressly approved by the party responsible for compliance could void the user's authority to operate the equipment.

The device has been evaluated to meet general RF exposure requirement. The device can be used in portable condition without restriction.

This device complies with part 15 of the FCC Rules.

Operation is subject to the following two conditions:

- (1) This device may not cause harmful interference, and
- (2) this device must accept any interference received, including interference that may cause undesired operation.

Contents

I. Product Overview	1
a. Overview	1
b. Working area	2
II. Stylus Pen	2
a. Overview	2
b. Replacing the pen tip	3
III. Driver Installation	3
a. Windows	3
b. Mac	4
IV. Connecting the Star 05	4
a. Wireless USB	4
b. Corded USB	5
c. Sleep mode	5
V. Driver Settings UI	6
a. Windows	6
b. Mac	14
VI. Driver Uninstallation	20
a. Windows	20
b. Mac	20
VII. FAQ	21
a. I can't use the stylus to control the cursor.	
b. The Star 05's response time is slow during wireless USB use.	
c. How do I know that the Star 05 driver installed successfully?	
d. How do I determine if a problem is software or hardware related?	
e. When I open the tablet driver UI, I see "Tablet 1" and "Tablet 2."	

{I.Product Overview}

a. Overview

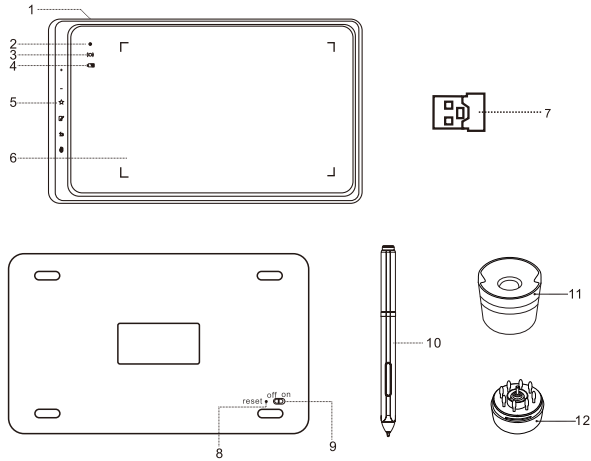

Image 1-1: Overview

- (1). USB plugin
- (2). Status indicator light
 - a) Blinking light: Stylus is in range of, but not touching, the working area.
 - b) Solid light: Stylus is touching the working area.
 - c) No light: Stylus is out of detection range.
- (3). Wireless indicator light
 - d) On: Tablet is connected via wireless USB.
 - e) Off: Tablet is not connected via wireless USB.
- (4). Battery indicator light
 - f) On, blue: Tablet is connected and charging via corded USB.
 - g) On, red: Tablet battery is low.
 - h) On, green: Tablet is sufficiently charged.
- (5). Touch keys
- (6). Working area
- (7). USB receiver
- (8). Reset button
- (9). Power on/off button
- (10). Stylus
- (11). Pen stand
- (12). Pen tip replacements (stored inside the pen stand)

b. Working area

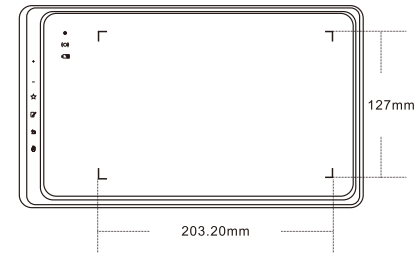

Image 1-2: Working area

{II.Stylus pen}

a. Overview

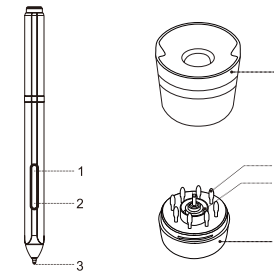

Image 2-1: Stylus and accessories

- (1). Barrel button 2
- (2). Barrel button 1
- (3). Pen tip
- (4). Pen stand top
- (5). Replacement pen tips
- (6). Pen clip
- (7). Pen stand bottom

NOTES:

Barrel button functions can be customized.
Stylus does not use a battery.

b. Replacing the pen tip

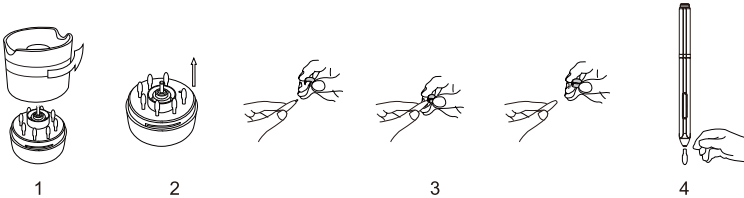

Image 2-2: Replacing the pen tip

- (1). Hold the upper half of the pen stand and twist counterclockwise to remove it.
- (2). Remove the pen clip located in the center of the lower pen stand.
- (3). Use the pen clip to grip the pen tip and pull it out of the stylus.
- (4). Push the new pen tip into the stylus.

{III. Driver Installation}

NOTES:

- (1) **Disable any antivirus or firewall software before beginning the installation.**
- (2) **Uninstall any existing tablet software before attempting to install the Star 05 driver. Other tablet drivers will conflict with the Star 05 driver or prevent installation entirely.**
- (3) **You may install the Star 05 driver with the included CD or download the latest driver version from the XP-Pen website (www.xp-pen.com). If you choose to download the driver from the website, be sure to extract the .zip file contents before running "install.exe."**

a. Windows

- (1). Connect the Star 05 to your computer using the included USB cord.
- (2). Insert the included driver CD into your computer's CD/DVD drive and follow the on-screen instructions. If setup does not begin automatically, open the disc contents manually and run "setup.exe" or "install.exe."
- (3). After a successful installation, the driver's icon () will appear on your taskbar. If the icon is not present, uninstall the driver, reboot, and repeat step 2.

b. Mac

- (1). Connect the Star 05 to your computer using the included USB cord.
- (2). Insert the included driver CD into your computer's CD/DVD drive.
- (3). Open the CD's file list. Open the "Mac Driver" folder, then run "PenTablet.pkg."
- (4). Follow the on-screen instructions, then reboot your computer.

{IV. Connecting the Star 05}

a. Wireless USB

- (1). Insert the included USB wireless receiver into your computer's USB port.
- (2). Use a toothpick, needle, or other small object to press the reset button on the back of the Star 05. (Image 4-1)
- (3). While continuing to press the reset button, slide the on/off switch to the right to turn on the tablet. (Image 4-1)
- (4). If successful, the Star 05's green wireless indicator light will light up and remain on. If the wireless indicator light does not light up, repeat steps 2 and 3.

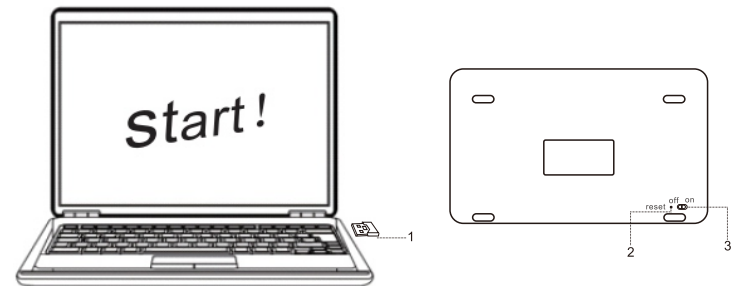

Image4-1: Wireless USB

b. Corded USB

- (1). Connect the Star 05 to your computer with the included USB cable.
- (2). Switch the tablet on.



Image4-2: Wired USB

c. Sleep mode

When connected wirelessly, the Star 05 will automatically enter sleep mode after being idle for 30 minutes. The tablet can be woken up two ways:

- (1). Hold the "Hand" touch key for 3 to 5 seconds.



Image4-3: Sleep mode

- (2). Turn the tablet off and back on with the power switch on the back.

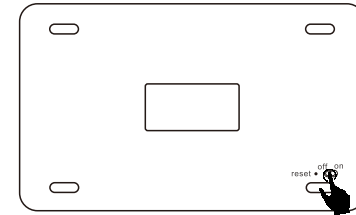



Image4-4: Sleep mode

{V.Driver Settings UI}

a.Windows

The Star 05's driver settings can be opened two ways:

- (1). Double-click the taskbar icon ().
- (2). Open the Control Panel, then double-click "Tablet Settings."

1.Info

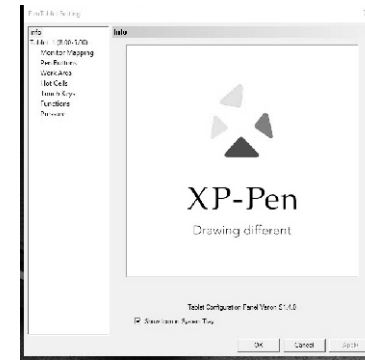

Image5-1: Info

The "info" tab displays the current downloaded driver version. The driver's system tray (taskbar) icon can also be toggled on and off here.

2. Tablet



Image5-2: Tablet

- (1). The "Tablet" tab displays basic information about the Star 05.
- (2). Tablet PC support can be toggled on and off here. Enabling this will allow support for Windows Ink.
- (3). The "Rotation" function allows you to use your tablet at different orientations. 90 ° and 270 ° rotation allow use at portrait orientations. 180 ° rotation allows comfortable left-handed use.

3. Monitor Mapping

The Monitor Mapping tab allows you to configure your tablet for use with single or dual monitors.

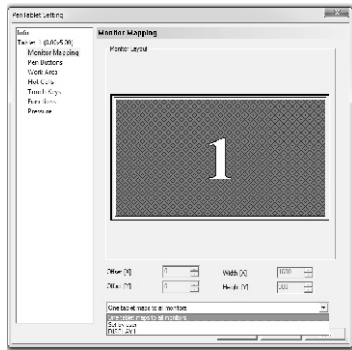

Image5-3: Example of a single-monitor setup

The Star 05 driver will automatically detect dual monitors. Your tablet can be used horizontally across both monitors.

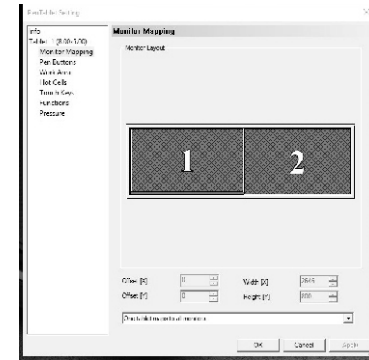

Image5-4: Example of a dual-monitor setup

If only one monitor is selected, your tablet input will be limited to only that monitor.

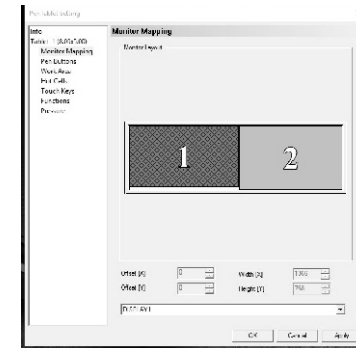

Image5-5: The tablet driver set up for use on one monitor.

4. Pen Buttons

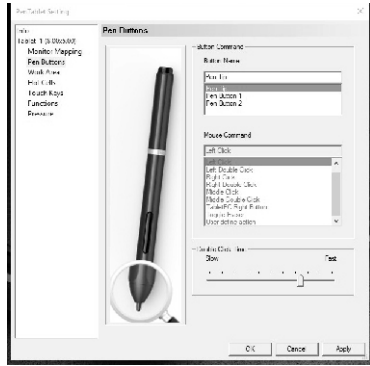

Image5-6: The Pen Button tab

In the Pen Button tab, you may customize the functions of the pen's barrel buttons by selecting the button name from the top menu and assigning your desired command under "Mouse Command."

NOTE:

(1).Tapping your tablet with the stylus pen functions as a left click.

You may also adjust the quickness required between pen taps to register as a double-click.

(2).Pen/Eraser toggle

With the stylus in range of the tablet's working area, clicking the first barrel button will, by default, toggle between pen and eraser modes. The current selected mode will briefly appear in the bottom middle of your display.

User defined actions:

(1).Run

The stylus pen's barrel buttons can be programmed to open a specified program or document.

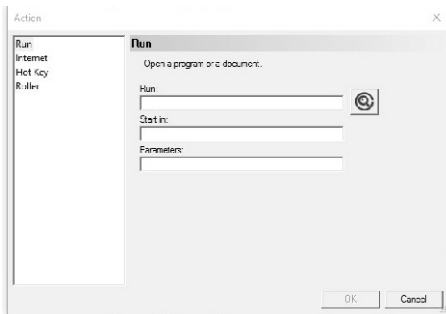

Image5-7: Run

(2).Internet

The stylus pen's barrel buttons can be programmed to open a specified web address.

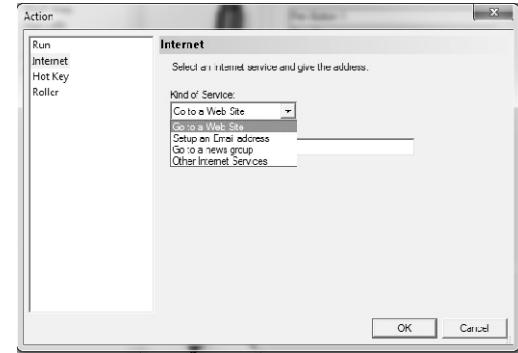

Image5-8: Internet

(3).Hot Key

The stylus pen's barrel buttons can be programmed to execute a specified keystroke.

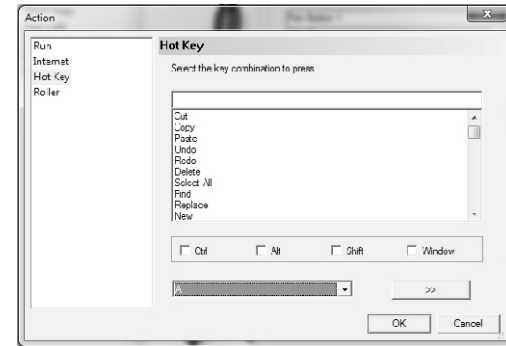

Image5-9: Hot Key

(4).Roller

The stylus pen's barrel buttons can be set to "Select Next Function", "Select Previous Function" or "Popup A Menu To Select".

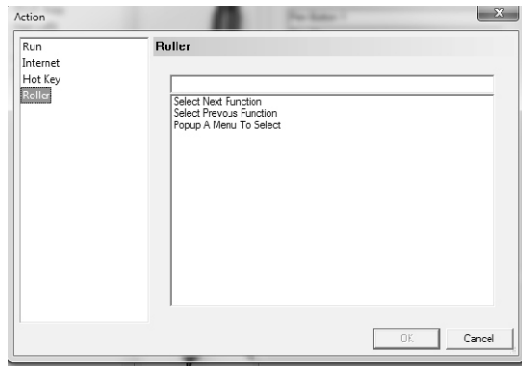

Image5-10: Ruler

5. Work Area

In the Work Area tab, you may adjust the tablet's on-screen working area to your preferred size and location.

Width (X) & Height (Y):

Indicates the current height and width of the tablet's on-screen working area. You may type exact dimensions here.

Offset (X) & Offset (Y):

Indicates the distance between the on-screen work area and the edges of the display. You may type exact dimensions here.

Full area:

Selects the largest possible on-screen working area.

Screen ratio:

Adjusts the tablet's on-screen working area to match your monitor's resolution.

Reserve edges:

Allocates buffer space along the outside borders of your on-screen working area.

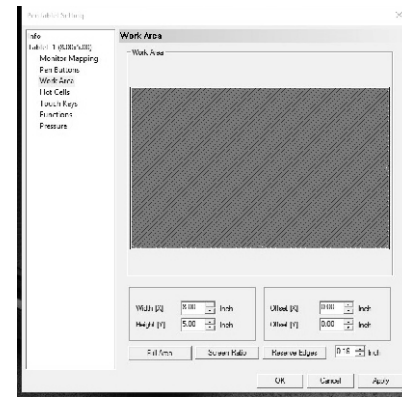

Image5-11: Work Area

6. Touch Keys

In this tab, you may edit the functions of the Star 05's touch keys.



Image5-12: Touch Keys

- + Add function
- × Delete
- ↑ Move up
- ↓ Move down
- ⚙ Edit
- ↺ Restore

To edit a function, select the touch key you would like to customize and click . Here, you may choose your desired function.

NOTE:
DO NOT alter the Handy Key's settings—this will disable the functions of the “+” and “-” buttons.

7.Functions



Image5-13: Functions

Here, you may edit the list of functions that the Handy Key will cycle through. Move a function to the left to enable it, or to the right to disable it.

Use and to adjust the order of your selected functions.

Clicking will reverse a function—for example, “zoom out/zoom in” will become “zoom in/zoom out.”

Clicking will restore a function to its default settings.

When cycling through functions with the Handy Key, the currently selected function will be briefly displayed in the bottom center of your screen.

8.Pressure

Use this tab to test your tablet's pen pressure and adjust its sensitivity. Lighter sensitivity means that digital pressure level will rise with less applied physical pressure.

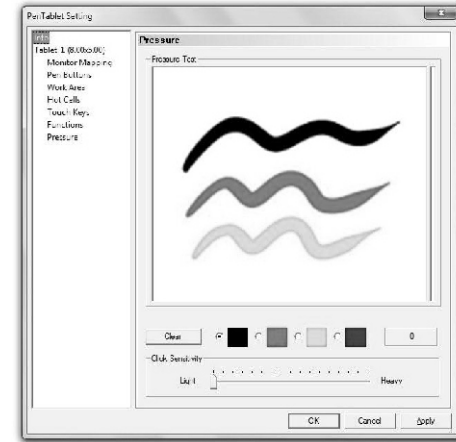

Image5-14: The pressure tab

While drawing in the test area, the numerical value of your current pressure level will be shown above the “clear” button. Heavier pressure creates a thicker line.

b.Mac

To open the Star 05's driver settings, open Finder > Applications > PenTabletSetting.



Image 5-15: Tablet Setting

1.Info

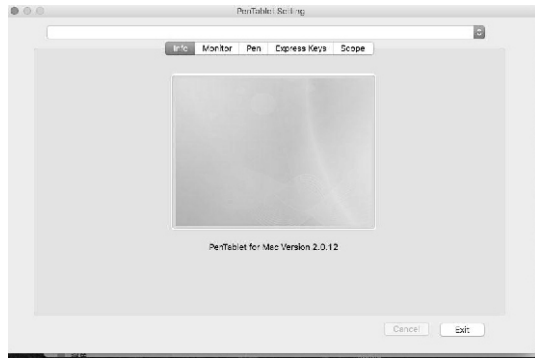

Image5-16: Info

This tab displays the current version of your driver software.

2. Monitor

In the Monitor tab, you may select "Full Monitor", "Portion of Monitor" or "Display".

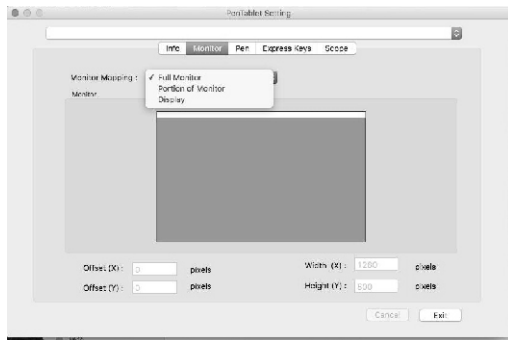

Image 5-17: Monitor

3. Pen

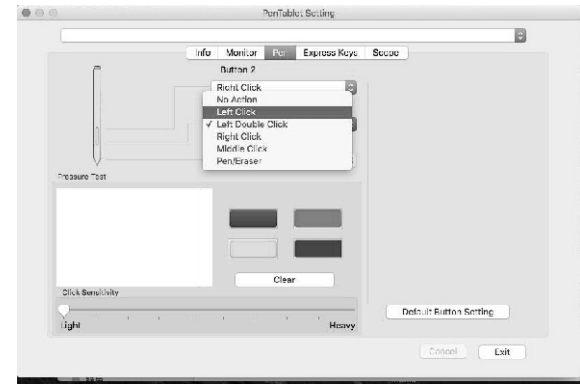

Image 5-18: Pen

In the Pen tab, you may choose your preferred functions for the stylus pen's barrel buttons from a list. You may also test the Star 05's pen pressure and adjust its sensitivity. Higher pressure creates a thicker line. Lighter sensitivity means that digital pressure level will rise with less applied physical pressure.

Click "Default Button Setting" to revert to manufacturer settings.

NOTE:

Pen/Eraser toggle

With the stylus in range of the tablet's working area, clicking the first barrel button will, by default, toggle between pen and eraser modes.

4. Express Keys

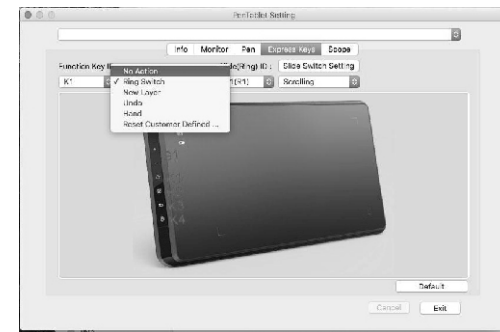

Image 5-19: Express Keys

In the Express Keys tab, you may choose your preferred functions for the Star 05's touch keys from a list.

NOTE:

Do not edit the K1 key—doing so will disable the “+” and “-“ keys.

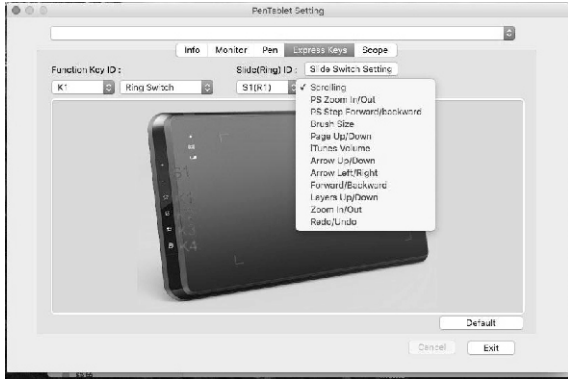

Image5-20: Express Keys-1

(1).Click “Slide Switch Setting” to add or remove functions from the K1 key’s queue.

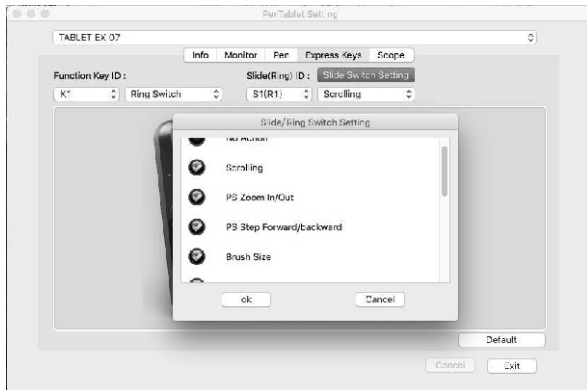

Image5-21: Slide/Ring Switch Setting

(2).Scroll down to “Reset Customer Defined list” for advanced settings.

User defined actions:

(3).Application

The Star 05's touch keys can be programmed to open specified programs or documents.

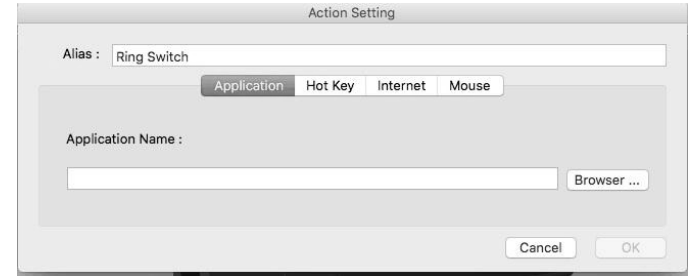

Image5-22: Application

(4).Hot Key

The Star 05's touch keys can be programmed to execute common keystrokes from a preset list.

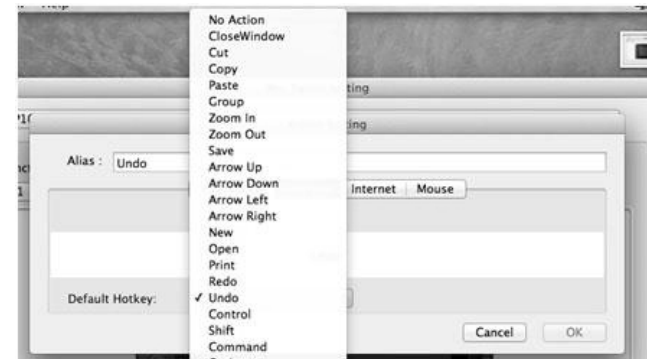

Image5-23: Hot Key

(5).Internet

The Star 05's touch keys can be programmed to open specified web addresses.

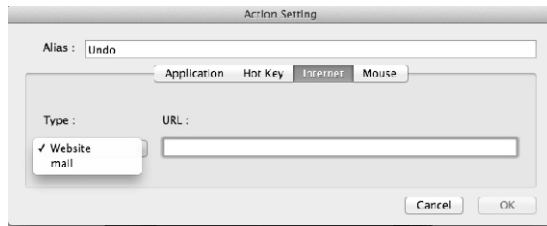

Image5-24: Internet

(6).Mouse

The Star 05's touch keys can be programmed to function as standard mouse buttons.

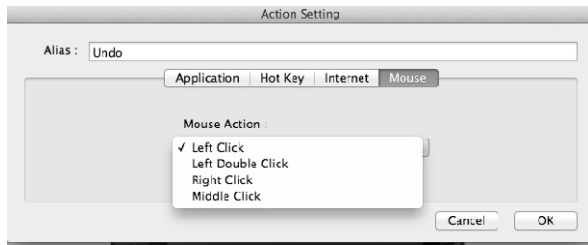

Image5-24: Mouse

5.Scope

In the Scope tab, you may adjust the tablet's on-screen working area to your preferred size and location. Under "Pen Area" is a visual representation of the current on-screen working area.

Pen Area Dimensions:

Indicates the current height and width of the tablet's on-screen working area. You may type exact dimensions here.

Pen Area Offset:

Indicates the distance between the on-screen work area and the edges of the display. You may type exact dimensions here.

Full area:

Selects the largest possible on-screen working area.

Screen ratio:

Adjusts the tablet's on-screen working area to match your monitor's resolution.

Reserve edges:

Allocates buffer space along the outside borders of your on-screen working area.

Working Area Orientation:

Allows the tablet to be switched between right or left-handed use.

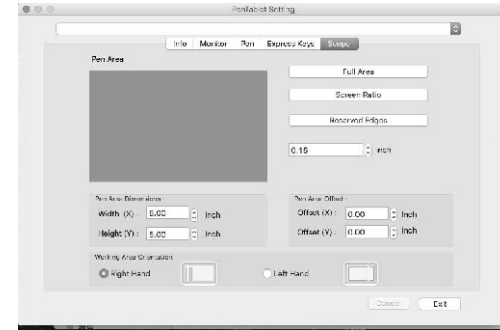

Image5-26: Scope

{VI.Driver Uninstallation}

a.Windows

1. Open [Start menu] → [All Programs/Apps] → [XP-Pen]. Click "Uninstall Driver," then follow the on-screen instructions.
OR
2. From the Start menu, open [Control Panel] → [Add/Remove Programs]. Find "Tablet Driver V8.0" and click "Uninstall." Follow the on-screen instructions.

b.Mac

Open [Finder]→ [Application]→ [Touch Tablet], then click "Uninstall Pen Tablet Driver." Follow the on-screen instructions.

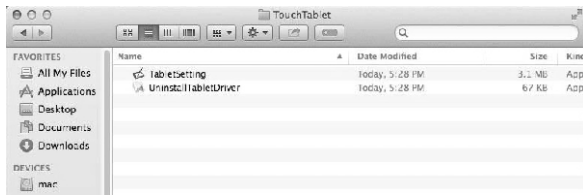

Image 6-1: Uninstall

NOTE:

When attempting to reinstall the Star 05 driver, be sure to reboot your computer after the uninstallation is complete.

{VII.FAQ}

a. I can't use the stylus to control the cursor.

1. Does the tablet's status indicator light come on when the stylus is in contact with the working area?
 - (1). Yes: Uninstall the Star 05 driver. Reboot, then connect the tablet to your computer and test your stylus. If the cursor responds to your pen input, the tablet hardware is functional. Reinstall the Star 05 driver.
 - (2). No: Make sure that the tablet's power switch is turned ON. If you are using wireless USB mode, test the tablet with a wired USB connection.

b. The Star 05's response time is slow during wireless USB use.

1. The tablet's battery may be running low. Test the tablet in wired USB mode.

c. How do I know that the Star 05 driver installed successfully?

1. After installing the driver, the Star 05's driver icon  should be visible in the taskbar/system tray (Windows OS). Pen input will control the cursor and pressure sensitivity will be functional in the driver UI's "Pressure"/"Pen" tab.

d. How do I determine if a problem is software or hardware related?

1. Connect and install the Star 05 on a different computer. If the tablet functions properly on the new computer, you are experiencing a software issue—confirm that ALL tablet drivers (including the Star 05) are uninstalled and removed from your computer, then reinstall the Star 05.
2. The Star 05's indicator lights will help you determine if an issue is hardware-related. When functioning properly, the white status indicator light will light up when the stylus pen is in range of or touching the tablet's working area. If the light does not turn on under these conditions while the Star 05 is powered ON, you may be experiencing a hardware issue.

e. When I open the tablet driver UI, I see "Tablet 1" and "Tablet 2."

1. This means that you have the Star 05 connected via wireless and wired USB. Close the driver UI, disconnect one of these, then reopen the driver UI.

