

Xerox FreeFlow® Print Server

Using LCDS Print Description Language

Xerox Corporation
Global Knowledge & Language Services
800 Phillips Road Bldg. 845-17S
Webster, NY 14580

Copyright © 2007 Xerox Corporation. All rights reserved.

Copyright protection claimed includes all forms and matters of copyrighted material and information now allowed by statutory or judicial law or hereinafter granted, including without limitation, material generated from the software programs that are displayed on the screen such as styles, templates, icons, screen displays, looks, etc.

Adobe® and the Adobe logo, InDesign®, Illustrator®, PageMaker®, Photoshop®, Acrobat®, Distiller®, and the Acrobat logo are either registered trademarks or trademarks of Adobe Systems Incorporated in the United States and/or other countries.

Macintosh, Power Macintosh, and Mac are registered trademarks of Apple Computer, Inc.

Microsoft® Windows NT® and Microsoft® Windows are trademarks of Microsoft Corporation.

PANTONE® is a registered trademark of Pantone, Inc.

Sun Microsystems and Solaris are a trademarks, registered trademarks, or service marks of Sun Microsystems, Inc. in the U.S. and other countries.

SWOP® is a registered trademark of SWOP, Inc.

Quark and QuarkXPress are trademarks of Quark, Inc. and all applicable affiliated companies, Reg. U.S. Pat. & Tm. Off. and in many other countries.

This product includes software developed by the Apache Software Foundation (<http://www.apache.org>).

This product includes software developed by the JDOM Project (<http://www.jdom.org>).

This product includes software developed by the Jaxen Project (<http://www.jaxen.org>).

iGen3® is a registered trademark of Xerox Corporation in the US and/or other countries.

Xerox®, FreeFlow®, and SmartPress™ are the trademarks of or licensed to XEROX CORPORATION.

Table of contents

Laser safety	xvii
Ozone information: U. S. only	xvii
Operation safety: U. S.	xviii
Operation safety: Europe	xix
Warning markings	xix
Electrical supply	xix
Ventilation	xx
Operator accessible areas	xx
Maintenance	xxi
Before cleaning your product	xxi
CE mark: Europe only	xxi
For further information	xxii
Introduction	xxiii
Contents	xxiii
Conventions	xxiv
1. PDL principles and procedures	1-1
Enabling PDL features and functions	1-2
PDL command structure and components	1-3
Command lines	1-3
Components of a command	1-3
Command syntax	1-12
Syntax rules	1-12
Command syntax conventions	1-14
Sample PDL commands	1-15
PDL command categories	1-16
The Job Source Library (JSL)	1-17
What does a JSL specify?	1-18
JSL command levels	1-18
JDL name	1-21
JDL or system level commands	1-21
Coding system level commands with identifiers .	1-21
Coding other system level commands	1-24
Catalog level commands	1-26
Job or JDE level commands	1-26
Coding job or JDE level commands	1-27
Comments	1-29

Ending a JSL	1-29
Sample completed JSL	1-30
Before creating a JSL: considerations and decisions	1-31
Input data	1-32
Output specifications	1-32
Special features	1-33
Interactions between JSLs, catalogs, and jobs	1-34
Paper sizes and page frames	1-34
Orientation	1-35
Fonts	1-38
Overriding PDL commands	1-40
Hints and tips	1-47
Coding a JSL	1-49
Before you start	1-50
Short JSL coding procedure	1-50
Full JSL coding procedure	1-56
Sample online JSL	1-61
Sample offline JSL	1-63
Compiling a JSL	1-65
Compiling procedure	1-65
Files produced by the compilation procedure	1-69
Correcting errors in a JSL	1-70
Dynamic job descriptor entries (DJDEs)	1-73
Benefits of using DJDEs	1-73
Dumps	1-74
Online dump	1-74
Starting and ending online dump sessions	1-74
Online dump format and content	1-74
Offline dump	1-76
Starting and ending tape dump sessions	1-76
Offline dump format and content	1-76
Compatibility with other Xerox laser printing systems that use PDL	1-77
Printing highlight color applications on FreeFlow Print Server LCDS systems	1-79
Other Xerox monochrome LPS jobs	1-81

2. Specifying input parameters 2-1

Input data streams	2-1
Input processing functions	2-2
Input processing online	2-2
Forms control buffer (FCB) and vertical format control processing	2-5
Example of an online JSL	2-6
Input processing offline	2-8
Host computer tape formats	2-8
Tape codes	2-9

Packed data formats	2-9
Record formats	2-9
Record structure	2-10
Multivolume processing	2-10
Input processing command descriptions	2-11
BLOCK command	2-12
BLOCK command parameters	2-12
BLOCK ADJUST	2-13
BLOCK CONSTANT	2-13
BLOCK FORMAT	2-14
BLOCK LENGTH	2-14
BLOCK LMULT	2-15
BLOCK LTHFLD	2-15
BLOCK OFFSET	2-16
BLOCK POSTAMBLE	2-16
BLOCK PREAMBLE	2-17
BLOCK ZERO	2-17
BLOCK command: points to note	2-18
Block command example	2-18
CODE command	2-19
CODE command parameters	2-19
CODE ASSIGN	2-20
CODE DEFAULT	2-20
CODE SPACECODE	2-22
DBCOD command	2-22
DBCOD command parameters	2-23
DBCOD ASSIGN	2-23
DBCOD DEFAULT	2-24
DBCOD command: point to note	2-24
IDEN command	2-24
IDEN command parameters	2-25
IDEN DJPCC	2-25
IDEN OFFSET	2-26
IDEN OPRINFO	2-26
IDEN PREFIX	2-27
IDEN SKIP	2-27
IDEN command example	2-28
KCODE command	2-28
KCODE command parameters	2-28
KCODE ASSIGN	2-29
KCODE DEFAULT	2-29
KCODE command: point to note	2-30
PCC command	2-30
PCC command parameters	2-30
PCC ADVTAPE	2-31
PCC ASSIGN	2-31

PCC DEFAULT	2-33
PCC INITIAL	2-34
PCC MASK	2-35
PCC command: points to note	2-35
PCC command example	2-35
RECORD command	2-36
Record command parameters	2-36
RECORD ADJUST	2-36
RECORD CONSTANT	2-37
RECORD FORMAT	2-37
RECORD LENGTH	2-38
RECORD LMULT	2-39
RECORD LTHFLD	2-39
RECORD OFFSET	2-40
RECORD POSTAMBLE	2-40
RECORD PREAMBLE	2-40
RECORD STRUCTURE	2-41
RECORD command: Points to note	2-41
RECORD command example	2-42
SEFFNT command	2-44
SEFFNT command parameters	2-45
SEFFNT SEFMAP	2-45
SEFFNT MAP	2-46
SEFFNT command: points to note	2-47
SEFFNT command examples	2-48
TCODE command	2-49
TCODE command parameters	2-50
TCODE DEFAULT	2-51
TCODE TASSIGN	2-51
TCODE TRESET	2-52
TCODE command examples	2-53
VOLUME command	2-54
VOLUME command parameters	2-54
VOLUME BMULT	2-56
VOLUME CODE	2-56
VOLUME DBCODE	2-57
VOLUME DBCS	2-58
VOLUME EMTYPE	2-58
VOLUME EOVS	2-59
VOLUME EXPAGE	2-59
VOLUME HOST	2-60
VOLUME KANJI	2-62
VOLUME KCODE	2-63
VOLUME LABEL	2-63
VOLUME LCODE	2-64
VOLUME LPACK	2-64

VOLUME MAXLAB	2-65
VOLUME MINLAB	2-65
VOLUME OPTIMIZE	2-66
VOLUME OSCHN	2-67
VOLUME OSHDP	2-67
VOLUME OSTLP	2-67
VOLUME RMULT	2-68
VOLUME TCODE	2-68
VOLUME UNPACK	2-69
VOLUME VCODE	2-70
VOLUME command examples	2-71
3. Using logical processing	3-1
Types of commands for logical processing	3-1
Test expressions	3-2
Coding a test expression	3-2
Logical processing commands that have TEST parameters	3-4
Commands that define criteria and constants	3-4
TABLE command	3-4
TABLE command parameters	3-5
TABLE CONSTANT	3-5
TABLE MASK	3-6
TABLE command: points to note	3-7
TABLE command examples	3-7
CRITERIA command	3-9
CRITERIA command modes	3-9
Using the CRITERIA command	3-10
String comparisons	3-11
CRITERIA command parameters	3-14
CRITERIA CHANGE	3-14
CRITERIA CONSTANT	3-16
CRITERIA LINENUM	3-17
CRITERIA VALUE	3-18
Logical processing command descriptions	3-22
BANNER command	3-22
BANNER command parameters	3-23
BANNER HCOUNT	3-23
BANNER HJOBNO	3-24
BANNER HRPTNA	3-24
BANNER TCOUNT	3-25
BANNER TEST	3-25
BANNER TYPE	3-26
BANNER command: points to note	3-27
BANNER command examples	3-27
BSELECT and BDELETE commands	3-28
BSELECT and BDELETE TEST parameter	3-28

BSELECT and BDELETE commands: points to note . .	3-29
Examples	3-29
Example 1	3-29
Example 2	3-30
LMODIFY command	3-31
LMODIFY command parameters	3-31
LMODIFY INK	3-31
LMODIFY SELECT	3-32
LMODIFY TEST	3-32
Points to note: LMODIFY command	3-33
RAUX command	3-33
RAUX TEST parameter	3-34
RAUX command: points to note	3-34
RAUX command example	3-34
RDELETE and RSELECT commands	3-35
RSELECT and RDELETE TEST parameter	3-35
RDELETE and RSELECT commands: point to note . . .	3-36
RDELETE command example	3-36
RFEED command	3-37
RFEED TEST parameter	3-37
RFEED command: points to note	3-38
ROFFSET command	3-39
ROFFSET command parameters	3-40
ROFFSET PASSES	3-40
ROFFSET TEST	3-41
ROFFSET command: points to note	3-41
ROFFSET command example	3-42
RPAGE command	3-43
RPAGE command parameters	3-43
RPAGE SIDE	3-43
RPAGE TEST	3-45
RPAGE WHEN	3-45
RPAGE command: points to note	3-46
RPAGE command examples	3-46
RRESUME and RSUSPEND commands	3-49
RSUSPEND and RRESUME command parameters . . .	3-49
RSUSPEND and RRESUME BEGIN	3-49
RSUSPEND and RRESUME TEST	3-50
RRESUME and RSUSPEND commands: points to note	3-50
RSUSPEND and RRESUME example	3-52
RSTACK command	3-53
RSTACK delimiter modes	3-53
Delimiter on accounting page	3-54
Status display	3-54
RSTACK command parameters	3-55
RSTACK ACCTINFO	3-55

RSTACK DELIMITER	3-56
RSTACK HRPTNA	3-56
RSTACK PRINT	3-57
RSTACK TEST	3-58
RSTACK command: points to note	3-58
RSTACK command example	3-59
4. Specifying print format parameters	4-1
Print format command descriptions	4-1
ABNORMAL command	4-2
ABNORMAL command parameters	4-2
ABNORMAL ACCTFEED	4-2
ABNORMAL CODE	4-3
ABNORMAL ERROR	4-3
ABNORMAL IMISMATCH	4-5
ABNORMAL ISUBSTITUTE	4-7
ABNORMAL OTEXT	4-7
ABNORMAL REP	4-8
ABNORMAL SECURITY	4-9
ACCT command	4-10
ACCT command parameters	4-10
ACCT DEPT	4-10
ACCT USER	4-11
ACCT command: points to note	4-11
ACCT command example	4-11
CME command	4-12
CME command parameters	4-13
CME CONSTANT	4-14
CME FONT	4-14
CME INK	4-15
CME LINE	4-16
CME POSITION	4-17
CME command: points to note	4-17
CME command examples	4-19
IDR command	4-20
IDR command parameters	4-21
IDR ICATALOG	4-21
IDR ILIST	4-22
IDR PALETTE	4-23
LINE command	4-23
LINE command parameters	4-23
LINE BASELINE	4-24
LINE BLANKTYPE	4-25
LINE DATA	4-26
LINE FCB	4-26
LINE FDATA	4-27

LINE FONTINDEX	4-28
LINE GDATA	4-29
LINE INKINDEX	4-30
LINE LPI	4-31
LINE MARGIN	4-32
LINE OVERPRINT	4-32
LINE PCC	4-34
LINE PCCTYPE	4-35
LINE VFU	4-36
LINE command: points to note	4-37
LINE command examples	4-38
MESSAGE command	4-39
MESSAGE command parameters	4-40
MESSAGE ITEXT	4-40
MESSAGE OTEXT	4-41
MESSAGE command: points to note	4-42
MESSAGE command example	4-42
OUTPUT command	4-43
OUTPUT command parameters	4-43
OUTPUT BFORM	4-45
OUTPUT BINDING	4-46
OUTPUT COLLATE	4-49
OUTPUT COPIES	4-49
OUTPUT COVER	4-50
OUTPUT CYCLEFORMS	4-50
OUTPUT DENSITY	4-52
OUTPUT DESTINATION	4-52
OUTPUT DUPLEX	4-53
OUTPUT FACEUP	4-53
OUTPUT FEED	4-54
OUTPUT FORMAT	4-55
OUTPUT FORMS	4-56
OUTPUT GRAPHICS	4-57
OUTPUT IDFAULT	4-58
OUTPUT IDR	4-59
OUTPUT IMAGE	4-60
OUTPUT INVERT	4-61
OUTPUT IRESULT	4-62
OUTPUT LOGO	4-63
OUTPUT MODIFY	4-64
OUTPUT NTO1	4-65
OUTPUT NUMBER	4-67
OUTPUT OFFSET	4-69
OUTPUT OSTK	4-70
OUTPUT PAPERSIZE	4-75
OUTPUT PURGE	4-76

OUTPUT SF1FUNCTION	4-77
OUTPUT SF2FUNCTION	4-78
OUTPUT SHIFT	4-78
OUTPUT SIZING	4-79
OUTPUT STAPLE	4-81
OUTPUT STOCKS	4-82
OUTPUT SYSPPR	4-83
OUTPUT TMODE	4-85
OUTPUT TRANS	4-89
OUTPUT UNITS	4-89
OUTPUT XSHIFT	4-90
OUTPUT command: point to note	4-91
OUTPUT command examples	4-91
PDE command	4-93
Standard PDEs	4-93
PDE command parameters	4-95
PDE BEGIN	4-95
PDE FONTS	4-98
PDE PMODE	4-99
PDE command: points to note	4-100
PDE command examples	4-100
ROUTE command	4-101
ROUTE command parameters	4-101
ROUTE RFORM	4-102
ROUTE RTEXT	4-102
ROUTE command example	4-105
STOCKSET command	4-105
STOCKSET command parameters	4-106
STOCKSET ASSIGN	4-106
STOCKSET INIFEED	4-107
STOCKSET SYSPAGE	4-107
STOCKSET command example	4-109
VFU command	4-110
VFU command parameters	4-110
VFU ASSIGN	4-110
VFU BOF	4-111
VFU TOF	4-111
VFU command: points to note	4-112
VFU command example	4-113
5. Using Dynamic Job Descriptor Entries (DJDEs)	5-1
Using the IDEN command to enable DJDEs	5-1
Specifying DJDE records	5-2
Application of DJDEs	5-3
DJDE operator information pages	5-5
Restrictions on job parameter modification	5-6

Considerations and cautions for using DJDEs	5-8
Types of DJDEs	5-10
DJDE descriptions	5-14
ALTER DJDE	5-14
ALTER DJDE: point to note	5-15
Examples of ALTER DJDE	5-15
ASSIGN DJDE	5-16
ASSIGN DJDE: points to note	5-16
BATCH DJDE	5-16
BATCH DJDE: points to note	5-17
BEGIN DJDE	5-17
BEGIN DJDE: points to note	5-18
BFORM DJDE	5-18
BFORM DJDE: points to note	5-19
BOF DJDE	5-20
BOF DJDE: points to note	5-20
C (text) DJDE	5-20
C (text) DJDE: points to note	5-21
CANCEL DJDE	5-21
COLLATE DJDE	5-22
COLLATE DJDE: point to note	5-22
COPIES DJDE	5-22
COPIES DJDE: points to note	5-23
DATA DJDE	5-23
DATA DJDE: point to note	5-23
DEPT DJDE	5-24
DEPT DJDE: points to note	5-24
DESTINATION DJDE	5-24
DESTINATION DJDE: points to note	5-25
DUPLEX DJDE	5-25
END DJDE	5-26
END DJDE: points to note	5-26
EOF DJDE	5-26
EOF DJDE: point to note	5-26
FEED DJDE	5-27
FDATA DJDE	5-27
FILE DJDE	5-28
FILE DJDE: points to note	5-29
FILE DJDE processing	5-29
FONTINDEX DJDE	5-33
FONTINDEX DJDE: points to note	5-34
FONTS DJDE	5-35
FONTS DJDE: points to note	5-36
FORMAT DJDE	5-37
FORMAT DJDE: points to note	5-37
FORM[S] DJDE	5-38

FORM[S] DJDE: point to note	5-38
GDATA DJDE	5-39
GRAPHIC DJDE	5-39
GRAPHIC DJDE: points to note	5-41
ICATALOG DJDE	5-42
ICATALOG DJDE example	5-42
IDFAULT DJDE	5-42
IDFAULT DJDE: point to note	5-43
IDR DJDE	5-43
ILIST DJDE	5-43
ILIST DJDE example	5-44
IMAGE DJDE	5-44
INKINDEX DJDE	5-45
INVERT DJDE	5-46
IRESULT DJDE	5-47
IREULT DJDE: points to note	5-47
ITEXT DJDE	5-48
ITEXT DJDE: points to note	5-48
JDE DJDE	5-48
JDE DJDE: points to note	5-49
JDL DJDE	5-49
JDL DJDE: points to note	5-50
LOGO DJDE	5-50
LOGO DJDE: points to note	5-52
LPI DJDE	5-52
LPI DJDE: point to note	5-53
MAP DJDE	5-53
MARGIN DJDE	5-53
MARGIN DJDE: points to note	5-54
MODIFY DJDE	5-54
MODIFY DJDE: points to note	5-55
NUMBER DJDE	5-55
NUMBER DJDE: point to note	5-56
NUMBER DJDE example	5-58
OTEXT DJDE	5-58
OTEXT DJDE: point to note	5-59
OVERPRINT DJDE	5-59
OVERPRINT DJDE: points to note	5-60
PALETTE DJDE	5-60
PALETTE DJDE example	5-61
PMODE DJDE	5-61
PMODE DJDE: point to note	5-61
RFORM DJDE	5-61
RFORM DJDE: points to note	5-62
RTEXT DJDE	5-62
RTEXT DJDE example	5-63

SAVE DJDE	5-64
SAVE DJDE: point to note	5-64
SEFMAP DJDE	5-64
SEFMAP DJDE: points to note	5-65
SEFMAP DJDE examples	5-65
SF1FUNCTION DJDE	5-66
SF2FUNCTION DJDE	5-67
SHIFT DJDE	5-67
SHIFT DJDE: points to note	5-68
SIDE DJDE	5-68
SIDE DJDE: points to note	5-69
STOCKS DJDE	5-70
STOCKS DJDE: point to note	5-70
TMODE DJDE	5-70
TOF DJDE	5-71
TOF DJDE: points to note	5-71
TRANS DJDE	5-72
TRANS DJDE: points to note	5-72
XMP DJDE	5-73
XSHIFT DJDE	5-74
6. Using PDL commands for graphics	6-1
Input for graphics	6-2
Error handling for graphics	6-3
Graphic processing modes	6-3
Formats for graphic data	6-4
Impact of graphics on system performance	6-6
Graphics features restrictions	6-6
A. PDL command and DJDE summary	A-1
Summary table of PDL commands and DJDEs	A-2
B. PDL command quick reference	B-1
PDL command Quick Reference table	B-2
C. Character code assignments	C-1
IBM BCD code set	C-2
Honeywell/Bull 200 and 2000 BCD code set	C-2
Honeywell/Bull 6000 BCD code set	C-3
Fielddata translation	C-3
UNIVAC ASCII character set	C-4
Standard ASCII character set	C-5
Standard EBCDIC character set	C-6
Xerox EBCDIC to extended ASCII hexadecimal translation values	C-7
D. Offline specifications	D-1

Input unpacking examples D-1
Valid host computer and label specifications D-2
Host system JDLs on system software CD D-4
LPS tape label format D-5

Glossary..... Glossary-1

Laser safety

WARNING

Adjustments, use of controls, or performance of procedures other than those specified herein may result in hazardous light exposure.

Xerox FreeFlow Print Server-based printers are certified to comply with the performance standards of the U.S. Department of Health, Education, and Welfare for Class 1 laser products. Class 1 laser products do not emit hazardous radiation. The DocuPrint printers do not emit hazardous radiation, because the laser beam is completely enclosed during all modes of customer operation.

The laser danger labels on the system are for Xerox service representatives and are on or near panels or shields that must be removed with a tool. **DO NOT REMOVE LABELED PANELS OR PANELS NEAR LABELS. ONLY XEROX SERVICE REPRESENTATIVES HAVE ACCESS TO THESE PANELS.**

DANGER

**LASER RADIATION WHEN OPEN
AVOID DIRECT EXPOSURE TO BEAM**

Ozone information: U. S. only

This product produces ozone during normal operation. The amount of ozone produced depends on print volume. Ozone is heavier than air. The environmental parameters specified in the Xerox installation instructions ensure that concentration levels are within safe limits. If you need additional information concerning ozone, call 1-800-828-6571 to request the Xerox publication 600P83222, *OZONE*.

Operation safety: U. S.

Your Xerox equipment and supplies have been designed and tested to meet strict safety requirements. They have been approved by safety agencies, and they comply with environmental standards. Please observe the following precautions to ensure your continued safety.

WARNING

Improper connection of the equipment grounding conductor may result in risk of electrical shock.

- Always connect equipment to a properly grounded electrical outlet. If in doubt, have the outlet checked by a qualified electrician.
- Never use a ground adapter plug to connect equipment to an electrical outlet that lacks a ground connection terminal.
- Always place equipment on a solid support surface with adequate strength for its weight.
- Always use materials and supplies specifically designed for your Xerox equipment. Use of unsuitable materials may result in poor performance and may create a hazardous situation.
- Never move either the printer or the print server without first contacting Xerox for approval.
- Never attempt any maintenance that is not specifically described in this documentation.
- Never remove any covers or guards that are fastened with screws. There are no operator-serviceable areas within these covers.
- Never override electrical or mechanical interlocks.
- Never use supplies or cleaning materials for other than their intended purposes. Keep all materials out of the reach of children.
- Never operate the equipment if you notice unusual noises or odors. Disconnect the power cord from the electrical outlet and call service to correct the problem.

If you need any additional safety information concerning the equipment or materials Xerox supplies, call Xerox Product Safety at the following toll-free number in the United States:

1-800-828-6571

For customers outside the United States, contact your local Xerox representative or operating company.

Operation safety: Europe

This Xerox product and supplies are manufactured, tested and certified to strict safety regulations, electromagnetic regulations and established environmental standards.

Any unauthorized alteration, which may include the addition of new functions or connection of external devices, may impact the product certification.

Please contact your Xerox representative for more information.

Warning markings

All warning instructions marked on or supplied with the product should be followed.



This WARNING alerts users to areas of the product where there is the possibility of personal damage.



This WARNING alerts users to areas of the product where there are heated surfaces, which should not be touched.

Electrical supply

This product shall be operated from the type of electrical supply indicated on the data plate label of the product. If you are not sure that your electrical supply meets the requirements, please consult your local power company for advice.

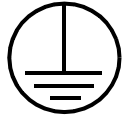

WARNING

This product must be connected to a protective earth circuit.

This product is supplied with a plug that has a protective earth pin. This plug fits only into an earthed electrical outlet. This is a safety feature. Always connect equipment to a properly grounded electrical outlet. If in doubt, have the outlet checked by a qualified electrician.

To disconnect all electrical power to the product, the disconnect device is the power cord. Remove the plug from the electrical outlet.

Ventilation

Slots and openings in the enclosure of the product are provided for ventilation. Do not block or cover the ventilation vents, as this could result in the product overheating.

This product should not be placed in a built-in installation unless proper ventilation is provided. Please contact your Xerox representative for advice.

Never push objects of any kind into the ventilation vents of the product.

Operator accessible areas

This product has been designed to restrict operator access to safe areas only. Operator access to hazardous areas is restricted with covers or guards which require a tool to remove. Never remove these covers or guards.

Maintenance

Any operator product maintenance procedures are described in the user documentation supplied with the product. Do not carry out any maintenance on the product which is not described in the customer documentation.

Before cleaning your product

Before cleaning this product, unplug the product from the electrical outlet. Always use materials specifically designated for this product; the use of other materials may result in poor performance and may create a hazardous situation. Do not use aerosol cleaners as they may be flammable under certain circumstances.

CE mark: Europe only



January 1, 1995: Council Directive 73/23/EEC, amended by Council Directive 93/68/EEC, approximation of the laws of the member states related to low voltage equipment.

January 1, 1996: Council Directive 89/336/EEC, approximation of the laws of the member states related to electromagnetic compatibility.

March 9, 1999: Council Directive 99/5/EC, on radio equipment and telecommunications terminal equipment and the mutual recognition of their conformity.

A full declaration of conformity, defining the relevant directives and referenced standards, can be obtained from your Xerox representative.

In order to allow this equipment to operate in proximity to Industrial, Scientific and Medical (ISM) equipment, the external radiation for the ISM equipment may have to be limited or special mitigation measures taken.

This is a Class A product. In a domestic environment this product may cause radio frequency interference, in which case the user may be required to take adequate measures.

Shielded interface cables must be used with this product to maintain compliance with Council Directive 89/36/EEC.

For further information

For more information on Environment, Health and Safety in relation to this Xerox product and supplies, please contact the following customer help lines:

Europe: +44 1707 353434

USA: 1-800-828-6571

Canada: 1-800-828-6571

Introduction

Using LCDS Print Description Language provides information on how to use PDL to program LCDS job descriptions that can be used on any Xerox FreeFlow Print Server-based printing system featuring LCDS. Examples of these systems include, but are not limited to: the Xerox DocuPrint 75/90 and 100/115/135/155/180 Enterprise Printing Systems, the DocuPrint 75 MX, the Xerox DocuTech 128/155/180 HighLight Color Printing System, and the Xerox Nuvera 100/120 family of printing systems.

Contents

Before using this documentation, become familiar with its contents and conventions.

The topics discussed in this guide include:

- Explanation of a Job Source Library (JSL), including required and optional commands and components
- Rules and guidelines for coding LCDS PDL commands
- Procedures for creating and compiling a JSL
- Syntax and explanation of each LCDS PDL command, parameter, and DJDE
- Explanation of Dynamic Job Descriptor Entries (DJDEs) and the process for inserting them into the data stream
- Reference list of all PDL and DJDE commands, including online and offline usage, parameters, and the Xerox printing systems that support them

A glossary and index are also provided.

Focus of this guide

This documentation describes LCDS Print Description Language as it applies to the DocuPrint 100/115/135/155/180 and 75/90 EPS, and the DocuPrint 75 MX. Except where otherwise noted, the PDL information contained in this documentation also applies to the following families of Xerox Laser Printing Systems that print LCDS data:

Xerox 180, 180MX, 96, and 96MX Laser Printing Systems

The following families of printing systems support subsets of the PDL commands that can be used.

- Xerox 4635 and 4635 MX Laser Printing Systems
- Xerox 4850 and 4890 HighLight Color Laser Printing Systems
- Xerox DocuPrint 92C HighLight Color Laser Printing System
- Xerox 4050, 4090, and 4650 Laser Printing Systems
- Xerox 9790 and 8790 Laser Printing Systems
- Xerox DocuTech 128/155/180 HighLight Color Printing Systems
- Xerox Nuvera 100/120 MX Digital Production Systems

Refer to Appendix A, “PDL command and DJDE summary,” for information on which laser printer families support the different commands.

NOTE: Forms Description Language (FDL) commands cannot be used on the FreeFlow Print Server, because these systems do not have forms compiling capability. You can, however, create forms by using FDL on another laser printing system or by using a forms creation software package on a PC or other type of workstation. Form files that are created externally can be transferred or imported to the system disk of your FreeFlow Print Server, and can be specified for jobs that are printed on the system.

Conventions

This guide uses the following conventions:

- **Alerts:** Alerts include notes, cautions, and warnings.
 - Notes are hints that help you perform a task or understand the text.
 - Cautions alert you to an action that could damage hardware, software, or your print job.
 - Warnings alert you to conditions that may cause injury to people.

Alerts appear as follows:

- Notes: *Printed in italics*
- CAUTIONS: **Printed in red**

- WARNINGS: **Printed in bold red**
- **Angle brackets:** Angle brackets surrounding a word indicate the word is the name of a key on the print server keyboard. Key names start with a capital letter. (Example: Press <Enter>.)
- **Square brackets:** Square brackets around words or phrases indicate the names of buttons to click or menu options to select on a screen., Square brackets also indicate the names of fields and text boxes on screens. (Example: In the [Folders] field, select [resources].)
- **Bold type:** Used for emphasis. It is also used for keywords that introduce items in a list.
- **Entering:** Within procedures, the two-step process of keying in text and pressing <Enter>. (Example: Enter **y** in the box.)
- **Fixed pitch font:** Used to indicate text that you enter in a text field on a window, such as examples of PDL commands. It also indicates text that the system displays on the screen, such as messages. Example:

```
LINE DATA=(1,132), FONTINDEX=133;
```
- **Italics:** Indicate variables (types of items that vary from one command to another), or the position of a specified argument in the command syntax. (Example: IDEN SKIP = *value*.)

Italics are also used for document titles and library names (Example: *Using LCDS Print Description Language*.)

1. PDL principles and procedures

The Xerox LCDS Print Description Language (PDL) is a set of commands you give to the printing system to define properties such as the appearance, output destination, and paper feed source for your LCDS print job.

You can use LCDS PDL to do all of the following in your print jobs:

- Change and mix font types on a page to page, line to line, or character to character basis. This allows you to customize printed output for specific needs; for example, emphasizing important headings by changing font styles and sizes.
- Change text orientation and positioning on a page to page basis. This allows you to print characters along the width or length of the page with equal ease. The printing system can switch instantly, at a page boundary, between portrait (tall and narrow) and landscape (wide) page formats, combining the two styles within a single report.
- Print a number of previously separate logical pages on the same physical page of a document.
- Modify documents on a page to page basis by using copy modification entries (CMEs) to replace selected portions of text with other data, change fonts, or label copies as “confidential.”
- Merge variable print data with forms stored on the system disk. This feature eliminates the need for forms overlays and most preprinted forms, as well as assuring perfect registration.
- Print two different forms back to back (duplex) on one sheet of paper, thereby reducing paper costs. Additionally, this option offers potential savings in inventory, filing, storage, and mailing costs for computer generated material.
- Feed paper either short edge first or long edge first to accommodate a variety of paper sizes.

Enabling PDL features and functions

To enable these functions, you enter PDL commands to enable the following for your print job:

- Describe the input (type, format, characteristics, and source)
- Define any logical or special processing functions to be performed on selected text, pages, or copies
- Describe the output (type, format, font selection, accounting options, and destination)

Each command has a set of parameters and parameter options used to define the above characteristics of a print job.

PDL commands may be specified in the following ways:

- In a Job Source Library (JSL)
- As Dynamic Job Descriptor Entries (DJDEs)

Job Source Libraries (JSLs)

One way to issue PDL job definition commands to your printing system is to create a text file of these commands for your job. The source (text, uncompiled) file of PDL commands is called a “job source library” (JSL) file. The JSL file is then compiled by the system to create an object file, called a “job descriptor library” (JDL).

Each compiled JDL file is stored in a resource folder named “lcmds” located on the print server disk. The system accesses the required JDL from the “lcmds” folder when the operator specifies it to start a job. When a job is sent from the host, the printing system reads the specified JDL and obtains instructions on what fonts and forms to use when printing the job as well as where to direct the printed output.

Dynamic job descriptor entries (DJDEs)

Dynamic Job Descriptor Entries (DJDEs) are parameters embedded within the input data stream. They modify the printing environment established by a job descriptor entry (JDE) within a JDL, as the job is printing. DJDEs allow page by page or record by record modifications to your applications.

Most PDL commands are also available as DJDEs. Refer to “PDL command and DJDE summary,” Appendix A, for information on which PDL commands have DJDE counterparts.

In order to use DJDEs, you must specify an IDEN command in the JSL to advise the system that DJDE records are included in the input data stream and where to look for them.

Refer to the “Specifying DJDE records” section of the “Using Dynamic Job Descriptor Entries (DJDEs)” chapter for information on how to include DJDEs in the data stream.

PDL command structure and components

In order for the system to recognize and respond correctly to your PDL commands, you must construct and enter them correctly. Some components of PDL commands must be specified every time, while others are optional. There are some rules for constructing commands. You must follow these rules in order for your system to print your job the way you want it. Refer to “Command syntax” later in this chapter for details on the JSL syntax rules.

Command lines

The JSL consists of command lines, also called *records*, on which you enter PDL commands. The length of these records can be up to 133 characters for JSLs on tape.

NOTE: If you select the [TRUNCATE] option of the xjdc compiling command, only characters 1 through 72 may be used for parameter information. Refer to “Compiling a JSL” later in this chapter.

You can continue commands on successive lines if the parameters are separated by commas. Multiple commands may appear on one record line if separated by semicolons.

Components of a command

Each PDL command consists of a command keyword and one or more parameters. Parameters are separated by commas or spaces. A PDL command has the following parts:

- Command identifier (if required)
NOTE: DJDEs do not have identifiers.
- Command keyword
- One or more command parameters
- Parameter options

- Comments (if appropriate)

These components are shown in the following figure.

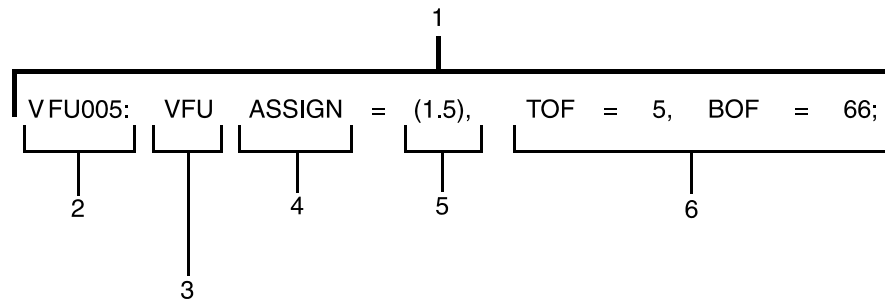

Figure 1-1. Diagram of PDL command components

1. Command statement
2. Identifier
3. Command keyword
4. Parameter keyword
5. Parameter option
6. Additional parameter keywords and options

In the example above, the identifier, parameter keyword, and parameter options are part of the VFU command, which is represented by the required command keyword **VFU**. All of these components may be collectively referred to as a “command statement.”

The following table shows examples of the typical components of a PDL command statement.

Table 1-1. Set of typical PDL commands

Command identifier	Command keyword (required)	Parameter keywords	Parameter options
VFU1:	VFU	ASSIGN= TOF= BOF=	(1,1), 1, 55;
CME4:	CME	LINE= POSITION= FONT=	(1,60), 5, 2;

Command identifier Some PDL commands require identifiers to precede their command keywords. By coding an identifier before a command, you associate the identifier with the command. This allows the command to be referenced (by its identifier) by other commands within the JSL. Some identifiers also determine the names of the files that the Xerox Job Descriptor Compiler creates.

Different syntax rules apply to identifiers, depending on the command being coded. Each command description in this document tells you if an identifier is required (or optional) for the command and if so, how it must be coded.

In most cases, in a JSL, if a command will be referenced by another command within the JSL, an identifier must precede the keyword of the referenced command. A command identifier is defined using a label of up to six alphanumeric characters, followed by a colon (:).

Two types of identifiers can be used:

1. *ac* type: Must have at least one alpha character, that is, a letter.
2. *dd* type: May have all numerals, all alpha characters, or a combination of both.

The following PDL command has the command identifier VFU1 and the command keyword is VFU.

```
VFU1: VFU    ASSIGN=(1,1), TOF=1, BOF=55;
END;
```

The identifier in this command may have any number of blanks following the VFU1 characters; however, no blanks are permitted **within** the identifier name.

*NOTE: A command that requires an identifier must always be defined **before** any other command that references it.*

Command keyword Every command must have a keyword, which is the “name” of the command for which various parameters may be selected.

In the following example, CME is the command keyword (CME4 is the identifier).

```
CME4: CME    LINE=(1,60), POSITION=5, FONT=2;
```

In the next example, the command keyword OUTPUT can be followed by any number of parameters, such as:

```
OUTPUT GRAPHICS=YES, DUPLEX=NO, FORMAT=PDFLT,
FORM=BAR;
```

Refer to Appendix A, “PDL command and DJDE summary,” for a list of all available command keywords.

Parameters Each command keyword is followed by parameters. Parameters give precise specifications for the print job or application.

- In commands that comprise a JSL, each parameter consists of a left part and a right part, separated by an equal (=) sign. (Spaces before and after the equal sign are optional.) The left part is the parameter name; the right part indicates the parameter options or values.
- In DJDEs, the left part is the DJDE command name. The DJDE options are right part components, following the equal sign.

Parameter options and right part components The right part of a parameter contains the options, which may consist of keywords, variable references, and value or string constants.

Each parameter has one or more options. For example, the OFFSET parameter of the OUTPUT command (which can be shortened to OUTPUT OFFSET parameter) has three options: ALL, FIRST, and NONE.

Some parameter options have multiple components. Some of these components must have values specified; others are optional. Parentheses are used to enclose multiple components of a right part, as shown in the following example.

In the example below, the VFU command has three parameters: ASSIGN, TOF (top of form), and BOF (bottom of form).

```
VFU1: VFU    ASSIGN=(1,1), TOF=1, BOF=55;  
END;
```

In this example, the ASSIGN parameter option has two components. Multiple components of an option must be coded in the order shown in the command description syntax diagram.

- **Keywords**

Keywords are terms that direct the system to perform specific activities. Keywords always consist of the same characters and do not vary.

Example:

```
ABNORMAL  ERROR=CONTINUE, OTEXT=(... WAIT);
ACCT      USER=BOTH;
```

- **Variable references**

In creating your JSLs, you will often include variable references, which may be either file names of resources stored on the system disk (forms, CMEs, PDEs, stocksets, and so on) or identifiers for commands coded previously in the JSL.

Example:

```
OUTPUT  FORM=FORM1, MODIFY=CME12;
```

NOTE: In some cases, such as in the MODIFY= command shown in the example above, the variable (CME12) could be either a file name or an identifier for a CME coded earlier in the JSL. In other cases, such as in the FORM= command, the variable (FORM1) can only be a file name.

- **Value constants**

Value constants have arithmetic values. Value constants should be expressed as decimal numbers. They may also be expressed as hexadecimal values, octal values, or character values, but these expressions are not recommended. Decimal numbers may be signed and may have fractional digits.

Example:

```
PDE      BEGIN=(1.1, .37);
RECORD   LENGTH=132;
OUTPUT   IMAGE=(1.30 CM, 0.85 IN);
```

To express value constants as hex, octal, or characters, you use string constants to define one or two bytes of data.

- **String constants**

String constants are used to specify a sequence of characters. The length of string constants is important.

- **Ways to express string constants**

String constants may be expressed as any of the following:

- Hexadecimal
- ASCII

- EBCDIC
- Octal
- Kanji

– **Using the # character (case toggle)**

Within a text string, the # character may be used as a case toggle. In other words, when a text string is encountered, it is assumed that characters are inserted into the print line as they appear in the text string (usually in uppercase). If the system encounters a #, it interprets the characters as lowercase mode. All letters after the # are considered lowercase until another # is encountered, which toggles back to uppercase.

The sequence ## indicates that the actual # character should be inserted and should not be treated as a toggle for lowercase mode.

– **Using a repeat count**

String constants may be preceded by an optional repeat count. A repeat count is enclosed in parentheses and must be in the range of 1 to 255. For example:

```
T1: TABLE CONSTANT=(3) '*';
```

is equivalent to:

```
T1: TABLE CONSTANT=('***');
```

Following are additional examples of the use of a repeat count:

```
T1: TABLE CONSTANT=(3)O'27';
```

```
T2: TABLE CONSTANT=(4)X'C1';
```

– **Types of string constants:**

The following table gives explanations and examples of the different types of string constants.

Table 1-2. Types of string constants

Constant	Definition	Example
Hexadecimal	Normally used as string constants, but they may also be used as value constants. Each pair of hexadecimal characters results in one byte. A hexadecimal constant must immediately be preceded by the characters X apostrophe (X'), then followed by another apostrophe, to indicate to the PDL compiler that the expression that follows is in hexadecimal.	IDEN PREFIX=X'C1C2C3C4';
ASCII	<p>Used as string constants. Each character results in one byte. The constants must be preceded by the characters A apostrophe (A') and followed by an apostrophe character.</p> <p>The ASCII string type allows hexadecimal representation of characters to be embedded in a string. This is done by preceding the hexadecimal representation of the character with an ! character. The three character sequence required for the hexadecimal representation of a character results in one byte.</p> <p>Two successive ! characters (!!) are necessary to represent one actual ! character when printing. The two character sequence (!!) results in one byte.</p>	<p>IDEN PREFIX=A'ABC!44EF' is equivalent to IDEN PREFIX=X'414243444546'</p>

Table 1-2. Types of string constants (Continued)

Constant	Definition	Example
EBCDIC	<p>EBCDIC constants are used for value and string constants. They must be preceded by the characters E apostrophe (E') and followed by an apostrophe character ('). The EBCDIC string type allows hexadecimal representation of characters to be embedded in a character string. This is done by preceding the hexadecimal representation of the character with an ! character. Each character represented in EBCDIC results in one byte. Each three character sequence representing a character hexadecimally results in one byte.</p> <p><i>NOTE: If no character type is specified, EBCDIC is the default.</i></p>	<pre>IDEN PREFIX='DJDE'; TABLE CONSTANT='ABCDE'; IDEN PREFIX=E'ABC!C4EFG' is equivalent to the hexadecimal IDEN PREFIX=X'C1C2C3C4C5C6C7'</pre>
Octal	<p>Octal constants should be used only as string constants because of the control program conversion process. Each octal character results in three bits. Each octal character pair is converted internally to an 8 bit octal character by prefixing two binary zeros. Thus, the arithmetic value of a multiple character octal constant may be difficult to determine, because each digit in the constant has been altered. An octal constant must be preceded immediately by the characters letter O apostrophe (O') and immediately followed by the apostrophe (') character.</p>	<pre>RECORD CONSTANT=O'07070707'</pre>

Table 1-2. Types of string constants (Continued)

Constant	Definition	Example
H2 and H6	<p>H2 and H6 constants generate H2000 BCD and H6000 BCD codes, respectively. Use of H2 and H6 is identical to use of E and A prefixes described in the previous sections of this table.</p> <p>Since H2000 and H6000 BCD are defined as 6-bit codes, no specification greater than X'3F' generates a legal character. If anything from X'40' to X'FF' is coded, an error message appears and the bad character is replaced with a blank.</p> <p>String constants may be replaced by an optional repeat count. A repeat count must be enclosed in parentheses and must be in the range of 1 to 255.</p>	<pre>BLOCK CONSTANT = H2' 373737' ; BLOCK CONSTANT = H6' 373737' ;</pre> <p>Repeat count examples:</p> <pre>T1: TABLE CONSTANT = (3)'*' ; is equivalent to: T1: TABLE CONSTANT = ('###') ;</pre> <pre>T1: TABLE CONSTANT=(3)O'27' ; T2: TABLE CONSTANT=(4)X'C1' ;</pre>

Command syntax

For the system to read and process any command you put in your JSL, you must place all elements in the proper order and use the correct symbol or amount of space to separate them.

Syntax rules

When you enter your PDL commands at the print server, workstation, or host keyboard, you must follow these syntax rules in order for the system to recognize the commands.

- **Abbreviations:** Command and parameter keywords can be shortened to the first three letters; for example, POSITION may be entered as POS, OUTPUT as OUT, etc.

NOTE: The only exception to this abbreviation rule is the parameter FOR, which the system could interpret as FORMAT, or FORM, or FORMS. Therefore, be sure to use the full spelling to represent FORMAT or FORM(S).

- **Blank spaces:** You may use blanks anywhere in the JSL except in keywords and constants.
- **Continuation lines:** The FreeFlow Print Server LCDS systems accept continuation lines in DJDEs. The following is an example of a DJDE using a continuation line.

NOTE: Use of continuation lines is not recommended because the results are unpredictable

Incorrect structure for FreeFlow Print Server LCDS systems:

```
DJDE FONTS=(fn1,fn2,fn3,...,fn13,  
DJDE fn14,fn15,fn16);
```

Valid structure for FreeFlow Print Server LCDS systems:

```
DJDE FONTS=(fn1,fn2,fn3,...,fn13),;  
DJDE FONTS=(fn14,fn15,fn16),;
```

- **End of a command:** Place a semicolon (;) at the end of every PDL command.
- **End of a JSL:** Use the END; command to signal the end of a JSL or other file such as a PDE, CME, or STOCKSET.
- **End of all JSLs:** To signal the end of all JSLs, PDEs, CMEs, TSTs, or STOCKSETS that are being processed, enter END followed by a semicolon (;) **twice**, as shown below.

```
END; END;
```

- **Multiple part options:** Use parentheses to enclose multiple parts of a parameter option.

Example:

```
CRITERIA CONSTANT=(0,120,EQ,T1);
```

- **Order of right part components:** If you want to specify more than one component of a parameter right part, enter the components in the order they are shown in the command description and separated by commas.

Example: The MESSAGE OTEXT parameter has two alternative options, one of which has four components enclosed in parentheses. (The square brackets indicate that a component is optional. The braces indicate that the command contains alternative options, only one of which may be used. Alternatives are separated by the “|” separator character.)

```
OTEXT={ (sc [, {passnum|END}] [, WAIT]) | NONE }
```

- **Placeholders:** To specify a particular component but not the optional components preceding it, do not enter more than one comma as a “place holders” for the component you do not specify. The component must be optional as indicated by square brackets in the syntax definition for the parameter. When the comma preceding the optional component appears inside the square brackets, then it is provided only if the component is provided.

Example: If you want to specify an operator message (OTEXT) and the WAIT parameter, but wish to use the default value for *passnum*, enter:

```
OTEXT=('load blue paper', WAIT);
```

The *passnum* component is not supplied in the example, and its default value is used instead.

- **Singular or plural:** You may use either the singular or plural form of the FONT, FORM, and GRAPHIC parameters. (The S in FONTS, FORMS, and GRAPHICS is optional.)
- **Separation of parameters:** Use commas and blanks to separate parameters within a command.

Example:

```
BANNER TEST=C1, HCOUNT=1, TCOUNT=2;
```

NOTE: Commas and blanks cannot be used interchangeably. Many commands require commas to separate the parameters, and blanks are not valid delimiters. The syntax diagram in each command and parameter description shows which delimiters to use.

- **Uppercase text:** Use UPPERCASE letters when coding PDL commands. Comments, however, need not be in uppercase.

Command example

The following LINE command example contains three parameters. The right part of the VFU parameter is a reference to an identifier “VFU1.” The right part of the DATA parameter has two components that are value constants, and OVERPRINT uses keyword constants.

Table 1-3.

LINE	VFU=VFU1, DATA=(1,10), OVERPRINT=(PRINT,DISP);
------	---

Command syntax conventions

The command descriptions use the syntax conventions shown in the table below.

Table 1-4. Syntax conventions

Symbol	Term	Function
()	Parentheses	Enclose options in a command right part that consist of two or more components, separated by commas.
{ }	Braces	Enclose a set of choices for a right part component, or the entire right part of a command for which there are two or more alternative (“either–or”) options, only one of which must be selected.
	Separator	Separates alternative command right part options, one of which must be selected. (Means “or.”)
[]	Square brackets	Enclose components that are optional and not required for the command.
,	Comma	Separates multiple parameters or components of a parameter right part (means “and”).
OUTPUT (example)	Uppercase letters	Denote a keyword for a command, parameter, or option.
<i>value</i> (example)	Italics	Denote a variable you must define.

Sample PDL commands

The following table lists a set of commands in the order that they might appear in a JSL. It shows the components of PDL commands and a variety of right part options.

The commands are displayed below in table form so you can more easily distinguish their components. When coding a JSL, you may want to use tabs to separate these parts. You may also prefer to place all parameters for a command on the same line with the command keyword.

Table 1-5. Sample PDL commands

Identifier	Command keyword	Parameter keywords	Parameter options
VFU1:	VFU	ASSIGN= TOF= BOF=	(1, 1), 1, 55;
VFU2:	VFU	ASSIGN= TOF= BOF=	(1, (4, 59)), 4, 127;
T1:	TABLE	CONSTANT=	('CLIPS');
C1:	CRITERIA	CONSTANT= LINENUM=	(14, 5, EQ, T1), (6, 3);
T2:	TABLE	CONSTANT=	('1');
C2:	CRITERIA	CONSTANT=	(0, 1, NE, T2);
CME1:	CME	LINE= POS= CONSTANT=	3, 59, 'FIRST QUARTER';
CME4:	CME	LINE= POSITION= FONT=	(1, 60), 5, 2;
PDE2:	PDE	PMODE= BEGIN= FONTS=	PORTRAIT, (1.1,.37), (P08TYA, P08SCA);
CODTAB:	CODE	DEFAULT= ASSIGN=	EBCDIC, (X'4A', X'B4');
	RECORD	STRUCTURE= LENGTH=	FB, 132;
	LINE	VFU= DATA= OVERPRINT=	VFU1, (1, 10), (PRINT, DISP);

Table 1-5. Sample PDL commands (Continued)

Identifier	Command keyword	Parameter keywords	Parameter options
	ACCT	USER= DEPT=	BIN, 'MEDCAR';
	OUTPUT	FORMS= FORMAT= MODIFY=	XER111, PDE2, CME4;
	ROUTE	RTEXT= RFORM=	('ENGINEERING', 2, 56, 109), XERCOV;
	RDELETE	TEST=	(C1, AND, C2);
	IDEN	PREFIX= SKIP= OFFSET=	'\$DJDE', 10, 1;

PDL command categories

PDL commands are classified according to their functional categories: input, logical processing, or output (print formatting) commands. DJDEs are in a separate category, because they are specified in the data stream instead of a JSL. Descriptions of the commands are listed according to command category, within the following chapters:

- “Specifying input parameters”
- “Using logical processing”
- “Specifying print format parameters”
- “DJDE descriptions”

For a summary of all commands, refer to:

- “PDL command and DJDE summary” (Appendix A)
- “PDL command quick reference” (Appendix B)

The Job Source Library (JSL)

The PDL commands that you issue to the printing system must be entered together in a file called a “job source library” (JSL). The JSL file is then compiled to convert it to an object file called a “job descriptor library” (JDL), which the system can read. The printing system then responds to the commands contained in the JDL file and prints the job the way you want it to appear.

You create a JSL by entering PDL commands at either of the following:

- Your host computer, using a host based editing facility
- Your print server, using the UNIX Text Editor

You can store your JDL files for different jobs on the print server internal disk, from which the system retrieves the JDL specified for the job. You can also store JDLs and JSLs on diskette, cartridge tape, or open reel tape and import them to the disk when you are ready to use them.

In order to create a JSL you need to know the following:

- What a JSL specifies
- Before creating a JSL: considerations and decisions
- How to code a JSL
- How to compile a JSL into a JDL
- Compatibility of the DP with other LPS that use PDL commands

What does a JSL specify?

A JSL is a set (“library”) of commands that specify various aspects of a print job, including:

- What portion of the variable and fixed data to use
- Placement, font, and point size for the variable and fixed data
- Which fonts, forms, images, signatures, and logos to use
- What paper stocks to use for the job
- Page layout
- Banner page recognition and processing
- How many copies to print
- Messages to the operator
- Use of black or colored ink for text and images (see the second note below).

NOTE: You cannot create forms at the FreeFlow Print Server, because it does not have a forms compiler. Forms specified in a JSL must be created as separate files at your host, a workstation, or the controller of another laser printing system. You can then import these forms onto the system disk from diskette or tape, or download them from your host system using the FILE DJDE or the File Transfer Protocol (FTP) process.

NOTE: You can create highlight color JSLs on a monochrome system using many of the color related PDL commands and parameters. The JSLs you create on the monochrome system can be used on the Xerox highlight color laser printing systems (4850 LPS, 4890 LPS, and DP92 LPS). If you use color JSLs to print jobs on monochrome systems, the jobs print in black and shades of gray. (The shades of gray that appear on the printed output depend on the inks that are specified in the JSL for the colored areas.)

JSL command levels

There are many PDL commands available for your job source libraries, many ways of organizing them, and virtually infinite combinations you can use to create applications with PDL. There are, however, a few programming rules that you must follow when creating a JSL. If the JSL is not structured according to these rules, the system may not recognize or obey the commands you enter.

Refer to “Coding a JSL” in this chapter for the procedure for creating a Job Source Library.

PDL commands are organized within a JSL in groupings called “command levels.”

- JDL or system level commands
- Catalog level commands
- Job or JDE level commands

You may code commands within these levels following the JDL command, which identifies the start of the system level. The system level must have at least the SYSTEM or JDL command. The catalog level is not required, and there must be at least one job specified in the JOB level. Some JSLs define only one print job, but it is more common to find JSLs that define multiple jobs.

The following table outlines the command levels and some typical specifications that are included in these various levels.

Table 1-6. Command levels and their general purpose

Command level	General purpose
JDL or system level	Establishes installation defaults. Commands at this level apply by default to all jobs (JDEs) within the JSL. Command specifications found in a job level, override specifications made at the system level. <i>NOTE: Some of these commands require an identifier, by which other commands in the JSL can reference them. Commands with identifiers are usually coded first; for example, the CODE and PCC commands. Commands within this level with identifiers, apply to all jobs and catalogs within the JSL.</i>
Catalog level	Groups PDL commands for easy reference at the job level. Catalog command sets are defined before the JOB or JDE command that references them. The catalog command sets are usually all defined before the first JDE or JOB command; therefore, they are considered to be coded at a separate level, called the “Catalog level.”
Job or JDE level	Defines how individual print jobs are processed. JDE level commands apply only to the job under which they are listed.

The following table illustrates a sample JSL file format and provides examples. Note that comments are used to designate the beginning of each level.

Table 1-7. Sample JSL file format

```
/* This sample JSL shows the JSL command levels*/
JDLSMP: JDL;

/* System level commands coded here*/
VFU1:   VFU       ASSIGN=(1,1), TOF=1, BOF=66;
VFU9:   VFU       ASSIGN=(1,9), TOF=9, BOF=66;
        VOLUME    HOST=IBMOS;
        RECORD    LENGTH=133;
        LINE      VFU=VFU9, DATA=(1,132);
        OUTPUT    FORMS=CPPR1, DUPLEX=NO, COPIES=2;

/* Catalog commands coded here if needed*/
CAT1:   CATALOG;
        LINE      VFU=VFU1;
        OUTPUT    FORMS=FORM2

/* Job level commands coded here*/
JOB CPP: JOB;
JOB2:   JOB       INCLUDE=CAT1;
JOB3:   JOB       INCLUDE=CAT1;
        OUTPUT    DUPLEX=YES

END;
```

JDL name

Begin your JSL by deciding on a name for the compiled JDL and entering the “JDL” command on the first line of the JSL. The *JDLNAME* is a 1 to 6 character alphanumeric identifier specifying the name of the JDL to be created.

Select a name that is related to the function of the JDL and identifies the type of jobs you are creating. For example, if your site has several input sources, you might want to name the JDL for an online job “JDLONL: JDL;”

The format for naming a JDL is:

```
JDLNAME: JDL;
```

For example, you might name a JDL containing short edge feed (large paper size) jobs:

```
JDLSEF: JDL;
```

When a JSL is coded, the word SYSTEM is sometimes used in place of JDL. The meaning is exactly the same. In the following example, the JDL name SAMPL corresponds to the name of the JDL to be used when printing a job. The command can be stated in the following ways:

```
SAMPL: SYSTEM;  
SAMPL: JDL;
```

JDL or system level commands

PDL commands coded at the JDL or system level establish default print job characteristics. Commands that are common to all the jobs in the JSL are listed at this level so that they need not be coded in every job in the JSL. System level commands, however, may be overridden by commands at the job or JDE level.

NOTE: The JDL level is the highest level in a JSL. When you enter the following command levels, you may wish to indent them under the system level commands.

Coding system level commands with identifiers

System level commands that require identifiers are typically coded first. These commands must be placed in the JSL either before or in the same job as any other commands within the library that reference their identifiers. The identifier that begins the command is typically placed at the left margin (at the beginning of the line).

The VFU (vertical format unit) commands in the JSL illustration shown in table 1-7 are examples of commands with identifiers. (In this JSL, the VFU command identifiers are called “VFU1” and “VFU9.”)

The types of commands described in the following sections are usually coded first at the system level (following the JDL command) because:

- They require identifiers.
- They typically apply to all jobs within a JSL.

These commands include:

- VFU commands
- TABLE commands
- CRITERIA commands
- PDE commands
- CME commands
- CODE commands
- VOLUME commands
- RECORD commands
- BLOCK commands

NOTE: Make sure that the first command line of the JSL is the JDL identifier command. The system level ID commands then follow. For example:

XSML: JDL;

VFU1: VFU ASSIGN=(1,1), TOF=1, BOF=66;

“XSML” is the name of the complete JDL. The VFU command is at the system level and has the identifier “VFU1.”

Specifying VFUs The VFU (vertical format unit) command specifies the vertical tabbing for the print job. There can be more than one VFU identified. Each VFU command requires an identifier. All VFUs are typically specified at the beginning of the system level; for example:

```
/* System level commands*/
VFU1: VFU    ASSIGN=(1,11), ASSIGN=(12,66),
          TOF=11, BOF=66;
VFU2: VFU    ASSIGN=(1,(11,77)),
          ASSIGN=(12,(66,132)), TOF=11,
          BOF=132;
VFU3: VFU    ASSIGN=(1,1), TOF=1, BOF=132;
```

Adding logical processing specifications Logical processing commands are invoked when the system locates satisfactory test criteria. These test criteria are set up for record fields and, if met, allow special processing to take place for such things as banner pages, record selection or deletion, page selection from auxiliary paper trays, and page offsetting.

An example of logical processing tests and criteria is provided in this command set:

```
T1: TABLE    CONSTANT=('PAGE 1');
T2: TABLE    CONSTANT=('INPUT RECORDS');
T3: TABLE    CONSTANT=('JOB');
C1: TABLE    CONSTANT=(122,6,EQ,T1),
          LINENUM=(1,10);
C2: TABLE    CONSTANT=(14,13,EQ,T2);
C3: TABLE    CONSTANT=(14,3,EQ,T3);
```

These commands are often placed at the system level because they require identifiers. However, depending on how many of the jobs they apply to within the JSL, they could be coded at any of the other levels.

Specifying formats (PDEs)

There are many standard formats or print description entries (PDEs) available for your JSL. These formats are listed in the “PDE command” section of the “Specifying print format parameters” in Chapter 4. PDEs, like VFUs, require identification; for example:

```
PDE1:  PDE      BEGIN=(0.18IN,0.66IN),
        FONT=(L0112B,L01BOA),
        PMODE=LANDSCAPE;

PDE2:  PDE      BEGIN=(1.03,.51),
        BEGIN=(6.30,.51),
        FONTS=P1012A, PMODE=PORTRAIT;
```

Using copy modification entries

Copy modification entries (CMEs) allow you to change certain parts of static data in report output and to change fonts within variable data. Below are some sample CMEs:

```
CME1:  CME      LINE=(9,-), POS=1, FONT=1;

CME2:  CME      LINE=3, POS=59,
        CONSTANT='FIRST QUARTER';
```

Defining character code translation tables

CODE commands define character translation tables used to convert input job data into printed characters. For example:

```
C1:  CODE  DEFAULT= EBCDIC;
        ASSIGN= ('\'', '/');
```

Coding other system level commands

System level commands without identifiers should be indented under the commands with identifiers. One exception is the JDL name command, which precedes the identifier commands and is not indented.

The following sections discuss several other commands that are usually coded at system level and that do not require identifiers.

Setting up input parameters

You may want to start by specifying the input data characteristics for the application. The basic input processing commands are BLOCK, CODE, PCC, RECORD, TCODE, and VOLUME. Input processing characteristics vary depending on the data source. For example, if your JSL is for an online application, the BLOCK command is not applicable. Also, parameters within a command may apply to offline only, online only, or both. For example, with the VOLUME command, the parameters CODE and HOST can apply to both online and offline; EOVS applies only to offline applications; and OPTIMIZE applies only to online applications. Following are examples of typical input processing commands.

- Online:

```
VOLUME  HOST=IBMONL, CODE=EBCDIC;  
RECORD  LENGTH=136;
```

- Offline:

```
VOLUME  HOST=IBMOS, LABEL=STANDARD, CODE=EBCDIC;  
BLOCK   LENGTH=2660, PREAMBLE=4, LTHFLD=2,  
        FORMAT=BIN;  
RECORD  LENGTH=135, PREAMBLE=4, LTHFLD=2,  
        STRUCTURE=VB, OFFSET=2, FORMAT=BIN;
```

Specifying LINE command parameters

The LINE command references VFUs from the system level and allows you to instruct the system on which parts of the data in each record will be printed. For this reason, it typically follows the RECORD command. For example:

```
LINE  DATA=(1,132), PCCTYPE=IBM3211,  
      PCC=(0,NOTRAN), VFU=VFU1;
```

Specifying ACCT command parameters

The ACCT command often follows the LINE command and can be coded into any command level.

```
ACCT  USER=TRAY;
```

Catalog level commands

The catalog level allows the coding of commands common to several JDEs. A catalog can then be referenced in an INCLUDE parameter in any following JDE commands. A catalog section of a JSL begins with the CATALOG command and ends with the appearance of another CATALOG command or a JOB command. CATALOG commands may contain the same commands that appear in the JOB command.

The CATALOG command has the form:

```
catname: CATALOG;
```

The *CATNAME* is a 1 to 6 character alphanumeric identifier, of which at least one character must be alphabetic. The catalog name is referenced by JDEs after the CATALOG command set has been defined.

For example:

```
POWER: CATALOG;
```

In this command, POWER is the catalog level identifier to be used in the INCLUDE parameter of a JOB command. To reference the catalog named POWER in a job, the job level command would be:

```
JOB1: JDE    INCLUDE=POWER;
```

Job or JDE level commands

A JSL contains one or more elements called “jobs” or “Job Descriptor Entries.” A JDE, along with its system level commands, describes the options that apply to one printing task. A JDE contains one input format, one set of processing instructions, and one set of output instructions. The identifier for each JDE (job) is a user defined name that you invoke to run the job.

PDL commands that are coded within the job command level override the system commands. For each job, values not specified in any of the command sets are taken from the PDL defaults. Refer to the “PDL command and DJDE summary” table in Appendix A for a list of all command defaults.

PDL commands coded at a catalog command level can be incorporated as shown in the command syntax below. *CATNAME* is a 1 to 6 character alphanumeric identifier of a previously defined catalog name.

Examples of JOB commands

Following are some examples of job commands.

```
JOB2:  JDE;
JOB3:  JDE      INCLUDE=CAT2;
JOB4:  JDE;
      LINE      VFU=VFU2;
      OUTPUT    FORMS=AY2F;
```

A JOB or JDE command remains in effect until another JOB or JDE command or an END command is encountered. The identifier in a JOB or JDE command, as in JOB2, JOB3, or JOB4 in the previous example, is used with the identifier on the JDL or SYSTEM command to initiate a print job.

Coding job or JDE level commands

The commands discussed in this section are usually coded at the JOB or JDE level of the JSL, because they normally vary by individual job. However, you may want to code them at the catalog level if you have grouped jobs together that have the same characteristics as defined in the commands.

Defining stock requirements

There are several ways to specify paper stocks with PDL. One method is the STOCKSET command, which can be referenced in lower level commands. Each formatted page is then associated with the active STOCKSET command and the active OUTPUT FEED parameter. If no FEED parameter is specified, the INIFEED parameter of the STOCKSET command takes effect.

- Use the OUTPUT command and the PAPERSIZE and SYSPPR parameters to specify physical and system paper size. The OSTK and TRANS parameters allow you to specify tab or transparency stocks, and the NTO1 parameter enables you to instruct the printer to print the last page of a report first.
- The FEED parameter of the OUTPUT command can either specify a stock reference assigned in the STOCKSET command or bypass this referencing and specify a stock name called out in the current STOCKSET.
- The INIFEED parameter of the STOCKSET command is the default if no OUTPUT FEED parameter is present.

Here is a sample STOCKSET command:

```
SSML:  STOCKSET  ASSIGN= ('WHITE' ,CVR) ,
          ASSIGN= ('YELLOW' ,BLL) ,
          ASSIGN= ('GREEN' ,SUM) ,
          INIFEED=CVR,
          SYSPAGE=SUM;
```

Specifying output requirements

There are many specifications you can select to define the manner and look of your printed application. You can also have messages displayed to operators to advise them of special circumstances. This is done with the MESSAGE command:

```
MESSAGE OTEXT= ('ALL FORMS DUPLEX ONLY!!!' , 1, WAIT);
```

NOTE: The MESSAGE OTEXT command shown above is one example, and is not necessarily the recommended method for switching media. Refer to the “OUTPUT STOCKS” and “OUTPUT FEED” command descriptions in the “Specifying print format parameters” chapter for further information.

Similarly, the ROUTE command sends printed information preceding the report to operators. Most output specifications are selected from parameters of the OUTPUT command. As with other commands, these can be specified at any command level, but are most often specified at the job level because of the many variations possible.

Job level command examples

Here are some examples of commands that are coded at the job or JDE level:

```
/* Job level commands*/

JOB1:  JDE;

        OUTPUT      DUPLEX=YES,  SHIFT=YES,
                    FORM=SMPLE,  MODIFY=CME1,
                    FORMAT=PDE1,  COPIES=10,
                    BFORM=SMLBK,  OFFSET=FIRST,
                    PURGE=NO;

JOB2:  JDE;

        LINE        VFU=VFU2UP;

        OUTPUT      FORMAT=PDE4,  FORMS=SPL2,
                    COPIES=7;
```

Comments

Comments are optional statements you may include in the source file to identify sections of the JSL, describe selected PDL commands and their functions, or provide messages for anyone who modifies the JSL later. The system does not perceive these comments as commands and ignores them.

Comments may appear anywhere within the JSL and may consist of multiple records. Comments must be preceded by the character sequence **slash asterisk** (`/*`), and terminated by the character sequence **asterisk slash** (`*/`). For example:

```
/*System commands are coded here.*/
```

Nested comments

A comment may also be nested within another comment. There is no practical limit to the level of nesting possible, as long as each nested comment is preceded by a slash and an asterisk (`/*`) and succeeded by an asterisk and a slash (`*/`). An acceptable nested comment format is as follows:

```
/*  
comment  
/*  
nested comment  
*/  
*/
```

Note that the illustration above ends with two `*/` markers: the first for the nested comment and the second for the main comment.

Ending a JSL

A JSL terminates with the END command. When you are finished constructing your JSL, you must let the system know you are finished by entering the END; command, as shown below. This also applies to CMEs, PDEs, TSTs, and STOCKSETs you are coding.

```
END;
```

What may follow the END; command

After you end a JSL, you may still code certain items following the END; command.

Subsequent JSLs: Following the END; command for one JSL, you may code additional JSLs. If one JSL is to follow another, the next command after the END; command should be another "JDL" command.

CMEs, PDEs, TSTs, and STOCKSETs: Following an END; command for a JSL, you may code one or more CMEs (CME command), PDEs (FORMAT command), TSTs (ROUTE command), or stocksets (STOCKSET command). If the CME, PDE, TST, or stockset that you are coding will be used by more than one JSL file or is referenced by a DJDE, compile and catalog it as a separate file (not part of any JSL). Refer to “Compiling a JSL,” later in this chapter, for the procedure.

Ending all JSLs The end of all JSLs, CMEs, PDEs, and so forth to be processed is indicated by two consecutive END; commands as shown below.

```
END; END;
```

Sample completed JSL

The following figure shows the entire JSL constructed from the command level examples in this section. This is an example of an online JSL. Note that HOST=IBMONL indicates the source and structure of input data. The VOLUME=HOST command indicates whether the JSL is for an offline (tape) or online job.

```

XRXSPL: JDL;
/* System level ID commands*/
VFU1:    VFU      ASSIGN=(1,11), ASSIGN=(12,66), TOF=11,
          BOF=66;
VFU2UP:  VFU      ASSIGN=(1,(11,77)),
          ASSIGN=(12,(66,132)), TOF=11, BOF=132;
VFU3:    VFU      ASSIGN=(1,1), TOF=1, BOF=132;
PDE1:    PDE      BEGIN=(0.18IN,0.66IN),
          FONT=(L0112B,L01BOA), PMODE=LANDSCAPE;
PDE2:    PDE      BEGIN=(1.03,.51), BEGIN=(6.30,.51),
          FONTS=P1012A, PMODE=PORTRAIT;
CME1:    CME      LINE=(9,-), POS=1, FONT=1;
CME2:    CME      LINE=3, POS=59,
          CONSTANT='FIRST QUARTER';
          VOLUME   HOST=IBMONL, CODE=EBCDIC;
          RECORD   LENGTH=136;

```



```
LINE      DATA=(1,132), PCCTYPE=IBM3211,
          VFU=VFU1;

ACCT      USER=TRAY;

IDEN      PREFIX='C9700', SKIP=7, OFFSET=1;

SSML:     STOCKSET  ASSIGN=('WHITE', CVR),
          ASSIGN=('YELLOW', BLL),
          ASSIGN=('GREEN', SUM),
          INIFEED=CVR, SYSPAGE=SUM;

          MESSAGE  OTEXT=('ALL FORMS DUPLEX ONLY!!!', 1,
          WAIT);

/* Job level commands*/

JOB1:     JDE;

          OUTPUT   DUPLEX=YES, SHIFT=YES,
          FORM=SMPLE, MODIFY=CME1,
          FORMAT=PDE1, COPIES=10,
          OFFSET=FIRST, PURGE=NO;

JOB2:     JDE;

          LINE     VFU=VFU2UP;

          OUTPUT   FORMAT=PDE2, FORMS=SPL2,
          COPIES=7;

END;
```

Before creating a JSL: considerations and decisions

Before starting to develop the JSL for your application, you must make the following key decisions, based on your site specific needs and the design of the application.

- Input data
- Output specifications
- Type of application to create
- Special features
- Interactions between JSLs, catalogs, and jobs
- Stock size
- Page orientation
- Font types
- Hints and tips

Input data

Before starting to develop the JSL for your application, you should know the following information about the input data.

- The input source, such as:
 - The host that supports the 3211 or 4245 host interface
 - Open reel or cartridge tape, which are offline devices
 - System disk
 - Combination of two or more of these sources
- Computer on which the data was created
- Block and record lengths and structure
- Code in which the data is encoded, such as ASCII and EBCDIC
- How printer carriage control (PCC) information should be processed
- For tapes: the label format used

Output specifications

Before starting to develop the JSL for your application, you must know the following about the printed output.

- Will you modify an existing JSL or create a new one?
- Will the orientation be landscape (horizontal) or portrait (vertical)?
- Will you use more than one type or color of stock in the print job?
- What fonts will be used?
- Will you use a form? If so, you need to specify the form in your JSL. If do not have an existing form that you can use, you will need to create it and load it onto the system disk.

You may specify the first form for your job in the Queue Manager, LCDS Setup, Output, or On-line Job Manager windows on the print server, when you are ready to print. This form selection overrides any initial form specified in the JSL. (If you do not specify an Initial Form at the user interface, the form defined in the JSL is used.)

- What paper sizes will be used?
- Will copy modification entries (CMEs) be used?

- Will the output be delivered face up, N to 1 (last page first), and collated?
- Will the data be printed on one side of the page (simplex) or on both sides (duplex)?
- Will graphics be used?
- What types of applications will be printed? For example:
 - Forms
 - Reports
 - Letters
 - Billing statements using variable data, that is, information that varies from customer to customer.
- What are the conventions at your site, if any, for naming forms, JSLs, files, and jobs?

This information helps you plan your application: the type of input data to specify, the type of application to design, and how to customize the application so that it meets its intended purpose rather than using system defaults.

Special features

Before starting to develop the JSL for your application, determine the following:

- Will you display operator information, such as messages, on the print server screen?
- Will you select paper trays?
- What will the page layout be? For example, a large form may require an entire page but, if smaller formats are usable, you may want to print two, or even four logical pages on each physical page.
- Will you use dynamic job descriptor entries (DJDEs) to change the application on a page or report basis? Refer to the “Using DynamicJob Descriptor Entries (DJDEs)” chapter for an explanation of DJDEs and their coding process.

Interactions between JSLs, catalogs, and jobs

Before starting to develop the JSL for your application, consider the interactions, similarities, and differences between various JSLs, catalogs, and jobs. Remember: although a printing system can have only one JOB or JDE in effect at a time, you can still create JSLs with multiple JOBS or JDEs, and switch between the JDEs by using DJDEs in the data stream.

- What characteristics are used globally, if any, for all of the applications at your site? For example, do all jobs use the same host, format, paper size, page orientation, block or record length, test criteria, DJDEs, error responses, accounting requirements, fonts, or forms?
- What names will you call the JSL and catalogs or individual jobs within the JSL? Use names that will be meaningful to you and others who may use the application.

Paper sizes and page frames

The printing system considers paper sizes in terms of page frames, which are boundaries associated with a page as a unit of printing or imaging. The system defines three page frames:

- Physical page
- System page
- Logical page

In addition to paper size, you must consider edgemarking and non-imaged elements when you design the pages of your applications.

System page The “system page” is the maximum image area of the printer for the paper size. The system page size varies, depending on the size of the paper for your job.

Physical page The “physical page” is the size of the paper itself. You may select any page dimensions within an 8 by 10 inch / 203 by 254 mm minimum and a 14.33 by 17 inch / 364 by 432 mm maximum.

If your system is configured with the small paper kit option, your minimum page size is 7 by 10 inches or 178 by 254 mm.

Logical page A “logical page” is a user defined page image that is bordered by Top of Form and Bottom of Form and left and right margin specifications. Up to 63 logical pages can be defined on a physical page.

NOTE: You are not able to specify right margins on logical pages. The right margin size is determined by the left margin and the line length.

Edgemarking “Edgemarking” occurs when text or graphics are printed outside the physical sheet, giving the appearance of printing on the edge of the paper. Refer to the “OUTPUT OSTK” command description in the “Specifying print format parameters” chapter for more information on edgemarking.

*NOTE: Edgemarks must **start** within the system page, although they may print mostly outside the page boundaries.*

Elements that do not print Elements of a page, that is, text and graphics, may begin at the edge of the physical page and may even extend off the page. However, if any part of a printed element begins off the system page, then no part of the element is imaged.

- If a line of variable data begins off the system page, no part of the line is printed.
- A ruled line must originate inside the system page in order for the line to print.
- If a ruled line begins off the system page, no part of the line is printed.

Orientation

There are two types of text orientation on a page:

- Portrait
- Landscape

The vertical and horizontal positions for each of these orientations are shown in the following figures.

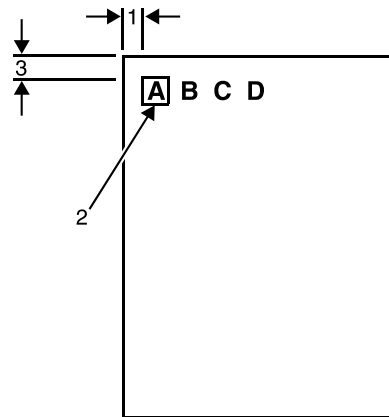

Figure 1-2. Vertical and horizontal positions in portrait mode

1. Left margin (horizontal position or hpos)
2. Character cell
3. Top margin (vertical position or vpos)

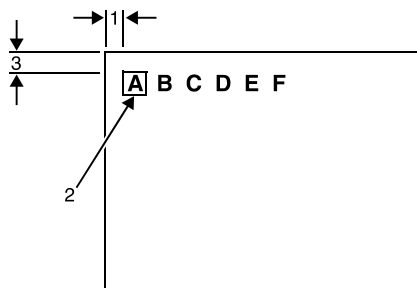

Figure 1-3. Horizontal and vertical positions in landscape mode

1. Left margin (hpos)
2. Character cell
3. Top margin (vpos)

Portrait orientation The following figure shows portrait orientation dimensions for a document using FMT6 (the standard portrait format for impact printer output).

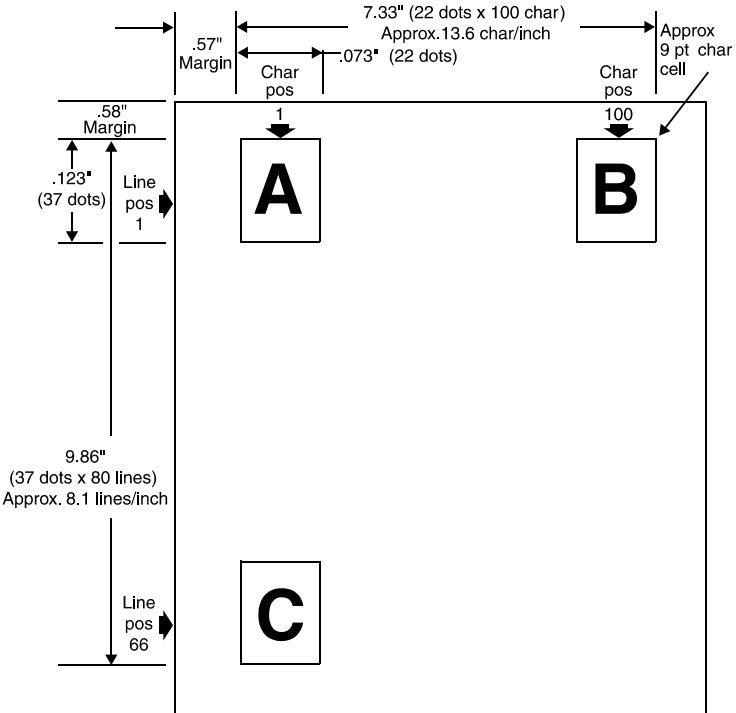

Figure 1-4. Page layout for FMT6: Impact printer format, 8.1 lines per inch

Landscape orientation

The following figure shows landscape orientation dimensions for a document using FMT1 (the standard landscape format for impact printer output).

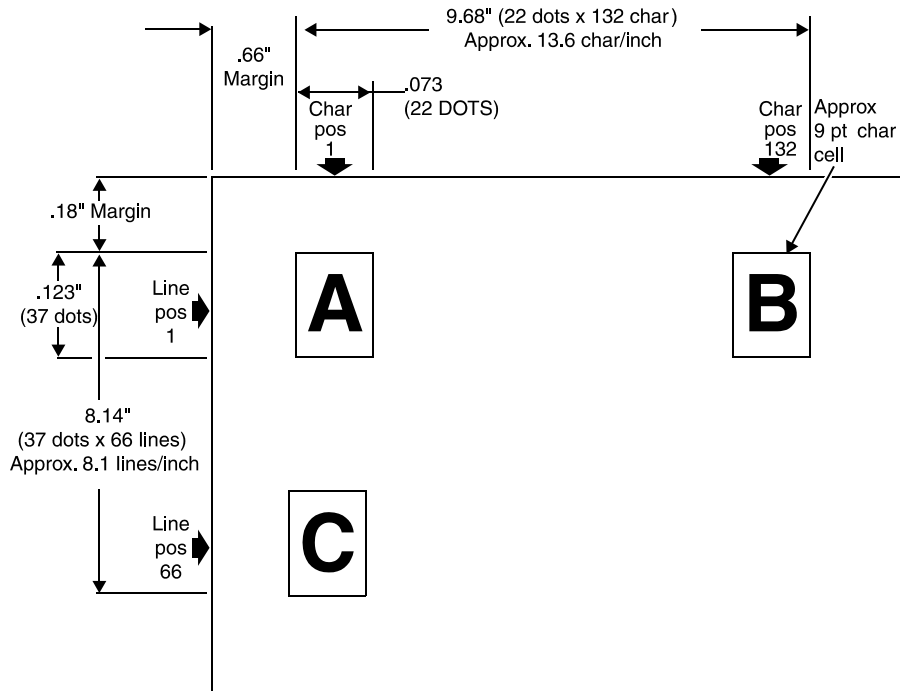

Figure 1-5. Page layout for FMT1: Equivalent impact printer format, 8.1 lines per inch

Fonts

A *font* is a character set that has a unique type style, type size, and orientation. Both fixed pitch and proportionally spaced fonts are available for use on your printing system. Each font character occupies an area called a “character cell.” All character cells in a fixed pitch font are the same width. Character cells in a proportional font vary in width.

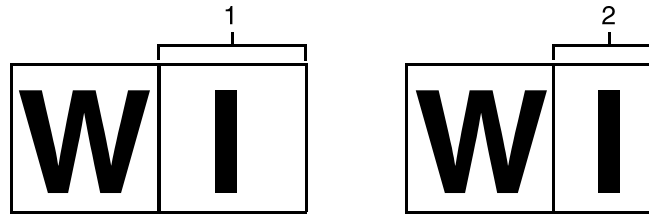

Figure 1-6. Fixed pitch and proportional font character spacing

1. Fixed pitch character cell
2. Proportionally spaced character cell

Because the length of a line printed with a proportional font is relatively unpredictable, fixed pitch fonts are used for variable data on a report to avoid overprinting of forms by variable data. Proportional fonts are normally used for form data such as titles and headings. A business letter is an example of the use of proportional fonts for variable data. An example of the difference in line length is illustrated in the following figure.

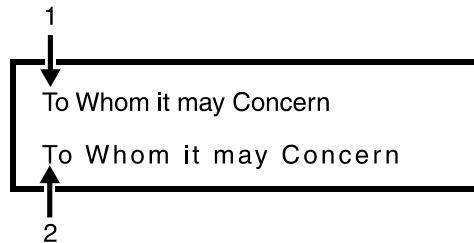

Figure 1-7. Character spacing examples

1. Proportional spacing
2. Fixed pitch spacing

Fonts are available in various families (for example, OCR and Titan), sizes, and faces (for example, italic and bold). Refer to the *Font Reference Manual*, delivered with your system, for more information on fonts and for samples of the font families, sizes, and faces available for use with your printing system.

In addition to typeface, style, and size, a font can be defined by its orientation:

- Landscape
- Portrait
- Inverse landscape
- Inverse portrait

Custom fonts, signatures, and logos may be ordered from Xerox through your sales representative.

Overriding PDL commands

The system default values are listed in the “PDL command and DJDE summary” in Appendix A. The printing system uses the defaults for parameters you do not specify in the JSL. When you are creating a JSL, you do not have to code the command parameters for which your jobs specify the defaults.

NOTE: Some parameters have no defaults. If you do not specify a value for these, they are not included in the job description. DJDEs do not have default values.

The coding may be further simplified by placing commands common to more than one job at the catalog command level. The PDL processor evaluates user coded commands and applies the highest priority, error free definition to the job for printing. This process, termed the “hierarchy of replacement,” is discussed in the subsequent paragraphs and illustrated in the “Command override sequence” figure.

The following figure shows a diagram of the command override sequence.

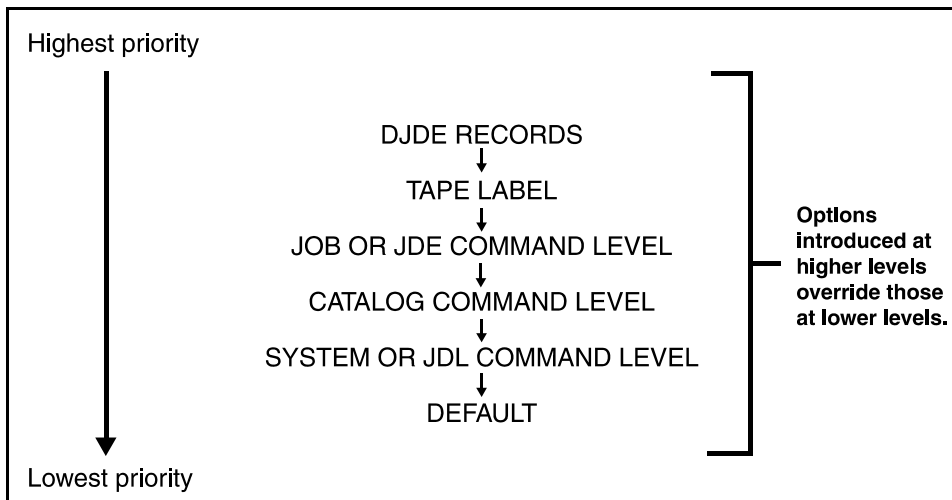

Figure 1-8. Command override sequence

User interface window overrides

Some PDL commands and DJDEs that are specified in the JSL can be overridden by queue properties that have been selected on user interface queue management windows.

- **Quantity:** The highest priority override is the Quantity (copy count) specification that can be set on the Queue Manager or the Online Manager window. This parameter must be set before the job is decomposed.
- **Late binding attributes:** Other specifications are known as “late binding attributes” or “post scheduling properties” of the queue, because they are implemented after the job has been sent to a queue and scheduled for printing. The procedure for setting late binding attributes is described in the next section.

Setting late binding attributes

In order for late binding attributes to take effect in the jobs you are printing, you must do the following for the queue that will be used:

1. On the Print Services window, click the [Queue Manager] icon. The queue list is displayed.

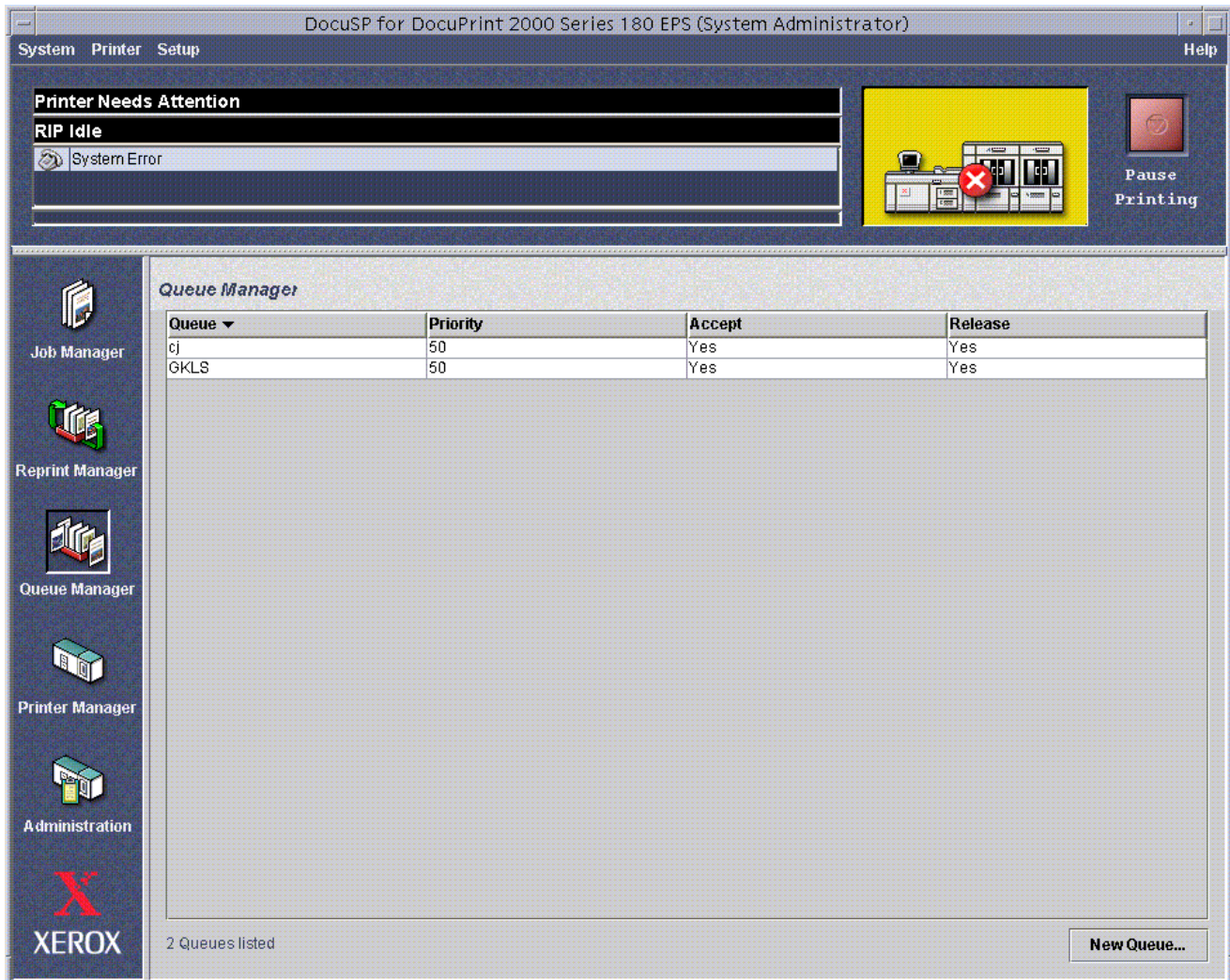

Figure 1. Print Services window with Queue Manager selected

2. On the queue list, double-click the name of the queue to which your job will be sent. The Properties window for the selected queue opens.
3. On the Properties window, click the tab that contains the attributes for which you want to specify an override. You are able to set late binding attributes for LCDS jobs on the following tab windows:
 - **[Stock]:** Includes stock name, type (including transparency), size, weight, and color, with access to the Stock List. Alternatively, you can select the name of a tray from which to feed, regardless of the stock that is loaded in it.

- The FreeFlow Print Server on the DP EPS supports unlimited stock media to be assigned to a tray.
- The FreeFlow Print Server on the Nuvera 1xx MX DPS supports up to 15 different media to be assigned to a tray.
- **[Output]:** Includes sides imaged (1-sided or 2-sided), finishing, slip sheets, rotation of page image, delivery (face up or down), order (1 to N or N to 1), output bin selection (location), collation, and optimization of throughput speed for jobs containing mixed sizes of stock.
- **[Alignment]:** Includes unit of measure for the adjustment, the amount of page image displacement, and printing a test pattern.
 - The DP EPS allows a shift of full-page size; IOT alignment is not used. The image is shifted on the page by the amount specified, starting on the next sheet.
 - The Nuvera 100/120 MX DPS supports alignment of +/- 11 millimeters in both process and cross-process directions. The image is shifted on the page by the amount specified, starting in approximately 20 sheets.

*NOTE: The features on the **Properties**, **PostScript/PCL**, **ASCII**, and **LCDS** tab windows are not late binding attributes. The items on the **Properties** tab, including queue and printer name, input mode (streaming, spooling, etc.), destination (print or save), and job notes, must be set prior to job submission.*

*The items on the **PostScript/PCL**, **ASCII**, and **LCDS** tab windows must be set before the job is decomposed. If they are not specified at that time, the system uses the queue defaults.*

4. On each tab window, select the *Override* check box for each queue attribute that you want to override all PDL commands and DJDEs.

NOTE: If [Override] is not selected for an option on the window, that option has no effect on the job. Instead, the parameter default in the JDL and JDE is used. If no JDL is specified, the system uses the default for the command itself.

The following figure shows the Output tab on a queue Properties window, on which the [Override] check boxes for the [Location], [Order], and [Delivery] have been selected.

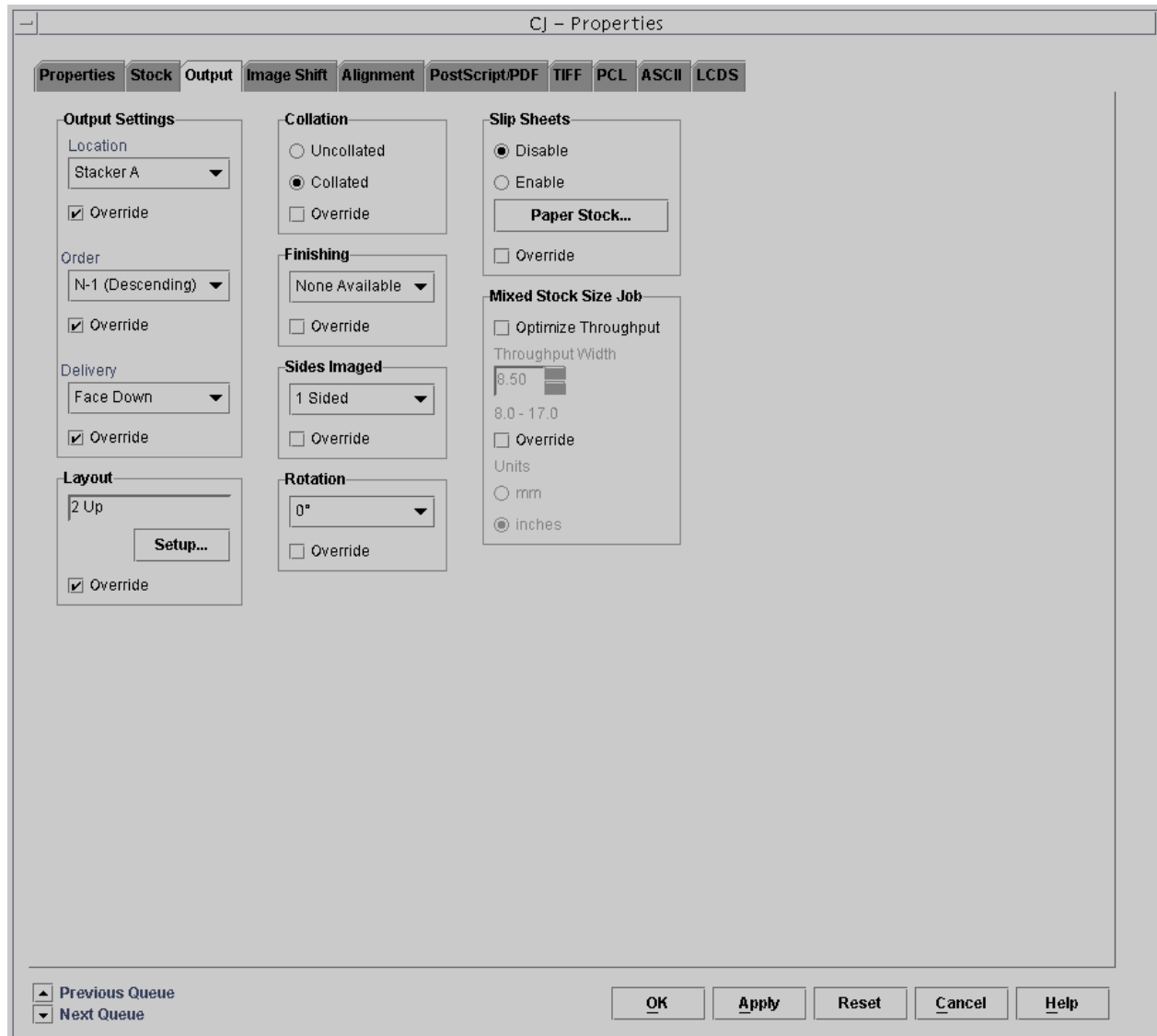

Figure 2. Output tab on Queue Properties window with [Override] options selected

NOTE: The [Initial Form] selection that appears on some of the user interface windows functions differently from the other options that can override JDL commands. [Initial Form] is overridden by DJDEs, even if its [Override] option is selected.

5. Click [OK]. The Properties window closes, and the properties for which you selected [Override] are implemented for the next job.

Specifying overrides while a job is printing

If you want to specify late binding overrides that will immediately take effect on a job that is currently printing, do the following:

1. Click [Pause Printing] on the Print Services window to halt printing.
2. Follow the procedure for specifying late binding attributes, described in the previous section.

Example:

The following example illustrates a situation in which you might want to use a late binding attribute on a job that is currently printing:

As a large job starts to print, you notice that the printed sheets are going to the sample tray. You know that the sample tray is not large enough to accommodate the entire job. On the Queue Properties window, you click the [Output] tab, then select a stacker bin from the menu in the Output group box. You click the [Override] check box, then click [OK] at the bottom of the Output window.

When you resume printing, the output immediately starts going to your selected stacker bin.

Hierarchy within a job descriptor library (JDL)

The following sample JSL for online printing contains three JDEs or jobs. The VOLUME CODE parameter, which specifies the encoding of the input data, appears in four places:

1. According to the system command level (or JDL) command set, the default encoding of the input data is ASCII (VOLUME CODE=ASCII).
2. According to the catalog command level, the encoding of the input data is EBCDIC (VOLUME CODE=EBCDIC).
3. According to the commands for job 2, the encoding of the input data is Printable EBCDIC (PEBCDIC). The PDL command VOLUME CODE=PEBCDIC overrides both catalog and system command level definitions.
4. In Job 3, the encoding of the input data is EBCDIC, because the INCLUDE parameter of the JOB command specifies the CATGRP catalog which, in turn, specifies EBCDIC in its VOLUME command CODE parameter.

NOTE: This JSL contains some highlight color commands and parameters: IDR, ILIST, ICATALOG, and IDEFAULT. These commands are processed, but most have no effect on the output if the JSL is used to print on the FreeFlow Print Server LCDS systems. However, if the JSL is used on a highlight color printing system such as the Xerox 4890 LPS, the commands are followed. Refer to "Printing highlight color applications on FreeFlow Print Server LCDS systems" in this chapter for information on how color commands are treated by the FreeFlow Print Server LCDS systems.

Table 1-8. Sample JSL

```
JDLHLC: JDL;
/*System level commands*/
VFU1: VFU ASSIGN=(1,5), ASSIGN=(2,10),
        ASSIGN=(3,15), TOF=5, BOF=66;
PDE1: PDE BEGIN=(175 DOTS, 00 XDOTS),
        FONTS=(UN110E, PR110E, PR124B);
PDE2: PDE FONTS=(L0512C, L05SCA, L05ITA),
        PMODE=LANDSCAPE,
        BEGIN=(0.725IN, 1.000 IN);
IDR1: IDR ILIST=('RED', 'BLACK', 'PINK');
        /***IDEFAULT = 'RED' ***/
IDR2: IDR ICATALOG=XEROX, PALETTE = 'PICTORIAL',
        ILIST=('BLACK', 'RED', 'PALE PINK');
        /*IDEFAULT = 'BLACK' */
T1: TABLE CONSTANT=(A' REPORT' );
C1: CRI CONSTANT=(2, 6, EQ, T1);
    VOLUME HOST=IBMONL, CODE=ASCII;
    RECORD LENGTH=136, STRUCTURE=VB, LTHFLD=2,
        ADJUST=0, FORMAT=BIN, PREAMBLE=3;
    LINE DATA=(1, 132), OVERPRINT=(PRINT, NODISP),
        VFU=VFU1;
    IDEN PREFIX=A' DJDE', SKIP=6, OFFSET=2,
        OPRINFO=YES;
    RSTACK TEST=(C1), DELIMITER=YES;
    ACCT USER=BIN;
```

Table 1-8. Sample JSL (Continued)

```

/*Catalog level commands*/
CATPOW:  CATALOG;
         VOLUME      HOST=IBMONL, CODE=EBCDIC;
         RECORD      LENGTH=135, STRUCTURE=VB, PREAMBLE=2,
                   ADJUST=3;
CATGRP:  CATALOG;
         VOLUME      HOST=IBMONL, CODE=EBCDIC;
         RECORD      LENGTH=135, STRUCTURE=VB, PREAMBLE=1,
                   LTHFLD=1, FORMAT=BIN, OFFSET=0,
                   ADJUST=2;

/*Job or JDE level commands*/
1:      JDE;
         OUTPUT      IDR=IDR1, NUMBER=(1, 1, 0, 1, 'BLACK'),
                   FORMAT=PDE1, LOGO=(SIG1,1.5 IN,6.0 IN);
2:      JDE          INCLUDE=CATPOW;
         VOLUME      HOST=IBMONL, CODE=PEBCDIC;
         OUTPUT      IDR=IDR2, FORMAT=PDE2, IDFAULT=2,
                   FORMS=STMT3;
         ABNORMAL    ERROR=CONTINUE, IMISMATCH=CONTINUE;
3:      JDE          INCLUDE=CATGRP;
         OUTPUT      COPIES=5, IDFAULT='BLACK', XMP=REPORT;
DFLT:   JDE;
END;

```

Hints and tips

The following tips may help you as you create your JSL.

- The only required elements in a JSL are:
 - A JDL name, which is the name of the file created by compiling the JSL
 - One or more job names (JDEs)
 - END; command at the end of the JSL.

System defaults can be used for all other specifications, although typically each application has its own specific characteristics.

- Use tab spacing to create columns for the command identifiers, commands, and parameters in your JSLs. While not required by the system, this organization makes it much easier to identify command sets, their commands, and the parameters of each command quickly, reducing the chance of error.

The JSL in the following figure is set up in column format with tabs. Generally, only the JDL name, identifiers, and the END command begin in the first column of the JSL. Other commands are indented.

Table 1-9. Sample JSL

```

SMPLST:  JDL;

V1:      VFU      ASSIGN=(1,5), ASSIGN=(2,10),
          ASSIGN=(3,15), TOF=5, BOF=66;

          VOLUME  HOST=XEROX, CODE=EBCDIC,
          LABEL=NONE;

          RECORD  LENGTH=133, STRUCTURE=FB;

          LINE    DATA=(1,132), PCCTYPE=XEROX,
          PCC=(0,NOTRAN), VFU=V1;

T1:      TABLE   CONSTANT= (132) '*';

C1:      CRITERIA CONSTANT=(2,132,EQ,T1),
          LINENUM=(1,5);

CME1:    CME      LINE=(9,-), POS=1, FONT=1;

JOB1:    JDE;

          OUTPUT  DUPLEX=YES, FORMS=BARS,
          MODIFY=CME1;

JOB2:    JDE;

          OUTPUT  FORMS=NONE, DUPLEX=NO, COPIES=2;

JOB3:    JDE;

          BANNER  TEST=C1, HCOUNT=1, TCOUNT=0;

END;
```

- After deciding on the command levels you will use, make a test run of the job to see the output and to make any necessary adjustments.
- Design forms to accommodate placement of data on the page.

NOTE: It is best to start with the standard formats (print description entries or PDEs) that are predefined on the system. Each of these formats (FMT1 through FMT11) matches standard form layouts.

- If you are not sure which specifications to select, run a job using the system defaults, then adjust the JSL to meet your requirements. You can modify an existing JSL in the same manner.
- Remember the command override sequence. It is much easier to specify generic or global characteristics at the system level, for example, than to specify the same specifications repeatedly for each job or catalog.
- Remember that the specifications you make in your JSL can be changed easily. By including the IDEN command, you can allow DJDEs to override PDL commands on a page or record basis. Refer to the “Using the IDEN command to enable DJDEs” section of the “Using Dynamic Job Descriptor Entries (DJDEs)” chapter for further information. Also, certain selections entered at the user interface can alter the print job in such areas as the number of copies to be printed and paper feed specifications.
- It is sometimes helpful to sketch the page layout, including page orientation, logos, fonts, and the point of origin for printing on the page.

Coding a JSL

If you want to create a JSL using specifications other than command defaults, you have many PDL commands available to you, and many ways of organizing them.

NOTE: Not all of these steps are necessary for every JSL you create. Your application determines what parts can be omitted.

Before you start

Before you start to code your JSL, be sure you have done the following:

1. Identify the source media and data format.
2. Design the layout of your print job.
3. Build forms for the job, if necessary.
4. Identify logical processing requirements.
5. Determine whether you will use catalogs.

Short JSL coding procedure

The fastest and easiest way to create a JSL is to build it from an existing one, such as the default JSL (named DFAULT.JSL), provided with your system software. The following steps describe how to create a JSL “the short way.”

1. Open a Text Editor window by following these steps:
 - a. On the print server screen, right-click in the background to display the Workspace menu.
 - b. From the Workspace menu, select [Programs]. The Programs pull-down menu opens beside the Workspace menu.

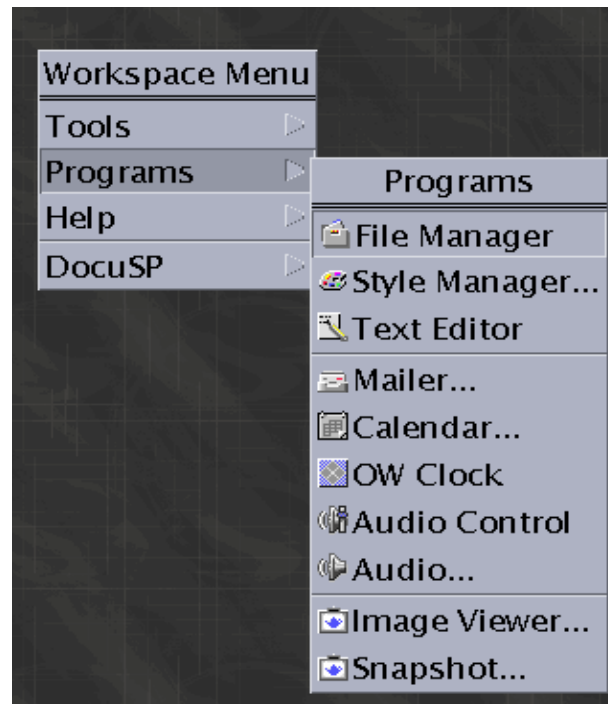

Figure 1-9. Workspace and Programs menus

- c. From the Programs menu, select [Text Editor]. A Text Editor window opens.

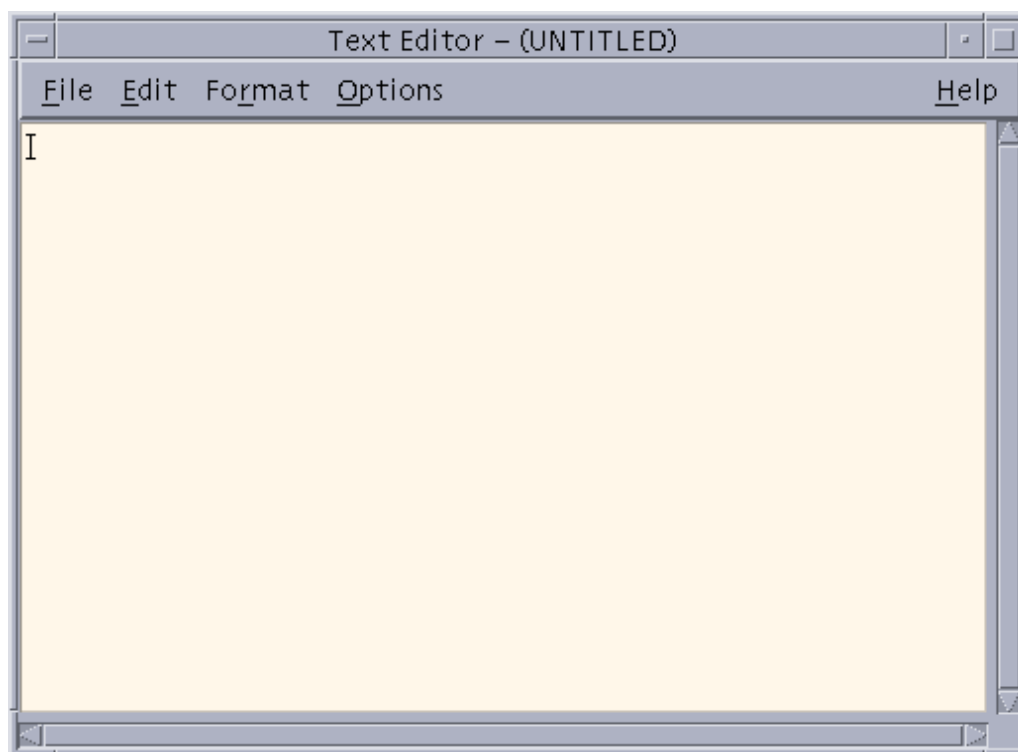

Figure 1-10. Text Editor window

2. Bring the default JSL (stored in the "lcds" folder on the system disk) into the Text Editor, using the following procedure.
 - a. From the File menu on the Text Editor menu bar, select [Include...]. The Text Editor – Include a File window opens.

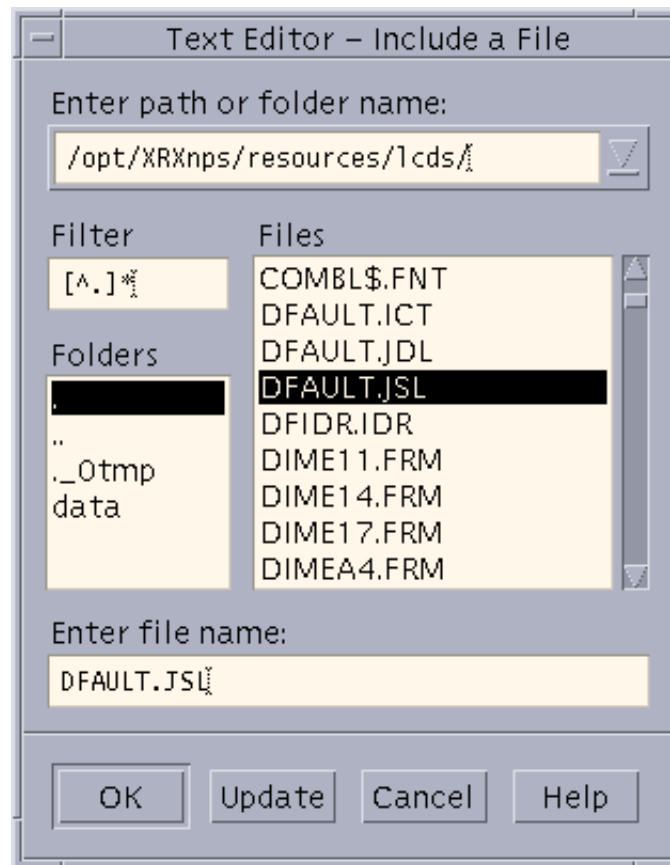

Figure 1-11. Text Editor – Include a File window

- b. In the [Enter path or folder name:] text field at the top of the Include a File window, enter one of the following directory paths and press <Return>.

`/opt/XRXnps/resources/lcds/`

or

`/var/spool/XRXnps/resources/lcds/`

NOTE: The file and folder names are case-sensitive. Be sure to enter the directory path exactly as it is shown above, with regard to uppercase and lowercase letters. Remember to include the slashes (/) at the beginning and end.

- c. A list of files appears in the Files field below the text box in which you entered the path to the folder. Scroll through the file list until you locate the file called DFAULT.JSL. This is the default JSL. (You can also use ONLINE.JSL, if you are creating the JSL for an online job.)

- d. Click the file name DFAULT.JSL, then click [OK]. The default JSL is displayed in the Text Editor window.
3. Using the default JSL as a base, enter any changes, additional commands or parameters, and deletions that you need to make in order to construct your new JSL.

NOTE: You should consider carefully the ID name that you enter in the JDL or SYSTEM command (the first line of the JSL), because this identifier determines the name of the JDL file when your new JSL is compiled.

The JDL name must be one to six characters in length, not including the extension (following the dot).

4. When you have completed entering all the desired commands and parameters, select [Save As] from the File menu on the Text Editor window menu bar. The Text Editor – Save As window appears.

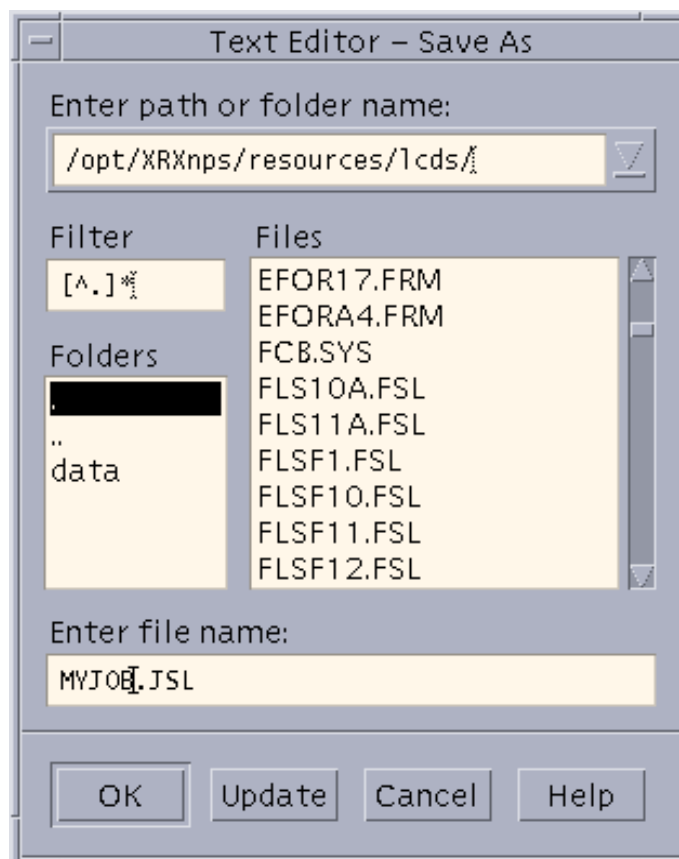

Figure 1-12. Save As window

5. In the [Enter path or folder name:] text field, enter one of the following paths to the “lcds” folder:

`/opt/XRXnps/resources/lcds/`

or

`/var/spool/XRXnps/resources/lcds/`

NOTE: The file and folder names are case-sensitive. Be sure to enter the directory path exactly as it is shown above, with regard to uppercase and lowercase letters. Remember to include the slashes (/) at the beginning and end.

The “lcds” folder, where the DFAULT.JSL and all other system LCDS resource files are stored, is the recommended folder for storing your JSLs. You have write access to this folder, which means you can add files and create new folders within it.

6. Enter the name of your new JSL in the [Enter file name:] text field at the bottom of the Text Editor – Save As window. Following are some rules for JSL names:

- The name must end with the .JSL file extension.
- The name must be one to six characters in length (not including the .JSL extension).

CAUTION

Be sure to give a new name to the JSL file that you have created. Otherwise, your new JSL may overwrite the default JSL in the “lcds” folder. (Overwriting can occur if you access the default JSL by selecting [Open] from the File menu on the Text Editor window instead of [Include]. Refer to step 7 of this procedure.)

- **Recommended:**

It is a good idea to use the same name for the JSL that you specified in the JDL or SYSTEM command at the beginning of the JSL coding. If the two names are the same, the JSL file name can be easily determined from the JDL file name in the future.

7. Click [OK]. Your new JSL is stored on the system disk. You can now close the Text Editor window.
8. Compile the JSL to create a JDL file. Refer to “Compiling a JSL” in this chapter for the procedure.

Full JSL coding procedure

If you do not want to use an existing JSL as a pattern and you prefer to build the entire JSL yourself, follow these steps.

1. Open a Text Editor window by following these steps:
 - a. On the print server screen, right-click in the background to display the Workspace menu.
 - b. From the Workspace menu, select [Programs]. The Programs pull-down menu opens beside the Workspace menu.

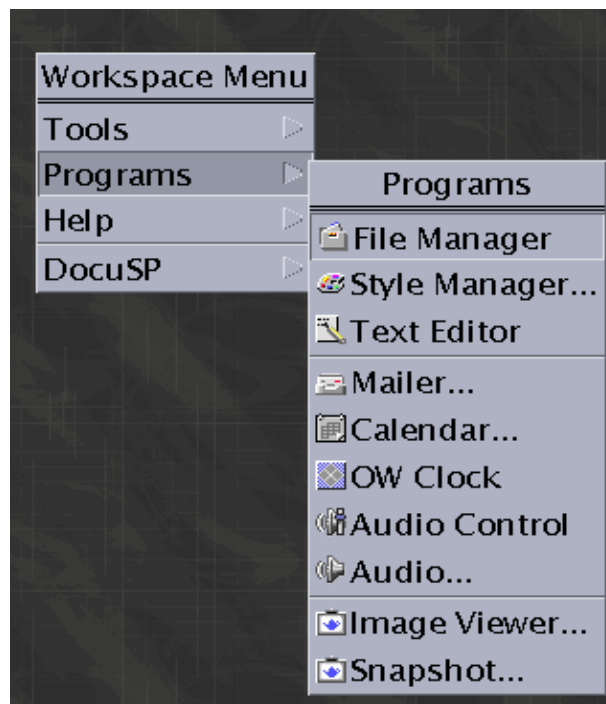

Figure 1-13. Workspace and Programs menus

- c. From the Programs menu, select [Text Editor]. A Text Editor window opens.

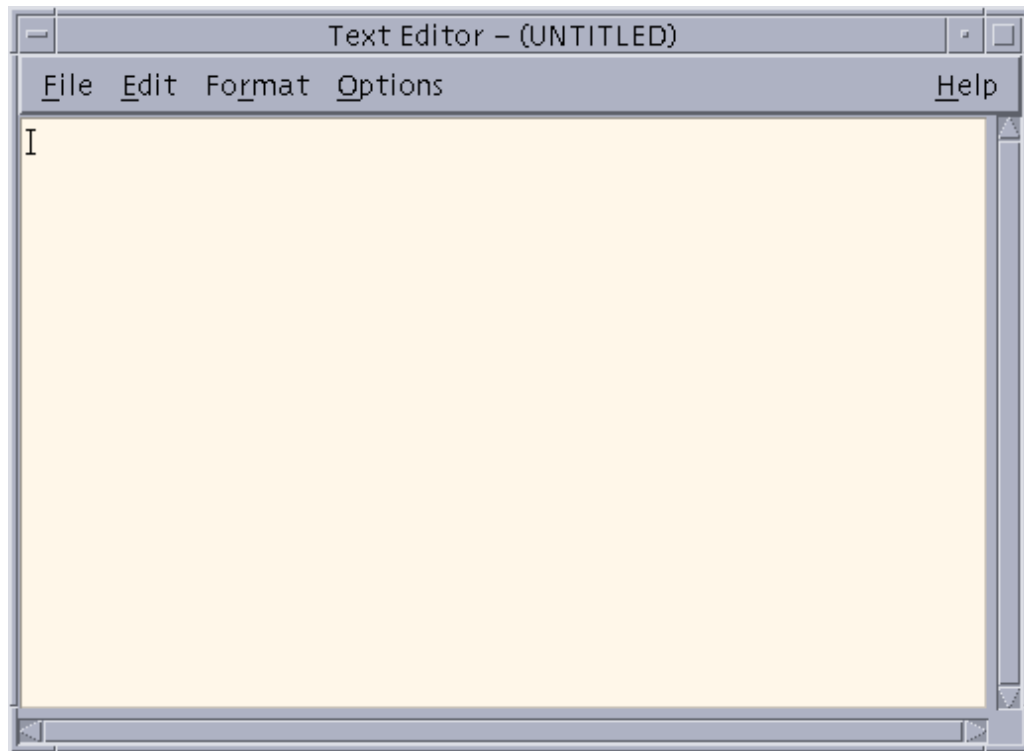

Figure 1-14. Text Editor window

2. In the Text Editor window, code the JDL name, starting at the left edge of the window workspace.
3. Code the system or JDL level ID commands with their identifiers.

Recommended:

- Before beginning your system level commands, code a comment line stating that the following entries are system level commands.
- For each command, at the beginning of the line, enter the identifier, followed by a colon (:), and the command keyword. Tab or space over until the cursor is approximately 20 character spaces from the left edge of the Text Editor workspace, then enter the first parameter keyword.
- For each subsequent parameter of the system level command, tab or space over about 20 character spaces to enter the parameter, aligning it under the previous parameter.
- Code the VFU (vertical format unit) first.

- Code the rest of your system level commands (those not requiring identifiers), to specify your input processing commands. Refer to the “Specifying input parameters” chapter for information on coding these commands.

Recommended:

For each of these commands, tab or space over about 10 character spaces to enter the command keyword. Then tab or space over until the cursor is about 20 spaces from the left edge of your Text Editor workspace to begin entering the parameter keywords.

```

Text Editor - (UNTITLED)
File Edit Format Options Help
DFAULT: JDL;
VFU1: VFU      ASSIGN=(1,4),ASSIGN=(2,10),ASSIGN=(3,16),
              ASSIGN=(4,22),ASSIGN=(5,28),ASSIGN=(6,34),
              ASSIGN=(7,40),ASSIGN=(8,46),ASSIGN=(9,66),
              ASSIGN=(10,52),ASSIGN=(11,58),ASSIGN=(12,64),
              TOF=1,BOF=66;
              VOLUME  HOST=IBMONL,
              OPTIMIZE=(NCC,NDC,NPR);
              LINE    PCCTYPE=IBM3211,VFU=VFU1,
              UCSB=PROCESS,FCB=PROCESS;
              ACCT    USER=(BIN,TRAY);
IDEN  PREFIX='DJDE',SKIP=5,OFFSET=0,OPRINFO=YES;
/*
/*      TABLES AND CRITERIAS
/*
T1:   TABLE  MASK='?',CONSTANT='HE?DE? PAGE';
C1:   CRITERIA CONSTANT=(1,11,EQ,T1),LINENUM=(1,10);
T2:   TABLE CONSTANT='TRAILER PAGE';
C2:   CRITERIA CONSTANT=(0,12,EQ,T2),LINENUM=(1,10);
T3:   TABLE CONSTANT='EOJ';
C3:   CRITERIA CONSTANT=(0,3,EQ,T3),
      LINENUM=(1,20);
T4:   TABLE CONSTANT='// JOB';
C4:   CRITERIA CONSTANT=(0,6,EQ,T4),

```

Figure 1-15. Text Editor window with JSL showing system level commands with identifiers

- Code the IDEN command at the system level if you plan to use dynamic job descriptor entries.
- Identify any dynamic print requirements for DJDEs.
- If you are using catalog level commands, code them next, with their identifiers.

Recommended: Do the following when you are coding catalog commands.

- Place a comment on the line above the first CATALOG command line, indicating that the following commands are catalog level.
 - Place the catalog identifier, followed by a colon (:) and the CATALOG keyword, at the left margin, aligned with the system level identifiers.
 - On the command lines following the catalog identifier line, tab or space over about 10 character spaces to enter the rest of the catalog level command keywords.
8. Code the first JDE identifier, followed by a colon (:) and the JDE keyword. The JDE name must be one to six characters long.

NOTE: If the JDE uses a catalog, enter the INCLUDE=catalogname command following the JDE identifier on the same line, with the semicolon (;) following the catalog name. For example:

```
2: JDE INCLUDE=CATPOW;
```

Recommended:

- Place a comment on the line above the first JDE command line, indicating that the following commands are JOB or JDE level.
 - Tab or space over approximately 10 character spaces to enter the job identifier, followed by a colon (:) and the JDE keyword.
9. Code the JDE level commands for the first job in the JSL.
- Recommended:** On the command lines following the JDE identifier line, tab or space over about 15 character spaces to enter the rest of the JDE level command keywords for that job.
10. Repeat steps 8 and 9, above, for each additional JDE that you want to specify.
11. Enter the END; command to complete the JSL.
12. When you have completed entering all the necessary commands and parameters, select [Save As] from the File menu on the Text Editor window menu bar. The Text Editor – Save As window appears.

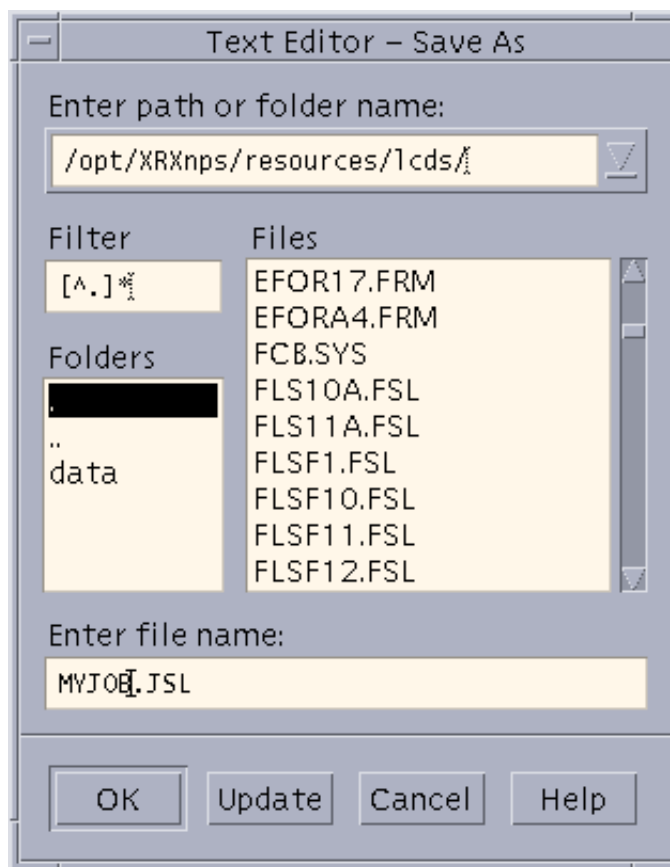

Figure 1-16. Text Editor – Save As window

13. In the [Enter path or folder name:] text field, enter one of the following paths to the “lcds” folder:

`/opt/XRXnps/resources/lcds/`

or

`/var/spool/XRXnps/resources/lcds/`

The “lcds” folder, where the DFAULT.JSL and all other system LCDS resource files are stored, is the recommended folder for storing your JSLs. You have write access to this folder, which means you can add files and create new folders within it.

14. Enter the name of your new JSL in the [Enter file name:] text field at the bottom of the Text Editor – Save As window.

Following are some rules for JSL names:

CAUTION

Be sure to give a new name to the JSL file you have created. Otherwise, your new JSL may overwrite the default JSL in the "lcds" folder. (Overwriting can occur if you access the default JSL by selecting [Open] from the File menu on the Text Editor window instead of [Include].

- The name must end with the .JSL file extension.
- The name must be one to six characters in length (not including the .JSL extension).

15. Click [OK]. Your new JSL is stored on the system disk. You can now close the Text Editor window.

16. Compile the JSL to create a JDL file. Refer to "Compiling a JSL" later in this chapter for this procedure.

Sample online JSL

The following figure shows another example of an online JSL. Note how comments are used to explain and identify parts of the JSL.

Table 1-10. Sample online JSL

```

ONLINE:  JDL;
/* System level commands */
VFU1:    VFU          ASSIGN=(1,4), ASSIGN=(2,10),
          ASSIGN=(3,16), ASSIGN=(4,22),
          ASSIGN=(5,28), ASSIGN=(6,34),
          ASSIGN=(7,40), ASSIGN=(8,46),
          ASSIGN=(9,66), ASSIGN=(10,52),
          ASSIGN=(11,58), ASSIGN=(12,64), TOF=4,
          BOF=66;
/* Tables and criteria */
T1:      TABLE      MASK='?', CONSTANT='HE?DE?PAGE';
C1:      CONSTANT=(1,10,EQ,T1), LINENUM=(1,10);
T2:      TABLE      CONSTANT='TRAILER PAGE';
C2:      CRITERIA    CONSTANT=(0,12,EQ,T2), LINENUM=(1,10);
T3:      TABLE      CONSTANT='EOJ';
C3:      CRITERIA    CONSTANT=(0,3,EQ,T3), LINENUM=(1,20)

```

Table 1-10. Sample online JSL (Continued)

```
T4:      TABLE      CONSTANT='// JOB';
C4:      CRITERIA    CONSTANT=(0,6,EQ,T4), LINENUM=(1,20);
T5:      TABLE      CONSTANT=(10,'*');
C5:      CRITERIA    CONSTANT=(0,10,EQ,T5), LINENUM=(50,10);
          VOLUME     HOST=IBMONL;
          LINE        PCCTYPE=IBM3211, VFU=VFU1,
                     FCB=IGNORE;
          ACCT        USER=(TRAY);
          IDEN        PREFIX='DJDE', SKIP=7, OFFSET=2,
                     OPRINFO=YES;

/* Job level commands */
/* Jobs with no banner pages */
      DFLT: JOB;
/* Jobs with header pages only */
      HDRP: JOB;
      BANNER          TEST=C1, HCOUNT=2, TCOUNT=0;
/* Jobs with trailer pages only */
      TRLP: JOB;
      BANNER          TEST=C2, HCOUNT=0, TCOUNT=3;
/* Jobs with both header and trailer pages */
      BOTH: JOB      INCLUDE=catname;
      BANNER          TEST=(C1 OR C2), HCOUNT=2, TCOUNT=3;
/* Other jobs */
      EOJ: JOB;
      BANNER          TEST=C3, TCOUNT=1;
      JOB: JOB;
      POWER: JOB;
      BANNER          TEST=C5, HCOUNT=2;

END;
```

Sample offline JSL

The following figure shows an example of an offline JSL. Note how comments are used to explain and identify parts of the JSL.

NOTE: This JSL contains some highlight color commands. These commands are processed by the FreeFlow Print Server, but all printing is in monochrome.

Table 1-11. Sample offline JSL

```
JDLHLC: JDL;
/* System (ID) level commands */
VFU1:    VFU          ASSIGN=(1,5), ASSIGN=(2,10),
          ASSIGN=(3,15), TOF=5, BOF=66;
PDE1:    PDE          BEGIN=(175DOTS, 300XDOTS),
          FONTS=(UN110E,PR110E,PR124B);
PDE2:    PDE          BEGIN=(0.725IN, 1.000IN),
          FONTS=(L0512C,L05SCA,L05ITA),
          PMODE=LANDSCAPE;
IDR1:    IDR          ILIST=('RED', 'BLACK', 'PINK');
          /***IDFAULT='RED'***/
IDR2:    IDR          ICATALOG=XEROX, PALETTE='PICTORIAL',
          ILIST=('BLACK', 'RED', 'PALE PINK');
          /*IDFAULT='BLACK'*/

/* Tables and criteria */
T1:      TABLE      CONSTANT=(A'REPORT');
C1:      CRITERIA    CONSTANT=(2,6,EQ,T1);

/* System level commands */
          VOLUME      HOST=IBMOS, CODE=ASCII;
          BLOCK       LENGTH=2048;
          RECORD      LENGTH=135, STRUCTURE=VB, LTHFLD=2,
          ADJUST=0, FORMAT=BIN, PREAMBLE=3;
          LINE        DATA=(1,132), PCCTYPE=IBM1403;
          PCC=(0,NOTRAN), OVERPRINT=(PRINT,NODISP),
          VFU=VFU1;
          IDEN        PREFIX=A'DJDE', SKIP=6, OFFSET=2,
          OPRINFO=YES;
```

Table 1-11. Sample offline JSL (Continued)

```
RSTACK      TEST=(C1), DELIMITER=YES;
ACCT        USER=TRAY;

/***** Catalog level commands *****/
CATPOW; CATALOG;
          VOLUME      HOST=IBMOS, CODE=EBCDIC;
          BLOCK       LENGTH=2048, PREAMBLE=6, LTHFLD=2,
                     FORMAT=BIN, OFFSET=4;
          RECORD      LENGTH=135, STRUCTURE=VB, PREAMBLE=2,
                     LTHFLD=2, FORMAT=BIN, OFFSET=0,
                     ADJUST=3;
CATGRP: CATALOG;
          VOLUME      HOST=GRASP, CODE=EBCDIC
          BLOCK       LENGTH=4096, PREAMBLE=0, ZERO=YES;
          RECORD      LENGTH=135, STRUCTURE=VB, PREAMBLE=1,
                     LTHFLD=1, FORMAT=BIN, OFFSET=0,
                     ADJUST=2;

/***** Job or JDE level commands *****/
1:        JDE;
          OUTPUT      IDR=IDR1, NUMBER=(1,1,0,1,'BLACK'),
                     FORMAT=PDE1, LOGO=(SIG1, 1.5 IN,6.0 IN);
2:        JDE;        INCLUDE=CATPOW;
          VOLUME      HOST=UNIVAC, CODE=PEBCDIC;
          OUTPUT      IDR=IDR2, FORMAT=PDE2, IDFAULT=2,
                     FORMS=STMT3;
          ABNORMAL    ERROR=CONTINUE, IMISMATCH=CONTINUE;
3:        JDE;        INCLUDE=CATGRP;
          OUTPUT      COPIES=5, IDFAULT='BLACK';
DFLT:    JDE;
END;
```

Compiling a JSL

The second part of creating the JSL is compiling it. Each JSL file must be compiled (converted) into an object file (Job Descriptor Library or JDL) before it can be read by the system to print a job. The Xerox Job Description Compiler (XJDC) software on your print server performs this conversion. The process is diagrammed below.

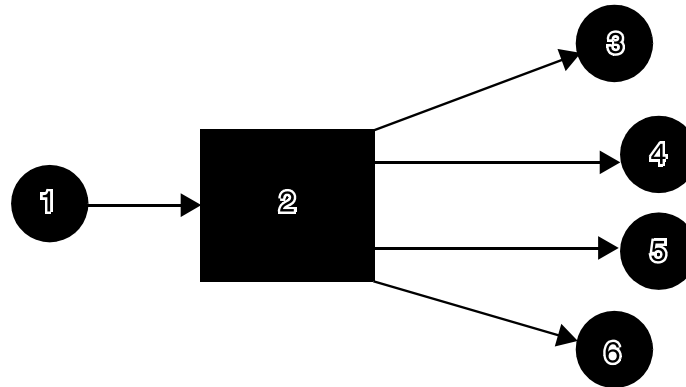

Figure 1-17. PDL compilation

1. JSL
2. XJDC (PDL compiler)
3. CME file (Copy Modification Entry)
4. JDL file (Job Descriptor Library [a compiled JSL])
5. PDE file (Print Descriptor Entry, or format)
6. STK file (STOCKSET file)

Compiling procedure

After you have finished entering all the commands for your JSL, including the last END; command, and saved the .JSL file in the "lcds" folder, you can begin the compilation process.

Rules for invoking the XJDC compiler

The command that invokes the XJDC compiler has some different syntax rules from the PDL commands that you used to create the JSL. Keep in mind the following rules when you enter this command:

- Do not omit any slashes (/). These symbols separate different directory levels of folders in the UNIX file system. The slash at the beginning of the command is actually the identifier or “name” of the parent (root) directory of the file system.
- Enter all command text in **lowercase** letters.

NOTE: This rule does not apply to UNIX file and folder names that contain uppercase letters. Be sure to enter any file or folder names exactly the way they appear in the directory. (For example, if you enter the “XRXnps” folder name as “xrxnps,” the system cannot find it.)

- Leave spaces only where the command syntax shows them; do not add any spaces where they are not indicated.
- Italics indicate variables that you must specify. For example, when entering a command, you would replace the word *filename* with the actual name of the file.

Follow these steps to compile a JSL:

1. On the print server workspace, open a Terminal window by following these steps:
 - a. Right click in the print server workspace (screen background) to display the Workspace menu.
 - b. From the Workspace menu, select [Tools]. The Tools menu is displayed next to the Workspace menu.

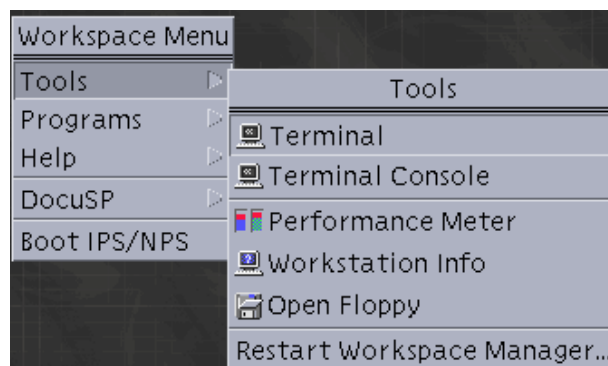

Figure 1-18. Selecting [Tools] from the Workspace menu

- c. Select [Terminal] from the Tools menu. A Terminal window opens.

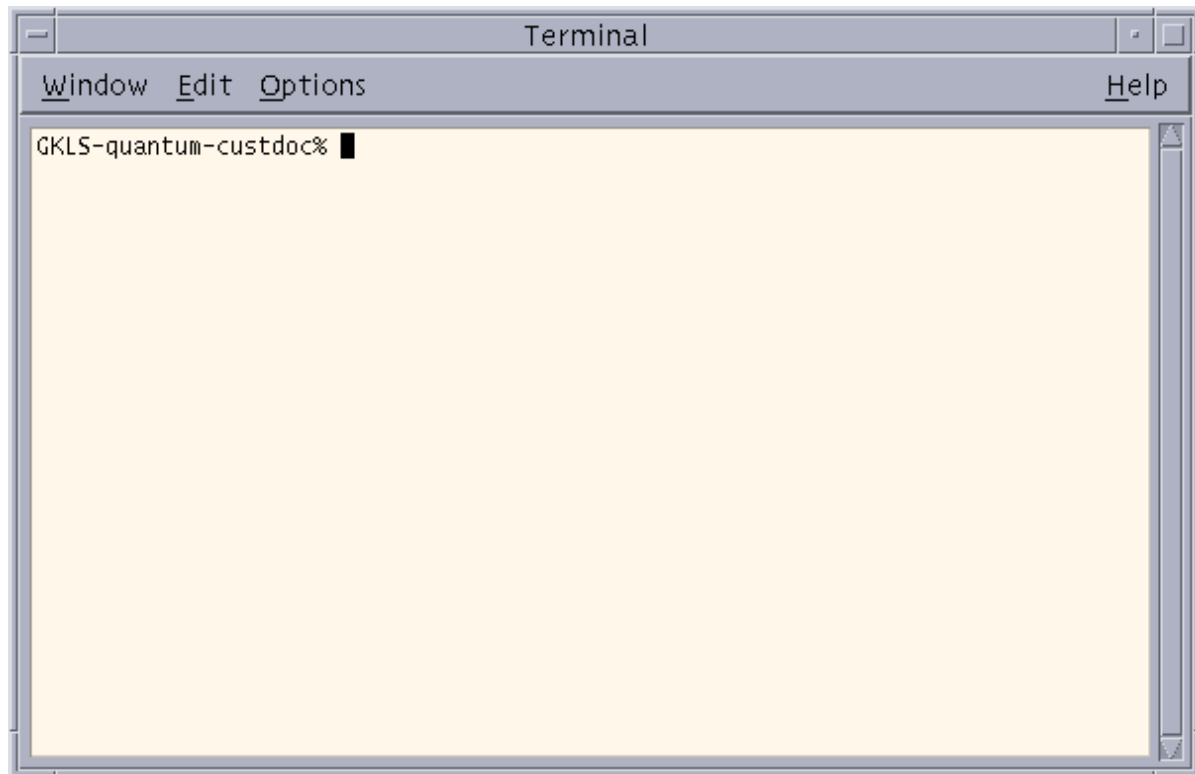

Figure 1-19. Terminal window with % prompt displayed

2. Move the pointer onto the Terminal window. A blinking cursor should be visible next to the prompt (a % sign, sometimes preceded by the name of your system).
3. At the % prompt, enter the following command to compile the JSL (be sure to leave spaces where they are indicated).

```
/opt/XRXnps/bin/xjdc options /opt/XRXnps/resources/lcds/JSLNAME.JSL
```

The *options* variable may be either omitted or replaced with one or more of the options that are shown on the following table. Options may be specified in any order.

You may shorten the option name to its first three characters (shown in uppercase in the following table).

The first option must be preceded by a hyphen. When you specify multiple options, you must separate them by commas. Refer to the following example.

Example:

```
/opt/XRXnps/bin/xjdc -NOT,LAB,REP /opt/XRXnps/resources/lcds/MYJOB.JSL
```

Table 1-12. xjdc command options

Option	Definition
COMpile	Compiles the JSL with printed sheets.
SCAn	Scans the JSL only.
PRInt	Generates a printed JSL.
NOPrint	Generates a printed JSL only when it contains errors.
REPlace	Specifies that an existing JDL file may be replaced by a new output file of the same name. This is the default.
NOReplace	Specifies that, if the new JSL has the same name as an existing one, the old file is retained as a backup file and is given a ".backup" extension. REPLACE is the default.
SINgleybyte	Specifies use of single byte character code and printer carriage control translation files.
DOUblebyte	Specifies use of double byte character code and printer carriage control translation files.
TRUncate	Restricts command lines in the JSL to the first 72 characters.
NOTruncate	Accepts JSL command lines that are longer than 72 characters.
LABel	Generates a 128 byte Xerox standard label.
NOLabel	Suppresses the 128 byte Xerox standard label.
DISplay	Displays all XJDC messages.
NODisplay	Suppresses all XJDC messages.
Vx	Software version number. x = 10, 2, 35, 3615, 37, 38, 39, 40, 50, 3A, or M10 For FreeFlow Print Server LCDS systems, the version number is M10 .
PAPersize= <i>s</i> (VM10 only)	Specifies the size of paper the job should print on. <i>s</i> = USLEGAL, USLETTER, or A4
DATE = <i>d</i>	Specifies the date format. <i>d</i> = US or EUROPEAN
PAGinate= <i>n</i>	Specifies the number of lines per page. <i>n</i> = 0 or 5 through 999 (0 specifies no pagination.)
OUTpath= <i>p</i>	Specifies the base directory path for output files. <i>p</i> = / <i>foldername1</i> / <i>foldername2</i> / ... The default is the current directory.

If the JSL compiles correctly with no errors, the JDL object file is created from the JSL, and a message is displayed in the Terminal window, indicating that the compilation was successful.

The system places the newly created JDL file (along with the .LST and .RSC files that are created at the same time) in the “lcds” resources folder where your JSL is located.

4. If the JSL does not compile correctly, correct any errors in the JSL and recompile it.

Files produced by the compilation procedure

When XJDC compiles a JSL, it produces the following files:

- **Object file (JDL):** The JDL, which contains all the information from the JSL, but in a format the system can read. If the JSL was compiled successfully, the object file, or Job Descriptor Library file, is created. The JDL file name is the identifier that is specified by the JDL command that starts the JSL. It has a .JDL extension.

NOTE: If you compile one of the other file types (other than a JSL) that are supported by the XJDC compiler, the file extension could be .CME, .IDR, .LIB, .PDE, .STK, or .TST. Its file name is the name that is specified by the first command in the file; that is, the CME, IDR, LIB, PDE, STK, or TST command.

- **JSL Source Listing file:** Shows the JSL as you coded it, but with the lines and columns numbered. Also indicates the location of any errors, along with messages explaining the errors. The Source Listing file name is the same as the JSL name, except that it has a .LST extension.
- **Resource Listing file:** Contains a list of the resources that are specified in the JSL, such as font names and form names. The Resource Listing file name is the same as the JSL name, except that it has a .RSC extension.
- **Log file:** Contains all messages that were displayed on the screen during compiling. This file is appended each time XJDC is invoked, and it is placed in the following directory:

`/opt/XRXnps/XRXxjdc/data/`

The Log file name is “XJDC.LOG.”

Correcting errors in a JSL

If errors are encountered in a JSL while it is being compiled, the following message appears in the Terminal window:

```
*****JSL CONTAINS ERROR(S)*****
```

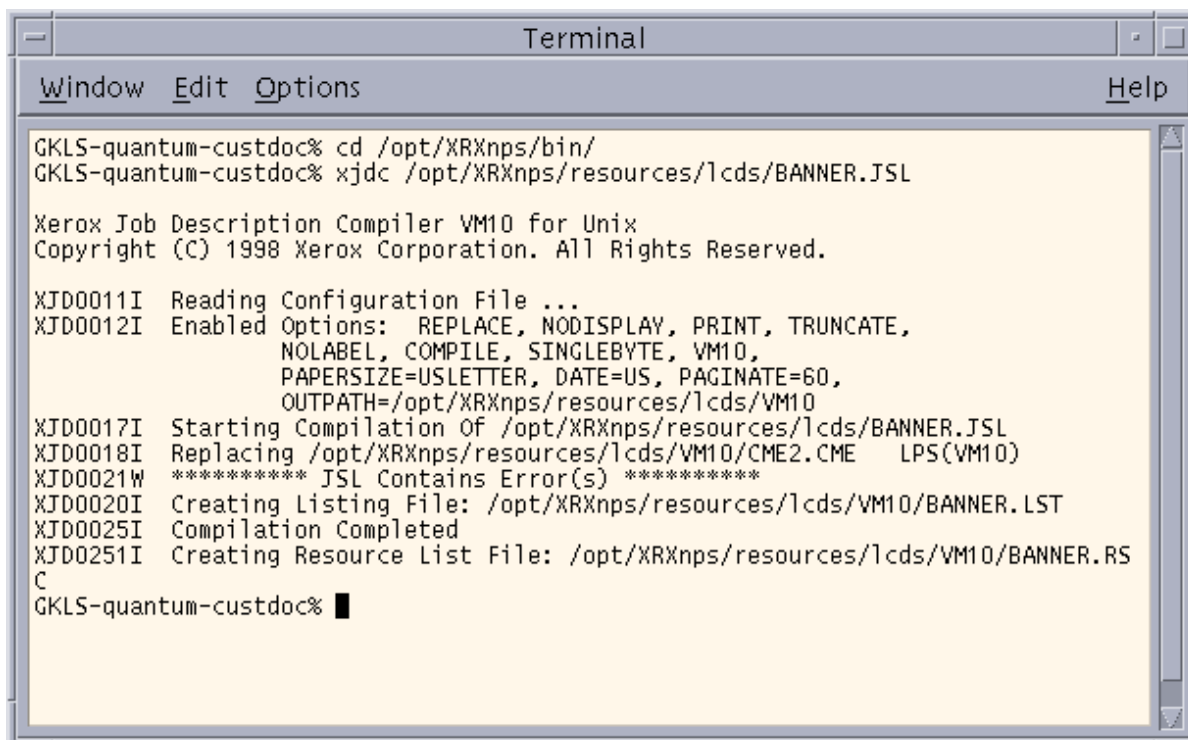
A screenshot of a terminal window titled "Terminal". The window has a menu bar with "Window", "Edit", "Options", and "Help". The terminal output shows the following commands and messages:

```
GKLS-quantum-custdoc% cd /opt/XRXnps/bin/  
GKLS-quantum-custdoc% xjdc /opt/XRXnps/resources/lcds/BANNER.JSL  
  
Xerox Job Description Compiler VM10 for Unix  
Copyright (C) 1998 Xerox Corporation. All Rights Reserved.  
  
XJD0011I Reading Configuration File ...  
XJD0012I Enabled Options: REPLACE, NODISPLAY, PRINT, TRUNCATE,  
NOLABEL, COMPILE, SINGLEBYTE, VM10,  
PAPERSIZE=USLETTER, DATE=US, PAGINATE=60,  
OUTPATH=/opt/XRXnps/resources/lcds/VM10  
XJD0017I Starting Compilation Of /opt/XRXnps/resources/lcds/BANNER.JSL  
XJD0018I Replacing /opt/XRXnps/resources/lcds/VM10/CME2.CME LPS(VM10)  
XJD0021W ***** JSL Contains Error(s) *****  
XJD0020I Creating Listing File: /opt/XRXnps/resources/lcds/VM10/BANNER.LST  
XJD0025I Compilation Completed  
XJD0251I Creating Resource List File: /opt/XRXnps/resources/lcds/VM10/BANNER.RS  
C  
GKLS-quantum-custdoc% █
```

Figure 1-20. Terminal window displaying compiling messages for a JSL with errors

The system does not create a .JDL file in the “lcds” folder, but it does create a .LST file, which shows where the errors are.

1. Open and inspect the .LST file to locate the errors that prevented the JSL from compiling.

To open a .LST file:

- a. Open a UNIX Text Editor window. Refer to the “Full JSL coding procedure” earlier in this chapter for instructions.
- b. From the File menu on the Text Editor window, select [Open] to display the Text Editor – Open a File window.

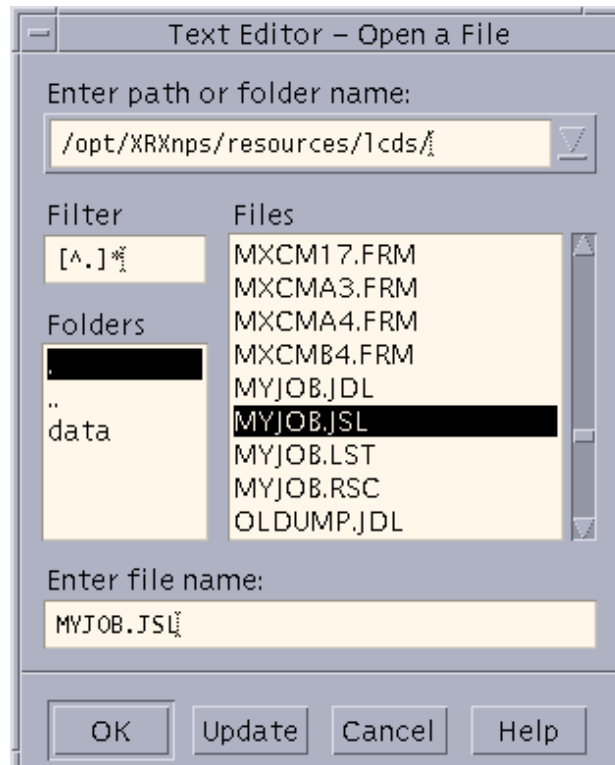

Figure 1-21. Text Editor – Open a File window

- c. In the Folders field, double-click the name of each of the folders that comprise the path to the “lcds” folder, in the order shown below:

`/opt/XRXnps/resources/lcds`

- d. In the Files field of the Open a File window, click the name of the .LST file for the JSL you attempted to compile; or
In the Files text field on the Open a File window, enter the name of your .LST file. The name syntax is as follows:

`JSLNAME.LST`

- e. Click [OK] on the Open a File window. The .LST file appears in the text window. This file contains the following:
- The JSL as you coded it, but with the lines and columns numbered
 - Below each line that contains errors, a message that explains each error that is on the line
 - The <<<<<<< symbol at the end of each error message line.

```

Text Editor - BANNER.LST
File Edit Format Options Help
BANNER.JSL Compiled By XJDC(VM10) For LPS(VM10) At 11:15:45 On Nov-19-99 1
Release Date: Nov-19-99
.....1.....10.....20.....30.....40.....50.....60.....70.

1 BANNER.JDL: JDL
2
3 /* COMMANDS WITH IDENTIFIERS */
4
5 VFU1: VFU ASSIGN=(1,11), ASSIGN=(12,66), TOF=11, BOF=66;
XJD0059E Bad Character Detected, Str = V, COL= 1. <<<<<<<<
XJD0052W PDL Skipping... <<<<<<<<
6 VFU2UP: VFU ASSIGN=(1,(11,77)), ASSIGN=(12,(66,132)), TOF=11, BOF=13
XJD0052W PDL Skipping... <<<<<<<<
7 VFU3: VFU ASSIGN=(1,1), TOF=1, BOF=132;
XJD0052W PDL Skipping... <<<<<<<<
8
9 PDE1: PDE BEGIN=(0.18 IN, 0.66 IN), FONT=(L0112B, L01B0A), PMODE=P
XJD0071E Invalid Option, Str = PORTRAI, COL=63. <<<<<<<<
10 PDE2: PDE BEGIN=(1.03, .51), BEGIN=(6.3, .51), FONTS=P1012A, PMODE
XJD0061E Invalid Parameter Keyword (Left Part), Str = PDE2, COL= <<<<<<<<
.... 1. <<<<<<<<
11
12 CME1: CME LINE=(9,-), POS=1, FONT=1;
13 CME2: CME LINE=3, POS=59, CONSTANT='FIRST QUARTER';
XJD0018I Replacing /opt/XRXnps/resources/lcds/VM10/CME2.CME LP <<<<<<<<
.... S(VM10) <<<<<<<<

```

Figure 1-22. A .LST file for a JSL containing errors

2. Open another Text Editor window and display your JSL in this new window. (The procedure for displaying the JSL is described under “Opening a file in the Text Editor,” above.)
3. Enter the indicated corrections to your JSL, referring to the .LST file in the other Text Editor window as needed.
4. On the Terminal window, recompile the corrected JSL, using the compiling procedure that is described earlier in this section.

Dynamic job descriptor entries (DJDEs)

Dynamic job descriptor entries (DJDEs) are parameters embedded within the input data stream. DJDEs modify the printing environment established by a job descriptor entry (JDE) as the job is printing. Dynamic job descriptor entry processing allows certain JDE parameters to be changed for individual pages or records.

The IDEN command, coded in a JDE, notifies the system that DJDE records are included in the input data stream, specifies where the DJDEs commands are embedded in the data record, and specifies how to identify the DJDE records.

Benefits of using DJDEs

There are several reasons to use DJDEs to change job parameters:

- The printing system does not need to stop between reports nor does it require operator intervention. The operator starts a job on the printing system and typically returns to the system for minor operational activity only.
- Forms may be changed on specific pages.
- Many variations on VFU channel, margin, Top Of Form (TOF) and Bottom Of Form (BOF) assignments may be applied to reports as they are created instead of being stored in the printing system in JDL files. This dynamic processing reduces the number of JDEs that need to be maintained.
- DJDEs can be used to satisfy unusual processing requirements more easily.
- Varying numbers of copies can be generated automatically with routing or distribution notification sent to the operator.
- Print resources (such as forms and fonts) or nonprint data can be downloaded onto the system disk through the print data stream.

Dumps

The dump feature is a troubleshooting tool for print jobs. It allows you to generate a hardcopy of the command and data transmission between the host computer or the magnetic tape and the printing system while a job is being transmitted and printed.

Online dump

The online dump provides a printout of all the command and data transmission taking place between the host computer and the printing system.

Starting and ending online dump sessions

To print a dump of an online job you wish to troubleshoot, follow these steps:

1. Specify the DFLT JDE and the OLDUMP JDL on the Online Job Manager window at the print server. (The OLDUMP JDL, which was loaded on your system at installation, contains the VOLUME HOST=OLDUMP and CODE=EBCDIC commands as well as the DFLT JDE.)
2. Run the job you intend to troubleshoot.
3. Terminate the dump session by clicking the End button on the Online Job Manager window.

Online dump format and content

Each host command directs the printer to perform an operation or provides control information used during printing. The control information could be printed with carriage control only or printer control, such as load FCB. All print commands and some control commands transmit data to and from the printing system. The dump format for each of these commands contains a HEADER and DATA segment. The HEADER segment consists of the fields shown in the following table.

Table 1-13. Print format command usage for online dump

Field	Definition
HOST COMMAND	The English translation of the host command in hexadecimal.
END STATUS	One byte of status in hexadecimal transmitted to the host.
SEQ#	Incremental count in decimal of the host commands received during a dump session. The maximum number is 999,999.
LENGTH	Length in decimal of the data transmitted.
DATE and TIME	Date and time when the host command was received by the dump processor. The time includes tics of seconds, where one tic is approximately one millisecond.

The DATA segment consists of the input data in hexadecimal transmitted from the host and printed in hexadecimal and ASCII. The data is translated based on the value specified in the CODE command.

Restrictions for online dumps

Online dumps have the following restrictions:

- DJDEs, BANNER, and other logical processing functions are not processed when the dump job is running.
- Hardware errors are reported in the system error log, but are not dumped due to host, OLI, or driver interface constraints.
- Commands processed when input is stopped, as when paper trays become empty, are not dumped.
- Print records that are longer than the RECORD LENGTH parameter value that is specified in the online dump (OLDUMP) JDL are truncated without warning. If records longer than 150 bytes are to be sent, the RECORD LENGTH parameter in the OLDUMP JDL should be modified to the longer length.

Offline dump

The offline tape dump feature is a troubleshooting tool for tape jobs. It allows you to generate a hardcopy printout of all the characters, carriage control information, channel status, tape labels, and other information in the data stream, while a job is being transmitted and printed.

Starting and ending tape dump sessions

To print a dump of an offline job you wish to troubleshoot, follow these steps:

1. Specify the DFLT JDE and the DUMP JDL on the Tape Client window at the print server. (The DUMP JDL, which was loaded on your system at installation, contains the VOLUME HOST=DUMP and CODE=EBCDIC commands as well as the DFLT JDE.)
2. Run the job you intend to troubleshoot.
3. Terminate the dump session by clicking the End button on the Tape Client window.

Offline dump format and content

Each command directs the printer to perform an operation or provides control information used during printing. The dump format for each of these commands contains a HEADER and DATA segment.

- If a tape read error occurs while the system is reading the tape for the dump, and the system skips the block containing the error and continues reading the tape, the error is indicated in the dump following the problem block.
- When the system encounters a tape mark while formatting for the dump, the tape mark is indicated following the block number.
- The dump of each block, tape mark, error status, end of volume, or end of data is separated by at least one blank print line.

The tape data stream dump contains the following information for each block that is dumped:

- Block number
- Block length
- The decimal number of the starting byte in each printed line of data
- The data printed in hexadecimal
- The data printed using the translation code table that is defined in the VOLUME CODE command.

Compatibility with other Xerox laser printing systems that use PDL

Your FreeFlow Print Server LCDS system is able to process print jobs that use JSLs with some commands for functions that the system does not support. For example, the system processes Xerox 4850, 4890, and DP92 HighLight Color LPS print jobs that contain ink references; it disregards color commands and prints the job in black. The FreeFlow Print Server LCDS systems also print all 4050, 4090, 4650, DP96, DP180, and 4635 LPS applications successfully.

The functions of the various Xerox laser printing systems are listed in the following compatibility table.

Table 1-14. Software version compatibility

JDL source file downloaded to:	V3.5: 4050 4090 4650	V3.6 4135	V3.7: 4850	V3.8: 4050 4090 4650	V3.9: 9790 8790	V4.0 & 5.0: 4850 4890 DP92C	V3A: 4635	VM10: DP180 LPS DP180 MX	DocuSP 3.7: DP EPS DP 75 MX DP 100/115/ 135/155/180 MX
Compiled in V3.5	1	1	1	1	1	1	1	1	9
Compiled in V3.6	2	1	2	3, 5	2	3, 5	1	1	9
Compiled in V3.7	2	4	1	4	2	1	4	4	4, 9
Compiled in V3.8	2	4	6	1	2	1	4	4	4, 9
Compiled in V3.9	2	1	2	2	1	2	1	1	9
Compiled in V4.0/5.0	2	4, 7, 8	6, 7, 8	4, 7, 8	2	1	4, 8	4	4, 9
Compiled in V3A	2	2	2	2	2	2	1	1	9
Compiled in XJDC 4.0	2	2	2	2	2	2	1	1	9
<ol style="list-style-type: none"> 1. Performs as expected. 2. Commands unique to this software release are not supported. Unpredictable results occur in printing. 3. Commands unique to this software release are not supported. However, an error message is displayed, unique commands are ignored, and the job prints. 4. Job prints in black only. 5. Paper size not supported by the printer. Causes job to abort. 6. RFEED command is not supported. 7. LOGO command in JSL is not supported. 8. Extended CRITERIA and VCODE are not supported. 9. Certain commands and/or parameters are not supported. The commands are processed by the Compiler, but are ignored by the printer. (Refer to the "PDL command and DJDE summary" in Appendix A to find out which commands are and are not supported on the different printers.) 									

Printing highlight color applications on FreeFlow Print Server LCDS systems

If you have a Xerox 4850, 4890, or DP92C HighLight Color LPS, or the FreeFlow Print Server-based Xerox DT128/155/180 HLC Printing System, your applications probably include the use of highlight color (one color plus black). The JDLs used to print these applications contain commands and parameters that specify the location and the color ink to be used. These color JDLs may also contain commands indicating what the system should do if a JDL specifies a different color ink from what is loaded in the printer.

The FreeFlow Print Server LCDS systems can print jobs that were designed for the 4850, 4890, or DP92C LPS and contain color commands. When you run a highlight color job on non-highlight-color systems, the job prints in black ink. (Some solid colored or shaded areas may print in various shades of gray.)

The following table lists the highlight color related PDL commands, parameters, and DJDEs.

Table 1-15. Highlight color commands

Command	Color parameter	DJDE available?
ABNORMAL	IMISMATCH	No
	ISUBSTITUTE	No
CME	INKS	No
IDR	ICATALOG	Yes
	ILIST	Yes
	PALETTES	Yes
LINE	INKINDEX	Yes
LMODIFY	INK	No
	SELECT	No
	TEST	No
OUTPUT	FORMS	Yes
	GRAPHICS	Yes
	IDFAULT	Yes
	IDR	Yes

**Table 1-15. Highlight color commands
(Continued)**

Command	Color parameter	DJDE available?
	IRESULT	Yes
	LOGO	Yes
	NUMBER	Yes
	XMP	Yes

For detailed information on the syntax and use of these PDL commands and DJDEs, refer to the *Print Description Language Reference* for your 4850/4890 or DP92 HighLight Color LPS.

Downloading highlight color JDLs to your FreeFlow Print Server

You can download color JDLs to your FreeFlow Print Server LCDS systems. When compiled on a Xerox 4850, 4890, or DP92, these JDLs can then be used on the FreeFlow Print Server, the 4850/4890 LPS, or the DP92C LPS. Any inks that you specified in the JSL are replaced by black ink when printed on monochrome FreeFlow Print Server-based LCDS systems; however, they print in the specified inks on your 4850, 4890, or DP92C HighLight Color LPS as well as the Xerox DT 128/155/180 HLC.

HighLight color LPS forms

Because the FreeFlow Print Server LCDS systems do not have a forms compiler, you cannot compile forms or form source libraries (FSLs) at your print server. Forms for FreeFlow Print Server LCDS jobs may be created on your FreeFlow Print Server, but they must be compiled at another Xerox LPS. After they are compiled, forms can be copied to the FreeFlow Print Server LCDS system disk from tape, CD, or diskette; or they can be downloaded from the host using File Transfer Protocol (FTP) or the FILE DJDE.

The FreeFlow Print Server LCDS systems can print forms that were created in color. It is important to note that forms need not contain color unique forms source library (FSL) commands in order to be classified as colored forms. You can generate them by the following methods:

- Compiling the FSL using the 4850/4890 or DP92C HighLight Color LPS Forms Description Language (FDL) compiler
- Converting the monochrome form to color with the File Conversion Utility (FCU) resident on the 4850, 4890, or DP92C HighLight Color LPS

- Downloading to the FreeFlow Print Server LCDS systems colored forms that were created with host or third party vendor software packages.

Refer to the *Forms Creation Guide* for the 4850/4890 or DP92C HighLight Color LPS for detailed information on creating and using highlight color forms.

Points to note for colored forms:

- Light tints with isolated pixels of color that print on the Xerox 4850, 4890, or DP92C LPS may not be visible on the FreeFlow Print Server LCDS system.
- Colored text printed over a solid black or gray background, or black text printed over solid colored or shaded backgrounds, may not be visible when printed on the FreeFlow Print Server LCDS system. Be especially careful in using this format, because it does not generate displayed or printed messages.
- 600 dots per inch (dpi) tints and shades printed on FreeFlow Print Server LCDS systems are finer and more uniform than 300 dpi tints and shades printed on the 4850, 4890, or DP92C HighLight Color LPS.

Other Xerox monochrome LPS jobs

You can create JSLs for the FreeFlow Print Server LCDS systems on all of the following Xerox families of monochrome laser printing systems:

- 4050, 4090, and 4650 LPS
- 8700, 8790, 9700, and 9790 LPS
- 4135, 4635, DP96, and DP180 LPS

You can then compile these JSLs on your FreeFlow Print Server LCDS system for printing.

2. Specifying input parameters

Input data is processed and temporarily written to disk for subsequent printing under control of user selected PDL commands.

The input processor decodes and formats input data online from a host attached channel interface or a remote communication, and offline from magnetic tape via the Tape Client.

Input data streams

The FreeFlow Print Server LCDS systems receive data online, over a channel or through Ethernet using TCP/IP. They also print offline from magnetic open reel and cartridge tapes. The print server supports submission of the following data streams:

- PostScript
- PCL
- ASCII (converted to PostScript by the print server)
- TIFF (converted to PostScript by the print server)
- LCDS
- PDF (converted to PostScript by the print server)

PostScript, PCL, and LCDS each has its own decomposer on the print server, and the print server supports page description commands for each page description language. Print Description Language is a type of page description language, which is used only with the LCDS data stream.

Input processing functions

The following functions are part of input processing on the FreeFlow Print Server LCDS systems.

Input processing online

For online printing, the LCDS data is transmitted from a host computer either directly or through a protocol converter. The FreeFlow Print Server LCDS systems receive print data either over a channel through bus and tag cables, or through the Socket Gateway or lpr using TCP/IP protocol.

The LCDS data stream emulates the IBM 3211 or 4245 line printer format. All commands coded for the 3211 may be coded for the 4245. In online 3211 mode, the data stream emulates an IBM 3211 line printer format, with or without embedded DJDEs.

Basic input processing functions are augmented by the following functions for online 3211 or 4245 mode operations:

- Handling all interactions with the online interface hardware.
- Building translate tables based on the present contents of the current FOLD or UNFOLD command that is in effect.
- Processing form control buffers (FCBs) that are received from the host to redefine channel to line number assignments.

Specifying DJDE processing online

Online printing is controlled through parameters from a user defined .JDL file. You can dynamically override these parameters by Dynamic Job Descriptor Entries (DJDEs).

The DJDEs that you specify are processed by the system as part of the input print data from the host. The IDEN command enables the system to identify DJDEs as commands and not part of the input data. Refer to the “IDEN command” section later in this chapter for information on the use and parameters of this command.

Nonprint files, such as font files, can be downloaded from the host using the FILE command. Refer to “FILE DJDE” in the “Using Dynamic Job Descriptor Entries (DJDEs)” chapter of this guide.

- Report separation** The two logical processing commands that can control report separation online are BANNER and RSTACK. The BANNER command specifies the detection criteria for traditional spooler banner pages and their associated report boundaries. The RSTACK command is used to detect other types of report boundary indicator records called RSTACK records.
- NOTE: After reports are processed they are managed and printed as jobs.*
- (See also “Using logical processing,” in which these commands are described.)
- Record length** The default record length for online systems is 150 bytes. However, you may choose larger record lengths with the following restrictions:
- If the data record transmitted from the host exceeds the value that is specified in the RECORD LENGTH parameter of the initial JDL, the record is truncated to the length that was specified in the initial JDL, and no warning is provided. (This action is consistent with IBM 3211 or 4245 printers.)
 - The online dump JDL specifies a record length of 150 bytes. If you use a longer record length, modify the JSL to dump the data accurately.
- To select a record length longer than 150 bytes, you must specify the new value for the RECORD LENGTH command. You must also modify the LINE DATA to print the extended character or record length.
- Using the VOLUME HOST command for online printing** One PDL command that must be specified for normal online processing is VOLUME HOST=IBMONL. The HOST parameter of the VOLUME command performs two functions:
- Allows the printer to accept data from the online host
 - Allows PDL to use a different set of defaults for the RECORD and LINE commands.
- Refer to the “VOLUME HOST” parameter section later in this chapter for additional information.
- Online recovery** After a system failure, data acquired from the host and stored on system disk is imaged upon system restart. Only data that was being received at the time of the power failure is lost and must be retransmitted.

In the event of a power failure, the system notifies you if you need to retransmit any data, and which records to resend.

Downloading resource files from the host to the printer

You can download resource files such as forms, fonts, JSLs, and so forth, by using the FILE DJDE.

The FILE dynamic job descriptor entry (DJDE) transfers files while normal printing activity is taking place. However, you may need to precondition the file that you want to transfer, by adding a delimiter at the end of each record to prevent truncation of trailing blanks by the host spooler. The FILE DJDE loads card image files from the data stream to the printing system disk while a printing job is in progress. Refer to “Offline specifications,” Appendix D, in this guide for information on the format of LPS labeled tapes.

The FILE DJDE is record oriented and is applied immediately. It can be included with other record oriented or page oriented DJDEs in a DJDE packet. Refer to “FILE DJDE processing” in the “Using Dynamic Job Descriptor Entries (DJDEs) for further information on using the FILE DJDE.

Forms control buffer (FCB) and vertical format control processing

The 3211 and 4245 forms control buffer (FCB) defines channel positions and forms length. You may restrict the forms control buffer information by accepting or suppressing the normal processing of host transmitted FCB input. To suppress processing of FCB input, specify FCB=IGNORE in the LINE command.

The vertical format unit (VFU) in the JSL and the FCB sent from the host interact as follows:

- When you start a job, the VFU table and its associated Bottom of Form (BOF) in the JDE become active.
- If no VFU is specified in the JDE, the last FCB sent from the host becomes active.
- When a DJDE is used to change a channel assignment, any previous assignments to the channel being changed are suspended until the end of report. At the end of report, DJDE changes are discarded and the last active FCB or VFU becomes active again.
- When operating system software is reinstalled or upgraded, the FCB saved on disk is reinitialized to the length of 66 lines with the following channel assignments:

Table 2-1. Default channel assignments made at installation

Channel	1	2	3	4	5	6	7	8	9	10	11	12
Line	4	10	16	22	28	34	40	46	52	58	64	66

The default corresponds to the STD2 default supplied by IBM.

- If a Print and Skip to Channel command is sent for an undefined channel, the system executes a Print and Space 1 command.

Print position indexing (non-U.S. markets only)

The print position indexing (PPI) byte determines whether lines should be shifted horizontally. If either the sixth bit or the seventh bit of the first byte in the loaded FCB is *on*, the byte is a PPI byte, and the lower five bits indicate the amount of shift.

For example, if the first byte is 0 x 48 (01001000), each line shifts seven ($0x48 \wedge 0x1f - 1$) character spaces to the right (the sixth bit indicates that the shift is to the right).

- When the system is operating online in 3211 or 4245 emulation mode, forms control buffers (FCBs) are received from the host to redefine channel-to-line number assignments and to set margins based on the print position indexing byte.
- If the print position indexing (PPI) byte of the FCB is enabled, it is not suppressed by FCB=IGNORE. If an FCB with a PPI byte is received, indexing is invoked; if an FCB without a PPI byte is received, indexing is turned off (even if FCB=IGNORE).

CAUTION

Use of the PPI byte to shift the starting print position may cause problems in recognition of both DJDEs and banner pages.

- On the FreeFlow Print Server LCDS system, the maximum record length is 12288 bytes. This limit is not influenced by print position indexing. However, on other LPS systems, you should not use PPI for print record lengths from 151 bytes to 214 bytes.

Example of an online JSL

The following figure shows an example of an online JSL that contains several input processing commands. This JSL would be used only for printing a job sent from a host over a channel or through a TCP/IP gateway.

Table 2-2. Example of an online JSL

```
ONLINE:  JDL;
VFU1:    VFU      ASSIGN=(1,4), ASSIGN=(2,10),
          ASSIGN=(3,16), ASSIGN=(4,22),
          ASSIGN=(5,28), ASSIGN=(6,34),
          ASSIGN=(7,40), ASSIGN=(8,46),
          ASSIGN=(9,66), ASSIGN=(10,52),
          ASSIGN=(11,58), ASSIGN=(12,64), TOF=1,
          BOF=66;

/*Tables and criteria */
T1:      TABLE   MASK='?', CONSTANT='HE?DE? PAGE';
C1:      CRITERIA CONSTANT=(1,11,EQ,T1), LINENUM=(1,10);
T2:      TABLE   CONSTANT='TRAILER PAGE';
C2:      CRITERIA CONSTANT=(0,12,EQ,T2), LINENUM=(1,10);
```

Table 2-2. Example of an online JSL (Continued)

```

T3:      TABLE      CONSTANT='EOJ' ;
C3:      CRITERIA    CONSTANT=(0,3,EQ,T3), LINENUM=(1,20) ;
T4:      TABLE      CONSTANT='//JOB' ;
C4:      CRITERIA    CONSTANT=(0,6,EQ,T4), LINENUM=(1,20) ;
T5:      TABLE      CONSTANT=(10)'*' ;
C5:      CRITERIA    CONSTANT=(0,10,EQ,T5), LINENUM=(50,10) ;
        VOLUME      HOST=IBMONL, OPTIMIZE=(NCC) ;
        LINE        PCCTYPE=IBM3211, VFU=VFU1, FCB=IGNORE ;
        ACCT        USER=BIN ;
        IDEN        PREFIX='DJDE' SKIP=7, OFFSET=2, OPRINFO=YES ;
/* Jobs with no banner pages */
        DFLT:       JOB ;
/* Jobs with header pages only */
        HDRP:       JOB ;
        BANNER      TEST=C1, HCOUNT=2, TCOUNT=0 ;
/* Jobs with trailer pages only */
        TRLP:       JOB ;
        BANNER      TEST=C2, HCOUNT=0, TCOUNT=3 ;
/* Jobs with header and trailer pages */
        BOTH:       JOB ;
        BANNER      TEST=(C1 OR C2), HCOUNT=2, TCOUNT=3 ;
/* OTHER JOBS */
        EOJ:        JOB ;
        BANNER      TEST=C3, TCOUNT=1 ;
        JOB:        JOB ;
        BANNER      TEST=C4, HCOUNT=1 ;
END ;

```

Input processing offline

For offline operations, the input medium to the printing system is magnetic tape, which may be recorded in one of a variety of standard vendor formats. Offline printing is handled by the Tape Client software, which is an optional part of the FreeFlow Print Server system software.

To submit a tape job, you set up the job on the Tape Client window on the print server and click [START]. The job is submitted to the printer through the Socket or LPR gateway. Refer to the *Tape Client Job Submission Guide*, delivered with your system, for job setup and submission procedures.

As a programmer, you define the tape input deblocking and record format parameters that reduce physical tape blocks first to logical records, then to print lines.

You can also select special processing commands that facilitate report processing by performing logical functions on the input data.

Before selecting the PDL commands that will describe a specific job tape, you need to understand certain tape structure concepts. These concepts enable you to define job tape characteristics such as host format, block and record structure, tape translation code, packed data formats, and so forth.

Host computer tape formats

The printing system processes input tapes produced by those standard hosts that are discussed in Appendix D, "Offline specifications," in this manual. The HOST parameter of the VOLUME command enables you to select a specific input tape. The format of each tape is described in the *Xerox LPS Tape Formats Manual*, which is delivered with your printing system.

Tape codes

Tape codes that are recognized by the FreeFlow Print Server LCDS systems are EBCDIC, ASCII, and several versions of BCD. If these codes are not sufficient for a particular tape, you may create a new code translation table or modify (customize) an existing code translation table. Tables that show the correspondence between standard recording codes and printed characters are in Appendix C, "Character code assignment tables," in this manual. Within a JDL, tape codes are selected by the CODE parameter of the VOLUME command.

Packed data formats

Six bit characters may be written onto a 9 track or 36-track tape in a 4-by-3 packed (or compressed) format. That is, four 6 bit data bytes are compressed into three 8 bit data bytes. Two methods of packing these bits together exist.

Whenever an unpacking method is included in the JDL, the system unpacks the characters before data processing. Each 6-bit character is extracted, and two high-order zeros are appended. Normally, after data is unpacked, it must be translated. The character code set is defined in the CODE parameter of the VOLUME command. For a 4-by-3 unpacking method, the data is generally encoded in BCD, and one of the three standard BCD CODE parameters (H2BCD, H6BCD, and IBMBCD) can be used.

Appendix D, "Offline specifications," shows an example of how 6 bit characters that are packed in the T4X3 or T4X3H2 method are unpacked and then translated to ASCII by the system.

Record formats

All tape records input to the printing system are either blocked or unblocked with a fixed length, a variable length, or an undefined format. The BLOCK and RECORD commands define the format of the input data. Tape label contents may also describe blocking and record structure, and in some cases they override BLOCK and RECORD commands that are specified in the JDL source file. These labels are described in this chapter and in the *Xerox LPS Tape Formats Manual*.

Record structure

A record is arbitrarily divided into two portions: operating system and user.

- The operating system portion of the record contains information that is supplied by the host operating or spooling system.
- The user portion of the record contains information that is provided by the application or the program that is running on the host system.

The boundary between the two portions of the record is traditionally between the record length and the printer carriage control (PCC) fields. If there is no record length field, there is no operating system portion of the record. The PDL commands that define the components of a record are described in the “RECORD command” section of this chapter.

Multivolume processing

All multivolume reports that force the system to make multiple passes over the data are handled in the following manner:

- For each copy that is requested, a complete pass is made over the group of volumes that make up the current report. The system is forced to make multiple passes over the input data for multicopy reports that exceed the size of the print file. Refer to your printing system online Help for information on the available choices for handling print file saturation.
- If a multivolume report requires multiple passes, messages appear on the print server screen with instructions on which action must be performed next.
- Users with multiple volume jobs and multiple laser printing systems may wish to print each volume on a separate system. This requires that each volume be processed independently. Refer to the “VOLUME EOVS” parameter section, later in this chapter, for a discussion of this processing.
- If a system rollover occurs while a multivolume report is being processed, the print server screen (as a portion of the recovery process) displays a message that tells you to click [Continue] to space forward to the recovery point.

As before, volume 1 is the start-of-job, and the volume specified by n is the volume that contains data for the last page that was written to the print file before the system rollover.

Input processing command descriptions

The basic PDL commands to control input processing are CODE, PCC, RECORD, SEFFNT, TCODE, and VOLUME, which are defined here. The “Using logical processing” section defines commands that specify logical functions that may be performed on either a record or page basis.

The input related PDL commands are summarized in the following table.

Table 2-3. Summary of PDL commands associated with input processing

Command	Function
BLOCK command	Describes input block characteristics
CODE command	Defines the input character code translation table.
DBCOD command	Defines an input double-byte character code translation table.
IDEN command	Indicates that the report contains DJDEs.
KCOD command	Defines an input double-byte character code translation table.
PCC command	Defines printer carriage control table.
RECORD command	Specifies the input data record characteristics.
SEFFNT command	Defines font mapping for short edge feed jobs.
TCOD command	Defines masked comparison type assignments for translation.
VOLUME command	Specifies input medium characteristics.

BLOCK command

The BLOCK command defines block length characteristics and recording modes for offline data sources.

BLOCK command parameters

The following table summarizes the BLOCK command parameters.

Table 2-4. Summary of BLOCK command parameters

Parameter	Specifies	Offline	Online	DJDE
BLOCK ADJUST	Specifies the adjustment value that is added to or subtracted from the content of the block length field.	Y	N	N
BLOCK CONSTANT	Specifies that the block delimiter constant and all subsequent data are ignored until the end of the block.	Y	N	N
BLOCK FORMAT	Specifies the length field recording mode.	Y	N	N
BLOCK LENGTH	Specifies the maximum block size.	Y	N	N
BLOCK LMULT	Specifies a multiplication factor to determine block length.	Y	N	N
BLOCK LTHFLD	Specifies the length of field that contains the block length specification.	Y	N	N
BLOCK OFFSET	Specifies the location of the block length field.	Y	N	N
BLOCK POSTAMBLE	Specifies the length of extraneous data at the end of the block.	Y	N	N
BLOCK PREAMBLE	Specifies the length of the operating system portion of block	Y	N	N
BLOCK ZERO	Specifies that the criterion test for the end of the block is 0.	Y	N	N

The following sections describe the syntax of the BLOCK command parameters and explain their options.

BLOCK ADJUST

Specifies a block adjustment value that is added to, or subtracted from, the contents of the block length field to determine the true block length. Refer to the “BLOCK LENGTH” parameter section for further information.

Syntax BLOCK ADJUST = *value*

Options

Table 2-5. BLOCK ADJUST parameter options and definitions

Option	Definition
<i>value</i>	Specifies the block adjustment length. This length is a constant integer that is added to or subtracted from the value in the block length field of every tape block. The resulting value is the true block length. The range for a value is -127 to 127 and must be less than the block LENGTH parameter. A plus (+) or minus (-) character may be used to specify a positive or negative adjustment value.

Default 0

BLOCK CONSTANT

Specifies that the block delimiter constant *sc* and all data following it are ignored until the end of the block is reached.

Syntax BLOCK CONSTANT = *sc*

Options

Table 2-6. BLOCK CONSTANT parameter options and definitions

Option	Definition
<i>sc</i>	(<i>String constant</i>) A string (hexadecimal, octal, or character) constant as described under “Coding a JSL.” The length of the constant must be from one to four bytes.

Default No default

BLOCK FORMAT

Specifies the recording mode of the block length field.

Syntax BLOCK FORMAT = *type*

Options

Table 2-7. BLOCK FORMAT parameter options and definitions

Option	Definition
<i>type</i>	Type of recording mode of the block length field. The following types are available: <ul style="list-style-type: none"> • BIN (binary) • DEC (decimal) • PACK (packed with no sign) • PKSG (packed with sign)

BLOCK LENGTH

Specifies the longest physical block that is being processed.

Syntax BLOCK LENGTH = *value*

Options

Table 2-8. BLOCK LENGTH parameter options and definitions

Option	Definition
<i>value</i>	Specifies the length, in bytes, of the longest physical block (an integer in the range 12 to 24,576 bytes).

Default 1330

**BLOCK LENGTH
parameter: points
to note**

- The maximum block size that may be processed (up to 24,576 bytes) depends on the available task memory and the processing features that are invoked. The Tape Client is able to allocate at least one input buffer for offline tape jobs when the tapes are written in maximum size blocks.
- The LENGTH parameter may be overridden by ANSI or IBM OS/Standard labels that specify block length.

- If a block length is specified that is less than the minimum block length that is found on the tape, the system allocates input buffers, which are sized to the minimum tape block length. It is wise to specify the maximum block length in the JSL, so that input buffers are large enough to handle the largest block. However, specifying the maximum block length in the JSL may slow performance. If the actual tape block length is smaller than the JSL block length, no error message is reported; otherwise, an error is displayed.
- The length on a 4 by 3 packed format tape is the number of 6-bit bytes or characters in the tape block.

BLOCK LMULT

Specifies a multiplication factor that is applied to the contents of the block length field to determine the true block length.

Syntax BLOCK LMULT = *value*

Options

Table 2-9. BLOCK LMULT parameter options and definitions

Option	Definition
<i>value</i>	An integer in the range of 1 to 15 that is multiplied by the value in the length field (refer to LENGTH parameter) to compute the number of bytes in the block.

Default 1

BLOCK LTHFLD

Specifies the length of the field that contains the block length.

Syntax BLOCK LTHFLD = *size*

Options

Table 2-10. BLOCK LTHFLD parameter options and definitions

Option	Definition
<i>size</i>	An integer from 0 to 5 that specifies in bytes the length of the field that contains the block length.

Default 1

- BLOCK LTHFLD:**
point to note
- If the size is set to 0, the block length field is not considered to be part of the block; and the length of a block on the tape is the actual physical block length.
 - The LTHFLD parameter may be overridden if RECORD STRUCTURE is changed through tape label processing.

BLOCK OFFSET

Specifies the location of the block length field.

Syntax BLOCK OFFSET = *value*

Options

Table 2-11. BLOCK OFFSET parameter options and definitions

Option	Definition
<i>value</i>	Specifies the number of bytes that the block length field is offset from the first byte of the block. The value is an integer in the range 0 to <i>LENGTH-LTHFLD -1</i> .

Default 0

BLOCK POSTAMBLE

Specifies the length in bytes of the extraneous data at the end of each tape block, measured from the end of the block backwards to the end of the last logical record.

Syntax BLOCK POSTAMBLE = *length*

Options

Table 2-12. BLOCK POSTAMBLE parameter options and definitions

Option	Definition
<i>length</i>	An integer in the range of 0 to the block length that specifies the number of bytes that follow the last logical record to the end of each tape block.

Default 0

**BLOCK
POSTAMBLE**
parameter: points
to note

- If the block delimiter string constant is specified, the block postamble is ignored.
- The POSTAMBLE parameter may be overridden if RECORD STRUCTURE is changed through tape label processing.

BLOCK PREAMBLE

Specifies the length of the operating system portion of the block; that is, the byte offset from the first byte of a tape block to the first byte of the first logical record.

Syntax BLOCK PREAMBLE = *length*

Options

Table 2-13. BLOCK PREAMBLE parameter options and definitions

Option	Definition
<i>length</i>	An integer in the range of 0 to the block length that specifies the number of bytes from the first byte of the tape block to the first byte of the first logical record

Default 0

BLOCK ZERO

Specifies the End-of-block indicator.

Syntax BLOCK ZERO = {NO | YES}

Options

Table 2-14. BLOCK ZERO parameter options and definitions

Option	Definition
YES	Specifies that the end of a tape block is indicated by a value of 0 in the record length field (before applying the record length adjustment). Data that follows the record is ignored through the end of the block.
NO	Indicates that the end of a tape block is not indicated by a value of 0 in the record length field.

Default NO

BLOCK command: points to note

Note the following when using the BLOCK command:

- The values for LTHFLD, OFFSET, FORMAT, and PREAMBLE may be overridden if RECORD STRUCTURE is changed as the result of ANSI or IBM OS/Standard label processing.
- The length of the block delimiter constant should not be coded as the BLOCK POSTAMBLE. Both lengths are subtracted from the end of the block.
- The search for the block delimiter constant starts after the block preamble and proceeds forward to the first appearance of the constant.
- **Using online JDEs in offline JDLs:** An offline JDL statement set that modifies the system default values, specifically in the BLOCK or RECORD commands, may experience incorrect results if an online job (JDE) is running. In other words, if an online JDE is specified in an offline JDL that has changed the system default values of the BLOCK and RECORD command parameters, the job may not print correctly. You should separate and run online and offline jobs (JDEs) independently of each other.

CAUTION

If a block delimiter constant is positioned and is part of a record or block, the record or block is truncated. As a result, the data is not formatted as specified.

Block command example

The BLOCK command for the example in the following figure would be coded as follows:

```
BLOCK    LENGTH=351, OFFSET=2, ADJUST=0,  
         LTHFLD=2, PREAMBLE=8, FORMAT=BIN;
```

The following diagram shows sample values for BLOCK command parameters.

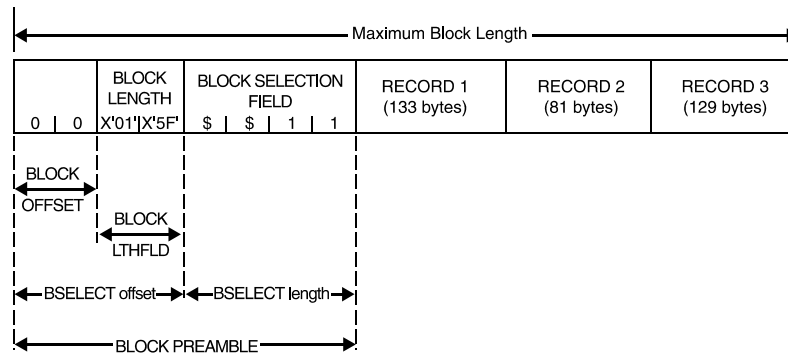

Figure 2-1. Sample BLOCK command diagram

CODE command

Defines a character code translation table.

When you require a user defined character code translation table, you define the character translation using this command, then reference the CODE command using the VOLUME CODE parameter. As an alternative, you can use the USER option of the VOLUME CODE parameter to reference the CODE command for which no identifier was provided.

ac identifier

A command identifier of the type *ac* is optional for the **first** CODE command within a JDE. Thereafter, each additional CODE command **must** include the identifier. The *ac* identifier consists of 1 to 6 alphanumeric characters (A through Z and 0 through 9). One of the characters must be alphabetic.

CODE command parameters

The following table summarizes the CODE command parameters.

Table 2-15. Summary of CODE command parameters

Parameter	Specifies	Online	Offline	DJDE
CODE ASSIGN	Defines user code assignments.	Y	Y	N
CODE DEFAULT	Specifies a base code from which character code assignment exceptions can be made.	Y	Y	N
CODE SPACECODE	Specifies the blank code for single-byte characters	Y	Y	N

The following sections describe the syntax of the CODE command parameters and explain the parameter options.

CODE ASSIGN

Defines user character code assignments.

Syntax *ac*: CODE ASSIGN = {(*input*, *output*) | (*input*, (*output*₁ [, *output*₂] [,...]))}

Options

Table 2-16. CODE ASSIGN parameter options and definitions

Option	Definition
<i>input</i>	Defines the input code.
<i>output</i>	Defines the output code, such as hexadecimal or decimal, that corresponds to the input code

CODE ASSIGN parameter: point to note

The output option is inherently ASCII, because LCDS character sets in most fonts are generally ASCII ordered. Therefore, hexadecimal characters in an EBCDIC string constant (such as E'13F') are converted to ASCII before being put into the code assignment table.

Hexadecimal output option strings (such as X'20'), as well as text string constants (for example, **a**), are not translated before being put into the code assignment table. Therefore, you should keep ASCII or, more precisely, the encoding of the fonts that will be used, in mind when you use hexadecimal strings.

Default No default

CODE DEFAULT

Specifies a base code from which you can make character code assignment exceptions.

The base code is specified by a *codetype*; the exceptions are specified in the ASSIGN parameter.

Syntax *ac*: CODE DEFAULT = {*codetype* | *value*}

Options

Table 2-17. CODE DEFAULT parameter options and definitions

Option	Definition
<i>codetype</i>	Can be one the following: <ul style="list-style-type: none"> • ASCII • BCD • EBCDIC • PEBCDIC • H2BCD • H6BCD • IBMBCD
<i>value</i>	A one byte hexadecimal, octal, or alpha constant. If a value is specified, all inputs are coded to that value.

Default Codetype: EBCDIC

**CODE DEFAULT
parameter: points
to note**

- The DEFAULT parameter must be coded **before** any ASSIGN parameter for the assignment exceptions to become active. A DEFAULT parameter following any defined ASSIGN parameters causes those ASSIGN parameters to be ignored.
- Multiple user defined character code translation tables are allowed, but only one may be without a command identifier.
 - The corresponding CODE and LCODE parameters of the VOLUME command are used to reference each user-created code table by a command identifier.
 - The USER option of the CODE and LCODE parameters of the VOLUME command references a user defined code translation table in which no command identifier is coded.

**CODE DEFAULT
parameter
examples**

Following are two examples illustrating the use of the CODE DEFAULT parameter.

Example 1

Assume that your input data is recorded in EBCDIC. On output, however, codes 5A, 5B, and 5C (characters !, \$, *, respectively), are assigned to the character blank (X'40'). The command to modify the EBCDIC base table is as follows:

```
CODE    DEFAULT=EBCDIC, ASSIGN=(X'5A', X'40'),
        ASSIGN=(X'5B', X'40'),
        ASSIGN=(X'5C', X'40');
```

Example 2 In this example, consecutive input codes, such as X'5B' and X'5C', need not be specified to accomplish code modification.

```
CODE2: CODE DEFAULT=EBCDIC,
        ASSIGN=(X'5A', (X'40',X'40',
        X'40'));
```

CODE SPACECODE

Defines the blank (space) character code for the single-byte character set.

Syntax *ac*: CODE SPACECODE = *spacecode*,

Options

Table 2-18. CODE SPACECODE parameter options and definitions

Option	Definition
<i>spacecode</i>	Defines the code for a blank space.

Default X'20'(CODE=ASCII), X'40'(CODE not ASCII)

CODE SPACECODE parameter: point to note SPACECODE must be specified **after** the DEFAULT parameter. If SPACECODE is specified before DEFAULT, the ***spacecode*** value is overwritten by X'20' or X'40'.
Hexadecimal output option strings (such as X'20'), as well as text string constants (for example, **a**), are not translated before being put into the code assignment table. Therefore, you should keep ASCII or, more precisely, the encoding of the fonts that will be used, in mind when you use hexadecimal strings.

DBC CODE command

Defines a double-byte character code translation table.
When you require a user defined translation table of double-byte character codes, you define the double-byte character translation using the DBCODE command, then reference this command using the VOLUME DBCODE parameter. As an alternative, you can use the USER option of the VOLUME DBCODE parameter to reference the DBCODE command for which no identifier was provided.

ac identifier A command identifier of the type *ac* is optional for the **first** DBCODE command within a JDE. Thereafter, each additional DBCODE command **must** include the identifier. The *ac* identifier consists of 1 to 6 alphanumeric characters (A through Z and 0 through 9). One of the characters must be alphabetic.

DBCODE command parameters

The following table summarizes the DBCODE command parameters.

Table 2-19. Summary of DBCODE command parameters

Parameter	Specifies	Online	Offline	DJDE
DBCODE ASSIGN	Defines user double-byte code assignments.	Y	N	N
DBCODE DEFAULT	Specifies a base code from which double-byte character code assignment exceptions can be made.	Y	N	N

The following sections describe the syntax of the DBCODE command parameters and explain the parameter options.

DBCODE ASSIGN

Defines double-byte character code assignment exceptions or an entire user character translation table.

Syntax *ac*: DBCODE ASSIGN = {(*input*, *output*) | (*input*, (*output*₁ [, *output*₂] [,...]))}

Options

Table 2-20. DBCODE ASSIGN parameter options and definitions

Option	Definition
<i>input</i>	A numeric constant that defines the input double-byte code.
<i>output</i>	A numeric constant that defines the output double-byte code that corresponds to the input code

Default No default

DBCOD DEFAULT

Specifies a base code from which you can make double-byte character code assignment exceptions.

The base code is specified by a *codetype*; the exceptions are specified in the ASSIGN parameter.

Syntax *ac*: DBCOD DEFAULT = *codetype*

Options

Table 2-21. DBCOD DEFAULT parameter options and definitions

Option	Definition
<i>codetype</i>	Keyword for one the following double-byte codes: <ul style="list-style-type: none"> • IBM: Specifies the IBM Nihongo character set (Kanji double-byte sets) • JEF: Specifies the Fujitsu JEF Kanji double-byte character set. • JIS • KEIS: Specifies the Hitachi KEIS Kanji double-byte character set

Default No default

DBCOD command: point to note

The KCODE command can be used in the same manner as DBCOD. DBCOD is the preferred usage.

IDEN command

Invokes dynamic job descriptor entry (DJDE) processing.

The IDEN command coded in the JSL notifies the system that DJDE records may be part of the input data stream. IDEN also describes the characteristics or search criteria for locating and identifying DJDE records.

The DJDE record(s) are interspersed among the data records in the input data stream. Each DJDE record contains an identification field (which matches the search criteria specified in the active job) and a series of parameters that describe the actual JDL changes to be applied to the job.

The following sections describe the syntax of the IDEN command parameters and explain their options.

IDEN command parameters

Table 2-22. Summary of IDEN command parameters

Parameter	Specifies	Online	Offline	DJDE
IDEN DJPCC	Specifies processing of carriage control for DJDE records.	Y	Y	N
IDEN OFFSET	Specifies the starting position of the prefix string.	Y	Y	N
IDEN OPRINFO	Specifies whether the DJDE record is printed and delivered to the stacker.	Y	Y	N
IDEN PREFIX	Specifies a character string that appears in the DJDE record identification part.	Y	Y	N
IDEN SKIP	Specifies the starting position of the first DJDE command.	Y	Y	N

IDEN DJPCC

(DJDE Printer Carriage Control) Defines the processing of carriage control for DJDE records found in the data stream.

Syntax IDEN DJPCC= {DEFAULT | PROCESS | IGNORE}

Options

Table 2-23. IDEN DJPCC options and definitions

Option	Definition
DEFAULT	Specifies that, for online printing, the 'channel skip' portion of the carriage control will be applied, whereas the 'print' and 'space' portions will not. (Refer to the PCC ASSIGN parameter section in this chapter for further information on carriage control.) For offline printing, this option specifies that all PCCs in the DJDE records will be ignored.
PROCESS	Specifies that carriage control information for all DJDE records will be valid for both online and offline printing.
IGNORE	Causes all carriage control information to be ignored for both online and offline printing.

Default DEFAULT

IDEN OFFSET

Specifies the number of bytes (beginning at 0) from the beginning of the user portion of the record to the beginning of the prefix string constant of the DJDE record. The number may be negative.

Syntax IDEN OFFSET = *value*

Options

Table 2-24. IDEN OFFSET parameter option and definition

Option	Definition
<i>value</i>	Specifies the number of bytes (beginning at 0) from the beginning of the user portion of the record to the beginning of the prefix string constant of the DJDE record. It may be a negative number.

Default 0

IDEN OPRINFO

Specifies whether or not the DJDE record is printed and delivered to the stacker.

Syntax IDEN OPRINFO = {YES | NO}

Options

Table 2-25. IDEN OPRINFO options and definitions

Option	Definition
YES	Specifies that the DJDE record prints and is delivered to the stacker.
NO	Specifies that the DJDE record does not print.

Default NO

IDEN OPRINFO parameter: point to note When OPRINFO=YES is selected, the length of the DJDE record that prints on the sheet is whatever amount fits on the width of the paper.

IDEN PREFIX

Defines the character string that must appear in the identification part of each DJDE record in the input data stream. When the system recognizes this character string, it examines the rest of the record for DJDE commands.

Syntax IDEN PREFIX = *sc*

Options**Table 2-26. IDEN PREFIX parameter options and definitions**

Option	Definition
<i>sc</i>	<i>string constant.</i> Specifies the search criterion for recognizing DJDE records. It is a byte string of up to 255 characters represented as a hexadecimal, octal, BCD, ASCII, or EBCDIC character constant. Any records within the data stream that contain an identification field equal to the specified prefix string <i>sc</i> are recognized and processed as DJDE records.

Default No default.

IDEN SKIP

Defines the starting position of the DJDE commands.

Syntax IDEN SKIP = *value*

Options**Table 2-27. IDEN SKIP parameter options and definitions**

Option	Definition
<i>value</i>	Specifies the number of bytes (beginning at 0) from the beginning of the user portion of the record to the beginning of the DJDE parameters. It may be a negative number.

Default 1

IDEN command example

```
IDEN    PREFIX='RTEST' , SKIP=9, OFFSET=3,
        OPRINFO=YES, DJPCC=IGNORE;
```

KCODE command

Defines a double-byte character code translation table.

When you require a user defined translation table of double-byte character codes, you define the double-byte character translation using the KCODE command, then reference this command using the VOLUME KCODE parameter. As an alternative, you can use the USER option of the VOLUME KCODE parameter to reference the KCODE command for which no identifier was provided.

ac identifier A command identifier of the type *ac* is optional for the **first** KCODE command within a JDE. Thereafter, each additional KCODE command **must** include the identifier. The *ac* identifier consists of 1 to 6 alphanumeric characters (A through Z and 0 through 9). One of the characters must be alphabetic.

KCODE command parameters

The following table summarizes the KCODE command parameters.

Table 2-28. Summary of KCODE command parameters

Parameter	Specifies	Online	Offline	DJDE
KCODE ASSIGN	Defines user double-byte code assignments.	Y	N	N
KCODE DEFAULT	Specifies a base code from which double-byte character code assignment exceptions can be made.	Y	N	N

The following sections describe the syntax of the KCODE command parameters and explain the parameter options.

KCODE ASSIGN

Defines double-byte character code assignment exceptions or an entire user character translation table.

Syntax *ac*: KCODE ASSIGN = {(*input*, *output*) | (*input*, (*output*₁ [, *output*₂] [,...]))}

Options**Table 2-29. KCODE ASSIGN parameter options and definitions**

Option	Definition
<i>input</i>	A numeric constant that defines the input double-byte code.
<i>output</i>	A numeric constant that defines the output double-byte code that corresponds to the input code

Default No default

KCODE DEFAULT

Specifies a base code from which you can make double-byte character code assignment exceptions.

The base code is specified by a *codetype*; the exceptions are specified in the ASSIGN parameter.

Syntax *ac*: KCODE DEFAULT = *codetype*

Options**Table 2-30. KCODE DEFAULT parameter options and definitions**

Option	Definition
<i>codetype</i>	Keyword for one the following double-byte codes: <ul style="list-style-type: none"> • IBM: Specifies the IBM Nihongo character set (Kanji double-byte sets) • JEF: Specifies the Fujitsu JEF Kanji double-byte character set. • JIS • KEIS: Specifies the Hitachi KEIS Kanji double-byte character set

Default No default

KCODE command: point to note

The DBCODE command can be used in the same manner as KCODE.

PCC command

Enables you to create a table (or modify an existing standard table) of one-byte printer carriage control codes and define their action.

NOTE: This command is ignored by the FreeFlow Print Server LCDS systems for both channel and TCP/IP processing. Carriage control (specifications such as Skip to Channel, Print, or Space 2 Lines) is accomplished by processing IBM channel commands, which have specific, well defined carriage control interpretations.

However, if you specify the PCC command in a JSL created on your system, you can transfer the JSL file to another laser printing system for use with offline printing.

All line spacing, skipping to channel, and printing actions are defined through this command.

You can optionally specify an identifier of the *ac* type (having at least one alphabetic character) when defining the PCC table, and reference this identifier in the LINE PCCTYPE parameter.

PCC command parameters

The following table summarizes the PCC command parameters.

Table 2-31. Summary of PCC command parameters

Parameter	Specifies	Online	Offline	DJDE
ADJUST	Defines the printer action for two successive channel skips	N	Y	N
CONSTANT	Specifies user-assigned carriage control code exceptions to the default table.	N	Y	N
RECORD FORMAT	Selects a table of printer carriage control codes.	N	Y	N
LENGTH	Specifies the initial reference point for the first carriage control command.	N	Y	N
LMULT	Makes inaccessible any unnecessary bits from the printer carriage control byte.	N	Y	N

Table 2-31. Summary of PCC command parameters (Continued)

Parameter	Specifies	Online	Offline	DJDE
LTHFLD	Length of field containing record length	Y	N	N
OFFSET	Location of record length field	Y	N	N
POSTAMBLE	Length of extraneous data at end of record	Y	N	N
STRUCTURE	Input record structure	Y	N	N

The following sections describe the syntax of the command parameters and explain their options.

PCC ADVTAPE

Specifies whether or not the carriage control advances to a new page when two successive channel skip parameters are issued with no intervening print.

For example, on most printers, the actions PSK1 (Print and Skip to Channel 1) followed by SK1N (Skip to Channel 1, Do Not Print) cause a blank page to be output. However, on a 1403 printer, these actions do not produce a blank page.

Syntax [ac:] PCC ADVTAPE = {YES | NO}

Options

Table 2-32. PCC ADVTAPE parameter options and definitions

Option	Definition
YES	Specifies that multiple skips are honored.
NO	Specifies that multiple skips result in only one skip action being taken.

Default No default

PCC ADVTAPE parameter: point to note SK1P (skip to channel 1 and print) followed by a second SK1P results in a page transition because printing occurred on the first page, even if only blanks were output.

PCC ASSIGN

Specifies printer carriage control exceptions to a default table. Refer to the "PCC DEFAULT" parameter section in this chapter.

Syntax [ac:] PCC ASSIGN = {(byte, ccln) | (byte, (ccln₁ [, ccln₂] [, ...])}

Syntax for ccln definition:

{field₁ [, field₂ [, field₃]] | (field₁ [, field₂ [, field₃]] [, {TOF | OVR | IGN}}}}

Options

Table 2-33. PCC ASSIGN parameter options and definitions

Option	Definition
byte	The printer carriage control byte that is being defined. Its value is in the range 0 to 255 (X00 to XFF).
<i>ccln</i>	<p><i>carriage control line number.</i> Specifies the action that should be taken when the printer carriage control byte defined in the <i>byte</i> field is encountered. A <i>ccln</i> consists of the following:</p> <ul style="list-style-type: none"> • Space print parameters This has the following components: <ul style="list-style-type: none"> – <i>field1</i> Specifies the carriage action to take before printing. (An example is the ANSI carriage control.) <ul style="list-style-type: none"> - SP<i>m</i> Space <i>m</i> lines before printing. - SK<i>n</i> Skip to channel <i>n</i> before printing. – <i>field2</i> Specifies whether printing occurs for this record: <ul style="list-style-type: none"> - P Print the output data at the line number computed after <i>field1</i> is processed. - N No printing occurs for this record (default). – <i>field3</i> Specifies the carriage action to take after printing. (An example is the IBM1403 carriage control.) <ul style="list-style-type: none"> - SP<i>m</i> Space <i>m</i> lines after printing. - SK<i>n</i> Skip to channel <i>n</i> after printing. <p><i>NOTE: Each of the three fields shown above is optional; however, you must specify at least one field. The range for variables m and n is 0 to 15.</i></p> • Bottom Of Form actions (optional) <ul style="list-style-type: none"> – TOF When <i>spacing</i> causes bottom of form (BOF) to occur, instructs the system to go to the top of form (TOF) on the next page and to stop spacing. – IGN When <i>spacing</i> causes the bottom of form (BOF) to occur, instructs the system to ignore it to continue spacing through the end of the physical page. The page then transitions to top of form and spacing continues. – OVR (default) When <i>spacing</i> causes bottom of form (BOF) to occur, instructs the system to go to the top of form (TOF) on the next page and to continue spacing.

Default No default

**PCC ASSIGN
parameter: points
to note**

- You need not specify consecutive byte values. For example, you can code the following command as a single command:

```
ASSIGN=(X' 60' , SP1) , ASSIGN=(X' 61' , SP2) ,
ASSIGN=(X' 62' , SP3) ;
```

The single command is:

```
ASSIGN=(X' 60' , SP1, SP2, SP3) ;
```

- If *byte translation* is specified under the PCC LINE parameter (that is, the LINE PCC parameter TRAN option is specified), the PCC control byte is translated into standard EBCDIC before being applied. Refer to Appendix C, “Character Code Assignments,” in this guide. In this case you must specify the *byte* option of the ASSIGN parameter as an EBCDIC translation of the PCC byte; for example, **X'F1'** or **'1'**.
- PCC codes should not be reassigned when the system is printing online, because the carriage control codes are converted to 3211 codes (whose functions are specifically defined) before they are sent. Any special PCC byte assignments are ignored for online printing, and the defaults that were defined for PCCTYPE=IBM3211 are used.

PCC DEFAULT

Allows you to select a set of printer carriage control codes.

You can select a table and then modify specific control codes by using the ASSIGN parameter.

Syntax [ac:] PCC DEFAULT = {*ccln* | *pcctype*}

Options

Table 2-34. PCC DEFAULT parameter options and definitions

Option	Definition
<i>ccln</i>	Specifies the required action when a character code has not been specifically assigned. The assignment codes for various actions are described in the <i>ccln</i> option description of the ASSIGN parameter. The system default PCC tables are defined using standard EBCDIC characters.

Table 2-34. PCC DEFAULT parameter options and definitions (Continued)

Option	Definition
<i>PCCtype</i>	Parameters and the tables that can be modified are: <ul style="list-style-type: none"> • ANSI • B2500 • B2700 • B3700 • B4700 • B6700 • H2000 • H6000 • IBM1401 • IBM1403 • IGN • OVR • TOF • US70 • XEROX • NONE

Default A table of PSP1 (Print and Space 1) codes

PCC DEFAULT parameter: point to note The DEFAULT parameter must precede any ASSIGN parameter. Any preceding ASSIGN parameter is not incorporated into the PCC table.

PCC INITIAL

Specifies the initial reference point (TOF or BOF) from which a job performs its first carriage control function.

Syntax [*ac*:] PCC INITIAL = {TOF | BOF}

Options

Table 2-35. PCC INITIAL parameter options and definitions

Option	Definition
TOF	Specifies that the control program will perform the first spacing, skipping, or printing action from the Top Of Form (top of page image).
BOF	Specifies that the control program will perform the first spacing, skipping, or printing action from the Bottom Of Form (bottom of page image).

Default TOF

PCC MASK

Makes inaccessible any unnecessary bits from the printer carriage control byte.

Syntax [ac:] PCC MASK = *value*

Options

Table 2-36. PCC MASK parameter options and definitions

Option	Definition
<i>value</i>	Specifies an 8 bit value that will be used in a bit wise "AND" operation with the printer carriage control byte being processed. AND occurs after translation, if any. The result of this process is to mask off bits from the carriage control byte that are not relevant to the operation being specified.

Default X'FF'

PCC command: points to note

When using the PCC command, keep in mind the following:

- Multiple user defined PCC tables are allowed, but only one may be used without a command identifier. The LINE PCCTYPE parameter is used to invoke a PCC command by reference to its identifier. The keyword USER can be used to reference any user defined PCC table for which no command identifier is coded.
- You may end a PCC command with a semicolon and start another PCC command to continue specification of the carriage control codes. Multiple PCC commands may be used within a single PCC table definition as long as there are no intervening non PCC commands.

PCC command example

```
PCC1: PCC      DEFAULT=IBM1403, INITIAL=TOF,
              ADVTAPE=NO, ASSIGN=(X'40',SP1P),
              ASSIGN=(X'F1',SK1P),
              ASSIGN=(X'F8',PSK8);
```

In the previous example, these codes were added to the standard IBM1403 carriage control code table: X'40' (Space 1 Line And Print), X'F1' (Skip to Channel 1 And Print), and X'F8' (Print And Skip to Channel 8).

RECORD command

Specifies the structure of the print record. (For online printing, only the LENGTH parameter of this command is used. For offline printing, the RECORD command has several additional parameters that define the record structure.)

Record command parameters

The following table summarizes the RECORD command parameters.

Table 2-37. Summary of RECORD command parameters

Parameter	Specifies	Offline	Online	DJDE
ADJUST	Record length adjust value	Y	N	N
CONSTANT	Record termination code	Y	N	N
RECORD FORMAT	Length field recording mode	Y	N	N
LENGTH	Maximum logical record length	Y	Y	N
LMULT	Multiplication factor to determine record length	Y	N	N
LTHFLD	Length of field containing record length	Y	N	N
OFFSET	Location of record length field	Y	N	N
POSTAMBLE	Length of extraneous data at end of record	Y	N	N
STRUCTURE	Input record structure	Y	N	N

RECORD ADJUST

Specifies an adjustment value that is added to or subtracted from the contents of the record length field to determine the true record length.

Syntax RECORD ADJUST = *value*

Options

Table 2-38. RECORD ADJUST parameter options and definitions

Option	Definition
<i>value</i>	A constant integer that is added to or subtracted from the value in the length field of every record. The range of a value is -127 to 127 and must be no greater than the record length. The first character may be plus (+) or minus (-).

Default 0

RECORD CONSTANT

Specifies a constant string used to signal the end of a record. This record delimiter constant string signals the end of the record, but it is not included in the print line.

Syntax RECORD CONSTANT = *sc*

Options

Table 2-39. RECORD CONSTANT parameter options and definitions

Option	Definition
<i>sc</i>	<i>String constant.</i> Specifies a string (hexadecimal, octal, or alpha) constant as described in the chapter "Creating a job source library (JSL)." The length of the constant may be from 1 to 4 bytes.

Default No default

RECORD FORMAT

Specifies the format of the record length field.

Syntax RECORD FORMAT = *type*

Options

Table 2-40. RECORD FORMAT parameter options and definitions

Option	Definition
<i>type</i>	The following types are available for the record format: <ul style="list-style-type: none"> • BIN (binary) • DEC (decimal) • PACK (packed with no sign) • PKSG (packed with sign)

Default BIN

RECORD LENGTH

Specifies the length of the longest record.

Syntax RECORD LENGTH = *value*

Options

Table 2-41. RECORD LENGTH parameter options and definitions

Option	Definition
<i>value</i>	Specifies in bytes the length of the longest logical record. The <i>value</i> is an integer from 12 to 12288 for the FreeFlow Print Server LCDS systems.

Default Online: 150
Offline: 133

RECORD LENGTH parameter: points to note

- When you change the LINE DATA parameter to a value greater than the default value, you must also change the RECORD LENGTH parameter accordingly. Otherwise, the data is truncated to the length that was specified in the initial JDL.
- You cannot use print position indexing for online processing if you specify a LENGTH greater than 150.

- The tape label contents can override a record length value. If a defined record length is larger than the default block length (1330), you must specify a block length that is large enough to hold the record. If a large enough record length is not specified, data may be lost.
- The RECORD LENGTH parameter may be overridden by ANSI or IBM OS/Standard labels that specify record length.
- The length on a 4-by-3 packed format tape is the number of 6-bit characters in the record.

RECORD LMULT

Specifies a multiplication factor that is applied to the contents of the record length field to determine the true record length.

Syntax RECORD LMULT = *value*

Options

Table 2-42. RECORD LMULT parameter options and definitions

Option	Definition
<i>value</i>	An integer in the range of 1 to 15 that is multiplied by the value in the length field (refer to the RECORD LENGTH parameter section in this chapter) to compute the number of bytes in the record.

Default 1

RECORD LTHFLD

Specifies the length of the field that contains the record length.

Syntax RECORD LTHFLD = *size*

Options

Table 2-43. RECORD LTHFLD parameter options and definitions

Option	Definition
<i>size</i>	An integer from 0 to 5 that specifies in bytes the length of the field that contains the record length.

Default 0

RECORD OFFSET

Specifies the location of the record length field.

Syntax RECORD OFFSET = *value*

Options

Table 2-44. RECORD OFFSET parameter options and definitions

Option	Definition
<i>value</i>	Specifies the number of bytes that the block length field is offset from the first byte of the record. The value is an integer in the range 0 to <i>LENGTH-LTHFLD</i> – 1.

Default 0

RECORD POSTAMBLE

Specifies the length in bytes of the extraneous data at the end of each tape record, measured from the end of the record backwards to the end of the last logical record.

Syntax RECORD POSTAMBLE = *length*

Options

Table 2-45. RECORD POSTAMBLE parameter options and definitions

Option	Definition
<i>length</i>	An integer in the range of 0 to the record length that specifies the number of bytes that follow the last logical record to the end of each tape record.

Default 0

RECORD PREAMBLE

Specifies the length of the operating system portion of the record; that is, the byte offset from the first byte of a tape record to the first byte of the first logical record.

Syntax RECORD PREAMBLE = *length*

Options

Table 2-46. RECORD PREAMBLE parameter options and definitions

Option	Definition
<i>length</i>	An integer in the range of 0 to the record length that specifies the number of bytes from the first byte of the tape record to the first byte of the first logical record

Default 0

RECORD STRUCTURE

Specifies the general record structure of the input data.

Syntax RECORD STRUCTURE = *structure-type*

Options

Table 2-47. RECORD STRUCTURE parameter options and definitions

Option	Definition
<i>structure-type</i>	Type of structure of the record. May be any of the following: <ul style="list-style-type: none"> • FB (fixed length blocked) • F (fixed length) • V (variable length) • VB (variable length blocked) • U (undefined length) • UB (undefined length blocked)

Default FB

RECORD command: Points to note

Note the following when using the RECORD command:

- **LTHFLD, OFFSET, FORMAT, and PREAMBLE parameters**
The values for these parameters may be overridden if STRUCTURE is changed as the result of ANSI or IBM OS/Standard label processing.
- **CONSTANT and STRUCTURE parameters**

CONSTANT may be enabled as the result of STRUCTURE being changed to U in label processing. However, no definition is assumed for the constant string. The default must be zero, or it must be defined in the job descriptor entry.

- **LINE DATA parameter and RECORD LENGTH parameter**

When the DATA parameter of the LINE command is changed to a value greater than the default value, the LENGTH parameter of the RECORD command must also be changed accordingly. Refer to the “LINE command” section of the “Specifying print format parameters” chapter for additional information.

- **Using online JDEs in offline JDLs**

An offline JDL statement set that modifies the system default values, specifically in the BLOCK or RECORD commands, may experience incorrect results if an online job (JDE) is running. In other words, if an online JDE is specified in an offline JDL that has changed the system default values of the BLOCK and RECORD command parameters, the job may not print correctly. You should separate and run online and offline jobs (JDEs) independently of each other.

RECORD command example

The RECORD command for the sample input record illustrated below would be coded as follows:

```
RECORD    LENGTH=133, OFFSET=2, LTHFLD=2,
          PREAMBLE=4, ADJUST=4, FORMAT=BIN;
```

The following figure shows sample values for RECORD command parameters.

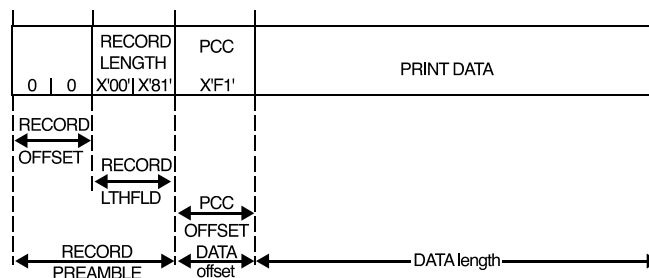

Figure 2-2. Sample RECORD command

The following figure shows record format types.

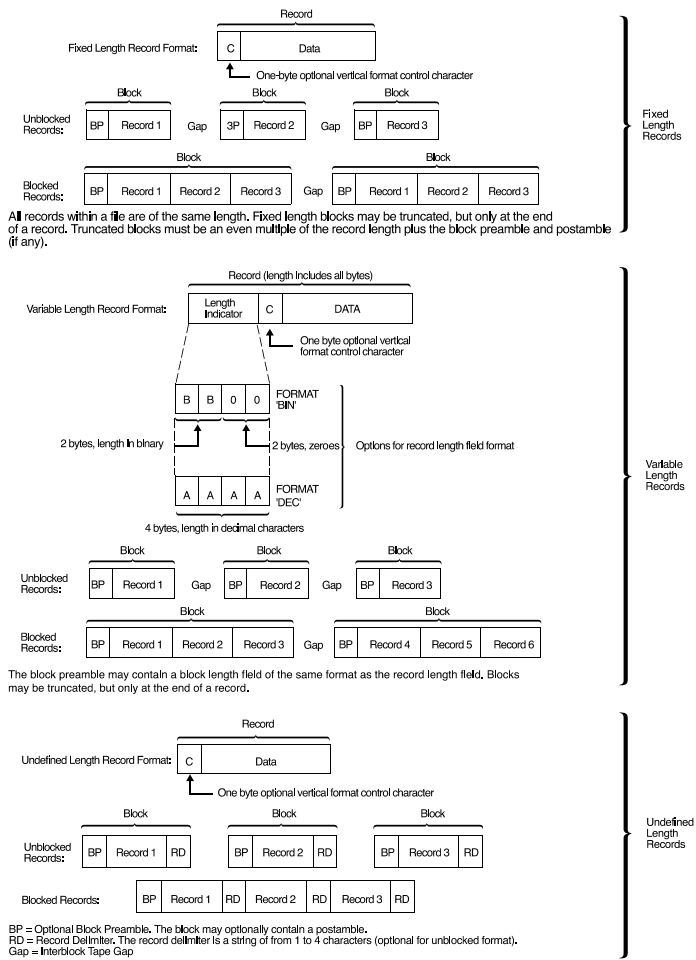

Figure 2-3. Record format types

SEFFNT command

When you print a job on large sized paper (such as 11 by 17 inch or A3), the paper must feed with its short edge as the leading edge. This is called “short edge feed” (SEF).

The SEFFNT command enables or disables the short edge feed font mapping feature. SEFFNT creates customized mapping files (of the type .LIB) and triggers the system to invoke short edge feed font mapping. It is used in conjunction with the PDE currently in effect.

In order to maintain the current definition of landscape and portrait in these jobs, you must define a mapping in which every landscape font used in a SEF job has a portrait equivalent and vice versa.

When the system recognizes a SEF job, it scans the PDE font list and substitutes these fonts with font mappings defined in the JSL. If you specify that font mappings are contained in a file, the input task checks to see if this file exists. If the mapping file, or a font file that has been mapped to, does not exist, job processing continues using the font specified in the PDE command.

If SEF font mapping is in effect, and if no mapping exists for a font referenced in a PDE, you receive a Continue or Abort Input message on the screen, which gives you the option to continue processing using the font specified in the PDE or to abort the job.

The SEFFNT command has different effects depending on the context:

- Bypassing font mapping (SEFFNT MAP=NONE)
- Mapping contained in the JDL (SEFFNT MAP=*label*)
- Standalone mapping files (SEFFNT MAP=*fileid*)
- Creation of a mapping file (*label*: SEFFNT SEFMAP= (...))

NOTE: You cannot specify both a MAP and a SEFMAP parameter in the same SEFFNT command.

SEFFNT command parameters

The following table summarizes the use of the SEFFNT command parameters.

Table 2-48. Summary of SEFFNT command parameters

Parameter	Specifies	Online	Offline	DJDE
<i>label</i>	Specifies the name of the font mapping file or the identifier of a font mapping table that will be created. If the label does not exist, the SEFFNT command either creates a table in the JDL or uses an existing mapping file if MAP is specified.	Y	Y	N
SEFFNT SEFMAP	Specifies font mapping where the second specified font is the SEF mapping for the first font.	Y	Y	Y
SEFFNT MAP	Specifies a font mapping that was defined previously.	Y	Y	Y

The following sections describe the syntax of the command parameters and give explanations of the parameter options.

SEFFNT SEFMAP

Specifies font mapping, which associates one font with another font. A collection of font mappings may be stored in a mapping file. (Font files are files having the .FNT extension and are stored on disk.)

Syntax `[label:] SEFFNT SEFMAP = {((font1, font2) [, (fontm, fontn))} | NONE}`

Options

Table 2-49. SEFFNT SEFMAP parameter options and definitions

Option	Definition
<i>(font</i> ₁ , <i>font</i> ₂)	Font pair, where <i>font</i> ₂ is the SEF mapping for <i>font</i> ₁ .
<i>(font</i> _m , <i>font</i> _n)	Font pair, where <i>font</i> _n is the SEF mapping for <i>font</i> _m .
NONE	Disables font mapping and short edge feeding (SEF); stops previous SEFFNT.
UPD	UPDATE Indicates that the specified font pairs change existing font mappings or appending new mappings to the current font mapping table.

Table 2-49. SEFFNT SEFMAP parameter options and definitions (Continued)

Option	Definition
REP	REPLACE Indicates that the specified font pairs create a new mapping table to replace the current one.

Default No default

SEFFNT SEFMAP parameter: points to note

- When specified without a label preceding the SEFFNT command, SEFMAP puts all font mapping definitions within the JDL, rather than creating a separate mapping file.
- When SEFMAP is coded outside of a standard JSL (either prior to a JDL command or after an END command), the system creates a file named *label.LIB* on the disk. This file contains the font mappings for reference within the JSL by other JSLs or through a DJDE.

NOTE: The .LIB file that is created by a labeled SEFFNT command cannot be imported to, or exported from, the FreeFlow Print Server LCDS systems. You must compile the JSL that contains the labeled SEFFNT command, which causes the system to recreate the .LIB file.
- When coded at the catalog level of a JSL, SEF mapping applies to all JOBS or JDEs that include the catalog. When coded at the job level, SEF mapping specifically assigns a mapping to be used with this JOB or JDE.
- In the parameter (*font₁, font₂*) (*font₂, font₃*), the fact that *font₁* is mapped to *font₂* and *font₂* is mapped to *font₃* does not imply that *font₁* is mapped to *font₃*.

SEFFNT MAP

References a previously defined font mapping file (*filename*) or a labeled SEFFNT command defined in the current JSL file.

Syntax SEFFNT MAP = {*filename* | *label*}

Options

Table 2-50. SEFFNT MAP parameter options and definitions

Option	Definition
<i>filename</i>	References a font mapping file. The file is accessed when the JDL is used for printing.
<i>label</i>	References the label of a labeled SEFFNT command that is defined in the current JSL.

Default No default

SEFFNT command: points to note

Note the following when using the SEFFNT command:

- The system does not assume any mappings for fonts. You must always provide the mapping. Once the font mapping is found, range checking is based on the new orientation. The range checking determines only if the BEGIN values are within the bounds of the page. The system does not check to determine whether the line will run off the edge of the page.
- The following system pages use predefined forms and therefore are not reformatted in order to print the forms in the same orientation as their associated jobs. In other words, no font mappings or rotations of forms are performed on the following files:
 - Graphic samples
 - Graphic summary pages
 - Accounting pages
- Short edge feed (SEF) duplex printing differs from long edge feed (LEF) applications in that SEF uses a head to toe orientation for printing portrait pages, while LEF uses head to head orientation. Refer to the “OUTPUT INVERT” parameter section of the “Specifying print format parameters” chapter for alternate methods of rotating the page orientation.

For landscape printing, however, SEF uses a head to head orientation, whereas LEF landscape uses head to toe orientation.

- If you want to use 11 by 17 inch paper or any size that requires SEF, be aware that form source libraries (.FSL) files, form (.FRM) files, logo (.LGO) files, and image (.IMG) files are not automatically scaled or rotated. You may need to alter the FSL text file to specify that the form should be rotated.

SEFFNT command examples

Following are a few examples of how to use the SEFFNT command.

Example 1 A FNTMAP.LIB file is created on the system disk.

```
FNTMAP: SEFFNT SEFMAP=(L0112B,P0612A);
SYS1: SYSTEM;
VOLUME CODE=ASCII;
```

Example 2 Job 1 uses the SEFFNT command because there is no override specified.

```
SEFFNT SEFMAP=(L0114B, P0614A);
PDE1: PDE FONT=L0114B,
PMODE=LANDSCAPE,
BEGIN=(.50,.50);
JOB1: JOB;
OUTPUT FORMAT=PDE1;
```

Example 3 Job 2 uses the FNTMAP.LIB file created in example 1.

```
JOB2: JOB;
OUTPUT FORMAT=FMT1;
SEFFNT MAP=FNTMAP;
```

Example 4 There is no font mapping because SEF is disabled by the SEFMAP=NONE parameter.

```
JOB3: JOB;
OUTPUT FORMAT=FMT6;
SEFFNT SEFMAP=NONE;
```

Example 5 Job 4 overrides the system level SEFFNT mapping with a job level definition.

```
JOB4: JOB;  
      SEFFNT      SEFMAP=(L01BOB,P0812A);
```

TCODE command

The TCODE command defines a set of input-character-to-type assignments that will be used for the masked string comparisons in a report. You must use TCODE whenever you need to modify one of the standard sets of default type assignments.

General rules for using the TCODE command

The TCODE command should be coded as follows:

- Use a command identifier of the type *ac* for the TCODE command within a JSL. The *ac* identifier consists of 1 to 6 alphanumeric characters (A through Z and 0 through 9). One of these characters must be alphabetic.
- Use the DEFAULT parameter to specify the initial type assignments for the entire set of input character codes.
- Use one or more occurrences of the TASSIGN parameter to modify the specified initial set of type assignments by associating specific character types with specific characters in the input character set.
- If necessary, use one or more occurrences of the TRESET parameter to further modify the initial set by disassociating specific character types from specific characters in the input character set.
- Use a hyphen (-) to specify a range of contiguous characters where the contiguity is based on actual codes.
- Specify input codes in their untranslated form.

For example, for input data encoded generally in ASCII, use the ASCII string constant type or the hexadecimal equivalent. (For example, for A, use the ASCII A'a' or the hex equivalent X'61'. Do not use 'a' in this case.)

- For input codes associated with EBCDIC characters, be aware that the contiguity of the input codes is interrupted between the letters I and J, and between the letters R and S. This break requires you to specify three separate ranges.
- Use the TASSIGN parameters to define additional character sets.

- The printing system accepts lowercase characters expressed literally or symbolically; that is, preceded by the pound sign (#) functioning as a switch case operator.

The following table gives some examples of how the TCODE command may be coded to specify the following types of character sets.

Table 2-51. Specifying various types of character sets

Type	Interpretation
1	Defines numeric characters (0 through 9) by default.
2	Defines alphabetic characters (A through Z and a through z) by default.
3	Defines uppercase alphabetic characters (A through Z) by TCODE command.
4	Defines lowercase alphabetic characters (a through z) by TCODE command.
None	Defines characters that are neither numeric nor alphabetic.

- The TCODE command requires a variable of the type *ac* (at least one character must be alphabetic).

TCODE command parameters

The following table summarizes the use of the TCODE command parameters.

Table 2-52. Summary of TCODE command parameters

Parameter	Specifies	Online	Offline	DJDE
TCODE DEFAULT	Specifies the initial set of character type assignments that will be used with masked comparisons.	Y	Y	N
TCODE TASSIGN	Associates one or more specified characters with one or more specified type codes.	Y	Y	N
TCODE TRESET	Disassociates one or more characters or all characters in a set from one or more type codes.	Y	Y	N

The following sections describe the syntax of the command parameters and give explanations of the parameter options.

TCODE DEFAULT

Specifies an initial set of character type assignments for use with masked comparisons. You may specify default assignments for any standard character set by coding the appropriate keyword.

Syntax *ac*: TCODE DEFAULT = {*tcode Type* | *value*}

Options

Table 2-53. TCODE DEFAULT parameter options and definitions

Option	Definition
<i>tcode Type</i>	Available tcode type keyword parameters are: <ul style="list-style-type: none"> • ASCII • BCD • EBCDIC • PEBCDIC • IBMBCD
<i>value</i>	An integer from 0 to 7. <ul style="list-style-type: none"> • If you specify 0, all the characters are untyped. • If you specify 1, all the characters are type 1. If you specify 7, all the characters are type 7, and so forth.

Default No default

TCODE DEFAULT parameter: points to note

If you specify a *tcode Type*, this sets the following conditions:

- All numeric characters (0 through 9) are type 1 characters.
- All alphabetic characters (A through Z, a through z) are type 2 characters.
- All other characters are untyped.

TCODE TASSIGN

Associates one or more specified characters with one or more specified type codes. May also be used to disassociate one or more characters from all type code assignments. Can be specified more than once in a TCODE command.

Syntax *ac*: TCODE TASSIGN = {(*typespec*, '*inputspec*') | (*typespec*, ('*inputspec*₁' [*inputspec*₂'] [...]))}

Options

Table 2-54. TCODE TASSIGN parameter options and definitions

Option	Definition
<i>typespec</i>	A <i>typespec</i> may be coded as a single integer, <i>n</i> . When coded as a single integer, the value must be in the range of 0 to 7. When coded as a series of integers, the values must be within the range of 1 through 7. NUMERIC may be used instead of 1; ALPHA may be used instead of 2.
<i>inputspec</i>	An <i>inputspec</i> may be coded as a single character, <i>char</i> , as a series of characters, (<i>char</i> [...]), or as a range of characters, (<i>char</i> ₁ , – , <i>char</i> ₂). The syntax <i>char</i> ₁ , , <i>char</i> ₂ means the set of input codes corresponding to characters bounded by and including <i>char</i> ₁ and <i>char</i> ₂ . (Refer to Appendix D, “Offline Specifications,” for relative order of characters.)

TCODE TASSIGN parameter: point to note When a *typespec* is coded as a 0, all characters specified by an *inputspec* are disassociated from all type code assignments. Thus, the TASSIGN parameter may untype a specified set of characters.

When a *typespec* is coded with a single value (ranging from 1 through 7), all specified characters are associated with that type code. When a *typespec* is coded as a series of values (all ranging from 1 through 7), the specified characters are each associated with all of the specified types.

Default No default

TCODE TRESET

Disassociates one or more characters (or all characters) in a set from one or more types.

Syntax *ac*: TCODE TRESET = {(*typespec*, '*inputspec*') | (*typespec*, ('*inputspec*₁' [, '*inputspec*₂' [...])) | ALL}

Options

Table 2-55. TCODE TRESET parameter options and definitions

Option	Definition
<i>typespec</i>	A <i>typespec</i> may be coded as a single integer, <i>n</i> , within the range of 1 through 7. NUMERIC may be used instead of 1; ALPHA may be used instead of 2.
<i>inputspec</i>	An <i>inputspec</i> for this parameter is the same as defined for TASSIGN parameter, or it can be ALL, which specifies that all characters in the code table are disassociated from the specified types. The TRESET parameter may be specified more than once in the TCODE command.
ALL	Resets all types for all characters.

Default No default

TCODE command examples

Following are a few examples of how to use the TCODE command.

Example 1 The basic character set used for default types is ASCII. The keyboard display has uppercase and lowercase character capability:

```
T1: TCODE      DEFAULT= ASCII,
           TASSIGN= (3, (A'A', -, A'Z')),
           TASSIGN= (4, (A'a', -, A'z'));
```

Example 2 The basic character set used for default types is EBCDIC. The keyboard display has uppercase and lowercase character capability:

```
T2: TCODE  DEFAULT= EBCDIC,
           TASSIGN= (3, ('A', -, 'I'), 'J', -, 'R'), ('S', -, 'Z')),
           TASSIGN= (4, 'a', -, 'i'), ('j', -, 'r'), ('s', -, 'z'));
```

Example 3 The basic character set used for default types is ASCII. The keyboard display is limited to uppercase only.

```
T3: TCODE  DEFAULT= ASCII,
           TASSIGN= (3, (A'A', -, A'Z')),
           TASSIGN= (4, (A'#A', -, A'#Z'));
```

The # symbol functions as a case switching operator.

Example 4 The basic character set is EBCDIC. The editor that was used to edit the JSL file is limited to uppercase only:

```
T4: TCODE DEFAULT=EBCDIC,
      TASSIGN=(3, ('A',-, 'I'), ('J',-, 'R'), ('S',-, 'Z')),
      TASSIGN=(4, ('#A',-, '#I'), ('#J',-, '#R'), ('#S',-, '#Z'));
```

VOLUME command

The VOLUME command specifies input medium and data characteristics.

VOLUME command parameters

The following table summarizes the parameters of the VOLUME command.

Table 2-56. Summary of VOLUME command parameters

Parameter	Specifies	Online	Offline	DJDE
VOLUME BMULT	Specifies a multiplication factor that is used to determine the true block length.	N	Y	N
VOLUME CODE	Specifies the character code set for input data translation.	Y	Y	N
VOLUME DBCODE	Specifies which double-byte character code translation table the system will use to interpret the input data.	Y	N	N
VOLUME DBCS	Specifies the double-byte character printing mode. Allows printing of data streams with intermixed single-byte and double-byte characters.	Y	N	N
VOLUME EMTYPE	Specifies the emulation type with which the system will print text.	Y	N	N
VOLUME EOVS	Specifies the action that the system will take when it detects the end of a tape volume.	N	Y	N
VOLUME EXPAGE	Provides data error logging and reporting of unprintable characters that do not have font bitmap or outline data in the font file.	Y	N	N
VOLUME HOST	Specifies the source of input data that will be processed.	Y	Y	N

Table 2-56. Summary of VOLUME command parameters (Continued)

Parameter	Specifies	Online	Offline	DJDE
VOLUME KANJI	Specifies double-byte character printing mode and allows printing of data streams of intermixed single-byte and double-byte characters.	Y	N	N
VOLUME KCODE	Specifies the double-byte character code translation table that the system will use to interpret the input data.	Y	N	N
VOLUME LABEL	Specifies the type of label on the input tape.	N	Y	N
VOLUME LCODE	Specifies the code translation table that will be used in interpreting the tape label.	N	Y	N
VOLUME LPACK	Specifies whether undefined labels are packed or unpacked.	N	Y	N
VOLUME MAXLAB	Specifies longest physical block that may be treated as a label if the label is undefined.	N	Y	N
VOLUME MINLAB	Specifies the shortest physical block that may be treated as a label if the label is undefined.	N	Y	N
VOLUME OPTIMIZE	Specifies throughput performance enhancement.	Y	N	N
VOLUME OSCHN	Specifies the channel that the system will use to signal the end of a report.	N	Y	N
VOLUME OSHDP	Specifies the number of header banner pages that precede the report.	N	Y	N
VOLUME OSTLP	Specifies the number of trailer banner pages that follow the report.	N	Y	N
VOLUME RMULT	Specifies a multiplication factor used to determine the true record length.	N	Y	N
VOLUME TCODE	Specifies a set of type assignments that will be used for masked comparisons.	Y	Y	N
VOLUME UNPACK	Specifies unpacking method of the input data when unpacking is required.	N	Y	N
VOLUME VCODE	Specifies a table of character type codes to use for criteria testing in Value mode.	Y	Y	N

The following sections describe the syntax of the VOLUME command parameters and explain the parameter options.

VOLUME BMULT

Specifies a multiplication factor that you can use to determine the true block length.

Syntax VOLUME BMULT = *value*

Options

Table 2-57. VOLUME BMULT parameter options and definitions

Option	Definition
<i>value</i>	An integer from 1 to 15 that you extract from the tape label and apply as a multiplication factor to the block length to determine the true block length

Default 1

VOLUME CODE

Specifies which code translation table the system uses to interpret the input data.

Syntax VOLUME CODE = {*keyword* | *id* | NONE}

Options

Table 2-58. VOLUME CODE parameter options and definitions

Option	Definition
<i>keyword</i>	Specifies a specific, standard, system defined code translation table. The available options are: <ul style="list-style-type: none"> • ASCII • BCD • EBCDIC • H2BCD • H6BCD • IBMBCD • NONE • PEBCDIC • USER (Refers to the single unlabeled CODE command defined within the JDL.)
<i>id</i>	Specifies an identifier label that you used in a previously defined CODE command. The <i>id</i> label is required when multiple CODE commands are contained within the JDL.
NONE	Specifies that data will not be translated by input processing.

Default EBCDIC

VOLUME CODE
parameter: points
to note

- When you run a CODE=NONE job with DUPLEX=YES and SHIFT=YES, you must specify MARGIN in inches.
- Input data is translated according to the CODE selected on the VOLUME command. Any character that is translated into an ASCII X'20' is truncated after the last significant (non-ASCII X'20') character in the print record.
- On the FreeFlow Print Server LCDS systems, trailing spaces are deleted for the current code set only. In addition, translated characters that are beyond the highest character code in the current font are converted to blanks and potentially removed.

VOLUME DBCODE

Specifies which double-byte character code translation table the system will use to interpret the input data.

Syntax VOLUME DBCODE = {*keyword* | *id*}

Options

Table 2-59. VOLUME DBCODE parameter options and definitions

Option	Definition
<i>keyword</i>	Specifies a specific, standard, system defined double-byte code translation table. The available options are: <ul style="list-style-type: none"> • IBM: IBM Nihongo character set (Kanji double-byte character sets) • IBMCHN: IBM 5550 code translation table • JEF: Fujitsu JEF Kanji double-byte character set • KEIS: Hitachi KEIS Kanji double-byte character set • USER: Refers to the single unlabeled DBCODE command defined within the JDL or JDE.
<i>id</i>	Specifies an identifier label that was used in a previously defined DBCODE command to refer to a specific, user-defined code translation table. The <i>id</i> label is required when multiple DBCODE commands are contained within the JDL.

Default No default

VOLUME DBCS

Specifies the double-byte character printing mode. Allows printing of data streams of intermixed single-byte and double-byte characters.

Syntax VOLUME DBCS = {YES | NO}

Options

Table 2-60. VOLUME DBCS parameter options and definitions

Option	Definition
YES	Allows printing of a data stream of intermixed single-byte and double-byte characters.
NO	Allows printing only of single-byte characters.

Default NO

VOLUME EMTYPE

Specifies the emulation type with which the system will print text.

Syntax VOLUME EMTYPE = {T1 | T2}

Options

Table 2-61. VOLUME EMTYPE parameter options and definitions

Option	Definition
T1	Interprets the function codes and the specified print positions, using the existing compatible formats.
T2	Interprets function codes and the specified print positions using the format for the host computer.

Default YES

VOLUME EMTYPE parameter: point to note This parameter is ignored for online printing unless one of the following VOLUME HOST parameter options for online printing is specified:

- HOST=FUJITSU; FUJONL KANJI=YES
- HOST=HITACHI; HITONL KANJI=YES

VOLUME EOVS

Specifies the action the system takes when it encounters an end of volume (EOV) on the input data tape.

Syntax VOLUME EOVS = ([PAUSE | NOPAUSE], [EOF | NOEOF])

Options**Table 2-62. VOLUME EOVS parameter options and definitions**

Option	Definition
PAUSE	Displays a message when EOVS is encountered. A CONTINUE response by the operator causes the tape to rewind and the normal volume change sequence to proceed.
NOPAUSE	Issues a rewind instruction as soon as the EOVS label is processed.
EOF	End of file. Specifies that the end-of-volume label is treated as an end-of-file label. When this occurs, the first part of the page spanning the volumes is output as the last page of the job. The second part of the spanned page is printed as the first page when the next volume is started, with possible page format irregularities. To use the EOF parameter effectively, special user-formatting of the multireel tapes is required to avoid these page format problems.
NOEOF	No end of file. Specifies normal end of volume processing.

Defaults NOPAUSE, NOEOF

VOLUME EXPAGE

Enables data error logging and reporting of unprintable characters that do not have font bitmap or outline data in the font file. (Errors are flagged on a separate page.)

Syntax VOLUME EXPAGE = {YES | NO}

Options

Table 2-63. VOLUME EXPAGE parameter options and definitions

Option	Definition
YES	If a character is not included in the font file, the error is flagged on the summary page.
NO	No unprintable character reporting is done.

Default YES

VOLUME HOST

Specifies the computer or host operating system that generated the input data file.

Syntax VOLUME HOST = *host type*

Options

Table 2-64. VOLUME HOST parameter options and definitions

Option	Definition
<i>host type</i>	Type of host operating system that is generating the input file. The following host types may be specified for online printing: <ul style="list-style-type: none"> • 123ONL • DBSONL • FUJONL • FXEONL • HITONL • IBMONL • OLDUMP • UTYONL The following host types may be specified for offline printing: <ul style="list-style-type: none"> • ANSI • DUMP (tape dump only format) • FUJITSU • HITACHI • IBMDOS • IBMOS • UNDEF (undefined) • UNIVAC SDF • Xerox (Xerox ANSI standard labeled and unlabeled tapes)

Default Offline printing: IBMOS
Online printing: No default

**VOLUME HOST
parameter: points
to note**

- For HOST=DUMP, two tape marks at the end of the tape are required to dump the data tape using DUMP.JSL.
- If a selected HOST type is inconsistent with a selected LABEL type, the PDL issues an error message and automatically substitutes a valid label. Do not code the LABEL parameter of the VOLUME command in cases where it is not appropriate for a particular HOST type. Refer to Appendix D, "Offline specifications," for format information.
- If an online job (JDE) is called out in an offline JDL that changes the system default values, the job may print incorrectly. If this happens, separate and run online and offline jobs independently of each other.
- The following defaults are automatically selected when VOLUME HOST=IBMONL is specified:

```
RECORD   LENGTH = 150;
```

```
LINE     PCCTYPE = IBM3211, DATA = (0,150);
```

- **Double-byte printing:**

The following host types can be used for **online** printing:

- 123ONL
- DBSONL: Emulates the IBM 4245 host type.
- FUJONL: Emulates the functionality of the Fujitsu F6715 and F672X printers.
- FXEONL
- HITONL: Emulates the functionality of the Hitachi H817X printer.
- UTYONL: Emulates the IBM 4245 host type.

The following host types can be used for **offline** printing:

- IBMDBS: Emulates the IBMOS, IBMDOS, and MVS/ESA host types in the label, block, and record structures.
- IBMUTY: Same as IBMDBS
- FUJITSU: Emulates the functionality of Fujitsu F6715 and F672x printers.
- HITACHI: Emulates the functionality of Hitachi 817x printer

- If the host application program uses ANSI carriage control commands, the host operating system converts each command to a valid 3211 or 4245 channel command before sending it to the printer for online printing. The printing system online interface (as well as the 3211 and 4245) rejects any commands other than those processed. Therefore, the only appropriate PCCTYPE for an online JSL file is IBM3211, which is the online default.
- Because the carriage control command is sent before the data record (rather than as part of it), offsets to fields (such as DJDE prefix and font index) are typically one byte less for online than offline mode, since the offline carriage control byte is part of the data record. For the same reason, the online LINE DATA parameter typically has a default offset of 0, rather than 1.

VOLUME KANJI

Specifies the double-byte character printing mode. Allows printing of data streams of intermixed single-byte and double-byte characters.

Syntax VOLUME KANJI = {YES | NO}

Options

Table 2-65. VOLUME KANJI parameter options and definitions

Option	Definition
YES	Allows printing of a data stream of intermixed single-byte and double-byte characters.
NO	Allows printing of only single-byte characters.

Default NO

VOLUME KANJI parameter: point to note This parameter functions the same as the VOLUME DBCS parameter, which is the preferred method of specifying double-byte character printing mode. The VOLUME KANJI parameter is supported only for compatibility purposes.

VOLUME KCODE

Specifies which double-byte character code translation table the system will use to interpret the input data.

Syntax VOLUME KCODE = {*keyword* | *id* }

Options**Table 2-66. VOLUME KCODE parameter options and definitions**

Option	Definition
<i>keyword</i>	Specifies a specific, standard, system defined double-byte code translation table. The available options are: <ul style="list-style-type: none"> • IBM: IBM Nihongo character set (Kanji double-byte character sets) • IBMCHN: IBM 5550 code translation table • JEF: Fujitsu JEF Kanji double-byte character set • KEIS: Hitachi KEIS Kanji double-byte character set • UCS2: ISO/IEC 10646 UCS2 character set • USER: Refers to the single unlabeled KCODE command defined within the JDL or JDE.
<i>id</i>	Specifies an identifier label that was used in a previously defined KCODE command to refer to a specific, user-defined code translation table. The <i>id</i> label is required when multiple KCODE commands are contained within the JDL.

Default No default

VOLUME LABEL

Specifies the type of label on the input tape.

Syntax VOLUME LABEL = *label type*

Options**Table 2-67. VOLUME LABEL parameter options and definitions**

Option	Definition
<i>label-type</i>	Specifies the type of label that the tape contains. The following types may be specified: <ul style="list-style-type: none"> • COBOL (Honeywell 2000 COBOL tape with 120-byte labels) • NONE (the input tape is unlabeled) • ANSI/XEROX ANSI • SPR (Honeywell 2000 System Print Tape) • STANDARD • UNDEF (Input tape label is not defined)

VOLUME LCODE

Specifies the code translation table that will be used in interpreting the tape label.

Syntax VOLUME LCODE = {*keyword* | *id* | NONE}

Options

Table 2-68. VOLUME LCODE parameter options and definitions

Option	Definition
<i>keyword</i>	<p>Specifies a specific, standard, system-defined code translation table. The available options are:</p> <ul style="list-style-type: none"> • ASCII • BCD • EBCDIC • H2BCD • H6BCD • IBMBCD • PEBCDIC • NONE • USER (Refers to the single unlabeled CODE command allowed within the JDE or JDL.) <p><i>NOTE: You must specify the variable identifier id to correspond to the identifier label that was assigned to the defining CODE command.</i></p>
<i>id</i>	<p>Specifies a variable identifier that you use in the CODE command to refer to a specific user-defined code translation table. The identifier id is required when multiple CODE commands are contained within the JDL.</p>
NONE	<p>Specifies that data will not be translated by input processing. For example, you select NONE for XPPI jobs that contain metacodes.</p>

Default EBCDIC

VOLUME LPACK

Specifies whether undefined labels (LABEL=UNDEF) are packed or unpacked.

Syntax VOLUME LPACK = *option*

Options

Table 2-69. VOLUME LPACK parameter options and definitions

Option	Definition
NO	Indicates that no unpacking operation will be performed.
YES	Indicates that the labels are packed. If YES is specified, the UNPACK parameters specify the required unpacking method for both the labels and the input data. If the data in a report is packed, the labels may be either packed or unpacked.

Default NO

VOLUME MAXLAB

Specifies the longest physical block that will be treated as a label when an undefined label is specified (LABEL=UNDEF).

Syntax VOLUME MAXLAB = *value*

Options

Table 2-70. MAXLAB parameter options and definitions

Option	Definition
<i>value</i>	Specifies in bytes the maximum length of the longest physical block. The value can range from 2 to 4096 bytes. The specified value must be greater than the MINLAB value and must not exceed the BLOCK LENGTH.

Default 81

VOLUME MAXLAB parameter: point to note Any data block whose length is between MINLAB and MAXLAB (inclusive) is treated as a label.

VOLUME MINLAB

Specifies the smallest physical block that will be treated as a label when an undefined label is specified (LABEL=UNDEF).

Syntax VOLUME MINLAB = *value*

Options

Table 2-71. VOLUME MINLAB parameter options and definitions

Option	Definition
<i>value</i>	Specifies in bytes the maximum length of the smallest physical block. The value can range from 1 to 4095 bytes. The specified value must be less than the MAXLAB value and must not exceed the BLOCK LENGTH.

Default 80

VOLUME OPTIMIZE

Enhances the performance of the data stream.

NOTE: This parameter is supported only partially by the FreeFlow Print Server LCDS systems. The parameter options table below reflects only the options that are supported.

Syntax VOLUME OPTIMIZE = {NCCHECK | NONE}

Options

Table 2-72. VOLUME OPTIMIZE parameter options and definitions

Option	Definition
NCCHECK	NCCHECK Disables channel 9 and channel 12 detection. When this option is selected, the host is not notified by the printing system each time channel 9 or 12 is recognized. Any skips to channel 9 or 12 are allowed as for any other channel. <i>NOTE: This option is supported on the FreeFlow Print Server LCDS systems only for Fuji Xerox markets. All other DP systems process it as NONE.</i>
NONE	No optimization actions are taken.

VOLUME OPTIMIZE parameter: Point to note The NCCHECK option is supported for FreeFlow Print Server LCDS systems only for Fuji Xerox markets. It is processed in other markets as if NONE were specified.

VOLUME OSCHN

Specifies the channel that the system uses to signal the end of a report that is generated by an IBM OS writer.

Syntax VOLUME OSCHN = *value*

Options

Table 2-73. VOLUME OSCHN parameter options and definitions

Option	Definition
<i>value</i>	Specifies the vertical format unit (VFU) channel that the system uses to signal the end of a report. When a skip (determined by the PCC field within a logical record) to the specified channel occurs, the IBM OS Writer banner page is considered found.

Default 9

VOLUME OSHDP

Specifies the number of header banner pages that will be generated by an IBM OS Writer.

Syntax VOLUME OSHDP = *value*

Options

Table 2-74. VOLUME OSHDP parameter options and definitions

Option	Definition
<i>value</i>	Specifies the number of header pages that precede the report.

Default 0

VOLUME OSTLP

Specifies the number of trailer banner pages that are generated by an IBM OS writer.

Syntax VOLUME OSTLP = *value*

Options

Table 2-75. VOLUME OSTLP parameter options and definitions

Option	Definition
<i>value</i>	Specifies the number of trailer pages that follow the report.

Default 0

VOLUME RMULT

Specifies a multiplication factor that the record length uses to determine the true record length.

Syntax VOLUME RMULT = *value*

Options

Table 2-76. VOLUME RMULT parameter options and definitions

Option	Definition
<i>value</i>	An integer from 1 to 15 that is used as a multiplication factor to determine the length of the record.

Default 1

VOLUME TCODE

Specifies the set of type assignments to use for masked comparisons.

Syntax VOLUME TCODE = {*tcode* *Type* | *label*}

Options

Table 2-77. VOLUME TCODE parameter options and definitions

Option	Definition
<i>rcode Type</i>	Specifies one of the following standard character sets for which type assignments are defined by default: <ul style="list-style-type: none"> • ASCII • BCD • EBCDIC • H2BCD • H6BCD • IBMCD • PEBCDIC By coding any one of the keywords, you are furnished with a set of character to type assignments.
<i>label</i>	Specifies an identified label of a TCODE parameter that defines a set of type assignments.

Default EBCDIC

VOLUME UNPACK

Specifies the unpacking method of the input data when unpacking is required.

Syntax VOLUME UNPACK = {NONE | T4X3 | T4X3H2 | UNIVAC}

Options

Table 2-78. VOLUME UNPACK parameter options and definitions

Option	Definition
NONE	Does not perform the unpacking operation.
T4X3 or T4X3H2	Specifies unpacking routines in which 6-bit characters are extracted and restored as 8-bit bytes.
UNIVAC	Specifies an unpacking routine used for UNIVAC tapes, although you can specify any of these routines independent of the HOST type.

Default NONE

VOLUME VCODE

Specifies a table of character type codes to use with the CRITERIA command, VALUE parameter. This parameter accommodates the different presentations of numbers used in different countries, thereby ensuring accurate comparisons of numeric values.

Syntax VOLUME VCODE = (*translation type*, *keyword*)

Options

Table 2-79. VOLUME VCODE parameter options and definitions

Option	Definition
<i>translation type</i>	Specifies a standard code translation set. The following options are available: <ul style="list-style-type: none"> • ASCII • BCD • EBCDIC • H2BCD • H6BCD • IBMCD • PEBCDIC Coding any one of the keywords gives a set of character-to-type assignments.
<i>keyword</i>	Specifies a standard character Type code table. The options for this parameter are shown in the following table.

Keyword options The following “Character Type code options” table defines a character Type code for each of the characters in a character code translation set.

Table 2-80. Character Type code options

Type	Thousands separator	Decimal point
VCODE0	comma	period
VCODE1	period	comma
VCODE2	comma, space, apostrophe	period
VCODE3	period, space, apostrophe	comma
VCODE4	space	period
VCODE5	space	comma
VCODE6	period, space	dollar sign
VCODE7	comma, space, apostrophe	period

There are eight unique character Type codes in a character code translation set, as defined in the following “Unique character Type codes” table.

Table 2-81. Unique character code types

Type	Characters
0	All characters except those defined below
1	Open parentheses
2	Thousands separator character
3	Close parentheses
4	Minus sign
5	Decimal point
6	0
7	1, 2, 3, 4, 5, 6, 7, 8, 9

Default EBCDIC, VCODE0

VOLUME VCODE examples

```
VOLUME CODE=ASCII, VCODE=(ASCII, VCODE0)
```

In the example above, the command utilizes the character type code table applicable to the United Kingdom or the United States to process and compare numeric values through an ASCII code translation.

```
VOLUME CODE=EBCDIC, VCODE=(EBCDIC, VCODE1)
```

In the above example, the command utilizes the character Type code table applicable to France to process and compare numeric values through an EBCDIC code translation.

VOLUME command examples

The following are sample VOLUME commands for different host types.

Online:

```
VOLUME HOST=IBMONL, CODE=EBCDIC;
```

Offline:

```
VOLUME  HOST=UNIVAC, LABEL=STANDARD,  
         UNPACK=T4X3, CODE=ASCII,  
         LCODE=ASCII;
```

```
VOLUME  HOST=IBMOS;
```

```
VOLUME  HOST=B6700, LABEL=ANSI, BMULT=6,  
         RMULT=6;
```

```
VOLUME  HOST=OCTDUMP, CODE=H6BCD,  
         UNPACK=T4X3;
```

3. Using logical processing

Logical, or special, processing enables you to specify logical functions that will be performed on a record or a set of records. During job processing, the system tests the value of a specified *test expression* and directs the flow of processing based on the result of the test.

In order to specify a logical processing function, you must define constants (character strings or values) for which the system will look in the job data records, and the criteria (such as “equal,” “greater than,” and so forth) that will be used to compare the record to the specified constant.

Types of commands for logical processing

Two types of commands are used to specify logical processing:

- **Constant definition commands.** Two commands, CRITERIA and TABLE, define the constants or conditions in the job for which the system will test during job processing.
- **Logical processing commands.** These commands specify which criteria the system will test for, and the action the system will perform when it encounters one of these criteria.

Coding order of command types

When you are creating a JSL that uses logical processing, you code the component commands in the following order:

1. Code the TABLE command first to define your constants (if any are needed). These must precede the CRITERIA CONSTANT command that references them.
2. Code the CRITERIA commands next. These commands must come **after** the tables they reference.
3. Code the logical processing commands after you have coded the CRITERIA commands that they reference.

Test expressions

To define a logical processing command fully, you must specify one or two fields in the record that will be tested. In general, a logical processing command has the following format:

```
parameter command-keyword = options, ...,  
command-keyword TEST = testexp, ...;
```

The *testexp* parameter of a logical processing command defines a test that will be performed on either one or two specified fields and their associated contents. The test result is a TRUE or FALSE value. The fields in the current data record are compared with either of the following:

- One or more constants associated with the test, using either an EQUAL (EQ) or a NOT EQUAL (NE) operator.
- The contents of the field in prior records using a NOT EQUAL (NE) operator.

The basic element used to describe a test for a logical function is the CRITERIA command.

Coding a test expression

To activate testing, you code the TEST parameter of any logical processing command that has one. (For information on constructing the TEST parameter, refer to the command description, Syntax section, for the command you want to code.)

Criteria identifiers (criids) In the TEST parameter, you must include one or two criteria identifiers (*criids*), which you specify in the CRITERIA command. These *criid* options are the identifiers of the CRITERIA commands that specify the location of the test fields and what they will be compared to.

Exceptions There are two special cases in which the TEST parameter does not function as described above, and the CRITERIA command fails:

- For offline printing: the record is too short to include the whole field that is being tested. (For online printing, the record is padded with blanks to make it large enough.)

- A specific print line range is specified by the LINENUM parameter, and the line or lines that are being tested contain no record (that is, the lines have been skipped or spaced over).

If the test specifies a change mode function, the CRITERIA command fails because no change has occurred. However, the value for the LAST option of the CHANGE parameter remains unchanged for comparison with the next record.

Test expression syntax

The following diagram shows the syntax for a definition of the test expression for a logical processing command. The test definition is referenced in the syntax of each of the logical processing commands that follow it.

```

TEST= criid;
TEST=(criid1, AND, criid2);
TEST=(criid1, OR, criid2);
tabid: TABLE          CONSTANT=sc;
criid: CRITERIA        CONSTANT=(offset, length, {EQ|NE}, table);
command-keyword TEST=criid;
```

Test expression example

If only one criteria identifier is present (C1 in this case), the test is satisfied if the criterion is met. If the test is satisfied, the logical processing function is performed on the tested field.

When two criteria identifiers are present, a test expression that contains OR (such as the RSELECT TEST command in the following example), the test is satisfied if either one of the two identifiers (in this case, C1 or C2) is present.

```

T1: TABLE          CONSTANT=' Page 001' ;
C1: CRITERIA        CONSTANT=(100, 8, EQ, T1) ;
C2: CRITERIA        CONSTANT=(0, 3, NE, LAST) ;
RSELECT            TEST=(C1, OR, C2) ;
```

Logical processing commands that have TEST parameters

The logical processing commands with TEST parameters are listed below. Each individual command should be specified only once per job descriptor entry. If any one command is specified more than once, the last occurrence is used without notification of any error.

- BANNER
- RAUX
- RDELETE
- RFEED
- ROFFSET
- RPAGE
- RRESUME
- RSELECT
- RSTACK
- RSUSPEND

Commands that define criteria and constants

The following table summarizes the commands that define constants that can be specified in logical processing commands.

Table 3-1. Summary of commands that define logical criteria and constants

Command	Function
TABLE	Builds a table of constants against which input data fields are checked to determine if a logical processing function will be performed.
CRITERIA	Specifies criteria for testing data records against constants or values.

TABLE command

The TABLE command builds a table of constants, which can be referenced by logical processing commands. (TABLE is the first command discussed in this section because it is usually coded before the other types of commands that are related to logical processing.)

Each constant that is included in a referenced TABLE command is examined by the system to see if it is equal in value to the input data field specified in the CONSTANT parameter of the CRITERIA command.

NOTE: The TABLE command must precede any CRITERIA command that references it.

This command requires an identifier of the type *ac* (at least one alpha character required).

TABLE command parameters

The following table summarizes the TABLE command parameters.

Table 3-2. Summary of TABLE command parameters

Parameter	Specifies	Online	Offline	DJDE
TABLE CONSTANT	Defines string constants against which input data fields are checked for logical processing.	Y	Y	N
TABLE MASK	Permits character positions of a string to be ignored or tested for type attributes.	Y	Y	N

The following section describes the syntax of the TABLE command parameters and explains their options.

TABLE CONSTANT

Specifies the content of one or more string constants.

Syntax *ac*: TABLE CONSTANT = {*sc* | (*sc*₁ [, *sc*₂] [,...])}

Options

Table 3-3. TABLE CONSTANT parameter options and definitions

Option	Definition
<i>sc</i>	<i>string constant.</i> <i>sc</i> is a string composed of literal characters and masking characters (as defined by the MASK parameter of the TABLE command). All string constants must be of the same length in bytes. The number of bytes for all constants in the table (after conversion of any hexadecimal or octal constants) is limited to 255 bytes.

Default No default

TABLE MASK

Defines mask characters used within string constants (specified by CONSTANT parameter). Also indicates which characters denote special type testing and what that type is.

Syntax *ac*: TABLE MASK = (*ignorechar* [, *charspec*₁ [, *charspec*₂ [,...]]])

Options**Table 3-4. TABLE MASK parameter options and definitions**

Option	Definition
<i>ignorechar</i>	Specifies a character that appears in positions that will not be compared within a string constant.
<i>charspec</i> _{<i>i</i>}	<i>character specification</i> Specifies a character that appears in positions within a string constant where a test for type <i>i</i> characters will be performed.

Default No default

**TABLE MASK
parameter: points
to note**

- Any valid character in the data character set, such as ASCII and EBCDIC, may be used in the MASK parameter as a mask character.
- Any character that is not explicitly tested for absolute equality by a TABLE command may be defined by the table MASK parameter as a mask character.
- MASK parameter character definitions apply only to the TABLE command in which the definition occurs. As in unmasked comparisons, it is possible to specify multiple strings in the CONSTANT parameter.
- To define a character specification use the form '*char*' or ('*char*', '*char*', ...'*char*').
- Mask characters should be defined using the same string type as in the string specified in the CONSTANT parameter.

TABLE command: points to note

- In an unmasked comparison (using only the CONSTANT parameter of the TABLE command), characters in the string constant that correspond positionally to those in the input data string are tested for absolute equality, one character at a time.
- In a masked comparison (using the MASK parameter), before the comparison is done for each character position, the character in that position in the string constant is compared against the mask characters that are specified by the user. If a match is found, the corresponding data character is ignored, or is tested only for the type indicated by the mask character.

TABLE command examples

Following are some examples of the TABLE command.

Example 1 In the sample TABLE commands below, the identifiers T1, T2, and T3 are each referenced by a CRITERIA command.

```
T1: TABLE      CONSTANT=( '$$/ ' );
T2: TABLE      CONSTANT=( '//JOB ', '//EXEC' );
T3: TABLE      CONSTANT=( 120 ) '* ' ;
```

Example 2 The following example illustrates the use of the MASK parameter to determine whether a particular field in a data record contains one of several different six character serial number formats. Possible formats are: xx999x, x999x9, and 99x999.

In this example, x represents any alphabetic character, and 9 represents any numeric character.

If the input code type is EBCDIC, the VOLUME command includes TCODE=EBCDIC. The TABLE command to find the format x999x9 within the input data stream would look like:

```
T1: TABLE      MASK=( '?', '%', '@' ),
                CONSTANT=( '@%%@%' );
```

The characters used in the MASK parameter occupy numbered positions, beginning with 0 and separated by commas. These position numbers in the MASK parameter are used as *type* numbers. Therefore, the associations of mask characters to type that are listed in the following table are made for the above TABLE command.

Table 3-5. Mask associations of character to type for the TABLE command

Character	Type	Meaning
?	None	Make no comparison
%	1	Per standard default, any numeric (0 through 9)
@	2	Per standard default, any alphabetic (A through Z, a through z)

- The data string characters that correspond positionally to those occupied by @ in the CONSTANT parameter are tested for type 2 (in the example, alphabetic A through Z or a through z).
- Characters that correspond positionally with a % are tested for type 1 (numeric, 0 through 9).
- If the string that is specified in the CONSTANT parameter were to include a ?, the corresponding data character from the input stream would be considered equal without any comparison being made, because it is an “ignore” type mask character.

Example 3 Assume the TABLE command in example 2 is changed as follows.

```
T2: TABLE      MASK=( '?', '%', '@' ),  
                CONSTANT=( 'A7%%@%' );
```

When the first two character positions of the CONSTANT parameter are checked for a mask character (as specified in the MASK parameter), none is found. Exact character matches between the input data string characters and the CONSTANT parameter characters (in this case, A7) are required for those two positions. Therefore, in this example, only data strings that begin with A7 can possibly pass the entire test.

Example 4 The TABLE command below sets up the character to type associations shown in the following table.

```
T2: TABLE MASK=('*',':','!'),
      CONSTANT=('DATE :/:/:/:: ID!!!!');
```

Table 3-6. Character to type associations

Mask position	Mask character	Character type	Meaning
0	*	None	Make no comparison
1	:	1	Any numeric (0 through 9)
2	!	2	Any alphabetic (A through Z, a through z)

A logical test using this TABLE command examines a field of an input data record to determine if the following conditions are met:

- The word *DATE* is present.
- The */* is in the right place.
- The date itself is numeric (type 1).
- The string ID is present.
- The first three characters after ID are alphabetic (type 2).

CRITERIA command

The CRITERIA command specifies that a test for a particular logical function will be performed on a specific field in the record. This command requires an identifier, which is specified with the TEST parameter in any of the logical processing commands. Specific TEST parameters are described in the individual logical processing command sections.

CRITERIA command modes

There are three formats or modes for CRITERIA commands: Constant mode, Change mode, and Value mode. You select the mode by specifying either the CHANGE parameter, the CONSTANT parameter, or the VALUE parameter of the CRITERIA command in your JSL.

NOTE: A command may specify only one mode. However, CRITERIA TABLES may specify either Change mode, Constant mode, or both functions; there are no restrictions on their usage or combination in tables.

- Constant mode** In Constant mode (that is, when the CRITERIA CONSTANT parameter has been specified), you must specify the location, length, and contents of a fixed field within a record. Each record is examined at the specified location to determine if the constant is present (the identifier *tabid* defines the table containing the constant). If the specified constant is present and equal (EQ), the CRITERIA command is true; if the constant is present and not equal (NE), the command is false.
- Change mode** In Change mode (that is, when the CRITERIA CHANGE parameter has been specified), you must specify the length and location of a control field in each record. When the content of the control field of one record differs from the content of the control field of the previous record, the CRITERIA command is true.
- Value mode** In Value mode (that is, when the CRITERIA VALUE parameter has been specified), you compare two numerical values, testing if they are equal (EQ) or not equal (NE), if one value is greater than (GT) or less than (LT) the other value, or if one value is greater than or equal to (GE) or less than or equal to (LE) the other value. If the test on the two values is satisfied, the CRITERIA command is true; if not, the command is false.

Using the CRITERIA command

To complete the description of the entire test for a logical function, the TEST parameter of a logical processing command must specify either one or two CRITERIA commands.

- Specifying one CRITERIA command** If only one test is to be performed to determine the value of a particular logical processing function, the form of the TEST parameter is as follows:

```
TEST = criid;
```

The *criid* is the identifier for the particular CRITERIA command. Parentheses in this format are optional.

- Specifying two CRITERIA commands** If two CRITERIA commands are needed to determine the true or false value for a logical processing function, they may be linked by either AND or OR. The formats of these TEST parameters may be as follows:

```
TEST = (criid1, AND, criid2);
```

or

```
TEST = (criid1, OR, criid2);
```

The $criid_1$ and $criid_2$ are the identifiers for two CRITERIA commands. The parentheses in this format are required.

For example, the following three commands specify that a record should be selected (RSELECT parameter) if a particular field is equal to a given string constant (sc):

```
T1: TABLE      CONSTANT = (sc) ;
C1: CRITERIA   CONSTANT = (offset, length, EQ, T1) ;
RSELECT TEST= (C1) ;
```

NOTE: A compiler error occurs if you attempt an AND test on two different criteria that appear on two line ranges that do not overlap. For example, a logic problem occurs with the ROFFSET command if Criterion 1 is limited to line 3, and Criterion 2 is limited to line 2. In this scenario both criteria could never be satisfied on the same line.

Specifying the CRITERIA LINENUM parameter

The LINENUM parameter of a CRITERIA command specifies that only a subset of the data record in a report will be tested for the user defined criteria. This subset is specified as a set of contiguous line numbers for a logical page. If the carriage control specification for a given record places the record within the set of lines specified by LINENUM, the record is examined according to the CRITERIA command. Otherwise, it is not processed.

String comparisons

String comparisons for logical processing are specified using the CRITERIA and TABLE commands. These comparisons test for one of the following conditions:

- **Absolute equality:** Tested by either a Change mode CRITERIA command or by a Constant mode CRITERIA command which references a TABLE command that does not have a MASK parameter coded. Refer to Processing sequence 1 in the “Commands that specify string comparisons” figure later in this chapter.
- **Equality under a mask:** Tested when the referenced TABLE command has a MASK parameter coded. Refer to Processing sequence 2 in the “Commands that specify string comparisons” figure later in this chapter.

Comparing strings for equality under a mask means that the user has specified, for each character position of the input data string, that the test performed is one of the following:

- Compare the character in that position for absolute equality.
- Ignore the character in that position (consider the character, whatever it is, to compare as equal).
- Compare the character in that position for type, for example, alphabetic, numeric, or some specially defined type.

Character types

An attribute called *type* may be associated with any character or characters in a character set. The possible types are identified by the integers 1 through 7. Any single character in a set, for example (\), either has a type (type 1, type 2, type 3, and so forth) or it does not. If a character has no type, it is referred to as “untyped.” It is possible for any character to be untyped, to have one type, or to have multiple types (for example, to be type 2 and type 3).

For every standard character set, there is a set of standard default type assignments which, for most applications, is sufficient without modification. These assignments are defined as follows:

- The numeric characters 0 through 9 are type 1 characters
- The uppercase and lowercase alphabetic characters A through Z and a through z are type 2 characters.

Use of these default type assignments can be invoked by the VOLUME TCODE command.

The defining of types, that is, the associating of type numbers with any group of characters in a character set, is described in the “TCODE command” section of the “Specifying input parameters” chapter.

Masked comparisons using default type assignments

Performing masked comparisons using unmodified standard default type assignments requires coding the following:

- **TCODE parameter of the VOLUME command:** Allows you to select a set of standard default type assignments.
- **MASK and CONSTANT parameters of one or more occurrences of the TABLE command:** Together, these parameters define exactly how the comparisons for that TABLE command are made using the set of type assignments specified by the TCODE parameter of the VOLUME command.

Masked comparisons using nondefault type assignments

Performing masked comparisons using either a nonstandard character set or a standard set for which the default type assignments are not suitable requires coding the following:

- **TCODE command:** This command is used either to modify a set of standard default type assignments or to define a completely new set (shown in processing sequence 3 in the following figure).
- **TCODE parameter of the VOLUME command:** This parameter is used to specify the set of assignments defined by the TCODE command as the one used for masked comparison.
- **The MASK and CONSTANT parameters of one or more occurrences of the TABLE command:** The use of these parameters is the same as for comparisons using unmodified defaults, explained in the previous section.

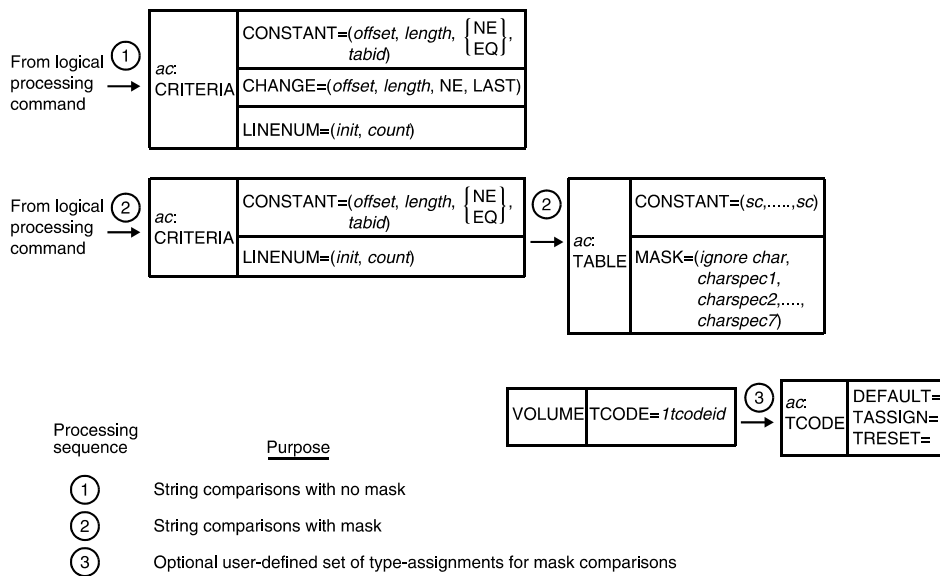

Figure 3-1. Commands that specify string comparisons

CRITERIA command parameters

A CRITERIA command may contain only one specification of one of these parameters: CONSTANT, CHANGE, or VALUE. In addition, it may optionally contain the LINENUM parameter. Thus, one or two parameters must be provided in the CRITERIA command.

The following table summarizes the CRITERIA command parameters and gives their uses and functions.

Table 3-7. Summary of CRITERIA command parameters

Parameter	Specifies	Online	Offline	DJDE
CRITERIA CHANGE	Specifies the Change mode criteria for a logical processing function; that is, the length and location of a control field in each record, to which the content of the preceding record is compared.	Y	Y	N
CRITERIA CONSTANT	Specifies the Constant mode criteria for a logical function; that is, the location and length of a fixed field within a record that will be searched for a constant (also specified by this parameter).	Y	Y	N
CRITERIA LINENUM	Specifies the range of numbers of consecutive lines on which records will be tested for the specified criteria.	Y	Y	N
CRITERIA VALUE	Specifies a magnitude comparison between numeric character strings	Y	Y	N

CRITERIA CHANGE

Defines test specifications for a logical processing function with Change mode criteria. Specifies the length and location of a control field in each record, to which the next record is compared. When the content of one record differs from the content of the control field of the previous record, the criteria test is TRUE.

Syntax *ac*: CRITERIA CHANGE = (*offset*, *length*, NE, LAST)

Options

Table 3-8. CRITERIA CHANGE parameter options and definitions

Option	Definition
<i>offset</i>	The offset in bytes (relative to zero) from the start of the user portion of the record to the control field within the record.
<i>length</i>	The length in bytes of the control field. Its range is 1 to 255.
NE	Indicates “not equal to.”
LAST	Indicates that the control field of the current record is being compared to the control field of the previous (last encountered) record. If a control field of the current record is less than the specified length, the comparison is not done and the test fails.

Default No default

**CRITERIA
CHANGE
parameter: points
to note**

- In online jobs, the host truncates trailing blanks. You may add blank character spaces to any control fields that are shorter than the specified length, so the system can make a comparison.
- The data field contents are not interpreted as a number, but as individual bytes of data. Therefore, comparison of the numeric values of two data fields is not relevant. (For example, “2.00” does not equal “2.000.”) Use the VALUE parameter to perform this kind of comparison.
- When Change Mode CRITERIA commands are evaluated, a string from the current line is compared with a string saved from the corresponding part of a previous line. Refer to “String comparisons” earlier in this chapter for information on use of strings in logical processing commands.
 - If the comparison is not equal, the string from the current line becomes the saved comparison string for subsequent lines and the criteria is considered true.
 - If two records are overprinted on the same line but with different data in the field defined by the CRITERIA command, the string from the last overprint record becomes the saved comparison string and the CHANGE CRITERIA is satisfied.

- If the LINENUM parameter is used, lines within the specified range are processed normally, and lines outside the range are not evaluated. Thus, Change mode comparison strings are not saved from lines outside of a LINENUM range. Refer to the “CRITERIA LINENUM” parameter section in this chapter for information on using this parameter of the CRITERIA command.
- “No print” records (carriage control specifies no printing but only skipping or spacing) are evaluated for logical processing.

**CRITERIA
CHANGE
parameter syntax
example**

A Change mode CRITERIA command can be coded as follows:

```
criid: CRITERIA  CHANGE= (offset, length, NE, LAST),  
                    LINENUM= (init, count);
```

CRITERIA CONSTANT

Specifies that the content of a record will be compared to the values that were specified in a TABLE command with the identifier *tabid*. The CRITERIA CONSTANT specification is referenced by the TEST parameter of the logical processing command that follows it in the JSL.

CONSTANT also specifies the location and length of the fixed field within a record that will be searched for the constant. The field to be compared is located the number of bytes indicated by the *offset* variable from the start of the user portion of the record. The field has a length the number of bytes indicated in the *length* variable.

When the field in the record matches a constant in the table and is equal (EQ), the CRITERIA command is TRUE, and the processing that was specified by the parameter is performed. If the field matches a constant in the table, but is not equal (NE), the command is FALSE.

Syntax *ac*: CRITERIA CONSTANT = (*offset*, *length*, {EQ | NE}, *tabid*)

Options

Table 3-9. CRITERIA CONSTANT parameter options and definitions

Option	Definition
<i>offset</i>	The offset in bytes (relative to zero) from the start of the user portion of the record to the field in the record being compared.
<i>length</i>	The length in bytes of the test field. Its range is 1 to 255.
EQ	Indicates the operation EQUAL TO.
NE	Indicates "not equal to."
<i>tabid</i>	<i>table identifier.</i> The identifier of a table, specified in the TABLE command, that contains the constant to which the test field is compared.

Default No default

CRITERIA CONSTANT parameter syntax example

The following CRITERIA command syntax diagram describes a test for a subfield equal to a specific constant table.

criid: CRITERIA CONSTANT=(*offset*, *length*, EQ, *tabid*);

In the above syntax, the CONSTANT parameter specifies that the content of a record is to be compared to the values that were specified in a TABLE command with identifier *tabid*. Refer to the "TABLE command" section in this chapter for an explanation of the *tabid* parameter.

The subfield that will be compared is located the number of bytes indicated by the *offset* variable from the start of the user portion of the record. The subfield has a length the number of bytes indicated in the *length* variable. When the subfield in the record matches a constant in the table, the CRITERIA command is TRUE and the processing specified by the parameter is completed or acted upon.

CRITERIA LINENUM

Specifies the range of consecutive line numbers for which the CRITERIA command is fully evaluated.

Syntax CRITERIA LINENUM = (*init*, *count*)

Options

Table 3-10. CRITERIA LINENUM parameter options and definitions

Option	Definition
<i>init</i>	<i>initial line</i> An integer specifying the number, on each logical page, of the beginning line for which the CRITERIA command is evaluated.
<i>count</i>	An integer specifying the consecutive number of lines (starting with the initial line) for which the CRITERIA command is evaluated.

Default All lines

CRITERIA VALUE

Defines test specifications for a logical processing function with the Value mode criterion.

Use the CRITERIA VALUE parameter to compare two numeric values. The system returns a true value if the variable text data satisfies the test criteria.

Syntax *ac*: CRITERIA VALUE = (*offset*, *length*, {EQ | NE | LT | LE | GT | GE}, *tabid*)

Options

Table 3-11. CRITERIA VALUE parameter options and definitions

Option	Definition
<i>offset</i>	The offset in bytes (relative to zero) from the start of the user portion of the data record to the field with the character string that is specified in the associated TABLE. <i>NOTE: Offset may be a negative value.</i>
<i>length</i>	The length in bytes of the test field. Its range is 1 to 255. <i>NOTE: This length may differ from the length of the associated TABLE CONSTANT string.</i>
EQ	Indicates the operation "equal."
NE	Indicates the operation "not equal."
LT	Indicates the operation "less than."
LE	Indicates the operation "less than or equal."
GT	Indicates the operation "greater than."

Table 3-11. CRITERIA VALUE parameter options and definitions

Option	Definition
GE	Indicates the operation "greater than or equal."
<i>tabid</i>	<i>table identifier.</i> The identifier of a table, specified in the TABLE command, containing the numeric value to which the test field is compared.

Default No default

**CRITERIA VALUE
parameter: points
to note**

- A test criteria specifying the EQ operator may return a true result even though the character strings being compared are not identically equal. For example, '0000' is equal to '0,' '0.0,' '\$0.00,' and so forth.
- A numeric character string is compared with a constant character string only if the numeric string is properly constructed. The system observes the following rules when evaluating a numeric character string:
 - A properly constituted numeric character string should consist of a single sequence of numeric characters, which may be interspersed only with characters from a rigidly defined set of "separator" characters that are allowed in the format of a decimal number.

Improperly constructed numeric character strings would include such strings as '1, 2, 3', '957N4218', and '00–123'.
 - All numeric character strings are evaluated as decimal numbers, with a decimal point separating the integer portion of the number from the fractional portion of the number.

Due to international variations in decimal number formats, the characters that are interpreted as the decimal point, and the characters that are interpreted as the "thousands" separator are taken from the VCODE table that is specified in the VOLUME command. The VCODE command is used to specify the character translation code and/or the character type code, and must be specified if the VCODE command defaults are not applicable.

- Non-numeric characters, such as currency symbols, positive and negative number designators, and alphabetic text may only precede, follow, or enclose the numeric character string.

Valid character strings would include the following if the appropriate VCODE table is specified:

'\$(1,500.00)', '-1.500,00 DM', and 'kr-1.500,00'

- A numeric character string is evaluated as a negative number if a minus sign (–) either precedes or follows the string, or if the string is enclosed in a single set of parentheses.

Because of the simplified procedure used to determine negative numbers, the following occurrences make the string invalid:

- More than one opening parenthesis preceding the string
 - More than one closing parenthesis following the string
 - More than one minus sign.
- Leading zeros in the integer part and trailing zeros in the fractional part of a numeric character string, do not affect the value of the string. The “decimal point” character separates the integer part of a number from the fractional part. If a “decimal point” is not present, there is an implied decimal point at the end of an integer number.

The “thousands separator” is allowed within a numeric character string only if it is placed between groups of three digits going away from the “decimal point.” A “decimal point” or a “thousands separator” may appear repeatedly outside the numeric character string.

In VCODE0, the following are examples of valid numeric character strings: '50,000,' '0,000,50,' '.,,42,' '1.000,00,' and '.....5.'

- The referenced TABLE command may not use the MASK parameter.
- When more than one character string constant is specified in the TABLE command, the following occurs:
 - If the operator is EQ, the system tests the variable data against all the values in the TABLE CONSTANT statement. If any of the values are equal, the system returns a TRUE value.

- If the operator is NE, LT, GT, LE, or GE, the system tests the variable data against only the first value in the TABLE CONSTANT statement.

Performance considerations with the CRITERIA VALUE parameter

CRITERIA VALUE affects system performance in relation to the number of characters per page involved. This is a function of the number of tests performed, the number of character columns in each test, and the number of lines in which the criteria is evaluated.

The following actions can help you reduce the impact of CRITERIA VALUE processing on your printer throughput speed when printing your applications:

- Restrict the range of lines tested via the LINENUM parameter. This avoids time spent with unnecessary testing of lines that are not supposed to meet the criteria in any case. For example, in a forms application with an address field at the top and mailing information at the bottom, you might use the LINENUM command to prevent tests on the data associated with the address label and mailing info.
- Restrict the columns tested in the CRITERIA VALUE parameter to the shortest possible length, to avoid testing blank space. However, you should be sure that you are providing for all possible values. For example, you should not limit the column size to space enough for only \$999,999 if there is a chance that \$1,000,000 might occur on a rare occasion.
- For applications in which either CRITERIA VALUE or CRITERIA CONSTANT can be used, choose CRITERIA CONSTANT, because it has less performance impact.
- When coding numeric values into TABLE CONSTANTs, for maximum performance, specify the shortest possible numeric string. Omit superfluous leading zeros, trailing zeros, white space, and “thousands” separators. For example, use ‘50000’ instead of ‘050,000.00.’ Because the former expresses the same value as the latter but with only half as many characters, it takes much less time to process.

CRITERIA VALUE parameter syntax example

criid: CRITERIA VALUE=(*offset*, *length*, GT, *tabid*),
LINENUM=(*init*, *count*);

Logical processing command descriptions

Logical processing commands cause the system to test input data records in the job against specified criteria. If the criteria are satisfied, the system performs specific actions.

The commands described in the following sections provide logical processing functions. The following table summarizes the logical processing commands and the functions that are associated with them.

Table 3-12. Summary of commands associated with logical processing functions

Command	Specifies
BANNER	Specifies the number of consecutive banner pages the system must detect before it recognizes the end of the report.
RAUX	Specifies test for feeding a page from the tray configured with the AUX stock.
RDELETE and RSELECT	RDELETE: Specifies a test for deleting a record. RSELECT: Specifies a test for selecting a record.
RFEED	Changes stock names on a page basis without using DJDEs.
ROFFSET	Specifies a test for offsetting a page in the stacker.
RPAGE	Specifies a test for repositioning a logical page.
RRESUME and RSUSPEND	RRESUME: Specifies a test for resuming printing. RSUSPEND: Specifies a test for stopping printing.
RSTACK	Specifies a test for detecting the end of a report.

BANNER command

Specifies the number of consecutive banner pages the system must detect before it will recognize the end of the report. The BANNER command includes a test expression to detect and count the header or trailer pages that are used to separate reports.

Banner pages are header or trailer pages that separate printed reports from each other in the stacker. Header pages are found at the start of a report; trailer pages are found at the end of it.

The system recognizes the end of a report when enough banner pages have been printed to satisfy the “end of report” test criteria.

BANNER command parameters

The following table summarizes the BANNER command parameters.

Table 3-13. Summary of BANNER command parameters

Parameter	Specifies	Online	Offline	DJDE
BANNER HCOUNT	Specifies the total number of consecutive header pages that are recognized at Start of Report.	Y	N	N
BANNER HJOBNO	Specifies which subfield of the first record to satisfy banner selection criteria will be displayed as a customer job number.	Y	N	N
BANNER HRPTNA	Specifies which subfield of the first record to satisfy banner selection criteria will be displayed as a report name.	Y	Y	N
BANNER TCOUNT	Specifies the total number of consecutive trailer banner pages that are needed for detection of the end of the report.	Y	N	N
BANNER TEST	Specifies the test expression for banner page detection.	Y	N	N
BANNER TYPE	Specifies that banner pages will be treated as data pages.	Y	N	N

The following sections describe the syntax of the BANNER command parameters and explain their options.

BANNER HCOUNT

Specifies the maximum number of consecutive header banner pages that will be recognized at Start of Report.

Syntax BANNER HCOUNT = *value*

Options

Table 3-14. BANNER HCOUNT parameter options and definitions

Option	Definition
<i>value</i>	Maximum number of consecutive header pages that will be recognized at the start of the report

Default 0

BANNER HCOUNT parameter: point to note The FreeFlow Print Server LCDS systems do not recognize header banner pages if an HCOUNT value of 0 is specified.

BANNER HJOBNO

Specifies that, for each report, a subfield of the first record that satisfies the banner selection criteria is to be displayed as a customer job on the user interface Job Manager window.

Syntax BANNER HJOBNO = {(*offset, length*) | NONE}

Options

Table 3-15. BANNER HJOBNO parameter options and definitions

Option	Definition
<i>offset</i>	Amount of space, specified in bytes (relative to zero), from the start of the user portion of the record to the subfield within the record.
<i>length</i>	The number of bytes in the subfield (0 to 16).
NONE	Specifies that no HOST job number is to be selected.

Default NONE

BANNER HRPTNA

Specifies that for each report a subfield of the first record that satisfies the banner selection criteria is to be displayed as the report name on the user interface Job Manager window. (For jobs specifying HCOUNT=0 [meaning no headers are present; only trailers], the report name is associated with the report that precedes the trailer banner page.)

Syntax BANNER HRPTNA = {(*offset, length*) | NONE}

Options

Table 3-16. BANNER HRPTNA parameter options and definitions

Option	Definition
<i>offset</i>	Amount of space, specified in bytes (relative to zero), from the start of the user portion of the record to the subfield within the record.
<i>length</i>	The number of bytes in the subfield (1 to 16).
NONE	Specifies that no report name is to be selected.

Default NONE

BANNER TCOUNT

Specifies the total number of consecutive trailer banner pages that must be detected to recognize the end of the report.

Syntax BANNER TCOUNT = *value*

Option

Table 3-17. BANNER TCOUNT parameter option and definition

Option	Definition
<i>value</i>	Specifies the total number of consecutive trailer pages that must be detected to recognize the end of the report.

Default 0

BANNER TEST

Defines the test expression for detection of a banner page for either Change Mode or Constant Mode criteria.

Syntax BANNER TEST = *testexp*

Options

Table 3-18. BANNER TEST parameter options and definitions

Options	Definitions
<i>testexp</i>	<i>test expression</i> Refer to “Coding a test expression” earlier in this chapter for the format and syntax of a <i>testexp</i> . If a test expression is satisfied, the page containing the record tested is considered a banner page.

Default No default

BANNER TYPE

Specifies the use of selected data pages as banner pages when reports do not contain this information.

Syntax BANNER TYPE = {DATA | BANNER}

Options

Table 3-19. BANNER TYPE parameter options and definitions

Option	Definition
DATA	Allows you to specify selected data pages to function as banner pages for report separation. This type of banner page is printed with a form (if specified). In duplex mode, it is printed as a duplex page with data on the back. If multiple PDE BEGINS and TYPE=DATA parameters are specified, only the first header page of the report is repositioned to the first logical page of a new physical sheet.
BANNER	Specifies that the banner pages will print without forms. In duplex mode, the banner pages are printed with blank backs.

Default BANNER

BANNER TYPE parameter: point to note Use DATA when reports do not contain user specified banner pages. Use BANNER when reports contain user specified banner pages.

BANNER command: points to note

- Field content captured via HJOBNO and HRPTNA is translated using the CODE table in effect when the record containing them is processed.
- The following table shows the effect of the TCOUNT and HCOUNT parameters of the BANNER command under the conditions listed, and the results of each.

Table 3-20. Summary of BANNER command parameter conditions and results

Condition	Parameter	Result
System positions to Top of Form after processing the end of the report.	If TCOUNT= 0	The page after the first header is positioned at TOF.
	If TCOUNT not 0	The page after the last trailer is positioned at TOF.
A job is running with header pages only as the offset criteria.	TCOUNT = 0	Job parameters such as DJDEs and page numbering for a given report are applied to the first header page of the following report.
The system encounters a page other than a banner page.	TCOUNT = 0	The next banner page is treated as the first header of a new report, even if HCOUNT is not satisfied.
The system encounters a non-banner page before HCOUNT is satisfied.	HCOUNT not 0 and TCOUNT not 0	The system assumes that the report has fewer header pages than were specified and begins looking for trailer pages.

BANNER command examples

Following are examples of the BANNER command.

Example 1 The following commands define the BANNER criteria for a job with two trailer pages and one header page. A string of 120 asterisks beginning in position 1 of line 66 occurs on header and trailer pages.

```
T1: TABLE          CONSTANT= (120) '*' ;
C1: CRITERIA        CONSTANT= (0, 120, EQ, T1) ,
                    LINENUM= (66, 1) ;
                    BANNER      TEST=C1, HCOUNT=1, TCOUNT=2,
                    HJOBNO= (121, 6) ;
```

Example 2 If a job stream has two trailer pages with the character string DATE=*mm/dd/yy* appearing on line 10 or 11 and beginning in print position 20, the BANNER criteria could be coded as follows:

```
T2: TABLE      CONSTANT= ('DATE=::/::/::'),  
                    MASK= (':');  
  
C2: CRITERIA    CONSTANT= (19,13,EQ,T2),  
                    LINENUM= (10,2);  
  
BANNER          TEST=C2, HCOUNT=0, TCOUNT=2;
```

The MASK parameter specifies a masking character. The CONSTANT parameter specifies both the constant data being compared and the character positions in which variable data is not being compared. In this example, positions 1 through 5 (DATE=), as well as positions 8 and 11 (the /'s), of the specified character string contain fixed data. Positions 6, 7, 9, 10, 12, 13, 14, and 15, which are identified by the mask character (:), contain variable data and are not compared.

Header page count has been set to zero because no headers are present in the job stream (that is, none are being tested for).

BSELECT and BDELETE commands

Blocks that are interspersed within one offline report or file may be either selected for or deleted from printing by use of the BDELETE and BSELECT commands.

These commands can also be used selectively to delete specialized blocks; for example, control blocks and unsupported labels that are on the data tape but should not be printed.

BSELECT and BDELETE TEST parameter

For offline jobs, this parameter defines test expression for selecting blocks for printing or for deleting blocks from printing.

Syntax BSELECT TEST = *test-exp*
BDELETE TEST = *test-exp*

Options

Table 3-21. TEST parameter options and definitions

Option	Definition
<i>testexp</i>	<i>test expression.</i> Defines a test expression for a block that will be selected for printing (BSELECT) or deleted (BDELETE). Refer to "Coding a test expression" earlier in this chapter for the format and syntax of a <i>testexp</i> .

Default No default

BSELECT and BDELETE commands: points to note

Note the following when using the BSELECT and BDELETE commands:

- It is important to note that block selection or block deletion is performed before the extraction of the records from the block. If a block is deleted from or not selected for printing, none of the records contained within that block are processed or are available for any other logical processing functions.
- If a block does not match the same format as the normal blocks, it can be deleted and thus not cause a processing error. For example, a control block in a fixed blocked file may cause a processing error unless it is first deleted.
- When defining TABLE CONSTANT or CHANGE parameters, specify offsets to subfields of a block in bytes relative to zero, from the start of the block to the beginning of the subfield.

Examples

This section shows examples of use of the BSELECT and BDELETE commands.

Example 1

The following commands illustrate the use of BSELECT to process interspersed reports on a block basis. Refer to the figure below.

```
T1: TABLE      CONSTANT=( ' P ' ) ;
C1: CRITERIA   CONSTANT=( 0 , 1 , EQ , T1 ) ;
      BSELECT   TEST=( C1 ) ;
```

The contents of the first byte of each tape block (offset=0, length=1) is examined for the character constant 'P'. When a 'P' is detected, the entire block is selected (BSELECT) for printing. When the first byte of any block does not contain a 'P', that block is bypassed and not printed. In this example, only block 1 is printed.

The following figure shows a sample of how BSELECT and BDELETE commands are used.

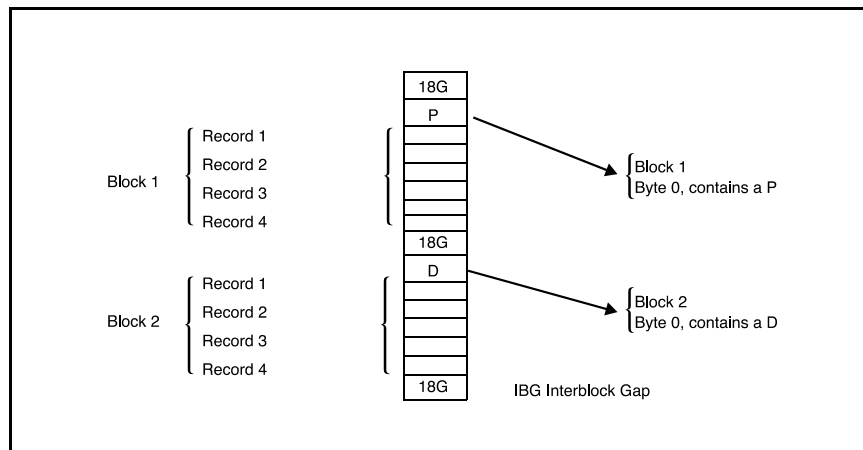

Figure 3-2. Sample BSELECT and BDELETE command usage

Example 2

The following example shows a BDELETE command that will delete from the tape any blocks that contain \$\$11:

```
T1: TABLE      CONSTANT= (' $$11 ' );
C1: CRITERIA   CONSTANT= ( 4 , 4 , EQ , T1 ) ;
      BDELETE   TEST=C1 ;
```

LMODIFY command

Enables you to select one or more text strings to which highlight color will be added under specified conditions.

NOTE: The FreeFlow Print Server LCDS monochrome systems ignore this command. However, JSLs that contain the LMODIFY command may be created and transferred to a highlight color laser printing system, such as the DT 128/155/180 HLC, for use with highlight color jobs.

LMODIFY command parameters

The following table summarizes the LMODIFY parameters and their options.

Table 3-22. Summary of LMODIFY command parameters

Parameter	Specifies	Online	Offline	DJDE
LMODIFY INK	Specifies the ink to use to print the selected text data.	Y	Y	N
LMODIFY SELECT	Defines the portion of the line that will be printed in the specified ink.	Y	Y	N
LMODIFY TEST	Defines the test expression for printing specified text strings in color.	Y	Y	N

LMODIFY INK

Specifies the ink to use to print the selected text (specified in the SELECT parameter) in color.

Syntax LMODIFY INK= *inkindex*

Option

Table 3-23. LMODIFY INK parameter option and definition

Option	Definition
<i>inkindex</i>	Specifies the ink to be used to print the selected text data. The <i>inkindex</i> is an index number that refers to the current ink list (ILIST). If the <i>inkindex</i> is not specified, the first ink in the ILIST is used.

Default No default

LMODIFY SELECT

Specifies the part of the print line that will be printed in the specified ink.

Syntax LMODIFY SELECT= {LINE | (*offset*, *length*)}

Options

Table 3-24. LMODIFY SELECT parameter options and definitions

Option	Definition
LINE	Prints the entire line using the specified ink.
<i>offset</i>	Specifies in bytes (relative to zero) the amount of space from the beginning of the print line to the beginning of the portion of the line that will be printed in the specified ink.
<i>length</i>	Specifies the length in bytes of the portion of the print line that will be printed in the specified ink.

Default No default

LMODIFY TEST

Specifies the test expression for selecting one or more text strings to be printed in color.

Syntax LMODIFY TEST = {*criid* | (*criid1*, OR, *criid2*) | (*criid1*, AND, *criid2*)}

Options

Table 3-25. LMODIFY TEST parameter options and definitions

Option	Definition
<i>criid</i>	<i>criterion identifier.</i> Specifies the identifier of a CRITERIA command that is being referenced in this TEST parameter.
AND	Specifies that both of the two specified criteria must be met for the selected text to print in color.
OR	Specifies that either of two specified criteria must be met for the selected text to print in color.

Default No default

Points to note: LMODIFY command

- The LMODIFY command acts upon individual print lines. The offset values in all of the test criteria are measured from the beginning of the **print line** to the beginning of the test field. The print data offset (pdo value) in the LINE DATA parameter can affect the relationship between the beginning of the input data record and the beginning of the print line.

NOTE: In the LMODIFY command, the offset is measured differently from the way it is done for other PDL commands. The offset value for LMODIFY is measured from the beginning of the print line. In most cases, the offset value is measured from the beginning of the user portion of the record.

- Copy modification entries (CMEs) or font indexing (and optionally ink indexing) in conjunction with OVERPRINT=MERGE override LMODIFY specifications.

RAUX command

You can control feeding of a single sheet of paper from the tray that contains the AUX stock, from within the input data stream. If the system encounters a data record that satisfies the RAUX test criteria, the page on which the record is found prints on a sheet of paper picked from the tray assigned to the AUX stock.

For simplex printing, the page is printed on a sheet of paper selected from the current tray, unless the page contains a record satisfying the RAUX test criterion. For duplex printing, the system ascertains the need to pick a sheet from the AUX stock (the specified RAUX criterion appears on either the front or back side of a page) on a page pair basis before the first side is printed.

This command can also be used in combination with the OUTPUT FEED command and the FEED DJDE.

The following section describes the syntax of the RAUX command parameter and explains its options.

RAUX TEST parameter

Specifies the test expression for selection of paper from the auxiliary tray.

Syntax RAUX TEST = *testexp*

Options**Table 3-26. RAUX TEST parameter options and definitions**

Option	Definition
<i>testexp</i>	<i>test expression</i> . Describes the criteria that, when detected by the system, will cause a page to be fed from the tray identified for the AUX stock. Refer to "Coding a test expression" earlier in this chapter for the format and syntax of a <i>testexp</i> .

Default No default

RAUX command: points to note

- If a record that is intended to satisfy the criteria for RAUX is suspended by RSUSPEND, that record is not checked for the RAUX criteria.
- Record selection and deletion are performed before RAUX processing.

RAUX command example

Following is an example of how to use the RAUX command.

```
T1:      TABLE      CONSTANT='CUSTOMER COPY';
C1:      CRITERIA    CONSTANT=(20, 13, EQ, T1);
          RAUX       TEST=C1;
          RECORD     PREAMBLE=0;
```

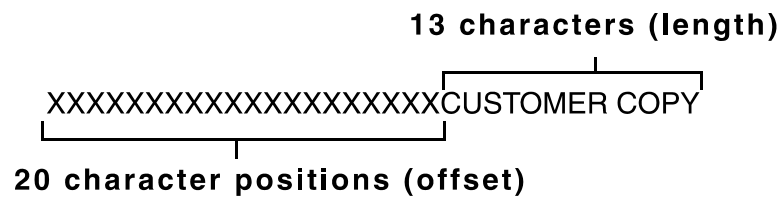

Figure 3-3. Data record showing offset specified in RAUX command

The data record, when processed as part of the input data stream, causes the page it is a part of to be printed on a sheet of paper fed from the auxiliary tray. The Xs are depicted in the above example only to illustrate the specified offset of 20 character positions.

RDELETE and RSELECT commands

Records that are interspersed throughout one report or file may be either deleted or selected for printing by the RDELETE and RSELECT commands, respectively. These commands can also be used to selectively delete specialized records; for example, control records and offset records that are on the data tape but are not printed.

If the tests for both RSELECT and RDELETE are satisfied, the records are deleted.

The following section describes the syntax of the RDELETE and RSELECT command parameters and explains their options.

RSELECT and RDELETE TEST parameter

Defines the test expression for selection (RSELECT) or deletion (RDELETE) of records for printing.

Syntax RDELETE TEST = *testexp*
RSELECT TEST = *testexp*

Options

Table 3-27. RDELETE and RSELECT TEST parameter options and definitions

Option	Definition
<i>testexp</i>	<ul style="list-style-type: none"> For RSELECT: Specifies the test criteria that, if met, will cause the record to be selected for printing. For RDELETE: Specifies the test criteria that, if met, will cause the record to be deleted from the printed output. Refer to “Coding a test expression” earlier in this chapter for the format and syntax of a <i>testexp</i> .

Default No default

RDELETE and RSELECT commands: point to note

The RSELECT and RDELETE commands are supported on the FreeFlow Print Server LCDS systems only for offline printing.

RDELETE command example

The following commands illustrate the use of RDELETE to process interspersed reports on a record basis. Refer to the figure below.

```
T1: TABLE      CONSTANT= ( 'EFGH' ) ;
C1: CRITERIA    CONSTANT= (104, 4, EQ, T1) ;
RDELETE        TEST=C1;
```

The above example shows that, if the contents of a deletion control field located 104 bytes from the start of the user portion of the record are equal to the constant 'EFGH,' the record is not printed.

In the example illustrated in the following figure, records 2 and 6 will not be printed.

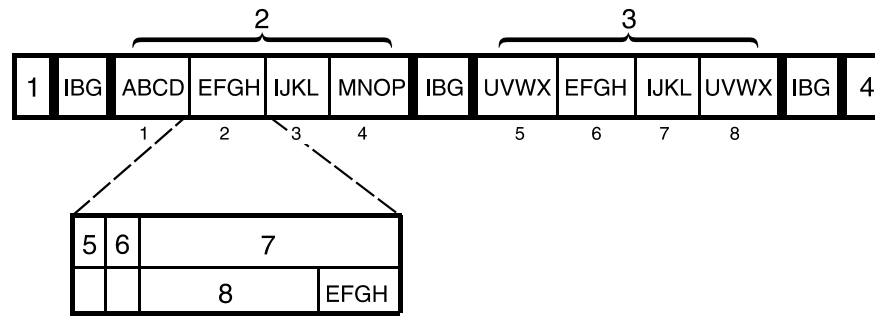

Figure 3-4. Illustration of RDELETE command usage

1. Tape mark, followed by interblock gap (IBG)
2. Block 1, followed by interblock gap (IBG)
3. Block 2, followed by interblock gap (IBG)
4. Tape mark
5. Record length field (in preamble)
6. Printer carriage control (PCC) byte (at start of user portion of record)
7. Print line
8. 103 bytes of data

RFEED command

The logical processing RFEED command allows you to change stock names on a page by page basis without using DJDEs. The RFEED command allows you to specify paper fed from trays assigned to different stocks if certain record criteria are met. RFEED, an extension of the RAUX command, lets you specify virtually any *stock name* or *stock reference* without being limited to the AUX stock.

The following section describes the syntax of the RFEED command parameter and explains its options.

RFEED TEST parameter

Allows you to specify paper fed from trays assigned to different stocks if certain record criteria are met.

Syntax RFEED TEST = ((*testexp*, *stock*) [, ...])

Options

Table 3-28. RFEED TEST parameter options and definitions

Option	Definition
<i>testexp</i>	References a criteria table to be used to test for conditions that will cause the stock defined by the <i>stock</i> parameter option to feed for the next page. Refer to “Coding a test expression” earlier in this chapter for the format and syntax of a <i>testexp</i> .
<i>stock</i>	Defines the stock whose assigned tray(s) will be used for the page, (either a stock name or a stock reference).

Default No default

RFEED command: points to note

- Satisfaction of the RFEED criteria causes the current page to feed from the tray assigned to the stock defined in the RFEED command.
- If a criterion is met, the stock name remains in effect until the next RFEED criterion are met or a new report is processed.
- RFEED is not available as a DJDE. Instead, the FEED DJDE is available for similar functions. Refer to the “FEED DJDE” in the “Using Dynamic Job Descriptor Entries (DJDEs)” chapter of this guide.
- In a multiple RFEED criteria command, the order in which the test expressions are specified makes a difference in the job application. After a test is satisfied, the system ignores RFEED checking for the rest of the page. RFEED checking resumes when a page transition occurs.

Consider the following example:

```
PAPERSTK: STOCKSET ASSIGN=( 'RED' ,REDPPR) ,
              ASSIGN=( 'BLUE' ,BLUPPR) ,
              ASSIGN=( 'GREEN' ,GRNPPR) ;

T1:         TABLE   CONSTANT=( 'ABC' ) ;
T2:         TABLE   CONSTANT=( 'DEF' ) ;
T3:         TABLE   CONSTANT=( 'GHI' ) ;
C1:         CRITERIA CONSTANT=( 4, 3, EQ, T1) ;
C2:         CRITERIA CONSTANT=( 4, 3, EQ, T2) ;
C3:         CRITERIA CONSTANT= (15, 3, EQ, T3) ;
RFEED      TEST=( (C1, 'RED' ) , (C2, 'BLUE' ) , C3,
                  'GREEN' ) ;
```

In this example, the system checks C1, C2, and then C3. If C2 and C3 satisfy the specified criteria, the C2 stock has priority over the C3 stock due to its position in the JSL.

ROFFSET command

The logical processing ROFFSET command enables you to initiate a page offset in the stacker tray under control of the input data and DJDE records. These special user-controlled offsets can simplify job distribution by creating separate stacks for each recipient. No other special processing occurs as a result of the ROFFSET test being satisfied; for instance, the report is not terminated and multiple copies are not produced at the offset juncture.

ROFFSET forces the logical page on which the criteria are satisfied to be the first logical page on a new sheet.

The page on which the offset occurs can be determined by the following criteria:

- If the record that satisfies the ROFFSET test is printed on a page of the output, that page is on the offset sheet.
- If the record that satisfies the ROFFSET test is not printed on a page of the output, that is, it is deleted by RDELETE, the ROFFSET function is performed for the next printable record. If the next printable record causes a transition to the next page, that next page is offset.

ROFFSET can also force an offset on either all copies of the report or only the first copy. In conjunction with job offset control (OFFSET parameter of the OUTPUT command), you can exert extensive control over the offsetting function to build tailored, job controlled stacks of output in your printer stacker tray.

ROFFSET command parameters

The following table summarizes the ROFFSET command parameters.

Table 3-29. Summary of ROFFSET command parameters

Parameter	Specifies	Online	Offline	DJDE
ROFFSET PASSES	Initiates an offset of specified copies of a report.	Y	Y	N
ROFFSET TEST	Defines a test expression for offsetting pages in the stacker.	Y	Y	N

The following section describes the syntax of the ROFFSET command parameters and explains their options.

ROFFSET PASSES

Specifies which copy of a report in a collated print run will be offset.

Syntax ROFFSET PASSES = {FIRST | ALL}

Options

Table 3-30. ROFFSET PASSES parameter options and definitions

Option	Definition
FIRST	Specifies that the satisfied criteria causes an offset only on the first pass of a collated print run.
ALL	Specifies that the satisfied criteria causes an offset on all passes of a collated print run.

Default ALL

ROFFSET TEST

Specifies the test expression for offsetting pages in the stacker bin.

Syntax ROFFSET TEST = testexp

Options

Table 3-31. ROFFSET TEST parameter options and definitions

Option	Definition
<i>testexp</i>	<i>test expression.</i> Specifies the criteria test that, if satisfied, causes the output to be offset in the stacker tray. Refer to “Coding a test expression” earlier in this chapter for the format and syntax of a <i>testexp</i> .

Default No default

ROFFSET command: points to note

- The ROFFSET feature prints the record that satisfies the test expression according to the normal job parameters.
- If ROFFSET is specified for an uncollated job, an offset occurs on only the first copy of the offset page.
- If OUTPUT OFFSET=FIRST (or ALL) was specified, and the ROFFSET criteria is satisfied on the first page of a report, the normal offset from the preceding report occurs.
- If a *testexp* is satisfied in duplex mode, the logical page on which the record occurs is the first logical page of a new sheet.
If this page falls on the back side of a two-sided sheet, the page is moved to the front of the next sheet, creating a blank back side.
- If segments are specified, the ROFFSET command is ignored.

ROFFSET command example

In the following example, a file has multiple reports without any delimiter records separating the reports. Each page of the report has a page number as part of the heading. Each report causes renumbering of the pages, starting with PAGE...1. With the ROFFSET command coded below, an offset occurs for all passes of the reports. Therefore, the first sheet of each report is offset relative to the previous sheet, because each first sheet contains records with the "Page...1" text.

```
T1: TABLE      CONSTANT= (' PAGE...1' );
C1: CRITERIA    CONSTANT= (105, 8, EQ, T1) ;
      ROFFSET    TEST=C1, PASSES=ALL;
```

The following figure shows a sample job diagram showing ROFFSET command usage.

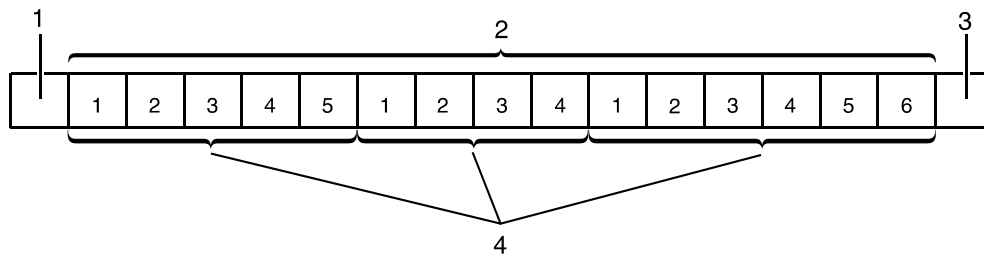

Figure 3-5. Diagram of a sample ROFFSET command

1. Tape mark
2. Pages
3. Tape mark
4. Reports

RPAGE command

The RPAGE command allows you to reposition the current (or next) logical page on the physical page.

RPAGE command parameters

The following table summarizes the RPAGE command parameters.

Table 3-32. Summary of RPAGE command parameters

Parameter	Specifies	Online	Offline	DJDE
RPAGE SIDE	Specifies the side of the physical page on which to reposition the logical page.	Y	Y	Y
RPAGE TEST	Defines the test expression for detecting an RPAGE record.	Y	Y	N
RPAGE WHEN	Specifies the portion of the current logical page that will be positioned.	Y	Y	N

The following sections describe the syntax of the RPAGE command parameters and explains their options.

RPAGE SIDE

Defines the side of the physical sheet on which the repositioned logical page is to appear. The default is (NUFRONT, NOFFSET).

Syntax RPAGE SIDE = {*sideopt* | *offsetopt* | (*sideopt*,*offsetopt*)}

Options

Table 3-33. RPAGE SIDE parameter options and definitions

Option	Definition
<i>sideopt</i>	In duplex (with no BFORM), <i>sideopt</i> produces the following results:
NUFRONT	The specified logical page is positioned as the first logical page on a new sheet.
BACK	The specified logical page is positioned as the first logical page of the next available back.
NUBACK	The specified logical page is positioned as the first logical page on the back of a new sheet.
NEXT	The specified logical page is positioned as the first logical page on the next available side, the back of the current sheet or the front of the next sheet. The logical page is moved unless it is already properly positioned as the first logical page on the specified side.
In simplex, or in duplex with BFORM: The <i>sideopt</i> parameter is forced to NUFRONT, and the specified page is positioned as the first logical page. If the logical page is already properly positioned, a blank sheet is not created.	
<i>offsetopt</i>	The available <i>offsetopt</i> parameters are:
OFFSET	The sheet on which the repositioned logical page occurs is offset in the output stacker.
NOFFSET	No offset occurs.

Default (NUFRONT, NOFFSET)

RPAGE TEST

Defines the test expression for detection of an RPAGE record that will cause the logical page to be repositioned on a physical page.

Syntax RPAGE TEST = *testexp*

Options**Table 3-34. RPAGE TEST parameter options and definitions**

Option	Definition
<i>testexp</i>	<i>test expression</i> . Specifies the criteria test that, if met, will reposition the logical page. The logical page on which this record normally appears is called the “current logical page.” Refer to “Coding a test expression” earlier in this chapter for the format and syntax of a test expression.

Default No default

RPAGE WHEN

Defines the portion of the current logical page that will be positioned to the first logical page of a new location.

Syntax RPAGE WHEN = {TOP | BOTTOM | NOW}

Options**Table 3-35. RPAGE WHEN parameter options and definitions**

Option	Definition
BOTTOM	The logical page following the current logical page is repositioned.
NOW	The current record is repositioned. This record prints at TOF. Any spacing or skipping defined to occur before printing the current record is ignored.
TOP	The current logical page is repositioned.

Default TOP

RPAGE command: points to note

Note the following when using the RPAGE command.

- If a record intended to satisfy the criteria for RPAGE is suspended by RSUSPEND, that record is not checked for the RPAGE criteria. Note that the RPAGE criteria takes effect when printing is resumed.
- Record selection or deletion is performed prior to RPAGE processing. If a record satisfying the RPAGE test criteria was previously not selected for or was deleted from printing, the RPAGE does not function.
- Since DJDE processing occurs before RPAGE processing, DJDE records are not checked for satisfying the RPAGE criteria.

RPAGE command examples

The following figures show the effects of RPAGE command SIDE and WHEN parameters, respectively.

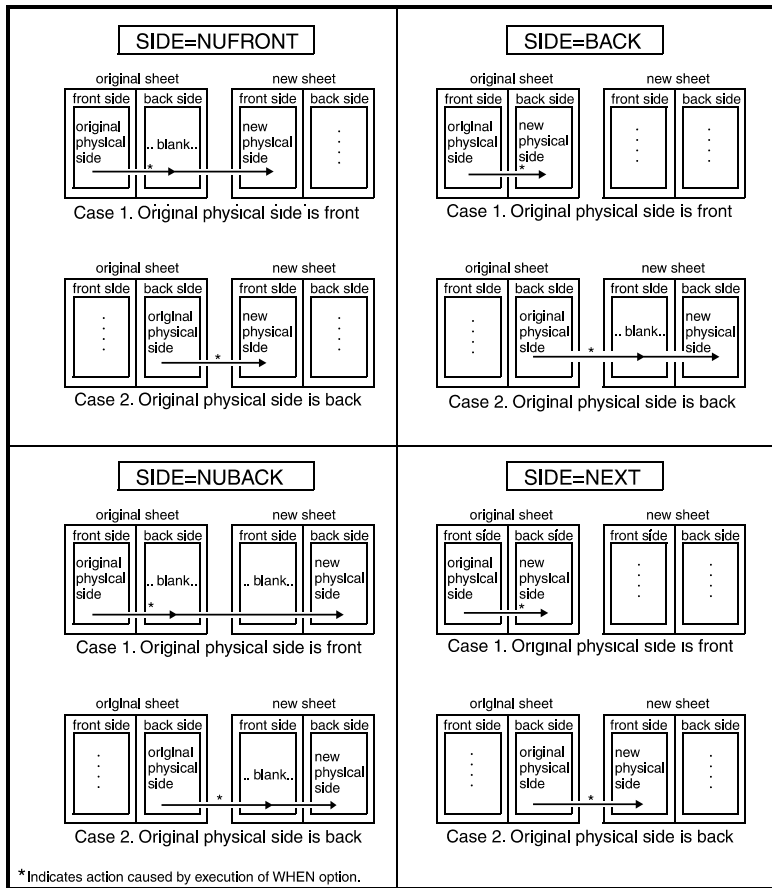

Figure 3-6. Effects of RPAGE SIDE parameter

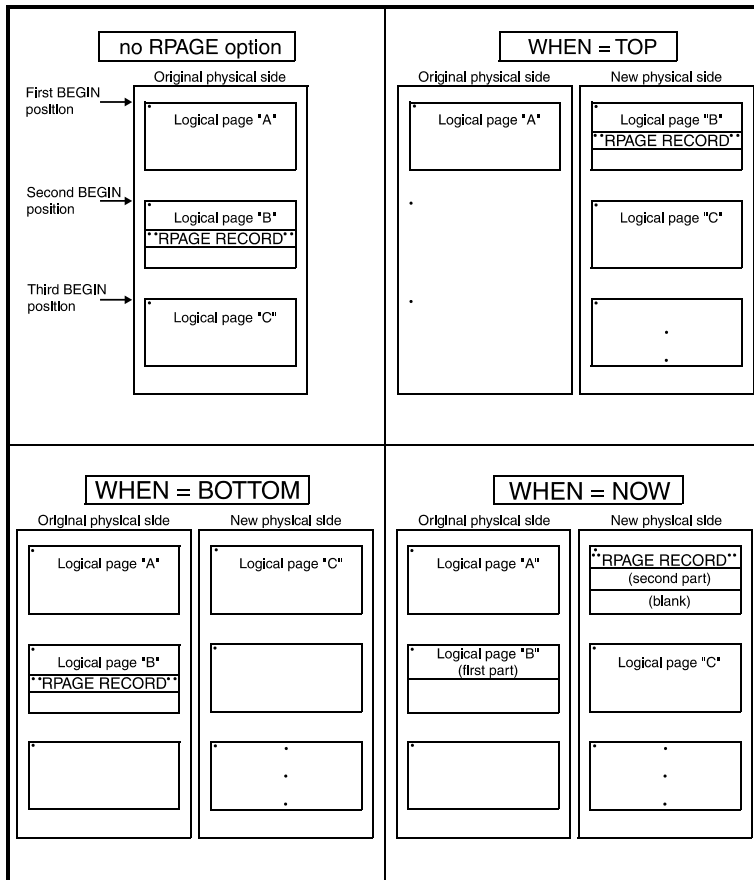

Figure 3-7. Effects of RPAGE WHEN parameter

RRESUME and RSUSPEND commands

The print suppression logical processing function permits you to delete from printing groups of records that are distinguishable at the start and end, but whose intermediate records may not be unique or distinguishable.

Print suppression and resumption are invoked by the use of two separate commands: RSUSPEND and RRESUME. The tests for each command are independent and must be described separately. Each of the commands can specify the full range of tests as described previously for the other logical processing commands.

When specifying either the RSUSPEND or RRESUME command, you can also specify whether suspension or resumption of printing occurs on the current or next record. This is controlled by the BEGIN parameter. This additional control provides the necessary flexibility to cope with the variability of requirements for print suppression. The BEGIN parameter can be specified independently in both the RSUSPEND and the RRESUME commands.

RSUSPEND and RRESUME command parameters

The following table summarizes the parameters for the RSUSPEND and the RRESUME commands.

Table 3-36. Summary of RSUSPEND and RRESUME command parameters

Parameter	Specifies	Online	Offline	DJDE
BEGIN	Indicates with which record the print suspension (RSUSPEND) or resumption (RRESUME) begins.	Y	Y	N
TEST	Defines a test expression for the records at which to suspend and resume printing.	Y	Y	N

The following sections describe the syntax of the RSUSPEND and RRESUME command parameters and explain their options.

RSUSPEND and RRESUME BEGIN

Specifies whether printing will be suspended starting with the current record or with the following one.

Syntax RSUSPEND BEGIN = {CURRENT | NEXT}
RRESUME BEGIN = {CURRENT | NEXT}

Options

Table 3-37. RSUSPEND and RRESUME BEGIN parameter options and definitions

Option	Definition
CURRENT	Specifies that printing will stop or resume on the current record. <ul style="list-style-type: none"> If CURRENT is coded for RSUSPEND, the record satisfying <i>testexp</i> does not print. If CURRENT is coded for RRESUME, the record is printed.
NEXT	Specifies that printing will stop or resume with the next record. <ul style="list-style-type: none"> If NEXT is coded for RSUSPEND, the record satisfying <i>testexp</i> is printed, and printing is suppressed beginning with the next record. If NEXT is coded for RRESUME, the record satisfying the <i>testexp</i> is not printed, and printing begins with the next record.

Default NEXT

RSUSPEND and RRESUME TEST

Defines the test expressions for the record at which printing will be suppressed (RSUSPEND) or resumed (RRESUME).

Syntax RSUSPEND TEST = *testexp*
RRESUME TEST = *testexp*

Options

Table 3-38. RSUSPEND and RRESUME TEST parameter options and definitions

Options	Definitions
<i>testexp</i>	<i>test expression.</i> Defines a test expression for the record with which printing will be suspended (RSUSPEND) or resumed (RRESUME) following print suppression. Refer to “Coding a test expression” earlier in this chapter for the format and syntax of a <i>testexp</i> .

Default No default

RRESUME and RSUSPEND commands: points to note

- On the FreeFlow Print Server LCDS system, RSUSPEND and RRESUME are supported only for offline printing.

- **Interaction with RSTACK**

- A record that satisfies the RSTACK criteria is detected, and it terminates the report and record suspension, regardless of whether or not the printing of records was suspended at the time.

DJDE records are not processed if record printing has been suspended. Refer to the “Using Dynamic Job Descriptor Entries (DJDEs)” chapter for further information.

- If the criteria for RSTACK and RSUSPEND are satisfied on the same record, that record delimits the report, and the record is suspended.
- Make sure that, if an RSUSPEND command is coded, an RRESUME command is also present for the job. A warning is issued by the XJDC compiler if one, but not both, commands is invoked for a job. However, the JDE is compiled as programmed.
- If a data record satisfying the test expression in the RSUSPEND is encountered, printing is suspended. If no record that satisfies the test expression in the RRESUME command is encountered (or no RRESUME command is present for the job), there is no output generated for records that occur after the point of suspension.
- Record selection or deletion is performed before RSUSPEND or RRESUME processing. If a record satisfying either the suspend or resume test criteria was not selected for or was deleted from printing, it does not cause either the suspend or resume function.
- The records just before print suspension and after resumption should have compatible printer carriage control (PCC) characters. No additional carriage control characters are inserted by the system during the print suppression.
- Use of the LINENUM parameter in the CRITERIA command is not recommended when using RRESUME. Because carriage control characters are not processed during print suppression, the line number used by the system is that which existed before the suppression started. This could result in the test criteria being either unexpectedly satisfied or never satisfied as a function of the line number where the print suppression started.

- DJDE records are processed, not ignored, even when detected after an RSUSPEND record and before the corresponding RRESUME record.

RSUSPEND and RRESUME example

Following is an example of the RSUSPEND and RRESUME commands.

```
T1: TABLE      CONSTANT=('//JOB ', '//EXEC');
T2: TABLE      CONSTANT=('EOJ ');
T3: TABLE      CONSTANT=('//EXEC');
C1: CRITERIA    CONSTANT=(1, 6, EQ, T1);
C2: CRITERIA    CONSTANT=(1, 4, EQ, T2);
C3: CRITERIA    CONSTANT=(1, 6, EQ, T3);
RSUSPEND TEST=(C1, OR, C2),
          BEGIN=CURRENT;
RRESUME  TEST=(C3, OR, C2), BEGIN=NEXT;
```

The printing of the input data records in the following sample data is suspended (records from //JOB to //EXEC) by the preceding RSUSPEND command. Printing is resumed after the //EXEC data record by the RRESUME command that follows it.

```
//JOB FOR001A0
//OPTION CATAL
//ASSIGN SYSRLB, 3340, TEMP      Records that will not be printed
INCLUDE IMPCBBM
//EXEC FCOBOL
.
.
.
.
Data that will be printed
```

RSTACK command

The stacked reports feature enables you to define a series of reports in a single file. This is accomplished by specifying the end of the report in the coded logical processing commands.

The printer stacks reports in a file if more than one report is included in a single file (or a single spooled host file identified by the banner pages). In processing stacked reports, the system checks each record for the logical “end of report” specification as defined by the RSTACK TEST parameter.

When you use RSTACK for report separation, the end of the report occurs as soon as the test criteria are satisfied. However, when BANNER is coded, you specify the number of consecutive banner pages that must satisfy the test criteria before end of report occurs.

Report separation based on banner page detection is performed with the BANNER command. When you use RSTACK for report separation, the end of the report occurs as soon as the test expression is satisfied. However, when BANNER is coded, you specify the number of consecutive banner pages that must satisfy the test criteria before the end of the report occurs, and report separation occurs on a page boundary.

RSTACK delimiter modes

There are two modes of stacked reports: delimiter and nondelimiter.

- In **delimiter mode**, the record satisfying the TEST criteria is not part of the data for the report that follows the delimiter, but simply serves to separate or delimit one report from another.
- In **nondelimiter mode**, reports are “stacked” one after the other without any special records separating them.

The two modes are specified by the DELIMITER parameter of the RSTACK command.

Delimiter mode If DELIMITER=YES is coded (delimiter mode), you may actually separate each report with multiple successive records, each of which satisfies the test expression of the RSTACK command. In this case, all consecutive delimiters are treated as a delimiter packet.

In this mode, you can use the PRINT parameter to print the delimiter (or the delimiter packet) and to select the output destination of this delimiter page: BIN, TRAY, or BOTH. The option BOTH delivers the page to the sample tray and to the output tray.

The delimiter page, when printed, is output as part of the subsequent report. All of the printing parameters selected in the JDL remain in effect during report delimiter printing except CARRIAGE CONTROL, which is ignored; the carriage control is replaced by a Print and Space 1 line control.

If DJDE records exist within the delimiter packet or immediately following, they are included on the delimiter page.

Nondelimiter mode

If DELIMITER=NO is coded (Nondelimiter mode), a single record separates one report from the next. After satisfying the TEST criteria, this record is considered part of the subsequent report. In this mode, the PRINT parameter is not available. Therefore, the delimiter is not printed on a special page.

Delimiter on accounting page

You may include part of the first record of a report on the accounting page. This command is selected by coding the ACCTINFO parameter, which is normally used to print part of the first (or only) RSTACK record.

The ACCTINFO field is captured from the first record of the report, even if that record does not satisfy the RSTACK test. Thus, the ACCTINFO data is captured even for a report (boundary) that was not detected by an RSTACK test.

Status display

You can display a subfield of the first record in a report when you display job status on the user interface screen. You select this command by coding the HRPTNA or HJOBNO parameter.

Note that HJOBNO is not an RSTACK parameter and must be coded in the BANNER command.

RSTACK command parameters

The following table summarizes the parameters of the RSTACK command.

Table 3-39. Summary of RSTACK command parameters

Parameter	Specifies	Online	Offline	DJDE
RSTACK ACCTINFO	Prints a subfield of the first record on the accounting page.	Y	Y	N
RSTACK DELIMITER	Specifies whether RSTACK records are treated as special (delimiter) records, or as the first data record of the next report.	Y	Y	N
RSTACK HRPTNA	Displays a subfield of the first record as REPORT NAME on the print server screen as part of the status display.	Y	Y	N
RSTACK PRINT	Prints delimiters.	Y	Y	N
RSTACK TEST	Test expression for end of report condition	Y	Y	N

RSTACK ACCTINFO

Specifies that a subfield of the first record will be printed on the accounting page at the end of the report. If DELIMITER=YES is also coded, the subfield is from the first delimiter record of the report. For DELIMITER=NO the subfield is from the first record of the report.

Syntax RSTACK ACCTINFO = (*offset*, *length*)

Options

Table 3-40. RSTACK ACCTINFO parameter options and definitions

Option	Definition
<i>offset</i>	The amount of space, specified in bytes (relative to zero), from the start of the user portion of the record to the subfield within the record.
<i>length</i>	The number of bytes in the subfield (1 to 64).

Default No default

RSTACK DELIMITER

Specifies whether or not RSTACK records are treated as data records.

Syntax RSTACK DELIMITER = {YES | NO}

Options

Table 3-41. RSTACK DELIMITER parameter options and definitions

Option	Definition
YES	Specifies that all consecutive records that satisfy the TEST criteria are treated as a delimiter packet and not as data records.
NO	Specifies that this single record separates one report from another and is treated as a data record.

Default NO

Point to note: You can use DELIMITER = NO to detect a record that is uniquely recognizable as the first record of each report and have the record treated as a report boundary. Two common examples of this usage are:

**RSTACK
DELIMITER
parameter**

- A page heading print record that has page numbers on it such as “Page 00001” (using Constant mode criteria)
- A page heading record that has a report number on it such as “Report 00001” (using Change mode Criteria).

RSTACK HRPTNA

Specifies that a subfield of the first record will be displayed on the Job Manager window on the user interface.

If DELIMITER = YES is also coded, the subfield is from the first delimiter record of the report. For DELIMITER = NO, the subfield is from the first record, even if that record does not satisfy the RSTACK test.

Syntax RSTACK HRPTNA = {(*offset, length*) | NONE}

Options

Table 3-42. RSTACK HRPTNA parameter options and definitions

Option	Definition
<i>offset</i>	The amount of space, specified in bytes (relative to zero), from the start of the user portion of the record to the subfield within the record.
<i>length</i>	The number of bytes in the subfield (1 to 16).
NONE	Specifies no report name is selected.

Default NONE

RSTACK PRINT

If DELIMITER=YES is coded, specifies if the report delimiters will be printed, and if so, the output destination of the printed delimiters.

Syntax RSTACK PRINT = {BIN | BOTH | TRAY | NONE}

Options

Table 3-43. RSTACK PRINT parameter options and definitions

Options	Definitions
BIN	Specifies that report delimiters will be printed and the output will be delivered to the stacker tray.
BOTH	Specifies that report delimiters will be printed, and the output will be delivered to both the sample tray and the stacker tray.
TRAY	Specifies that report delimiters will be printed and the output will be delivered to the sample tray.
NONE	Specifies that report delimiters will not be printed.

Default NONE

**RSTACK PRINT
parameter: points
to note**

- If DELIMITER=NO has been coded, no page is printed.
- If the report is being printed in duplex mode, report delimiters are printed on at most one side of a two sided page.

RSTACK TEST

Defines the test expression for the “end of report” conditions for either Change mode or Constant mode criteria.

Syntax RSTACK TEST = *testexp*

Options

Table 3-44. TEST parameter options and definitions

Option	Definition
<i>testexp</i>	Defines test criteria that, if satisfied, signals the end of the report for either Change Mode or Constant Mode criteria. Refer to “Coding a test expression” earlier in this chapter for the format and syntax of a <i>testexp</i> .

Default No default

RSTACK command: points to note

- If the TEST expression on the RSTACK command consists solely of a Change Mode CRITERIA command, DELIMITER=NO must be coded.
- If a record that is an RSTACK delimiter (satisfies the test expression), it must neither be deleted from nor not selected for printing by the RSELECT or RDELETE logical processing. If the record satisfies the RSTACK test criteria but is not a delimiter, it can be deleted from or not selected for printing. However, it still causes report separation.
- If an RSTACK command contains a TEST expression that specifies a constant mode CRITERIA command, and DELIMITER = YES, the RSTACK command can be used to detect a heading of a report as a report boundary.

Points to note for online printing:

- Detection of RSTACK criteria within a not yet recognized banner page (RSTACK record occurs before BANNER criteria line) results in subsequent incorrect report separation.
- Detection of RSTACK criteria in a recognized but incomplete banner page (RSTACK record occurs after BANNER criteria line) is ignored.

- Detection of RSTACK immediately following report separation is ignored. This prevents null reports. If RSTACK is specified in a selected JDE or JDL, that is, a JDE or JDL invoked in a DJDE), the following restrictions apply to online systems:
 - If RSTACK is not specified in the JDE or JDL that is identified in the Initial JDE or JDL field on the user interface window, the DELIMITER=NO parameter should be specified in the selected JDE or JDL. Specification of DELIMITER=YES is overridden in this case.
If RSTACK is specified in the Initial JDE or JDL, the DELIMITER parameter cannot be changed in a selected JDE or JDL.
 - If RSTACK is specified in the starting JDE or JDL but not in the selected JDE or JDL, RSTACK processing is suspended until end of report is triggered by BANNER page detection.
 - If ACCTINFO is specified in the Initial JDE or JDL on the Online Job Manager window, the ACCTINFO parameter cannot be changed or deleted in a selected JDE or JDL (even if RSTACK is suspended).
If ACCTINFO is not specified in the Initial JDE or JDL, it can be invoked in a selected JDE or JDL. The first record after the selected JDE takes effect is then printed as the ACCTINFO field.

RSTACK command example

Following is an example of the RSTACK command:

```
T1: TABLE          CONSTANT= ('XEROX' ) ;
C1: CRITERIA        CONSTANT= (1, 5, EQ, T1) ;
RSTACK              TEST=C1, DELIMITER=YES,
                    ACCTINFO= (14, 19) ,
                    HRPTNA= (20, 10) ;
```

In the previous example, reports are separated by a record with the characters XEROX in bytes 1 to 5 (relative to 0). Two reports are created as illustrated in the following figure. The delimiter record is not printed with the report.

The following figure illustrates a sample RSTACK command usage.

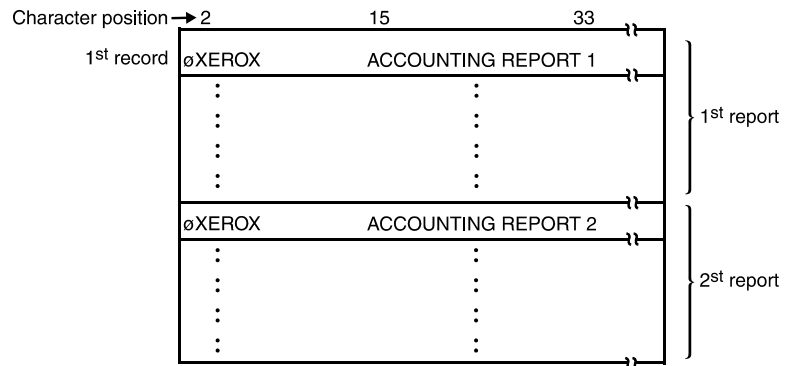

Figure 3-8. Sample RSTACK command usage illustration

4. Specifying print format parameters

To specify the physical characteristics of a print job, define the placement of data on the page, identify system responses to error conditions, and other functions related to the printed output, you use the PDL print format commands. These commands are described in the following sections.

Print format command descriptions

The following table lists these print format commands and summarizes their functions. Details of the function, syntax, and usage of the parameters available for each command are provided in its command description section.

Table 4-1. Summary of print format commands

Command	Function
ABNORMAL	Specifies operations security and page offset on jam recovery.
ACCT	Defines user and system accounting requirements.
CME	Allows certain parts of report output to be replaced on copies with predefined static data or to specify font changes within variable data.
IDR	Defines inks, default ink catalogs, and palettes.
LINE	Controls margin, overprinting, carriage control, and so forth.
MESSAGE	Sends message to operator during input or output processing.
OUTPUT	Controls printing mode, forms, paper size and type, offsetting, and output destination.
PDE	Defines page format (page orientation, fonts).
ROUTE	Sends message and form for a routing page.
STOCKSET	Defines a set of stocks used in a report.
VFU	Defines vertical format control.

ABNORMAL command

The ABNORMAL command allows you to restrict certain operator functions and to define system responses to error conditions.

ABNORMAL command parameters

The following table summarizes the ABNORMAL command parameters.

Table 4-2. Summary of ABNORMAL command parameters

Parameter	Specifies	Online	Offline	DJDE
ABNORMAL ACCTFEED	Specifies the stock from which an error sheet will be fed when an error occurs during the accounting report processing.	N	Y	N
ABNORMAL CODE	Specifies how illegal function codes in the data stream will be handled.	N	Y	N
ABNORMAL ERROR	Specifies the system response to abnormal conditions detected while processing DJDEs.	Y	Y	N
ABNORMAL IMISMATCH	Specifies action to take when the job contains a specification for an ink that is not loaded in the printer. Options are ABORT, STOP, and CONTINUE.	Y	Y	N
ABNORMAL ISUBSTITUTE	Specifies whether or not an ink substitution can be made by the operator. Options are NONE and ANY.	Y	Y	N
ABNORMAL OTEXT	Specifies that a message will be displayed to the operator when printing stops because of a system rollover.	Y	Y	N
ABNORMAL REP	Generates a page offset and/or slip sheet after recovery from a rollover.	Y	Y	N
ABNORMAL SECURITY	Enables restriction on use of certain operator commands.	Y	Y	N

The following sections describe the syntax of the ABNORMAL command parameters and explain the parameter options.

ABNORMAL ACCTFEED

Specifies the stock from which an error sheet will feed when an error occurs during accounting report processing.

Syntax ABNORMAL ACCTFEED = {AUX | OPR}

Options

Table 4-3. ABNORMAL ACCTFEED parameter options and definitions

Option	Definition
AUX	Specifies that the error sheet will feed from the stock that was identified as AUX.
OPR	(Not currently supported) Specifies the medium that is defined in the Virtual Printer.

Default AUX

ABNORMAL CODE

Specifies the handling of illegal function codes in the data stream. The system sets the report completion code and inserts an account error page into the job.

Syntax ABNORMAL CODE = {IGNORE | SPACE | SUBSTITUTE}

Options

Table 4-4. ABNORMAL CODE parameter options and definitions

Option	Definition
IGNORE	Bypasses illegal functions in the data stream
SPACE	Replaces each illegal function code with a character space.
SUBSTITUTE	(Not currently supported) Replaces each illegal function code with a substitute character that is defined in the Virtual Printer.

Default IGNORE

ABNORMAL ERROR

Specifies the required system response to abnormal conditions detected in input while processing DJDEs.

Syntax ABNORMAL ERROR = {ABORT | CONTINUE | STOP}

Options

Table 4-5. ABNORMAL ERROR parameter options and definitions

Option	Definition
CONTINUE	Displays the normal system message defining the abnormal condition and continues processing the report without applying the offending DJDE parameter and without offering the operator the choice of resuming or canceling the job.
ABORT	Displays the message for the abnormal condition and aborts only the report it is processing (not the entire job) without offering the operator the choice of resuming or canceling the job.
STOP	Displays the message for stop condition, the system stops processing the report and waits for the operator to respond by resuming or canceling the job from the Job Manager window.

Default STOP

**ABNORMAL
ERROR
parameter: points
to note**

- The CONTINUE and ABORT options put the printer in “Nonstop” mode. The STOP option puts the system in “Stop” mode. Any abnormal condition that is detected, such as a syntax error in a DJDE specification, a missing file referred to by a DJDE, or an RTEXT or GRAPHIC error in either mode, results in an appropriate error message being displayed. In addition, during the Stop mode, the displayed error message is followed by a DJDE error message to resume or cancel the job.
- If abnormal conditions are detected while processing DJDEs, the DJDE parameter set containing the offending entry is set up to print on the OPRINFO page and an error message is displayed.
- Errors detected while system is processing RTEXT data are not reported to you.
- The graphics processing errors are reported separately on the graphics exception page printed at the end of the report.

ABNORMAL IMISMATCH

Specifies the action for a highlight color printer to take when a specified ink requires a primary ink color that is not currently loaded.

NOTE: IMISMATCH is a highlight color parameter that is recognized by printers such as the Xerox 4850 and 4890, as well as the Xerox DT 128/155/180 HighLight Color Printing Systems. It may be included in JSLs that are created on the FreeFlow Print Server LCDS systems for highlight color printing. If the system encounters this parameter when printing, it is ignored.

Syntax ABNORMAL IMISMATCH = {ABORT | CONTINUE | STOP}

Options

Table 4-6. ABNORMAL IMISMATCH parameter options and definitions

Option	Definition
ABORT	Specifies that the system displays a message for the abnormal condition and aborts only the report it is processing (not the entire job) without offering the operator the choice of resuming printing or canceling the job.
CONTINUE	Specifies that the system displays a message defining the abnormal condition and resumes printing the current report with the ink that is currently loaded, overriding the ISUBSTITUTE parameter and any forms creation commands that specify no ink substitution.
STOP	Specifies that the system displays a message prompting the operator to load the requested primary ink or to abort the job. The printer stops printing the report and waits for the operator to resume printing (with or without changing inks) or cancel the job.

Default STOP

ABNORMAL IMISMATCH parameter: point to note If a report does not contain an ink list in the JDE, printing may start before the system is aware of the primary colors that are needed. For example, page 100 of a report that was designated black only may specify the green primary when the ink loaded in the printer is red. This would create an IMISMATCH condition.

FreeFlow Print Server-based LCDS printers contain queue default settings and a queue override setting. The default setting will be to Use Loaded Color. The LCDS datastream overrides queue default settings; however, a queue override setting will override the LCDS datastream. The FreeFlow Print Server Mismatch Action will include operator intervention (change ink), cancel the job, or use loaded color.

ABNORMAL ISUBSTITUTE

Specifies whether or not the operator of a highlight color printer may initiate ink substitution.

NOTE: ISUBSTITUTE is a highlight color parameter that is recognized by printers such as the Xerox 4850 and 4890, as well as the Xerox DT 128/155/180 HighLight Color Printing Systems. It may be included in JSLs that are created on the FreeFlow Print Server LCDS systems for highlight color printing. If the system encounters this parameter when printing, it is ignored.

Syntax ABNORMAL ISUBSTITUTE = {ANY | NONE}

Options

Table 4-7. ABNORMAL ISUBSTITUTE parameter options and definitions

Option	Definition
ANY	Specifies that the operator may initiate ink substitution.
NONE	Prohibits operator initiated ink substitution. The operator may either print the report without performing an ink substitution or abort the report.

Default ANY

NOTE: FreeFlow Print Server will allow any highlight color to be substituted for any other color. It differs in that BLACK cannot be substituted for any highlight color and any highlight color cannot be substituted for black. This is a decomposer limitation. A highlight color job can be printed entirely in BLACK by setting the Queue Properties:Image Quality Tab:Mapping Algorithm to Monochrome and selecting the override checkbox.

ABNORMAL OTEXT

("Output text") Specifies that the system will display a message to the operator at the point of software restart when printing is interrupted by a software failure. The parameter options enable you to specify whether or not printing will stop when this message is displayed.

Syntax ABNORMAL OTEXT = {WAIT | NOWAIT}

Options

Table 4-8. ABNORMAL OTEXT parameter options and definitions

Option	Definition
WAIT	Displays a message and stops printing until the operator resumes it (by pressing the printer Continue button or selecting Resume from the print server screen). Stopping printing allows the operator to verify the output report in the near vicinity of the marker page.
NOWAIT	Displays a message, but printing does not stop.

Default NOWAIT

**ABNORMAL
OTEXT parameter
example**

Following is an example of the ABNORMAL OTEXT parameter.

```
ABNORMAL        OTEXT = WAIT, ERROR = ABORT;
```

ABNORMAL REP

Specifies whether or not the first data page delivered to the output bin following a printer jam recovery or a system rollover is offset from the rest of the report.

Syntax ABNORMAL REP = {NO | YES}

Options

Table 4-9. ABNORMAL REP parameter options and definitions

Option	Definition
NO	Specifies that the page will not be offset.
YES	Specifies that the page will be offset.

Default NO

ABNORMAL SECURITY

Restricts certain operations or administrative functions.

Syntax ABNORMAL SECURITY = {YES | NO}

Options**Table 4-10. ABNORMAL SECURITY parameter options and definitions**

Option	Definition
YES	Restricts use of the following functions for the duration of the startup JDE or JDL: <ul style="list-style-type: none"> • Obtaining a sample print from the current job • Skipping over output pages.
NO	Specifies that no restrictions will be imposed.

Default NO

ABNORMAL SECURITY
parameter: points
to note

- If SECURITY is invoked in a selected JDE, such as one that is requested via a JDE DJDE, the Sample restrictions take effect when the page that is associated with the DJDE reaches the marker.
- The automatic recovery procedures on the printing system are based on the availability of valid checkpoint data independently saved by the LCDS decomposer. As a result, most recoveries are performed with no operator assistance. In certain cases, the system may detect that the checkpoint data is incorrect, and operator assistance is requested; that is, the operator or user is requested to return to point of origin or last valid checkpoint.
- The system produces a marker page, which is set up during processing, and inserts it into the print job at the point of crash. It is printed after the output processor has printed data that was already processed by input before the crash occurred.

ACCT command

The ACCT command enables a printout of an accounting summary to be included with each report printed. This summary consists of a single page of information containing job setup information and counts of processing events.

The system automatically saves on disk certain processing information on each report that is printed. The status file accumulates this information on an individual report basis, in the order that it is processed. Refer to the online help information on the Accounting window, accessed from the Administration window on your system print server, for the customer accounting procedures. The accounting file is accessible to the user and can be saved on media using the LCDS Accounting and Media Resource Manager windows.

ACCT command parameters

The parameters for the ACCT command are summarized in the following table.

Table 4-11. Summary of ACCT command parameter

Parameter	Specifies	Online	Offline	DJDE
ACCT DEPT	Specifies a category under which user accounting statistics will accumulate for a job.	Y	Y	Y
ACCT USER	Specifies the output destination of the accounting page if one is printed with a report.	Y	Y	N

ACCT DEPT

Defines the name under which accounting statistics will be accumulated for this report or job.

Syntax ACCT DEPT = *sc*

Options

Table 4-12. ACCT DEPT parameter options and definitions

Option	Definition
sc	<i>string constant.</i> Represents a department code or name of up to 31 characters, under which accounting information is maintained.

Default Built from the JDL name by adding “.JDL” to the name.

ACCT DEPT parameter: point to note The department name (sc) is printed on the accounting sheet, and is entered into the accounting log for the report.

ACCT USER

Specifies the delivery destination of the one-page accounting summary for each report. This page is always printed in the same mode (duplex or simplex) as the report.

Syntax ACCT USER = {BIN | TRAY | BOTH | NONE}

Options

Table 4-13. ACCT USER parameter options and definitions

Option	Definition
BIN	Directs an accounting page to the output bin.
TRAY	Directs an accounting page to the sample tray.
BOTH	Directs an accounting page to the output bin and the sample tray.
NONE	Specifies that no accounting page is delivered.

Default BIN

ACCT command: points to note

- If the report completion code on the accounting page is other than Completed, an accounting page is delivered to the tray, even if USER=NONE is coded. This is done to notify you of a possible report integrity problem.
- Accounting information is accumulated at processing time, not during printing. If the report does not complete successfully, use the Customer Accounting feature to obtain printing status.

ACCT command example

```
ACCT USER=BOTH, DEPT='MARKETING' ;
```

The command example above specifies that after each report is printed, an accounting page is delivered to both the output bin and sample tray.

CME command

Copy modification entries (CMEs) allow certain parts of the printed data in a report to be replaced with predefined static data, and/or specify the changing of fonts within the variable data. (The copy modification function is also referred to as “spot carbon.”)

CMEs define a rectangular space on the printed page within which printed data is replaced with a substitution string or a changed font. More than one CME may be applied to a job. CMEs may be coded as part of the JDL or created as separate files so that they may be referenced by one or more JDLs. This latter feature is described more fully in the “Catalogued CMEs” section, later in this chapter.

You must specify an *ac* type identifier (requiring at least one alphabetical character) when defining the CME, and reference it with the MODIFY parameter of the OUTPUT command.

NOTE: The CME must precede the OUTPUT command.

Short form CME specifications

You can minimize coding length by giving CME specifications in the short form. In short form, you need to give only the **first** character of a keyword, you can omit equal signs, and you need not insert commas except where necessary to avoid ambiguity.

Here is an example of a CME in which the commands are shortened:

```
CME12.CME    L47, P1, F5, (5)'*', L48, P1, F1,  
              L49, P10, C'ABCD';
```

In the above example, L replaces LINE=, P replaces POSITION=, F replaces FONT=, and C replaces CONSTANT=.

Catalogued CMEs

CMEs need not be part of your JDL. They can be created as separate disk files and still be used as if they were part of the JDL that references them. You can do this by creating a JSL file containing only one or more CMEs, then compiling it using the **xjdc** command. Refer to the “Compiling a JSL” section in the “PDL principles and procedures” chapter. For each CME, an object file is created in the “lcmds” folder on the system disk, where the system looks for resource files when they are needed for printing.

Refer to “Importing LCDS resources” in the “PDL principles and procedures” chapter for the procedure for copying resources to the `/opt/XXnps/resources/lcds/` folder from elsewhere within the Unix file system.

NOTE: When you modify a CME source file, you must recompile it with the `xjdc` command. It is not necessary to recompile the associated JDLs.

When a CME is referenced in a JDL that does not contain that CME, the system searches the “lcds” folder for the CME file (which has the file type extension `.CME`). The CME file is then loaded into memory for use in processing the report.

The MODIFY DJDE can also be used to dynamically associate a catalogued CME file with report processing.

NOTE: CMEs must be catalogued as separate disk files if they are referenced by a MODIFY DJDE.

CME command parameters

The following table summarizes the CME command parameters.

Table 4-14. Summary of the CME command parameters

Parameter	Specifies	Online	Offline	DJDE
CME CONSTANT	Specifies the copy modification character string that will be printed.	Y	Y	N
CME FONT	Selects the fonts for printing input or CME data.	Y	Y	N
CME INK	Specifies the ink for printing the variable data that is affected by the CME	Y	Y	N
CME LINE	Specifies the range of lines on which copy modification occurs.	Y	Y	N
CME POSITION	Specifies the character position at which copy modification begins on a page.	Y	Y	N

The following sections describe the syntax of the CME command parameters and explain their options.

CME CONSTANT

Specifies a character string to print.

Syntax [ac:] CME CONSTANT = *sc*

Options

Table 4-15. CME CONSTANT parameter options and definitions

Option	Definition
<i>sc</i>	<i>string constant.</i> Represents the character string to be printed. The width of the copy modification rectangle is determined by the number of characters specified by <i>sc</i> . More than one string constant is allowed.

Default No default

CME CONSTANT parameter: point to note The CONSTANT parameter of the CME has no default and must be specified, unless all that is required is a font change in the variable data.

CME FONT

Specifies a value to be used as an index into the font list (as specified by the PDE command or a DJDE). The selected font is used when imaging the input data or CME data. (A PDE command is selected by the FORMAT parameter of the OUTPUT command.)

Syntax [ac:] CME FONT = *value*

Option

Table 4-16. CME FONT parameter option and definition

Option	Definition
<i>value</i>	May range from 1 to <i>n</i> , where <i>n</i> is the number of different fonts specified by the FONTS parameter of the PDE command. A value of 1 specifies the first font in the PDE FONTS parameter, 2 the second, and so forth. The default for a value is the current font (specified with the last FONT parameter; initially the value is 1).

Default No default

**CME FONT
parameter: points
to note**

- A font specification applies to input variable data as well as to static CME data. If a line number (LINE) and character position (POSITION) but no insertion text (CONSTANT) are specified, the font change that is called out applies to input variable data at the specified position.
- Fonts may be specified at any point. The last font that is specified remains in effect until another font is specified. An example of a CME with these characteristics is shown below.

```
XYZ: CME      LINE = (1,10), POS=40, FONT=2, POS=80,
              FONT=3, LINE = (11,20), POS=1, FONT=3,
              POS=40, FONT=1, POS=80, FONT=2,
              LINE = (31,50), POS=1, FONT=2, POS=40,
              FONT=3, POS=80, FONT=1;
```

- Whether a font switch is applied to a CME string constant depends upon the order in which FONT and CONSTANT are specified in the CME. If FONT is specified before CONSTANT, the font switch applies to the string constant. If FONT is specified after CONSTANT, the font switch occurs at the line position immediately after the string constant.

CME INK

Specifies the highlight color ink that will be used to print variable data that is affected by the CME or CME constant data.

Syntax [ac:] CME INK = *inkindex*

Option

Table 4-17. CME INK parameter option and definition

Option	Definition
<i>inkindex</i>	An integer value that represents the ink name that will be used to print variable data that is affected by the CME. The value must be from 1 to <i>n</i> , where <i>n</i> is the number of inks in the current ink list (defined by the ILIST parameter of the IDR command or by the ILIST DJDE).

Default 0

**CME INK
parameter: points
to note**

- If 0 is specified (or defaulted) for the INK parameter, the ink for the variable data and the CME text reverts to the ink that was specified in the IDFAULT parameter of the OUTPUT command.
- An inkindex value greater than the ILIST size causes an “out of range” message to be displayed. The operator has the option to continue printing the job using black ink or to abort the job.

CME LINE

Specifies the line range within which the CME is located on the page.

Syntax *ac*: CME LINE = {*n* | (*n*, *m*) | (*n*, -)}

Options

Table 4-18. CME LINE parameter options and definitions

Option	Definition
<i>n</i>	The initial line number of the copy modification rectangle
<i>m</i>	The number of lines to repeat the information. If not specified, the information applies only to the starting line.
-	A dash character indicates that information is to apply to all lines on a page beginning with the line indicated by <i>n</i> .

Default No default.

**CME LINE
parameter: point
to note**

The line numbers specified in the LINE parameter must always be in **ascending** order. In other words, you cannot specify one line number, then list another one of lower value in the same command. For example, the following command is incorrect and will not be compiled:

```
CME1: CME        LINE = (2, 3), POS=15,
                  CONSTANT=(6), 'HELLO', FONTINDEX=3,
                  LINE=1, POS=15;
```

As you can see, the first line parameter specifies starting at line 2, while the second LINE parameter specifies line 1, which contradicts the ascending order.

CME POSITION

Specifies the initial character position at which to begin to apply the CME in the print line.

Syntax [ac:] CME POSITION = *n*

Options

Table 4-19. CME POSITION parameter option and definition

Option	Definition
<i>n</i>	An integer value in the range of 1 (the first position of the print line) and the value specified by the <i>length</i> option of the LINE DATA parameter.

Default 1

CME command: points to note

- The CME LINE and POSITION parameters are order dependent; that is, LINE must always precede POSITION.
- **Data lines:** The position of the line is altered to accommodate the line with a larger font.
- **Multiple copies:** If a multicopy report is aborted before all the pages are processed, one copy is printed if the CMEs are copy sensitive. Otherwise, all copies of the setup pages are printed.
- CMEs are not applied if OVERPRINT=MERGE and FONTINDEX are **both** specified.
- If an **indefinite** range is specified (for example, **10 –**), CMEs are applied only up until the last print line for the page.
If a **definite** range is specified (such as **10, 15**), CMEs are applied regardless of whether or not variable data appears on those lines.
- **Multiple lines and columns:** You may specify multiple lines and multiple columns for each line.
 - Multiple line specifications must be given in ascending (top to bottom of page) order.
 - Multiple column specifications for a line range must be given in ascending (left to right) order.

There also may be multiple text specifications following a column specification. These are combined to form a single text string.

- **String position:** Where a CME string constant is printed on a line depends upon where the POSITION and CONSTANT parameters are specified in the CME. If POSITION is specified before CONSTANT, the string constant is printed at the specified position. If POSITION is specified after CONSTANT, the string constant is printed at the current position (position 1 if no other POSITION or CONSTANT parameter has been specified), and a subsequent CONSTANT or FONT parameter takes effect at the specified POSITION.
- **Double byte font support:** Double byte text strings are supported for the CME CONSTANT value if KCODE or DBCODE is specified for the VOLUME command. The maximum number of double byte characters is 127.
- **Copy sensitive CMEs:**
 - On LPS systems: Copy sensitive CMEs are supported only for offline printing, because multiple passes are required to implement them.
 - On EPS systems: Copy sensitive CMES are supported for online as well as offline printing. Online jobs may be transmitted via channel or the Socket gateway. Only spooling queues may be used.

NOTE: The entire job must be spooled to disk before the RIP process can start. This could cause the spool to become full if the job is extremely large.
 - Copy sensitive CMEs are not supported when COLLATE=NO is specified in the OUTPUT command.

CME command examples

This section shows two examples of uses of the CME command.

Example 1 CME parameters specified in standard form:

```
CME12: CME      LINE=47, POS=1, FONT=5,
              CONSTANT=(5) '*', LINE=48, POSITION=1,
              FONT=1, LINE=49, POS=10,
              CONSTANT='ABCD';
```

CME parameters specified in short form:

```
CME12: CME      L47,P1,F5,(5) '*',L48,P1,F1,L49,P10,C'ABCD';
```

or

```
CME12: CME      L47P1F5(5) '*L48P1F1L49P10C'ABCD';
```

Example 2 The following is an example of copy sensitive CMEs.

```
CME1: CME      LINE=3, POS=59, CONSTANT='FIRST
              QUARTER';

CME2: CME      LINE=(37,3), POS=81, CONSTANT=(6) '*';

CME3: CME      LINE=(1,60), POS=5, FONT=2, POS=12,
              FONT=1;

OUTPUT        COPIES=3, MODIFY=(CME1,1,1),
              MODIFY=(CME2,2,1), MODIFY=(CME3,3,1);
```

For the first copy of the report, line 3 is modified by the text 'FIRST QUARTER'. For the second copy, the character '*' is inserted in lines 37, 38, and 39 for 6 character positions (starting in column 81). For copy 3, fonts are changed for lines 1 to 60 at character positions 5 and 12. These fonts must be defined in the FONTS parameter of the PDE command.

IDR command

Allows you to define default ink catalogs, palettes, and inks.

ac identifier You must specify an *ac* identifier when defining an IDR. This identifier is referenced by the OUTPUT IDR parameter or the IDR DJDE. If a JSL contains an IDR command, but does not specify an IDR name, the following message appears when the JSL is compiled:

```
IDR FILE WILL BE USED DURING PRINTING.
```

The IDR command may be coded as part of the JSL or created as separate files that may be referenced by JDLs or DJDEs. (A separate file is created by the XJDC compiler when the commands that define the IDR are coded outside the JSL. The IDR command identifier is used as the filename.) An IDR that is created as a separate disk file may be used as if it were part of the JDL that references it.

If a DJDE will call the IDR, the IDR must be defined before the JDL command, so that the IDR is saved on the system disk as a separate file.

NOTE: The IDR command is a highlight color command that is recognized by printers such as the Xerox 4850, 4890, and DP92C LPS as well as the new DT 128/155/180 HLC Printing Systems. It may be included in JSLs that are created on your monochrome system for highlight color printing. If the system encounters this command when printing, it is ignored.

IDR overrides The OUTPUT IDR parameter references an IDR command (with appropriate parameters) for each job. These IDRs are used for the job unless they are overridden by other commands or command parameters. For example, the IDFAULT parameter of the OUTPUT command can override an ink specified in an IDR that has been referenced in a job.

The default ink is defined according to the following override sequence:

1. The IDFAULT DJDE has highest priority.
2. The OUTPUT IDFAULT parameter has the next priority at the job level.
3. A catalog level default overrides a system level default if it is specified at the job level.
4. A system level default has next priority if it is not overridden at the catalog or job levels.

If no IDFAULT is specified, the first element of the ILIST is used as the default. If no ILIST is specified, the system default is used.

IDR command parameters

The following table summarizes the IDR command parameters.

Table 4-20. Summary of IDR command parameters

Parameter	Specifies	Online	Offline	DJDE
IDR ICATALOG	Specifies a default ink catalog that will be used when there is no specific catalog reference.	Y	Y	Y
IDR ILIST	Provides a list of all the inks that may be referenced by indexing when variable data is printed through DJDEs.	Y	Y	Y
IDR PALETTE	Specifies a default palette that will be used when there is no specific palette reference.	Y	Y	Y

IDR ICATALOG

Establishes a default ink catalog that will be used in ink references when there is no specific catalog reference in the JDL.

Syntax *ac*:IDR ICATALOG = *inkcatalogname*

Options

Table 4-21. IDR ICATALOG parameter options and definitions

Option	Definition
<i>ink catalog name</i>	Name of the ink catalog that will be used when no other catalog is referenced.

Default System default ink catalog

IDR ICATALOG parameter: point to note The ink catalog selection remains in effect until it is changed by another IDR ICATALOG parameter. This also applies to ink references that are specified by DJDEs.

IDR ILIST

This parameter provides a list of all the inks which may be referenced by indexing in printing variable input data or CME data.

Syntax `ac:IDR ILIST = {'inkname' | ('inkname1' ['inkname2'] [, ...])}`

Options

Table 4-22. IDR ILIST parameter options and definitions

Option	Definition
'inkname'	Name of an ink that may be referenced by ink indexing during printing. Can be a solid primary color only.

Default No default

IDR ILIST parameter: points to note

- The first ink in the ILIST parameter is the default unless it is overridden by an IDFAULT parameter.
- The maximum number of ink names that may be specified in the ILIST parameter is 64.
- If an IDR parameter is not specified in the OUTPUT command or if the IDR that is specified does not exist, the system supplies DFIDR.IDR as the system default IDR. DFIDR.IDR is a standard file that is provided with the system software. It contains the definition of the system default 'BLACK' ink, specified by the following command:

```
DFIDR: IDR ILIST = 'BLACK';
```
- When the VOLUME command CODE=NONE parameter is specified, an ILIST parameter referencing a highlight color primary causes the entire report to print in highlight mode. If ILIST references only black ink, the report prints in black mode.

IDR PALETTE

Establishes a default inks palette that will be used in ink references when there is no specific palette reference.

Syntax `ac:IDR PALETTE = 'palette'`

Options**Table 4-23. IDR PALETTE parameter options and definitions**

Option	Definition
<i>'palette'</i>	Name of the default palette that will be used in ink references in the absence of a specific palette reference.

Default No default

IDR PALETTE parameter: point to note The palette that is identified by this parameter remains in effect until it is changed by another IDR PALETTE parameter. This also applies to ink references that are specified by DJDEs.

LINE command

The LINE command provides parameters that define the characteristics of the user portion of the input data record and specify how it will be printed.

LINE command parameters

The following table summarizes the LINE command parameters.

Table 4-24. Summary of LINE command parameters

Parameter	Specifies	Online	Offline	DJDE
LINE BASELINE	Specifies the method of calculation for the baseline position of the character that is being printed.	Y	N	N
LINE BLANKTYPE	Specifies whether or not the "shift in" and "shift out" codes are printed as blank spaces.	Y	N	N
LINE DATA	Defines the user portion of the input record.	Y	Y	Y
LINE FCB	Specifies whether to suppress or process the forms control buffer that is transmitted from the host.	Y	N	N

Table 4-24. Summary of LINE command parameters (Continued)

Parameter	Specifies	Online	Offline	DJDE
LINE FDATA	Specifies starting and ending points of the file data within a record.	Y	Y	N
LINE FONTINDEX	Specifies that a field within the user portion of the record defines the index to a specific font to be used for that line.	Y	Y	Y
LINE GDATA	Specifies starting and ending points of graphic data within a record.	N	Y	N
LINE INKINDEX	Specifies a field within a data record that contains a number that represents the ink index in the current ILIST.	Y	Y	Y
LINE LPI	Specifies the line spacing values for each line	Y	N	Y
LINE MARGIN	Defines the size of the left margin on a physical page	Y	Y	Y
LINE OVERPRINT	Specifies the manner in which overprint lines are handled.	Y	Y	Y
LINE PCC	Specifies the location of the printer carriage control field.	N	Y	N
LINE PCCTYPE	Specifies a set of printer carriage control codes that will be used for a job.	N	N	N
LINE VFU	Specifies a vertical format unit table that will be used for a job.	Y	Y	N

The following sections describe the syntax of the command parameters and explain their options.

LINE BASELINE

Defines how to calculate the baseline position of the character that is being printed.

Syntax LINE BASELINE = {TOP | CENTER | BOTTOM | LARGE[ST]}

Options

Table 4-25. LINE BASELINE parameter options and definitions

Option	Definition
TOP	Determines the baseline position from the top of each line by using the BASELINE parameter of the first font in the PDE font list.
CENTER	Positions all of the characters so that their center lines match.
BOTTOM	Determines the baseline from the bottom of each line by using the BASELINE parameter of the first font in the PDE font list.
LARGE[ST]	Determines the baseline position and the line spacing by using the largest font in the PDE font list.

Default LARGE[ST]

LINE BASELINE parameter: point to note If KANJI is specified as one of the fonts (KANJI = YES), a BASELINE=LARGE command is treated as BASELINE=TOP.

LINE BLANKTYPE

Specifies whether or not the “shift in” and “shift out” function codes are printed as spaces.

Syntax LINE BLANKTYPE = {F | V | SPACE | NOSPACE}

Options

Table 4-26. LINE BLANKTYPE parameter options and definitions

Option	Definition
F	Specifies the width of the back space character that is associated with the width of the full-sized single-byte character, or of the half-sized double-byte character.
V	Specifies the width of the back space character that is associated with the full-sized single-byte or double-byte character.
SPACE	Replaces X'0E' and X'0F' (“shift-in” and “shift-out”) function codes with single-byte blank character spaces.
NOSPACE	Specifies that no space code is substituted.

Default NOSPACE

LINE DATA

Specifies the location and length of the print line data within an input data record.

Syntax LINE DATA = (*pdo*, *length*)

Options

Table 4-27. LINE DATA parameter options and definitions

Option	Definition
<i>pdo</i>	<i>print data offset</i> . Number of bytes between the start of the user portion of the record and the first character of the record to be printed.
<i>length</i>	Maximum length of printable data within each logical record.

Default Online: (0,150)
Offline: (1,132)

LINE FCB

Specifies whether to suppress or to process host transmitted forms control buffers (FCB).

Syntax LINE FCB = {IGNORE | PROCESS}

Options

Table 4-28. LINE FCB parameter options and definitions

Option	Definition
IGNORE	Suppresses the processing of the host transmitted forms control buffer (FCB).
PROCESS	Accepts FCB processing. The VFU parameter defines the vertical positioning control table if the FCB is ignored. For online systems only.

Default PROCESS

**LINE FCB
parameter: points
to note**

- If you specify FCB=PROCESS, an FCB load causes positioning to TOF. If the system is already at TOF, page eject does not occur. However, if the line number before the FCB load is greater than TOF, a page eject occurs.
- If you specify FCB=PROCESS and an FCB is sent from the host, the later FCB overrides the previous FCB or VFU. Its length replaces the previous BOF. Furthermore, its contents and length are saved on the disk.
- If no Bottom Of Form is specified in the JDE, the length of the last FCB sent from the host is retrieved from the disk and becomes BOF. Note that Top of FORM (TOF) is not affected by the FCB.
- *Non-U. S. markets only:* The print position indexing (PPI) byte of the FCB is suppressed.

LINE FDATA

Specifies the starting point of the file data from the beginning of the user portion of a data record. This command can be used to skip past information, such as a PCC byte that is not actually part of the file data.

Syntax LINE FDATA = (*offset*, *termination*)

Options**Table 4-29. LINE FDATA parameter options and definitions**

Option	Definition
<i>offset</i>	The starting point of the line data.
<i>termination</i>	The terminating byte of the record. The options are: <ul style="list-style-type: none"> • DEFAULT <ul style="list-style-type: none"> – If online, a single terminating byte exists. – If offline, no terminating byte exists. • <i>n</i>: The number of terminating bytes that exist

Default *offset*: 0
termination: DEFAULT

LINE FONTINDEX

Specifies that a field within the user portion of a record defines the index to a specific font to be used for that line. If FONTINDEX is not specified, no index is used.

Syntax LINE FONTINDEX = {*offset* | (*offset* [, *initval* [, *bitopt*]]) | NONE}

Options

Table 4-30. LINE FONTINDEX parameter options and definitions

Option	Definition
<i>offset</i>	Specifies the byte offset in the data record where the character that is to be used as a font index number is located. Refer to "LINE OVERPRINT" later in this chapter for a discussion of FONTINDEX usage with overprint lines and maximum number of fonts.
<i>initval</i>	<i>initial value.</i> Index number associated with the first font in the font list (i.e., the number the font list starts with). This value can be one of the following: <ul style="list-style-type: none"> • ONE specifies that an index value of 1 is associated with the first font in the font list. • ZERO specifies that an index value of 0 is associated with the first font in the font list, an index value of 1 is associated with the second font in the font list, and so forth. The default for the initial font index value is ONE.
<i>bitopt</i>	<i>bit option</i> A number specifying the number of low order bits within the font index byte, which, in turn, specifies an index value into the font list of the current PDE. The <i>bitopt</i> value may be 1 through 7. The default <i>bitopt</i> value is 4.
NONE	Specifies that there is no font index.

Default NONE

LINE FONTINDEX
parameter: points
to note

- When the *bitopt* option is specified, the *initval* must also be specified.
- If the *initval* is ONE or is not specified, the value of the font index byte in the data record is a number in the range 1 to *n*, where *n* is the number of fonts specified in the PDE parameter (1 to 128). If ZERO is specified, the font index is a number in the range 0 to *n*, where *n* is the number of fonts specified in the PDE parameter minus one (0 to 127). The font index value must be present in every record. If the FONTINDEX in the data record is greater than the number of fonts specified, the first font in the list is used.
- If the FONTINDEX feature is specified, the font index byte is processed for every printed record, and for DJDEs where the IDEN DJPCC parameter causes such processing. A valid FONTINDEX byte should be present in all such records, because it controls line spacing at page transitions.

If the offset to the font index value exceeds the logical record size, the first font in the font list is used.
- If there is a change from a small font to a large font when LINE OVERPRINT=MERGE has been specified, the line is adjusted downward by the difference in height between the first and the largest fonts in the line. (This applies to FreeFlow Print Server LCDS systems, 4850/4890 LPS, and DP92C LPS only.)
- **FreeFlow Print Server only:** When a new FONTINDEX is specified for a print record, the new line spacing value is always used, regardless of whether the record actually contains printable data.

LINE GDATA

Specifies the starting point of the graphic data from the beginning of the user portion of a data record. This command can be used to skip past information, such as a PCC byte that is not actually part of the image.

Syntax LINE GDATA = (*offset, termination*)

Options

Table 4-31. LINE GDATA parameter options and definitions

Option	Definition
<i>offset</i>	The starting point of the graphic data.
<i>termination</i>	The terminating byte of the record. The options are: <ul style="list-style-type: none"> • DEFAULT <ul style="list-style-type: none"> – If online, a single terminating byte exists. – If offline, no terminating byte exists. • <i>n</i>: The number of terminating bytes that exist

Default *offset*: 0

termination: DEFAULT

LINE INKINDEX

Specifies a field within a data record that contains a number that represents the ink index in the current ILIST.

Syntax LINE INKINDEX = {*offset* | (*offset* [, *initval* [, *bitopt*]]) | NONE}

Options

Table 4-32. LINE INKINDEX parameter options and definitions

Option	Definition
<i>offset</i>	Indicates the byte offset in the data record where the ink index number is located.
<i>initval</i>	<i>initial value</i> . Specifies an index value that is associated with the first ink in the ink list. Must be ONE or ZERO. <ul style="list-style-type: none"> • “ZERO” specifies that the first ink on the ink list is considered “ink 0.” • “ONE” indicates that the first ink on the ink list is considered “ink 1.” The default <i>initval</i> is ONE.
<i>bitopt</i>	<i>bit option</i> Specifies the number of bits that should be used in calculating the ink index. The range is 1 through 7. The default <i>bitopt</i> value is 4.
NONE	Specifies that there is no ink index.

Default NONE

**LINE INKINDEX
parameter: points
to note**

- The FreeFlow Print Server LCDS systems support only the offset option for the LINE INKINDEX parameter.
- When the *bitopt* option is specified, the *initval* must also be specified.
- The printer permits an entire line or a portion of a line to be printed in highlight color. You can specify highlight color for variable data on a form. (This is analogous to the output capability of font switching.)

Variable data is printed using the ink that is specified in the INKINDEX byte. If the INKINDEX byte is blank or does not exist in the variable data record, the variable data is printed using the default ink.

**LINE INKINDEX
parameter
example**

```
LINE      DATA=(1,132), FONTINDEX=133,
          INKINDEX=143;
```

LINE LPI

Specifies the line spacing values for each line.

Syntax LINE LPI = *{(linespacing {LPI | DOTS | XDOTS}) | (linespacing {LPI | DOTS | XDOTS}, lineno, (...))}*

Options**Table 4-33. LINE LPI parameter options and definitions**

Option	Definition
<i>linespacing</i>	Specifies the line spacing value. May be measured in: <ul style="list-style-type: none"> • LPI (lines per inch) • DOTS • XDOTS (600 dpi) The default unit is LPI.
<i>lineno</i>	<i>line number</i> Specifies the line number or numbers over which the line spacing will be applied. The options are: <ul style="list-style-type: none"> • <i>n</i> Number of the line to which the specified <i>linespacing</i> will be applied • <i>n-</i> Number of the line from which the specified <i>linespacing</i> will be applied through BOF (bottom of form). • <i>n-m</i> The specified <i>linespacing</i> will be applied from line <i>n</i> through line <i>m</i>.

Default No default

LINE LPI parameter: points to note

- If the LARGE[ST] is specified for the LINE BASELINE parameter, the LPI parameter is ignored.
- The line spacing value is not based on the maximum LPI font of the line. Instead, it is based on the value that is specified in the command:

LINE LPI = LINESPACING

LINE MARGIN

Specifies the left printing margin within each logical page.

Syntax LINE MARGIN = {*value* | (*value*, *valuetype*)}

Options

Table 4-34. LINE MARGIN parameter options and definitions

Option	Definition
<i>value</i>	Specifies the distance from the left edge of the logical page (as indicated by the current BEGIN value in effect) to the left margin. Has the format <i>nnn.mm</i> (a positive decimal number of up to three digits, with up to 2 digits to the right of the decimal point).
<i>valuetype</i>	Unit of measure for the margin value. Available unit options include: <ul style="list-style-type: none"> • IN (inches) • CM (centimeters) • POS (character positions). <i>NOTE: When you run a CODE=NONE job with DUPLEX=YES and SHIFT=YES, you must specify MARGIN in inches.</i>

Default (1, POS)

LINE MARGIN parameter: point to note

A value must be specified as an integer (*nnn*) if its *valuetype* is character positions (POS).

LINE OVERPRINT

Specifies how overprint lines are handled. (Overprint lines are print lines whose carriage control specifies printing with no line spacing after the last printed line.)

Syntax LINE OVERPRINT = (*overopt*, *disp*)

Options

Table 4-35. LINE OVERPRINT parameter options and definitions

Option	Definition
<i>overopt</i>	<p><i>overprint option.</i></p> <p>This option has the following choices:</p> <ul style="list-style-type: none"> • PRINT: Specifies that all overprint lines are printed as they would be on an impact printer; that is, the second line is printed over the top of the first with no regard to the previous data, including character spacing, which may vary between the two lines of data. • IGNORE: All overprint lines are ignored. • MERGE: Same as PRINT except when used with FONTINDEX or CME processing. Refer to 1) the "LINE OVERPRINT parameter: points to note" section below and, 2) Example 2 of the "Examples" section for this parameter. • PRINT2: Specifies that up to two consecutive lines are printed per line; that is, one line and one overprint. Other overprints for the line are ignored.
<i>disp</i>	<p><i>display.</i></p> <p>This option has the following components:</p> <ul style="list-style-type: none"> • DISP • NODISP <p><i>NOTE: This option is not functional on the FreeFlow Print Server LCDS systems. It is preserved here for compatibility with other Xerox laser printing systems. The number of overprint lines is always printed on the accounting page.</i></p>

Default (PRINT, NODISP)

**LINE OVERPRINT
parameter: points
to note**

FONTINDEX and OVERPRINT: When used in conjunction with OVERPRINT, FONTINDEX is handled as follows:

- For OVERPRINT=PRINT, the printing system overprints records analogously to an impact printer if the fonts are the same size. If the fonts differ, records are overprinted without regard to character spacing.
- For OVERPRINT=MERGE, the system replaces blank characters in the previously printable line, if this print record overprints the line. Character spacing values are adjusted; thus, proportionally spaced or different size fonts may be used, and the system performs the character placement.

Blank characters in the previous printable line are replaced only when they are translated using the CODE table into an ASCII X'20' or into a character value greater than that of the highest character in the specified font.

**LINE OVERPRINT
parameter
example**

Following is an example of the LINE OVERPRINT parameter.

```
LINE    OVERPRINT=(MERGE,NODISP) , VFU=V1,
        DATA=(1,132) , PCCTYPE=ANSI,
        PCC=(0,NOTRAN) ;
```

LINE PCC

Specifies the position (and possible translation) of the printer carriage control field.

NOTE: The PCC parameter is ignored in online printing by the FreeFlow Print Server LCDS systems, because online carriage control is derived from commands that are sent using the online channel protocol. However, you may create a JSL containing this parameter and transfer it to another laser printing system for use with offline printing.

Syntax LINE PCC = (*offset* [, *transtype*])

Options

Table 4-36. LINE PCC parameter options and definitions

Option	Definition
<i>offset</i>	A number specifying the byte offset of the user portion of the record within the user portion of each record to the printer carriage control (PCC) field. The default <i>offset</i> value is 0.
<i>transtype</i>	<i>translation type.</i> Specifies whether or not the printer carriage control byte is to undergo code translation. This option has the following alternatives: <ul style="list-style-type: none"> • TRAN: Indicates that the byte is to be translated into standard EBCDIC before being applied, using the translation defined in the CODE parameter of the VOLUME command. • NOTRAN: Prohibits translation. The <i>transtype</i> default is NOTRAN.

Default (0, NOTRAN)

LINE PCCTYPE

Specifies a set of printer carriage control codes that will be used in printing a job.

Syntax LINE PCCTYPE = {*PCCname* | *PCCid* | USER}

Options**Table 4-37. LINE PCCTYPE parameter options and definitions**

Option	Definition
<i>PCCname</i>	<p><i>printer carriage control name.</i></p> <p>Choices are:</p> <ul style="list-style-type: none"> • ANSI • B2500 • B2700 • B3500 • B3700 • B4700 • B6700 • F650D • H6000 • H2000 • H8276 • IBM1401 • IBM1403 • IBM3211 • IBM4245 • NCR • Univac • US70 • Xerox
<i>PCCid</i>	<p><i>printer carriage control identifier</i></p> <p>Refers to a PCC table that was defined in the JSL with the specified identifier.</p>
USER	Refers to a PCC table that was defined in the JSL without a label identifier.

Default Online: IBM4245
Offline: ANSI

LINE PCCTYPE
parameter: points
to note

- For the FreeFlow Print Server LCDS systems, this parameter is treated as if the system were an IBM 3211.
Note that there is no functional difference between IBM3211 and IBM4245 for PCC types.
- Creation of a user defined PCC table, which may be referenced by either an identifier *id* or the keyword USER, is specified using the PCC command. Refer to “PCC command” section of the “Specifying input parameters” chapter.
- The INITIAL parameter for any of the PCCTYPEs listed in the previous table (except ANSI or HOST=RSX11) is TOF.
For ANSI or HOST=RSX11, the INITIAL parameter is BOF.
For USER or *PCCid*, the INITIAL parameter is set by the user in the PCC command.
- The PCCTYPE=IBM3211 or IBM4245 specifies that the printer online interface will perform checks, such as for bad or NO OP parameters.

LINE VFU

Specifies a vertical format unit (VFU) table.

Syntax LINE VFU = {*vfuid* | NONE}

Options

Table 4-38. LINE VFU parameter options and definitions

Option	Definition
<i>vfuid</i>	<i>vertical format unit identifier.</i> The command identifier of the VFU table, which must precede this reference to it. The VFU table defines print line positions corresponding to skip to channel parameters for the job to be processed.
NONE	Indicates that any skip to channel parameter is to be replaced by a carriage control of Print and Space 1.

Default NONE

LINE command: points to note

- **Line spacing with multiple fonts:** The vertical spacing of a line is the line spacing of the largest font in use in the previous line. The current line can also be adjusted downward by the difference in height between the first and the largest font in the current line.

The line spacing of the first line in a report is determined by the first font in the PDE, provided the FONTINDEX parameter has not been specified. When FONTINDEX is specified, the height of the first line of a report is determined by the height of the font selected by the font index value in that first line. If there is no font index value in the record and FONTINDEX is specified, the spacing for the first line of the report is determined by the first font in the PDE.

- **Positioning of the first line on subsequent pages.** The position of the first line, and the spacing of subsequent lines, on the pages following page 1 is determined a different font from the previous page, depending on the printing system.
 - **FreeFlow Print Server LCDS systems:** Each time a new font list is downloaded for a page, font 0 is used to position the first line of that page.
 - **Other LPS:** When a page transition occurs, the line positioning and spacing is determined by different fonts, depending on the conditions.
 - When the FONTINDEX or CME parameters are specified, the line spacing of subsequent pages is determined by the index of the last font on the previous page into the current PDL font list. The height of the last font used determines the initial base line of that first print line.
 - If the index of the last font used on the previous page is greater than the number of fonts on the current page, the first font on the current page is used to determine spacing and positioning.
- **Print line data:** When you are changing the font index or a print data offset (pdo) to a value greater than the default value (150), the RECORD LENGTH command must also be changed accordingly. Otherwise, the record is truncated to the length that was specified in the initial JDL.

LINE command examples

Here are some examples of use of the LINE command.

Example 1 The LINE command below defines the characteristics of the following record structure shown in the following figure.

```
LINE      DATA=(1,132), PCC=(0,NOTRAN),
          PCCTYPE=IBM1403, FONTINDEX=133;
```

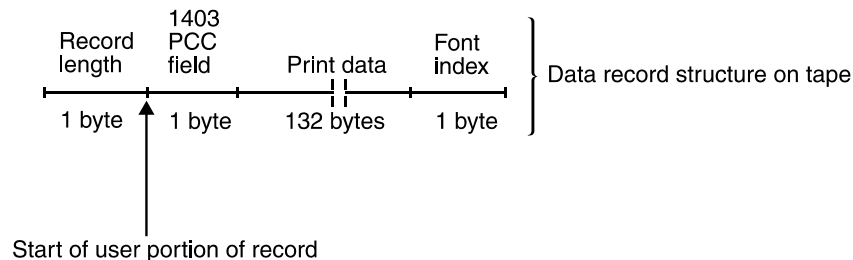

Figure 4-1. Diagram of a sample print data offset (pdo) parameter

The print data offset (*pdo*) option of the DATA parameter (the number of bytes between the start of the user portion of the record and the first character of the record to be printed) is 1 byte.

In the sample shown in the above figure, the print length parameter (the number of characters in the longest print line in the record) is defined as 132 bytes. The carriage control is defined as IBM1403, and the position of the carriage control character is the first byte within the user portion of the record. The position of the font index (an index value into a font list that indicates which font is to be selected) is byte 133 (relative to 0).

Example 2 In the following command, PCC = 0 (can be omitted because it is the default). The record PREAMBLE=0.

```
LINE      PCCTYPE=NONE, DATA=(2,60),
          VFU=V1, FONTINDEX=1;
```

The following figure illustrates the command shown in example 2.

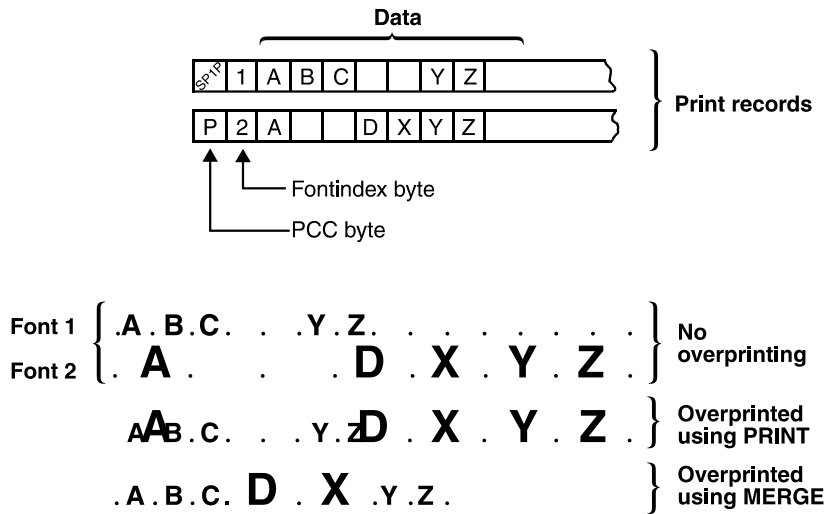

Figure 4-2. Sample data record structure

Example 3 LINE PCCTYPE=NONE, DATA=(1,57), VFU=V1;

MESSAGE command

The MESSAGE command permits you to inform the operator of special conditions by displaying user defined text on the screen.

- All MESSAGE command parameters must be specified in a single command. If multiple message commands are specified, the parameters in the final command are applied.
- The FreeFlow Print Server LCDS systems do not support the bar code option. Bar code commands that are encountered by the print server are ignored, and no syntax errors are noted. No messages or operator information pages are generated.

MESSAGE command parameters

The following table summarizes the MESSAGE command parameters.

Table 4-39. Summary of MESSAGE command parameters

Parameter	Specifies	Online	Offline	DJDE
MESSAGE ITEXT	Specifies that a message to the operator will be displayed during input processing.	Y	Y	Y
MESSAGE OTEXT	Specifies that a message to the operator will be displayed during printing.	Y	Y	Y

The following sections describe the syntax of the command parameters and explain the parameter options.

MESSAGE ITEXT

("Input text") Specifies a text message to be sent to the operator during input processing.

Syntax MESSAGE ITEXT = {(sc [, *passnum*]) | NONE | WAIT}

Options

Table 4-40. MESSAGE ITEXT parameter options and definitions

Option	Definition
NONE	Specifies that no text message is sent to the operator during input processing.
<i>passnum</i>	<i>pass number</i> Specifies the pass (copy ply) to which the message text applies. The message is sent to the operator just before processing of the indicated pass is begun. If no pass number is specified, the indicated message is sent at the beginning of the first pass.
<i>sc</i>	<i>string constant</i> Specifies a text message (string constant) of up to 80 characters.
WAIT	Specifies that after the text is displayed, input is suspended until the operator has initiated a Continue request. <i>NOTE: The FreeFlow Print Server LCDS systems do not support the ITEXT WAIT parameter. It is ignored, and no error message is displayed.</i>

Default NONE

**MESSAGE ITEXT
parameter: points
to note**

- If EBCDIC or hexadecimal strings or hex defined bytes using “!” in a character string are used in a MESSAGE command, they are interpreted as standard EBCDIC and are translated to extended ASCII.
- You can use the # sign as a case toggle to switch between upper- and lowercase when entering the messages.
- ITEXT messages for more copies than one are ignored. No error message is displayed.

MESSAGE OTEXT

(“Output text”) Specifies a text message to be output to the operator during job printing.

Syntax MESSAGE OTEXT= {(sc [, {passnum | END}] [,WAIT]) | NONE}

Options**Table 4-41. MESSAGE OTEXT parameter options and definitions**

Option	Definition
NONE	Specifies that no text message is sent to the operator during job printing.
sc	<i>string constant</i> Specifies a text message of up to 80 characters. Refer to “MESSAGE OTEXT: points to note” below.
<i>passnum</i>	<i>pass number.</i> Specifies the pass (copy ply) to which the text applies. Multiple messages, one per passnum, may be specified in a JSL. The message is sent to the operator before the beginning of printing the specified report ply. If no pass number is specified, the text is sent once, at the beginning of printing the first copy of the report.
WAIT	Specifies that after the text is displayed, printing is suspended until the operator has initiated a Continue request.
END	Specifies that the text is displayed after the last copy of the report is printed.

Default NONE

MESSAGE OTEXT: points to note

- Multiple line messages may be specified for a single copy by one of the following methods:
 - Specifying the copy number more than once in different OTEXT parameters
 - Specifying a list of string constants contained in a second level of parentheses.
- A maximum of 395 messages is permitted per report.

MESSAGE command: points to note

- You can use the # sign as a case toggle to switch between upper- and lowercase when entering the messages.
- Messages may be entered in hexadecimal, octal, ASCII, H2, H6, or EBCDIC. You must enter an apostrophe (') followed by the appropriate letter for the language. (If there are no introductory symbols, the message defaults to EBCDIC.) Refer to the “Types of string constants” table in the “PDL principles and procedures” chapter for further information.

MESSAGE command example

The following MESSAGE command informs the operator that blue paper is required for copy 2 of a 4 copy report. Printing is suspended at the appropriate points so that the operator can load the paper.

```
OUTPUT      COPIES= 4;
MESSAGE     OTEXT= ('LOAD BLUE PAPER',2,WAIT),
            OTEXT= ('LOAD WHITE PAPER',3,WAIT),
            OTEXT= (('LAST COPY DONE', 'RELOAD STANDARD PAPER'),
                    END, WAIT);
```

OUTPUT command

The OUTPUT command controls the organization and format of a report, including the number of copies of a report, the forms to be printed with the variable data, report offsetting, and the use of simplex or duplex mode. For further information on graphics features, refer to the “Using PDL commands for graphics” chapter.

OUTPUT command parameters

The following table summarizes the OUTPUT command parameters.

Table 4-42. Summary of OUTPUT command parameters

Parameter	Specifies	Online	Offline	DJDE
OUTPUT BFORM	Prints a specified form only on the back sides of duplex pages.	Y	Y	Y
OUTPUT BINDING	Specifies page rotation for printing for short edge or long edge binding.	Y	N	N
OUTPUT COLLATE	Specifies whether report pages will be collated or uncollated.	Y	Y	Y
OUTPUT COPIES	Specifies the number of report copies that will be printed.	Y	Y	Y
OUTPUT COVER	Feeds cover pages for a report from the tray that contains the AUX stock.	Y	Y	N
OUTPUT CYCLEFORMS	Associates forms with report pages in a repeating sequence.	Y	Y	N
OUTPUT DENSITY	Enables or disables image generator local density functionality. (Listed for compatibility purposes; not supported on FreeFlow Print Server LCDS systems.)	Y	Y	N
OUTPUT DESTINATION	Specifies the destination for printed output.	Y	Y	Y
OUTPUT DUPLEX	Prints the job on both sides of the paper.	Y	Y	Y
OUTPUT FACEUP	Delivers and stacks the printed sheets face up in the stacker.	Y	Y	N
OUTPUT FEED	Specifies the tray from which paper will feed for the job.	Y	Y	Y
OUTPUT FORMAT	Specifies a page descriptor entry (PDE) for the job.	Y	Y	Y
OUTPUT FORMS	Associates forms with report copies	Y	Y	Y

Table 4-42. Summary of OUTPUT command parameters (Continued)

Parameter	Specifies	Online	Offline	DJDE
OUTPUT GRAPHICS	Specifies if and how graphics are used in the job.	Y	Y	N
OUTPUT IDFAULT	Specifies the default ink that will be used for parameters in which no ink is specified.	Y	Y	Y
OUTPUT IDR	Specifies the name of an ink descriptor (IDR) that will be used for the job.	Y	Y	Y
OUTPUT IMAGE	Specifies initial scaling and positioning for Batch mode graphics.	Y	Y	Y
OUTPUT INVERT	Rotates an image 180 degrees on the printed page.	Y	Y	Y
OUTPUT IRESULT	Specifies whether the result of overlapping pixels will be a colored or a black pixel.	Y	Y	Y
OUTPUT LOGO	Enables selection and positioning of a logo.	Y	Y	Y
OUTPUT MODIFY	Associates copy modification entries with report copies.	Y	Y	Y
OUTPUT NTO1	Specifies on a report basis whether the pages of all copies of a report are printed in ascending (1 to N) or descending (N to 1) order.	Y	Y	Y
OUTPUT NUMBER	Specifies whether page numbers will be printed and, if so, defines their location and appearance.	Y	Y	Y
OUTPUT OFFSET	Specifies whether reports are offset in the stacker.	Y	Y	N
OUTPUT OSTK	Specifies the job will be printed on ordered stock.	Y	Y	N
OUTPUT PAPERSIZE	Specifies the size paper to be used for the job.	Y	Y	N
OUTPUT PURGE	Specifies the default disposition of document interleaved graphics after printing.	Y	Y	N
OUTPUT SF1FUNCTION	Specifies a function for sheet finisher function number 1.	Y	Y	Y
OUTPUT SF2FUNCTION	Specifies a function for sheet finisher function number 2.	Y	Y	Y
OUTPUT SHIFT	Shifts image on the y axis (vertically) on the page.	Y	Y	Y
OUTPUT SIZING	Controls matching the paper that is specified when the page is formatted with the paper sizes in the trays.	Y	Y	Y

Table 4-42. Summary of OUTPUT command parameters (Continued)

Parameter	Specifies	Online	Offline	DJDE
OUTPUT STAPLE	Places a wire stitch in copied sets of output.	Y	Y	N
OUTPUT STOCKS	Specifies a STOCKSET for use in the report.	Y	Y	Y
OUTPUT SYSPPR	Specifies the system page paper size for a job.	Y	Y	N
OUTPUT TMODE	Specifies a maximum paper width in order to improve throughput efficiency when mixed paper sizes are used. <i>NOTE: This feature is not supported for the Nuvera MX systems.</i>	Y	Y	Y
OUTPUT TRANS	Specifies that transparencies are used in the job.	Y	Y	N
OUTPUT UNITS	Specifies user selected units for positioning graphics.	Y	Y	N
OUTPUT XSHIFT	Shifts the image upward or downward on the page.	Y	Y	Y

OUTPUT BFORM

Prints a form on the back side of a duplex data sheet. In association with the duplex printing mode DUPLEX=YES, a page containing only a form (no variable data can be printed with this page) may be printed on the back side of a data sheet. This feature can be used to print static data on the back of each sheet in a report without the use of DJDEs or the repetitive processing of that static data for the back sides of successive sheets.

Syntax OUTPUT BFORM = {NONE | (*formid* [, *init* [, *copies*]]
[, (INKS, *inkref*₁ [, *inkref*₂] ...))}]

Options

Table 4-43. BFORM parameter options and definitions

Option	Definition
<i>formid</i>	Specifies the name of the back form – a one to six character form file name (may be numeric, alpha, or alphanumeric), which exists on the system disk.
<i>init</i>	<i>initial copy.</i> Specifies the first copy set on which the BFORM will be placed.
<i>copies</i>	Specifies the numbers of copy sets that will contain the BFORM.

Table 4-43. BFORM parameter options and definitions (Continued)

Option	Definition
NONE	Specifies that no form is to be added to the associated report page of variable data.
<i>inkref</i>	<i>Ink reference.</i> Identifies the inks that override the corresponding inks that are specified in the ink list of the form. If a form does not contain an ink list, the form is printed in black.

Default NONE

OUTPUT BINDING

Specifies printing for long edge or short edge binding. Causes the page to be rotated to orient it correctly for binding by a finishing device on the long or short edge.

Syntax OUTPUT BINDING = {LONG | SHORT}

Options

Table 4-44. OUTPUT BINDING parameter options and definitions

Option	Definition
LONG	Rotates the sheet so that binding space will occur along the long edge of the printed page.
SHORT	Rotates the sheet so that binding space will occur along the short edge of the printed page.

Default LONG

OUTPUT BINDING parameter: point to note The following figure shows the output using two-hole drilled long edge feed paper with short edge binding.

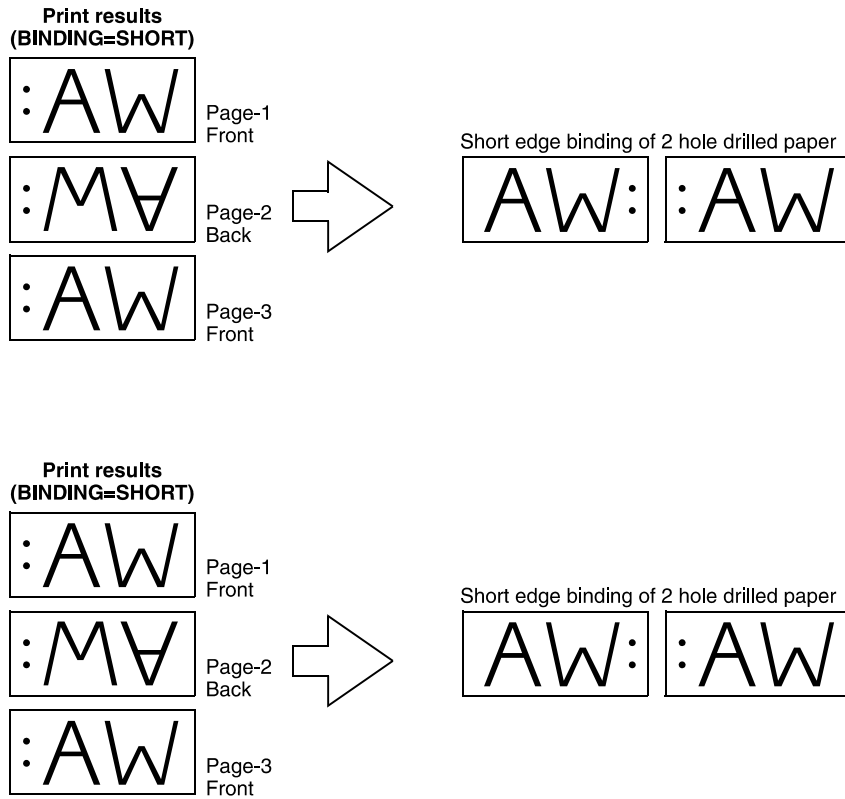

Figure 4-3. Two-hole drilled output from a long edge feed job, with short edge binding

The following figure shows the results of different specifications.

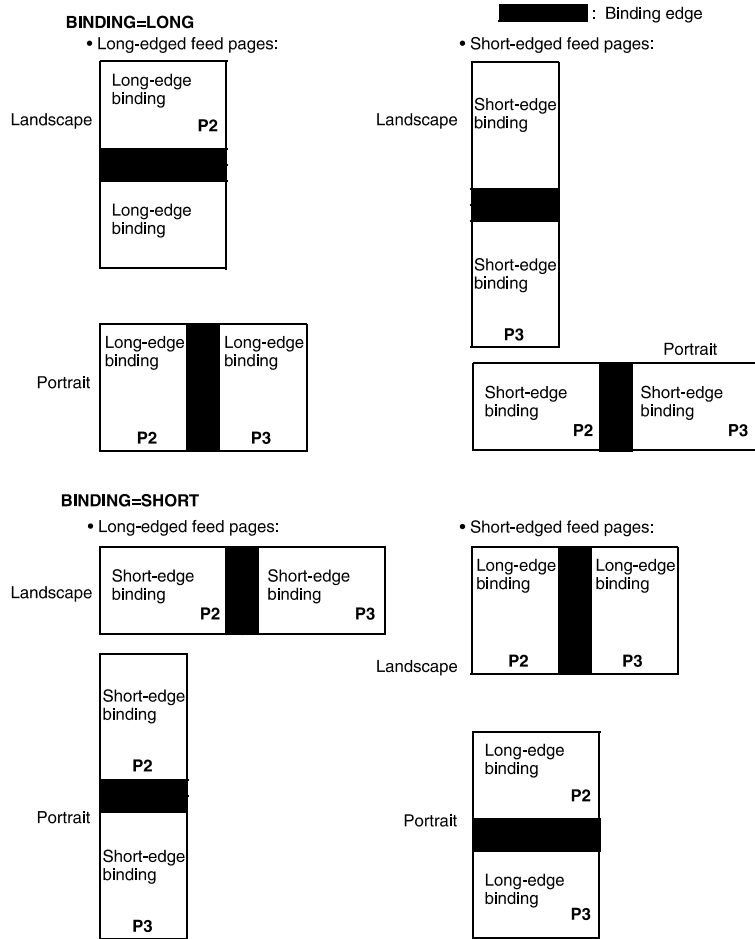

Figure 4-4. Diagrams of output resulting from different BINDING specifications

OUTPUT COLLATE

Specifies whether pages will be printed collated (in ordered sets) or uncollated.

Syntax OUTPUT COLLATE = {YES | NO}

Options

Table 4-45. OUTPUT COLLATE parameter options and definitions

Option	Definition
YES	Specifies that the output pages are collated.
NO	Specifies that the output is not collated.

Default YES

- OUTPUT COLLATE parameter: points to note**
- If NTO1=YES, PDL overrides COLLATE=NO with COLLATE=YES and notes this action with a warning in the JSL.
 - If you have specified multiple copies, you cannot change the value of the COLLATE parameter again within the report.

OUTPUT COPIES

Specifies the number of report copies to be printed.

Syntax OUTPUT COPIES = *number*

Options

Table 4-46. OUTPUT COPIES parameter options and definitions

Option	Definition
<i>number</i>	Specifies the number of copies to be printed. This is an integer value from 1 to 32,767.

Default 1

OUTPUT COVER

Specifies that cover sheets are to be fed from the AUX stock. These cover sheets may be placed at the front or back of each copy of a report.

Syntax OUTPUT COVER = {(FRONT [, SEP]) | BACK | (BOTH [, SEP]) | NONE}

Options

Table 4-47. OUTPUT COVER parameter options and definitions

Option	Definition
NONE	Specifies that no cover sheets are to be fed.
FRONT	Specifies that a cover sheet will be fed as the first page of each report copy.
SEP	Specifies that no data will be printed on any front cover sheet.
BACK	Specifies that a cover page will be fed at the end of each copy. No report data is printed on back covers.
BOTH	Specifies that both front and back cover pages will be fed for each report copy. The front cover sheet will be the first page of each copy.

Default NONE

OUTPUT COVER parameter: point to note If RTEXT is specified along with (FRONT, SEP) or (BOTH, SEP), RTEXT pages are printed on the covers, and front covers are picked only on copies for which there is RTEXT. Refer to the “ROUTE RTEXT” parameter section later in this chapter for further details on RTEXT.

Refer to “Restrictions on job parameter modification” in the “Using Dynamic Job Descriptor Entries (DJDEs)” chapter for more information on COVER specified in a selected JDE.

OUTPUT CYCLEFORMS

Specifies a set of forms to be printed on report pages in a repeating sequence.

Syntax OUTPUT CYCLEFORMS = {NONE | *formid* | (*formid*₁ [, (INKS, *inkref*₁ [*inkref*₂] [, ...])] [, *formid*₂ [, (INKS, *inkref*₁ [*inkref*₂] [, ...])])}

Options

Table 4-48. OUTPUT CYCLEFORMS parameter options and definitions

Option	Definition
NONE	Specifies that no form will be added to the associated report page of variable data.
<i>formid</i>	Specifies a 1 to 6 character form file name (may be numeric, alpha, or alphanumeric), which exists on the system disk.
INKS	Specifies that the inks that follow will be used for the forms.
<i>inkref</i>	Identifies the inks that override the corresponding inks that are specified in the ink list of the form. If a form does not contain an ink list, the form is printed in black.

Default NONE

**OUTPUT
CYCLEFORMS
parameter: points
to note**

- If multiple CYCLEFORMS are specified in the same OUTPUT command, a single list consisting of all these specified forms is created. The forms are listed in the order the names are encountered. The number of form identifiers is limited only by the number of forms retained on the disk.
- **CYCLEFORMS and FORMS:** Both may be used within a report; however, only the parameter that was specified most recently is in effect at any given time. If a multicopy report specifies CYCLEFORMS, a FORMS DJDE that is encountered in the report overrides the CYCLEFORMS parameter from that point in every copy.
- **For colored forms:** If an *inkref* that is on the ink list is omitted from the command, commas must be used to maintain the relative positioning of the remaining ink references.

If more than two *inkrefs* are specified, the system ignores the additional *inkrefs*.

**OUTPUT
CYCLEFORMS
parameter
example**

```
OUTPUT CYCLEFORMS=(form1, form2)
```

OUTPUT DENSITY

Specifies how the system will respond to a scan line density error.

This parameter is obsolete and is listed for compatibility purposes only. It is, however, recognized by the XJDC (PDL) compiler. You would use it if your JSL will be used for printing on a system that is running an early version of operating system software.

Syntax OUTPUT DENSITY = {FIX | NOFIX | DEFAULT}

Options

Table 4-49. OUTPUT DENSITY parameter options and definitions

Option	Definition
FIX	Enables local density function.
NOFIX	Disables local density function.
DEFAULT	Directs the output to respond to local density events according to the default for the printer type.

Default DEFAULT

OUTPUT DESTINATION

Specifies the destination for printed output.

Syntax OUTPUT DESTINATION = {BIN | TRAY | EXPORT}

Options

Table 4-50. OUTPUT DESTINATION parameter options and definitions

Option	Definition
BIN	Specifies that the currently selected bin is used.
TRAY	Sends output to the sample tray. Transparencies should always be sent to this tray. <i>NOTE: Use caution when selecting the TRAY option because of the limited capacity of the sample tray (100 sheets).</i>
EXPORT	Specifies that sheets be sent to the bypass transport to be fed into a finishing device. The EXPORT option takes effect only if: <ul style="list-style-type: none"> The user interface Output window has "System Specified" selected in the Output Location field, and The Finishing field displays the name of a finishing device.

Default BIN

OUTPUT DUPLEX

Specifies whether printing is to occur in duplex (print on both sides of a sheet) or simplex (print on a single side).

Syntax OUTPUT DUPLEX = {YES | NO}

Options

Table 4-51. OUTPUT DUPLEX parameter options and definitions

Option	Definition
YES	Specifies two sided (duplex) printing.
NO	Specifies single sided (simplex) printing.

Default NO

OUTPUT DUPLEX parameter: point to note

OUTPUT FACEUP

Specifies that printed pages are delivered face up to the output destination.

Syntax OUTPUT FACEUP = {YES | NO}

Options

Table 4-52. OUTPUT FACEUP parameter options and definitions

Option	Definition
YES	Specifies that the printed sheets are delivered to the stacker face up.
NO	Specifies that the printed sheets are delivered to the stacker face down.

Default NO

OUTPUT FACEUP parameter: point to note Specify FACEUP=YES when printing on label stock. Delivering label sheets face up prevents delamination when the sheets are stacked. Refer to the “OUTPUT NTO1” parameter section later in this chapter for related information.

OUTPUT FEED

Controls the initial stock on which pages are printed.

Syntax OUTPUT FEED = {OPR | MAIN | AUX | ‘stockname’ | stockreference}

Options

Table 4-53. OUTPUT FEED parameter options and definitions

Option	Definition
MAIN	Feeds from the tray for which the stock identified as MAIN was specified. (Provides compatibility with existing applications.)
AUX	Feeds from the tray for which the stock identified as AUX was specified. (Provides compatibility with existing applications.)
OPR	FEED =OPR is equivalent to FEED = MAIN. (Provides compatibility with existing applications.)
‘stockname’	Specifies the name of the stock from whose assigned tray or trays the next sheet will feed for printing. This name must be in single quotes.
stockreference	Specifies the descriptive term that has been associated with the name of the stock being used for the job.

Default OPR

OUTPUT FEED
parameter: points
to note

- “FEED = *stockreference*” must refer to a stock assigned to a stockname by the STOCKSET command that has been specified for the report.
- The MAIN stock is the default for system generated pages and is used if no SYSPAGE stock is specified.
- The FreeFlow Print Server LCDS software comes with MAIN, AUX, and AUTO stocks defined.
- If the OUTPUT FEED command and the RAUX command specify two different stock names, RAUX has higher priority.
- The ‘*stockname*’ option bypasses the stock reference feature, but it still requires that the stock name be specified in the current STOCKSET command. (FEED=*stockreference* is the recommended usage.)

OUTPUT FORMAT

Specifies a page descriptor entry (PDE) to be used in formatting the printed output, such as location of starting print line for each logical page on the physical page, font usage, and orientation.

Syntax OUTPUT FORMAT = *pdeid*

NOTE: To ensure readability, enter the entire parameter FORMAT. Do not abbreviate to “FOR.”

Options

Table 4-54. OUTPUT FORMAT parameter options and definitions

Option	Definition
<i>pdeid</i>	<i>page descriptor entry identifier</i> References a page descriptor entry that was either defined previously in the JDL or catalogued as a separate file in the “lcds” resources folder on disk. Refer to “Coding a JSL” in the “PDL principles and procedures” chapter for information on creating and compiling PDE files using the XJDC processor.

Default FMT1

OUTPUT FORMAT
parameter: point
to note

Standard *pdeids*, such as FMT1 and FMT2, are defined in the “PDE command” section, later in this chapter. These standard PDEs are delivered with the printing system software and may be used unless a specialized PDE is required. The choice of active PDE may subsequently be replaced entirely or modified in part through DJDEs.

OUTPUT FORMS

Specifies forms to be associated with the report copies. Different forms may be associated with different copies of a report by the use of multiple FORMS left parts in the same OUTPUT command.

Syntax OUTPUT FORMS = {NONE | *formid* | (*formid* [, *init* [, *copies*]]) [, (INKS, *inkref*₁ [, *inkref*₂] ...)]}

NOTE: To ensure readability, enter the entire FORMS parameter. Do not abbreviate to "FOR," because the system interprets "FOR" as FORMAT.

Options

Table 4-55. OUTPUT FORMS parameter options and definitions

Option	Definition
<i>formid</i>	Specifies a 1 to 6 character form file name (may be numeric, alpha, or alphanumeric) that already exists on the system disk. Forms can be coded at a workstation with forms creation software such as Elixir, or on another LPS using Xerox Forms Description Language (FDL), and transferred to the print server disk by importing it via diskette, tape, or CD. Refer to "Importing LCDS resources" in the "PDL principles and procedures" chapter for the procedure.
<i>init</i>	Specifies the first copy number to which the specified form applies. This defaults to the first or next copy. If neither <i>init</i> nor <i>copies</i> is specified, the form applies to all copies of all data pages of the report.
<i>copies</i>	Specifies the number of copies to which the form applies. If the <i>copies</i> option is not specified, the last (or only) specified form applies to all copies beginning with the <i>init</i> copy number. If the form is not the last one specified, <i>copies</i> defaults to 1.
NONE	Means that no form is added to the associated report page of variable data.
<i>inkref</i>	<i>Ink reference.</i> Identifies the inks that override the corresponding inks that are specified in the ink list of the form. If a form does not contain an ink list, the form is printed in black.

Default No default

**OUTPUT FORMS
parameter: points
to note**

- **CYCLEFORMS and FORMS parameters:** Both may be used within a report; however, only the last parameter specified is in effect at any given time. If a multicopy report specifies CYCLEFORMS, a FORMS DJDE that is encountered within the report overrides the CYCLEFORMS parameter from that point in every copy.
- You can code forms at a workstation with forms creation software such as Elixir, on another laser printing system using Xerox Forms Description Language (FDL), or on a mainframe computer.

You can transfer these form files from tape, CD, or diskette to the print server disk by using the Import process. (For further information, click the online [Help] button on your system print server and refer to “Importing resources.”) You can also download forms from a host computer by using File Transfer Protocol (FTP) or the FILE DJDE.

**OUTPUT FORMS
parameter
example**

The example below shows how to specify forms on different copies. Form FORM12 appears on copies 1 and 2. FORM3 will print on copy 3, and FORM4, on copies 4 through 10.

```
OUTPUT FORMS = (FORM12,1,2), FORMS = FORM3,
FORMS = FORM4, COPIES = 10;
```

OUTPUT GRAPHICS

Specifies how graphics will be processed in a job.

Syntax OUTPUT GRAPHICS = {NO | YES | MOVE | BATCH | ({NO | YES | MOVE}, NOSUB)}

Options**Table 4-56. OUTPUT GRAPHICS parameter options and definitions**

Option	Definition
NO	Indicates that there are no graphics in this job.
YES	Indicates there are graphics in the job, and they are processed in Batch mode.
BATCH	Means that the input stream contains no text, but only graphics that are to be imaged, one per page.

Table 4-56. OUTPUT GRAPHICS parameter options and definitions (Continued)

Option	Definition
Unused options: The following options are ignored by the FreeFlow Print Server LCDS systems. They are included here for compatibility.	
MOVE	Specifies that all referenced graphic disk files will be copied into the print file. (On the FreeFlow Print Server LCDS systems, YES is used instead.)
NOSUB	If a graphic is missing, specifies that no substitution for the missing graphic image is desired. (This option is ignored by the FreeFlow Print Server LCDS systems.)

Default NO

OUTPUT GRAPHICS parameter: points to note

- If you are using the IMAGE parameter in conjunction with GRAPHICS, make sure to list the GRAPHICS parameter first, as these two parameters are order dependent.
- In Batch mode, only one graphic is imaged per page.
- After a graphic has been processed as part of the job, if a switch to a JDE with GRAPHICS = NO occurs, the GRAPHICS = NO specification is ignored.

OUTPUT GRAPHICS parameter examples

```
OUTPUT GRAPHICS=BATCH, RESOLUTION=300;
```

```
OUTPUT GRAPHICS=MOVE, RESOLUTION=300,
PURGE=NO;
```

OUTPUT IDFAULT

Specifies the default ink that will be used for objects whose ink is not specified. This parameter remains in effect until another IDFAULT parameter is specified.

Syntax OUTPUT IDFAULT = *'inkref'*

Options

Table 4-57. OUTPUT IDFAULT parameter options and definitions

Option	Definition
<i>'inkref'</i>	<i>ink reference</i> The default ink that will be used for all subsequent parameters that do not specify a colored ink.

Default The first ink that is referenced in the IDR ILIST parameter in effect at the start of the page. If no IDR is specified, the default ink is BLACK.

OUTPUT IDFAULT parameter example OUTPUT IDFAULT='RED'

OUTPUT IDR

Specifies the ink descriptor that will be used for the job. Refer to the "IDR command" section earlier in this chapter for information on what is defined in an IDR.

Syntax OUTPUT IDR = *idrname*

Options

Table 4-58. OUTPUT IDR parameter options and definitions

Option	Definition
<i>idrname</i>	<i>ink descriptor reference name</i> The name of the IDR (previously defined by an IDR command in the JSL) that will be used for the job.

Default DFIDR.IDR

OUTPUT IDR parameter example OUTPUT IDR=IDR1

OUTPUT IMAGE

This parameter is for Batch mode processing only, and specifies the initial graphic imaging parameters to be used.

Syntax OUTPUT IMAGE = (*vpos* [*units*], *hpos* [*units*] [, *n* [/*d*]]
[, (INKS, *inkref*₁ [, *inkref*₂]))

Options

Table 4-59. OUTPUT IMAGE parameter options and definitions

Option	Definition
<i>vpos</i>	<i>vertical position.</i> Specifies the vertical position of the top edge of the graphic, as a downward offset, relative to 0,0 on the current physical page (the position that would be specified by a PDE BEGIN of 0,0). This parameter is specified as a decimal number with up to three digits to the right of the decimal point and may be followed by a space and the <i>units</i> indicator.
<i>hpos</i>	<i>horizontal position.</i> Specifies the horizontal position of the left edge of the graphic, as a rightward offset, relative to 0,0 on the current physical page. The form of the specification is the same as for <i>vpos</i> .
<i>units</i>	Specifies the unit of measure for the vertical and horizontal positions of the image on the page. <ul style="list-style-type: none"> • DOTS • CM (centimeters) • IN (inches) • UN (user defined unit). The default <i>unit</i> is IN.
<i>n / d</i>	<i>numerator / denominator.</i> Specifies the reference scale factor. Each parameter, <i>n</i> and <i>d</i> , must be an integer in the range of 1 to 8, thereby allowing a reference scale factor in the range of 1/8 to 8. The reference scale factor is multiplied by the scale factor specified at the time the graphic was digitized and the product is rounded to the nearest integer in the range 1 to 8. That integer becomes the effective scale factor with which each pixel of the graphic is imaged. If <i>n</i> is specified but not <i>d</i> , <i>d</i> is assumed to be 1.
INKS	Specifies that the ink references that follow will override the inks that were defined in the image file.
<i>inkref</i>	<i>ink reference</i> Specifies the inks that override the corresponding inks specified in the ink list of the image file.

Default Top left corner of the portrait or landscape oriented page, scaled at 1/1

OUTPUT IMAGE parameter: points to note

- To put an image on a page, use a form with the image, or use the IMAGE DJDE.
- If the UN option is used to define positioning, the UNITS parameter must precede this command.
- The IMAGE parameter must follow the GRAPHICS=BATCH parameter, as these two parameters are order dependent.
- If two IMAGE parameters are listed consecutively in a JDL, the system processes only the second one.
- Existing .IMG files are printed in the system default black ink unless ink references are specified in the INK parameter.
- If ink references are used:
 - If one *inkref* in the list is omitted, commas must be used as place holders to maintain the relative positioning of the remaining ink references.
 - If more than two ink references are specified, the additional ink references are ignored.

OUTPUT IMAGE parameter example

Following is an example of the OUTPUT GRAPHIC parameter.
`OUTPUT GRAPHIC=BATCH, IMAGE=(1 IN,2 CM);`

OUTPUT INVERT

Specifies that the content of a page will be inverted 180 degrees when it is printed on the physical page, head to head or head to toe. Inversion is also used for page orientation for finishing functions.

Syntax OUTPUT INVERT = {FRONT | BACK | BOTH | NONE}

Options

Table 4-60. OUTPUT INVERT parameter options and definitions

Option	Definition
FRONT	Specifies page inversion on front sides.
BACK	Specifies page inversion on back sides.

Table 4-60. OUTPUT INVERT parameter options and definitions (Continued)

Option	Definition
BOTH	Specifies page inversion on front and back sides.
NONE	Turns page inversion off.

Default NONE

OUTPUT IRESULT

Specifies what the result will be when objects that are imaged with different inks overlap.

Syntax OUTPUT IRESULT = {BLACK | COLOR}

Options

Table 4-61. OUTPUT IRESULT parameter options and definitions

Option	Definition
BLACK	Specifies that, when two objects that are imaged with different inks overlap, and black and colored pixels coincide, the resulting pixel is black.
COLOR	Specifies that, when two objects that are imaged with different inks overlap, and black and colored pixels coincide, the resulting pixel is colored.

Default The ink priority that was chosen at installation.

OUTPUT IRESULT parameter: points to note

- For monochrome printers such as the DP EPS, the COLOR and BLACK parameters produce identical results (black).
- The FreeFlow Print Server-based DT 128/155/180 HLC Printing Systems have queue settings for this option. The default setting is black.
- The color that results from overlapping objects may be only black or a color for an entire page. For example, a page cannot have red text printed over a black background and also black text printed over a red background.
- The IRESULT can be specified on a page basis with the IRESULT DJDE. If more than one IRESULT is specified on a page, the last instance takes precedence.

OUTPUT LOGO

Allows you to specify a logo for imaging on all pages of a report, unless it is canceled by a CANCEL DJDE. Up to 128 logos can be specified on a page.

Syntax OUTPUT LOGO = (*name*, *vpos units*, *hpos units* [, INKS, *inkindex*₁ [, *inkindex*₂]])

Options

Table 4-62. OUTPUT LOGO parameter options and definitions

Option	Definition
<i>name</i>	Name of the logo file
<i>vpos</i>	<i>vertical position</i> A value constant that specifies as an offset the vertical position of the top edge of the logo relative to the 0,0 position on the current physical page (the position that would be specified by a PDE BEGIN parameter value of 0,0).
<i>hpos</i>	<i>horizontal position</i> A value constant that specifies as an offset the horizontal position of the left edge of the logo relative to the 0,0 position on the current physical page.
<i>units</i>	The unit of measurement for the vertical and horizontal positions offset value. Options are: <ul style="list-style-type: none"> • DOTS • XDOTS (600 dpi dots) • CM (centimeters) • IN (inches) The default unit is IN.
INKS	Indicates that the ink that follows will override the inks that are defined in the logo.
<i>inkindex</i>	Overrides the corresponding inks that are specified in the ink list of the logo. <i>NOTE: For this option to be valid, the logo that is referenced must be in color format.</i>

Default No default

OUTPUT LOGO
parameter: **points**
to note

- The number of logos that are allowed on a page varies depending on the structure of the logo and the amount of available dynamic memory space. If there is not enough dynamic memory available for the number of logos specified for a given page, an error message is generated.
- Existing .LGO (logo) files and restricted RES format .LGO files are printed in black by highlight color printers unless *inkrefs* are specified in the INKS parameter.

If an *inkref* in the list is omitted, you must use commas to maintain the relative positioning of the remaining ink references. If more than two *inkrefs* are specified, the additional *inkrefs* are ignored.
- If any of the inks that will be substituted were specified in the logo definition with a NOSUBSTITUTION parameter, the system processes the ink requests according to what was specified in the ABNORMAL ISUBSTITUTE parameter.

OUTPUT MODIFY

Specifies CMEs that will be associated with report copies.

Syntax OUTPUT MODIFY = {(*cmeid* [, *init* [, *copies*]]) | NONE}

Options

Table 4-63. OUTPUT MODIFY parameter options and definitions

Option	Definition
<i>cmeid</i>	<i>copy modification entry identifier.</i> The identifier or file name of a CME.
<i>init</i>	<i>initial copy</i> Specifies the initial copy to which the associated CME is to be applied. If no initial copy is specified, the CME applies to all copies.
<i>copies</i>	Specifies the number of plies (passes) on which apply the CME will be applied. If <i>copies</i> is not specified, the CME applies to all copies beginning with the copy number specified by <i>init</i> .
NONE	Specifies that data are processed without modification.

Default NONE

**OUTPUT MODIFY
parameter: points
to note**

- A CME may be coded within a JSL or coded and catalogued separately for use by several JSLs. Any CME invoked by a DJDE must be catalogued separately. Refer to the “CME command” section earlier in this chapter for further information.
- If the CME is within the JSL, it must precede a reference to its identifier by the MODIFY parameter.
- Different CMEs may be associated with different copies of a report by the use of multiple MODIFY parameters on the same OUTPUT command. CME copy ranges may not overlap.
- If different CMEs are associated with different copies of a report, or if a CME is applied to some but not all copies of a report, then the CMEs are termed copy sensitive. Copy sensitive CMEs may not be used if COLLATE=NO, or online processing is specified. Refer to the MODIFY DJDE section in the “Using Dynamic Job Descriptor Entries (DJDEs)” chapter for a discussion of how CMEs may be changed on a page by page basis within a report ply.

OUTPUT NTO1

Specifies, on a report basis, whether all copies of a particular report are printed last page to first (*n* to 1).

Syntax OUTPUT NTO1 = {NO | YES | *n*}

Options**Table 4-64. OUTPUT NTO1 parameter options and definitions**

Option	Definition
YES	Specifies last to first page printing. To print <i>n</i> to 1, output processing must print the report starting with the last page. Therefore, output processing cannot begin until input processing has finished with the entire report. It is possible that input processing does not recognize the end of a report until it detects the start of the next report (header banner page). When YES is specified, the system assumes a 50 sheet threshold for the maximum report size to be printed N to 1.
NO	Specifies first page to last (1 to <i>n</i>) printing.

Table 4-64. OUTPUT NTO1 parameter options and definitions

Option	Definition
<i>n</i>	<p>number. The NTO1 threshold, which specifies the maximum number of pages a report may have in order for it to be printed <i>n</i> to 1. If the threshold count is exceeded before the end of the report, the system prints the entire report 1 to <i>n</i>. The default value of <i>n</i> is 50 physical sheets, but <i>n</i> may range from 1 to 32767. When a value is greater than 100, the system generates a warning message.</p>

Default NO

OUTPUT NTO1 parameter: points to note

The NTO1 parameter interacts with some of the other OUTPUT command parameters. These interactions can cause some of the specifications in the JSL to be overridden. In other cases, you must follow special procedures when specifying the interacting parameters in your JSL, in order to produce the results you want.

- *N* to 1 printing takes longer to process than 1 to *n* printing because the system must process the entire report before beginning to print the job.
- **NTO1 and COLLATE:** When NTO1=YES, PDL overrides COLLATE=NO with COLLATE=YES, and notes this action with a warning in the JSL listing.
- **NTO1 and FACEUP:** NTO1=YES causes FACEUP=YES to be specified.
- **NTO1 and 1TON:** The system assumes each report is NTO1 until the first data page, even if 1TON is specified in the JDE or JDL. This arrangement allows you to use JDEs and JDLs that are selected by DJDEs and invoke NTO1 after a series of banner pages.

The following examples illustrate these conditions:

Example 1:

OUTPUT NTO1= NO is specified.

The job prints 1TON unless a JDE or JDL DJDE specifying NTO1 is invoked in the first data record after banner pages.

Example 2:

OUTPUT NTO1= YES is specified, and a JDE or JDL DJDE specifying NTO1= NO is invoked.

The DJDE is processed and the job prints 1TON if the system encounters it in the first data record after banner pages.

- NTO1 and OSTK:** When printing ordered stock in NTO1 sequence using the OSTK parameter, note the following:
 The ordered stock must be **reverse collated** in the feeder so that the first sheet of the set is on the bottom, the second sheet next to the bottom, and so on, with the last sheet of the set on top to be fed first. If the report is larger than the N to 1 threshold, it prints in 1 to N order, and the reverse collated stock is then inappropriate.
 When this occurs, the system displays a message stating that page ordering has been reversed, and cycles down.
- NTO1= NO, FACEUP= NO, and DUPLEX= NO:** In this sequence, the NTO1 and FACEUP parameters specify the NO option so other potentially affected parameters, such as DUPLEX, are not overridden. The DUPLEX parameter, therefore, maintains either the YES or NO option.
 If hierarchical overrides occur, the system issues warning messages in the xjdc listing when the JSL is compiled, then forces parameters that are lower in the hierarchical structure to their workable values.

OUTPUT NUMBER

Invokes page numbering on the printed report, and specifies starting number and location of the numbers on the page.

Syntax OUTPUT NUMBER = {(*pnum*, *lnum*, *cnum* [, [*findex*] [, *inkref*]]) | NO}

Options

Table 4-65. OUTPUT NUMBER parameter options and definitions

Option	Definition
<i>pnum</i>	<i>page number</i> An integer specifying the number with which page numbering starts. The beginning page number may be nonpositive. The number is incremented at page transitions but is not printed until it becomes positive. The maximum page number that can be printed is 2,147,483,647.
<i>lnum</i>	<i>line number.</i> An integer specifying the number of the line on which the page number is placed.
<i>cnum</i>	<i>column number.</i> An integer specifying the ending column number for the page numbering sequence.

Table 4-65. OUTPUT NUMBER parameter options and definitions (Continued)

Option	Definition
<i>findex</i>	<i>font index.</i> An index into the list of fonts specified in the currently active FONTS parameter of the PDE command, or of a recent DJDE. The index is an integer, starting with 1 for the first font. If a font index is not specified, the first font in the list is used.

Table 4-65. OUTPUT NUMBER parameter options and definitions (Continued)

Option	Definition
<i>inkref</i>	ink reference. Specifies the reference number for the ink with which the page number will be printed.
NO	Specifies that no page numbering is to be performed.

Default NO

**OUTPUT NUMBER
parameter: points
to note**

- The page number character string is placed on the page at the specified line number, based on the line spacing of the specified font. If override line spacing is specified for the font, it does not affect where the page number character string is to be printed.
- If both BFORM and NUMBER are specified, BFORM pages are numbered.

**OUTPUT NUMBER
parameter
example**

`OUTPUT NUMBER=(1, 1, 40, 1);`

OUTPUT OFFSET

Specifies offsetting of output in the stacker on a report basis.

Syntax OUTPUT OFFSET = {ALL | FIRST | NONE}

Options

Table 4-66. OUTPUT OFFSET parameter options and definitions

Option	Definition
ALL	Results in an offset of each copy of each report.
FIRST	Specifies that an offset is to occur only on the first copy of a report.
NONE	Specifies that there will be no offsetting at any time.

Default ALL

OUTPUT OFFSET The OFFSET control of FIRST, ALL, or NONE may be modified by the ROFFSET command. Refer to the “ROFFSET” command section in the “Using logical processing” chapter.

parameter: point to note

If OUTPUT OFFSET=FIRST (or ALL) was specified, and the ROFFSET criteria is satisfied on the first page of a report, the normal offset from the preceding report occurs.

OUTPUT OSTK

Specifies that ordered stocks are used for printing the job.

Syntax OUTPUT OSTK = {*ostkspec* | (*ostkspec*, *ostkspec*, ...)}

where *ostkspec* is:

(*stockdef*, [*mod*], [*pos*], [{RES | NORES}], [TABS], [*size* {DOTS | IN | CM}]) [, {L | P}]

Options

Table 4-67. OUTPUT OSTK parameter options and definitions

Option	Definition
<i>stockdef</i>	<i>stock definition</i> The identifier or name of the ordered stock to be used, and for which feeder trays have been identified on the user interface Stock List. No default.
<i>mod</i>	<i>modulus</i> The number of sheets in the ordered stock. For example, 5 cut tabs would have a <i>mod</i> value of 5. The range of values is from 1 to 255. The default modulus definition is 1.
<i>pos</i>	<i>position.</i> The initial position relative to the <i>mod</i> value. The range of values is between 1 and <i>mod</i> . The default position is 1.
RES NORES	RESET or NO RESET. Indicates whether the <i>pos</i> value should be reset at the start of the next report. The default is RES.
TABS	Indicates a tab stock is being used. The default is no tabs (no option entered).
<i>size</i>	Width of the tab. The value can be specified in DOTS, IN, or CM. This parameter applies only when tabs are specified. The default is 0.5 in.

Table 4-67. OUTPUT OSTK parameter options and definitions (Continued)

Option	Definition
L or P	Landscape or Portrait. Indicates at which edge of the paper the tab is located. If L, it is located at the right edge of the landscape oriented page. If it is P, it is located at the right edge of the portrait oriented page. The default is P.

- Defaults**
- *mod* and *pos*: 1
 - RES
 - no tabs
 - *size*: 0.5 IN
 - P

**OUTPUT OSTK
parameter: points
to note**

When using tabs and ordered stock:

- All applications that are printed on a tab have pages formatted for tab printing. If there is a PDE switch in the job stream that causes the BEGIN value to be shifted off the page, such as BEGIN = (.18, 8.6), the stock criteria must already be met before the new BEGIN is processed. This sequence allows the input task to ignore the BEGIN value when checking for tab stocks.
- The XJDC compiler ensures the minimum value for *mod* is 1 and the maximum is 255 (decimal). It also ensures the value of *pos* is greater than or equal to 1 and less than or equal to *mod*.
- **Printing on tabs:** Following are some considerations for printing on tabs.
 - Use the OSTK option before trying to run a tab job.
 - The printer prints on tabs in both simplex and duplex modes.
 - **Imaging area:** When the printer is printing on 9 inch (229 mm) stock or 8.5 inch (216 mm) stock with half inch (13 mm) tabs, the full imaging area of 9 inches (229 mm) is enabled. It is limited, however, by the amount of image shift that is enabled.

- **Tab widths:** When running a tab stock job, you must not include the width of the tab when specifying the PAPER SIZE command. However, you must include the width of the tab when specifying the stock size on the print server user interface windows or on the printer control console.
- **Switching to tab stock during a job:** The *stockname* form of a stock specification must be used in the following instances: a FEED= DJDE; RAUX, RFEED, or COVER commands; or a selection from the user interface stock windows.
- **Recognizing tab stock:** The system processes tabs by referring to the current *stockname* at the time that the page is formatted for output.

Example: If the page satisfies the RAUX criteria and AUX is specified as a *stockname* in the ordered stock statement, the system recognizes this as a tab stock. Having recognized it, the system then adds *n* scan lines (width of the tab) to the paper size in the slow scan direction for portrait tabs, or in the fast scan direction for landscape tabs.

- **Orientation:** The P and L (portrait and landscape) parameters of the OSTK statement allow you to specify either orientation. The only one that is supported by the FreeFlow Print Server LCDS systems is portrait (P) is the default condition. If you select landscape (L) and you load the tab stock with the tab at the right edge of a landscape oriented page, this combination does not run due to jams induced by skew.

Example: Job 1 starts with Tab 1 (located in the upper right corner of a portrait page), and Job 2 must start with Tab 5 (located in the lower right corner of the portrait page). The number of tabs Job 1 will use is 2.

In order to run the job in succession, you must code the JSL with MOD=5 and POS=1 for Job 1 and MOD=5 and POS=5 for Job 2. The system does keep track of the last tab position in tray 2 at the end of Job 1. Upon starting Job 2, the printer purges Tab 3 and Tab 4 because Job 2 starts with POS=5 and Job1 used Tab 1 and Tab 2.

- At the time the system makes validity checks for BEGIN values and graphic positioning, the system cannot determine if the current physical page is tab stock.

However, if the OSTK command is specified, the system allows a tolerance of n inches (where n is the width of the tab specified in the OSTK command) when validity checks are being performed on BEGIN values and graphic positioning. In addition, the FEED=*tab stock* DJDE must precede any printable text data that is placed on the tab.

- When running tab stock jobs, dedicate one tray for tab stock.
- Avoid using tab stock with two-sided printing. When you are feeding stock that contains tabs, turn off duplex printing.
- When feeding from tab stock, be sure to convert the DJDEs back to the following specifications after printing the tabs, by using the following parameters:

```
OUTPUT  FEED=regular stock, DUPLEX=NO
        (or DUPLEX=YES)
```

- **Specifying a tab as a form:** To define a form that is to be used as a tab in a form callout, it is recommended that you code your applications with the following specifications:
 - The JSL must specify PAPERSIZE=USLETTER (or 8.5,11 or A4).
 - Your form must specify that the paper size is 9 by 11 inches or 8.5 by 11 inches, or A4 with 1/2 inch / 13 mm tab.
 - One tray must be dedicated for tabs. The JSL must specify which stock name/reference contains the tab stock.
 - JDE and JDL DJDEs must be coded to define the following for the tab stock:

```
PAPERSIZE = (9, 11) or 8.5 by 11 or A4 with 1/2 inch (13 mm) tab
FEED=tab stock
DUPLEX=YES or DUPLEX=NO
FORM=form name
```
 - Corresponding JDE and JDL DJDEs must be coded to switch back to printing regular paper stock. Note that the ordered stock statement specified in the original JDE and JDL DJDEs and the regular stock JDE and JDL DJDEs must be exactly alike.

- Specify TABS in the ordered stock statement so that dynamic width checking is disabled.
- You may define the ordered stock statement at the job or the system level of a JSL. If you define it at the job level, you must ensure that the ordered stock command defined from the initial JDE and JDL to a selected JDE and JDL are exactly alike. The reason is that the system contains an internal *mod* and *pos* table that keeps track of the current *mod* and *pos* values for the job, and is used for jam recovery. This table is initialized at report setup time through values that were entered in the Properties window for each tray (accessed from the Printer Manager window).

When a JDE or JDL DJDE with an ordered stock command is specified, the system reinitializes its internal *mod* and *pos* table with values in the DJDE JDE or JDL, if it finds that the ordered stock information in LCDS Setup window is different from the values defined in the DJDE JDE or JDL.

However, if both commands are alike, the system does not reinitialize the internal *mod* and *pos* table. If you check for initialization of the internal *mod* and *pos* table, the tab stocks start purging before every tab is imaged (because *mod* and *pos* are always initialized for every tab page).

- **Purging tab stock:** The printer can purge tab sheets whenever the tab cycle is not in sync with the formatted data. This may be caused by paper jams with multiple jobs running in succession.

Example: Here is an example of a typical application scenario:

- Tray two contains the tab stock which has MOD=5.
- Two tab stock jobs to run in succession. Both jobs require tray 1.
- Job 1 starts with Tab 1 (located in the upper right corner of a portrait page) and Job 2 must start with Tab 5 (located in the lowest right corner of the portrait page.)
- The number of tabs Job1 will use is 2.

What to do:

In order to run the job in succession, you must code the JSL with MOD=5 and POS=1 for Job 1 and MOD=5 and POS=5 for Job 2. The system keeps track of the last tab position in tray 2 at the end of Job 1. Upon starting Job 2, printer purges Tab 3 and Tab 4 because Job 2 starts with POS=5 and Job 1 used Tab 1 and Tab 2.

- You can improve performance by ordering application dependent tab stock. Using ordered tab stock that supports only the number of tabs required for a specific job eliminates the need for purging unused tabs.

OUTPUT PAPERSIZE

Specifies the size of paper that will be used for printing the job.

Syntax OUTPUT PAPERSIZE = {A3 | A4 | B4 | B5 | USLEGAL | USLETTER | (x, y)}

Options

Table 4-68. OUTPUT PAPERSIZE parameter options and definitions

Option	Definition
A3	16.54 by 11.69 inches / 297 by 420 mm
A4	8.27 by 11.69 inches / 287 by 270 mm
B4	10.12 by 14.33 inches / 257 by 364 mm
B5	7.17 by 10.12 inches / 178 by 254 mm (with the 7 by 10 inch enablement kit)
USLEGAL	8.5 by 14 inches / 216 by 356 mm
USLETTER	8.5 by 11 inches / 216 by 279 mm
(x, y)	A user defined paper size; that is, a size that is not one of the standard sizes. The x and y variables define the width and length of the nonstandard stock; e.g., 7,10 for 7 by 10 inches.

Default System default size that was specified at installation

**OUTPUT
PAPERSIZE
parameter: points
to note**

- When centimeters (CM) are used to specify paper size, the maximum allowable value is 32,767 cm.
- Paper size cannot be changed by a DJDE on a page basis. However, paper sizes can be changed on a report basis.

- PAPERSIZE=B4 and PAPERSIZE=(10.12,14.33) produce identical results because they indicate long edge feed, as opposed to short edge feed format. Refer to the “SEFFNT command” section in the “Specifying input parameters” chapter for detailed information on short and long edge feed.
- To print on B5 and 7 by 10 inch paper sizes, the printer requires the 7 by 10 inch enablement kit (a hardware option) to be installed.
- There are performance considerations when you are switching paper sizes across pitch modes.
- The PAPERSIZE parameter is not supported as a DJDE. Therefore, a JDE page oriented DJDE that calls out the desired paper size is needed.
- If the JSL specifies the paper size using the keyword method (such as USLEGAL, A4, or B4), the form coding must use the same terminology. If the JSL specifies 8.5,14 and your form specifies USLEGAL, an error message is displayed, indicating that the form paper size is too small or too large. USLETTER and B4 are the only sizes for which the keyword and the x, y expression do not create any incompatibilities.

OUTPUT PAPERSIZE parameter example

```
OUTPUT  PAPERSIZE=USLETTER, FEED=MAIN,  
        DUPLEX=NO,  NUMBER=(1,1,80),  
        FORMAT=SMPPOE;
```

OUTPUT PURGE

Specifies whether or not the system should delete graphic disk files at the end of report. This is applicable only to documents with interleaved graphics.

Syntax OUTPUT PURGE = {NO | YES}

Options

Table 4-69. OUTPUT PURGE parameter options and definitions

Option	Definition
NO	Specifies that graphic disk files should not be deleted.
YES	Specifies that all .IMG graphics files that were created or replaced by document interleaved graphic processing for this report should be deleted at the end of the report printing.

Default YES

OUTPUT PURGE parameter: point to note You can use the SAVE DJDE to override the purging of specific files.

OUTPUT SF1FUNCTION

Specifies to the third party finisher whether or not it should perform the user-defined SF1 operation on the current report.

This parameter provides control over third party finishing devices that conform to the DFA standard. You use it to invoke Finishing Function SF1 through the DFA channel C6. The user must specify what function SF1 will have. Refer to your finishing equipment vendor documentation for information on what function should be specified for your finisher.

Syntax OUTPUT SF1FUNCTION = {NO | YES}

Options

Table 4-70. OUTPUT SF1FUNCTION parameter options and definitions

Option	Definition
YES	Instructs the finisher to initiate the user-defined SF1 finishing function on the current sheet.
NO	Specifies that Finishing Function SF1 will not be implemented on the current sheet.

Default NO

OUTPUT SF2FUNCTION

Specifies to the third party finisher whether or not it should perform the user-defined SF2 operation on the current report.

This parameter provides control over third party finishing devices that conform to the DFA standard. You use it to invoke Finishing Function SF2 through the DFA channel C7. The user must specify what function SF2 will have. Refer to your finishing equipment vendor documentation for information on what function should be specified for your finisher.

Syntax OUTPUT SF2FUNCTION = {NO | YES}

Options

Table 4-71. OUTPUT SF2FUNCTION parameter options and definitions

Option	Definition
YES	Instructs the finisher to initiate the user-defined SF2 Finishing Function on the current sheet.
NO	Specifies that Finishing Function SF2 will not be implemented on the current sheet.

Default NO

OUTPUT SHIFT

Shifts the image of the data for three-hole paper, binding, finishing, and edgemarking. Specifies that the entire content of the page will be shifted, and the amount and direction of the shift.

Image shift is the shifting of the image data (system page) relative to the physical page. This shifting is vertical for landscape pages and horizontal for portrait.

Syntax OUTPUT SHIFT = {YES | NO | (v₁, v₂)}

Options

Table 4-72. OUTPUT SHIFT parameter options and definitions

Option	Definition
v_1	<i>value 1.</i> An integer value in dots for the amount of shift on the simplex page or the odd (front) side of the duplex page. (Each dot is 1/300 of an inch.) The range for v_1 is -75 to 75.
v_2	<i>value 2.</i> A value in dots for the amount of shift on the even (back) side of a duplex page. The range for v_2 is -75 to 75.
YES	Specifies that a shift occurs. A standard size shift occurs if YES is specified ($v_1=75$ and $v_2=-75$).
NO	Specifies that no shift occurs ($v_1=0$ and $v_2=0$).

Default NO

**OUTPUT SHIFT
parameter: points
to note**

- If the origin of a print line is off the page, the printer prints as much of the line as possible and provides a message, once per report, indicating that printing is off the page.
- Graphics and logos are not allowed to start off the page. If they are positioned at a point that is outside the page boundary, an error message is displayed.

OUTPUT SIZING

Specifies how the system matches the paper sizes in the output bins and how it responds to paper and bin size mismatches.

When a stock has more than one tray assignment, and these trays contain different size paper, the system tries to match the paper sizes in the trays. You can specify one of the following options based on whether or not the printer will be attended by an operator during printing.

Syntax OUTPUT SIZING = {SEMIAUTO | STOP | BEST | EXACT}

Options

Table 4-73. OUTPUT SIZING parameter options and definitions

Option	Definition
SEMIAUTO	<p>(Standard mode of operation.) Causes the printer to stop printing when there is a paper size mismatch.</p> <p>For the printer to resume printing, the operator must do one of the following:</p> <ul style="list-style-type: none"> • Resume printing to print the job on the next larger size paper. • Change the paper or the effective stock. • Cancel the job. <p>If Continue is selected, the system ignores further mismatches of this type until one of the following occurs:</p> <ul style="list-style-type: none"> • The STOCKS parameter changes. • The end of the report is detected, and no STOCKS parameter is in effect. • The end of the print job is reached. • The printer stops printing.
STOP	<p>Causes the printer to cycle down if the exact paper size is not available. To resume operation, the operator must do one of the following:</p> <ul style="list-style-type: none"> • Load the proper size paper and resume printing. • Cancel the report.
BEST	<p>On the FreeFlow Print Server LCDS systems, this parameter functions the same as SEMIAUTO.</p>
EXACT	<p>On the FreeFlow Print Server LCDS systems, this parameter functions the same as STOP.</p>

Default SEMIAUTO

**OUTPUT SIZING
parameter: points
to note**

- A paper size is considered equal in size to another paper size if neither dimension differs by more than 15/600 of an inch.
- Use this command to print on paper larger than the specified paper size. Data may be lost if the paper size is smaller than the image size.
- Note that A4 paper is treated as smaller than 8.5 by 11 inch paper because it is narrower.
- Regardless of the parameter selected, if an exact match in paper size is found, the matching tray is used. The parameters differ only when no match is found.

- If the stock is not an exact paper size match, but is larger than the specified size, selecting SEMIAUTO (or BEST) causes the printer to stop and wait for operator confirmation to continue printing, using the larger paper. Further mismatches of this type are ignored until:
 - The STOCKS parameter changes
 - End Of Report and no STOCKS parameter is in effect
 - End Of Job
 - The printer stops printing. The operator must either select Continue to confirm the larger paper or change the paper or the effective stock in order for the printer to resume printing. (The operator can also abort the report.)
- EXACT (or STOP) causes the report to be aborted if the printer does not halt printing.

OUTPUT STAPLE

Specifies that copy sets will be bound by a wire stitch on printers that are configured with a stitcher stacker option. Jobs can be offset and stapled simultaneously.

(This command is ignored by the DP 100/115/135/155/180 EPS, because these systems do not have an internal stitcher. However, the command may be coded in a JSL that is compiled on the DP 100/115/135/155/180 EPS for use on another printing system that has a stitcher-stacker.)

The Nuvera 100/120 MX DPS supports a single portrait staple.

Syntax OUTPUT STAPLE = {NO | YES}

Options

Table 4-74. OUTPUT STAPLE parameter options and definitions

Option	Definition
YES	Specifies that a single wire stitch will be placed in sets of printed output. <ul style="list-style-type: none"> • LPS systems: Specifying STAPLE=YES forces the following parameter options: NTO1=YES, FACEUP=YES, and COLLATE=YES. • DP 75/90 systems: If a job requires N to 1 or face-up printing and STAPLE=YES has been specified, the system prints the job 1 to N and face down.
NO	Specifies that no stitching will occur.

Default NO

**OUTPUT STAPLE
parameter: points
to note**

- The STAPLE command must be specified in the initial JDL/JDE, or the JDL/JDE DJDE record must be the first record processed. If there is a banner page in front of the JDL/JDE DJDE record, the STAPLE command is ignored.
- If the NTO1=YES and STAPLE=YES parameters are specified, the system overrides NTO1=YES with NTO1=NO and places an error message in the listing file when the JSL is compiled.
- Individual sheets cannot be offset when they are coded in the JSL. To maintain consistent face-up orientation while stitched and unstitched jobs are delivered to the stacker, you may print unstitched sets N-to-1, provided that the system does not encounter the override conditions that have been defined.
- **DP 75/90 systems:** Jobs greater than 50 pages are not stapled. The default behavior is to fault the job, with no error message displayed. If you want the job to print without any finishing, do the following in the Overprint Finishing section of the Finishing window:
 1. Select [Print Job Unfinished].
 2. Select [Check Set–Size] before Printing.

OUTPUT STOCKS

Identifies the stockset and its associated stocks that will be used for a report. This stockset file (*STOCKSETNAME.STK*) must have been created previously via compilation of a JSL and must currently be stored in the “lcds” resource folder.

Syntax OUTPUT STOCKS = *stocksetname*

Options

Table 4-75. OUTPUT STOCKS parameter options and definitions

Option	Definition
<i>stocksetname</i>	Specifies the stockset to be used for the job.

Default No default.

OUTPUT STOCKS
parameter: points
to note

- If the *stocksetname* does not reference a STOCKSET command coded earlier in the same JDL, the system assumes that the stockset exists as a .STK file in the “lcds” folder, which is read at print time. In this case, XJDC inserts a message in the listing file when the JSL is compiled, indicating that a .STK file will be used at print time.
- Whenever a new stockset is chosen at the start of a report or through a JDE and JDL switch invoked by a DJDE, the system checks each stock to verify that the stock exists and can be made active. This verification provides an automatic method of changing stocks in the system as required by the data stream.

OUTPUT SYSPPR

Specifies the paper size for printing pages generated by the system (such as error sheets).

Syntax OUTPUT SYSPPR = {USLEGAL | A3 | A4 | B4 | USLETTER | (x, y)}

Options

Table 4-76. OUTPUT SYSPPR parameter options and definitions

Option	Definition
USLEGAL	8.5 by 14 inches / 216 by 279 mm
A3	16.54 by 11.69 inches / 420 by 297 mm
A4	8.27 by 11.69 inches / 210 by 297 mm
B4	10.12 by 14.33 inches / 257 by 364 mm
USLETTER	8.5 by 11 inches / 216 by 279 mm
(x, y)	User specified width and length. <ul style="list-style-type: none"> • x defines the width in inches, cm, dots, or Xdots. • y defines the length in inches, cm, dots, or Xdots.

Default No default.

**OUTPUT SYSPPR
parameter: points
to note**

- PAPERSIZE=B4 and PAPERSIZE= (10.12, 14.33) produce identical results in that they indicate long edge feed, as opposed to short-edge feed format. Refer to the “SEFFNT command” section in the “Specifying input parameters” chapter for detailed information on short and long-edge feed.
- The SYSPPR parameter takes effect for the following system pages:
 - DJDE error page (OPRINFO parameter of the IDEN command)
 - Report delimiter page (PRINT parameter of the RSTACK command)
 - Accounting page (ACCT command)
 - Graphic error summary page
 - Short Edge Feed error page
- **SYSPPR and the STOCKSET SYSPAGE parameter:**
System pages are checked for stocks through the SYSPAGE parameter. If there is no stock name active for the current page, the system checks to see if a stock name was specified at the user interface on the Stock tab of the queue Properties window. If so, the system page is printed on the stock that is specified on the user interface window. If SYSPAGE=*stock* is not specified, the MAIN stock definition is used.

SYSPPR defines the paper size to use for the system page. Therefore, if MAIN contains a mix of USLETTER and USLEGAL, the system searches for the appropriate feeder tray that contains the required paper size. If SYSPPR is not defined, the printer uses the paper size of the current job.

*NOTE: SYSPPR defines a paper size, whereas SYSPAGE defines a **stock name** reference. Both parameters must agree in order to prevent errors, similar to the way the FEED and PAPERSIZE parameters interact.*

OUTPUT TMODE

Specifies a maximum paper width in order to improve throughput efficiency when mixed paper sizes are used.

Refer to “Paper sizing and print speed” in your printer operator guide for an explanation of the relationship between paper widths and throughput speed.

Syntax OUTPUT TMODE = {*width* | (*width* [,*widthunit*])}

Options

Table 4-77. OUTPUT TMODE parameter options and definitions

Option	Definition
<i>width</i>	The process direction measurement that will be used to determine the pitch mode. <ul style="list-style-type: none"> For normal (long-edge) feeding, this is normally a measure of the short edge of the widest paper being used in the report. For short-edge feeding (SEF) this measures the long edge of the sheets. Acceptable values range from the system minimum to the system maximum (usually specified at system installation).
<i>widthunit</i>	Defines the unit of measurement for the default pitch mode. Choices are: <ul style="list-style-type: none"> IN CM DOTS XDOTS. IN (inches) is the default <i>widthunit</i> .

Default Based on the specified paper size (expressed in inches)

OUTPUT TMODE parameter: points to note

- This feature is not supported for the Nuvera MX systems.
- Width values can range from 7 inches or 178 mm to 17 inches or 432 mm.
- In order to process 7 by 10 inch and B5 papers, the printer must be configured with the 7 by 10 inch throughput kit (a hardware option).

- Pitch modes and throughput performance:** The printing system can operate in several different **pitch modes**: 3, 4, 5, 6, and 7. The following table shows the minimum and maximum boundary values for each pitch mode and the default paper sizes that can be specified with the TMODE parameter. The table shows these default scan values in inches (IN), centimeters (CM), DOTS, and XDOTS (dots at 600 dpi), along with their associated print speeds in pages per minute (ppm).

Table 4-78. Pitch mode minimum and maximum boundary values and pages per minute printing speeds

PITCH	IN	CM	MM	DOTS	XDOTS	PPM*
3	15.31 x 17.00	38.9 to 43.18	389 to 431.8	4595 to 5100	9190 to 10200	77
4	12.12 x 15.31	30.8 to 38.9	308 to 389	3639 to 4594	7277 to 9189	103
5	10.19 x 12.12	25.9 to 30.8	259 to 308	3060 to 3638	6119 to 7276	128
6	9.01 x 10.19	22.9 to 25.9	229 to 259	2705 to 3059	5410 to 6118	154
7	7.40 x 9.01	18.8 to 22.9	188 to 229	2221 to 2704	4442 to 5409	180
8	7.00 x 7.40	17.8 to 18.8	178 to 188	2100 to 2220	4205 to 4441	206

*Pages per minute

- In 7 pitch mode (the normal pitch mode for printing), the printer can process paper from 8 inches by 10 inches to 9.01 inches by 14.33 inches or 203 by 254 to 229 by 364 mm, in long-edge feed mode. This means the sheet is fed into the paper path with its long edge first.

 In this pitch mode, the printer prints with full productivity at 180 pages per minute, with seven page images per photoreceptor revolution.
- For papers whose width ranges from 9.01 inches to 15.31 inches, the printer prints with slightly reduced productivity. The reason for this is that for papers in this width range, the normal image area extends into the interimage zone that is normally used for xerographic process controls. In order to maintain the best productivity possible, xerographic process controls are temporarily suspended. Periodically, the system induces about 14 skipped “images” in order to perform a xerographic process control check and to ensure that the highest print quality is maintained. The printer then resumes printing at full productivity.

- For any paper size wider than 15.32 inches / 389 mm, the system automatically switches to 3 pitch mode, in which it prints up to 77 pages per minute.
- For very large papers, such as 11 by 17 inches or A3, paper is fed short edge first, so the 11-inch edge leads through the printer.
- **Using pitch mode and the TMODE parameter effectively:** Specifying the pitch mode (also called the “throughput mode”) with the OUTPUT TMODE parameter allows you to control the default pitch mode, which provides the following benefits:
 - **Matching system throughput with finishing device restrictions:** If the finishing device attached to the printer cannot accept output at rated speed, the printer inserts gaps in the paper path to ensure that pages do not arrive at the device too rapidly.

For example, if printing is done at 180 ppm, printing effectively slows to 68 ppm. This happens even if the finishing device actually could have accepted pages at up to 120 ppm. However, if you change the mode of this job from 7 pitch to 6 pitch mode, the job runs about 116 ppm.
 - **Eliminating process adjustment cycles during jobs that cross pitch boundaries:** Each time a job crosses a pitch boundary, the system performs a print quality adjustment. If this is done frequently within a job, the adjustments may take a substantial amount of the overall print time. Lowering the pitch mode so that the entire job runs in the same mode may enable you to significantly increase performance.
 - **Estimating the time needed to run your print jobs for scheduling purposes:** To better understand the potential value of specifying pitch modes in your JSLs, consider these hypothetical situations:
 - Problem: Your finishing device folds and binds your printed output but accepts pages at a slower rate than the FreeFlow Print Server LCDS systems produce pages.**
 - Solution:** You may want to slow down the rate at which the printer sends sheets to the device. Specify a different pitch mode.

Example: Assuming that your application calls for 8.5 by 11-inch paper, you could use 5 pitch mode. However, by selecting 4 pitch, which reduces the pages per minute on the DP180 EPS from 180 to 77, you make the printer speed more closely match your finishing device capabilities and you reduce the potential for paper jams.

Problem: Your application uses four paper sizes, ranging from 8.5 by 11 inches for the first few pages to 11 by 17 inches for the last several pages. Each time your printer detects a different paper size, it adjusts to accommodate it, significantly reducing throughput time.

Solution: By specifying a low enough pitch mode to accommodate all the paper sizes in your application (in this case, 3 pitch mode), you make the entire job run at the maximum possible throughput speed because paper size adjustments are limited. Keep in mind that you may select a lower pitch mode (allowing a greater scan value) for smaller size paper, but you would not want to select a pitch mode too small to accommodate a larger paper size.

Problem: You want to estimate how many applications you could run on a particular shift. However, given the size and complexity of your applications, you are uncertain as to how to plan.

Solution: By looking at the paper sizes, and thereby the pitch modes required by each application and the number of pages in each application, and by associating these with the ppms provided in the preceding table, you can roughly estimate the length of time each application requires for printing.

There are no absolute rules and no set methods for accomplishing your printing goals. The variables that are involved include individual finishing device requirements, the paper sizes required by your applications, the complexity of each page, the number of pages in each application, and so forth. However, a general understanding of the relationship between paper size and pitch mode and the advantages of specifying pitch modes will help you optimize your printing activities.

OUTPUT TRANS

Specifies whether or not transparencies are used in the print job.

Syntax OUTPUT TRANS = {YES | NO}

Options

Table 4-79. OUTPUT TRANS parameter options and definitions

Option	Definition
YES	Indicates that transparencies will be used in the job.
NO	Indicates that transparencies will not be used in the job.

Default NO

**OUTPUT TRANS
parameter: points
to note**

- **DP 100/115/135/155/180 EPS only:** Transparencies cannot be handled by the high capacity feeder/stackers. Due to this restriction, transparency jobs must be fed from the processor feeder trays (trays 1 and 2) and delivered to the sample tray. (The DP 75/90 EPS can feed transparencies from any tray.)
- If TRANS is specified in a job, these parameters automatically go into effect:

OUTPUT DUPLEX = NO;

ACCT USER = TRAY;

OUTPUT BFORM = NONE;

RPAGE SIDE = NUFROnt;

OUTPUT UNITS

Defines the size in dots of the unit of measure that will be used to position a graphic that is referenced by the OUTPUT IMAGE parameter or an IMAGE, ALTER, or GRAPHIC DJDE.

Syntax OUTPUT UNITS = *size*

Options

Table 4-80. OUTPUT UNITS parameter options and definitions

Option	Definition
<i>size</i>	An integer value constant that defines the number of dots in a user defined unit (UN). When used to compute the position of a graphic, the result is rounded to the nearest dot.

Default No default

OUTPUT XSHIFT

Specifies whether or not the image of the form and data on a page is to be shifted downward or upward (thus changing the x coordinate of the logical page origin) and if so, by what values.

XSHIFT is used to shift the image of the data downward or upward (as a long edge feed page is viewed in portrait orientation) to accommodate predrilled stocks, binding, finishing, edgemarking, and short-edge binding.

Syntax OUTPUT XSHIFT = {YES | NO | *value*}

Options

Table 4-81. OUTPUT XSHIFT parameter options and definitions

Option	Definition
YES	Specifies that the page image will be shifted up or down.
NO	Specifies that no X-image shift will occur.
<i>value</i>	An integer that specifies a shift amount on the front and back sides of a page. The shift is upward on a portrait oriented page when a positive value is specified, and downward when a negative value is specified. (Each dot is 1/300 of an inch.) The allowable range is 80 to -80.

Default No default

OUTPUT XSHIFT parameter example Following is an example of the OUTPUT XSHIFT parameter.

```
INVPDE: PDE          PMODE=PORTRAIT, BEGIN=(1.3, .37),
                   FONTS=P0612A;

INVJDE: JDE;

OUTPUT  INVERT=BACK, SHIFT=YES, XSHIFT=40,
        FORMAT=INVPDE, PAPERSIZE=(8.5, 11);
```

OUTPUT command: point to note

Certain parameters of the OUTPUT command interact with each other or with other commands. Some parameters require certain options to be specified in conjunction with other options; other parameters preclude the use of certain options. The following sections describe instances in which the OUTPUT command parameters affect each other as well as other commands, and what requirements exist under those circumstances.

Some specifications that are selectable from the user interface may override the JSL specifications.

OUTPUT command examples

This section shows some examples of the use of some OUTPUT command parameters.

Example 1

```
OUTPUT  GRAPHICS=YES, UNITS=150,
        CYCLEFORMS=NONE, FORMAT=PDE1,
        RESOLUTION=300;
```

Example 2

```
OUTPUT  COPIES=3, DUPLEX=YES, SHIFT=YES,
        OFFSET=FIRST, NUMBER=(1, 66, 132),
        COVER=(FRONT, SEP), FORMS=GBAR;
```

Pages printed with the OUTPUT command shown above are duplex with a margin shift of 75 dots. Three copies of the report are made, the first of which is offset; the second and third copies are stacked on top of the first. Each page is numbered at the end of line 66. The form GBAR appears on each data page of the report.

Example 3 The commands in the following figure illustrate use of the offsetting features of the OUTPUT command. The parameter ALL offsets all copies of all reports; FIRST offsets just the first copy of each report and NONE inhibits offsetting.



Figure 4-5. Illustration of ways to use OUTPUT OFFSET parameter

Example 4

```
OUTPUT CYCLEFORMS=(FORM1, NONE, FORM3);
```

or

```
OUTPUT CYCLEFORMS=(FORM1,,FORM3);
```

If there are ten pages in the report, either of the above commands would cause FORM1 to be applied to pages 1, 4, 7, and 10; no forms to be applied to pages 2, 5, and 8; and FORM3 to be applied to pages 3, 6, and 9.

Example 5 The commands in the following figure illustrate the use of CYCLEFORMS with multiple copies. Note that every copy of a particular page has the same form, whether COLLATE=YES or NO. The pages in the following example are not logical pages but are one side of a physical sheet of paper.

```
OUTPUT COPIES=2,
COLLATE=NO, DUPLEX=NO,
CYCLEFORMS=(FORM1, NONE);
```



```
OUTPUT COPIES=2,
COLLATE=YES
DUPLEX=YES,
CYCLEFORMS=(FORM1, NONE);
```



Figure 4-6. Illustration of use of OUTPUT CYCLEFORMS parameter in a multicopy report

PDE command

The PDE command specifies a page descriptor entry (PDE), which defines the formatting for each page of a report. This formatting information includes page orientation (landscape or portrait), location of the beginning print line for each logical page, and the fonts to be used.

ac identifier You must specify an identifier of the type *ac* (must have one alpha character) when defining the PDE, and reference it with the *FORMAT* parameter of the *OUTPUT* command. The PDE command must precede the *OUTPUT* command in the JSL.

Standard PDEs

The following table describes a set of standard PDEs, which are provided with the operating system software (OSS). You may use one of these standard formats to format your job, or you may create your own PDEs and compile them using the *xjdc* command. Refer to “Compiling a JSL” in the “PDL principles and procedures” chapter.

Table 4-82. Standard print formats (PDEs)

PDE id	No. of lines	No. of columns	lines per inch	char. per inch	Approx. point size	Page size and orientation*	BEGIN values	Default font id
FMT1	66	132	8.1	13.6	9	11 by 8.5	(.18,.66)	L0112B
FMT2	66	150	8.1	15	9	11 by 8.5	(.18,.50)	L0212A
FMT3	88	132	10.7	13.6	7	11 by 8.5	(.14,.66)	L0312A
FMT4	88	150	10.7	15	7	11 by 8.5	(.14,.50)	L0412A
FMT5	49	100	6	10	12	11 by 8.5	(.17,.50)	L0512A
FMT6	80	100	8.1	13.6	9	8.5 by 11	(.57,.58)	P0612A
FMT7	60	90	6	12	12	8.5 by 11	(.50,.50)	P07TYA
FMT8	60	75	6	10	12	8.5 by 11	(.50,.50)	P0812A
FMT9	80	200	10.0	20.0	7	11 by 8.5	(.25,.25)	L0912A
FMT10	132	132	12.5	17.6	6	8.5 by 11	(.22,.51)	P1012A
FMT11	132	150	12.5	20.0	6	8.5 by 11	(.22,.50)	P1112A
FMT12	66	172	8.1	13.6	9	14 by 8.5	(.18,.66)	L0112B
FMT13	104	100	8.1	13.6	9	8.5 by 14	(.57,.58)	P0612A
FMT1A	66	132	8.3	12.5	9	11.69 by 8.27	(.18,.57)	R112BL**
FMT2A	66	150	8.3	14.3	9	11.69 by 8.27	(.18,.60)	R212BL**
FMT3A	88	132	11.1	12.5	7	11.69 by 8.27	(.18,.57)	R312BL**
FMT4A	88	150	11.1	14.3	7	11.69 by 8.27	(.18,.60)	R412BL**
FMT5A	48	100	6	10	12	11.69 by 8.27	(.22,.85)	R512BL**
FMT6A	80	100	8.1	13.6	9	8.27 by 11.69	(.91,.46)	R612BP**
FMT7A	60	90	6	12	12	8.27 by 11.69	(.85,.39)	R7TIBP**
FMT8A	60	75	6	10	12	8.27 by 11.69	(.85,.39)	R812BP**
FMT9A	80	200	10.0	20.0	7	11.69 by 8.27	(.14,.85)	R912BL**
FMT10A	132	132	12.5	17.6	6	8.27 by 11.69	(.57,.39)	RA12BP**
FMT11A	132	150	12.5	20.0	6	8.27 by 11.69	(.57,.39)	RB12BP**
*The first dimension given is the horizontal dimension. Thus, 11 by 8.5 is landscape orientation, while 8.5 by 11 is portrait orientation. Dimensions are given in inches.								
**A4 European international formats.								

PDE command parameters

The following table summarizes the PDE command parameters.

Table 4-83. Summary of PDE command parameters

Parameter	Specifies	Online	Offline	DJDE
PDE BEGIN	Specifies the location of the first print line on the page.	Y	Y	Y
PDE FONTS	Specifies the fonts to be used to print CME and variable data.	Y	Y	Y
PDE PMODE	Specifies whether the job will print with landscape or portrait orientation.	Y	Y	Y

The following sections describe the syntax of the PDE command parameters and explain the parameter options.

PDE BEGIN

Specifies the location of the starting print line of a logical page. It may be in inches (IN) or centimeters (CM).

Defining multiple logical pages on a physical page

Logical pages are user defined page images, each bordered by Top Of Form, Bottom Of Form, and left and right margins. To define multiple logical pages on one physical page (one side of a sheet), you code a separate PDE BEGIN parameter for each logical page you want to define.

You may define up to 63 logical pages for one physical page. You may define them in any order and place them on the physical page in the sequence that the BEGIN parameters appear in the PDE command. The first BEGIN specified, whatever its physical position on the page, is logical page one.

Syntax *ac*: PDE BEGIN = (*vpos* [*unit*], *hpos* [*unit*])

Options

Table 4-84. PDE BEGIN parameter options and definitions

Option	Definition
<i>vpos</i>	<i>vertical position</i> Specifies the vertical position of the first character of the first print line of the logical page relative to the top edge of the physical sheet. It must be a decimal number with up to four digits to the right of the decimal point; for example, 0.5634 or 2.35. The default vertical position is .18.
<i>hpos</i>	<i>horizontal position</i> Specifies the horizontal position of the first character of the first print line of the logical page, relative to the left edge of the physical sheet. All specifications are rounded to the nearest dot (1/300 of an inch) for positioning of the logical page. The default horizontal position is .66.
<i>unit</i>	Specifies the unit of measure for the distance from the edge of the physical sheet to the first character of the first print line. The choices are: <ul style="list-style-type: none"> • IN (inches) • CM (centimeters) The default unit of measure is IN.

Default (.18 IN, .66 IN)

**PDE BEGIN
parameter: points
to note**

- When specifying the location of the beginning of a print line on a logical page, view the page in the orientation (landscape or portrait) in which it will be printed.
- Structure your variable data in the same order that the logical pages are defined, using either spacing or skipping printer carriage controls to move from one logical page to the next. Generally, a Skip to Channel 1 parameter is the easiest way to position to the next logical page.
- Each online banner page is positioned as the first logical page on a new physical sheet (if the BANNER TYPE parameter specifies BANNER).
- ROFFSET causes the logical page containing the matching criteria to be the first logical page of a new physical sheet.
- Page numbering occurs on each logical page, rather than each physical page.
- Commands that specify line numbers, such as CRITERIA, VFU, CME, and NUMBER, refer to the line on the current logical page (ranging from TOF to BOF).

- RTEXT is imaged on a separate physical sheet. The line and column specifications for positioning the text refer to the first logical page specified in the PDE.
- RAUX criteria that is found on any logical page on the physical page causes that sheet to be fed from the tray containing the stock identified as the AUX stock.
- Accounting statistics are accumulated on the basis of physical pages.
- If any logical page overflows the physical page before BOF is encountered, the next line moves to the first logical page of the next side, and all subsequent logical pages are repositioned based on BEGIN values.
- With the exception of DEPT and SHIFT, all page oriented DJDEs take effect at a logical page boundary.
- When the following DJDEs are applied, the current page position moves to the first logical page on the front side of a new physical sheet:
 - BFORM
 - COPIES
 - DUPLEX
 - JDE
 - JDL
 - OTEXT
 - RTEXT
- The following DJDEs cause the current page position to go to the first logical page on the next physical side of the sheet:
 - FORMAT
 - FORMS
- If no BEGIN parameter is specified, the default PDE FMT1 (one logical page per physical page) is used.
- The FreeFlow Print Server LCDS systems support the specification of horizontal position values with up to four decimal places; the other Xerox LPS systems support a maximum of only three places.

- The placement of the values of the BEGIN parameter on the FreeFlow Print Server LCDS systems, 4850 LPS, 4890 LPS, and DP92C LPS is relative to the top edge of the physical sheet for all paper sizes. On the 4635 and DP180 LPS, however, an A4 paper size specification causes the image to shift approximately 1/8 inch (3 mm) downward.

If you want to provide consistency between jobs that are printed on the FreeFlow Print Server LCDS systems and on a 4635 or DP180 LPS, you can adjust the alignment by 35 dots using the FreeFlow Print Server LCDS systems queue management windows. Refer to the “Adjusting alignment” section of your printer operator guide for this procedure.

PDE FONTS

Specifies the fonts to be used in printing variable input data and CME data.

Syntax *ac*: PDE FONTS = {(*f*₁ [, *f*₂] [,...]) | ((*f*₁, *s*₁ [, *unit*]) [, (*f*₂, *s*₂ [*unit*]) [, ...])}

Options

Table 4-85. PDE FONTS parameter options and definitions

Option	Definition
<i>f</i>	<i>font</i> . Specifies a one to six alphanumeric character identifier (consisting of at least one letter) corresponding to a font cataloged on the system disk (you can use up to 128 fonts with the font indexing capability).
<i>s</i>	<i>spacing</i> . Specifies an optional override line spacing value defined by either the print lines per inch (LPI) or the dots per print line (DOTS or XDOTS) to be associated with the font. Maximum value for <i>s</i> is 30 LPI; minimum value is 10 dots. There is no default LPI value for <i>s</i> .
<i>unit</i>	A unit of measure for the override line spacing to be associated with a font. The unit can be one of the following: <ul style="list-style-type: none"> • LPI (lines per inch) • DOTS (dots per print line at 300 dpi) • XDOTS (dots per print line at 600 dpi) The default unit is LPI.

Default No default

PDE FONTS
parameter: **points**
to note

- If different fonts are used on the same print line, character heights of all fonts used in the print line are compared to find the largest font in the line. (The line spacing value that was defined, or specified as an override, for that font is used to determine the position of the next print line.)
- The maximum number of fonts that may be used in printing a given page or a given job varies depending on a number of factors. The number of fonts specified in the FONTS parameter must be at least equal to the largest number of fonts required to print any page within the job.

When the system is unable to receive an allocation of dynamic memory, the job aborts. Particularly for input, the limitations of dynamically allocated memory impose additional constraints that effectively reduce the maximum number of fonts that may be used to print a page. The number of fonts specified in the FONTS parameter determines the size of a dynamically allocated table where information about the fonts is cached.

- An *xdot* is 1/600 unit of measurement. You can create, edit, and compile a form specifying XDOTS on any Xerox laser printing system (other than the FreeFlow Print Server LCDS systems) with version 3 or higher software. The 600 spi form does not print on the FreeFlow Print Server LCDS systems, which accept only 300 spi data.

PDE PMODE

Specifies the printing mode (orientation) for each physical sheet.

Syntax *ac*: PDE PMODE = {LANDSCAPE | PORTRAIT}

Options

Table 4-86. PDE PMODE parameter options and definitions

Option	Definition
LANDSCAPE	Indicates that printing will be parallel to the long edge of paper (for paper loaded with its long edge facing the feed direction). Print lines on 11 by 17 inch or A3 paper are parallel to the short edge.
PORTRAIT	Indicates that printing will be parallel to the short edge of paper (for paper loaded with its long edge facing the feed direction). Print lines on 11 by 17 inch or A3 paper are parallel to the long edge.

Default LANDSCAPE

PDE command: points to note

- You may code PDEs as part of the JSL or create them as separate files so that they may be referenced by one or more JDLs or by DJDEs. PDEs are invoked by the OUTPUT FORMAT parameter or by the FORMAT DJDE. A PDE must have been previously compiled for a DJDE to access it.
- You can create a PDE as a separate disk file and use it as if it were part of the JDL that references it. To do this, create a JSL file containing only PDE commands and use the “xjdc” command to compile it. Refer to “Compiling a JSL” in the “PDL principles and procedures” chapter for information on using **xjdc** to compile files.

For each PDE command, **xjdc** creates a file with the .PDE extension, in the “lcds” folder on the system disk. The PDE command identifier becomes the PDE file name.

When the system encounters a reference to a PDE in a JDL, it searches the “lcds” resources folder for the PDE that was specified. If it finds it, the system loads the PDE into memory for use in processing the report.

PDE command examples

Example 1 Two PDEs are defined and are referenced in separate JDEs. PDE1 specifies a landscape page and two landscape fonts; PDE2 defines a portrait page and two portrait fonts with override line spacing.

```
PDE1: PDE          PMODE=LANDSCAPE, BEGIN=(.861,.7),
                FONTS=(L0112B, L01BOB);

PDE2: PDE          PMODE=PORTRAIT, BEGIN=(1.3,.37),
                FONTS=((P08TYA,6.8), (P080AA,6.8));

L1:    JDE;
      OUTPUT      FORMAT=PDE1;

P1:    JDE;
      OUTPUT      FORMAT=PDE2;
```

Example 2 The following is an example of multiple BEGINs. Two logical pages are defined on one physical page.

```
2UP: PDE      BEGIN=(.5 IN, .5 IN) ,
              BEGIN=(6.5IN, .5 IN) ,
              PMODE=PORTRAIT,
              FONTS=P1012B;
```

Example 3 This is an example of a PDE that may be compiled separately from a JDL. The compilation process creates a .PDE object file, which may be referenced from within a JDL or by a DJDE. The name of the object file for this PDE is PDE99.PDE (the same as its identifier in the source command shown below).

```
PDE99: PDE      PMODE=PORTRAIT,
                BEGIN=(.10, 0) ,
                FONTS=(P07ITA, P08OAA) ;

END;
```

ROUTE command

The ROUTE command allows you to print identifying information (text and an optional form) on a page preceding a report. You may code this command within a JDL or in a disk file of ROUTE commands.

ROUTE command parameters

The following table summarizes the ROUTE command parameters.

Table 4-87. Summary of ROUTE command parameters

Parameter	Specifies	Online	Offline	DJDE
ROUTE RFORM	Specifies a form that will be printed with RTEXT pages.	Y	Y	Y
ROUTE RTEXT	Specifies the text that will be printed preceding a report copy.	Y	Y	Y

The following sections describe the syntax of the ROUTE command parameters and explain the parameter options.

ROUTE RFORM

Specifies a form to be printed with all RTEXT pages.

Syntax ROUTE RFORM = {*formid* | NONE}

Options

Table 4-88. ROUTE RFORM parameter options and definitions

Option	Definition
<i>formid</i>	<i>form identifier.</i> Name of the form that will be used with all RTEXT pages. This identifier references a previously created form file (<i>formid.FRM</i>).
NONE	Specifies that no form will be printed on RTEXT pages.

Default NONE

**ROUTE RFORM
parameter: points
to note**

- The RFORM parameter is not allowed in a ROUTE command that is a catalogued file, but it may be specified in the ROUTE command in a JSL invoking the catalogued RTEXT file. It also may be specified in the RFORM DJDE.
- If RTEXT data is not specified, the system ignores the RFORM command. However, you can specify RTEXT as one blank character (or space) in order to print an RFORM on the routing page without any accompanying text.

ROUTE RTEXT

Specifies text that will be printed on a separate page preceding a report or report copy.

Syntax [*ac*:] ROUTE RTEXT = {NONE | *sc* | (*sc* [, {*passnum* | ALL} [, *line* [, *col* [, *fontindex*]]]]) | *rtextid*}

Options

Table 4-89. ROUTE RTEXT parameter options and definitions

Option	Definition
<i>sc</i>	<i>string constant.</i> Specifies the message to be printed (a string of 1 to 132 characters). It is printed with the first font specified in the FONTS parameter of the PDE command. Refer to the <i>fontindex</i> option in this table.
<i>passnum</i>	<i>pass number.</i> An integer specifying the single copy (pass) to which the text applies. If there is more than one RTEXT parameter in a DJDE packet, <i>passnum</i> must be in increasing numeric order.
ALL	Specifies that the text applies to all copies.
<i>line</i>	Specifies the line number on which the first line of a block of RTEXT message is printed. To avoid overprinting, only one RTEXT parameter may be specified per line for a <i>passnum</i> . The default is line 1 for the first text string of the pass. Otherwise, the default is the next line of the page.
<i>col</i>	<i>column.</i> Specifies the column number at which the first character of a block of RTEXT messages is to be printed. The default is column 1.
<i>fontindex</i>	Identifies the font index (starting with 1) of the PDE font with which the text is printed.
<i>rtextid</i>	<i>routing text identifier.</i> References a catalogued file of RTEXT parameters previously compiled by XJDC.
NONE	Specifies that no routing text will be printed on a separate page.

Default NONE

**ROUTE RTEXT
parameter: points
to note**

- The font index is associated only with a particular string. To print an entire RTEXT page in the same font, you must specify the font index with each string. For strings without a *fontindex* specified, the system uses the first font (specified in the PDE FONTS parameter).
- The positioning of the first line of data on the page following an RTEXT page is determined by font 0 of the current font list.
- If more than one font is used to print any number of RTEXT strings on a page, the line and the character spacing values of the different fonts are used to place RTEXT on the page.

- If a proportional pitch font is used, the starting column number for printing the RTEXT is determined by using the character spacing value for the space character in the character font.
- If RTEXT is specified along with COVER=(FRONT, SEP) or (BOTH, SEP), the RTEXT pages are printed on the covers. Front covers are picked only on copies for which there is RTEXT. If RTEXT is specified in noncollate mode, only the routing page for copy one is printed.
- EBCDIC or hexadecimal strings (or hex defined bytes in a character string) used in an RTEXT command are interpreted as standard EBCDIC and are translated to extended ASCII.
- **Double byte font support:** Double byte text strings are supported for the CME CONSTANT value if KCODE or DBCODE is specified for the VOLUME command. The maximum number of double byte characters is 127.
- **Catalogued RTEXT files:** When there are a large number of RTEXT parameters, you should precompile them and store them in the “lcds” resources folder, instead of including them in a JDL. After they are compiled, you can access them from either a JDL or a DJDE by using their object file names. RTEXT parameters must be precompiled to be accessed with a DJDE.

To catalog RTEXT parameters, you must include an identifier of the type *ac* (at least one alpha character) in the ROUTE command. This identifier is used to reference the RTEXT file by means of the ROUTE RTEXT= *rtextid* parameter. If the catalogued RTEXT is defined within a JSL, it is automatically applied to that JDL.

The RTEXT file is catalogued if the ROUTE command has an identifier, even if the ROUTE command is inside the portion of the JSL that defines a JDL. (This is different from other catalogued file creation such as PDEs or CMEs.)

An example of catalogued RTEXT usage is shown below.

```
ROUTEF1: ROUTE    RTEXT= ('USER1 ', 1, 33, 64) ,  
                  RTEXT= ('BLDG1 ', 1, 34, 64) ,  
                  RTEXT= ('USER2 ', 2, 33, 64) ,  
                  RTEXT= ('BLDG2 ', 2, 34, 64) ;
```

After the above commands are compiled by PDL, a .TST file is created. In the example above, the file would be named "ROUTE1.TST." You can then access this file by name with the ROUTE command (RTEXT= *rtextid*) from a JDL or with a DJDE. For this example, the RTEXT parameter would be coded as follows:

```
RTEXT=ROUTE1,
```

You must specify RFORM, if it is needed, along with the reference to the RTEXT file (RFORM is never catalogued with RTEXT). This allows you to select different RFORMs in different JDEs with the same RTEXT information.

ROUTE command example

Following is an example of how to use the ROUTE command:

```
ROUTE    RTEXT= ( 'USER1 ' , 1 , 33 , 64 ) ,  
          RTEXT= ( 'USER2 ' , 2 , 33 , 64 ) ;
```

The text USER1 and USER2 will print in the center of a page preceding the respective copies of a two copy report. The page is 132 columns by 66 lines.

STOCKSET command

The STOCKSET command defines a set of stocks to be used in a report. Stocksets are also the means of associating stock references with stock names. For the FreeFlow Print Server LCDS systems, a *stockname* or *stockreference* functions the same as a **cluster** does on other Xerox laser printing systems. Stock names and associated trays are specified at the print server, using the Stock Manager windows.

An identifier of the type *ac* (at least one alpha character) is specified to name the stock set. This identifier is used (referenced) by the OUTPUT STOCKS parameter in JSLs to select that group of stocks.

STOCKSET command parameters

The following table summarizes the STOCKSET command parameters.

Table 4-90. Summary of STOCKSET command parameters

Parameter	Specifies	Online	Offline	DJDE
STOCKSET ASSIGN	Lists stock names and associates them with stock references.	Y	Y	N
STOCKSET INIFEED	Specifies which stock to use in the absence of any designation in the OUTPUT FEED parameter.	Y	Y	N
STOCKSET SYSPAGE	Specifies the stock on which system generated pages will print.	Y	Y	N

STOCKSET ASSIGN

Associates stocks with an identified *stock reference* or with other stocks to create a stock set that will be used together in an application.

Syntax [ac]: STOCKSET ASSIGN = (*stockdescriptor*₁ [, *stockdescriptor*₂] [...])

Options

Table 4-91. STOCKSET ASSIGN parameter options and definitions

Option	Definition
<i>stockdescriptor</i> Can have one of the following formats: <ul style="list-style-type: none"> • '<i>stockname</i>' • (<i>'stockname'</i>, <i>stockreference</i>) • (<i>'stockname'</i>, <i>stockreference</i> [, <i>stockreference</i> [...]]) 	<ul style="list-style-type: none"> • <i>Stockname</i> is the specific name of a stock. It is enclosed in single quotes. • <i>Stockreference</i> is an alternate term for referencing the named stock. It is common to assign the <i>stockreference</i> according to its function in the job or some other characteristic. <p>A <i>stockreference</i> may be assigned to only one <i>stockname</i>.</p>

Default No default

Example of use of STOCKSET ASSIGN ASSIGN = (('F1302', COVER), ('F1415', BODY))

STOCKSET INIFEED

Specifies which stock to use in the absence of any OUTPUT FEED parameter or FEED DJDE. If no stock is specified, the INIFEED parameter defaults to the first stock name specified in the ASSIGN parameter.

Syntax [ac:] STOCKSET INIFEED = {'stockname' | stockreference}

Options**Table 4-92. STOCKSET INIFEED parameter options and definitions**

Option	Definition
<i>'stockname'</i>	Specifies the name of the stock to be fed for the job if no stock is specified in the OUTPUT FEED command or the FEED DJDE. It is enclosed in single quotes.
<i>stockreference</i>	Specifies the stock for the job by the term associated with it in the STOCKSET ASSIGN command.

Default The first stock name

STOCKSET SYSPAGE

Specifies which stock to use for system generated pages, such as exception and accounting pages, and the pages generated by the OPRINFO DJDE and the PLABEL parameter.

Syntax [ac:] STOCKSET SYSPAGE = {'stockname' | stockreference | MAIN | AUX}

Options**Table 4-93. STOCKSET SYSPAGE parameter options and definitions**

Option	Definition
<i>'stockname'</i>	Specifies the name of the stock to be used to print system pages. It is enclosed in single quotes.
<i>stockreference</i>	Specifies the stock for printing system pages by its reference term, which was defined using the current STOCKSET ASSIGN parameter.

Table 4-93. STOCKSET SYSPAGE parameter options and definitions

Option	Definition
MAIN	Specifies that system pages feed from the tray containing the stock identified as MAIN.
AUX	Specifies that system pages will feed from the tray containing the stock identified as AUX.

Default MAIN

STOCKSET SYSPAGE parameter: points to note

- **Paper size mismatch on system pages:** Pages generated by the system via such commands as IDEN OPRINFO are formatted for 8.5 by 11 inch paper, unless the queue has been configured for A4 paper. These system generated pages are printed with the STOCKSET SYSPAGE parameter that is in currently effect. If no STOCKSET parameters are in effect, the MAIN stock is used, unless it overridden by a specification entered on the user interface windows.

Example of mismatch handling:

Assume that you try to print this page on 8.5 by 11 inch paper, subject to the stock that was identified by the SYSPAGE parameter or the specification that was entered at the print server screen.

- If the paper size is not available, the system attempts to print the page on a different paper size chosen from the set of trays that normally would be used. No warning, caution, or cycling down occurs.
- If a larger paper size is available, it is used. If a larger paper size is not available, a smaller paper size is used. This is the only time a page may be printed on a paper size smaller than what was specified to format the page.

When a system generated page is not printed on the size paper that was used to format it, the positioning of the data on the physical page is not guaranteed. For example, when printing on a larger paper size, the data does not fall off the physical page, but it may not appear in the correct location. When printing on a smaller size paper, the data may fall off the physical page and appear incomplete.

- The MAIN and AUX stocks and their preferred trays have already been defined in the operating system software when the printing system is delivered. However, you can change their specifications at the user interface, using the Stock Manager windows. (You cannot, however, delete them.)

STOCKSET command example

The STOCKSET command is similar to the PDE and CME commands, because it produces a file you can compile separately from the JDL. For each STOCKSET encountered before an initial JDL or SYSTEM command, PDL creates a file of the type .STK, which contains information about the stockset. You can then reference the .STK file in multiple JSL source files.

```
BILLS:  STOCKSET  ASSIGN = ('F1302', COVER),
          ASSIGN = ('F1415', (BODY, SUMMARY)),
          ASSIGN = (('F6204', LATE),
                   ('F9999', DISCON)),
          INIFEED = COVER,
          /*INIFEED='F1302' works as well*/
          SYSPAGE = COVER;END;
```

In the example above, a stockset called BILLS is created.

- BILLS consists of four stocks: F1302, F1415, F6204, and F9999.
- Stock references are created for these four stocks: COVER for F1302, BODY and SUMMARY for F1415, LATE for F6204, and DISCON for F9999.
- In the absence of a specific parameter of the FEED command at the start of the report, INIFEED directs output to feed from the stock referred to by COVER.
- A system page will print on the stock referenced as COVER.

You could use this stock set in a billing application by coding an OUTPUT STOCKS = BILLS command in the JDE. Through successive FEED DJDEs, the stock set directs feeding the cover, body and summary, late notice, and disconnect pages from the stock referenced by COVER, BODY, SUMMARY, LATE, and DISCON, respectively.

Alternatively, the FEED DJDE record could refer directly to stocks by name, such as FEED= 'F1302'. Note that the use of stock references is preferred over stock names, because stock references provide flexibility.

VFU command

The VFU command assigns output line numbers to printer carriage control channels. These Line to Channel assignments perform the same function as the printer carriage control tape on a conventional line printer.

The VFU command also assigns line numbers to the top of the form (TOF parameter) and the bottom of the form (BOF parameter). TOF and BOF are used for prejob page alignment and for page overflow processing.

ac identifier You must specify an identifier of the type *ac* (at least one alpha character required) when defining the VFU table, and reference it in the VFU parameter of the LINE command. The VFU command must precede the referencing LINE command.

VFU command parameters

The following table summarizes the VFU command parameters.

Table 4-94. Summary of VFU command parameters

Parameter	Specifies	Online	Offline	DJDE
VFU ASSIGN	Assigns a VFU channel number to a page line number or set of line numbers.	Y	Y	Y
VFU BOF	<i>Bottom Of Form</i> Indicates the number of lines from the top of an output page to the last print line on the page; i.e., defines the last line on which printing appears.	Y	Y	Y
VFU TOF	<i>Top Of Form</i> Indicates the number of lines from the top (as defined by the PDE BEGIN values) of an output page to the first print line on the page; in other words, defines the first line on which printing appears.	Y	Y	Y

The following sections describe the syntax of the command parameters and explain the parameter options.

VFU ASSIGN

Specifies assignments of channel numbers to output lines.

Syntax [*ac*:] VFU ASSIGN = {(*channo*, *lineno*) | (*channo*, (*lineno*₁ [, *lineno*₂] [, ...]))}

Options

Table 4-95. VFU ASSIGN parameter options and definitions

Option	Definition
<i>channo</i>	<i>channel number.</i> The number of the channel being assigned. It is an integer in the range 0 to 15.
<i>lineno</i>	<i>line number.</i> The number of the output print line that you are assigning to a particular channel. It is an integer in the range TOF to BOF.

Default No default

VFU BOF

Specifies the Bottom Of Form line number.

Syntax [*ac:*] VFU BOF = *value*

Options

Table 4-96. VFU BOF parameter options and definitions

Option	Definition
<i>value</i>	Specifies the number of lines from the top of the output page to the last print line on the page (bottom of form). The Bottom Of Form specification is independent of channel assignments. BOF should be greater than or equal to the largest line number assigned to a channel. The maximum value for BOF is 255.

Default 66

VFU BOF parameter: point to note If the carriage control action specified by the PCC ASSIGN parameter for BOF is specified as OVR (the default), the processing spaces from Top of Form a number of lines equal to the difference between the location of the current line and the new BOF (if it is different from the original BOF).

VFU TOF

Specifies the Top Of Form line number.

Syntax [*ac:*] VFU TOF = *value*

Options

Table 4-97. VFU TOF parameter options and definitions

Option	Definition
<i>value</i>	Specifies the number of lines from the top of the logical page to the first print line (top of form). The TOF specification is independent of channel assignments. It should be greater than or equal to 1, and less than or equal to the smallest line number assigned to a channel.

Default 1

VFU TOF parameter: point to note If the value that is specified in the TOF parameter is greater than or equal to the BOF (Bottom Of Form) value, the TOF value is set to 1.

VFU command: points to note

- For all PCCTYPES except ANSI and user defined PCCs, the prejob page alignment is with TOF in the expectation that the first carriage control parameter of the job will be Print and Space One Line, or something similar.
- Page overflow occurs when spacing to the next line causes the BOF line number to be exceeded. Page transition occurs, and line spacing continues from the TOF line number. (Xerox carriage control is an exception to this processing.)
- Any channel operation encountered during printing for an unassigned channel causes a Print And Space 1 Line operation. This operation occurs even though some vendor formats normally specify the default as a Space 1 Line And Print operation.
- Multiple line numbers may be assigned to the same channel number. This simulates the vertical tabbing feature of an impact line printer where a Skip to Channel parameter causes transition to the next punched hole in the specified channel of the paper tape. This paper tape, which controls the printer, facilitates spacing a fixed number of lines down the print page. There may be multiple punches in any vertical format channel on the impact printer tape.
- A Skip to Channel parameter sent to the printing system causes it to select the next line number in the PCC ASSIGN list (for that channel) larger than the current line number. Page transition and alignment to the first line number in the list occur if no line number is larger than the current line.

VFU command example

Following is an example of how to use the VFU command.

In the following example, top of form is assigned to line number 5 and bottom of form is assigned to line number 55. Channels 1, 2, and 12 have been assigned line numbers.

```
V1: VFU    ASSIGN=(1,5),  
          ASSIGN=(2,(10,15,20,25,30,35,40,45,50)),  
          ASSIGN=(12,55), TOF=5, BOF=55;
```

Assume the printing system is printing a report and the current line number is 11.

- If a Skip To Channel 1 And Print parameter is issued, a page transition occurs. Printing begins on line 5 (assigned to channel 1), which is the top of form on the new page.
- If a Skip to Channel 2 And Print parameter is issued when the current line number is 11, the next line to be printed is line 15 of the current page. Lines 10, 15, 20, and so forth, are also assigned to channel 2, but because the current line number is 11, the next consecutive line number assigned to channel 2 (greater than 11) is line 15.
- If a Skip To Channel 12 And Print parameter is issued, the next line to be printed is line 55 of the current page.

5. Using Dynamic Job Descriptor Entries (DJDEs)

Dynamic Job Descriptor Entries, unlike the PDL commands described in the Input Processing, Print Format, and Logical Processing sections, are not coded in JSLs. They are coded in the data stream to make changes during printing to what was specified in the JSL. DJDEs are coded slightly differently from JSL statements.

Using the IDEN command to enable DJDEs

To invoke DJDE processing in a job, you must code an IDEN command in the JDL. The DJDE record(s) are interspersed among the data records in the input data stream. Each DJDE record contains an identification field (which matches the search criteria specified in the active JDE) and a series of parameters that describe the actual JDE changes to be applied to the report. The IDEN command notifies the system that DJDE records may be part of the input data stream. IDEN also describes the characteristics of the DJDE records and the search criteria for locating and identifying them.

Example Following is an example of a coded IDEN command:

```
IDEN    PREFIX='RTEST', SKIP=9, OFFSET=3,  
        OPRINFO=YES;
```

The PREFIX parameter defines the character string that must appear in the identification part of each DJDE record in the input data stream. When the system recognizes this character string (in this example, it is the EBCDIC string 'RTEST'), it examines the rest of the record for DJDE parameters. The OFFSET and SKIP parameters define the starting positions of the prefix string and DJDE parameters within the record.

Example Here is another example:

```
IDEN    PREFIX=E'DJDE', SKIP=7, OFFSET=2,  
        OPRINFO=YES;
```

For information on coding the IDEN command and explanations of its parameters and options, refer to the “IDEN command” description in the “Specifying input parameters” chapter.

Specifying DJDE records

DJDE records are part of the data stream. The system looks for them only if there is an IDEN PREFIX command within the JDE used to process the job. DJDE information is contained in one or more records, each of which may be up to the maximum record length specified for the job input data. For each DJDE record, the prefix (the identification field) must begin in the same location in the record.

Ending a DJDE A group of DJDE records, called a *packet*, is terminated by an END parameter in the last DJDE record in the packet. All specified DJDE information is applied at the next record or page boundary after the END parameter is encountered.

The end of a DJDE record parameter that is split and continued on the next DJDE record must be followed by a comma, then a semicolon (,;).

NOTE: After a DJDE packet is terminated by an END parameter, there must be one or more data records before the next DJDE packet. DJDE records directly following a previously terminated DJDE parameter set are ignored.

Multiple DJDEs There may be multiple DJDE packets in a job. Only the specific parameters mentioned within the packet are modified.

DJDE coding guidelines When preparing DJDE records as part of the input data stream, keep in mind the following guidelines.

- A DJDE record may contain more than one parameter. Each parameter within a record must be separated from the next parameter by a comma.
- The prefix in a DJDE record may appear after the DJDE parameter(s) as long as it is consistently located in all DJDE records.

- DJDE records need not be consecutive because none of the parameters are applied until the system encounters END. However, it is recommended that DJDE records be consecutive, especially when used with delimiter records.
- A page oriented DJDE that is positioned **before** any print record on a page takes effect on the current page.
A page oriented DJDE that is positioned **after** the first print record on a page takes effect on the next page, unless End Of Report is encountered.
- DJDE packets that immediately follow a deferred page oriented DJDE are recognized and ignored. DJDE packets that are separated by one or more data records from a deferred page oriented DJDE packet on the same page are applied.
- For Delimiter Mode stacked report processing, DJDE parameters may be placed within or after (but not before) the delimiter record packet.
- If a DJDE is always created because of your coding procedures, but there is no need to set any of the DJDE parameters for a particular report, you can create a null DJDE with nothing but an END parameter specified. The null DJDE does not modify any of the existing job setup parameters.

Application of DJDEs

The specific parameters included in a DJDE packet are the only ones modified when the DJDE is applied. The only exceptions are the JDE DJDE and JDL DJDE, which cause all processing parameters contained in the JDE to be updated except for those listed in the “Restrictions on job parameter modification” section of this chapter. The modified parameter remains in effect until that parameter is encountered in a later DJDE packet, or until the end of the report is reached.

When the next report starts, it begins with all of the parameters that are specified in the original JDE and JDL invoked by specifications on the user interface windows.

Many DJDEs have parameters that specify the same things as JDL command parameters. If one of these parameters is not specified in a DJDE but is specified in the current JDE or JDL, the JDE or JDL value remains in effect.

The following figure shows the usage of a single record DJDE and the IDEN command.

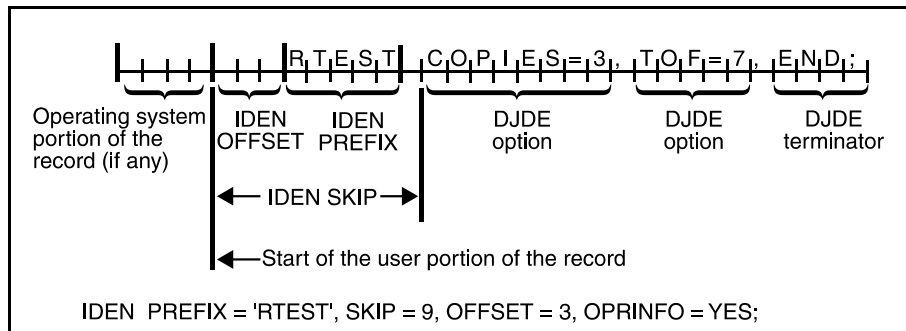

Figure 5-1. Single record DJDE diagram and IDEN command

The following is an example of a multiple record DJDE.

DJDE packet in data stream:

```
*MTEST C MULTI-RECORD DJDE EXAMPLE;
*MTEST FORMS=(XEROX1,1,3), FORMAT=XPDE12,
FONTINDEX=1, NUMBER=(3,15,55);
*MTEST COPIES=20,COLLATE=YES, ASSIGN=(1,5),
ASSIGN=(5,32);
*MTEST FONTS=((P0612A),(P0812A));
*MTEST ASSIGN=(12,63), TOF=5, BOF=66;
END;
```

Command in JSL:

```
IDEN PREFIX='MTEST', SKIP=7, OFFSET=1,
OPRINFO=YES;
```

DJDE operator information pages

The specification OPRINFO=YES in the JDE specifies that the DJDE records will be printed and sent to the output bin at the next page transition after an END command. The DJDE records are printed on a separate page from the report data. However, no page formatting occurs and DJDEs in long records are truncated at the end of the physical page boundary.

You can use comments in the DJDE for operator notification or output routing instructions in conjunction with the OPRINFO parameter. These information pages are printed and delivered to the bin regardless of the OPRINFO parameter if the DJDE contains an error, unless you disable the information pages on the user interface Queue Manager windows.

Messages on OPRINFO pages

- **Error messages.** Error messages are printed on the OPRINFO pages, close to where the errors occurred. These messages indicate syntax errors and unsupported DJDEs, and give the initial character position of the invalid text string or DJDE coding.
- **Missing END command or page boundary.** The following message is automatically printed on an OPRINFO page at the end of a report if the END parameter or a page boundary is not detected:

```
***MISSING END COMMAND OR MISSING PAGE BOUNDARY***
```

The following conditions produce the message.

- No END parameter is found in the DJDE.
- No complete page boundary was found before the end of the report; that is, at the end of report there were some DJDEs that had not yet been applied.

Duplex processing of OPRINFO pages

When the system is printing duplex, the text for OPRINFO pages is printed only on the front side of the sheet. Each OPRINFO page is processed as duplex page with a blank back. The blank side is counted as a printed sheet by the system in its statistics for the duplex report.

In a job for which OPRINFO was specified, if DJDEs are included at the page boundary of the front side of a duplex page, the DJDE data skips the back side of the sheet and is printed on the front of the next sheet.

Restrictions on job parameter modification

To process a DJDE, the system must process data up to the recognition and interpretation of the DJDE itself. This sequence requires that the basic description of the input source must be correct before the application of the DJDE. Therefore, you must not change the description of the input source with DJDEs, either by accident or by intent.

The system also does not allow certain basic parameters to be changed through the selected JDE (the JDE specified by the JDE DJDE).

NOTE: CODE changes to data may occur and take effect on the page boundary following the DJDE record. If a translation code change is involved in a selected JDE, the parameter portion of any subsequent DJDE must be in the new code. The prefix used by the IDEN must, however, retain the original hexadecimal value. Thus, if the CODE changes from EBCDIC to ASCII, the prefix must remain in EBCDIC even though the parameter portion changes to ASCII.

Parameters that cannot be changed through a JDE DJDE

The parameters that cannot be changed through a JDE that is specified in the JDE DJDE are listed in the following table.

Table 5-1. Parameters that are not changeable by a JDE DJDE

Command	Parameters
BANNER	All parameters
BLOCK	All parameters
IDEN	All parameters except OPRINFO
OUTPUT	OFFSET
RECORD	All parameters except LENGTH
VOLUME	HOST

Parameters that can be changed through a JDE DJDE The parameters that can be changed through a JDE that you specify in a JDE DJDE are listed in the following table.

Table 5-2. Parameters that are changeable by a JDE DJDE

Command	Parameters
ABNORMAL	—
ACCT	All parameters
IDEN	OPRINFO only
LINE	DATA, FONTINDEX, MARGIN, OVERPRINT, PCCTYPE, VFU
MESSAGE	All parameters
OUTPUT	All parameters except OFFSET
PDE	All parameters
RAUX	All parameters
RDELETE	—
RECORD	LENGTH
RFEED	—
ROFFSET	All parameters
ROUTE	All parameters
RPAGE	All parameters
RRESUME	—
RSELECT	—
RSTACK	TEST
RSUSPEND	—
STOCKSET	—
VOLUME	TCODE, CODE

NOTE: If a front cover is invoked in a selected JDE that takes effect after the first page of the report, the cover appears at the point where the DJDE is applied.

Considerations and cautions for using DJDEs

Remember the following points and cautions when coding and applying DJDEs.

Page transition issue

If you use the JDE DJDE to reassign the channel that caused the page transition (generally channel 1), when the DJDE printer carriage control (PCC) byte is processed the first page may be incorrectly positioned after the page transition occurs. Page oriented DJDEs, like the JDE DJDE, are implemented when the system detects the switch from one physical page to the next. The normal page transition is caused by a skip from the bottom of a page to the top of the next, generally channel 1.

For example, if channel 1 had been previously assigned at line 1, then a new JDE assigned channel 1 to line 10, the system would not automatically reposition to line 10.

Solution

Here are some ways to avoid this problem.

- You may add an ASSIGN DJDE to the DJDE packet to change the applicable channel, such as channel 1, to the new line number. Because the ASSIGN DJDE is a record oriented DJDE, it is implemented on the next line and thus affects the next channel skip.
- You may insert a record after the DJDE packet to cause the page transition and then allow a second skip to channel 1 to position to the correct line. This technique causes a blank page to be printed if the new channel 1 is less than the old, but is totally transparent if the new channel 1 assignment is greater (further down the page) than the old.

Duplex DJDE page printing issues

When certain DJDEs (listed below) are invoked between an odd numbered page (front side) and an even numbered page (back side), the following printing sequence occurs.

The odd numbered page is printed as usual, but with a blank back side. What would have been printed on the back side (the even numbered page) is printed on the front of the next sheet. This occurs for the following DJDEs:

- COPIES
- OTEXT
- RTEXT

- JDE
- JDL
- DUPLEX=NO
- FEED

Effect of multiple logical pages

If you use multiple PDE BEGIN commands to define multiple logical pages on one physical page (as described in the PDE command description in the “Specifying print format parameters” chapter), consider the following:

- With the exception of DEPT and SHIFT, all page oriented DJDEs are applied at a logical page boundary.
- The following DJDEs cause the current page position to be set to the first logical page of the front side of a new physical sheet:
 - DUPLEX
 - COPIES
 - JDL
 - JDE
 - OTEXT
 - RTEXT
 - FEED
- The following DJDEs cause the current page position to be set to the first logical page of the next physical side:
 - FORMS
 - FORMAT
 - BEGIN
 - PMODE
 - FONTS

Header pages and online DJDEs

If an online job has header pages only (no trailers), DJDEs that are invoked within a report remain in effect for the first header page of the following report; however, they do not remain in effect beyond the end of that header page. These conditions occur because the end of the first report is not detected until the first header page of the following report is received and processed.

Printer carriage control and DJDEs Printer carriage control processing may differ if it is associated with DJDEs. Use of certain PCC parameters in conjunction with DJDEs affects what those parameters do. The following table shows what to expect from those PCC parameters when DJDEs are present.

Table 5-3. Interaction of DJDEs with printer carriage control parameters

Carriage control parameter	Processing with DJDE
Print and Skip (online)	Treated as a Skip Immediate carriage control parameter. <ul style="list-style-type: none">• If the printer is not at the channel specified, a skip occurs.• If the printer is at the specified channel, no skip occurs unless the last carriage control parameter received was a Print Without Spacing parameter.
Print and Space	Ignored
Print Without Spacing	Ignored
Print and Skip (offline)	Ignored

Types of DJDEs

There are two types of DJDEs: page oriented and record oriented.

Page oriented DJDEs Page oriented DJDEs change the look of subsequent pages within a report, and can change these pages differently on different copies.

- If DJDE parameters are placed within the report itself, they take effect at the next page boundary. (They can take effect on the current page if no data has yet been printed on it.)

- If DJDEs are located at the start of a report, they invoke changes beginning with the first page of the report (or report copy).

Table 5-4. Page oriented DJDEs

DJDE	Function
BEGIN	Specifies the location of the starting print line of each logical page.
BFORM	Specifies that a form will be printed on the back side of each printed page.
COLLATE	Specifies whether the pages of a job are to be collated (placed into sets ordered the way the pages are printed) or uncollated (all copies of a page are placed together).
COPIES	Specifies the number of copies of the pages (also called <i>sets</i>) to produce.
DEPT	Specifies the name under which accounting statistics for reports are accumulated. <i>NOTE: The DP 2000 Series EPS place this information in the accounting log. You can print out the values.</i>
DESTINATION	Specifies the output destination of printed pages.
DUPLEX	Specifies whether both sides of a piece of paper are printed (duplex) or only the top side (simplex). (Simplex and duplex are also called “1-sided” and “2-sided.”)
FEED	Controls the stock on which pages are printed.
FONTINDEX	Specifies the location in the input record where an index to the specified font is stored.
FORMAT	Specifies the fonts used for printing.
FORM[S]	Specifies a new page descriptor entry (PDE) to use for formatting control.
FORM[S]	Specifies the form to be merged onto the printed pages.
ICATALOG	Specifies an ink catalog that contains palettes and inks for subsequent pages.
IDFAULT	Specifies a default ink for objects for which no ink was specified.
IDR	Specifies the ink descriptor reference (IDR) that will be used for subsequent pages.
ILIST	Specifies a list of all the inks that may be referenced by the ink index on the page.
INKINDEX	Specifies a field within a data record that contains a number representing the ink index in the current ILIST.
INVERT	Specifies that the subsequent page content will be inverted 180 degrees on the physical page.

Table 5-4. Page oriented DJDEs (Continued)

DJDE	Function
ITEXT	Specifies a text message that will be displayed to operators during processing.
JDE	Specifies the JDE to be used within the selected JDL at the next page boundary.
JDL	Specifies the name of the JDL to be invoked at the next page boundary.
MAP	References a previously created font mapping file.
MARGIN	Specifies the left printing margin within each logical page.
MODIFY	Specifies the CME to be used on each subsequent logical page.
NUMBER	Specifies page numbering control.
OTEXT	Provides a text message to be displayed to the operator during job printing.
PALETTE	Specifies the palette of inks that will be used for subsequent pages.
PMODE	Specifies the printing mode for each page (either landscape or portrait).
RFORM	Specifies whether a form is printed on all RTEXT pages.
RTEXT	Specifies text to be printed on a separate page preceding each report copy.
SEFMAP	Specifies a font mapping table.
SHIFT	Specifies a shift of page image (page content) for binding purposes.
SF1FUNCTION	Specifies sheet finisher function number 1 through the DFA channel C6.
SF2FUNCTION	Specifies sheet finisher function number 2 through the DFA channel C7.
SIDE	Specifies the repositioning of the next logical page to the first logical page position of the given side of a physical sheet of paper.
STOCKS	Redefines the parameters of a STOCKSET command (the types of stocks to use) for the page.
TMODE	Specifies process direction measurement for determining default pitch modes. <i>NOTE: This feature is not supported by the Nuvera MX series printers.</i>
TRANS	Specifies whether transparencies are used in the print job.
XSHIFT	Allows shifting in the x direction for short edge binding.

Record oriented DJDEs Record oriented DJDEs take effect immediately at the next record following the last record of the packet (set) of DJDE records of which they are a part. After an END parameter, a compiled record oriented DJDE takes effect immediately.

NOTE: The exception is the OVERPRINT DJDE, which takes effect at the next logical page boundary if FONTINDEX has been invoked in a JDE or DJDE.

Record oriented DJDEs also may appear at report boundaries to change subsequent pages in a report (or report copy).

Table 5-5. Record oriented DJDEs

DJDE	Function
ASSIGN	Assigns a VFU channel to one or more line numbers on the logical page.
BOF	Specifies the Bottom of Form (BOF) line number.
C (<i>text</i>)	Allows comment text in the DJDE record.
DATA	Specifies the location and length of printable data within an input record.
END	Specifies the end of DJDE information.
EOF	Stops downloading of a sixel encoded file to the system disk.
FILE	Enables files to load onto the system disk while a print job is in progress.
LOGO	Specifies the name and location of logos that will be printed on pages of a report.
LPI	Specifies the line spacing values for each subsequent line.
OVERPRINT	Provides instructions to the system for handling overprint lines (print lines whose carriage control specifies printing with no line spacing after the last printed line).
TOF	Specifies the Top of Form (TOF) line number.

The following table lists record oriented DJDEs that are used with graphics.

Table 5-6. Record oriented DJDEs for graphics

DJDE	Function
ALTER	Specifies the new imaging parameters for graphics.
BATCH	Delimits Batch mode graphic data to permit normal processing of online banner pages for Batch mode jobs.
CANCEL	Cancels the hold specified by the H parameter in a GRAPHIC or IMAGE DJDE.
FDATA	Specifies the offset of the starting point of file data from the beginning of the user portion of the record.
GDATA	Specifies the offset of the starting point of graphic data from the beginning of the user portion of the record.
GRAPHIC	Specifies that the DJDE is a graphic sentinel.
SAVE	Specifies that image (.IMG) files that were updated during the current report will not be purged when processing of the report is complete.

DJDE descriptions

The following sections give the definition, syntax, and options for each available DJDE.

ALTER DJDE

Specifies new imaging parameters for graphics previously referenced using the HOLD (automatic reimaging) parameter.

Type Record oriented graphic

Syntax ALTER = (*name*, *vpos* [*units*], *hpos* [*units*] [, *n* [/d]] [, (INK[S], *inkref*₁ [, *inkref*₂]...))

Options

Table 5-7. ALTER DJDE options and definitions

Option	Definition
<i>name</i>	Identifies a previously specified graphic that is currently subject to the HOLD parameter of the command that specifies it. Refer to the "IMAGE DJDE" section later in this chapter.
<i>vpos</i>	<i>vertical position.</i> Specifies the vertical position of the top edge of the graphic, relative to 0,0 on the current physical page
<i>hpos</i>	<i>horizontal position</i> Specifies the horizontal position of the left edge of the graphic relative to 0,0 on the current physical page. The form of the specification (UN, CM, IN, DOTS, or XDOTS) is the same as for <i>vpos</i> .
<i>n/d</i>	<i>numerator / denominator</i> Specifies the reference scale factor. Each DJDE, <i>n</i> and <i>d</i> , must be an integer in the range of 1 to 8, thereby allowing a reference scale factor in the range of 1/8 to 8. The reference scale factor is multiplied.
<i>unit</i>	Unit of measure for the vertical and horizontal positions. Options are: <ul style="list-style-type: none"> • CM (centimeters) • IN (inches) • DOTS • XDOTS • UN (user defined units). <p>If UN is specified, the user defined positioning unit must previously be defined by the UNITS parameter of the OUTPUT command in the current JDE or JDL.</p> <p><i>NOTE: IN and CM are each specified as a decimal number with up to three digits to the right of the decimal point.</i></p> <p>The default unit is IN.</p>

ALTER DJDE: point to note

ALTER maintains the GRAPHICS HOLD parameter in effect but also specifies a new set of imaging parameters for the current and subsequent pages.

Examples of ALTER DJDE

```
ALTER= (BUS, 5, 5, 1) ;
ALTER= (IMG, 1, 3, 5) , END;
```

ASSIGN DJDE

Specifies an assignment of a VFU channel number to a page line number or set of line numbers.

Type Record oriented

Syntax ASSIGN= (*channo*, *lineno*)

or

ASSIGN = (*channo*, (*lineno*₁ [, *lineno*₂] [, ...]))

Options

Table 5-8. ASSIGN DJDE options and definitions

Option	Definition
<i>channo</i>	<i>channel number.</i> The number of the channel being assigned. It is an integer in the range 0 to 12.
<i>lineno</i>	<i>line number.</i> The number of the output print line being assigned to a particular channel. It is an integer in the range TOF to BOF.

ASSIGN DJDE: points to note

- ASSIGN DJDEs take effect at the next record following an END DJDE. DJDEs affect only those channels for which assignments have been specified. Other channels remain the same.
- It is possible to have multiple ASSIGN parameters within a DJDE.
- The ASSIGN parameters are the same as for the VFU command ASSIGN parameter described under PDL Reference.

BATCH DJDE

Permits normal processing of online banner pages for Batch mode jobs by delimiting the Batch mode graphic data.

Type Record oriented graphic

Syntax BATCH = {START | END}

Options

Table 5-9. BATCH DJDE options and definitions

Option	Definition
START	Marks the beginning of online Batch mode data.
END	Marks the end of online Batch mode data.

BATCH DJDE: points to note

- The BATCH DJDE is supported for online Batch mode jobs only.
- This DJDE must be used precisely to mark the beginning and ending of online Batch mode data.
 - The first graphic (or IMAGE DJDE) must be preceded immediately by a BATCH=START DJDE.
 - The last graphic must be followed immediately by a BATCH=END DJDE.
- The BATCH DJDE, when specified, must be the only DJDE in the packet.

BEGIN DJDE

Specifies the location of the starting print line of a logical page.

Type Page oriented

Syntax BEGIN = (*vpos* [*units*], *hpos* [*units*])

Options

Table 5-10. BEGIN DJDE options and definitions

Option	Definition
<i>vpos</i>	Specifies the vertical position of the first character of the first print line on the logical page.
<i>hpos</i>	Specifies the horizontal position of the first character of the first print line on the logical page.
<i>units</i>	Unit measure for the horizontal and vertical positions. It may be specified in inches (IN), centimeters (CM), or DOTS. The default is IN.

BEGIN DJDE: points to note

- All specifications for *vpos* and *hpos* are rounded to the nearest dot (1/300 of an inch) for positioning of the logical page. Specifications must be a decimal number with no more than three digits to the right of the decimal point; for example, 0.563 IN or 2.35 CM.
- In specifying the location of the beginning of a print line on the logical page, you measure while viewing the page in the orientation (landscape or portrait) in which it will be printed.
- You may have more than one logical page per physical page. Use multiple BEGIN DJDEs to define multiple logical pages.

BFORM DJDE

Specifies that a form will be printed on the back side of a page (must have DUPLEX=YES). It takes effect at the next front-to-back-side page transition encountered. BFORM DJDEs are the same as for the OUTPUT command.

Type Page oriented

Syntax BFORM= {NONE | (*formid* [, *init* [,*copies*]] [, (INKS, *inkref*₁ [,*inkref*₂] ...))}}

Options

Table 5-11. BFORM DJDE options and definitions

Option	Definition
NONE	Specifies that no form will be added to the associated report page of variable data. When NONE is specified in combination with other BFORM options, it takes precedence over the other BFORM options, so that no forms are printed.
<i>formid</i>	<i>form identifier</i> Specifies a filename for a form that exists on disk. This form file is created with forms creation software on a workstation or with Forms Description Language (FDL) on another type of LPS.
<i>init</i>	<i>initial copy</i> Specifies the first copy number to which a specified form applies. <i>NOTE: For the DP 2000 Series EPS, any init specification greater than 1 is ignored. The form that appears on the first copy appears on all subsequent copies.</i>
<i>copies</i>	Specifies the number of plies (passes) to which a specified form applies. Default is all copies of the report.
INKS	Indicate that ink references follow.
<i>inkref</i>	<i>ink reference</i> Identifies an ink that overrides the corresponding ink specified in the ink list of a colored form. If the form does not contain an ink list, the form is printed in black. <i>NOTE: If one ink reference from the ink list is omitted, a comma must be used in its place in order to maintain the relative positions of the remaining ink references.</i> <i>If more ink references are specified than the number of inks in the ink list, the extra inkrefs in the DJDE are ignored.</i>

BFORM DJDE: points to note

- Multiple BFORM DJDEs may be specified to place different BFORMS on different copies.
- Multiple instances of the BFORM DJDE right part syntax (shown in the Syntax section for this DJDE) may be provided enclosed in parentheses and separated by commas. For example:

BFORM=(*bform1*, *bform2*, *bform3*); or
BFORM= ((*bform1*, 1, 2),) (*bform2*, 3, 1));

The following syntax specifies that no back form will be added to any copy:

BFORM=(*bform1*, NONE, *bform3*)

BOF DJDE

Specifies the Bottom Of Form (BOF) line number. It takes effect at the next record following an END DJDE.

Type Record oriented

Syntax BOF = *value*

Options

Table 5-12. BOF DJDE options and definitions

Option	Definition
<i>value</i>	Specifies the number of lines from the top of the output page to the last print line on the page (Bottom Of Form).

BOF DJDE: points to note

- If Bottom Of Form (BOF) is altered by DJDE to a line number smaller than the current line from which the DJDE was processed, Input forces an immediate page transition.
- If the carriage control action to perform at BOF is specified as OVR (the default), processing spaces from TOF a number of lines equal to the difference between the location of the current line and the new BOF. Refer to the “PCC command” section in the “Specifying input parameters” chapter for information regarding alternate carriage control options.
- The *value* is defined in the same manner as the BOF parameter of the VFU command.

C (text) DJDE

Allows you to include comment text in the DJDE record.

Type Record oriented

Syntax C *text*

Options

Table 5-13. C (text) DJDE options and definitions

Option	Definition
<i>text</i>	The actual text of the comment

C (text) DJDE: points to note

- When you are coding the C *text* DJDE, the C must be followed by a **space** (not by an equal sign).
- Any text following the keyword up to a semicolon (unless the semicolon is enclosed in parentheses) or the End Of Record is treated as commentary.
- On the DP 2000 Series EPS, commas are treated as delimiters and not as ordinary text.
- If the system does not encounter an END parameter at the end of a C DJDE record, a syntax error is declared.

CANCEL DJDE

Cancels, effective on the current page, the hold (automatic reimaging) specified by the H parameter of an IMAGE or GRAPHIC DJDE.

Type Record oriented graphic

Syntax CANCEL = {(*name*₁ [, *name*₂] [, ...]) | ALL}

Options

Table 5-14. CANCEL DJDE options and definitions

Option	Definition
<i>name</i>	Identifies the graphic being held.
ALL	Specifies that all graphics being held are to be cancelled.

COLLATE DJDE

Specifies Collated or Uncollated mode for printing.

Type Page oriented

Syntax COLLATE = {YES | NO}

Options

Table 5-15. COLLATE DJDE options and definitions

Option	Definition
YES	Specifies that report copies are to be printed in Collated Mode. (Copies are printed in complete, ordered sets.)
NO	Specifies that report copies are to be printed in Uncollated Mode. (All copies of each page are printed and stacked together; that is, all copies of page 1 are printed first, then all copies of page 2, etc.)

COLLATE DJDE: point to note

The COLLATE DJDE takes effect at the next page boundary but must occur before the first data record of the report.

COPIES DJDE

Specifies the number of copies of a report to produce.

Type Page oriented

Syntax COPIES = *number*

Options

Table 5-16. COPIES DJDE options and definitions

Option	Definition
<i>number</i>	Number of copies of a report to produce.

COPIES DJDE: points to note

- In duplex processing, if COPIES appears before the back side of a duplex page, a blank back sheet is output, and the print data continues on the next front page.
- If COPIES=0 is specified for a page, that page is not printed.
- If *number* is set to zero, this copy count remains in effect until a new copy count or End Of Report is encountered. DJDEs encountered while *number* is set to zero are processed normally.
- The number of copies specified in the DJDE overrides the number of copies in the OUTPUT command.

DATA DJDE

Specifies the location and length of printable data within an input record.

Type Record oriented

Syntax DATA = (*pdo*, *length*)

Options

Table 5-17. DATA DJDE options and definitions

Option	Definition
<i>pdo</i>	<i>Print data offset.</i> Number of bytes between the start of the user portion of the record and the first character of the record to be printed.
<i>length</i>	Specifies the maximum length of printable data within each logical record.

DATA DJDE: point to note

The DATA DJDE takes effect at the next record following an END DJDE.

DEPT DJDE

Defines the name under which accounting statistics will be accumulated for this report.

Type Page oriented

Syntax DEPT = *sc*

Options

Table 5-18. DEPT DJDE options and definitions

Option	Definition
<i>sc</i>	<i>string constant.</i> Represents a department code or name under which accounting information is maintained. May be up to 31 characters.

DEPT DJDE: points to note

- The *sc* name should already have been created in the accounting file prior to processing the job.
- This parameter is ignored by the DP 2000 Series EPS. It is included here for compatibility purposes. Refer to the “PDL commands and DJDE summary” in Appendix A for information on which Xerox printers support each command and DJDE.

DESTINATION DJDE

Determines the delivery destination of the printed output.

Type Page oriented

Syntax DESTINATION = {BIN | TRAY | EXPORT}

Options

Table 5-19. DESTINATION DJDE options and definitions

Option	Definition
BIN	Specifies delivery to the currently active output bin.
TRAY	Specifies delivery to the sample tray. <i>NOTE: Use caution when selecting the sample tray because of its limited capacity.</i>
EXPORT	Specifies that sheets will be sent to the bypass transport.

DESTINATION DJDE: points to note

- Transparencies should be sent only to the sample tray.
- EXPORT is honored only if the bypass transport is specified on the LCDS Setup window as the output destination.

DUPLEX DJDE

Specifies whether printing is to occur on both sides of a page (duplex mode) or a single side (simplex mode). The choice takes effect on the next page boundary.

Type Page oriented

Syntax DUPLEX = {YES | NO}

Options

Table 5-20. DUPLEX DJDE options and definitions

Option	Definition
YES	Specifies that printing will occur on both sides of a sheet. (This is also called "two-sided printing.")
NO	Specifies that printing will occur on only the front side of the sheet. (This is also called "one-sided printing.")

END DJDE

Specifies the end of a DJDE packet. When an END DJDE is encountered, the system applies all DJDE information specified to the current printing environment at the next page or record boundary.

Type Record oriented

Syntax END;

END DJDE: points to note

- After the system detects an END parameter, record oriented DJDEs take effect immediately. Page oriented DJDEs take effect at the current page if no data has been printed. If data has been printed, page oriented DJDEs take effect at the next page transition.
- If a delimiter other than a comma was used before the END DJDE, a syntax error is displayed. A comma is required for the system to properly process the END DJDE.

EOF DJDE

Stops downloading of a sixel-encoded file to the system disk (used in conjunction with the FILE DJDE.) Note that EOF is followed by a comma, then a semicolon.

Type Record oriented

Syntax EOF,;

EOF DJDE: point to note

When the EOF DJDE is combined with the FILE DJDE, the END DJDE is not required.

FEED DJDE

Controls the stock on which the page is printed.
 “FEED=*stockreference*” must refer to a stock assigned to a ‘*stockname*’ by the STOCKSET command in effect at the time the page is printed.

Type Page oriented

Syntax FEED = {MAIN | AUX | OPR | ‘*stockname*’ | *stockreference*}

Options**Table 5-21. FEED DJDE options and definitions**

Option	Definition
AUX	Specifies that the page will feed from the tray(s) assigned to the AUX stock.
MAIN	Specifies that the page will feed from the tray(s) assigned to the MAIN stock.
OPR	Equivalent to MAIN
‘ <i>stockname</i> ’	Specifies the name of the stock from whose assigned tray or trays the next sheet will feed for printing. (Must be placed in single quotation marks.) This option bypasses the reference feature, but still requires that the stockname be specified as it appears in the current STOCKSET. (FEED= <i>stockreference</i> is the recommended usage.)
<i>stockreference</i>	Specifies the term (usually descriptive) that has been associated with the stock from whose assigned tray or trays the next sheet will feed for printing. This option allows you to change stocks associated with a job without altering the stock references in the data application itself.

FDATA DJDE

Specifies the starting point of the file data from the beginning of the user portion of a data record.

Type Record oriented

Syntax FDATA = *offset, termination*

Options

Table 5-22. GDATA DJDE options and definitions

Option	Definition
<i>offset</i>	The starting point within the record of the file data that will be downloaded.
<i>termination</i>	The terminating byte of the record. The options are: <ul style="list-style-type: none"> • DEFAULT <ul style="list-style-type: none"> – If online, a single terminating byte exists. – If offline, no terminating byte exists. • <i>n</i>: The number of terminating bytes that exist

FILE DJDE

Enables you to load files to the system disks while a print job is in progress. The print job may be invoked solely for the purpose of downloading permanent files. (Although intended primarily for use with online systems, this DJDE is not restricted to online use.)

Type Record oriented

Syntax FILE = ([*filename*] [[, *filetype*] [[, *f*] [[, *s*] [[, *n*]]]])

Options

Table 5-23. FILE DJDE options and definitions

Option	Definition
<i>filename</i>	A 1 to 6 character name used to identify the downloading file. In this option, lowercase characters a through z are converted to uppercase before use.
<i>filetype</i>	A 3 character file extension identifier, indicating the type of file being downloaded. In this option, lowercase characters a through z are converted to uppercase before use.
<i>f</i>	File input format parameter. The only parameter that is supported for the DP 2000 Series EPS is as follows: L = LPS labeled tape format The default file input format is L.
<i>s</i>	One of the following file storage parameters: <ul style="list-style-type: none"> • D = Delete after report printed • P = Permanent The default file storage is P.

Table 5-23. FILE DJDE options and definitions (Continued)

Option	Definition
<i>n</i>	Rounded up to a multiple of 6, specifies the maximum number of card images to be processed for this file. The default number is 120. <i>NOTE: This option is ignored by DP 2000 Series EPS systems, which do not support card image files.</i>

FILE DJDE: points to note

- For LPS labeled files, the FILE DJDE may be specified as follows:

```
FILE= ( )
```

In this case, the file name and file type are obtained from the label record that precedes the file data.

- If the *filename* or *filetype* specified in the FILE DJDE differs from those in the label record, the file is renamed as specified in the DJDE.
- If the maximum number of records is encountered, the processing of the file is completed. Additionally, for card image data, the FILE DJDE must be specified as follows to indicate the end of card image data:

```
FILE=( , , C) or FILE=(END, , C)
```

- The DELETE DJDE and the FILE DJDE with the DELETE option allow you to remove the following types of files only: .IMG, .FRM, .LGO, .FNT, .CME, .JDL, .PDE, and .TST.

FILE DJDE processing

File replacement and deletion

If a disk file with the specified file name already exists in the “lcds” resources folder (accessible via either the `/var/spool/XXnps/resources/lcds/` or the `/opt/XXnps/resources/lcds/` directory path), the disk file is superseded by the new one. However, the existing file is not replaced immediately. If the new file will be retained beyond the scope of the current report processing (as indicated by the `s` [storage] parameter of the FILE DJDE), the new file is stored in the “lcds” folder and replaces existing files there, at the end of the report.

Files that are transferred with a D (delete) option are deleted as soon as the report is processed, and therefore must not be referenced in a subsequent report.

NOTE: The FILE DJDE does not allow a file to be replaced if the file is a system permanent file. System permanent files have a \$ in their names.

Card image file processing

When card image files are transferred, the following occurs:

1. The system checks the FILE DJDE for valid parameters, and responds to errors as follows:
 - If the destination filetype is not acceptable for a card image file, the preceding DJDE packet is printed on an OPRINFO page with an error message that indicates the file type is wrong. The system then proceeds to read and discard the extent of the file.
 - If the file name is improperly specified, the preceding DJDE packet is printed on an OPRINFO page with an error message that indicates that the file name is wrong. The system then proceeds to process the data as variable text data.
 - If the system reads more card image records than the maximum number of card images specified by the DJDE, it discards the extra records. The preceding DJDE packet is printed on an OPRINFO page with an error message indicating that the excess card file images were lost.
 - If the file cannot be created due to insufficient space on the disk, the preceding DJDE packet is printed on an OPRINFO page with an error message indicating there is not enough space on the disk for the file being downloaded. The system then proceeds to read and discard the file.
2. The system makes an appropriate amount of disk space available for the file. If the file contains errors that preclude printing or storage, the system discards the file.
3. The system reads the card image file records. When the system reads a card image file record, it uses record delimiters (if any) to determine record length. Only the data portion of a record is used for file processing.

Records with a length greater than 80 bytes are truncated to 80 bytes; records with a length less than 80 bytes are padded with ASCII blanks to 80 bytes. Character translation may be performed, depending on the JDE in effect.

4. The system terminates record processing for the card image being downloaded when another DJDE record is encountered.
 - If a DJDE record is encountered and one or more card image records have been written in the file, the file is truncated to an appropriate size and closed. If OPRINFO=YES, a message is listed on an OPRINFO page, indicating that a file has been created and giving the name of the new file.
 - If a DJDE record is encountered before any card image records have been filed, the null file is deleted, and the preceding DJDE packet is printed on an OPRINFO page with an error message indicating that the file "*FILENAME*" has no card image data.
5. The printing system completes file processing.

NOTE: Card image files that have the type extensions listed below are not supported on the DP 2000 Series EPS:

- *.CMD*
- *.MSC*
- *.PCH*
- *.TMP*
- *.TPF*

When the system encounters any of these types of files specified within a FILE DJDE, it logs an "invalid file type" error, which is handled according to the specification by the ABNORMAL ERROR parameter in the JDL.

LPS labeled file processing

When LPS labeled files are transferred, the following occurs:

1. The system checks the FILE DJDE for valid parameters, reads the LPS label record at the beginning of the file, and responds to errors as follows:

- If the first record does not meet the requirements for a label record, the preceding DJDE packet is printed on an OPRINFO page with an error message indicating that no label record was found. The system then proceeds to process the data as variable text data.
 - If the file cannot be created due to insufficient space on the disk, the preceding DJDE packet is printed on an OPRINFO page with an error message indicating that there is not enough space on the disk to download the file. The system then proceeds to read and discard the file.
2. If the destination file type is acceptable, the system obtains the file size field from the label record and calculates the extent of the file.
 3. The file name and file type that appear in the label block are converted to uppercase characters.
 4. The system creates the file. If a file with the same name was created as a result of earlier processing of this report, the earlier copy of the file is replaced. Otherwise, a new copy is created.
 5. The system reads the file data records and stores them in the file until the total extent of the file is spanned. The system ignores record delimiters, and processes only the data portion of the file.
 - If the FILE= () signaled the start of LPS labeled data, the system assumes that more than one LPS labeled file may be batched together, and checks for another label record when it completes processing a file.
 - If OPRINFO=YES and the file transfers are successfully concluded, the file name and file type of each transferred file are listed on the OPRINFO page with a brief indication of whether the file was newly created or replaced an existing file.

**Delimited records
for LPS labeled
files**

To prevent loss of data through trailing blank suppression procedures on the host spooler, data records for LPS labeled files must be delimited by appending an extra non-blank character at the end of each record. The same non-blank character must be used with all records processed during the file processing period.

If the nonblank character that is appended at the end of the records is not consistently present throughout the file, the preceding DJDE packet is printed on an OPRINFO page with an error message indicating that processing for the file "*FILENAME*" is being aborted due to a data error.

The system then deletes the partial file that was created and proceeds to process the data as variable text data.

Refer to the "LPS tape label format" section of Appendix D for information on the structure of LPS labeled tape.

File readiness Files may be used by the LCDS processor as soon as they are written to the "lcmds" folder on the system disk. However, the files become effective only when they are referenced by a DJDE. For example, a font or form file becomes effective at the next page boundary when a DJDE specifies the *FORMAT* or *FORMS* parameter to invoke the new font or form file. If a file was downloaded earlier in the report and has since been replaced, the new file is not used until it is reinvoked by an appropriate DJDE.

FONTINDEX DJDE

Specifies a location in the input record of an index into the current font list. The font found in the list at the position indicated by the index is used for printing.

Type Page oriented

Syntax FONTINDEX = {*offset* | (*offset* [, *initval* [, *bitopt*]]) | NONE}

Options

Table 5-24. FONTINDEX DJDE options and definitions

Option	Definition
<i>offset</i>	Indicates the byte offset in the data record where the font index number is located. Refer to the "LINE OVERPRINT" parameter section in the "Specifying print format parameters" chapter for a discussion of FONTINDEX usage with overprint lines and maximum number of fonts.
<i>initval</i>	<i>initial value.</i> Index number associated with the first font in the font list (that is, the number the font list starts with). This value can be one of the following: <ul style="list-style-type: none"> • ONE specifies that an index value of 1 is associated with the first font in the font list. • ZERO specifies that an index value of 0 is associated with the first font in the font list, an index value of 1 is associated with the second font in the font list, and so forth. The default for the initial font index value is ONE.
<i>bitopt</i>	<i>bit option</i> A numeral specifying the number of low order bits within the font index byte, which, in turn, specifies an index value into the font list of the current PDE. The <i>bitopt</i> value may be 1 through 7. The default <i>bitopt</i> value is 4.
NONE	Specifies that there is no font index.

FONTINDEX DJDE: points to note

- The FONTINDEX DJDE takes effect at the next logical page boundary.
- The FONTINDEX DJDE options are the same as for the LINE FONTINDEX command).
- Because there is ambiguity between the FONTINDEX and FONTS keywords, if either is abbreviated to the first three letters, the keyword defaults to FONTINDEX.
- When multiple fonts of various sizes are used on a single page, the line spacing of any particular line is determined by the largest font in use in the previous line. The current line can also be adjusted downward by the difference in height between the first and the largest font in the current line. The line spacing of the first line in a report is determined by the first font in the PDE, provided the FONTINDEX JDL command or DJDE has not been specified.

When FONTINDEX is specified, the line spacing of the first line of a report is determined by the font indicated by the font index value in the first line of the report. If there is no font index value in the record and FONTINDEX is specified, the line spacing for the first line of the report is determined by the first font in the PDE.

When the FONTINDEX or CMEs are specified, the line spacing of the first line of subsequent pages is determined by the line spacing of the font called out by the last font index of the previous page applied to the current font list.

If a FORMAT DJDE has occurred before the page transition, the font used for the line spacing comes from this list.

FONTS DJDE

Specifies the fonts to be used in printing variable input data or CME data.

Type Page oriented

Syntax `FONTS = {(f1[, f2] [,...]) | ((f1, s1[, unit]) [, (f2, s2 [, unit]) [, ...])}` or
`FONTS = (sbf [, s1 [unit]]) [, ...] [(dbf [*vn [*hn]] [, s1 [unit]] [, {Ai | DBi | Ki}] [, c1 [unit]]) [, ...]]`

Options

Table 5-25. FONTS DJDE options and definitions

Option	Definition
<i>f</i>	font. Specifies a one to six alphanumeric character identifier (consisting of at least one letter) corresponding to a font catalogued on the system disk.
<i>sbf</i>	single byte font. Specifies a one to six alphanumeric character identifier (consisting of at least one letter) corresponding to a single byte font catalogued on the system disk.
<i>dbf</i>	double byte font. Specifies a one to six alphanumeric character identifier (consisting of at least one letter) corresponding to a double byte font catalogued on the system disk.
<i>i</i>	index. Specifies the font index for a double byte character set. Can be 1 through 8.

Table 5-25. FONTS DJDE options and definitions (Continued)

Option	Definition
K or DB	Indicate a double byte font.
A	Indicates a 1/2 or 1/4 sized double byte font.
* <i>hn</i>	Specifies the factor (an integer value from 1 through 16) by which the font will be magnified horizontally. Default: 1
* <i>vn</i>	Specifies the factor (an integer value from 1 through 16) by which the font will be magnified vertically. Default: 1
<i>s</i>	<i>spacing.</i> Specifies an optional override line spacing value defined by either the print lines per inch (LPI) or the dots per print line (DOTS or XDOTS) associated with the font. Maximum value for s_1 is 30 LPI; minimum value is 10 dots.
<i>c</i>	Specifies an optional override character spacing value, either characters per inch or dots per character, to be associated with a double byte font.
<i>unit</i>	A unit of measure for the override line or character spacing to be associated with a font. The unit can be one of the following: <ul style="list-style-type: none"> • CPI (characters per inch) Used only with the <i>c</i> option. • LPI (lines per inch) • DOTS (dots per print line at 300 dpi) • XDOTS (dots per print line at 600 dpi) The default unit is LPI.

FONTS DJDE: points to note

- The FONTS DJDE takes effect at the next page boundary.
- You can use up to 128 fonts with the font indexing capability. If the number of fonts to be invoked exceeds the size of one DJDE record, you must use multiple FONTS parameters.
- If different fonts are used on the same print line, character heights of all fonts used in the print line are compared to find the largest font in the line. The line spacing value defined for that font (or specified as an override for it) is used to determine the position of the next print line.
- An xdot is 1/600 unit of measurement. A form specifying xdots can be created, edited, and compiled on any LPS with version 3 or higher software. However, the 600 spi form does not print on DP 2000 Series EPS systems, which accept only 300 spi jobs.

- Because there is ambiguity between the abbreviated forms of the FONTINDEX and the FONTS DJDEs, if either is abbreviated to the first three letters, DJDE processing presumes FONTINDEX.
- If there are more than 128 fonts in a DJDE packet, a syntax error occurs, and the FONTS DJDE is ignored.
- If any font in the font list is missing, a syntax error occurs and the FONTS DJDE is ignored.

FORMAT DJDE

Specifies an entirely new page descriptor entry (PDE) to be used for formatting control. It takes effect on the next page boundary.

Type Page oriented

Syntax FORMAT = *PDEid*

Options

Table 5-26. FORMAT DJDE options and definitions

Option	Definition
<i>PDEid</i>	<i>page descriptor entry identifier</i> Name of the new PDE being invoked by this DJDE. This PDE is a separate file in the "lcds" resources folder on the system disk.

FORMAT DJDE: points to note

- Parameters of the selected PDE, such as BEGIN, FONTS, and PMODE, may also be modified on an individual basis. (The DJDEs that are specified separately override the parameters that are part of the PDE.)
- Format file names must be in all UPPERCASE letters when they are referenced in DJDEs, or the system will not detect them. (However, format file names may have lowercase letters in the JSL commands and parameters.)

FORM[S] DJDE

Specifies the form to be merged onto the printed pages. It takes effect on the next page boundary. The form specified is invoked beginning with the specified starting copy number. Multiple FORMS DJDEs may be used to associate different forms with different copy plies.

Type Page oriented

Syntax FORM[S] = {NONE | *formid* | (*formid* [, *init* [, *copies*]]) [, (INKS, *inkref*₁ [, *inkref*₂] ...))}

NOTE: When using this command, you must enter an entire parameter: FORM or FORMS. Do not abbreviate to the first three letters, because system interprets "FOR" as FORMAT.

Options**Table 5-27. FORM[S] DJDE options and definitions**

Option	Definition
<i>formid</i>	Specifies a 1 to 6 character form file name (may be numeric, alpha, or alphanumeric), which exists on the system disk.
<i>init</i>	If two or more forms are called out in succession, <i>init</i> specifies the first copy number to which the next form applies. This defaults to the first or next copy. If the <i>copies</i> parameter is not specified, the last (or only) specified form applies to all copies beginning with the <i>init</i> copy number. If the form is not the last one that is specified, <i>copies</i> defaults to 1. If neither <i>init</i> nor <i>copies</i> is specified, the form applies to all copies of all data pages of the report.
<i>copies</i>	Specifies the number of copies to which the form applies.
NONE	Means that no form is added to the associated report page of variable data.

FORM[S] DJDE: point to note

Because there is ambiguity between the abbreviated forms of the FORMAT and the FORM[S] DJDEs, if either is abbreviated to the first three letters, DJDE processing presumes FORMAT.

GDATA DJDE

Specifies the starting point of the graphic data from the beginning of the user portion of a data record.

Type Record oriented

Syntax GDATA = *offset, termination*

Options**Table 5-28. GDATA DJDE options and definitions**

Option	Definition
<i>offset</i>	The starting point within the record of the graphic data that will be downloaded.
<i>termination</i>	The terminating byte of the record. The options are: <ul style="list-style-type: none"> • DEFAULT <ul style="list-style-type: none"> – If online, a single terminating byte exists. – If offline, no terminating byte exists. • <i>n</i>: The number of terminating bytes that exist

GRAPHIC DJDE

Specifies that the DJDE is a graphic sentinel. That is, it immediately precedes and identifies a graphic in the report data stream.

NOTE: This DJDE, when specified, must be the only DJDE in its packet.

Type Record oriented

Syntax GRAPHIC = (*name, vpos [units], hpos [units], [,H] [,n [/d]] [, (INKS, inkref₁ [, inkref₂])])*)

(If no other DJDEs are specified, the parentheses may be omitted.)

Options

Table 5-29. GRAPHIC DJDE options and definitions

Option	Definition
<i>name</i>	Identifies the graphic. If document interleaved, it becomes the file name with which the .IMG file is written. If page interleaved, it is used to associate the graphic with other DJDE references.
<i>vpos</i>	<i>vertical position.</i> Specifies the amount of vertical spacing of the top edge of the graphic from 0,0 on the physical page.
<i>hpos</i>	<i>horizontal position.</i> Specifies the horizontal spacing of the left edge of the graphic from 0,0 on the current physical page.
<i>units</i>	Unit of measure for the vertical and horizontal positions of the graphic. The following may be used: <ul style="list-style-type: none"> • UN (unit defined by the user) • CM (centimeters) • IN (inches) • DOTS • XDOTS (DOTS for 600 spi processing) If UN is specified, the user defined positioning unit must be previously defined by the OUTPUT UNITS command in the current JDE or JDL. The default positioning unit is IN.
H	HOLD Specifies that the same graphic is to be held and imaged without further callouts at the same position and with the same scale factor at all subsequent pages until changed by a DJDE CANCEL or ALTER DJDE.
<i>n/d</i>	<i>numerator/denominator</i> Specifies the reference scale factor. Each option, <i>n</i> and <i>d</i> , must be an integer in the range of 1 to 8, thereby allowing a reference scale factor in the range of 1/8 to 8. The reference scale factor is multiplied by the internal scale factor of the image.
INKS	Specifies that the ink references that follow will override the inks that were defined in the image file.
<i>inkref</i>	<i>ink reference</i> Specifies the inks that override the corresponding inks specified in the ink list of the image file.

GRAPHIC DJDE: points to note

- Other than *name*, none of the parameters may be used if the specified graphic is document interleaved, nor should *name* normally be used if the graphic is referenced by an IMAGE DJDE.

If the graphic is page interleaved, the remaining parameters may be used exactly as on the IMAGE DJDE (except for the T parameter). If these parameters are specified in the GRAPHIC DJDE and also on one or more IMAGE DJDEs that reference the same graphic, the graphic is imaged on the page once for each reference.

- **Document and page interleaved graphics:** If no textual data has been previously encountered, the graphic specified in the GRAPHIC DJDE is document interleaved and is copied to a .IMG type disk file.

If textual data has been encountered previously, the graphic is page interleaved and the previous print record should have caused a page transition. If not, the occurrence of this DJDE forces an immediate page termination, and the next print record encountered is processed relative to TOF (Top of Form) on the next physical page.

An interleaved graphic that immediately follows a header banner page is treated as document interleaved. The header banner page must be defined by a BANNER command. Skip carriage control commands on a graphics sentinel DJDE are ignored.

- **Graphic file replacement and deletion:** If an image file with the specified name already exists in the “lcds” resources directory, it is superseded by the new one. However, it is not replaced immediately. If a new file will be retained beyond the scope of the current report processing (as indicated by the OUTPUT PURGE parameter or the SAVE DJDE), the new file is stored in (and replaces existing files in) the “lcds” resource folder when processing of the report is complete.

NOTE: The “lcds” folder can be accessed from either of the following Unix directory paths:

/var/spool/XRXnps/resources/lcds/

or

/opt/XRXnps/resources/lcds/

- If inks are used:
 - If one *inkref* in the list is omitted, commas must be used as place holders to maintain the relative positioning of the remaining ink references.
 - If more than two ink references are specified, the additional ink references are ignored.

ICATALOG DJDE

Specifies an ink catalog that contains palettes and inks for subsequent pages.

Type Page oriented

Syntax ICATALOG = '*ink catalog name*'

Options

Table 5-30. ICATALOG DJDE options and definitions

Option	Definition
<i>'ink catalog name'</i>	Name of the ink catalog that will be used on the page. Note that the ink catalog name is specified within single quotes.

ICATALOG DJDE example

ICATALOG = 'DEFAULT'

IDFAULT DJDE

Specifies the default ink that will be used for objects whose ink is not specified. An example of this usage is page numbers whose color is not specified in an OUTPUT NUMBER parameter or the NUMBER DJDE.

Type Page oriented

Syntax IDFAULT = '*inkref*'

Options

Table 5-31. IDFAULT DJDE options and definitions

Option	Definition
<i>'inkref'</i>	<i>ink reference</i> The default ink that will be used for all objects that do not specify an ink.

IDFAULT DJDE: point to note

Only saturated primary colors can be specified by this DJDE.

IDR DJDE

Specifies the ink descriptor entry that will be used for subsequent pages. Refer to the “IDR command” section in the “Specifying print format parameters” chapter for an explanation of what is defined in an IDR.

Type Page oriented

Syntax IDR = *idrname*

Options

Table 5-32. IDR DJDE options and definitions

Option	Definition
<i>idrname</i>	<i>ink descriptor reference name</i> The name of the IDR (previously defined by an IDR command in the JSL) that will be used for subsequent pages.

ILIST DJDE

Specifies a list of all the inks that may be referenced by the ink index on the page.

Type Page oriented

Syntax ILIST = *'inkname'* | (*'inkname₁'*, [*'inkname₂'*] [, ...])

Options

Table 5-33. ILIST DJDE options and definitions

Option	Definition
<i>'inkname'</i>	Specifies an ink name that will be part of the ILIST that is defined for the page. Note that the ink name is specified within single quotes.

ILIST DJDE example

```
ILIST = ('BLACK', 'XEROX.RED')
```

IMAGE DJDE

In Batch mode, this DJDE defines new imaging parameters for subsequent graphics. In all other modes, it defines imaging parameters for the named graphic.

Type Record oriented

Syntax IMAGE = (*imgname*, *vpos* [*units*], *hpos* [*units*] [,T] [,H] [, *n* / [*d*]] [, (INKS, *inkref*₁ [, *inkref*₂]))

Options

Table 5-34. IMAGE DJDE options and definitions

Option	Definition
<i>imgname</i>	<p><i>image name</i></p> <p>The name of an .IMG file or the name on the DJDE sentinel record of a page interleaved graphic immediately following the current page, such as GRAPHIC=<i>name</i>). Lowercase characters a through z are converted to uppercase.</p> <p>The <i>name</i> parameter may be omitted in Batch mode; however, the comma before <i>vpos</i> must be coded, because it is a positional parameter.</p>
<i>vpos</i>	<p><i>vertical position</i>.</p> <p>Specifies the vertical position of the top edge of the graphic as a downward offset relative to 0,0 on the current physical page. (This is the position that would be specified by a PDE BEGIN of 0,0 and a PDE PMODE value, PORTRAIT or LANDSCAPE, that is currently in effect).</p> <p>Specified as a decimal number with up to three digits to the right of the decimal point and may be followed by a space and the <i>units</i> indicator.</p> <p>NOTE: The default value for the <i>vpos</i> parameter is 0.</p>

Table 5-34. IMAGE DJDE options and definitions (Continued)

Option	Definition
<i>hpos</i>	<i>horizontal position.</i> Specifies the horizontal position of the left edge of the graphic, as a rightward offset, relative to 0,0 on the current physical page. Specified as a decimal number with up to three digits to the right of the decimal point and may be followed by a space and the <i>units</i> indicator. <i>NOTE: The default value for the hpos parameter is 0.</i>
<i>units</i>	Specifies the unit of measure for the vertical and horizontal positions of the image on the page. Available units are: <ul style="list-style-type: none"> • DOTS • CM (centimeters) • IN (inches) • UN (user defined unit) • XDOTS (DOTS at 600 spi) If UN is specified, the user defined positioning unit must be previously defined by the OUTPUT UNITS command in the current JDE or JDL. The default positioning unit is IN.
H	HOLD Specifies that the same graphic is to be held and imaged without further callouts, at the same position and with the same scale factor on all subsequent pages until changed by a DJDE CANCEL or ALTER.
T	PAGE INTERLEAVED (Type of graphic) Specifies that the referenced graphic is page interleaved and follows the current page data in the input stream.
<i>n / d</i>	<i>numerator / denominator.</i> Specifies the reference scale factor. Each parameter, <i>n</i> and <i>d</i> , must be an integer in the range of 1 to 8, thereby allowing a reference scale factor in the range of 1/8 to 8. The reference scale factor is multiplied by the scale factor specified at the time the graphic was digitized and the product is rounded to the nearest integer in the range 1 to 8. That integer becomes the effective scale factor with which the graphic is imaged.
INKS	Specifies that the ink references that follow will override the inks that were defined in the image file.
<i>inkref</i>	<i>ink reference</i> Specifies the inks that override the corresponding inks specified in the ink list of the image file.

INKINDEX DJDE

Specifies a field within a data record that contains a number that represents the ink index in the current ILIST.

Type Page oriented

Syntax INKINDEX = {*offset*, [ZERO | ONE] [, *bitopt*] | NONE}

Options

Table 5-35. INKINDEX DJDE options and definitions

Option	Definition
<i>offset</i>	Indicates the byte offset in the data record where the ink index number is located.
ZERO	Specifies that the first ink in the list is referenced with an index value of 0.
ONE	Specifies that the first ink in the list is referenced with an index value of 1.
<i>bitopt</i>	<i>bit option</i> Specifies the number of bits that should be used in calculating the ink index. The range is 1 through 7. The default <i>bitopt</i> value is 4.
NONE	Specifies that there is no ink index.

**INKINDEX DJDE:
point to note**

If inks are used:

- If one *inkref* in the list is omitted, commas must be used as place holders to maintain the relative positioning of the remaining ink references.
- If more than two ink references are specified, the additional ink references are ignored.

INVERT DJDE

Specifies that the subsequent page content will be inverted 180 degrees when printed on the physical page. Portrait oriented text is printed as inverse portrait, landscape text is printed as inverse landscape, and vice versa.

Type Page oriented

Syntax INVERT = {FRONT | BACK | BOTH | NONE}

Options

Table 5-36. INVERT DJDE options and definitions

Option	Definition
FRONT	Specifies page inversion on front sides.
BACK	Specifies page inversion on back sides.
BOTH	Specifies page inversion on both front and back sides.
NONE	Specifies no page inversion.

IRERESULT DJDE

Specifies what the result will be when objects that are imaged with different inks overlap.

Type Page oriented

Syntax IRESULT = {DEFAULT | BLACK | COLOR}

Options

Table 5-37. IRESULT DJDE options and definitions

Option	Definition
DEFAULT	Specifies that the ink that was set as the system default IRESULT ink will override when two different colored pixels overlap. The default IRESULT ink may be black or colored. <i>NOTE: On the FreeFlow Print Server-based DT 128/155/180 HLC Printing Systems, the default is Black.</i>
BLACK	Specifies that, when two objects that are imaged with different inks overlap, and black and colored pixels coincide, the resulting pixel is black.
COLOR	Specifies that, when two objects that are imaged with different inks overlap, and black and colored pixels coincide, the resulting pixel is colored.

IRERESULT DJDE: points to note

- For monochrome printers, the COLOR and BLACK parameters produce identical results (black).
- The color that results from overlapping objects may be only black or only colored for an entire page. For example, a page cannot have red text printed over a black background and also black text printed over a red background.

- If more than one IRESULT is specified on a page, the last instance takes precedence.
- The FreeFlow Print Server-based DT 128/155/180 HighLight Color Printing Systems have queue settings for this option; the default setting is Black.

ITEXT DJDE

Specifies a text message to be displayed to the operator during input processing.

Type Page oriented

Syntax ITEXT = {NONE | *sc*}

Options

Table 5-38. ITEXT DJDE options and definitions

Option	Definition
NONE	Specifies that no text message is displayed to the operator during input processing.
<i>sc</i>	<i>string constant.</i> Specifies a text message of up to 80 characters.

ITEXT DJDE: points to note

- The ITEXT DJDE takes effect at the next page boundary.
- The options for the ITEXT DJDE are the same as for the MESSAGE ITEXT parameter described under output format parameters.

JDE DJDE

Specifies the JDE to be used within the current or selected JDL at the next page boundary.

Type Page oriented

Syntax JDE = *JDEid*

Options

Table 5-39. JDE DJDE options and definitions

Option	Definition
<i>JDEid</i>	<i>Job Descriptor Entry identifier.</i> Name of the JDE that will be used within the current or selected JDL at the next page boundary. This is called the “selected JDE.”

JDE DJDE: points to note

- The new JDE that is specified in the JDE DJDE ***JDEid*** parameter is the “selected JDE.”
- In a DJDE packet containing a JDE DJDE, other record or page oriented DJDEs included in the packet override parameters specified in the indicated JDE. Refer to “Restrictions on job parameter modification” section earlier in this chapter for further information.
- If only a JDE DJDE (no JDL DJDE) is specified in the DJDE packet, the system uses the JDL most recently specified in a DJDE in this report. If no JDL was specified in any DJDE, the system uses the JDL that is specified on the LCDS Setup window.

JDL DJDE

Specifies the JDL to be invoked at the next page boundary.

Type Page oriented

Syntax JDL = *JDLid*

Options

Table 5-40. JDL DJDE options and definitions

Option	Definition
<i>JDLid</i>	<i>Job Descriptor Library identifier</i> Name of the JDL to be invoked at the next page boundary.

JDL DJDE: points to note

- The *JDLid*.JDL file must exist on the print server disk.
- If there is no delimiter between the JDL DJDE and the JDL identifier (*JDLid*), a syntax error is displayed.
- If only a JDL DJDE (no JDE DJDE) is specified in the DJDE packet, the system uses the JDE most recently specified in a DJDE in this report. If no JDE was specified in any DJDE, the system uses the JDE that is specified on the LCDS Setup window.
- In a DJDE packet containing a JDL DJDE, other record or page oriented DJDEs override parameters specified in the indicated JDL.
- Record length for the job does not change when a JDL is switched by a JDL DJDE.

LOGO DJDE

Specifies the name and location of logos that will be printed on a page or on all pages of a report.

Type Record oriented

Syntax $\{(name, vpos [units], hpos [units] [, H] [, (INKS, inkref_1 [, inkref_2])]) | (name, HERE [, (VADJ, \{+ | -\} tvalue [units])]) [, (HADJ, \{+ | -\} tvalue [units])]) [, H] [, (INKS, inkref_1 [, inkref_2])])\}$

Options

Table 5-41. LOGO DJDE options and definitions

Option	Definition
<i>name</i>	Name of a logo that will be imaged.
<i>vpos</i>	<i>vertical position</i> Specifies the vertical position of the top edge of the logo, as a downward offset, relative to 0,0 on the current physical page (the position that would be specified by a PDE BEGIN of 0,0 and a PDE PMODE value, PORTRAIT or LANDSCAPE, that is currently in effect).
<i>hpos</i>	<i>horizontal position</i> Specifies the horizontal position of the left edge of the logo, as a rightward offset, relative to 0,0 on the current physical page.

Table 5-41. LOGO DJDE options and definitions (Continued)

Option	Definition
<i>units</i>	<p>Specifies the unit of measure for the vertical and horizontal positions of the logo on the page. Available units are:</p> <ul style="list-style-type: none"> • DOTS • CM (centimeters) • IN (inches) • UN (user defined unit) • XDOTS (DOTS at 600 spi) <p>If UN is specified, the user defined positioning unit must be previously defined by the OUTPUT UNITS command in the current JDE or JDL. The default positioning unit is IN.</p>
H	<p>HOLD Specifies that the logo that is invoked by the DJDE will be held and imaged without further callouts and at the same position on all subsequent pages until it is canceled by a CANCEL DJDE. A logo that is specified in a DJDE appears only on the current page unless the H option is specified. <i>NOTE: If any character other than H, or any additional character, is detected in the fourth parameter position of this command, the system declares a syntax error.</i></p>
HERE	<p>Specifies that the upper left corner of the logo will be positioned at, or relative to, the top of the next printed line, and the current left margin.</p>
HADJ	<p>HORIZONTAL ADJUSTMENT Specifies that an adjustment will be made to the horizontal position of the left edge of the logo, relative to the position defined by the HERE option.</p>
VADJ	<p>VERTICAL ADJUSTMENT Specifies that an adjustment will be made to the vertical position of the left edge of the logo, relative to the position defined by the HERE option.</p>
+ –	<p>Specifies a positive or negative positioning of the tvalue. When following HADJ, + shifts the logo to the right, and – shifts it to the left. When following VADJ, + shifts the logo downward on the page and – shifts it upward.</p>
<i>tvalue</i>	<p>Specifies the amount of the adjustment signaled by the HADJ or VADJ parameter for a logo on the page. May be specified in inches (IN), centimeters (CM), user defined units (UN), DOTS, or XDOTS (600 spi dots). The default unit is IN.</p>
INKS	<p>Specifies that the ink references that follow will override the inks that were defined in the image file.</p>
<i>inkref</i>	<p><i>ink reference</i> Specifies the inks that override the corresponding inks specified in the ink list of the image file.</p>

LOGO DJDE: points to note

- Any logos specified in a selected JDE (the JDE that was specified in the JDE DJDE) replace those from the original JDE. If none are specified in the selected JDE, logos from the original JDE are canceled.
- If the logo that is specified in the Initial JDE is not found, the job aborts and an error message is displayed. If a logo that is specified after the start of the job is not found, the system response is determined by the specifications in the ABNORMAL ERROR parameter.
- The HERE keyword must be included whenever the VADJ or HADJ options are coded. Otherwise, a syntax error occurs.
- If inks are used:
 - If one *inkref* in the list is omitted, commas must be used as place holders to maintain the relative positioning of the remaining ink references.
 - If more than two ink references are specified, the additional ink references are ignored.

LPI DJDE

Specifies the values for the vertical spacing between subsequent lines.

Type Record oriented

Syntax LPI = {(*linespacing* [*units*], DEFAULT) | (*linespacing* [*units*], *lineno*, (...))}

Options

Table 5-42. LPI DJDE options and definitions

Option	Definition
<i>linespacing</i>	<i>lines per inch</i> Specifies the line spacing value. May be measured in:
<i>units</i>	Unit of measure for the amount of vertical line space. The options are: <ul style="list-style-type: none"> • LPI (lines per inch) • DOTS • XDOTS (600 dpi) The default unit is LPI.

Table 5-42. LPI DJDE options and definitions (Continued)

Option	Definition
<i>lineno</i>	<p><i>line number</i> Specifies the line number or numbers over which the line spacing will be applied. The options are:</p> <ul style="list-style-type: none"> • <i>n</i> Number of the line to which the specified <i>linespacing</i> will be applied • <i>n-</i> Number of the line from which the specified <i>linespacing</i> will be applied through BOF (bottom of form). • <i>n-m</i> The specified <i>linespacing</i> will be applied from line <i>n</i> through line <i>m</i>.

LPI DJDE: point to note

If LARGE[ST] was specified for the LINE BASELINE parameter, the LPI DJDE is ignored.

MAP DJDE

References a font mapping file (*FILENAME.LIB*) previously created using a compiled SEFFNT command.

Type Page oriented

Syntax MAP = *FILENAME*

Options**Table 5-43. MAP DJDE options and definitions**

Option	Definition
<i>FILENAME</i>	Name of the font mapping file to be used.

MARGIN DJDE

Specifies the left printing margin within each logical page. It takes effect at the logical page following an END DJDE.

Type Page oriented

Syntax MARGIN = *value* | [*value*, *valuetype*]

Options

Table 5-44. MARGIN DJDE options and definitions

Option	Definition
<i>value</i>	Specifies the distance from the left edge of the logical page (as indicated by the BEGIN value currently in effect) to the left margin. Has the format <i>nnn.mm</i> (a positive decimal number with up to 2 digits to the right of the decimal point).
<i>valuetype</i>	Unit of measure for the margin value. Available unit options are: <ul style="list-style-type: none"> • IN (inches) • CM (centimeters) • POS (character positions) The default value type is POS.

MARGIN DJDE: points to note

- A value must be specified as an integer (*nnn*), if its *valuetype* is character positions (POS).
- The options for the MARGINS DJDE are the same as for the LINE MARGIN command.

MODIFY DJDE

Specifies a copy modification entry (CME) to be used in report processing.

Type Page oriented

Syntax MODIFY = {(*cmeid* [, *init* [, *copies*]] | NONE}
or
MODIFY = *cmeid*

Options

Table 5-45. MODIFY DJDE options and definitions

Option	Definition
<i>cmeid</i>	<i>copy modification entry identifier</i> References a previously created CME file (<i>filename.cme</i>). The default is NONE.
<i>init</i>	<i>initial copy</i> Specifies the first copy of the report to which the CME will be applied. If <i>init</i> is not specified, the CME is applied to all copies.

Table 5-45. MODIFY DJDE options and definitions (Continued)

Option	Definition
<i>copies</i>	Specifies the number of plies (passes) on which to apply the CME. If <i>copies</i> is not specified, then the CME applies to all copies beginning with the copy number specified by <i>init</i> .
NONE	Specifies that no CMEs will be applied; data is processed without modification.

MODIFY DJDE: points to note

- Any CME invoked by a DJDE must be catalogued separately. Refer to the “Catalogued CMEs” section in the “Specifying print format parameters” chapter for further information.
- The MODIFY DJDE takes effect at the next logical page boundary.
- The MODIFY DJDE parameters are the same as those for the OUTPUT MODIFY command.
- For the DP 2000 Series EPS, copy variant CMEs (also called “copy sensitive CMEs”) are not supported. Multiple copy output yields duplicate copies of copy 1. Only the CME that applies to copy 1 appears, and it appears on all copies.

NUMBER DJDE

Specifies page number properties and occurrence. This DJDE takes effect at the next logical page boundary.

Type Page oriented

Syntax NUMBER = {(*pnum*, *Inum*, *cnum* [, [*findex*] [,*inkref*]]) | NO}

Options

Table 5-46. NUMBER DJDE options and definitions

Option	Definition
<i>pnum</i>	<i>page number</i> An integer that specifies the starting page number. The maximum page number that can be printed is 2,147,483,647.
<i>inum</i>	<i>line number</i> An integer that specifies the number of the line on which the page number is placed
<i>cnum</i>	<i>column number</i> An integer that specifies the final column (character space) number for the page numbering sequence
<i>findex</i>	<i>font index</i> This is an index into the list of fonts specified in the currently active FONTS parameter of the PDE command, or of a recent DJDE. The index is an integer starting with 1 for the first font. If an index is not specified, the first font in the list is used.
<i>inkref</i>	<i>ink reference</i> Specifies the reference number for the ink with which the page number will be printed.
NO	Specifies that there will be no page numbering.

NUMBER DJDE: point to note

- The beginning page number may be nonpositive, in which case it is incriminated at page transitions but is not printed until it is positive.
- If the system encounters a NUMBER DJDE immediately after the criteria that were specified for the RSTACK command were met in the input data stream, page numbering starts on the next page (after the delimiter sheet) and with the page number 1 printed on it. Refer to the examples in the following figure.

LPS systems:

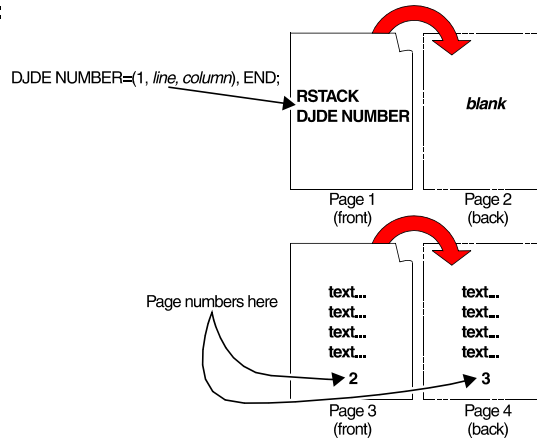

DP 2000 Series EPS:

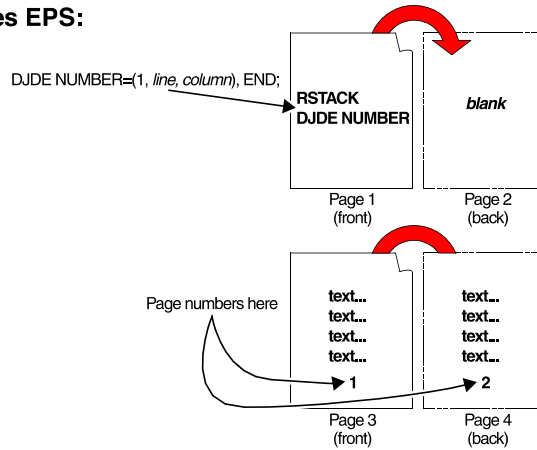

Figure 5-2. Page numbering when NUMBER DJDE immediately follows RSTACK DELIMITER criteria

- The options for the NUMBER DJDE are the same as for the NUMBER parameter of the OUTPUT JSL command.

NUMBER DJDE example

```
NUMBER= (1, 1, 40, 1) , END;
```

OTEXT DJDE

Specifies a text message to be output to the operator during job printing. It takes effect on the next page boundary.

Type Page oriented

Syntax OTEXT = {(sc [, {passnum | END}] [,WAIT]) | NONE}
 or
 OTEXT = sc

Options

Table 5-47. OTEXT DJDE options and definitions

Option	Definition
NONE	Specifies that no text message is output to the operator during printing.
sc	<i>String Constant.</i> The text of the message that will be output to the operator. The message may have up to 80 characters, with a maximum of 400 characters per report.
passnum	<i>pass number.</i> Specifies the number of the pass (copy ply) to which the text applies. Multiple sc messages, one per passnum, may be specified in a JSL. The message is output to the operator immediately before the next page on the specified report ply starts printing. If no pass number is specified, the text is output only once, when the page begins to print.
WAIT	Suspends printing after the message is output, until the operator has responded by selecting or pressing a Continue button.
END	Displays the message text after the last copy of the report is printed.

OTEXT DJDE: point to note

The DJDE parameters are the same as for the MESSAGE OTEXT command.

OVERPRINT DJDE

Specifies how overprint lines are handled. (Overprint lines are print lines whose carriage control specifies printing with no line spacing because the last printed line.)

Type Record oriented

Syntax OVERPRINT = (*overopt*, *disp*)

Options**Table 5-48. OVERPRINT DJDE options and definitions**

Option	Definition
<i>overopt</i>	<p><i>overprint option.</i></p> <p>This option has the following choices:</p> <ul style="list-style-type: none"> • PRINT: Specifies that all overprint lines are printed as they would be on an impact printer; that is, the second line is printed over the top of the first with no regard to the previous data, including character spacing, which may vary between the two lines of data. • IGNORE: All overprint lines are ignored. • MERGE: Same as PRINT except when used with FONTINDEX or CME processing. Refer to “OVERPRINT DJDE: points to note” below. • PRINT2: Specifies that up to two consecutive lines are printed per line—one line and one overprint. Other overprints for the line are ignored.
<i>disp</i>	<p>(Obsolete)</p> <p>This option has the following components:</p> <ul style="list-style-type: none"> • DISP • NODISP <p><i>NOTE: This option is not functional on DP 2000 Series EPS. It is preserved here for compatibility with other Xerox laser printing systems. The number of overprint lines is always printed on the accounting page.</i></p>

OVERPRINT DJDE: points to note

- The OVERPRINT DJDE normally takes effect on the next record following an END DJDE. If FONTINDEX has been invoked in a JDE or DJDE, OVERPRINT takes effect at the next logical page boundary.
- OVERPRINT options are the same as for the LINE OVERPRINT parameter.
- **FONTINDEX and OVERPRINT:** When used in conjunction with OVERPRINT, FONTINDEX is handled as follows:
 - For OVERPRINT=PRINT, the printing system overprints records analogously to an impact printer if the fonts are the same size. If the fonts differ, records are overprinted without regard to character spacing.
 - For OVERPRINT=MERGE, the system replaces blank characters in the previously printable line, if this print record overprints the line. Character spacing values are adjusted; thus, proportionally spaced or different size fonts may be used, and the system performs the character placement.

Blank characters in the previous printable line are replaced only when they are translated using the CODE table into an ASCII X'20' or into a character value greater than that of the highest character in the specified font.

PALETTE DJDE

Specifies the ink palette that will be used for subsequent pages.

Type Page oriented

Syntax PALETTE = '*palette name*'

Options

Table 5-49. PALETTE DJDE options and definitions

Option	Definition
' <i>palette name</i> '	Specifies the palette to be used on the page. Note that the palette name is specified within single quotes.

PALETTE DJDE example

PALETTE = 'SIMPLE'

PMODE DJDE

Specifies the text orientation for each page.

Type Page oriented**Syntax** PMODE = {LANDSCAPE | PORTRAIT}**Options****Table 5-50. PMODE DJDE options and definitions**

Option	Definition
LANDSCAPE	Indicates that print lines will be parallel to the long edge of the paper (for paper loaded with its short edge facing the feed direction). Print lines on 11 by 17 inch paper are parallel to the short edge.
PORTRAIT	Indicates that print lines will be parallel to the short edge of the paper (for paper loaded with its long edge facing the feed direction). Print lines on 11 by 17 inch paper are parallel to the long edge.

PMODE DJDE: point to note

If PMODE is changed through a DJDE, the BEGIN DJDE should be respecified (even if the same horizontal and vertical positions were specified in the previous BEGIN DJDE).

RFORM DJDE

Specifies a form to be printed with all RTEXT pages. It takes effect on the next RTEXT page. The options are the same as for the ROUTE RFORM command.

Type Page oriented**Syntax** RFORM = {*formid* [, (INKS, *inkref*₁ [, *inkref*₂])] | NONE}

Options

Table 5-51. RFORM DJDE options and definitions

Option	Definition
<i>formid</i>	<i>form identifier.</i> Name of the form to be printed with all RTEXT pages. References a previously created form file (FILENAME.FRM).
NONE	Specifies that no form will be printed with RTEXT pages.
INKS	Specifies that the inks that follow will be used for the forms.
<i>inkref</i>	Identifies the inks that override the corresponding inks that are specified in the ink list of the form. If a form does not contain an ink list, the form is printed in black.

RFORM DJDE: points to note

- The RFORM parameter is not allowed in a ROUTE command that is being defined as a catalogued file. However, you may specify it in the ROUTE command in the JSL invoking the catalogued RTEXT file, or you can specify it via the RFORM DJDE. Refer to the “ROUTE RTEXT” parameter section in the “Specifying print format parameters” chapter for further details.
- Forms may be created using forms creation software on a workstation, or by compiling a file of forms source commands, called an FSL, with the FDL compiler on another type of LPS.
- **For colored forms:** If an *inkref* that is on the ink list is omitted from the command, commas must be used to maintain the relative positioning of the remaining ink references.

If more than two *inkrefs* are specified, the system ignores the additional *inkrefs*.

RTEXT DJDE

Specifies text to be printed on a separate page preceding a report. It takes effect on the next page boundary.

The parameters for the RTEXT DJDE are the same as for the ROUTE RTEXT command.

Type Page oriented

Syntax RTEXT = {NONE | *sc* | (*sc* [, {*passnum* | ALL} [, *line* [, *col* [, *fontindex*]]]]) | *rtextid*}

Options

Table 5-52. RTEXT DJDE options and definitions

Option	Definition
<i>sc</i>	<i>string constant</i> Specifies the message to be printed (a string of 1 to 132 characters). It is printed with the first font specified in the FONTS parameter of the PDE command. Refer to the <i>fontindex</i> option in this table.
<i>passnum</i>	<i>pass number</i> An integer specifying the single copy (pass) to which the text applies. If there are two or more RTEXT parameters in a ROUTE command, <i>passnum</i> must be in increasing numeric order.
ALL	Specifies that the text applies to all copies.
<i>line</i>	Specifies the line number on which the first line of a block of RTEXT message is printed. To avoid overprinting, only one RTEXT parameter may be specified per line for a <i>passnum</i> . The default is line 1 for the first text string of the pass. Otherwise, the default is the next line of the page.
<i>col</i>	<i>column.</i> Specifies the column number at which the first character of a block of RTEXT messages is to be printed. The default is column 1.
<i>fontindex</i>	Identifies the index (starting with 1) of the PDE font with which the text is printed.
<i>rtextid</i>	<i>route text identifier</i> Used to reference a catalogued file of RTEXT parameters previously compiled by XJDC. A file of the type .TST is referenced.
NONE	Specifies that no text is to be printed on a separate page.

RTEXT DJDE example

```
RTEXT= ( ' TEST' , ALL , 15 , 5 , 2 ) ;
END;
```

SAVE DJDE

Specifies that image (.IMG) files that were updated during the current report will not be purged when processing of the report is completed.

For specific files, this DJDE overrides automatic file deletions that are specified by the OUTPUT PURGE=YES parameter within the JDE.

Type Record oriented

Syntax SAVE = {*filename* | (*filename* [, ...]) | ALL}

Options

Table 5-53. SAVE DJDE options and definitions

Option	Definition
<i>filename</i>	Name of an .IMG file that will not be purged.
ALL	Specifies that all document interleaved files created by processing of this report are to be saved, overriding an explicit (or default) specification in the OUTPUT command within the JDE.

SAVE DJDE: point to note

The SAVE DJDE must occur before or at the end of the report.

SEFMAP DJDE

On a page by page basis, specifies a font mapping table for short edge feeding. This overrides the SEF table that is defined in the SEFFNT SEFMAP parameter within the JSL.

Type Page oriented

Syntax SEFMAP = {{{(*font*₁, *font*₂) [, (*font*_m, *font*_n)]...[, {UPD | REP}}] | NONE}

Options

Table 5-54. SEFMAP DJDE options and definitions

Option	Definition
$(font_1, font_2)$	Font pair, where $font_2$ is the SEF mapping for $font_1$.
$(font_m, font_n)$	Font pair, where $font_n$ is the SEF mapping for $font_m$.
UPD	UPDATE Indicates that the specified font pairs change existing font mappings or appending new mappings to the current font mapping table.
REP	REPLACE Indicates that the specified font pairs create a new mapping table to replace the current one.
NONE	Disables short edge feeding (SEF) and font mapping (stops a previous SEFFNT specification).

SEFMAP DJDE: points to note

- UPD and REP options affect only memory resident font mapping tables (not disk resident tables such as those found in JDLs).
- If you want to use 11 by 17 inch, A4, or any size paper that requires short edge feed, be aware that the system does not scale or rotate form, logo, and image files. The graphic file must be created in the desired orientation.
- A SEFMAP DJDE that is in the data stream is processed whether or not the JDL contains short edge feed commands.

SEFMAP DJDE examples

Following are examples of how the SEFMAP DJDE works.

Example 1:

```
SEFMAP= ((font1, font7), (font5, font6), UPD);
```

Before the SEFMAP DJDE shown above was encountered, the contents of the memory font mapping table were:

```
((font1, font2), (font3, font4))
```

After the SEFMAP DJDE is processed, the contents of the memory font mapping table are:

```
((font1, font7), (font3, font4), (font5, font6))
```

Example 2:

```
SEFMAP=((font1,font7), (font5,font6),REP);
```

Before the above SEF DJDE was processed, the contents of the memory font mapping table were:

```
((font1,font2), (font3,font4))
```

After this SEFMAP DJDE is processed, the contents of the memory font mapping table are:

```
((font1,font7), (font5,font6))
```

SF1FUNCTION DJDE

Specifies to the third party finisher whether or not it should perform the user defined SF1 operation on the current sheet.

The SF1FUNCTION DJDE invokes the C6 signal of the electronic interface between the printing system and a third party finishing device. The user must specify what function SF1 will have. Refer to your finishing equipment vendor documentation for more detailed information.

Type Page oriented

Syntax SF1FUNCTION = {YES | NO}

Options

Table 5-55. SF1FUNCTION DJDE options and definitions

Option	Definition
YES	Instructs the third party finisher to begin the user defined SF1 operation on the current sheet.
NO	Instructs the third party finisher not to perform on the current sheet the operation defined as SF1.

SF2FUNCTION DJDE

Specifies to the third party finisher whether or not it should perform the user defined SF2 operation on the current sheet.

SF2FUNCTION invokes the C7 signal of the electronic interface between printing system and a third party finishing device. Refer to your finishing equipment vendor device documentation for more detailed information.

Type Page oriented

Syntax SF2FUNCTION = {YES | NO}

Options

Table 5-56. SF2FUNCTION DJDE options and definitions

Option	Definition
YES	Instructs the finisher to begin the operation defined as SF2 on the current sheet.
NO	Instructs the third party finisher not to perform on the current sheet the operation defined as SF2.

SHIFT DJDE

Shifts the printed image from the edge of the physical page. This DJDE is commonly used to accommodate hole drilling or binding.

Type Page oriented

Syntax SHIFT = {YES | NO | (v₁, v₂)}

Options

Table 5-57. SHIFT DJDE options and definitions

Option	Definition
v_1	<i>value 1</i> An integer value in dots for the amount of shift on the simplex page or the odd (front) side of the duplex page. (Each dot is 1/300 of an inch.) The range for v_1 is -75 to 75.
v_2	<i>value 2</i> A value in dots for the amount of shift on the even (back) side of a duplex page. The range for v_2 is -75 to 75.
YES	Specifies that a shift occurs. A standard size shift occurs if YES is specified ($v_1=75$ and $v_2=75$).
NO	Specifies that no shift occurs ($v_1=0$ and $v_2=0$).

SHIFT DJDE: points to note

- The SHIFT DJDE takes effect at the next physical page boundary.
- The resolution for both v_1 and v_2 is 1/300 of an inch for all printers.
- If the origin of a print line falls off the page, the printing system prints as much of the line as possible.
- Graphics and logos are not allowed to start off the page. If they are positioned at a point that is off the page, an error message is displayed.

SIDE DJDE

Specifies repositioning of the next logical page so that it is the first logical page on the given side of a physical sheet.

Type Page oriented

Syntax SIDE = {*sideopt* | *offsetopt* | (*sideopt*, *offsetopt*)}

Options

Table 5-58. SIDE DJDE options and definitions

Option	Definition
<i>sideopt</i>	<i>side option</i> . In duplex (with no BFORM): The four <i>sideopt</i> options produce the following results:
	NUFRONT The specified logical page is positioned as the first logical page on a new sheet.
	BACK The specified logical page is positioned as the first logical page of the next available back.
	NUBACK The specified logical page is positioned as the first logical page on the back of a new sheet.
	NEXT The specified logical page is positioned as the first logical page on the next available side: the back of the current sheet or the front of the next sheet. The logical page is moved unless it is already properly positioned as the first logical page on the specified side.
In simplex, or in duplex with BFORM: The <i>sideopt</i> parameter is forced to NUFONT, and the specified page is positioned as the first logical page. If the logical page is already properly positioned, a blank sheet is not created.	
<i>offsetopt</i>	Specifies whether sheets containing repositioned logical pages will be offset in the stacker. The available <i>offsetopt</i> parameters are: <ul style="list-style-type: none"> • OFFSET Causes the sheet on which the repositioned logical page occurs to be offset. • NOFFSET No offset occurs. The default offset option is NOFFSET.

SIDE DJDE: points to note

- The SIDE DJDE takes effect at a logical page boundary.
- The SIDE DJDE options are the same as for the RPAGE command, SIDE parameter.
- The SIDE DJDE should be used **instead of**, not **in conjunction with**, the RPAGE command. It overrides both the RPAGE SIDE and ROFFSET parameters, if they apply to the next logical page. Thus, it triggers repositioning of only a single logical page and does not otherwise override the RPAGE SIDE or ROFFSET parameters on subsequent pages.

STOCKS DJDE

Identifies the stock set and its associated stock(s) to be used in a report. This stockset file (*STOCKSETNAME.STK*) must already have been created by a compiled JSL and must currently reside in the “lcds” resource folder on the system disk.

Type Page oriented

Syntax STOCKS = *stocksetname*

Options

Table 5-59. STOCKS DJDE options and definitions

Option	Definition
<i>stocksetname</i>	Name of the STOCKSET used in a report.

STOCKS DJDE: point to note

Whenever a new *stockset* is chosen, that is, at start of report or through a JDE or JDL switch via DJDE, the system verifies each stock to determine that the stock exists and can be made active. This verification provides an automatic method of changing stocks in the printer as required by the data stream.

TMODE DJDE

Specifies a maximum paper width in order to improve throughput efficiency when using mixed paper sizes. Refer to the “OUTPUT TMODE” parameter section in the “Specifying print format parameters” chapter for an explanation of pitch mode.

NOTE: This feature is not supported by the Nuvera MX series printers.

Type Page oriented

Syntax TMODE = (*width* [, *widthunit*])

Options

Table 5-60. TMODE DJDE options and definitions

Option	Definition
<i>width</i>	The process direction measurement that will be used to determine the pitch mode. <ul style="list-style-type: none"> For normal (long edge) feeding, this is usually a measure of the <i>short</i> edge of the widest paper being used in the report. For short edge feeding (SEF) this measures the <i>long</i> edge. Width values can range from the 7 inch equivalent to the 17 inch equivalent.
<i>widthunit</i>	Unit of measure for the width of the paper. Can be IN (inches), CM (centimeters), DOTS, or XDOTS (600 spi dots). The default width unit is IN.

TOF DJDE

Specifies the number of lines from the top of the logical page to the first print line (Top Of Form).

Type Record oriented

Syntax TOF = *value*

Options

Table 5-61. TOF DJDE options and definitions

Option	Definition
<i>value</i>	Specifies the Top Of Form line number. This specification is independent of channel assignments. It should be greater than or equal to 1 and less than or equal to the smallest line number assigned to a channel. The default is 1.

TOF DJDE: points to note

- The TOF DJDE is applied before processing of the first data record following the DJDE record.
- Depending on the time of a page transition, the TOF DJDE may not take effect on the next record. In other words, even though a TOF DJDE is processed, a page transition may have occurred before the DJDE value could take effect.

For example, if the initial TOF and BOF values are **2** for every job, a page transition occurs every time a data record is processed because the TOF and BOF have the same value. If a TOF DJDE specifying a value of **1** is processed and the page transition has already occurred, the TOF DJDE value is too late and does not take effect until the next page transition.

- The *value* option is defined the same as in the VFU command, described in the “Specifying print format parameters” chapter.
- If the value specified in the TOF DJDE is greater than or equal to the BOF (Bottom Of Form) value, the TOF value is set to 1.

TRANS DJDE

Specifies whether or not transparencies are used in the print job.

Type Page oriented

Syntax TRANS = {YES | NO}

Options

Table 5-62. TRANS DJDE options and definitions

Option	Definition
YES	Specifies that transparencies are used in the print job.
NO	Specifies that transparencies are not used in the print job.

TRANS DJDE: points to note

- The TRANS DJDE is used to force parameters when transparencies are used and to minimize paper jams. If TRANS=YES is specified, the following parameters are forced:
 - DUPLEX=NO
 - ACCT=TRAY
 - BFORM is ignored.
 - For the RPAGE command, the NUBACK parameter is forced to NUFRONT.

- When simplex mode is put into effect, as is done by use of the TRANS DJDE, the system ensures that the first **simplex** page printed after the DJDE is on an odd numbered page. To accomplish this, the system forces a blank back side for the last duplex page.

However, if you specify TRANS=NO and DUPLEX=YES, the system ensures that the first **duplex** page is printed on an odd numbered page.

XMP DJDE

(Xerographic Mode Persistence) Controls the xerographic mode switching between black and color printing for a report.

Type Record oriented

Syntax XMP = {DEFAULT | REPORT}

Options

Table 5-63. XMP DJDE options and definitions

Option	Definition
DEFAULT	Specifies that the xerographic mode switching that was specified at installation will be used for the report.
REPORT	Specifies that when the system determines that a report requires highlight color for a page, all subsequent pages of the report will print in highlight color.

Auto Switch to Monochrome: On the FreeFlow Print Server-based DT 128/155/180 HighLight Color Printing Systems, the XMP feature is called Auto Switch to Monochrome and can be enabled and disabled in the System Preferences window under the Setup pull-down menu on the main GUI. When enabled, this feature will automatically switch the printer from Highlight Color Mode to Black Only Mode after a user-definable number of consecutive black-only pages. When enabled, it will also switch back to Highlight Color Mode from Black Only Mode when a scheduled highlight color page is to be printed. The default setting is Off.

XSHIFT DJDE

Specifies whether the image of the form and data on a page is to be shifted, and if so, by what values. This DJDE shifts the data downward (in the x direction) for short edge binding, because a long edge feed page is viewed in portrait mode. It is typically used to accommodate top drilled paper, binding, finishing, and edgemarking.

Type Page oriented

Syntax XSHIFT = {YES | NO | (v_1 , v_2)}

Options**Table 5-64. XSHIFT DJDE options and definitions**

Option	Definition
v_1	<i>value 1</i> An integer value in dots for the amount of shift on the simplex page or the odd (front) side of the duplex page. (Each dot is 1/300 of an inch.) The range for v_1 is -75 to 75.
v_2	<i>value 2</i> A value in dots for the amount of shift on the even (back) side of a duplex page. The range for v_2 is -75 to 75.
YES	Specifies that a shift occurs. A standard size shift occurs if YES is specified ($v_1=75$ and $v_2=75$).
NO	Specifies that no shift occurs ($v_1=0$ and $v_2=0$).

6. Using PDL commands for graphics

Several PDL parameters are available for graphics handling. These include four OUTPUT command parameters (specified in the JDE) and six DJDEs. The following tables summarize those parameters.

Table 6-1. OUTPUT command parameters and functions for graphics

Option	Definition
OUTPUT GRAPHICS	Specifies if and how graphics will be processed in current job.
OUTPUT IMAGE	Specifies initial scaling and positioning parameters for graphics in Batch mode.
OUTPUT PURGE	Specifies default disposition of document interleaved graphics at the end of a report.
OUTPUT UNITS	Specifies units of measure for positioning graphics.

For a explanation of the OUTPUT command parameters, refer to the “OUTPUT command” section in the “Specifying print format parameters” chapter.

Table 6-2. DJDE definitions for graphics

Option	Definition
ALTER DJDE	Specifies new imaging parameters for graphics previously referenced using HOLD statement.
BATCH DJDE	Marks beginning and end of online Batch mode graphic data.
CANCEL DJDE	Terminates option of the GRAPHIC DJDE.
GRAPHIC DJDE	Precedes interleaved graphic in data stream.
IMAGE DJDE	Specifies name, scaling, and positioning of a graphic printed.
SAVE DJDE	Identifies document interleaved graphics not to be deleted or purged.

Graphics DJDEs are record oriented because they take effect immediately. For example, ALTER, CANCEL, and IMAGE may appear anywhere on the page and are applied to the page on which they occur. Page oriented DJDEs to be applied to the next page must not precede Batch mode or page interleaved graphics to be applied to the current page.

Refer to the “Using Dynamic Job Descriptor Entries (DJDEs)” chapter for more information.

Input for graphics

Named graphics, like other resource files, may be imported to the system disk from magnetic tape, CD ROM, or diskette. They can also be downloaded from the host by using the FTP process or by FILE DJDE processing.

Graphics may be input either separately from, or interleaved with, textual data. If the graphics are input separately, they are recorded as permanent disk files. If they are interleaved, they may or may not be recorded as permanent disk files. Refer to “Graphic processing modes” later in this chapter.

A graphic is typically incorporated into a document by a DJDE record occurring with the data targeted for the same simplex sheet or duplex side in which the graphic appears. Additionally, a graphic may be referenced in a form, so that use of the form automatically includes the graphic.

NOTE: The DP 2000 Series EPS can handle highlight colored graphics (one color plus black) from a Xerox 4850, 4890, or DP92C HighLight Color Laser Printing System (it prints them in shades of black). However, the systems cannot process multicolor graphics.

Error handling for graphics

Use the ABNORMAL ERROR parameter to specify how the system will handle error conditions involving graphics. If you specified ABNORMAL ERROR=STOP in the JSL, the DP 2000 Series EPS systems do the following when they encounter an image that is off the page:

- Display an error message.
- Partially print the image.
- Give the operator the option to abort the job or to continue printing and have the error added to the log.

Graphic processing modes

A graphic is handled by the software in one of the following four modes:

- Random mode (Move mode)
- Block mode
- Batch mode

You select the mode depending upon how the graphic is made available for report processing, as well as your performance requirements and disk resources.

Random or Move mode

In Random mode (also called Move mode), a graphic is obtained from a named disk file. The file must already exist at the start of report processing or must be read from the input data stream before the first record of the report text is processed. In the latter case, each graphic is written to the disk as a permanent image file. In Random mode, the output software reads the various graphics for a page from their individual files.

Block mode

In Block mode, a graphic is obtained from the input data stream immediately following the textual data to be imaged on the same page. Separate graphic disk files are not created.

A given page of a report that includes Block mode graphics may also include either Random or Move mode graphics.

Batch mode In Batch mode, the input stream contains graphics that will be imaged, one per page, with either default or specified imaging options. Batch mode graphics are processed the same as Block mode graphics. In Batch mode, only one graphic is imaged on each page (for example, forms may not be invoked in Batch mode). This feature may be invoked by the GRAPHICS parameter of the OUTPUT command.

Formats for graphic data

There are four possible formats for jobs that incorporate graphics. If you are loading the graphics from magnetic tape, the graphics tape must be formatted appropriately for the format being used. The formats are:

- Random Mode Only format
- Document Interleaved format
- Page Interleaved format
- Batch Mode format

Random Mode Only format To transfer .IMG files from a tape to the system disk independent of printing (Random Mode Only format), use the print server user interface LCDS Media Resource Manager window. Refer to the online help on your print server for the procedure.

Document Interleaved format In this format, a report data stream begins with a set of one or more graphics before the first record of text. These graphics are copied one at a time to named .IMG disk files. When the report has finished printing, the .img files created are automatically deleted, unless you have explicitly specified otherwise.

A document interleaved graphic report tape must be formatted as follows:

- The tape format may be any legal fixed or variable length block, or in a record format that is supported by the DP 2000 Series EPS; that is, BLOCK or RECORD STRUCTURE = F, FB, V or VB. It may not be an undefined block or record format, that is, RECORD STRUCTURE = U or UB. Packed data formats are not supported.
- Each graphic must be preceded immediately by a GRAPHIC DJDE.

- Use of block and record constants in an appropriately structured file (type F, FB, V, or VB) containing interleaved graphics is supported. However, the actual delimiter searching is suspended while an .IMG file is being read.
 - For record delimiters, this means that delimiter searching is suspended from the first record of graphic data until the entire graphic has been read. Extraneous bytes at the end of the last record are ignored. Record delimiter processing resumes with the next record.
 - For block delimiters, this means that the first byte of a graphic must be the first data byte of a block and that the first byte of data following the graphic must also be the first byte of a block. Extraneous data in the last block following the last byte specified by the IMG byte count is ignored.
- Improved tape to disk processing time is obtained if the graphic data portion of each record is an integer multiple of 512 bytes and begins at an even byte offset from the beginning of the block. Processing of each graphic begins in this mode. If a record is not a multiple of 512 bytes or does not begin at an even byte offset from the beginning of the block, the mode is terminated.

Page Interleaved format

In this format, one or more graphics imaged on a physical page are included in the data file immediately following the textual data for that page. These graphics, if referenced, are processed in Block mode. If not referenced, a page interleaved graphic is skipped. The rules for page interleaved graphics are as follows:

- The graphics must occur immediately following the last text to appear on the physical page.
- The four rules for document interleaved graphics apply to this format also. Refer to the “Document Interleaved format” section earlier in this chapter.

Batch Mode format

In this format, a report contains only graphics that will be imaged one per page and an optional IMAGE DJDE preceding each graphic. These graphics are processed as Block mode graphics.

The four rules for document interleaved graphics apply to this format also. Refer to the “Document Interleaved format” section earlier in this chapter.

NOTE: Block or record delimiters are not permitted.

Except for the graphics themselves, the input stream may contain only optional IMAGE DJDE records. When the system encounters an IMAGE DJDE record, that DJDE defines the scaling and positioning parameters for subsequent graphics.

Impact of graphics on system performance

Incorporating graphics in a job can have an impact on system performance at different points in the printing process. The effect varies according to the mode of graphics transfer.

- **Random (Move) mode:**

Random or Move mode requires a separate disk access for processing of every graphic on a page. The more graphics on a page and the larger the graphics, the more likely it is that paper path holes are created.

NOTE: On the DP 2000 Series EPS, this condition occurs rarely, and only under extreme conditions.

- **Online:**

It should be noted that sending interleaved graphics across the online interface affects system performance. The time to process graphic information across the channel, block it, and write it to disk is significant. As the average density of graphic information decreases, throughput should increase.

Graphics features restrictions

Following is a summary of restrictions imposed on, and by, graphics features supported on DP 2000 Series EPS.

- Tape formats supported by interleaved graphic processing are restricted to LPS compatible fixed or variable record structures, that is, BLOCK or RECORD STRUCTURE = F, FB, V, or VB only. Undefined length record structures, such as types U and UB, are not supported. Packed data formats are not supported.
- Graphic images may be overlapped on a page with each other and with text.
- If a graphic begins off the system page, no part of the graphic is printed.

- No online banner page (neither header nor trailer) may include graphic references.
- A JDE that is selected with the JDE DJDE or JDL DJDE may not specify GRAPHICS=NO if the current report has already processed at least one graphic. (The GRAPHICS=NO specification is ignored.)
- In online Batch mode, PCC commands are ignored beginning with the BATCH=START DJDE until the BATCH=END DJDE is processed.
- If RPAGE is used to move a logical page from one physical page to another, graphic references are handled as follows: Graphic references encountered after the record that satisfied the RPAGE statement are imaged on the physical page to which the logical page is moved. Any other image references are applied to the physical page being formed at the time the RPAGE statement was satisfied. For example, if RPAGE WHEN=TOP is specified, it is possible for a graphic to appear on physical page n , even though text that may have preceded its reference in the input data stream appears on physical page $n+1$.

NOTE: Use caution when using RPAGE with page interleaved graphics.

- A document interleaved graphic replaces an existing graphic with the same name. This is true even if the existing graphic is used in a report that is being printed.
- Forms are not supported for Batch mode processing.

A. PDL command and DJDE summary

This section contains all the PDL commands, parameters, and DJDEs available for all the Xerox laser printing systems, including the FreeFlow Print Server LCDS systems. This document may be used as a quick reference for information about PDL command syntax and parameters. The following definitions describe the conventions used in this appendix.

Conventions The following symbols are used in the command syntax:

Table A-1. Symbols used in command syntax

Symbol	Meaning
<i>ac</i>	<i>Alpha character</i> identifier. Signifies a command identifier. Consists of 1 to 6 alphanumeric characters (A through Z and 0 through 9). One of the characters must be alpha.
<i>dd</i>	Signifies a command identifier. Same as <i>ac</i> except there is no restriction of having an alpha character. This identifier applies only to SYSTEM (or JDL) and JOB (or JDE) command sets.
<i>id</i>	<i>Identifier</i> . Reference to a command identified by an <i>ac</i> command identifier.
<i>sc</i>	<i>String constant</i> . A hexadecimal, octal, ASCII, EBCDIC, or character text string constant.
<i>value</i>	A decimal constant.
<i>s</i>	The <i>s</i> at the end of some PDL commands and DJDEs is optional.

**Contents of
command table
columns**

The columns in the PDL Command Summary table contain the following information:

- **Command column:** Lists all PDL commands in alphabetical order.
- **Parameters column:** Beside each command, lists the command parameters in alphabetical order.
- **Default column:** Gives the default parameter for each command.

- **Printing system column:** Indicates the laser printing systems to which the command or parameter applies. “ALL” means that the command is applicable to all laser printing systems operating with version 3 software or higher.
- **Online and Offline columns:** Specify the input data stream modes of operation for the printing system. A “Y” for a particular parameter means the parameter is available for that processing mode. An “N” means the parameter is not available for that mode.
- **DJDE orientation column:** Indicates whether a command or parameter has an equivalent DJDE and, if so, specifies whether the DJDE is page or record oriented.

Summary table of PDL commands and DJDEs

Table A-2. PDL commands and DJDEs

Command	Parameters	Default	Printing system	Off-line	On-line	DJDE orientation
ABNORMAL	ACCTFEED	OPR	FreeFlow Print Server LCDS systems	N	Y	—
	CODE	IGNORE	FreeFlow Print Server LCDS systems	N	Y	—
	ERROR	STOP	All	Y	Y	—
	IMISMATCH	STOP	4850, 4890, DP92C LPS, DP EPS (prints black), DT 128/155/180 (use loaded color)	Y	Y	—
	ISUBSTITUTE	ANY	4850, 4890, DP92C LPS, DP EPS (prints black), DT 128/155/180 (prints black with queue override)	Y	Y	—
	OTEXT	NOWAIT	All	Y	Y	—
	SECURITY	NO	All	Y	Y	—
ACCT	DEPT	<i>JDLNAME</i>	All	Y	Y	Page
	USER	BIN	All	Y	Y	—

Table A-2. PDL commands and DJDEs (Continued)

Command	Parameters	Default	Printing system	Off-line	On-line	DJDE orientation
ALTER DJDE	<i>name</i>	—	All	Y	Y	Record
	<i>vpos</i>	—	All	Y	Y	Record
	<i>hpos</i>	—	All	Y	Y	Record
	<i>n/d</i>	—	All	Y	Y	Record
	INKS	—	All	Y	Y	Record
	<i>'inkref'</i>	—	All	Y	Y	Record
BANNER	HCOUNT	0	All	N	Y	—
	HJOBNO	NONE	All	N	Y	—
	HRPTNA	NONE	All	Y	Y	—
	TCOUNT	0	All	N	Y	—
	TEST	—	All	N	N	—
	TYPE	BANNER	All	N	Y	—
BARCODE	BSEQ	RESET	4635 LPS	Y	Y	Page
	BSIDE	ODD	4635 LPS	Y	Y	Page
	BSKIP	SKIP	4635 LPS	Y	Y	Page
BATCH DJDE	START	—	All	Y	Y	Record
	END	—	All	Y	Y	Record
BDELETE	TEST	—	All	Y	N	—
BLOCK	ADJUST	0	All	Y	N	—
	CONSTANT	—	All	Y	N	—
	FORMAT	BIN	All	Y	N	—
	LENGTH	1330	All	Y	N	—
	LMULT	1	All	Y	N	—
	LTHFLD	0	All	Y	N	—
	OFFSET	0	All	Y	N	—
	POSTAMBLE	0	All	Y	N	—
	PREAMBLE	0	All	Y	N	—
	ZERO	NO	All	Y	N	—
BSELECT	TEST	—	All	Y	N	—

Table A-2. PDL commands and DJDEs (Continued)

Command	Parameters	Default	Printing system	Off-line	On-line	DJDE orientation
C <i>text</i> DJDE	<i>text</i>	—	All	Y	Y	Record
CANCEL DJDE	ALL	—	All	Y	Y	Record
	<i>name</i>	—	All	Y	Y	Record
ac:CATALOG	—	—	All	Y	Y	—
ac:CME	CONSTANT	—	All	Y	Y	—
	FONTS	—	All	Y	Y	—
	INK	—	4850, 4890, 92C LPS, DP EPS (prints black), DT 128/155/180 HLC	Y	Y	—
	LINE	—	All	Y	Y	—
	POSITION	—	All	Y	Y	—
ac:CODE	ASSIGN	—	All	Y	Y	—
	DEFAULT	EBCDIC	All	Y	Y	—
	SPACECODE	X'20 (ASCII) X'40 (non-ASCII)	FreeFlow Print Server LCDS systems	N	Y	—
ac:CRITERIA	CHANGE	—	All	Y	Y	—
	CONSTANT	—	All	Y	Y	—
	LINENUM	ALL LINES	All	Y	Y	—
	VALUE	—	4850, 4890, DP92C, 96, 4635, 180 LPS, FreeFlow Print Server LCDS systems	Y	Y	—
DBCOD	ASSIGN	—	FreeFlow Print Server LCDS systems	N	Y	—
	DEFAULT	—	FreeFlow Print Server LCDS systems	N	N	—
END DJDE	—	—	All	Y	Y	—

Table A-2. PDL commands and DJDEs (Continued)

Command	Parameters	Default	Printing system	Off-line	On-line	DJDE orientation
EOF, DJDE	—	—	FreeFlow Print Server LCDS systems	Y	Y	Record
EXPORT	SEPARATORS	NONE	4850, 4890, DP92C, 4135, 96, 4635, 180, 9790, 8790 LPS	Y	Y	—
	SNUMBER	—	4850, 4890, DP92C, 4135, 96, 4635, 180, 9790, 8790 LPS	Y	Y	Page
	SPLIT	—	4850, 4890, DP92C, 4135, 96, 4635, 180, 9790, 8790 LPS	Y	Y	Page
	SRECOVER	PAGE	4850, 4890, DP92C, 4135, 96, 4635, 180, 9790, 8790 LPS	Y	Y	Page
	STIMING	—	4850, 4890, DP92C, 4135, 96, 4635, 180, 9790, 8790 LPS	Y	Y	Page
FILE DJDE	<i>filename</i>	—	All	N	Y	Record
	<i>filetype</i>	—	All	N	Y	Record
	f (input format)	—	All	N	Y	Record
	s (file storage)	—	All	N	Y	Record
GRAPHIC DJDE	<i>name</i>	—	All	Y	Y	Record
	<i>vpos</i>	—	All	Y	Y	Record
	<i>hpos</i>	—	All	Y	Y	Record
	H	—	All	Y	Y	Record
	<i>n/d</i>	—	All	Y	Y	Record
	INKS	—	All	Y	Y	Record
	<i>'inkref'</i>	—	All	Y	Y	Record
IDEN	OFFSET	0	All	Y	Y	—
	OPRINFO	NO	All	Y	Y	—
	PREFIX	—	All	Y	Y	—
	SKIP	1	All	Y	Y	—

Table A-2. PDL commands and DJDEs (Continued)

Command	Parameters	Default	Printing system	Off-line	On-line	DJDE orientation
<i>ac:IDR</i>	ICATALOG	System default	4850, 4890, DP92C LPS, DP EPS (prints black), DT128/155/180 HLC	Y	Y	Page
	ILIST	—	4850, 4890, DP92C LPS, DP EPS (prints black), DT128/155/180 HLC	Y	Y	Page
	PALETTE	DFAULT	4850, 4890, DP92C LPS, DP EPS (prints black), DT128/155/180 HLC	Y	Y	Page
JDE DJDE	<i>jdename</i>	—	All	Y	Y	Page
JDL DJDE	<i>jdlname</i>	—	All	Y	Y	Page
<i>ac:JOB</i>	INCLUDE	—	All	Y	Y	—
KCODE	ASSIGN	—	FreeFlow Print Server LCDS systems	N	Y	—
	DEFAULT	—	FreeFlow Print Server LCDS systems	N	N	—

Table A-2. PDL commands and DJDEs (Continued)

Command	Parameters	Default	Printing system	Off-line	On-line	DJDE orientation
LINE	BASELINE	LARGE[ST]	FreeFlow Print Server LCDS systems	N	Y	—
	BLANKTYPE	NOSPACE	FreeFlow Print Server LCDS systems	N	Y	—
	DATA	offline=1,132	All	Y	Y	Record
		online=0,150	All	N	Y	Record
	FCB	PROCESS	All	N	Y	—
	FDATA	0, DEFAULT	FreeFlow Print Server LCDS systems	N	Y	Record
	FONTINDEX	NONE	All	Y	Y	Page
	GDATA	0, DEFAULT	FreeFlow Print Server LCDS systems	N	Y	Record
	INKINDEX	NONE	4850, 4890, DP92C LPS, DP EPS (prints black), DT128/155/180 HLC	Y	Y	Page
	LPI	—	All	N	Y	Record
	MARGIN	1, POS	All	Y	Y	Record
	OVERPRINT	PRINT, NODISP	All	Y	Y	Record
PCC	0, NOTRAN	All	Y	N	—	

Table A-2. PDL commands and DJDEs (Continued)

Command	Parameters	Default	Printing system	Off-line	On-line	DJDE orientation
LINE (continued)	PCCTYPE	offline=ANSI	All	Y	N	—
		online=IBM4245	All	N	Y	—
	UCSB	PROCESS	All except FreeFlow Print Server LCDS	N	Y	—
	VFU	NONE	All	Y	Y	—
LMODIFY	TEST	—	4850, 4890, DP92C LPS, FreeFlow Print Server LCDS systems	Y	Y	—
MESSAGE	ITEXT	NONE	All	Y	Y	Page
	OTEXT	NONE	All	Y	Y	Page

Table A-2. PDL commands and DJDEs (Continued)

Command	Parameters	Default	Printing system	Off-line	On-line	DJDE orientation
OUTPUT	BFORM	NONE; <i>init</i> defaults to first or next copy	All	Y	Y	Page
	BINDING	LONG	FreeFlow Print Server LCDS systems	N	Y	—
	COLLATE	YES	All	Y	Y	Page
	COPIES	1	All	Y	Y	Page
	COVER	NONE	All	Y	Y	—
	CYCLEFORMS	NONE	All	Y	Y	—
	DENSITY	DEFAULT	All	Y	Y	—
	DESTINATION	NO	All	Y	Y	—
	DUPLEX	NO	All	Y	Y	Page
	FACEUP	NO	All except 9790 and 8790	Y	Y	—
	FEED	OPR	All	Y	Y	Page
	FORMAT	FMT1	All	Y	Y	Page
	FORM[S]	NONE; (<i>init</i> defaults to first or next copy; FOR defaults to FORMAT if FORMS is not fully entered.)	All	Y	Y	Page
GRAPHICS	NO	All	Y	Y	Record	

Table A-2. PDL commands and DJDEs (Continued)

Command	Parameters	Default	Printing system	Off-line	On-line	DJDE orientation
OUTPUT (continued)	IDFAULT	First ink in ILIST parameter	4850, 4890, DP92C LPS, DP EPS (prints black), DT128/155/180 HLC	Y	Y	Page
	IDR	DFIDR.IDR	4850, 4890, DP92C LPS, DP EPS (prints black), DT128/155/180 HLC	Y	Y	Page
	IMAGE	INCHES; top left corner scaled 1 to 1	All	Y	Y	Page
	INVERT	NONE	96, 4635, 180 LPS, FreeFlow Print Server LCDS systems	Y	Y	Page
	IRESULT	Installed default	4850, 4890, DP92C LPS, DP EPS (prints black), DT 128/155/180 HLC (queue settings apply, black is default).	Y	Y	Page
	LOGO	—	96, 4635, 180 LPS, FreeFlow Print Server LCDS systems	Y	Y	Record
	MODIFY	NONE	4850, 4890, DP92C LPS, DP EPS (prints black)	Y	Y	Page
	NT01	NO	All	Y	Y	—
	NUMBER	NO	All except 9790 and 8790	Y	Y	—
	OFFSET	ALL	All	Y	Y	—
	OSTK	RES <i>mod & pos =1;</i> <i>size=.5 IN</i>	96, 4635, 180 LPS, FreeFlow Print Server LCDS systems	Y	Y	—
	PAPERSIZE	Installed default	All	Y	Y	Page
	PURGE	NO	All	Y	Y	—
	RESOLUTION	Installed default	All	Y	Y	—

Table A-2. PDL commands and DJDEs (Continued)

Command	Parameters	Default	Printing system	Off-line	On-line	DJDE orientation
OUTPUT (continued)	SF1FUNCTION	NO	4850, 4890, 4135, 96, 4635, 180 LPS, FreeFlow Print Server LCDS systems	Y	Y	Page
	SF2FUNCTION	NO	4850, 4890, 4135, 96, 4635, 180 LPS, FreeFlow Print Server LCDS systems	Y	Y	Page
	SHIFT	—	All	Y	Y	Page
	SIZING	—	All	Y	Y	—
	STAPLE	Depends on paper size	4050, 4090, 4850, 4890, DP92C LPS, DP75 EPS, Nuvera 1xx MX DPS	Y	Y	—
	STOCKS	<i>width unit=IN</i>	All except 9790 and 8790 LPS	Y	Y	Page
	SYSPPR	—	4135, 96, 4635, 180 LPS, FreeFlow Print Server LCDS systems	Y	Y	—
	TMODE	—	4135, 96, 4635, 180 LPS, FreeFlow Print Server LCDS systems except for Nuvera	Y	Y	Page
	TRANS	NO	4135, 96, 4635, 180 LPS, FreeFlow Print Server LCDS systems	Y	Y	Page
	UNITS	—	All	Y	Y	—
	XMP	DEFAULT	4850, 4890, DP92C LPS, DT 128/155/180 HLC	Y	Y	Record
XSHIFT	NO	96, 4635, 180 LPS, FreeFlow Print Server LCDS systems	Y	Y	Page	

Table A-2. PDL commands and DJDEs (Continued)

Command	Parameters	Default	Printing system	Off-line	On-line	DJDE orientation
ac:PCC	ADVTAPE	YES	All	Y	N	—
	ASSIGN	—	All	Y	N	—
	DEFAULT	DEFAULT	All	Y	N	—
	INITIAL	TOF	All	Y	N	—
	MASK	X'FF'	All	Y	N	—
ac:PDE	BEGIN	.18 IN, .66 IN	All	Y	Y	Page
	FONTS	L0112B	All	Y	Y	Page
	PMODE	LANDSCAPE	All	Y	Y	Page
RAUX	TEST	—	All	Y	Y	—
RDELETE	TEST	—	All	Y	Y	—
RECORD	ADJUST	0	All	Y	N	—
	CONSTANT	—	All	Y	N	—
	FORMAT	BIN	All	Y	N	—
	LENGTH	offline=133	All	Y	N	—
		online=150	All	N	Y	—
	LMULT	1	All	Y	N	—
	LTHFLD	0	All	Y	N	—
	OFFSET	0	All	Y	N	—
	POSTAMBLE	0	All	Y	N	—
	PREAMBLE	0	All	Y	N	—
STRUCTURE	FB	All	Y	N	—	
RFEED	TEST	no default for <i>stockdef</i>	All except 9790 and 8790 LPS	Y	Y	—
ROFFSET	PASSES	ALL	All	Y	Y	—
	TEST	—	All	Y	Y	—
ac:ROUTE	RFORM	NONE	All	Y	Y	Page
	RTEXT	NONE	All	Y	Y	Page

Table A-2. PDL commands and DJDEs (Continued)

Command	Parameters	Default	Printing system	Off-line	On-line	DJDE orientation
RPAGE	SIDE	NUFRONT, NOFFSET	All	Y	Y	Page
	TEST	—	All	Y	Y	—
	WHEN	TOP	All	Y	Y	—
RRESUME	BEGIN	NEXT	All	Y	Y	—
	TEST	—	All	Y	Y	—
RSELECT	TEST	—	All	Y	Y	—
RSPLIT	TEST	—	9790 and 8790 LPS	Y	Y	—
RSTACK	ACCTINFO	—	All	Y	Y	—
	DELIMITER	NO	All	Y	Y	—
	HRPTNA	NONE	All	Y	Y	—
	PRINT	NONE	All	Y	Y	—
	TEST	—	All	Y	Y	—
RSUSPEND	BEGIN	NEXT	All	Y	Y	—
	TEST	—	All	Y	Y	—
SAVE DJDE	<i>filename</i>	—	All	Y	Y	Record
	ALL	—	All	Y	Y	Record
SEFFNT	MAP	—	96, 4635, 180 LPS, FreeFlow Print Server LCDS systems	Y	Y	Page
	SEFMAP	—	96, 4635, 180 LPS, FreeFlow Print Server LCDS systems	Y	Y	Page
<i>ac</i> :STOCKSET	ASSIGN	—	All	Y	Y	—
	INIFEED	first ' <i>stockname</i> '	All	Y	Y	—
	SYSPAGE	—	All	Y	Y	—
<i>ac</i> :SYSTEM	—	—	All	Y	Y	—
<i>ac</i> :TABLE	CONSTANT	—	All	Y	Y	—
	MASK	—	All	Y	Y	—

Table A-2. PDL commands and DJDEs (Continued)

Command	Parameters	Default	Printing system	Off-line	On-line	DJDE orientation
<i>ac:TCODE</i>	DEFAULT	—	All	Y	Y	—
	TASSIGN	—	All	Y	Y	—
	TRESET	—	All	Y	Y	—
<i>ac:VFU</i>	ASSIGN	—	All	Y	Y	Record
	BOF	66	All	Y	Y	Record
	TOF	1	All	Y	Y	Record
VOLUME	BMULT	1	All	Y	N	—
	CODE	EBCDIC	All	Y	Y	—
	DBCOD	—	FreeFlow Print Server LCDS systems	N	Y	—
	DBCS	NO	FreeFlow Print Server LCDS systems	N	Y	—
	EMTYPE	T1	FreeFlow Print Server LCDS systems	N	Y	—
	EOV	NOPAUSE, NOEOF	All	Y	N	—
	EXPAGE	YES	FreeFlow Print Server LCDS systems	N	Y	—
	HOST	IBMOS	All	Y	Y	—
	KANJI	NO	FreeFlow Print Server LCDS systems	N	Y	—
	KCODE	—	FreeFlow Print Server LCDS systems	N	Y	—
	LABEL	STANDARD	All	Y	N	—
	LCODE	EBCDIC	All	Y	N	—
	LPACK	NO	All	Y	N	—
	MAXLAB	81	All	Y	N	—
MINLAB	80	All	Y	N	—	

Table A-2. PDL commands and DJDEs (Continued)

Command	Parameters	Default	Printing system	Off-line	On-line	DJDE orientation
VOLUME (continued)	OPTIMIZE	NONE	All except FreeFlow Print Server LCDS	Y	N	—
	OSCHN	9	All	Y	N	—
	OSHDP	0	All	Y	N	—
	OSTLP	0	All	Y	N	—
	PLABEL	NO	All except FreeFlow Print Server LCDS	Y	N	—
	RMULT	1	All	Y	N	—
	RSAT	REMOUNT	All	Y	N	—
	TCODE	EBCDIC	All	Y	N	—
	UNPACK	NONE	All	Y	N	—

B. PDL command quick reference

This section provides a quick reference for PDL commands, in the form of structure diagrams. The commands shown here are supported on some or all of the following laser printing systems: DP180 LPS, DP96 LPS, 4050 LPS, 4090 LPS, 4135 LPS, 4635 LPS, 4850 LPS, 4890 LPS, DP92C LPS, 8790 LPS, 9790 LPS, and DP 2000 Series EPS.

Refer to Appendix A, "PDL command and DJDE summary," for information on which printing systems support each command and parameter.

Conventions Symbols used in the command syntax are listed in the table below.

Table B-1. Symbols used in command syntax

Symbol	Meaning
<i>ac</i>	<i>Alpha character identifier.</i> Signifies a command identifier. Consists of 1 to 6 alphanumeric characters (A through Z and 0 through 9). One of the characters must be alpha.
<i>dd</i>	Signifies a command identifier. Same as <i>ac</i> except there is no restriction of having an alpha character. This identifier applies only to SYSTEM (or JDL) and JOB (or JDE) command sets.
<i>id</i>	<i>Identifier.</i> Reference to a command identified by an <i>ac</i> command identifier.
<i>sc</i>	<i>String constant.</i> A hexadecimal, octal, ASCII, EBCDIC, or character text string constant.
<i>value</i>	A decimal constant.
<i>s</i>	The <i>s</i> at the end of some PDL commands and DJDEs is optional.

Contents of Quick Reference table columns

The Quick Reference table for PDL commands shows, in compact table format, the syntax for each parameter of each PDL command. The table columns contain the following information:

- **Command column:** Lists the PDL commands in alphabetical order.

- **Syntax column:** Beside each command in the Command column, lists the command parameters in alphabetical order and gives the syntax for each parameter.
- **Default column:** Gives the default option for each parameter.

PDL command Quick Reference table

Table B-2. PDL command quick reference table

Command	Syntax	Default
ABNORMAL	ABNORMAL ACCTFEED = AUX OPR	OPR
	ABNORMAL CODE = IGNORE SPACE SUBSTITUTE	IGNORE
	ABNORMAL ERROR = {ABORT CONTINUE STOP}	STOP
	ABNORMAL IMISMATCH = {ABORT CONTINUE STOP}	STOP
	ABNORMAL ISUBSTITUTE = {ANY NONE}	ANY
	ABNORMAL OTEXT = {WAIT NOWAIT}	NOWAIT
	ABNORMAL REP = {NO YES}	NO
	ABNORMAL SECURITY = {YES NO}	NO
ACCT	ACCT DEPT = <i>sc</i>	<i>JDLNAME.JDL</i>
	ACCT USER = {BIN TRAY BOTH NONE}	BIN
ALTER (DJDE only)	ALTER = (<i>name</i> , <i>vpos</i> [<i>units</i>], <i>hpos</i> [<i>units</i>], [<i>n</i> [<i>d</i>]] [, (INK[S], <i>inkref</i> ₁ , [<i>inkref</i> ₂] [...]))	—
BANNER	BANNER HCOUNT = <i>value</i>	<i>testexp</i>
	BANNER HJOBNO = {(<i>offset</i> , <i>length</i>) NONE}	NONE
	BANNER HRPTNA = {(<i>offset</i> , <i>length</i>) NONE}	NONE
	BANNER TCOUNT = <i>value</i>	0
	BANNER TEST = <i>testexp</i>	—
	BANNER TYPE = {DATE BANNER}	BANNER
BARCODE	BARCODE BSKIP = {READ SKIP}	BSKIP
	BARCODE BSIDE = {ODD EVEN BOTH}	ODD
	BARCODE BSEQ = {RESET NORESET NOSEQ}	RESET
BATCH (DJDE only)	BATCH = (START END)	—

Table B-2. PDL command quick reference table (Continued)

Command	Syntax	Default
BDELETE	BDELETE TEST = <i>testexp</i>	—
BLOCK	BLOCK ADJUST = <i>value</i>	0
	BLOCK CONSTANT = <i>sc</i>	—
	BLOCK FORMAT = <i>type</i>	BIN
	BLOCK LENGTH = <i>value</i>	1330
	BLOCK LMULT = <i>value</i>	1
	BLOCK LTHFLD = <i>value</i>	0
	BLOCK OFFSET = <i>value</i>	0
	BLOCK POSTAMBLE = <i>value</i>	0
	BLOCK PREAMBLE = <i>value</i>	0
BLOCK ZERO = {YES NO}	—	
BSELECT	BSELECT TEST = <i>testexp</i>	—
C <i>text</i> (DJDE only)	C <i>text</i>	—
CANCEL (DJDE only)	CANCEL = {ALL (<i>name1</i> , [<i>name2</i> , [...]])}	—
ac:CATALOG	<i>catname</i> :CATALOG	—
ac:CME	ac:CME CONSTANT = <i>sc</i>	—
	ac:CME FONTS = <i>value</i>	—
	ac:CME LINE = { <i>n</i> (<i>n</i> , <i>m</i>) (<i>n</i> , -1)}	—
	ac:CME POSITION = <i>n</i>	—
	ac:CME INK = { <i>inkindex</i> 0}	—
ac:CODE	ac:CODE ASSIGN = {(<i>input</i> , <i>output</i>) (<i>input</i> , (<i>output</i> , ..., <i>output</i>))}	—
	ac:CODE DEFAULT = <i>codetype</i>	EBCDIC
	ac:CODE SPACECODE = <i>spacecode</i>	X'20 (ASCII) X'40 (non-ASCII)
ac:CRITERIA	ac:CRITERIA CHANGE = (<i>offset</i> , <i>length</i> , NE, LAST)	—
	ac:CRITERIA CONSTANT = (<i>offset</i> , <i>length</i> , {EQ NE}, <i>tabid</i>)	—
	ac:CRITERIA LINENUM = (<i>init</i> , <i>count</i>)	ALL LINES
	ac: CRITERIA VALUE = (<i>offset</i> , <i>length</i> , {EQ NE LT LE GT GE}, <i>tabid</i>)	—

Table B-2. PDL command quick reference table (Continued)

Command	Syntax	Default
ac:DBC CODE	ac:DBC CODE ASSIGN = (<i>input</i> , <i>output</i>)	—
	ac:DBC CODE DEFAULT = {JIS JEF KEIS IBM}	—
END (DJDE only)	END;	—
EOF, (DJDE only)	EOF,;	—
EXPORT	EXPORT SEPARATORS = {FIRST LAST [,D]} (BOTH [, D]) NONE}	NONE
	EXPORT SNUMBER = (<i>Inum</i> , <i>cnum</i> , <i>findex</i>)	—
	EXPORT SPLIT = {NOW (<i>min</i> , <i>max</i>) OFF}	—
	EXPORT SRECOVER = {PAGE SEGMENT ASK DEVICE}	PAGE
	EXPORT STIMING = {(INTERVAL, <i>sec</i>) (DELAY, <i>sec</i>) (INTERVAL, <i>sec</i> , DELAY, <i>sec</i>)}	—
FILE (DJDE only)	FILE = ([<i>filename</i>] [, <i>filetype</i>] [, <i>f</i>] [, <i>s</i>] [, <i>n</i>]))	—
GRAPHIC (DJDE only)	GRAPHIC = (<i>name</i> , <i>vpos</i> [<i>units</i>], <i>hpos</i> [<i>units</i>], [, H] [, <i>n</i> [<i>/d</i>]])	—
IDEN	IDEN OFFSET = <i>value</i>	0
	IDEN OPRINFO = {YES NO}	NO
	IDEN PREFIX = <i>sc</i>	—
	IDEN SKIP = <i>value</i>	1
ac:IDR	IDR ICATALOG = <i>ink catalogname</i>	DFAULT
	IDR ILIST = {' <i>inkname</i> ' (' <i>inkname</i> ₁ ' [, ' <i>inkname</i> ₂ '] [,...])}	—
	IDR PALETTE = ' <i>palette name</i> '	DFAULT
JDE (DJDE only)	JDE = <i>JDEname</i>	—
JDL (DJDE only)	JDL = <i>JDLNAME</i>	—
ac:JOB	ac:JOB [INCLUDE = (<i>catname</i> ₁ [, <i>catname</i> ₂] [,...])]	—
KCODE	KCODE ASSIGN = (<i>input</i> , <i>output</i>)	—
	KCODE DEFAULT = {JIS JEF KEIS IBM}	—

Table B-2. PDL command quick reference table (Continued)

Command	Syntax	Default
LINE	LINE BASELINE = {TOP LARGE[ST] CENTER BOTTOM}	—
	LINE BLANKTYPE = {SPACE NOSPACE}	NOSPACE
	LINE DATA = (<i>pdo</i> , <i>length</i>)	offline: 1,134; online: 0,150
	LINE FCB = {IGNORE PROCESS}	PROCESS
	LINE FDATA = (<i>offset</i> , <i>termination</i>)	0, DEFAULT
	LINE FONTINDEX = { <i>offset</i> <i>offset</i> ([, <i>initval</i>][, <i>bitopt</i>]) NONE}	NONE
	LINE GDATA = (<i>offset</i> , <i>termination</i>)	0, DEFAULT
	LINE INKINDEX = { <i>offset</i> <i>offset</i> ([, <i>initval</i>][, <i>bitopt</i>]) NONE}	NONE
	LINE LPI = {(<i>linespacing</i> {LPI DOTS XDOTS}) (<i>linespacing</i> {LPI DOTS XDOTS}, <i>lineno</i> , (...))}	—
	LINE MARGIN = { <i>value</i> (<i>value</i> , <i>valuetype</i>)}	1, POS
	LINE OVERPRINT = (<i>overopt</i> , <i>disp</i>)	PRINT, NODISP
	LINE PCC = (<i>offset</i> , <i>transtype</i>)	0,NOTRAN
	LINE PCCTYPE = { <i>PCCname</i> <i>PCCid</i> USER}	offline: ANSI online: IBM4245
	LINE UCSB = {IGNORE PROCESS}	PROCESS
LINE VFU = { <i>VFUid</i> NONE}	NONE	
LMODIFY	LMODIFY = TEST	—
MESSAGE	MESSAGE ITEXT = { <i>sc</i> (<i>sc</i> , <i>passnum</i>) NONE WAIT}	NONE
	MESSAGE OTEXT = { <i>sc</i> (<i>sc</i> [, <i>passnum</i>]) [,WAIT] <i>sc</i> [, END] [, WAIT] NONE}	NONE

Table B-2. PDL command quick reference table (Continued)

Command	Syntax	Default
OUTPUT	OUTPUT BFORM = { <i>formid</i> (<i>formid</i> [, <i>init</i> [, <i>copies</i>]] [, INK[S], <i>inkref</i> ₁ [, <i>inkref</i> ₂] ...)}	NONE
	OUTPUT BINDING = {LONG SHORT}	LONG
	OUTPUT COLLATE = {YES NO}	YES
	OUTPUT COPIES = <i>number</i>	1
	OUTPUT COVER = <i>coveropt</i>	NONE
	OUTPUT CYCLEFORMS = { <i>formid</i> [, <i>formid</i>],...} (<i>formid</i> [, (INK[S], <i>inkref</i> [, <i>inkref</i>],...)) ([, <i>formid</i> [INK[S], <i>inkref</i> [, <i>inkref</i> [, ...]]]) NONE}	NONE
	OUTPUT DENSITY = {FIX NOFIX DEFAULT}	DEFAULT
	OUTPUT DESTINATION = {BIN TRAY EXPORT}	—
	OUTPUT DUPLEX = {YES NO}	NO
	OUTPUT FACEUP = {YES NO}	NO
	OUTPUT FEED = { <i>stockreference</i> ' <i>stockname</i> ' MAIN AUX OPR}	OPR
	OUTPUT FORMAT = <i>PDEid</i>	FMT1
	OUTPUT FORMS = { <i>formid</i> (<i>formid</i> [, <i>init</i> [, <i>copies</i>]] [, (INK[S], <i>inkref</i> [, <i>inkref</i>] ...)) NONE}	NONE; (<i>init</i> defaults to first or next copy.) FOR defaults to FORMAT if FORM[S] is not fully entered.)
	OUTPUT GRAPHICS = {NO YES MOVE BATCH (YES, NOSUB) (MOVE, NOSUB)}	NO
	OUTPUT IDFAULT = ' <i>inkref</i>	First ink in ILIST parameter
	OUTPUT IDR = <i>IDRname</i>	DFIDR.IDR
	OUTPUT IMAGE = (<i>vpos</i> {UN CM IN DOTS XDOTS} <i>hpos</i> , {UN CM IN DOTS XDOTS} [, <i>inkref</i>] ...))	Inches, top left corner scaled at 1 to 1
OUTPUT INVERT = {FRONT BACK BOTH NONE}	Installation default	
OUTPUT IRESULT = {BLACK COLOR}	Installation default	
OUTPUT LOGO = (<i>name</i> , <i>vpos</i> [<i>units</i>], <i>hpos</i> [<i>units</i>] [, INKS, <i>inkindex</i> ₁ [, <i>inkindex</i> ₂] [, ...]])	—	
OUTPUT MODIFY = { <i>CMEid</i> (<i>CMEid</i> , <i>init</i> [, <i>copies</i>]) NONE}	NONE	

Table B-2. PDL command quick reference table (Continued)

Command	Syntax	Default
OUTPUT (Continued)	OUTPUT NTO1 = {YES NO <i>n</i> }	NO
	OUTPUT NUMBER = {{(<i>pnum</i> <i>num,cnum</i> [, [<i>findex</i>] [, <i>inkref</i>]]) NO}	NO
	OUTPUT OFFSET = {ALL FIRST NONE}	ALL
	OUTPUT OSTK = (<i>stockdef</i> [, <i>mod</i>] [, <i>pos</i>] [, {RES NORES}] [,TABS] [, (<i>size</i> [, {DOTS IN CM})] [, {L P})	Installation default
	OUTPUT PAPERSIZE = {A3 A4 B4 B5 USLEGAL USLETTER (<i>x,y</i>)}	USLETTER or A4
	OUTPUT PURGE = {YES NO}	YES
	OUTPUT RESOLUTION = {300 600}	Installation default
	OUTPUT SF1FUNCTION = {YES NO}	NO
	OUTPUT SF2FUNCTION = {YES NO}	NO
	OUTPUT SHIFT = {{(<i>v₁</i> , <i>v₂</i>) YES NO}	NO
	OUTPUT SIZING = {SEMIAUTO BEST EXACT}	SEMIAUTO
	OUTPUT STAPLE = {NO YES}	NO
	OUTPUT STOCKS = <i>stocksetname</i>	—
	OUTPUT SYSPPR = {USLEGAL A3 A4 B4 B5 USLETTER (<i>x,y</i>)}	Size of last sheet before system page
	OUTPUT TMODE = { <i>width</i> (<i>width</i> [, <i>width unit</i>])}	NO
	OUTPUT TRANS = {YES NO}	—
	OUTPUT UNITS = { <i>size in dots</i> }	DEFAULT
	OUTPUT XMP = {DEFAULT REPORT}	NO
OUTPUT XSHIFT = {YES NO}, <i>value</i>	NO	
ac:PCC	ac:PCC ADVTAPE = {YES NO}	YES
	ac:PCC ASSIGN = {{(<i>byte, ccln</i>) (<i>byte, ccln</i> [, <i>ccln</i>] [, ...])}}	—
	ac:PCC DEFAULT = { <i>ccln</i> <i>PCCtype</i> }	DEFAULT
	ac:PCC INITIAL = {BOF TOF}	TOF
	ac:PCC MASK = <i>value</i>	X'FF'

Table B-2. PDL command quick reference table (Continued)

Command	Syntax	Default
ac:PDE	ac:PDE BEGIN = (<i>vpos</i> , <i>hpos</i>)	.18 IN, .66 IN
	ac:PDE FONTS = {(<i>f</i> ₁ [, <i>f</i> ₂] [, ...]) ((<i>f</i> ₁ , <i>s</i> ₁) [, (<i>f</i> ₂ , <i>s</i> ₂)] [, ...]) ((<i>f</i> ₁ , <i>s</i> ₁ [{{ <i>l</i> _{pi} XDOTS DOTS}}] [, (<i>f</i> ₂ , <i>s</i> ₂) [{{ <i>l</i> _{pi} XDOTS DOTS}}] [, ...])}	L0112B
	ac:PDE PMODE = {LANDSCAPE PORTRAIT}	LANDSCAPE
RAUX	RAUX TEST = <i>testexp</i>	—
RDELETE	RDELETE TEST = <i>testexp</i>	—
RECORD	RECORD ADJUST = <i>value</i>	0
	RECORD CONSTANT = <i>sc</i>	—
	RECORD FORMAT = <i>type</i>	BIN
	RECORD LENGTH = <i>value</i>	offline=133 online=150
	RECORD LMULT = <i>value</i>	1
	RECORD LTHFLD = <i>size</i>	0
	RECORD OFFSET = <i>value</i>	0
	RECORD POSTAMBLE = <i>length</i>	0
	RECORD PREAMBLE = <i>length</i>	0
RECORD STRUCTURE = <i>structure-type</i>	FB	
RFEED	RFEED TEST = (<i>testexp</i> , <i>stockdef</i>)	no default for <i>stockdef</i>
ROFFSET	ROFFSET PASSES = {FIRST ALL}	ALL
	ROFFSET TEST = <i>testexp</i>	—
ac:ROUTE	ac:ROUTE RFORM = { <i>form-id</i> NONE}	NONE
	ac:ROUTE RTEXT = { <i>sc</i> (<i>sc</i> [, { <i>passnum</i> ALL}] [, <i>line</i> [, <i>col</i> [, <i>fontindex</i>]]]) <i>rtextid</i> NONE}	NONE
RPAGE	RPAGE SIDE = { <i>sideopt</i> <i>offsetopt</i> }	NUFRONT, NOFFSET
	RPAGE TEST = <i>testexp</i>	—
	RPAGE WHEN = {BOTTOM NOW TOP}	TOP
RRESUME	RRESUME BEGIN = {CURRENT NEXT}	NEXT
	RRESUME TEST = <i>testexp</i>	—
RSELECT	RSELECT TEST = <i>testexp</i>	—

Table B-2. PDL command quick reference table (Continued)

Command	Syntax	Default
RSTACK	RSTACK ACCTINFO = (<i>offset</i> , <i>length</i>)	—
	RSTACK DELIMITER = {YES NO}	NO
	RSTACK HRPTNA = {(<i>offset</i> , <i>length</i>) NONE}	NONE
	RSTACK PRINT = {BIN BOTH TRAY NONE}	NONE
	RSTACK TEST = <i>testexp</i>	—
RSUSPEND	RSUSPEND BEGIN = {CURRENT NEXT}	NEXT
	RSUSPEND TEST = <i>testexp</i>	—
SAVE (DJDE only)	SAVE = {(<i>filename</i> [, ...]) ALL}	—
ac:SEFFNT	[<i>label</i> :] SEFFNT SEFMAP = ((<i>font</i> ₁ , <i>font</i> ₂), [(<i>font</i> _m , <i>font</i> _n)])	—
	SEFFNT MAP = <i>filename</i>	—
ac:STOCKSET	ac:STOCKSET ASSIGN = { <i>stockdescriptor</i> (<i>stockdescriptor</i> ₁ [, <i>stockdescriptor</i> ₂] [, ...])}	—
	ac:STOCKSET INIFEED = {' <i>stockname</i> ' <i>stockreference</i> }	first ' <i>stockname</i> '
	ac:STOCKSET SYSPAGE = {' <i>stockname</i> ' <i>stockreference</i> MAIN AUX}	—
ac:SYSTEM	SYSTEM JDL = <i>JDLname</i>	—
ac:TABLE	ac:TABLE CONSTANT = (<i>sc</i> ₁ [, <i>sc</i> ₂] [, ...])	—
	ac:TABLE MASK = (<i>ignore chart</i> ([, <i>charspec</i> ₁ [, <i>charspec</i> ₂] [, ...]))	—
ac:TCODE	ac:TCODE DEFAULT = <i>tcodetype</i>	—
	ac:TCODE TASSIGN = (<i>typespec</i> , {' <i>inputspec</i> ' ₁ (' <i>inputspec</i> ' ₂ [, ...])}	—
	ac:TCODE TRESET = (<i>typespec</i> , {' <i>inputspec</i> ' (' <i>inputspec</i> ' ₁ [, ...]) ALL}	—
ac:VFU	VFU ASSIGN = {(<i>channo</i> , <i>lineno</i>) <i>channo</i> , <i>lineno</i> [, <i>lineno</i>][, ...]}	—
	VFU BOF = <i>value</i>	66
	VFU TOF = <i>value</i>	1

Table B-2. PDL command quick reference table (Continued)

Command	Syntax	Default
VOLUME	VOLUME BMULT = <i>value</i>	1
	VOLUME CODE = { <i>keyword</i> <i>id</i> NONE}	EBCDIC
	VOLUME DBCODE = { <i>keyword</i> <i>id</i> }	—
	VOLUME DBCS = {YES NO}	NO
	VOLUME EMTYPE = {T1 T2}	T1
	VOLUME EOVS = {(PAUSE, EOF) (NOPAUSE, NOEOF)}	NOPAUSE, NOEOF
	VOLUME EXPAGE = {YES NO}	NO
	VOLUME HOST = <i>hosttype</i>	IBMOS
	VOLUME KANJI = {YES NO}	NO
	VOLUME KCODE = { <i>keyword</i> , <i>id</i> }	—
	VOLUME LABEL = <i>labeltype</i>	STANDARD
	VOLUME LCODE = { <i>keyword</i> <i>id</i> }	EBCDIC
	VOLUME LPACK = {YES NO}	NO
	VOLUME MAXLAB = <i>value</i>	81
	VOLUME MINLAB = 80	80
	VOLUME OPTIMIZE = { <i>keyword</i> (<i>keyword</i> [, <i>keyword</i> [, ...]]) NONE}	NONE
	VOLUME OSCHN = <i>value</i>	9
	VOLUME OSHDP = <i>value</i>	0
	VOLUME OSTLP = <i>value</i>	0
	VOLUME PLABEL = {YES NO}	NO
	VOLUME RMULT = <i>value</i>	1
VOLUME RSAT = {SPLIT REMOUNT}	REMOUNT	
VOLUME TCODE = { <i>tcodetype</i> <i>tcodename</i> }	EBCDIC	
VOLUME UNPACK = {T4X3 T4X3H2 UNIVAC NONE}	NONE	
VOLUME VCODE = (<i>translation type</i> , <i>keyword</i>)	—	

C. Character code assignments

The charts in this section illustrate the following character code assignments:

- IBM BCD code set
- Honeywell/Bull 200 and 2000 BCD code set
- Honeywell/Bull 6000 BCD code set
- Fielddata translation
- UNIVAC ASCII character set
- Standard ASCII character set
- Standard EBCDIC character set
- Xerox EBCDIC to extended ASCII hexadecimal translation values

IBM BCD code set

Table C-1. IBM BCD code set

		Most significant bits							
Octal (columns)		0	1	2	3	4	5	6	7
(rows)	Binary	000	001	010	011	100	101	110	111
0	000		8		Y	–	Q	&	H
1	001	1	9	/	Z	J	R	A	I
2	010	2	0	\$		K		B	&
3	011	3	#	T	,	L	\$	C	.
4	100	4	@	U	%	M	*	D	<
5	101	5	'	V	_	N)	E	(
6	110	6	=	W	>	O	;	F	+
7	111	7		X	?	P		G	

Honeywell/Bull 200 and 2000 BCD code set

Table C-2. Honeywell/Bull 200 and 2000 BCD code set

		Most significant bits							
Octal (columns)		0	1	2	3	4	5	6	7
(rows)	Binary	000	001	010	011	100	101	110	111
0	000	0	8	+	H	–	Q	<	Y
1	001	1	9	A	I	J	R	/	Z
2	010	2	'	B	;	K	#	S	@
3	011	3	=	C	.	L	\$	T	,
4	100	4	:	D)	M	*	U	(
5	101	5		E	%	N	*	V	{
6	110	6	<	F	[O]	W	}
7	111	7	&	G	?	P	!	X	

Honeywell/Bull 6000 BCD code set

Table C-3. Honeywell/Bull 6000 BCD code set

		Most significant bits							
Octal (columns)		0	1	2	3	4	5	6	7
(rows)	Binary	000	001	010	011	100	101	110	111
0	000	0	8	space	H	¬ ^	Q	+	Y
1	001	1	9	A	I	J	R	/	Z
2	010	2	[B	&	K	-	S	_
3	011	3	#	C	.	L	\$	T	,
4	100	4	@	D]	M	*	U	%
5	101	5	:	E	(N)	V	=
6	110	6	>	F	<	O	;	W	“
7	111	7	?	G	/	P	'	X	!

Fielddata translation

Table C-4. Fielddata translation

		Most significant bits							
Octal (columns)		0	1	2	3	4	5	6	7
(rows)	Binary	000	001	010	011	100	101	110	111
0	000	@	C	K	S)	*	0	8
1	001	[D	L	T	-	(1	9
2	010]	E	M	U	+	%	S	_
3	011	#	F	N	V	<	:	3	;
4	100	^	G	O	W	=	?	4	/
5	101	blank	H	P	X	>	!	5	.
6	110	A	I	Q	Y	&	.	6	“
7	111	B	J	R	Z	\$	/	7	_

UNIVAC ASCII character set

Table C-5. UNIVAC ASCII character set

Octal	Character	Octal	Character	Octal	Character
040	blank	100	@	140	\
041	!	101	A	141	a
042	"	102	B	142	b
043	#	103	C	143	c
044	\$	104	D	144	d
045	%	105	E	145	e
046	&	106	F	146	f
047	/	107	G	147	g
050	(110	H	150	h
051)	111	I	151	i
052	*	112	J	152	j
053	+	113	K	153	k
054	,	114	L	154	l
055	-	115	M	155	m
056	.	116	N	156	n
057	/	117	O	157	o
060	0	120	P	160	p
061	1	121	Q	161	q
062	2	122	R	162	r
063	3	123	S	163	s
064	4	124	T	164	t
065	5	125	U	165	u
066	6	126	V	166	v
067	7	127	W	167	w
070	8	130	X	170	x
071	9	131	Y	171	y
072	:	132	Z	172	z
073	;	133	[173	}

Table C-5. UNIVAC ASCII character set

Octal	Character	Octal	Character	Octal	Character
074	<	134	\	174	
075	=	135	}	175	{
076	>	136	^	176	~
077	?	137	_	177	null

Standard ASCII character set

Table C-6. Standard ASCII character set

		Most significant bits															
		0	1	2	3	4	5	6	7	8	9	A	B	C	D	E	F
Hexa- decimal	Bi- nary	00 00	00 01	00 10	00 11	01 00	01 01	01 10	01 11	10 00	10 01	10 10	10 11	11 00	11 01	11 10	11 11
	0	0000			0	@	P	c	p								
1	0001			!	1	A	Q	a	q								
2	0010			“	2	B	R	b	r								
3	0011			#	3	C	S	c	s								
4	0100			\$	4	D	T	d	t								
5	0101			%	5	E	U	e	u								
6	0110			&	6	F	V	f	v								
7	0111			‘	7	G	W	g	w								
8	1000			(8	H	X	h	x								
9	1001)	9	I	Y	i	y								
A	1010		{	*	:	J	Z	j	z								
B	1011			+	;	K	L	k									
C	1100		}	,	<	L	\	l									
D	1101		~	-	=	M]	m									
E	1110		¼	.	>	N	^	n									
F	1111		½	/	?	O	_	o									

Standard EBCDIC character set

Table C-7. Standard EBCDIC character set

Hexa- decimal		Most significant bits															
		0	1	2	3	4	5	6	7	8	9	A	B	C	D	E	F
	Bi- nary	00 00	00 01	00 10	00 11	01 00	01 01	01 10	01 11	10 00	10 01	10 10	10 11	11 00	11 01	11 10	11 11
0	0000						&	-		¼	½			{	}	\	0
1	0001							/		a	j			A	J		1
2	0010									b	k	s		B	K	S	2
3	0011									c	l	t		C	L	T	3
4	0100									d	m	u		D	M	U	4
5	0101									e	n	v		E	N	V	5
6	0110									f	o	w		F	O	W	6
7	0111									g	p	x		G	P	X	7
8	1000									h	q	y		H	Q	Y	8
9	1001							c	i	r	z			I	R	Z	9
A	1010					c	!	^	:								
B	1011					.	\$,	#	{	}						
C	1100					<	*	%	@								
D	1101					()	_	'			[]				
E	1110					+	;	>	=								
F	1111						~	?	"								

Xerox EBCDIC to extended ASCII hexadecimal translation values

Table C-8. Xerox EBCDIC to extended ASCII hexadecimal translation values

Hexa- decimal		EBCDIC most significant digit															
		0	1	2	3	4	5	6	7	8	9	A	B	C	D	E	F
	Bi- nary	00 00	00 01	00 10	00 11	01 00	01 01	01 10	01 11	10 00	10 01	10 10	10 11	11 00	11 01	11 10	11 11
0	0000	20	FA	EA	DA	20	26	2D	B0	1E	1F	BC	B0	1A	1C	5C	30
1	0001	20	F9	E9	D9	CA	C1	2F	AF	61	6A	7B	B1	41	4A	9F	31
2	0010	20	F8	E8	D8	C9	C0	B8	AE	62	6B	73	B2	42	4B	53	32
3	0011	20	F7	E7	D7	C8	BF	B7	AD	63	6C	74	B3	43	4C	54	33
4	0100	20	F6	E6	D6	C7	BE	B6	AC	64	6D	75	B4	44	4D	55	34
5	0101	20	F5	E5	D5	C6	BD	B5	AB	65	6E	76	B5	45	4E	56	35
6	0110	20	F4	E4	D4	C5	BC	B4	19	66	6F	77	B6	46	4F	57	36
7	0111	20	F3	E3	D3	C4	BB	B3	18	67	70	78	B7	47	50	58	37
8	1000	20	F2	E2	D2	C3	BA	B2	AA	68	71	79	B8	48	51	59	38
9	1001	20	F1	E1	D1	C2	B9	B1	60	69	72	7A	B9	49	52	5A	39
A	1010	20	F0	E0	D0	60	21	5E	3A	A9	90	91	A8	A7	A3	9E	1B
B	1011	FF	EF	DF	CF	2E	24	2C	23	1A	1C	7D	17	A6	A2	9D	99
C	1100	FE	EE	DE	CE	3C	2A	25	40	10	12	7E	7F	13	8F	15	98
D	1101	FD	ED	DD	CD	28	29	5F	27	BA	8D	5B	5D	A5	8E	9C	97
E	1110	FC	EC	DC	CC	2B	3B	3E	30	BB	7C	11	95	14	A1	9B	96
F	1111	FB	EB	DB	CB	1B	1D	3F	22	94	93	92	16	A4	A0	9A	20

NOTE: Values on the **perimeter** are EBCDIC. Values within the **blocked rectangles** are ASCII.

Example: An EBCDIC value of AB is equivalent to an ASCII value of 7D.

D. Offline specifications

This appendix provides specifications for tapes for offline printing.

Input unpacking examples

The following figure shows several input unpacking examples.

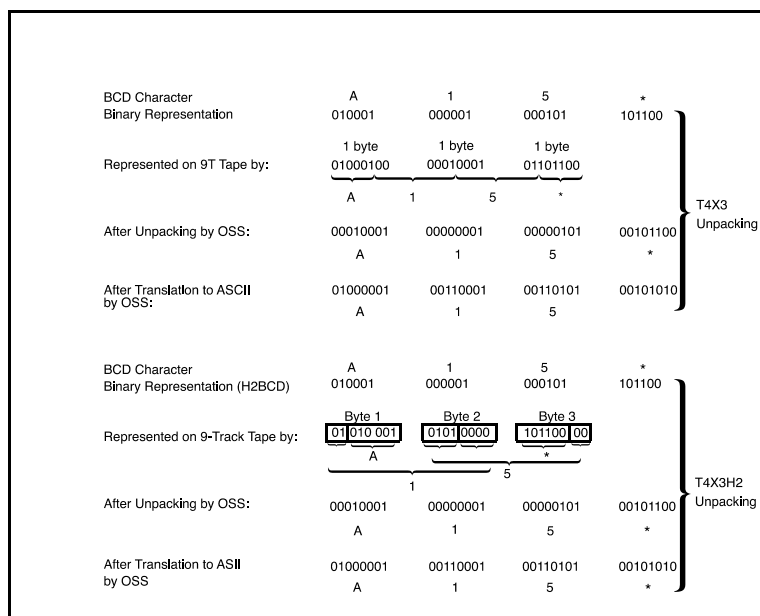

Figure D-1. Input unpacking examples

Valid host computer and label specifications

Table D-1. Valid host computer and label specifications

Host type	Label specifications					
	Unlabeled	ANSI	Standard	System print	COBOL	Undef .
ACOS4		x				
ANSI		X				
Burroughs medium systems: B2500	X	X	X			
B2700	X	X	X			
B3700	X	X	X			
B4700	X	X	X			
Burroughs large system: B6700	X	X	X			
DUMP	Label specification is ignored.					
FUJITSU	X					
FXEWTR						
GRASP POWER POWERVS	Label specification is ignored.					
HITACHI						
Honeywell/Bull 200/2000 series: H2000			X	X	X	
Honeywell/Bull 600/6000 series: H6000 H6ASC H6BCD			X X X			
IBM3200						
IBMOS	X	X	X			
IBMDOS	X	X	X			
IBMUTY/IBMDBS						
ICL2900			X			

Table D-1. Valid host computer and label specifications

Host type	Label specifications					
	Unlabeled	ANSI	Standard	System print	COBOL	Undef .
NEC			X			
NCR	X		X			
OLDUMP	Label specification is ignored.					
OSWTR		X	X			
OCTDUMP	Label specification is ignored.					
RSX11	X					
STDOUT						
Undef.						X
UNIVAC	X	X	X			
US70	X	X	X			
XEROX	X	X	X			

Each shaded area of this table shows the label that is substituted by PDL when an invalid host/label pair is specified. Each X indicates a valid label specification parameter for each type of host.

Host system JDLs on system software CD

Job description library (JDL) source files that are supplied on the FreeFlow Print Server software CD are summarized in the following table.

Table D-2. JDL source files on software CD

JDL	JDEs provided for:										
DUMP or DUMPA4	Tape dumps of various tape formats where: <table border="0"> <tr> <td>JDE</td> <td>Characteristics</td> </tr> <tr> <td>2-or-EBCDIC</td> <td>EBCDIC</td> </tr> <tr> <td>3-or-ASCII</td> <td>ASCII</td> </tr> <tr> <td>5-or-IBMBCD</td> <td>IBM BCD</td> </tr> <tr> <td>6-or-UNIVAC</td> <td>UNIVAC Fieldata</td> </tr> </table>	JDE	Characteristics	2-or-EBCDIC	EBCDIC	3-or-ASCII	ASCII	5-or-IBMBCD	IBM BCD	6-or-UNIVAC	UNIVAC Fieldata
JDE	Characteristics										
2-or-EBCDIC	EBCDIC										
3-or-ASCII	ASCII										
5-or-IBMBCD	IBM BCD										
6-or-UNIVAC	UNIVAC Fieldata										
IBMRCA	IBM OS and DOS standard-labeled tapes IBM ANSI-labeled and OS Writer tapes US70 RCA-labeled tapes										
OLDUMP	Online dumps of host transmissions										
ONLINE	Online with or without banner or trailer pages										
UNIVAC	Univac DF-formated tapes										
XEROX	ANSI-labeled tapes Unlabeled tapes Xerox ANSI-labeled tapes JDEs to print unknown tapes Printing tapes without attempting to deblock the tape properly										

After an LPS software system is created by the user, the source for these JDLs is resident in the JSL directory. Use **xjdc** commands to obtain a printout of the desired JDLs. Refer to the "Compiling a JSL" section in the "PDL principles and procedures" chapter for information on managing JDLs.

LPS tape label format

LCDS resources (such as JDLs) that reside on LPS formatted tapes may be downloaded to the printing system disk from a host mainframe computer by means of

. The format of the tapes that may contain these resources is shown in the following diagram.

In this diagram, each rectangle represents a record that contains one or more bytes of data. The table that follows it lists the pieces of information that are contained within each record.

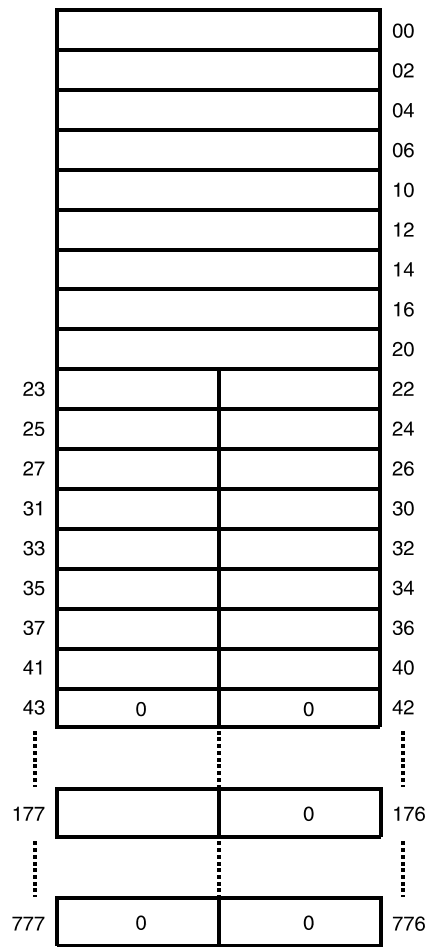

Figure D-2. LPS tape format diagram

Table D-3. Content of tape records

Byte range	Information contained in record	Additional information
00–02	File name	If not used, must be zero.
04	File type (RAD–50)	
06	File size in 512–byte blocks	
10	First free byte	
12	Date (DOS format)	Not used
14	Record size in bytes	80 for text; otherwise, 512
16	Tape block size in bytes	
20	Reserved for future use	
22–32	ASCII file name (9 characters).	Currently only 6–character file names are supported. Unused file name characters must be filled with 0.
33–35	ASCII file type	
42–176	Contain 0	
177	ASCII * (052)	
200–777	Contain 0	

NOTE: Characters in the ASCII file name and type fields must be in the RAD–50 (Radix-50) character set. The following table defines the RAD-50 character set.

Table D-4. RAD–50 character set

RAD–50 character	ASCII Octal value	RAD–50 Octal value	RAD–50 decimal value
(space)	040	000	000
A–Z	101–132	001–032	1–26
\$	044	033	27
.	056	034	28
(undefined)		035	29
0–9	060–071	036–047	30–39

Glossary

A3	Paper size measuring 297 by 420 mm.
A4	Paper size measuring 210 by 297 mm.
ACT	Advanced Customer Training
AFP	Advanced Function Printing
AIM	Ancillary IOT message processor. System task that initializes the client layer between the printer and the print server. It also displays the Fault, Hint, and information messages.
algorithm	Computational procedure that can be repeated any number of times.
alphanumeric	Set of characters including the letters A through Z, numerals 0 through 9, and all printable special symbols.
ANSI	American National Standards Institute
ascender	Portion of alphabetic character that rises above the body of the character (its x-height portion). See also descender; x height.
ASCII	American Standard Code for Information Interchange. Standard 7-bit code that represents alphanumeric information. Each alphanumeric character and several nonprinting characters are assigned a binary number, covering 128 possible characters. It is used for information interchange among data processing systems, data communication systems, and associated equipment.
asynchronous	Transmission in data communications controlled by start and stop elements at the beginning and end of each character. Thus, time intervals between transmitted characters may be unequal in length.
audit log	Captures the sheet delivery information for every page in an audited report, certain details about each sheet, the planned and actual report control totals, and waste management.
auxiliary menu	Menu that contains options not displayed in a window. The symbol for an auxiliary menu is a box containing three horizontal lines.
B4	Paper size measuring 250 by 353 mm.

background job Low-priority job, usually batched, that is executed automatically as system resources become available.

batch processing Allows for repetitive operations to be performed sequentially on batched data without much involvement of the computer operator.

BCD binary coded decimal

binary Numbering system based on 2 that uses only the symbols 0 and 1. Binary is used in computers and related devices since information can be represented with electric pulses (0=off, 1=on). Most computer calculations are binary.

binary digit (bit) In the binary numbering system, either of the characters 0 or 1. The "bit" is the base unit of information used by computers. It can take the form of a magnetized spot, an electric pulse, or a positive or negative charge. A sequentially stored set of bits represents a character on a computer.

Multipliers are:

1 or 0 byte = 8,192 bits

kilobyte (KB) or 1,024 bytes = 8,388,608 bits.

Computer space equivalents are:

1.5 KB = about 1 single-spaced typed page

30 KB = about 20 typed pages

150 KB = about 100 typed pages

bit Abbreviation for binary digit, the smallest unit of information recognized by a computer. See also binary digit.

bit map Visual representation of graphic images in which a bit defines a picture element (pixel); for example, if a bit is 1, the corresponding pixel is printed.

blocking Process of combining two or more records into a single block of data which can then be moved, operated upon, or stored, as a single unit by the computer.

block length Number of characters or bytes contained in a block of data (the block is treated as a unit within the computer). Block length is usually invariable within a system and may be specified in units such as records, words, computer words, or characters.

BOF bottom of form

BOT beginning of tape

bpi bits per inch

bps	bits per second. In serial communication, the instantaneous bit speed with which a device or channel transmits a character.
BSC	binary synchronous communication. 1. Communication using binary synchronous line discipline. 2. Uniform procedure using a standardized set of control characters and control character sequences for synchronous transmission of binary-coded data between stations.
buffer	Compartment of memory in which this data is stored during transfer from one device to another. This is useful for accumulating data into blocks before storage or processing and for adjusting differences of speed between devices, or between a device and a communicating facility.
Bypass Transport	Optional module that moves paper from the last stacker bin to a finishing device.
byte	Fixed number of bits (in data processing, usually 8) operated upon as a unit. A byte may represent a character, a machine instruction, or some other logical unit of information.
CDC	control data communications
channel	1. In data communications, a path or line that enables two or more devices to communicate (sometimes called a circuit, facility, or link). 2. In computers, a path for communication between the central processing unit (CPU) and input/output units, or between the CPU and peripheral devices.
character code	Code representing alphanumeric information, for example, ASCII.
character code identifier	Code associated with the universal identifier "Xerox" to indicate the version of the Xerox character code standard used to code Interpress strings.
character set	Number of different characters used by a particular device, including alphabetic, numeric, and special characters such as symbols.
client layer	The software interface used by the print server to communicate with the printer, allowing printing commands and fault and status information to be exchanged.
clocking	A method of synchronizing the sending and receiving of data communications devices. Clocking allows synchronous transmission at high speeds.
cluster	A term that is used with LPS systems, referring to a defined group of feeder trays, usually containing the same size and type of (stock). Each cluster has a name, consisting of one to six alphanumeric characters. See also stock; stockset.

CME	copy modification entry. Entry modifying the output printing characteristics of a report on a copy-to-copy basis.
collate	To arrange or assemble into ordered sets.
compiler	Software that translates instructions written in high-level language into machine language for execution by a system.
concatenate	To connect or link in a series, as when files are grouped together for faster processing. See also job concatenation mode.
consumable supplies	Supplies such as paper and dry ink that are depleted (used up) during the course of normal printer operation.
coordinate	Point on the x and y axis that determines a grid position.
copy-sensitive	Term used to indicate jobs in which multiple copies of a report will contain different data, as with paychecks and banking statements.
cpi	characters per inch. Designates the number of characters per inch for a particular typeface. See also pitch.
CPU	central processing unit. Interprets and executes instructions, performs all operations and calculations, and controls input and output units and auxiliary attachments.
database	Information to meet specific processing and retrieval needs. Generally applies to integrated file of data, arranged for access by many subsystems.
data rate	In data communications, the rate at which a channel carries data, measured in bits per second (bps).
DCE	data communications equipment
DDCMP	Digital Data Communication Message Protocol
debug	To detect and correct errors in a program.
decompose	To break down into component parts, such as when Interpress breaks down a Font Interchange Standard (FIS) master to compile font information.
descender	Portion of alphabetic character that extends below the baseline. See also ascender, x height.
DFA	Document Feeding and Finishing Architecture
DJDE	Dynamic Job Descriptor Entry. Command within an input data stream used to modify the printing environment dynamically.
dot	Unit of measurement representing a fraction of an inch, for example, 300 dots per inch (dpi). It may also be referred to as a picture element (pixel) or spot.
dpi	dots per inch

dry ink	Minute dry particles of resin and carbon black used to create images. Dry ink can accept an electrical charge.
DSU	digital signal unit
DSR	disk save and restore
DTE	data terminal equipment
dump session	The online dump feature is a troubleshooting tool for print jobs, allowing you to generate hardcopy of the command and data transmission taking place between the host computer and the printing system while a job is being transmitted and printed.
duplex printing	Printing on both sides (front and back) of a page. See also simplex printing.
EBCDIC	Extended Binary Coded Decimal Interchange Code. Coded character set consisting of 8-bit coded characters. It can accommodate 256 characters.
edgemarking	Use of graphic objects, usually lines or boxes, that bleed off the edge of the physical page. See also physical page.
ENET	Ethernet network
EOT	end of tape
EP	electronic publishing
ESS	electronic subsystem
Ethernet	Network system that allows data to be transmitted by cable from one device to another, enabling it to share the network.
extended metrics	Measurements used in Interpress to alter the size of fonts, allowing more precision with character escapement. Used for rendered characters.
FCB	forms control buffer. Buffer for controlling the vertical format of printed output.
FCP	file control parameter
FDL	forms description language. LPS-resident source language used for designing electronic forms. See also FSL; form.
field	1. Part of a record that serves a similar function in all records of that group, such as name and address field. 2. Area or setting of practical activity or application.
FIS	Font Interchange Standard. Standard that defines the digital representation of fonts and character metrics for the generation of an entire series of Interpress fonts.
fixed font	Font containing characters with fixed spacing. See also proportional font.

fixed pitch	Font set in which every character cell has the same width. In reference to character sets, this term describes typefaces in which all character cells are of equal width; monospaced as opposed to proportional spaced.
fixed spacing	Arrangement of characters on a line so that all characters occupy the same amount of horizontal space.
floating accent	Nonspacing accent characters that can be combined with characters and printed as a composite.
form	1. Compiled forms source library (.FSL) file. 2. Printed or typed document with blank spaces for inserting information. Specific arrangement of lines, text, and graphics stored in a computer under an identifying name. Page of data that, when preceded by proper commands, is stored on the system disk as a permanent file. It may be merged with variable data by a form start command. See also FDL; FSL.
format	1. Layout of a document, including margins, page length, line spacing, typeface, and so on. 2. In data storage, the way the surface of a disk is organized to store data. 3. To prepare the surface of a disk for acceptance of data.
form feed	Keyboard or printer control character that causes the printer to skip the top of the next page.
FPS	formatting print service
FSL	forms source library. Uncompiled collection of user-created files containing FDL commands. See also FDL; form.
FST	font specification table
GCR	group code recording mode. Refers to the specific density of data (such as 6250 bpi) as it is recorded on tape, which is measured in bits per inch (bpi).
grid unit	Smallest rectangle enclosed by horizontal and vertical lines on a grid. The size of a grid unit is expressed as the length of one side of a rectangle.
gsm	grams per square meter
halftone screen	A tool used in offset printing, typesetting, and laser printing to convert a continuous tone (such as photographic) image to dots, which allows the image to be rendered accurately in these printing processes.
HCF	high-capacity feeder. Feeder tray capable of holding 2500 sheets of 20 pound/75 gsm paper.

HCS	high-capacity stacker. Stacker bin capable of holding 2500 sheets of 20 pound/75 gsm paper. In the LPS, the high-capacity stacker bins are located in the top half of the feeder/stacker modules.
hexadecimal	Numbering system with a base of 16. In this system, 10 through 15 are represented by A through F, respectively.
HFDL	host forms description language
hierarchy	Relative priority assigned to arithmetic or logical operations that must be performed.
HIP	Host Interface Processor
host	Computer accessed by users which serves as a source of high-speed data processing for workstations with less computer power.
host interface	Connection between network and host computer.
hpos	horizontal positioning
id	identifier. Character used to identify or name data and possibly to indicate certain properties of that data.
IFU	Interpress font utility
IG	image generator
IGM	image generator module
image area	Area on a physical page that may contain text or graphics.
initialize	1. To prepare the magnetic surface of a blank diskette so that it can accept data. 2. To set all information in a computer system to its starting values (usually the first step is accomplished when a program is booted).
input/output	General term encompassing the flow of data into and out of a system.
interface	Device by which two systems connect and communicate with each other.
interpolation	Series of logical rules implemented in the printer to convert a 300 spi input video stream to a 600 spi output video stream. Interpolation is functionally analogous to bit doubling (2x scaling), except the logical rules result in superior output.
Interpress	Xerox standard that defines digital representation of lines for printing. Interpress documents can be printed on any sufficiently powerful printer equipped with Interpress print software.
Interpress font utility (IFU) program	Program used to convert FIS fonts to LPS fonts.

Interpress master	File written according to the Interpress standard.
I/O	input/output
IOM	image output module
IOT	input output terminal, also referred to as “printer”
IPD	Interpress decomposer
IPFONTS	Interpress fonts
IPL	initial program load. For the optional open-reel tape drive, the internal initialization sequence whereby certain functions are loaded into random access memory (RAM).
IPM	Interpress mapping
ips	inches per second
JCB	job control block
JCL	job control language
JDE	job descriptor entry. Collection of job descriptions. See also JSL.
JDL	job descriptor library. Collection of compiled job descriptions. See also JSL.
JID	job identifier
job concatenation mode	In HIP, a mode in which multiple print jobs are processed as reports in one print job. See also concatenate.
job control	Program called into storage to prepare each job or job step to be run.
job management	Collective functions of job scheduling and command processing.
JSL	job source library. Collection of uncompiled job descriptions. See also JDE; and JDL.
keyword	Required part of a command.
label	1. In data storage, a reference to a file saved on tape or disk, a record indicating the file name or date created, or other control information. 2. In programming, a name assigned to a particular instruction or portion of a program as a locational reference (the computer translates the label into an address).
LAN	local area network
landscape page orientation	Orientation of print lines or top of an illustration parallel to the long edge of the paper if the sheet is within the standard size range. (Sheets larger than standard have the reverse print orientation.)
latent image	Static charge present on the photo conductor before contact with dry ink particles.

leading	1. Vertical distance between lines (also called line space), measured from a baseline of one line to the baseline of the next. 2. Extra spacing between lines of type. 3. In typography, spacing between lines and paragraphs.
LED	light emitting diode. Solid substance that glows when a current is passed through it. Often used for indicator lights on disk drives or modems, as well as for displays on other electronic equipment.
LEF	long-edge feed. The movement of paper through the printer in the direction of the paper length (the longer side of a sheet of paper).
legal size	Sheet the standard size of legal briefs, 8.5 by 14 inches.
LF	long-edge feed
letter size	Paper sized 8.5 by 11 inches/216 by 279 mm.
library	In data storage, a collection of related files or programs.
line tables	Internal data structures providing a record in memory of lines to be drawn on a page.
literal	Alphanumeric beginning with a letter, optionally including an asterisk, period, colon, or slash, and not enclosed in single quotes.
log	Collection of messages or message segments placed on an auxiliary storage device for accounting or data collection purposes.
logical page	In the Xerox printing systems environment, a formatted page that is smaller than the physical page. A logical page is defined by an origin, thus allowing more than one logical page to be placed on a physical page.
lpi	lines per inch
LPS	Laser Printing System
mask	1. Selection of bits from a storage unit by using an instruction that eliminates the other bits in the unit. 2. In accessing files, a file name mask is used to reference one or more files with similar file-id (identifier) syntax. 3. In Interpress, a mask serves as a template, indicating the shape and position of an object on a page.
MB	megabyte. Unit of one million bytes.

metacode	Same as “native mode.” Method of speaking to and controlling the image generator. These controls are used by the character dispatcher to generate scan line information. This information is sent in the form of character specifications to the image generator, which uses it to compose the bit stream that modulates the laser.
MHz	megahertz. 1. Unit of cycling speed (one million cycles per second) for an electromagnetic wave (in particular, a radio wave). 2. Sending and receiving stations of a radio wave transmission must be tuned in to the same unit of megahertz.
MICR	Magnetic Ink Character Recognition. MICR allows a computer to read characters printed in special metallic ink by scanning the shapes of their magnetic fields. MICR fields are often imprinted on bank checks before processing.
module	Cohesive unit within a program. It is consistent in its level and identifiable in terms of loading or with other units.
MTU	magnetic tape unit (refers to the 9-track magnetic tape drive; also referred to as “magnetic tape drive”)
nonimpact printer	Printer that forms characters without any strikes of a key or element against the paper.
object file	Source file converted into machine language (binary code).
OCR	optical character recognition
offset	To place pages currently being printed in slightly different positions from previous pages.
OLI	online interface
operating system	Basic host- or LPS-resident controlling program that governs the operations of a computer, such as job entry, input/output, and data management. The operating system is always running when the computer is active. Unlike other types of programs, it does not run to an end point and stop. The operating system of a Xerox LPS is referred to as the operating system software (OSS).
orientation	1. In reference to image area, orientation describes whether the printed lines are parallel to the long edge of the paper or the short edge of the paper. 2. Choice of printing portrait (vertically) or landscape (horizontally).
origin	In reference to image area, this is the upper left corner of a sheet.
OS	operating system

output	1. Material produced by a peripheral device of a computer, such as a printout or a magnetic tape. 2. Result of completed operations.
overprinting	Printing more than one character at the same position.
overprint ratio	Maximum number of variable data and form characters that may be intersected by a single scan line.
page	1. In computer programming, a block of instruction, data, or both that can be located in main or auxiliary storage. 2. In word processing, a defined section of a document.
page orientation	Direction in which data is printed on a report. See also landscape page orientation; portrait page orientation.
parameter	Part of a command other than the keyword.
pass-through job	On systems with XPAF, a job that is sent directly from a host to a Xerox printer using XPAF, without undergoing XPAF processing. See also XPAF.
patch	In programming, to modify a portion of the program at the machine language level, as opposed to modifying at the source program level.
PCC	printer carriage control
PDL	print description language. Language used to describe printing jobs to an LPS. PDL describes the input (type, format, characteristics), performs the processing functions (logical processing), and describes the output (type, format, font selection, accounting options).
pitch	1. Horizontal character spacing; 10-pitch (10 characters per inch) spacing is called pica, and 12-pitch (12 characters per inch) spacing is called elite. 2. The number of page images placed on the xerographic belt during one revolution.
pixel	Acronym for picture element. Smallest addressable point of a bit-mapped screen that can be independently assigned color and intensity. Pixels are definable locations on a display used to form images. For graphic displays, more pixels generally provide higher resolution. Spots, dots, and pixels are used interchangeably.
point	Unit of measurement equal to 0.0139 inch. Points are always used to express type size and leading. There are 12 points to a pica and about 72 points to every inch. See also pica.
portrait page orientation	Orientation of print lines or the top of an illustration parallel to the short edge of the paper if the sheet is within the standard size range. Sheets larger than standard have the reverse print orientation.

ppm	pages per minute
PQA	print quality adjustment
PROM	programmable read-only memory
proportional font	Font containing characters that vary in width. See also fixed font.
proportional spacing	Text in which each alphanumeric character is given a weighted amount of space. Such output has print-like appearance. Proportional spacing allows more space for wide characters and less space for narrow characters
protocol	Formal set of conventions governing the format of data and the control of information exchange between two communication devices.
purge	To delete data from a system.
PWBA	printed wiring board assembly
QIC	quarter-inch cartridge
queue	List of documents waiting to be processed.
RAM	random access memory. Storage that allows data, such as documents, to be stored and retrieved directly by address location without reading through any other data.
raster data	Binary data, usually consisting of dots arranged in scan lines, according to the print order.
rasterization	Creation of a page's bit map image for printing.
record	Collection of data or words treated as a unit.
recovery	Act of overcoming a problem or error during processing. Typically, a specialized software recovery routine gains control and attempts to resolve the error without crashing the system.
remote access	Access to a central computer by terminals or devices geographically separated from that computer.
report	In setting a separation boundary through the Bin Full Criteria task, report refers to a subset of a job (a job may consist of one or more reports).
resolution	Number of dots per unit. The LPS imaging system converts a character from digitized data into a printed image composed of these tiny dots. The greater the number of dots per inch, that is, the resolution, the clearer the image that is produced.
ROM	read-only memory. Solid-state memory for programs. It cannot be rewritten.
ROS	raster output scanner
SAFES	stand-alone field engineering software

scale	To adjust font or image size according to given proportions.
SCSI	small computer system interface. Accepted standard for connecting peripheral devices to computers.
SDLC	synchronous data link control
SEF	short-edge feed. The movement of paper through the printer in the direction of the paper width (the shorter side of a sheet of paper).
sequential	In numeric sequence, usually in ascending order. As applied to a file organization, describes files in which records are written one after another and cannot be randomly accessed. For example, the first 99 records in a sequential file-access file have to be read before the 100th record is accessible.
set	In setting a separation boundary through the Bin Full Criteria task, set refers to multiple copies of the same report.
simplex printing	Printing on one side of the page. See also duplex printing.
SNA	system network architecture
sort	To rearrange data records according to a particular item (field) which they all contain, using a predetermined ordering scheme.
source	Terminal node at which data enters a network. For example, a computer transmitting data through telecommunication lines to several other computers or receiving terminals.
source language	Language, high-level or low-level, used by a programmer. A source language must be converted by a compiler to machine language for the instructions to be executed.
spi	spots per inch
spooling	Process of releasing data from main memory and storing it temporarily until a peripheral device is ready to accept it, for example storing text before sending it to a printer.
spot	Unit of measurement representing a fraction of an inch, for example, 300 spots per inch (spi). May also be referred to as a picture element (pixel) or dot.
static data	Information usually found on preprinted forms or overlays.
stock	User-defined name in the JSL that specifies a certain type of paper for printing a job. See also cluster.
stockset	Collection of stocks to be used on a print job. See also stock; cluster.
string	Connected sequence of alphanumeric characters treated as one unit of data by a program.

synchronous	Efficient encoding of data suitable for high-speed, block-oriented data transmission by using equal time elements.
sysgen	system generation
syntax	Rules governing the structure of expressions in a programming language.
system controller	Part of the system that provides interfacing capability, data handling, formatting, buffering, and operator control for the system.
tape density	Number of characters that can be stored on magnetic media, such as how close together data can be recorded. The Xerox LPS may use either 1600 bpi or 6250 bpi density magnetic media.
task	1. Any major job performed by a computer. 2. One of several programs being executed by a system.
teleprocessing	Sending and receiving data through telecommunication lines for processing among various remote terminals and the central processing unit (CPU).
throughput	In data processing systems, the amount of data that can be processed, transmitted, printed, and so on, per a specified unit of time.
TL/DL	text line/display list
TOF	top of form
tpi	tracks per inch
TPJ	test pattern job
trailer	In data communications, the last portion of a message that signals the end.
transaction processing	Method of data processing in which files are updated and results are generated immediately after data entry.
truncated	Cut off before completion, as when data transfer from a host to a printer is cut off before all data has been transmitted.
two-up	Application that prints two logical pages on one side of a physical page.
typeface	1. All type of a single design. 2. Set of characters with design features that make them similar to one another.
type size	Height of a typeface, measured from the bottom of its descenders to the top of its ascenders, expressed in points.
type style	Italic, condensed, bold, and other variations of typeface that form a type family.

TXC	total xerographic convergence
UCS	Universal Character Set. Printer feature that permits the use of a variety of character
UCSB	Universal Character Set Buffer
UI	user interface
UNIX Text Editor	Editing window on a UNIX workstation print server, used to code PDL commands in a JSL.
utility program	General-purpose program that performs activities, such as initializing a disk or sorting, which are not specific to any application.
validation	Process of testing a system's ability to meet performance objectives by measuring and monitoring its performance in a live environment.
value constants	Arithmetic values, such as decimal, hexadecimal, octal or character values.
variable text	Text of changing nature, such as various names and addresses combined with a form letter to make a complete document.
VM	virtual memory
virtual page	Page area selected by a forms designer for printing.
vpos	vertical positioning
VS	virtual storage
WAN	wide area network
weight	Characteristic of type determined by how light or dark it appears.
x axis	Horizontal axis on a forms grid.
x dot	Unit of measurement representing a fraction of an inch. It may also be referred to as a picture element (pixel) or spot, for example, 1/600 spots per inch (spi).
x height	Height of lowercase letters without their ascenders or descenders (height of letter "x"). See also ascender; descender.
XCSC	Xerox Customer Support Center
XDGI	Xerox DCF and GDDM Interface
XDSS	Xerox Documentation and Software Services
XICS	Xerox Integrated Composition System
XJCF	Xerox Job Control Facility
XJDC	Xerox Job Descriptor Compiler. Used by the DP 2000 Series EPS workstation to compile JSLs.

XMP	xerographic mode persistence
XMS	xerographic mode switching
XPAF, XPF	Xerox Printer Access Facility
XPMF-VMS	Xerox Print Management Facility - VMS Version
XPPI	Xerox Pen Plotter Interface
XPS	Xerox Publishing System
y axis	Vertical axis on a forms grid

Symbols

- # sign
 - changing case, 1-8

Numerics

- 2-sided printing
 - see duplex printing
- 3211, IBM
 - emulation, 2-2
- 4245, IBM
 - emulation, 2-2

A

- abbreviations
 - in command syntax, 1-12
- ABNORMAL command, 4-2–4-9
 - ACCTFEED parameter, 4-2
 - CODE parameter, 4-3
 - ERROR parameter, 4-3, 6-3
 - IMISMATCH parameter, 4-5
 - ISUBSTITUTE parameter, 4-7
 - OTEXT parameter, 4-7
 - REP parameter, 4-8
 - SECURITY parameter, 4-9
- ac identifier, 1-5, 2-19, 2-49
- accounting
 - error sheet, 4-2
 - printing sheet, 4-10
 - specifying department, 5-24
- accounting page
 - with RSTACK command, 3-55
- ACCT command, 1-25, 4-10–4-11
 - DEPT parameter, 4-10
 - USER parameter, 4-11
- ACCTFEED parameter
 - ABNORMAL command, 4-2
- ACCTINFO parameter
 - RSTACK command, 3-55
- ADJUST parameter
 - BLOCK command, 2-13
 - RECORD command, 2-36
- ADVTAPE parameter, PCC command, 2-31
- ALTER DJDE, 5-14
 - applying DJDEs, 5-3
- ASCII
 - in string constants, 1-9

- ASSIGN DJDE, 5-16
- ASSIGN parameter
 - CODE command, 2-20
 - KCODE command, 2-29
 - PCC command, 2-31
 - STOCKSET command, 4-106
 - VFU command, 4-110
- AUX tray
 - feeding cover sheets from, 4-50
 - specifying, 3-33

B

- BANNER command, 2-3, 3-22–3-28
 - HCOUNT parameter, 3-23, 3-27
 - HJOBNO parameter, 3-24, 3-27
 - HRPTNA parameter, 3-24, 3-27
 - TCOUNT parameter, 3-25, 3-27
 - TEST parameter, 3-25
 - TYPE parameter, 3-26
- banner pages, 3-22–3-28
- BASELINE parameter
 - LINE command, 4-24
- BATCH DJDE, 5-16
- Batch mode (graphics), 6-4
- Batch Mode format, 6-5
- BDELETE command, 3-28–3-31
 - TEST parameter, 3-28
- BEGIN DJDE, 5-17
- BEGIN parameter
 - PDE command, 4-95
 - RRESUME command, 3-49
 - RSUSPEND command, 3-49
- begins, multiple, 5-9
- BFORM DJDE, 5-18
- BFORM parameter
 - OUTPUT command, 4-45
- BINDING parameter
 - OUTPUT command, 4-46
- bins, output
 - specifying, 4-52, 5-24
- blanks
 - in command syntax, 1-12
- BLANKTYPE parameter
 - LINE command, 4-25
- block
 - length, 2-14–2-15
 - selecting or deleting from a report, 3-28
- BLOCK command, 2-12–2-19

- ADJUST parameter, 2-13
- CONSTANT parameter, 2-13
- FORMAT parameter, 2-14
- LENGTH parameter, 2-14
- LMULT parameter, 2-15
- LTHFLD parameter, 2-15
- OFFSET parameter, 2-16
- POSTAMBLE parameter, 2-16
- PREAMBLE parameter, 2-17
- ZERO parameter, 2-17
- Block mode (graphics), 6-3
- BMULT parameter, VOLUME command, 2-56
- BOF, 4-110, 4-111
- BOF DJDE, 5-20
- BOF parameter
 - VFU command, 4-111
- Bottom of Form
 - see BOF, 4-110
- braces, 1-14
- brackets, square, 1-14
- BSELECT command, 3-28–3-31
 - TEST parameter, 3-28

C

- C DJDE, 5-20
- CANCEL DJDE, 5-21
- carriage control
 - see printer carriage control
- case, changing, 1-8
- CATALOG command, 1-26, 1-59
- catalog commands
 - coding, 1-59
- catalog level commands, 1-26
- categories of commands, 1-16
- CE mark, xxi
- change mode, CRITERIA command, 3-10, 3-15
- CHANGE parameter
 - CRITERIA command, 3-14–3-16
- changing parameters
 - restrictions, 5-6
- channel assignments, 4-110
- character code assignments, 3-12–3-13
- character code translation, 1-24
- character code translation tables
 - defining, 2-19–2-22
 - double-byte, 2-22, 2-28–2-30, 2-63
 - for tape label, 2-64
 - for tapes, 2-9
- character types, 3-12
- CME command, 4-12–4-19
 - CONSTANT parameter, 4-14
 - FONT parameter, 4-14
 - INK parameter, 4-15
 - LINE parameter, 4-16
 - POSITION parameter, 4-17
- CMEs, 1-24

- catalogued, 4-12
- commands to create, 4-12–4-19
 - short form, 4-12
 - specifying, 4-64, 5-54
- CODE command, 1-24, 2-19–2-22
 - ASSIGN parameter, 2-20
 - DEFAULT parameter, 2-20–2-22
 - SPACECODE parameter, 2-22
- CODE parameter
 - ABNORMAL command, 4-3
- CODE parameter, VOLUME command, 2-56
- coding a DJDE, 5-2–5-3
- coding a JSL, 1-49–1-61
 - full procedure, 1-56–1-61
 - short procedure, 1-50–1-55
- coding order, logical processing, 3-1
- COLLATE DJDE, 5-22
- COLLATE parameter
 - OUTPUT command, 4-49
- color, highlight
 - commands, 1-79
 - IDR, 4-20–4-23
 - on monochrome systems, 1-18
 - DJDEs, 5-42, 5-43, 5-45, 5-47, 5-60, 5-73
 - forms, 1-80
 - parameters, 4-5, 4-7, 4-15, 4-21–4-23, 4-30, 4-58, 4-59, 4-62
 - printing jobs created in, 1-79–1-81
- comma, 1-14
 - as placeholder, 1-13
- commands
 - catalog level, 1-26
 - categories, 1-16
 - components, 1-3–1-10
 - constant definition, 3-1
 - containing TEST parameters, 3-4
 - defining stocks, 1-27
 - descriptions
 - input processing, 2-11–2-72
 - format diagram, 1-4
 - highlight color, 1-79
 - on monochrome systems, 1-18
 - identifiers, 1-5
 - input processing, 1-25
 - job or JDE level, 1-26–1-28
 - keywords, 1-5
 - levels
 - hierarchy, 1-45
 - levels in JSL, 1-18–1-28
 - logical processing, 1-23, 3-22–3-60
 - definition, 3-1
 - output, 1-28
 - overriding, 1-40–1-47
 - parameter options, 1-6
 - parameters, 1-6
 - print format, 1-28, 4-1–4-113
 - syntax, 1-12–1-14

- abbreviations, 1-12
- blank spaces, 1-12
- system level
 - identifiers, 1-21
 - variables, 1-7
- comments, 1-29
 - in DJDEs, 5-20
- compatibility between systems, 1-77–1-81
- compiling a JSL, 1-65–1-72
- constant mode, CRITERIA command, 3-10
- CONSTANT parameter
 - BLOCK command, 2-13
 - CME command, 4-14
 - CRITERIA command, 3-16–3-17
 - RECORD command, 2-37
 - TABLE command, 3-5
- constants
 - string, 1-7
 - value, 1-7
- conventions, document, xxiv
- COPIES DJDE, 5-22
- COPIES parameter
 - OUTPUT command, 4-49
- copy modification entries
 - see CMEs
- correcting errors in a JSL, 1-70–1-72
- COVER parameter
 - OUTPUT command, 4-50
- CRITERIA command, 3-1, 3-9–3-21
 - CHANGE parameter, 3-14–3-16
 - CONSTANT parameter, 3-16–3-17
 - LINENUM parameter, 3-11, 3-17
 - modes, 3-9–3-10
 - VALUE parameter, 3-18–3-21
- criteria identifier, 3-2
- criteria, test, 1-23, 3-10
- CYCLEFORMS parameter
 - OUTPUT command, 4-50

D

- DATA DJDE, 5-23
- DATA parameter
 - LINE command, 4-26
- data streams, 2-1
- DBC CODE command, 2-22–2-24
- DBC CODE parameter, VOLUME command, 2-57
- DBCS parameter, VOLUME command, 2-58
- dd identifier, 1-5
- default JSL, 1-53
- DEFAULT PARAMETER
 - CODE command, 2-20–2-22
- DEFAULT parameter
 - KCODE command, 2-29
 - PCC command, 2-33
 - TCODE command, 2-51
- defaults

- parameter, 1-40, 1-43
- delimiter
 - on accounting page, 3-54
 - with RSTACK command, 3-53
- DELIMITER parameter
 - RSTACK command, 3-56
- DENSITY parameter
 - OUTPUT command, 4-52
- DEPT DJDE, 5-24
- DEPT parameter
 - ACCT command, 4-10
- DESTINATION DJDE, 5-24
- DESTINATION parameter
 - OUTPUT command, 4-52
- DJDE diagram, 5-4
- DJDEs, 1-73
 - applying, 5-3
 - coding, 5-2–5-3
 - definition, 1-2
 - ending, 5-2, 5-26
 - for graphics, 6-1
 - graphics, 5-14
 - invoking processing, 2-24–2-28, 5-1
 - page oriented, 5-10–5-12
 - page transition issues, 5-8
 - record-oriented, 5-13–5-14
 - specifying processing online, 2-2
 - using IDEN command for, 5-1–5-2
- DJPCC parameter, IDEN command, 2-25
- Document Interleaved format, 6-4
- double-byte characters
 - printing, 2-62
 - translation tables, 2-22
- double-byte fonts
 - CME command, 4-18
- downloading resources, 2-4
- dumps, 1-74–1-77
 - offline, 1-76–1-77
 - online, 1-74–1-75
- duplex
 - printing issues with DJDEs, 5-8
- DUPLEX DJDE, 5-25
- DUPLEX parameter
 - OUTPUT command, 4-53
- duplex printing
 - offsetting, 3-41
 - specifying, 4-53, 5-25
- Dynamic Job Descriptor Entries
 - see DJDEs

E

- EBCDIC
 - in string constants, 1-10
- edgemarking, 1-35
- EMTYPE parameter, VOLUME command, 2-58
- END command, 1-12, 1-29–1-30

END DJDE, 5-26
ending a DJDE, 5-2, 5-26
ending a JSL, 1-29–1-30
EOF DJDE, 5-26
EOV parameter, VOLUME command, 2-59
ERROR parameter
 ABNORMAL command, 4-3, 6-3
errors in JSL, correcting, 1-70–1-72
EXPAGE parameter, VOLUME command, 2-59

F

FACEUP parameter
 OUTPUT command, 4-53
FCB
 interaction with VFU, 2-5
FCB parameter
 LINE command, 4-26
FDATA DJDE, 5-27
FDATA parameter
 LINE command, 4-27
FEED DJDE, 5-27
FEED parameter
 OUTPUT command, 4-54
feeding stock, 3-37
 AUX tray, 3-33
FILE DJDE, 2-4, 5-28–5-33
finishing
 defining SF1 operation, 4-77, 5-66
 defining SF2 operation, 4-78, 5-67
fixed pitch fonts, 1-39
font
 index, 4-28, 5-33
 mapping, 5-53
 short-edge feed, 5-64
 specifying, 5-35
FONT parameter
 CME command, 4-14
FONTINDEX DJDE, 5-33
FONTINDEX parameter
 LINE command, 4-28
fonts, 1-38–1-40
 fixed pitch, 1-39
 orientation, 1-40
 proportional, 1-39
 spacing, 1-39
FONTS DJDE, 5-35
FONTS parameter
 PDE command, 4-98
FORM DJDE, 5-38
format
 specifying, 5-37
FORMAT DJDE, 5-37
FORMAT parameter
 BLOCK command, 2-14
 OUTPUT command, 4-55
 RECORD command, 2-37

formats
 for jobs with graphics, 6-4
 record, 2-9
 specifying, 1-24, 4-55, 4-93
 standard, 4-93
 tape, 2-8
forms
 back, 4-45
 DJDE, 5-18
 creation, 1-18
 cycling, 4-50
 highlight color, 1-80
 initial specification, 1-44
 on RTEXT pages, 4-102, 5-61
 on tabs, 4-73
 specifying, 4-56, 5-38
Forms Control Buffer
 see FCB
FORMS parameter
 OUTPUT command, 4-56

G

GDATA DJDE, 5-39
GDATA parameter
 LINE command, 4-29
GRAPHIC DJDE, 5-39
graphics
 Batch Mode format, 6-5
 DJDEs, 5-14, 6-1
 Document Interleaved format, 6-4
 error handling, 6-3
 impact on system performance, 6-6
 importing, 6-2
 interleaved, 5-41
 Page Interleaved format, 6-5
 Random Mode Only format, 6-4
 restrictions, 6-6
 setting new parameters, 5-44
 specifying, 4-57, 5-39
 specifying initial, 4-60
GRAPHICS parameter
 OUTPUT command, 4-57
graphics processing modes, 6-3

H

H2 and H6 strings, 1-11
HCOUNT parameter
 BANNER command, 3-23, 3-27
header pages, 3-23
 with DJDEs, 5-9
hexadecimal
 expressing values, 1-7, 1-9
 strings in code assignment tables, 2-20
hierarchy of replacement, 1-40–1-41
highlight color

commands, 1-79
 IDR, 4-20–4-23
 commands on monochrome systems, 1-18
 DJDEs, 5-42, 5-43, 5-45, 5-47, 5-60, 5-73
 downloading JDLs, 1-80
 forms, 1-80
 parameters, 4-5, 4-7, 4-15, 4-21–4-23, 4-30,
 4-58, 4-59, 4-62
 highlight color jobs, 1-79–1-81
 HJOBNO parameter
 BANNER command, 3-24, 3-27
 HOST parameter
 VOLUME command, 2-3, 2-60
 HRPTNA parameter
 BANNER command, 3-24, 3-27
 RSTACK command, 3-56

I
IBM

3211
 emulation, 2-2
 4245
 emulation, 2-2
 ICATALOG DJDE, 5-42
 ICATALOG parameter
 IDR command, 4-21
 IDEN command, 1-73, 2-2, 2-24–2-28
 DJPCP parameter, 2-25
 enabling DJDEs, 5-1–5-2
 OFFSET parameter, 2-26
 OPRINFO parameter, 2-26, 5-5
 PREFIX parameter, 2-27, 5-2
 SKIP parameter, 2-27
 identifier
 command
 ac type, 1-5
 dd type, 1-5
 criteria, 3-2
 identifier, command, 1-5
 ac type, 1-5
 dd type, 1-5
 identifiers, 1-21
 IDFAULT DJDE, 5-42
 IDFAULT parameter
 OUTPUT command, 4-58
 IDR command, 4-20–4-23
 ICATALOG parameter, 4-21
 ILIST parameter, 4-22
 PALETTE parameter, 4-23
 IDR DJDE, 5-43
 IDR parameter
 OUTPUT command, 4-59
 ILIST DJDE, 5-43
 ILIST parameter
 IDR command, 4-22
 IMAGE DJDE, 5-44

IMAGE parameter
 OUTPUT command, 4-60
 image shift
 DJDE, 5-67
 specifying, 4-78, 5-74
 specifying vertical, 4-90
 IMISMATCH parameter
 ABNORMAL command, 4-5
 importing files, 5-28–5-33
 graphics, 6-2
 INIFEED parameter
 STOCKSET command, 4-107
 INITIAL parameter, PCC command, 2-34
 ink
 default, 4-20
 INK parameter
 CME command, 4-15
 LMODIFY command, 3-31
 INKINDEX DJDE, 5-45
 INKINDEX parameter
 LINE command, 4-30
 input data streams, 2-1
 input parameters
 setting up, 1-25
 input parameters, setting up, 2-1–2-72
 input processing
 command descriptions, 2-11–2-72
 INVERT DJDE, 5-46
 INVERT parameter
 OUTPUT command, 4-61
 inverting page image, 4-61
 IRESULT DJDE, 5-47
 IRESULT parameter
 OUTPUT command, 4-62
 ISUBSTITUTE parameter
 ABNORMAL command, 4-7
 ITEXT DJDE, 5-48
 ITEXT parameter
 MESSAGE command, 4-40

J

jam recovery, 4-8
 JDE DJDE, 5-48
 JDE level commands
 see job level commands
 JDL
 definition, 1-2
 downloading for highlight color, 1-80
 hierarchy within, 1-45
 name, 1-21
 offline
 using online JDEs in, 2-18, 2-42
 JDL DJDE, 5-49
 JDL level commands
 See system level commands
 job level commands, 1-26–1-28

- job recovery
 - online, 2-3
- JSL
 - coding, 1-49–1-61
 - full procedure, 1-56–1-61
 - short procedure, 1-50–1-55
 - command levels, 1-18–1-28
 - compiling, 1-65–1-72
 - correcting errors, 1-70–1-72
 - creating
 - hints and tips, 1-47–1-49
 - default, 1-53
 - definition, 1-2
 - ending, 1-12, 1-29–1-30
 - from other monochrome printers, 1-81
 - information specified in, 1-18
 - required elements, 1-47
 - sample, 1-30–1-31, 1-46, 1-48
 - offline, 1-63
 - online, 1-61, 2-6
 - saving a new, 1-54, 1-59
 - what to know before creating, 1-31–1-40

K

- KANJI parameter, VOLUME command, 2-62
- KCODE command, 2-28–2-30
 - ASSIGN parameter, 2-29
 - DEFAULT parameter, 2-29
- KCODE parameter, VOLUME command, 2-63
- keywords, command, 1-5, 1-6

L

- LABEL parameter, VOLUME command, 2-63
- label, tape, 2-63
- landscape orientation, 1-38
- laser safety, xvii
- late binding attributes, 1-41–1-44
 - setting, 1-41
- lcds folder, 1-2, 1-55, 1-60
- LCODE parameter, VOLUME command, 2-64
- LENGTH parameter
 - BLOCK command, 2-14
 - RECORD command, 2-38
- levels of commands, 1-18–1-28
- LINE command, 1-25, 4-23–4-39
 - BASELINE parameter, 4-24
 - BLANKTYPE parameter, 4-25
 - DATA parameter, 4-26
 - FCB parameter, 4-26
 - FDATA parameter, 4-27
 - FONTINDEX parameter, 4-28
 - GDATA parameter, 4-29
 - INKINDEX parameter, 4-30
 - LPI parameter, 4-31
 - MARGIN parameter, 4-32

- OVERPRINT parameter, 4-32
- PCC parameter, 4-34
- PCCTYPE parameter, 4-35
- VFU parameter, 4-36
- LINE parameter
 - CME command, 4-16
- LINENUM parameter
 - CRITERIA command, 3-11, 3-17
- LMODIFY command, 3-31–3-33
 - INK parameter, 3-31
 - SELECT parameter, 3-32
 - TEST parameter, 3-32
- LMULT parameter
 - BLOCK command, 2-15
 - RECORD command, 2-39
- loading files to disk, 5-28–5-33, 6-2
- logical page, 1-35
 - beginning, 4-95
 - DJDE, 5-17
 - multiple, 5-9
 - positioning on physical page, 3-43
- logical processing
 - command descriptions, 3-22–3-60
 - specifying, 1-23
- LOGO DJDE, 5-50
- LOGO parameter
 - OUTPUT command, 4-63
- logos
 - specifying, 4-63, 5-50
- lowercase
 - changing to, 1-8
- LPACK parameter, VOLUME command, 2-64
- LPI DJDE, 5-52
- LPI parameter
 - LINE command, 4-31
- LST file, 1-70–1-72
 - definition, 1-69
- LTHFLD parameter
 - BLOCK command, 2-15
 - RECORD command, 2-39

M

- MAP DJDE, 5-53
- MAP parameter, SEFFNT command, 2-46
- MARGIN DJDE, 5-53
- MARGIN parameter
 - LINE command, 4-32
- margins, setting, 4-32, 4-34, 5-53
- mask
 - character, 3-6–3-7
 - comparison, 3-12
- MASK parameter
 - TABLE command, 3-6
 - example, 3-7–3-8
- MASK parameter, PCC command, 2-35
- MAXLAB parameter, VOLUME command, 2-65

- measure, unit of
 - defining, 4-89
 - MESSAGE command, 4-39–4-42
 - ITEXT parameter, 4-40
 - OTEXT parameter, 4-41
 - messages
 - error, 5-5
 - operator, 4-7, 4-39–4-42
 - DJDEs, 5-5, 5-48, 5-58
 - MINLAB parameter, VOLUME command, 2-65
 - modes, CRITERIA command, 3-9–3-10
 - change mode, 3-10
 - constant mode, 3-10
 - value mode, 3-10
 - MODIFY DJDE, 5-54
 - MODIFY parameter
 - OUTPUT command, 4-64
 - Move mode
 - see Random mode (graphics)
 - multiple begins, 5-9
 - multivolume processing, 2-10
- N**
-
- N to 1 printing, 4-65
 - name, JDL, 1-21
 - NTO1 parameter
 - OUTPUT command, 4-65
 - NUMBER DJDE, 5-55
 - NUMBER parameter
 - OUTPUT command, 4-67
 - number, page
 - specifying, 4-67
- O**
-
- Octal
 - in string constants, 1-10
 - octal
 - expressing values, 1-7
 - offline
 - input processing, 2-8–2-11
 - offline dump, 1-76–1-77
 - OFFSET parameter
 - BLOCK command, 2-16
 - IDEN command, 2-26
 - OUTPUT command, 4-69
 - RECORD command, 2-40
 - offsetting pages in stacker, 3-39, 4-69
 - online
 - input processing, 2-2
 - RSTACK considerations, 3-58
 - online dump, 1-74–1-75
 - operation safety
 - Europe, xix–xxi
 - US, xviii
 - OPRINFO parameter
 - IDEN command, 5-5
 - OPRINFO parameter, IDEN command, 2-26
 - OPTIMIZE parameter, VOLUME command, 2-66
 - options, parameter, 1-6
 - order of command types, 3-1
 - ordered stocks
 - specifying, 4-70
 - orientation
 - font, 1-40
 - page, 1-35–1-38
 - specifying, 4-99, 5-61
 - OSCHN parameter, VOLUME command, 2-67
 - OSHDP parameter, VOLUME command, 2-67
 - OSTK parameter
 - OUTPUT command, 4-70
 - OSTLP parameter, VOLUME command, 2-67
 - OTEXT command, 1-28
 - OTEXT DJDE, 5-58
 - OTEXT parameter
 - ABNORMAL command, 4-7
 - MESSAGE command, 4-41
 - OUTPUT command, 4-43–4-93
 - BFORM parameter, 4-45
 - BINDING parameter, 4-46
 - COLLATE parameter, 4-49
 - COPIES parameter, 4-49
 - COVER parameter, 4-50
 - CYCLEFORMS parameter, 4-50
 - DENSITY parameter, 4-52
 - DESTINATION parameter, 4-52
 - DUPLEX parameter, 4-53
 - FACEUP parameter, 4-53
 - FEED parameter, 4-54
 - FORMAT parameter, 4-55
 - FORMS parameter, 4-56
 - GRAPHICS parameter, 4-57
 - graphics parameters, 6-1
 - IDFAULT parameter, 4-58
 - IDR parameter, 4-59
 - IMAGE parameter, 4-60
 - INVERT parameter, 4-61
 - IRESULT parameter, 4-62
 - LOGO parameter, 4-63
 - MODIFY parameter, 4-64
 - NTO1 parameter, 4-65
 - NUMBER parameter, 4-67
 - OFFSET parameter, 4-69
 - OSTK parameter, 4-70
 - PAPERSIZE parameter, 4-75
 - PURGE parameter, 4-76
 - SF1FUNCTION parameter, 4-77
 - SF2FUNCTION parameter, 4-78
 - SHIFT parameter, 4-78
 - SIZING parameter, 4-79
 - STAPLE parameter, 4-81
 - STOCKS parameter, 4-82
 - SYSPPR parameter, 4-83

- TRANS parameter, 4-89
- UNITS parameter, 4-89
- XSHIFT parameter, 4-90
- output command descriptions
 - see print format command descriptions
- output parameters, specifying, 1-28
- OVERPRINT DJDE, 5-59
- OVERPRINT parameter
 - LINE command, 4-32
- overrides
 - specifying during printing, 1-45
- overriding commands, 1-40–1-47
- ozone, xvii

P

- packed data formats, 2-9
- Page Interleaved format, 6-5
- page numbers
 - specifying, 4-67, 5-55
- page-oriented DJDEs, 5-10–5-12
- pages
 - logical, 1-35
 - physical, 1-34
 - system, 1-34
- PALETTE DJDE, 5-60
- PALETTE parameter
 - IDR command, 4-23
- PAPERSIZE parameter
 - OUTPUT command, 4-75
- parameter
 - definition, 1-6
- parameter options, 1-6
- parentheses, 1-14
 - use in commands, 1-6
- PASSES parameter
 - ROFFSET command, 3-40
- PCC
 - see printer carriage control
- PCC command, 2-30–2-36
 - ADVTAPE parameter, 2-31
 - ASSIGN parameter, 2-31
 - DEFAULT parameter, 2-33
 - INITIAL parameter, 2-34
 - MASK parameter, 2-35
- PCC parameter
 - LINE command, 4-34
- PCCTYPE parameter
 - LINE command, 4-35
- PDE command, 1-24, 4-93–4-101
 - BEGIN parameter, 4-95
 - FONTS parameter, 4-98
 - PMODE parameter, 4-99
- PDEs
 - specifying, 4-55
 - standard, 4-93
- PDEs, specifying, 1-24

- physical page, 1-34
- pitch mode, 4-86–4-88, 5-70
- PMODE DJDE, 5-61
- PMODE parameter
 - PDE command, 4-99
- portrait orientation, 1-37
- POSITION parameter
 - CME command, 4-17
- POSTAMBLE parameter
 - BLOCK command, 2-16
 - RECORD command, 2-40
- PPI
 - see print position indexing
- PREAMBLE parameter
 - BLOCK command, 2-17
 - RECORD command, 2-40
- PREFIX parameter, IDEN command, 2-27
- print format
 - command descriptions, 4-1–4-113
- PRINT parameter
 - RSTACK command, 3-57
- print position indexing, 2-5–2-6
- printer carriage control, 2-30–2-36, 4-34, 4-35
 - DJDEs, 2-25
 - interaction with DJDEs, 5-10
- printing
 - highlight color jobs, 1-79–1-81
- proportional fonts, 1-39
- PURGE parameter
 - OUTPUT command, 4-76

R

- Random mode (graphics), 6-3
- Random Mode Only format, 6-4
- RAUX command, 3-33–3-35
- RDELETE command, 3-35–3-37
 - TEST parameter, 3-35
- record
 - formats, 2-9
 - length, 2-3, 2-38
 - selecting or deleting from a report, 3-35
 - structure, 2-10, 2-36–2-43
- RECORD command, 2-36–2-43
 - ADJUST parameter, 2-36
 - CONSTANT parameter, 2-37
 - FORMAT parameter, 2-37
 - LENGTH parameter, 2-38
 - LMULT parameter, 2-39
 - LTHFLD parameter, 2-39
 - OFFSET parameter, 2-40
 - POSTAMBLE parameter, 2-40
 - PREAMBLE parameter, 2-40
 - STRUCTURE parameter, 2-41
- record-oriented DJDEs, 5-13–5-14
- records, 1-3
- recovery, job

- multivolume reports, 2-10
 - online, 2-3
- REP parameter
 - ABNORMAL command, 4-8
- repeat count, indicating, 1-8
- report
 - separation, 2-3
- required elements of JSLs, 1-47
- resources
 - downloading, 2-4
- restricting functions, 4-9
- restrictions
 - parameter changes by DJDE, 5-6
- RFEED command, 3-37–3-39
 - TEST parameter, 3-37
- RFORM DJDE, 5-61
- RFORM parameter
 - ROUTE command, 4-102
- RMULT parameter, VOLUME command, 2-68
- ROFFSET command, 3-39–3-42
 - PASSES parameter, 3-40
 - TEST parameter, 3-41
- rollover, system
 - multivolume reports, 2-10
- rotating the page image, 5-46
- ROUTE command, 4-101–4-105
 - RFORM parameter, 4-102
 - RTEXT parameter, 4-102
- RPAGE command, 3-43–3-48
 - SIDE parameter, 3-43
 - TEST parameter, 3-45
 - WHEN parameter, 3-45
- RRESUME command, 3-49–3-52
 - BEGIN parameter, 3-49
 - TEST parameter, 3-50, 3-51
- RSC file
 - definition, 1-69
- RSELECT command, 3-35–3-37
 - TEST parameter, 3-35
- RSTACK command, 2-3, 3-53–3-60
 - ACCTINFO parameter, 3-55
 - delimiter mode, 3-53
 - DELIMITER parameter, 3-56
 - HRPTNA parameter, 3-56
 - nondelimiter mode, 3-54
 - PRINT parameter, 3-57
 - TEST parameter, 3-58
- RSUSPEND command, 3-49–3-52
 - BEGIN parameter, 3-49
 - interaction with RSTACK command, 3-51
 - TEST parameter, 3-50
- RTEXT DJDE, 5-62
- RTEXT parameter
 - ROUTE command, 4-102

S

- safety
 - laser, xvii
 - operation
 - Europe, xix–xxi
 - US, xviii
- sample JSL, 1-30–1-31, 1-46, 1-48
 - offline, 1-63
 - online, 1-61, 2-6
- sample PDL commands, 1-15
- sample tray
 - specifying, 4-52
- SAVE DJDE, 5-64
- saving a new JSL, 1-54, 1-59
- SECURITY parameter
 - ABNORMAL command, 4-9
- SEF
 - see short edge feed
- SEFFNT command, 2-44–2-49
 - MAP parameter, 2-46
 - SEFMAP parameter, 2-45
- SEFMAP DJDE, 5-64
- SEFMAP parameter, SEFFNT command, 2-45
- SELECT parameter
 - LMODIFY command, 3-32
- semicolon, 1-12
- separating reports, 2-3
- SF1FUNCTION DJDE, 5-66
- SF1FUNCTION parameter
 - OUTPUT command, 4-77
- SF2FUNCTION DJDE, 5-67
- SF2FUNCTION parameter
 - OUTPUT command, 4-78
- SHIFT DJDE, 5-67
- SHIFT parameter
 - OUTPUT command, 4-78
- shifting the page image, 4-78, 5-67, 5-74
- short edge feed, 2-44–2-49
- short-edge feed
 - font mapping, 5-64
- SIDE DJDE, 5-68
- SIDE parameter
 - RPAGE command, 3-43
- SIZING parameter
 - OUTPUT command, 4-79
- SKIP parameter, IDEN command, 2-27
- SPACECODE PARAMETER, CODE command, 2-22
- STAPLE parameter
 - OUTPUT command, 4-81
- stitching
 - specifying, 4-81
- stocks
 - defining, 1-27
 - defining a set, 4-105–4-109, 5-70
 - for system pages, 4-107
 - for system-generated pages, 4-83

- mismatch response, 4-79
 - specifying, 4-54
 - DJDE, 5-27
 - specifying size, 4-75

STOCKS DJDE, 5-70

STOCKS parameter

- OUTPUT command, 4-82

stockset

- specifying, 4-82

STOCKSET command, 1-27, 4-105–4-109

- ASSIGN parameter, 4-106
- INIFEED parameter, 4-107
- SYSPAGE parameter, 4-107

string comparisons, 3-11

string constants, 1-7–1-10

- types, 1-8

STRUCTURE parameter

- RECORD command, 2-41

syntax, command, 1-12–1-14

- conventions, 1-14

SYSPAGE parameter

- STOCKSET command, 4-107

SYSPPR parameter

- OUTPUT command, 4-83

system level commands

- with identifiers, 1-21

system page, 1-34

T

TABLE command, 3-1, 3-4–3-9

- CONSTANT parameter, 3-5
- MASK parameter, 3-6
 - example, 3-7–3-8

tabs

- printing, 4-71–4-73
- specifying, 4-70

tape

- formats, 2-8
- label, 2-63

tape dump

- see offline dump

TASSIGN parameter, TCODE command, 2-51

TCODE command, 2-49–2-54, 3-13

- DEFAULT parameter, 2-51
- TASSIGN parameter, 2-51
- TRESET parameter, 2-52

TCODE parameter

- VOLUME command, 3-12, 3-13

TCODE parameter, VOLUME command, 2-68

TCOUNT parameter

- BANNER command, 3-25, 3-27

test expression, 3-2–3-4

- coding, 3-2
- syntax, 3-3

TEST parameter

- BANNER command, 3-25

BDELETE command, 3-28

BSELECT command, 3-28

CRITERIA command, 3-10

- interaction with RSTACK command, 3-51

LMODIFY command, 3-32

RDELETE command, 3-35

RFEED command, 3-37

ROFFSET command, 3-41

RPAGE command, 3-45

RRESUME command, 3-50

RSELECT command, 3-35

RSTACK command, 3-58

RSUSPEND command, 3-50

TEST parameters, 3-4

test-exp parameters, 3-2

Text Editor

- opening, 1-50, 1-56

throughput speed, 4-85–4-88

TMODE DJDE, 5-70

TOF, 4-110, 4-111, 5-71

TOF DJDE, 5-71

TOF parameter

- VFU command, 4-111

Top of Form

- see TOF, 4-110

trailer pages, 3-25

TRANS DJDE, 5-72

TRANS parameter

- OUTPUT command, 4-89

translation tables, 1-24

transparencies

- printing, 4-89, 5-72

tray,sample

- specifying, 4-52

TRESET parameter, TCODE command, 2-52

troubleshooting a job, 1-74–1-77

troubleshooting a JSL, 1-70–1-72

type attribute, character, 3-12

TYPE parameter

- BANNER command, 3-26

U

UNITS parameter

- OUTPUT command, 4-89

UNPACK parameter, VOLUME command, 2-69

uppercase

- changing to, 1-8

USER parameter

- ACCT command, 4-11

V

value constants, 1-7

value mode, CRITERIA command, 3-10

VALUE parameter

- CRITERIA command, 3-18–3-21

variables, 1-7, 1-14
VOLUME parameter
 VOLUME command, 2-70–2-72
vertical formatting
 See VFU command
VFU
 interaction with FCB, 2-5
VFU command, 1-23, 4-110–4-113
 ASSIGN parameter, 4-110
 BOF parameter, 4-111
 TOF parameter, 4-111
VFU parameter
 LINE command, 4-36
VFUs
 specifying, 1-23, 4-110–4-113
VOLUME command, 2-54–2-72
 BMULT parameter, 2-56
 CODE parameter, 2-56
 DBC CODE parameter, 2-57
 DBCS parameter, 2-58
 EMTYPE parameter, 2-58
 EOV parameter, 2-59
 EXPAGE parameter, 2-59
 HOST parameter, 2-3, 2-60
 KANJI parameter, 2-62
 KCODE parameter, 2-63
 LABEL parameter, 2-63
 LCODE parameter, 2-64
 LPACK parameter, 2-64
 MAXLAB parameter, 2-65
 MINLAB parameter, 2-65
 OPTIMIZE parameter, 2-66
 OSCHN parameter, 2-67
 OSHDP parameter, 2-67
 OSTLP parameter, 2-67
 RMULT parameter, 2-68
 TCODE parameter, 2-68, 3-12, 3-13
 UNPACK parameter, 2-69
 VOLUME parameter, 2-70–2-72

W

WHEN parameter
 RPAGE command, 3-45

X

xjdc command
 entering, 1-67
 options, 1-68
XJDC compiler, 1-65
 rules, 1-65
XMP DJDE, 5-73
XSHIFT DJDE, 5-74
XSHIFT parameter
 OUTPUT command, 4-90

Z

ZERO parameter
 BLOCK command, 2-17

