

Xerox 4500 PS TR
User's Guide

Doc. no. D60327 Revision 01

WARNING:

This equipment generates, uses, and can radiate radio frequency energy and if not installed and used in accordance with the instruction manual, may cause interference to radio communications. It has been tested and found to comply with the limits for a Class A computing device pursuant to Subpart B of Part 15 of FCC Rules, which are designed to provide reasonable protection against such interference when operated in a commercial environment. Operation of this equipment in a residential area is likely to cause interference in which case the user at his own expense will be required to take whatever measures may be required to correct the interference.

EMC directive:

This product observes the rules and regulations of the EMC directive. If so required, a declaration of conformity in local language stipulating the applied rules and regulations can be obtained.

Trademarks:

Company and product names mentioned in this datasheet are trademarks or registered trademarks of their respective owners.

Preface

July 1997

We congratulate you on your purchase of the *Xerox 4500 PrintServer Token Ring*. The *Xerox 4500 PS TR* forms part of a series of print servers developed with the purpose of migrating printing know-how into the LAN environment.

This manual describes the installation and configuration of the **Xerox 4500 PS TR** (used as product name throughout the manual) operating in different environments and covering these variants:

Xerox 4500 PS TR - non-IPDS - supports native and ICDS datstreams
Xerox 4500 PS TR - IPC - supports native, ICDS and IPDS datstreams

The user is required working knowledge of the relevant host environments: PSF/MVS, PSF/2, PSF/AIX, PSF/400, TCP/IP and ida PSS. For details on the configuration on these environments, see the specific chapters.

In addition, the user is assumed working knowledge of the relevant Host Operating System and relevant LAN based protocols.

NOTE:

In the manual reference is made to PSF for S/370-S/390 - this term is to be construed as PSF/MVS, PSF/VM and PSF/VSE.

Prerequisite manuals

- The original printer manual

Related manuals

The relevant documentation for the host systems and supported printers should be consulted.

- **For SNMP support** see:
 - Simple Network Management Protocol, RFC 1157
 - MIB for network management of TCP/IP based internets, RFC 1213

Changes with this revision

July 1997, revision 01

- added sample definition for 3745
- description of FSL top module added in separate file (**FSL_REF.pdf**)
- New configuration tools
 - using Web browser
 - using Psinst32
- Amendments made to the Telnet configuration
- Support for NetBIOS/NetNEUI

Table of Contents

Preface	2
Prerequisite manuals	2
Related manuals	2
Changes with this revision	2
Items Supplied with Xerox 4500 PS TR	7
1. Introduction to Xerox 4500 PS TR	8
1.1 Supported protocols	10
1.1.1 IPX/SPX protocol	10
1.1.2 TCP/IP protocols	10
1.1.3 NetBEUI/NetBios protocol	11
1.1.4 ida 802.2 protocol	11
1.1.5 PU/LU protocol	12
1.1.6 Illustration	12
1.2 The Xerox 4500 PS TR features	13
1.3 System requirements.....	14
1.3.1 All environments:	14
1.3.2 Direct AFP print - mainframe / midrange	14
1.3.3 LAN based AFP print	14
1.4 Supported printers	15
2. Installation of Xerox 4500 PS TR	16
2.1 Pre-Installation tasks	16
2.1.1 Ring speed configuration	16
2.1.2 EU - US language settings	17
2.1.3 National language selection - CPGID (IPC)	17
2.2 Rear panel	18
2.3 Installation procedure	20
2.3.1 Installing into Xerox 4505 / 4510 printer	20
2.3.2 Installing into Xerox 4517 printer	22
2.3.3 Installing into Xerox 4520 printer	23
2.4 Share timeout	24
2.5 Network installation	24
2.6 Installing upgrade modules	25
3. Configuration	26
3.1 Introduction to configuration	26
3.1.1 Which Configuration Tool Do I Choose to Configure My PrintServer?	27
3.1.2 In General on Configuration... ..	27
3.2 Minimum configuration	28
3.2.1 Mandatory settings	28
3.3 Configuration using PSinst32	31
3.3.1 Program Installation Procedure	31
3.3.2 Program Execution	31
3.3.3 Help	34
3.3.4 Main menu - Where do I start with PSinst32?	35
3.3.5 Program setup - Configuring Your Preferred Protocol	36
3.3.6 Further Options - The File Menu	40



3.3.7 End of Configuration - Downloading Settings to the PrintServer	43
3.3.8 Firmware download	46
3.3.9 Broadcasting	47
3.4 Configuration using Web Browser	49
3.4.1 Requirements	49
3.4.2 Access to ida HTML configuration	49
3.4.3 Overview	51
3.4.4 Configuration chart	51
3.4.5 Main Menu	52
3.4.6 Configure PrintServer	52
3.4.7 PrintServer Status Menu	53
3.5 Configuration using Telnet	54
3.5.1 Menu Structure	56
3.5.2 Configuring PrintServer	56
3.5.3 General Parameters Menu	57
3.5.4 Configure Sessions	63
3.5.5 Change Password	63
3.5.6 Save Configuration	64
3.5.7 Restore Configuration	64
3.5.8 Restore Factory Default	64
3.5.9 Reboot PrintServer	65
3.5.10 Trace destination	65
3.5.11 Status PrintServer	66
3.6 Configuration using Setup File	67
3.6.1 Sample minimum configuration file	68
3.6.2 Advanced configuration	70
3.7 Setting Up via BOOTP server	78
3.7.1 BOOTP process	81
3.7.2 Setting up the TFTP Daemon	82
3.7.3 Starting the BOOTP Server	84
3.8 Testing PrintServer	85
3.9 About the PING function	86
4. Novell Setup for IPX/SPX.....	87
4.1 Before you begin.....	88
4.2 Using the embedded PSERVER	88
4.2.1 Embedded PSERVER setup	88
4.3 Using the embedded NPRINTER	89
4.3.1 Embedded NPRINTER setup	89
4.4 NetWare setup - Bindery mode	91
4.5 NetWare setup - DS mode	93
4.6 Illustration	95
5. NetBEUI/NetBIOS Printing Using Windows '95, NT or OS/2.....	96
5.1 Windows '95 and NT Setup	96
5.2 OS/2 Setup	97
5.3 Changing the default PrintServer Name and Workgroup	98
6. OS/2 Printing Using TCP/IP LPR/LPD.....	99
6.1 OS/2 printing via a print queue	99
6.2 OS/2 printing using LPR command	100
6.3 OS/2 printing via redirection of LPTx Port with LPRMON command	100

7. UNIX Printing Using TCP/IP LPR/LPD.....	101
7.1 AIX printing using TCP/IP LPR/LPD	101
7.2 SUN OS printing using TCP/IP LPR/LPD	103
7.3 HP-UX printing with SAM using TCP/IP LPR/LPD	105
8. Windows NT Printing Using TCP/IP LPR/LPD.....	106
9. AS/400 Printing Using Host Print Transform and TCP/IP.....	107
9.1 Create a remote output queue	107
9.2 AS/400 printing	109
10. PSF/400 AFP Printing Using TCP/IP.....	110
10.1 AS/400 version 3.1 and 3.6	110
10.1.1 CRTDEVPRT	110
10.1.2 Configuring WRKAFF2 for direct TCP/IP connection	112
10.1.3 Setting the CHGTCPA	112
10.2 AS/400 version 3.2 and 3.7	113
10.2.1 CRTDEVPRT	113
10.2.2 CRTPSFCFG (version 3.2 only)	114
11. AS/400 SCS Printing Using SNA.....	115
11.1 AS/400 controller definition	116
11.2 AS/400 printer definition	117
11.3 AS/400 printing	117
12. AS/400 SCS-DCA Printing Using TCP/IP.....	118
12.1 Create a remote output queue	118
12.2 AS/400 Printing	119
13. PSF/MVS AFP Printing Using TCP/IP.....	120
13.1 PSF/MVS direct attachment	120
13.2 PSF/MVS startup procedure	121
14. SNA IPDS and SCS Printing from MVS or VM.....	122
14.1 Logmode.....	122
14.2 PS PU definition for 3174	123
14.3 3174 - OS/2 Gateway - PS PU definition	125
14.4 PS PU definition for 3745	128
14.4 Configuring NetWare SAA gateway for direct SNA connection to PS	129
14.5 FSL Configuration	133
15. PSS/MVS AFP Printing Using TCP/IP.....	134
15.1 Sample PSS/MVS JES2 initialisation statements	134
15.2 PSS printer profile using TCP/IP attachment	135
16. PSS/VM AFP Printing Using TCP/IP.....	136
16.1 Sample PSS VM printer profile definition using TCP/IP	136
17. PSF/2 AFP Printing Using TCP/IP.....	137
17.1 Creating a new printer profile	137
17.2 KEEPALIVE support for OS/2.....	139
17.3 OS/2 KEEPALIVE configuration	140
18. PSF/AIX Printing Using TCP/IP.....	141
18.1 Adding TCP/IP attached printer	141
18.2 KEEPALIVE support for AIX	142
18.3 AIX KEEPALIVE support	142
19. Problem Determination.....	144
19.1 Monitoring tools	144
19.1.1 SNMP support.....	144

19.1.2 LED Status error messages	146
19.2 Troubleshooting	147
19.2.1 When installing	147
19.2.2 When configuring	149
19.2.3 When printing	151
19.3 Intervention required (IRQ)	154
19.4 Printer errors in front panel	156
19.5 Problem reporting	156
APPENDICES.....	157
Appendix A: Configuration Using Setup File	158
Appendix A 1: Configuring via parallel port	158
Appendix A 2: Configuration file parameters	159
Appendix B: Microcode upgrading	174
Appendix B.1: Upgrading microcode via Parallel port	174
Appendix B.2: Upgrading Microcode via TCP/IP Boot Server	175
Appendix B.3: Problem determination	178
Appendix C: idaSetup - IPDS configuration	179
Appendix D: IPDS resident codepages	180
Appendix E: Test printout	181
Appendix F: Error messages	184
Appendix G: List of abbreviations	186
Appendix H: Selected products for Xerox printers	187

Items Supplied with Xerox 4500 PS TR

Before you begin installing the Xerox 4500 PS TR make sure that you have all the items shown below.

- **Interface**(in antistatic bag) for Xerox 4500 PS TR (**non-IPDS**) or (**IPDS top**)
- **Configuration and printer driver diskettes**
- **Cable converting STP to UTP**
- **idaSetup kit (if IPDS module):**
 - ✓ idaSetup installation diskettes for DOS and Windows
 - ✓ Documentation:
 - IPDS
 - Programmer's Guide
 - D60253
- **Product documentation:**
 - ✓  "Plug and play" documentation :
 - Quick Guide:
 - D10327
 - ✓  Advanced configuration :
 - Xerox 4500 PS TR
 - Installation & Operator's Guide
 - Doc. no. D60327
 - ✓ Informative files:
 - PTF levels for Midrange environment
"AS400PTF"
 - Redirected SNA AFP Printing
"Redirect"
 - Operating FSL top module
"FSL_REF"
 - ✓ Acrobat Viewer
 - Tool for viewing electronic documentation

NOTE:

Readme files supplied with the product setup files will provide you with details.

1. Introduction to Xerox 4500 PS TR

The Xerox 4500 PS TR is basically viewed as a “Plug and Go” product in terms of printing directly from Windows using NetBIOS/NetBEUI. To print using one of the other protocols supported, a minimum configuration on protocol level is required. This minimum configuration is system dependent and no default value will apply. For details on minimum configuration on protocol level, see the chapter: “Configuration of Xerox 4500 PS TR”.

Each unit is capable of supporting multiple print sessions at the same time, each with its own resource environment. This ensures maximum use of downloaded resources and minimises network traffic.

Direct host print

Native data: PCL, ASCII, Postscript etc. The Xerox 4500 PS TR is capable of printing AFP based documents as well as native data. The Xerox 4500 PS TR - non IPDS offers support for native and ICDS datastreams. The Xerox 4500 PS IPC offers support for native, ICDS and IPDS datastreams.

Direct host print via TCP/IP

Support for direct AFP host print via the TCP/IP PPR/PPD bi-directional protocol allows for direct printing control without the need for configuring intermediate systems. The ICDS and IPDS modules allow the unit to communicate directly with IBM mainframe and midrange systems using the TCP/IP PPR/PPD (Page Printer Requester/Page Printer Daemon) bi-directional protocol.

LAN print

The Xerox 4500 PS TR is a remote device for the Token Ring environment supporting the most widely used protocols in the LAN environment. With its capability to handle different network protocols simultaneously, the Xerox 4500 PS TR is ideal in a mixed environment. It allows you to connect your printers anywhere in a Token Ring network giving all network users access to shared printer resources.

Xerox 4500 PS TR output / print share

Although the Xerox 4500 PS TR does not have a spool function, it allows several print sessions to be active simultaneously. This means that print data can be received in “parallel” from various print applications .

To avoid print mixing, some sharing functions have been implemented. See the chapter “Configuration of Xerox 4500 PS TR” for details.

Redirected host print

The Xerox 4500 PS TR may also be used for redirected printing using the ida ReRouter, idaMON or idaIPPC.

See the separate document "Redirected SNA AFP Printing - Token Ring" included on the diskette for details).



Filename: "**Redirect'**

1.1 Supported protocols

The Xerox 4500 PS TR provides support for the protocols mentioned in this section. The multiple protocol support makes it possible to have an easy conversion to the IBM hosts, Windows NT and 95, Novell NetWare, OS/2 and UNIX systems.

1.1.1 IPX/SPX protocol

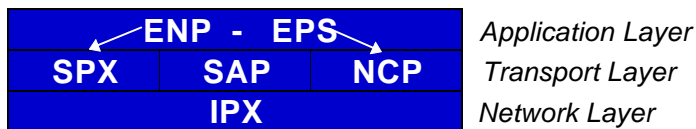

Application Layer

ENP: **E**mbded **N**Printer

Implements the NetWare remote printing functionality.
Communicates with SPX.

EPS: **E**mbded **P**rint**S**erver

Monitors the print queues and printers. Is able to monitor print queues on different network servers.
Communicates with NCP.

Transport Layer

SPX: Provides connection oriented services and guarantees packet delivery.

SAP: Provides service name to network address resolution.

NCP: Request/response protocol and the interface to the NetWare operating system.

Network Layer

IPX: Provides connection-less oriented data services.

1.1.2 TCP/IP protocol

The TCP/IP (Transmission Control Protocol/Internet Protocol) protocol is routable and enables the Xerox 4500 PS TR to reside on any network in an Internet environment.

The following TCP/IP protocols are supported by the Xerox 4500 PS TR:

Supported TCP/IP Protocols	
IP Layer	Internet Layer
IP (RFC 791)	Internet Protocol
ARP (RFC 826)	Address Resolution Protocol
TCP Layer	Transport Layer
TCP (RFC 793)	Transmission Control Protocol
UDP (RFC 768)	User Datagram Protocol
ICMP	Internet Control Message Protocol
Application Layer	
Bootp (RFC 951,1048 and 1084)	Bootstrap Protocol
LPD (RFC 1179)	Line Printer Daemon
SNMP (RFC 1157)	
SNMP - MIB II (RFC 1213)	

NOTE:

If you do not have TCP/IP on the host, redirected printing can be performed using the ida ReRouter. For details on redirected printing, see the separate document included on the diskette "Redirected SNA AFP Printing - Token Ring".

1.1.3 NetBEUI/NetBios protocol

With support for the NetBeui/NetBios network protocols, the Xerox 4500 PS TR enables printing from Microsoft (Windows 95 and NT) and IBM LAN network (OS/2) environments using the SMB (Server Message Block) printer protocol. As default the NetBEUI/NetBios protocol will be enabled and as such is ready to print using the default values.

1.1.4 ida 802.2 protocol

Native data is sent via the LPT monitor program idaMON, and IPDS data is sent via the IPDS redirecter program idaIPPC.

idaMON

idaMON is a background monitor program which communicates with the Xerox 4500 PS TR on the Token Ring and with the configuration program idaPMUTL redirecting LPT print to the Xerox 4500 PS TR.

idaIPPC

The idaIPPC is an OS/2 based redirecter included with the Xerox 4500 PS TR kit which functions as a bridge between the Host and the Xerox 4500 PS TR.

For details on redirected printing, see the separate document included on the diskette "Redirected SNA AFP Printing - Token Ring".

1.1.5 PU/LU protocol

When running in SNA IPDS mode, the Xerox 4500 PS TR will provide support for LU1 IPDS.

The Xerox 4500 PS TR supports SNA IPDS printing via PU2/LU1. It is installed and behaves as a network connected SNA PU2 cluster controller with 1 printer attached. This can be equated to a PC with a single LU1 attached printer.

Xerox 4500 PS TR will emulate the IBM 4028, IBM 3116 or similar printers running IPDS mode.

1.1.6 Illustration

The illustration in the following indicates which printer protocols are used for the supported datastreams.

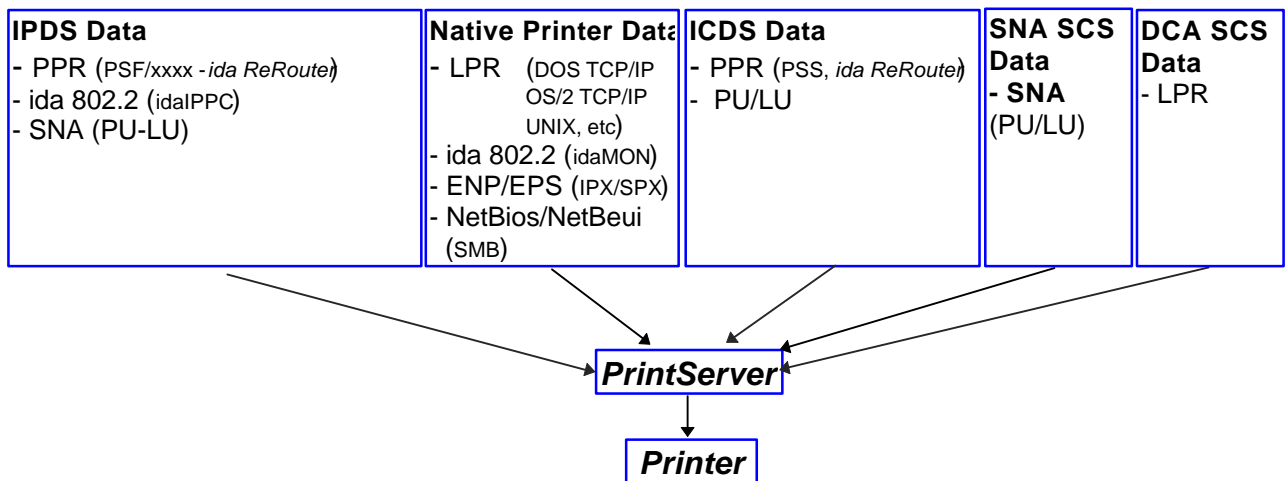

1.2 The Xerox 4500 PS TR features

The Xerox 4500 PS TR has the following features:

Xerox 4500 PS TR - non-IPDS:

- FLASH prom for firmware upgrading and settings download
- Online microcode upgrade facility
- High Performance Intel 80960 JX RISC Processor offering increased processing speed
- Setup routines for the Xerox 4500 PS TR :
 - via PSInst32
 - via Web browser
 - via Telnet
 - via BOOTP server

For details, see the chapter "Configuration of Xerox 4500 PS TR".

LAN:

- Support for SNMP (MIB II)
- Supports multiple protocols
- Supports all printers for LAN data.
- Redirects LAN native data directly to printer
- Support for Novell's embedded system's technology (NEST) in the form of embedded NPRINTER and embedded PSERVER.

ICDS:

- Supports ICDS data streams to PCL and PostScript printers.
- ICDS printing directly from ida PSS - version 7.00 (non-IPDS) or higher

Xerox 4500 PS TR IPC:

- Multiple IPDS print sessions - each with own resource environment
- Download of font sets
- IBM 3812/16, 3112/16, 3912/16 and 4028 IPDS emulations
- 2 - 18 Mb internal RAM for local storage of IPDS resources downloaded from the HOST.
- Xerox 4500 PS TR IPC prints IPDS data directly from PSF/MVS, PSF/400, PSF/2 and PSF/AIX.
- IPDS downloadable to Flash PROM from PC or host. The IPDS code is delivered in AFPDS format and can be printed like any other AFPDS file. Upon completion of the print job, the IPDS code will have been upgraded.

Redirected printing:

- Xerox 4500 PS TR IPC prints redirected IPDS data from PSF/MVS, PSF/VM, PSF/VSE, PSF/400
Redirection can be accomplished with the following products:
PSF/2, PSF/AIX, ida ReRouter, ida IPPC

1.3 System requirements

This section will briefly touch upon the various software requirements needed for the environments supported by the Xerox 4500 PS TR.

A specific description of system requirements will be provided with each supported printing environment. You are referred to the specific chapter describing the environment. See Table of Contents for an overview, or use the search facility provided with the Acrobat Reader.

1.3.1 All environments:

- Token-Ring LAN Attachment for 4 Mbps or 16 Mbps

Make sure that you have the required LAN cables to attach the Xerox 4500 PS TR .

1.3.2 Direct AFP print - mainframe / midrange

PSF/MVS
PSF/400
PSS/MVS
PSS/VM

1.3.3 LAN based AFP print

PSF/AIX
PSF/2

1.4 Supported printers

The Xerox 4500 PS TR supports the following printers:

Xerox 4505
Xerox 4510
Xerox 4517
Xerox 4520

See the chapter on Installation for details of how to install the Xerox 4500 PS TR interface into the above supported printers.

2. Installation of Xerox 4500 PS TR

When unpacking the unit, record the universal MAC address on the label attached to the rear panel of the unit.



Installation, configuration and changes to the mainframe and LAN of the Xerox 4500 PS TR must only be carried out by a person with authority and knowledge of the relevant environment.

CAUTION

The interface can be damaged by static discharge. To prevent this damage, the interface comes wrapped in an antistatic bag.

When you remove the interface from the bag and when you install it, hold the interface by the edges only. Do not touch the components or connections.

Do not throw away the antistatic bag. If the interface is removed from the printer later, it should be kept in the antistatic bag.

2.1 Pre-Installation tasks

Prior to installing the Xerox 4500 PS TR, you are to set

- **ring speed** according to your system requirements and
- check that **language settings** is correct.

→ Remaining switches are to be operated by support staff only.

These settings are performed on the Dip switch bank. The DIP switch bank sits on the interface

2.1.1 Ring speed configuration

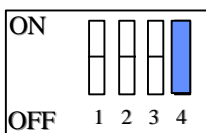

Dip switch number **4** is used for setting ring speed. You can select connection to the following token ring speeds:

- 4 Mbaud** - Dip Switch must be set to **OFF**
- 16 Mbaud** - Dip Switch must be set to **ON**

For details on network cabling connection, see the section on: “Network Installation”.

2.1.2 EU - US language settings

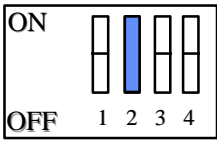

Dip switch number **2** is used for language setting.

You can select between EU and US language settings.

Should you need to change language setting, set dip switch number 2 as follows:

EU language setting - set the switch to **OFF**

US language setting - set the switch to **ON**

2.1.3 National language selection - CPGID (IPC)

When you have selected either EU or US settings, you should also check that you have the correct default codepage for your national language.

Use the program MakeITDS - supplied with this kit - to change the CPGID. In the following you will find guidelines for entering the CPGID default value in the MakeITDS program.

Make a settings printout (e.g. via the test key) containing IPDS settings and the IPDS resident codepages. The IPDS settings will state the default codepage (CPGID - Code Page Global ID). See the example of the IPDS settings in the following.

Example:

```
IPC - SETTINGS PRINTOUT
Firmware Version :Sxx xxx xxx

Basic Information
Installed Memory           : 2 Mbytes
Installed Interface        : Token Ring

IPDS Setup
IBM Emulation              : 4028
Default Codepage (CPGID)  : 01F4H (500)
Codepage Version           : 1
:
:
:
```

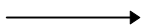

In the test page containing the IPDS resident code pages you will find the **decimal** number (second column) to be specified.

Appendix E contains a list of IPDS resident code pages.

In the idaSetup program, you must open the menu “IPDS Setup” (see section 2.5.2 in the accompanying manual). In the entry field “Default CPGID” you must enter the decimal number for the required national language.

Example:

You wish to change to the Japanese (English) code page.

Enter decimal no. **281** in the entry field for CPGID.

2.2 Rear panel

Below is an illustration of the rear panel of the Xerox 4500 PS TR and a short description of the panel elements.

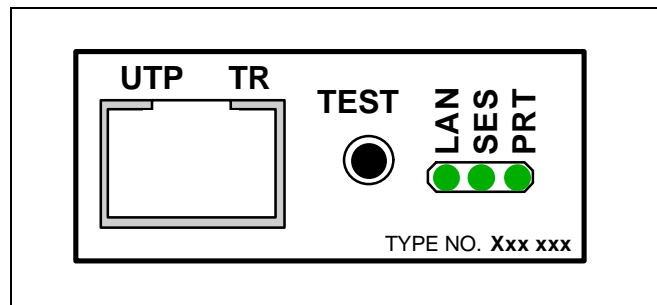

Xerox 4500 PS TR rear panel

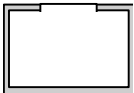

UTP

Unshielded twisted pair connector (RJ 45).

NOTE:

If your system is running STP you must connect the cable supplied with the kit.

LED indicators

The LEDs are used for verification purposes.

The tables below show the LED status once the Xerox 4500 PS TR is up and running.



PRT

Indicating data to the printer.

LED Status	Description
OFF	No data is being sent to the printer
Blinking (async)	Data is being transferred to the printer



LAN

Used to indicate the LAN status

LED Status	Description
OFF	No physical connection to LAN
ON	Connection to LAN is established
Blinking	Connection to LAN is established, but no boot reply has been accepted. Refer to the chapter "Configuration of Xerox 4500 PS TR for details.



SES (SION)

Indicates TCP/IP data transmission activity.

LED Status	Description
OFF	No data is being transmitted from the LAN (TCP/IP)
Blinking (async)	The SESSION LED blinks when data is being processed or received (TCP/IP)



TEST key

The test key can be used for generating a test page.

2.3 Installation procedure

This section describes the installation of the Xerox 4500 PS TR interface into one of the supported printers.

NOTE:
Before you start the installation you must power OFF.

2.3.1 Installing into Xerox 4505 / 4510 printer

1. Remove the plastic cover from the rear of the printer.
2. Loosen the thumb screws.
3. Pull out the motherboard by the handle.
4. Dismantle the two blankets indicated as “A” and “B” in the figure below. Save the 4 screws for later use.
5. Prior to inserting the interface in the motherboard, you are recommended to tighten loosely one screw in the interface’s rear panel and one in the Centronics panel.
6. Place the interface in the slot marked “A” and place the Centronics in the slot marked “B”.

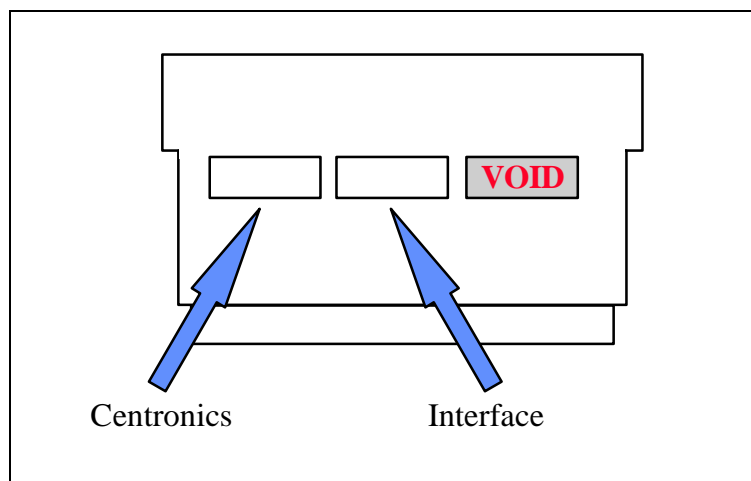

7. Now fasten the two screws you loosely inserted in step 3.
8. Fasten the two remaining screws.
9. Re-insert the motherboard into the printer and fasten the “thumbscrews”.

NOTE:

Turn power **ON** and generate a settings printout - pressing the test key on the rear panel - to check that the connection to the printer has been established.

2.3.2 Installing into Xerox 4517 printer

1. Loosen the “thumbscrews”.
2. Pull out the motherboard from the printer.
3. Dismantle the two blankets and save the 4 screws for later use (see step 4).
4. Prior to inserting the interface in the motherboard, you are recommended to tighten loosely one screw in the interface’s rear panel and one in the Centronics panel.
5. Place the interface in the lower (middle) slot of the motherboard (marked “A”) and place the Centronics cable in the upper slot (marked “ B”).

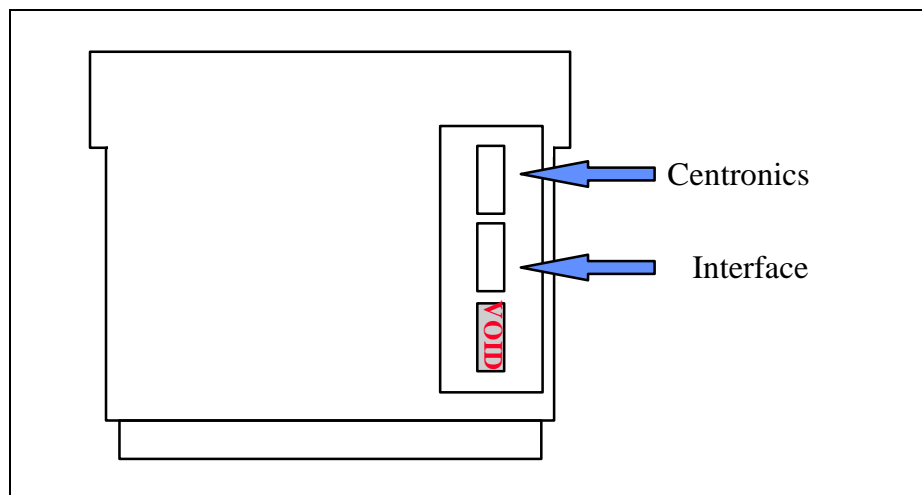

6. Now fasten the two screws you loosely inserted in step 3.
7. Fasten the two remaining screws.
8. Re-insert the motherboard into the printer and fasten the “thumbscrews”.

NOTE:

Turn power **ON** and generate a settings printout - pressing the test key on the rear panel - to check that the connection to the printer has been established.

2.3.3 Installing into Xerox 4520 printer

1. Loosen the “thumbscrews”.
2. Pull out the motherboard from the printer.
3. Dismantle the two blankets and save the 4 screws for later use (see step 4).
4. Prior to inserting the interface in the motherboard, you are recommended to tighten loosely one screw in the interface’s rear panel and one in the Centronics panel.
5. The interface is to be placed in the slot marked “ **A**” and the Centronics in the slot marked “ **B**”.

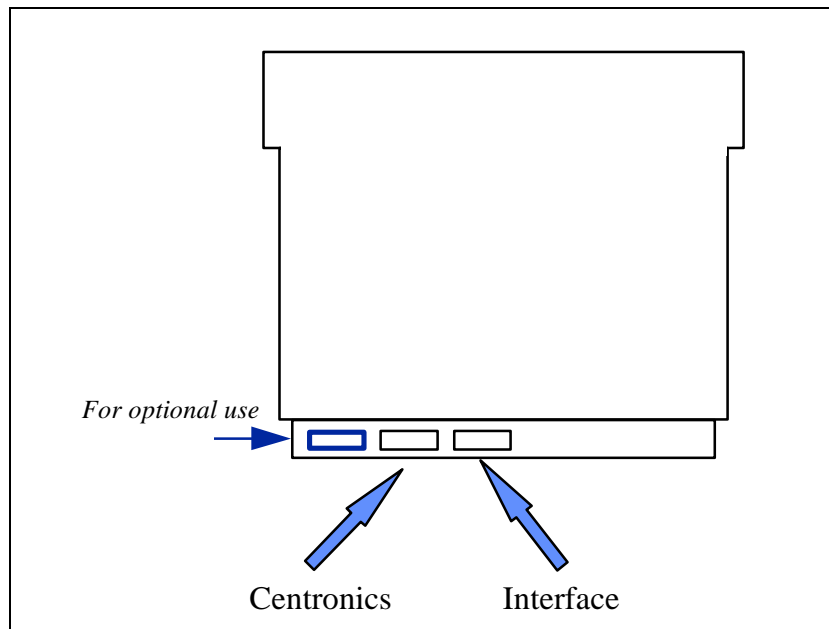

6. Now fasten the two screws you loosely inserted in step 3.
7. Fasten the two remaining screws.
8. Re-insert the motherboard into the printer and fasten the “thumbscrews”.

NOTE:

Turn power **ON** and generate a settings printout - pressing the test key on the rear panel - to check that the connection to the printer has been established.

2.4 Share timeout

When Xerox 4500 PS TR operates as a print server for multiple environments simultaneously, print corruption is avoided by excluding all other printing as long as a print job is being printed. This is done via a Share Timeout. The Share Timeout defines an idle time for switching between printer sessions. As a default, the Share Timeout is set to 20 seconds, but this can be changed via the configuration file (See the various configuration options for details).

NOTE:

- The Share Timeout must be set to a value which is less than the printer's internal printer share timer.
- **Native Share Strings:**
No share string functionality is included in the Xerox 4500 PS TR when printing non-IPDS data, so it is up to the application to ensure the correct printer environment.

IPDS Share Strings

To ensure that the printer environment is correct for IPDS printing, share strings can be programmed using the idaSetup (MakeITDS) Setup program.

IPDS resources downloaded to the printer are deleted on share boundaries and are therefore downloaded to the next print job (next usage).

2.5 Network installation

1. Switch off the printer.
2. Connect the UTP cable to the network port on the PrintServer.

NOTE:

If you use the STP cable connection, you must use the cable supplied with the kit to convert STP to UTP cabling.

3. Switch on the printer.
4. Test the Xerox 4500 PS TR (by pressing the TEST key).

When IP address has been defined:

If the TCP/IP is enabled, the LAN LED will - if **BOOTP parameter set to YES** - start to flash as the Xerox 4500 PS TR tries to contact a BOOTP server. If no BOOTP server is available, the Xerox 4500 PS TR will use defaults. If valid default values are found, the LAN LED will remain lit.

The printer and network installation is now complete. For advanced configuration, see the chapter "Configuration of Xerox 4500 PS TR".

2.6 Installing upgrade modules

This section provides installation guidelines for IPDS or FSL upgrade modules.

1. Disconnect all cables to the Xerox 4500 PS TR.
2. Loosen the thumbscrews and pull out the interface
3. Place the Xerox PS upgrade module (be it IPDS or FSL) on the 4 plastic spacers on the base module. Make sure that the pins on the connector J(x) fits correctly.
4. Remount the interface into the printer and fasten the 2 thumbscrews loosened in step 2.
5. Generate a settings printout to verify the installation of the upgrade module.

The printer and network installation is now complete. For advanced configuration, see the chapter "Configuration".

FIRMWARE DOWNLOAD

Firmware download when the PrintServer is equipped with a top module can be done easily via Psinst32. See this section for details.

3. Configuration

This chapter describes how the *PrintServer* may be subject to a more advanced configuration using the supported setup facilities (see below). However, with a minimum configuration of the selected protocol, the *PrintServer* is ready for operation. For details on operation based on default settings, see below.

3.1 Introduction to configuration

When installing your *PrintServer*, first of all you must **configure the protocol needed** in order for the system to be able to communicate with your *PrintServer*.

Thus, you should **ensure that the protocol you want to use for printing has been enabled** on the *PrintServer*. For example, if you wish to print from Novell you need to enable the IPX/SPX protocol and configure it and if you need to print SNA print from a host, you should enable the SNA (PU/LU) protocol and configure it. These two protocols are *not* enabled by default in the product. This configuration is carried out in PSinst32 or using one of the following tools:

- ⇒ Web Browser
- ⇒ Telnet
- ⇒ Configuration file
- ⇒ BOOTP server

See the section on “Minimum Configuration” for more details on minimum setup via each tool.

When you are sure that you have configured the *PrintServer* according to your specific needs (see this chapter: chapter 3), you will have to make the needed **definition on the system** in order to be able to send print to the *PrintServer*. For this you proceed to the chapters 4-17.

3.1.1 Which Configuration Tool Do I Choose to Configure My PrintServer?

When delivered, the product has a MAC address but no IP address.

NOTE:

If the PrintServer is to be used for TCP/IP print, you need to define an IP address in the PrintServer. If you wish to configure via the Web browser or using Telnet, you need to define an IP address in the PrintServer as well. You do this in Psinst32 or via BOOTP.

About the IP Address

The IP address is unique in the Internet environment and consists of a network ID and a host ID.

3.1.1.1 Psinst32

See section 3.3 for details

3.1.1.2 BOOTP Server

BOOTP may also send config files as well as download firmware. See section 3.7 for details.

3.1.2 In General on Configuration...

The *PrintServer* can be subject to advanced configuration in general. This can be done in a number of ways which will be dealt with later in this document. The various configuration methods are:

- ⇒ configuration via PSinst32
- ⇒ configuration using Web browser
- ⇒ configuration via Telnet
- ⇒ configuration using a configuration file
- ⇒ configuration using BOOTP server

3.2 Minimum configuration

With a minimum configuration on protocol level in addition to the default settings, the *PrintServer* is ready for operation.

A minimum configuration is necessary as it is system dependent and no default value will apply in this case. The parameters stated in the minimum configuration are **mandatory** settings for the *PrintServer* to become operational.

To set the minimum configuration parameters, use either the program *PSInst32* or the *minimum configuration file* supplied with the configuration diskettes.

The minimum configuration only covers the most basic printing needs and a more advanced configuration will have to be done using of the other supported configuration methods.

PSInst32

This program is described later in this chapter.

Minimum configuration file

Modify the parameters in the minimum configuration file to suit your system configuration. A sample configuration file is shown later in this chapter. For download of the configuration file, see the section "Configuration using Setup file".

3.2.1 Mandatory settings

TCP/IP

If you wish to operate via the TCP/IP protocol, the parameters below must be set. These are system dependent and thus the default values will not apply. Once these parameters have been defined, printing via LPD and PPD ports can be performed.

Mandatory parameters:

☞ IP address	→	<i>These parameters should<u>not</u> be chosen at random. Contact your system administrator for details.</i>
☞ Subnet mask		
☞ Gateway		

IP address

To receive data on your network you need to define an IP address.

This IP address is unique in the Internet environment and consists of a network ID and a host ID. The IP address uses the address classes A, B and C for the various network sizes.

Subnet masks are determined by assigning ones to bits belonging to the network ID and zeros to bits belonging to the host ID.

The subnet masks may be represented in 32-bit values or as dotted decimal notation.

E.g.:

<u>Class values</u>	<u>Subnet mask</u>
A	1-126 255.0.0.0
B	128-191 255.255.0.0
C	192-223 255.255.255.0

NETWARE - IPX/SPX

To operate via the IPX/SPX protocol thus using the Embedded Print Server (EPS) and the Embedded Printer (ENP) , you will first have to

☞ **Enable NetWare parameter.**

Subsequently you must define the following NetWare parameters:

- ☞ **Set mode** *Bindery (vs. 3.1x)*
DS (vs. 4.x)
- ☞ **Set Preferred SERVER**
- ☞ **Set Preferred DSTREE** *(valid for vs 4.x only)*
- ☞ **Set DS name context** *(valid for vs 4.x only)*
- ☞ **For EPS**
 - *mode*
 - *printserver*
 - *fileserv*
- ☞ **For ENP**
 - *printer number*
 - *fileserv*
 - *printserver*

SNA-SCS PRINTING - PU-LU

To operate via the SNA (PU-LU) protocol, you must first set the following:

☞ **Enable PU_LU**

Subsequently, define the following parameters:

- ☞ **Set Remote MAC** *(of the upstream device)*
- ☞ **Set IDNUMBER** *(exchange ID number)*
- ☞ **Set BLOCKNUMBER**

NetBEUI / NetBios

To operate via the NetBeui / NetBios network protocol no need for special setup is required as printing can be performed using default values.

ida 802.2

To operate via the ida 802.2 protocol, no need for special setup is required as printing is performed using default values.

3.3 Configuration using PSinst32

The *PSinst32* is a 32 bit i-data program using ida 802.2 **to be run under Windows 95 or Windows NT**. The program may be used for setting up **basic parameters** in the *PrintServer* via GUI panels. *The program is designed to complement the other PrintServer configuration tools used for more advanced settings.*

This section will limit itself to an outline description. For details you are referred to the extensive Help provided with the program. See the following section.

Firmware download can be done using PSinst32. See the instructions provided in section 3.3.8 "Firmware download".

3.3.1 Program Installation Procedure

Run the installation file from the first Configuration file disk (disk 1/2). From the Windows "File" menu, select "Run" and type: a:\setup.exe and press ENTER. Now follow the instructions given in the installation program.

NOTE:

You will be asked whether you wish to "install any PrintServer Drivers?". The drivers referred to here are the various firmwares for the FSL top module.

3.3.2 Program Execution

CAUTION

To make the PSinst32 program run correctly, you should check that the Microsoft 32-bit DLC network protocol has been installed correctly.

The installation procedure varies from Windows 95 to Windows NT. See the instructions immediately below:

Windows '95 DLC Installation Procedure:

NOTE:

You need to have access to the CD-ROM with your original operating system.

Click "Start" in the bottom left corner of the screen

Click "Settings"

Click "Control Panel"

Doubleclick "Network"

Click the "Configuration Form" and check for Microsoft 32-bit DLC

- if installed then click "OK" and continue with the installation of Psinst32
- if NOT then continue below:

Click "Add"
Highlight "Protocol"
Click "Add"
Highlight "Microsoft" in the manufacturer window
Click "Have disk"
- insert the "PS configuration, disk 2/2" supplied with the *ida PS x4 NP*
in drive a:
Click "OK"
Click "OK" and the installation begins
Click "OK" when returning to the "Network Configuration Form"

You are now prompted to insert the CD-ROM with your original operating system mentioned in the beginning. Please follow the instructions given.

When finished, click "NO" to restart of computer
Click "Start"
Click "Run"
Click "Browse" (your floppy drive a:)
Highlight "DLC32UPD.EXE"
Click "Open"
Click "OK"
Click "Yes" to update
Click "OK" to update completely
Remove floppy disk in drive a: and restart the computer

Windows NT 4.0 DLC Installation Procedure:

NOTE:

You need to have access to the CD-ROM with your original operating system.

Click "Start" in the bottom left corner of the screen
Click "Settings"
Click "Control Panel"
Doubleclick "Network"

Click "Protocol" and check for "DLC Protocol"
- if already installed, click "OK" and proceed with the PSinst32 installation
- if DLC protocol is not installed then click "Add"

Highlight "DLC protocol"
Click "OK"

You are prompted to insert the CD-ROM with your original operating system mentioned in the beginning. The installation commences so please be sure to follow the instructions given.

When finished, click “Close”.

Click “Yes” to restart the computer to activate the DLC protocol.

You can now proceed with the PSinst32 installation.

No configuration of the DLC protocol is necessary.

NOTE: - **Windows 95 only** -

The DLC protocol must be the Microsoft 32-bit DLC (on disk 2/2 with configuration files) for the PSinst32 to become operative.

Executing PSinst32

To execute the PSinst32 program, you do as follows:

1. From  **Start**, select “**Program**”, then “**i-data PrintServer Configuration Tool**” and finally “**PSinst32**”.

3.3.3 Help



You may obtain further information/Help wherever you are in the program. The main menu and every other menu has a Help button - click this to know more about the present panel or to look up a search word in general.

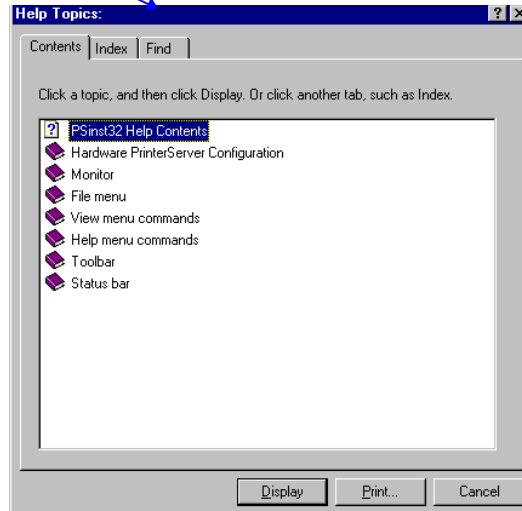

You may also obtain *context sensitive* help for a particular field or form in the program. Go to the toolbar and click this icon.



The cursor will become the shape of a question mark. Now you may choose to query menus from e.g. the File menu simply by clicking it. Or you may click the Property Sheet or Monitor Sheet to obtain further information.

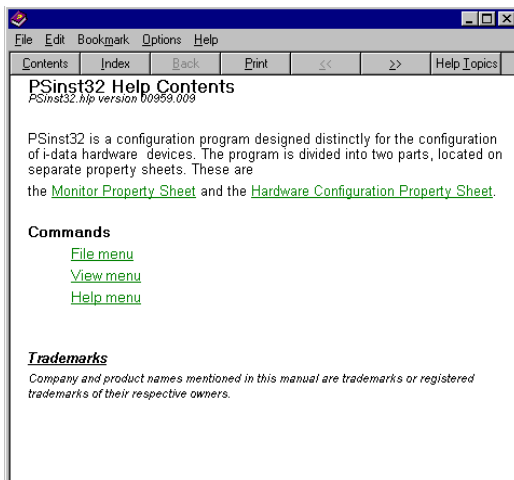

3.3.4 Main menu - Where do I start with PSinst32?

When you have installed the program, you will be met with the Main menu. The main menu has two overall sub-category forms:

- *Hardware PS Property Form*

From here you enable the protocol(s) of your choice and subsequently make the necessary configuration entries.

- *“Monitor” Property Form*

When you have selected a DLC download port (LAN), this menu will list all the devices attached to the LAN.

You start your configuration in the *Hardware PS Property Form*, filling in the basic information such as name and system location needed to identify you as a user. Then proceed to the next section in this manual.

Main Window

Hardware PS

From this menu you will be able to configure your PrintServer.

Monitoring

If you have selected LAN download (see section 3.3.7), the “Monitor” form will show all discovered devices by MAC address and Name.

The screenshot shows the 'Hardware PS' configuration window. It has two tabs: 'Hardware PS' (selected) and 'Monitor'. The 'Hardware PS' tab contains the following fields and options:

- PrintServer Name: [Text Input Field]
- Contact Name: [Text Input Field]
- System Location: [Text Input Field]
- Enable TCP/IP: [Configure TCP/IP]
- SPX/IPX: [Configure SPX/IPX]
- Enable PU/LU: [Configure PU/LU]
- Enable NetBeui: [Configure NetBeui]
- Boot PrintServer after download:

Callouts in the image:

- A blue box labeled 'Hardware PS' points to the 'Hardware PS' tab.
- A blue box labeled 'Monitoring' points to the 'Monitor' tab.
- A blue box labeled 'Names and system location entered by user' points to the three text input fields.
- A blue box labeled 'Protocols Tick the entry for "Enable" before configuration can take place.' points to the 'Enable' checkboxes and their corresponding 'Configure' buttons.
- A blue box labeled 'Tick this entry if you wish to boot the PrintServer after download' points to the 'Boot PrintServer after download' checkbox.

Tick this entry if you wish to boot the PrintServer after download

3.3.5 Program setup - Configuring Your Preferred Protocol

When you have filled in the first three entries in the menu for the Hardware Property Form:

- PrintServer name (a fully qualified domain name)
- Contact name
- Location (physical location of the unit)

.. you proceed to **the selection of your preferred protocol environment and subsequently to the configuration of it**. This is necessary in order for your system to be able to communicate with your PrintServer.

Select between:

- TCP/IP (including SNMP - MIB II)
- IPX/SPX (Netware)
- PU/LU (SNA)
- NetBIOS/NetBEUI (Windows and OS/2)



Here's how you configure the various protocols:

3.3.5.1 Configure TCP/IP

You enable the TCP/IP protocol by clicking the check box to the immediate left of the header "TCP/IP". When you have enabled the protocol, you will be able to configure the following entries:

The screenshot shows the 'Configure TCP/IP' dialog box with the following fields and buttons:

- Default IP-Addr: 0.0.0.0
- Default SubNet Mask: 255.255.0.0
- Default Gateway: 0.0.0.0
- Use BootP Server
- SNMP button
- OK, Cancel, Default, and Help buttons

Annotations with arrows point to the following elements:

- Set default IP address. (points to Default IP-Addr)
- Set default subnet mask (points to Default SubNet Mask)
- Set default gateway (points to Default Gateway)
- Tick this for SNMP application. SNMP - MIB II (see next section in this chapter) (points to the SNMP button)
- Tick this entry if you wish to use a BOOTP server (points to the Use BootP Server checkbox)
- Seek additional information here (points to the Help button)

NOTE: IP Address

To receive data on your network, you need to define an IP address. This IP address is unique in the Internet environment and consists of a network ID and a host ID.

3.3.5.2 Configure SNMP

If you click the “SNMP” button in the TCP/IP menu, you will see the following screen:

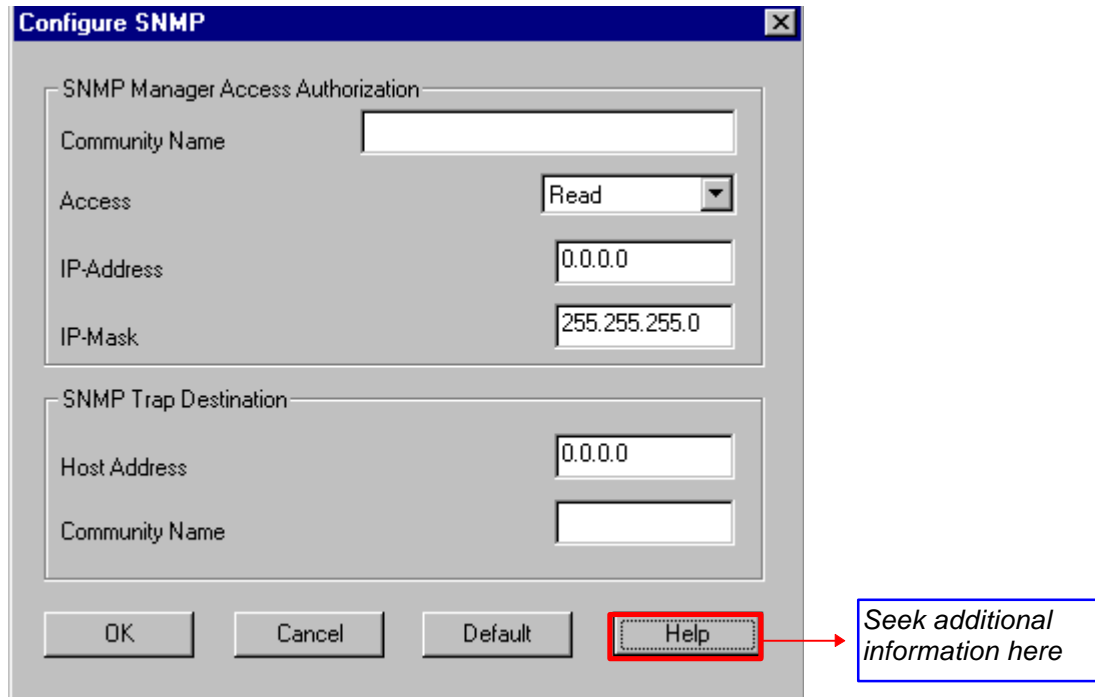

3.3.5.3 Configure SPX/IPX (NetWare - ENP)

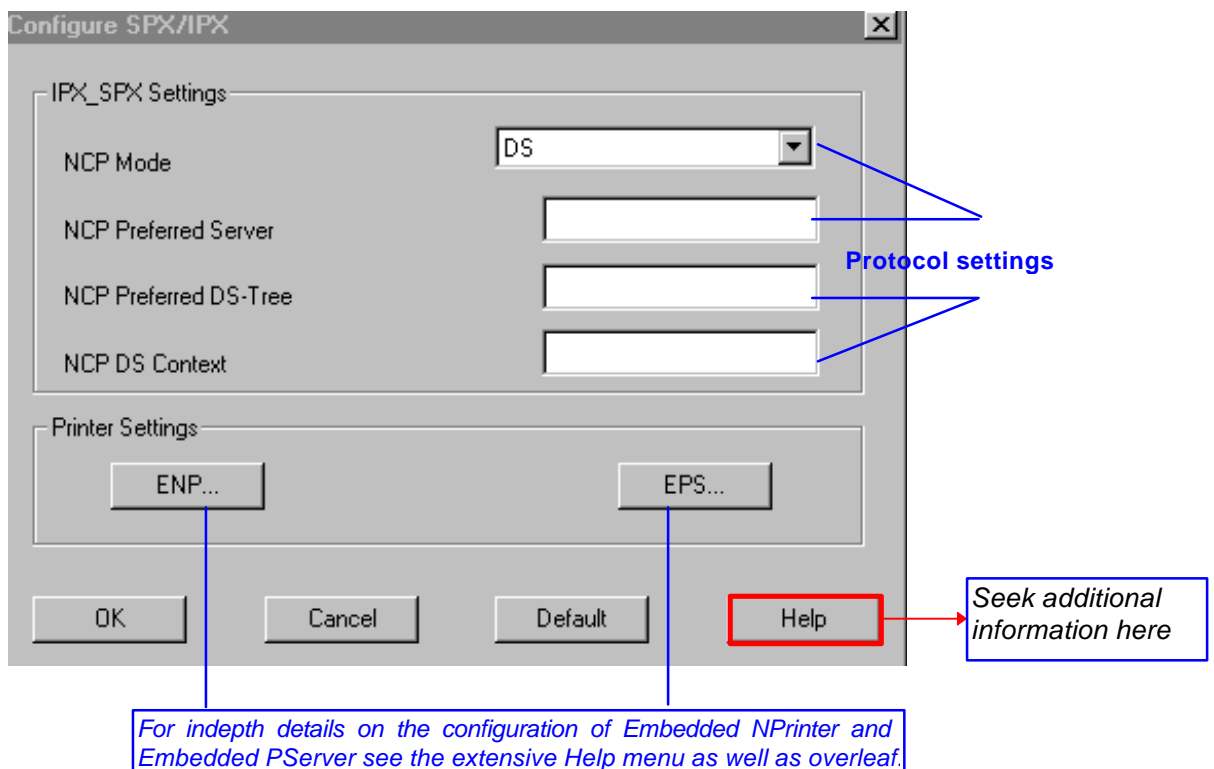

The ENP (Embedded N-Printer) submenu:

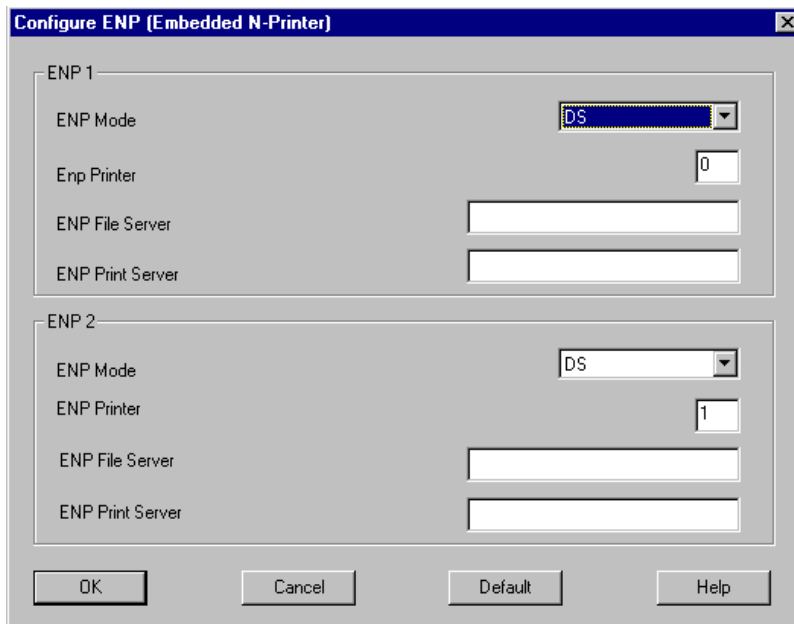

The EPS (Embedded PrintServer) submenu:

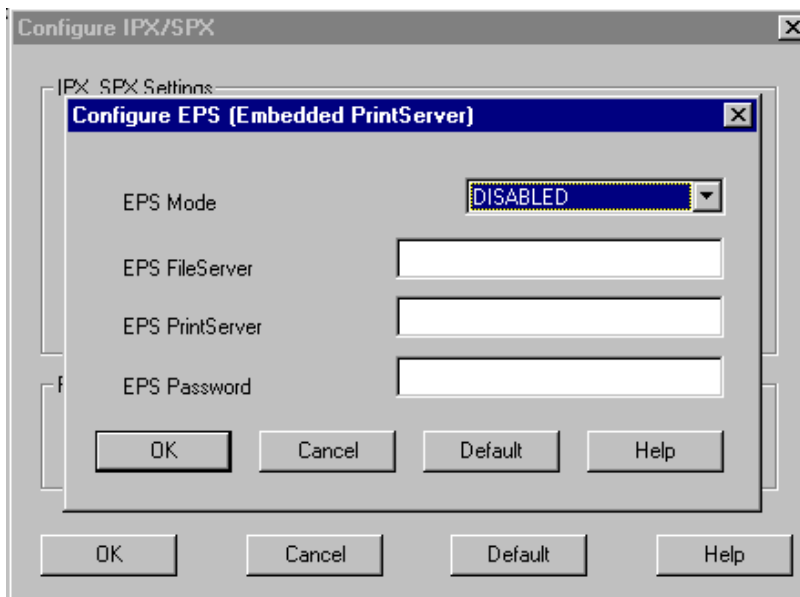

3.3.5.4 Configure SNA (PU/LU)

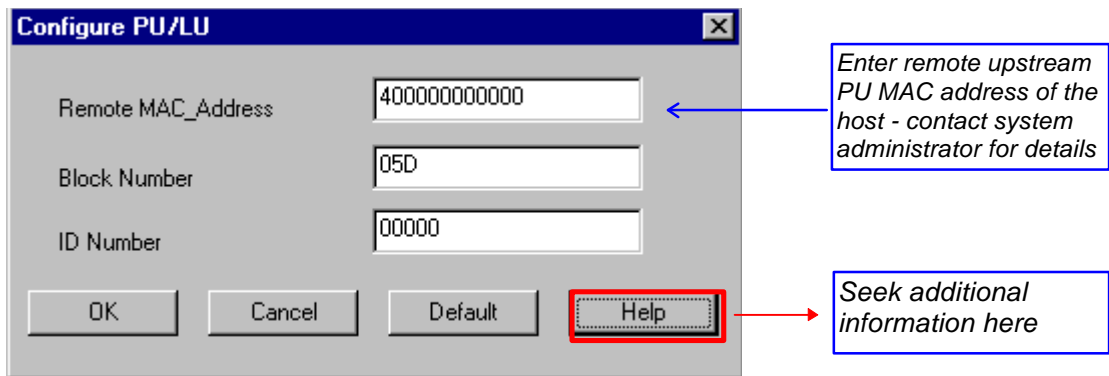

3.3.5.5 Configure NetBEUI/NetBIOS (Windows and OS/2)

NetBEUI means “NetBIOS Extended User Interface”.

Enable the Windows NetBEUI protocol from the Main menu to enter/modify the settings for the Windows and OS/2 protocol.

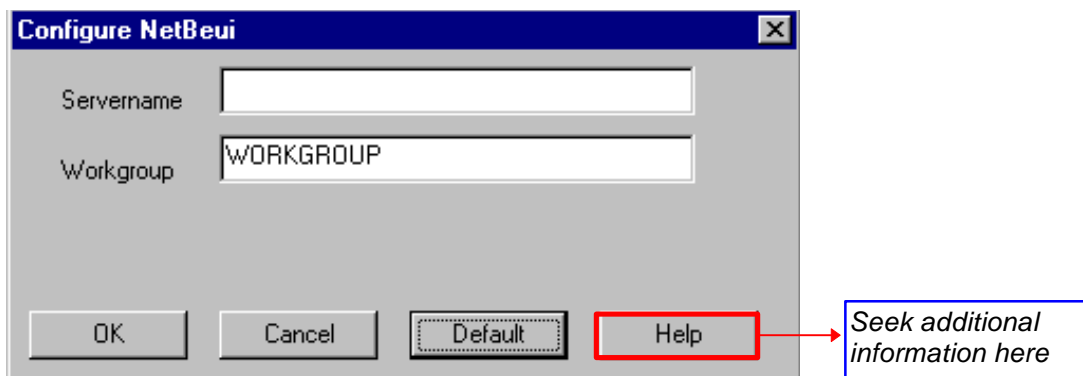

When running the NetBEUI protocol, you should note that only **native data** will be processed. Attempts to generate host print (IPDS or SCS data) will not be processed.

3.3.6 Further Options - The File Menu



Before you move on to the next chapter to learn how to download your recently defined settings (configuration of preferred protocol), let us just sum up briefly:

Using the PSinst32 as the initial configuration tool provides you with the options listed here:

- Configuration of network protocols:
TCP/IP, IPX/SPX- including embedded printer configuration (Novell Netware), **PU/LU (SNA), NetBEUI / NetBios**(Windows and OS/2 via SMB printer protocol)
- Network management configuration - SNMP
- Download method (via LAN or parallel port) - see section 3.3.7

Now follows a description of the operations you are able to perform after you have enabled and configured your protocol(s). So, let us take a look at the "File" menu. The "File" menu is located in the top left corner of the main form.

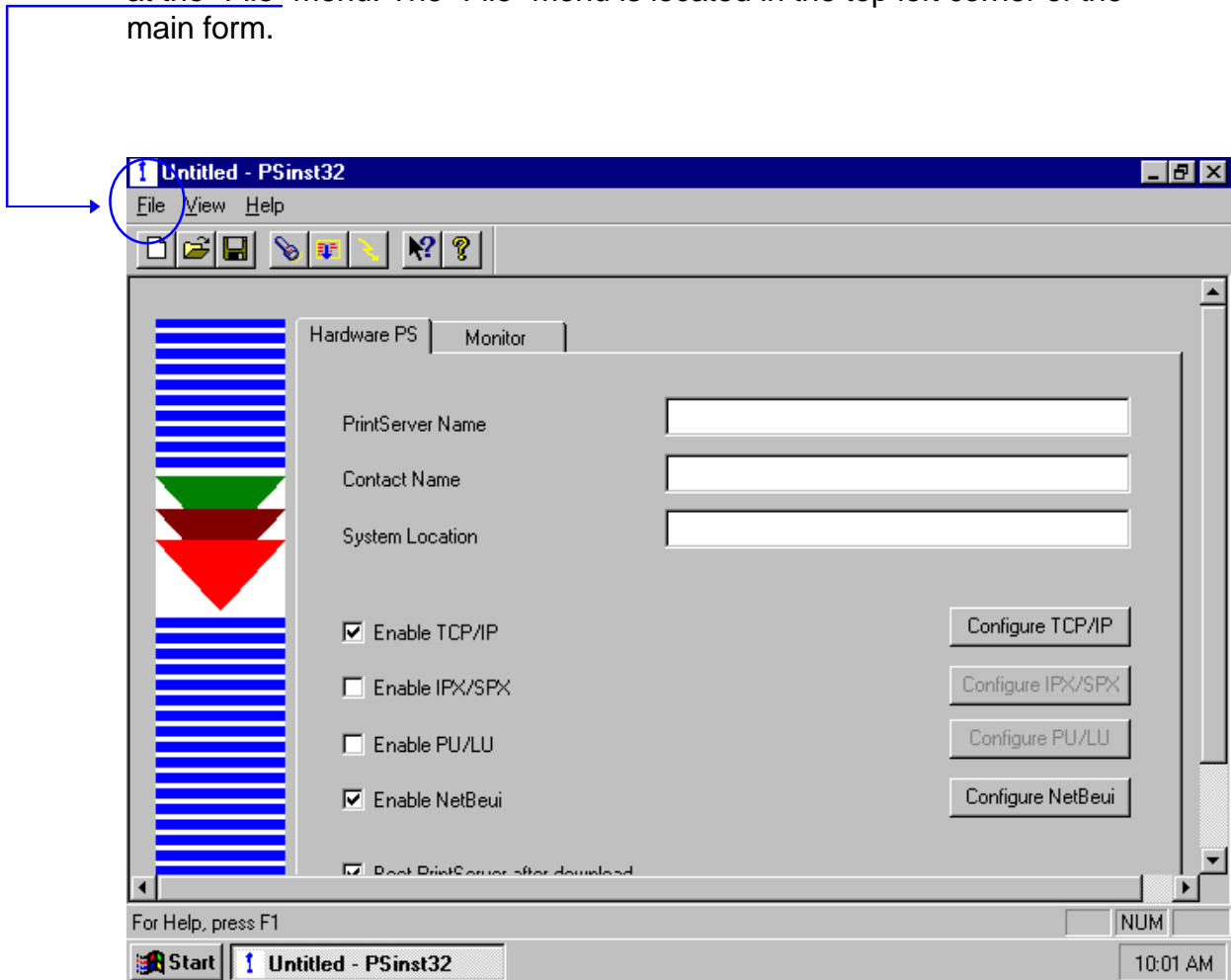

The File menu has the following actions available:

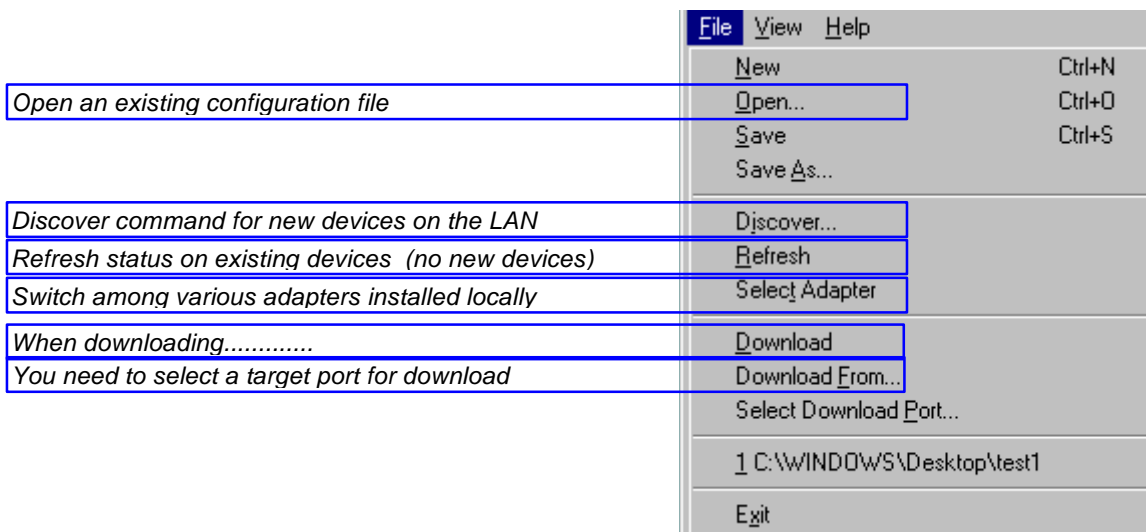

Below you will find guidelines to the various options listed on this menu

“Discover..”

This function will receive replies from **all** devices attached to the LAN
The Discover command is also available via the toolbar - look for the icon with the flashlight on it. When you have selected LAN as the download method (see below), the discovery function will receive a reply from the device without any prior configuration.

NOTE:

The discover function puts a heavy burden on network traffic - so use it with care.

“Refresh”

The Refresh command performs a sequential query for all the existing devices on the LAN - i.e. will not see **new** devices. Allow some time for this process to finish.

NOTE:

Rather use the Refresh command than the discover operation, to ensure low network traffic if you only need to refresh the device status

“Select Adaptor..”

Allows you to switch between different locally installed adaptors.

“Download..”

Allows you to download a file to the PrintServer

“Select Download Port..”

In order to download a configured file, you will have to select a target port.

The PSinst32 leaves you with two options:

- Download via Parallel port (select LPT 1, 2 or 3)
If using this option you will not be able to use the monitor function.
- Download via LAN (select DLC - **NOTE:** Check installation)
When using LAN as download method, you will be presented with a dialog containing a list of discovered devices. The devices are discovered by MAC address. See the “Broadcasting” section 3.3.9.

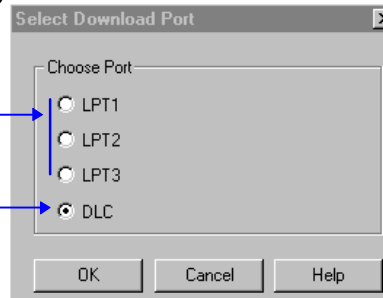

3.3.7 End of Configuration - Downloading Settings to the PrintServer

When you have completed the configuration of the selected protocol environment(s), you must download the new settings to the selected target port. This download target port may be **the parallel port or the LAN**

“Select download port...”

Choose the “Select Download Port” option from the “File” menu in the top left corner of the screen. The following form will be displayed:

- Download via Parallel port (select LPT 1, 2 or 3)

If using this option you will not be able to use the monitor function.

- Download via LAN (select DLC - **NOTE:** Check installation)

When using LAN as download method, you will be presented with a dialog containing a list of discovered devices. The devices are discovered by MAC address. See the “Broadcasting” section 3.3.9.

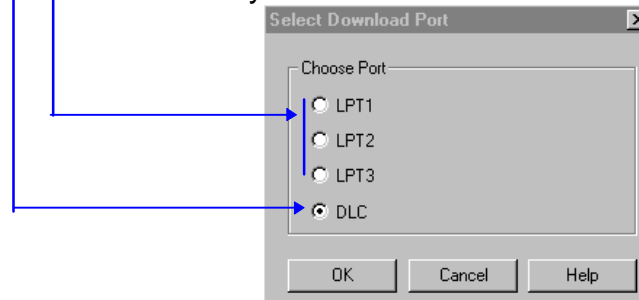

NOTE:

Downloading via Parallel Port: you have to use a share cable for this download process. Part number for the share cable: 999 022 030. Contact your point of purchase for more details.

Next, select the menu “Download” in the “File” menu which you will find in the top left corner of your main menu.

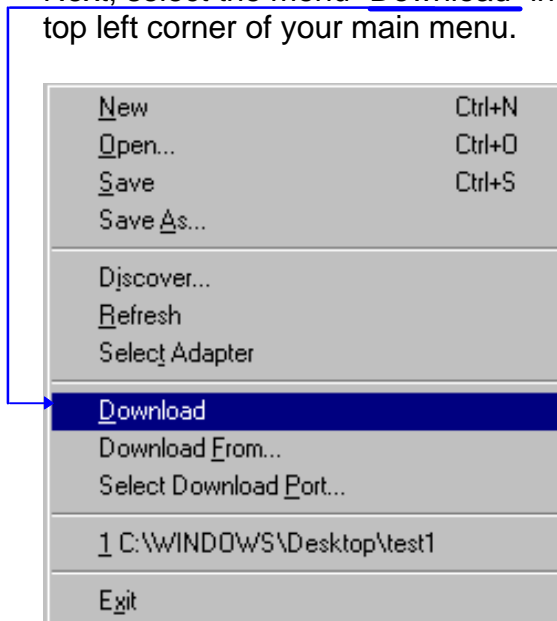

Now the Monitor form will appear listing all available devices on the network.

NOTE:

If the Monitor form does not appear by itself, click the Monitor form and select the “Discover” function to contact your device. The “Discover” function will perform a broadcast on your network, contacting and subsequently listing all available devices. You can activate the “Discover” function from the “File” menu (see illustration above) or by clicking this icon:



When your device is listed in the Monitor form, highlight the device and click “OK” to download your new settings to it.

Boot PrintServer after download

You will find this option in the main menu “Hardware PS” Form.

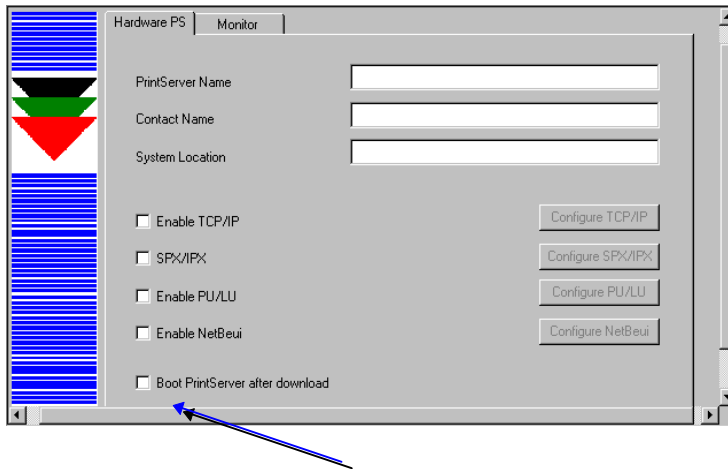

If the new settings you have just downloaded *differ* from the current settings - *and* no error situations have occurred - , the PrintServer will immediately be booted when ticking the field “ **Boot PrintServer.....**” . The display of warning messages does not prevent the PrintServer from being booted.

3.3.8 Firmware download

It is possible to download firmware via PSinst32 by activating the menu “Download From..” from the “File” menu. When activated you will see this screen:

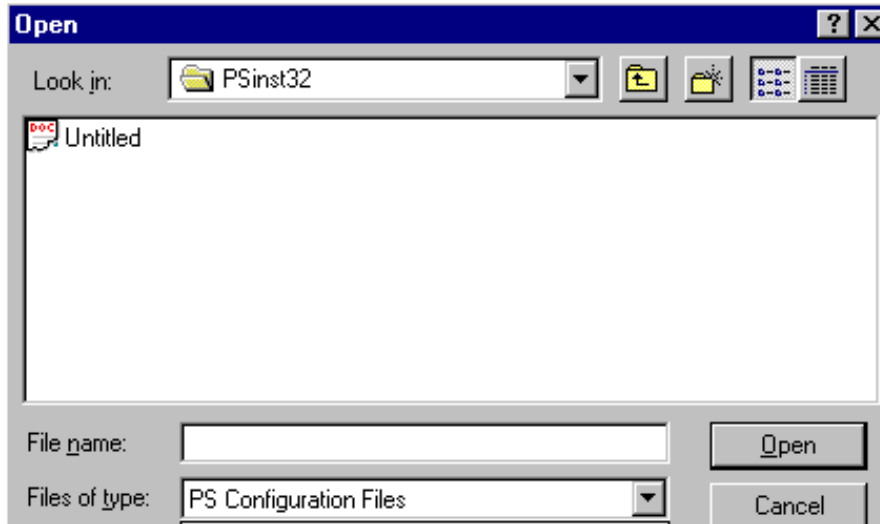

As a default PSinst32 will prompt for download of PrintServer configuration files but other files can be downloaded clicking “Files of type”:

- PS Configuration Files
- MakeITDS Configuration Files
- IPDS Top Firmware
- FSL Top Firmware
- IPDS Fontset
- Base Code
- All files

In the following you will see how to download firmware in the shape of PrintServer drivers when the PrintServer is equipped with a top module for IBM 3270 or IBM 5250 environment printing.

Example of downloading firmware for PrintServer drivers

When the PrintServer is equipped with a top module for printing in IBM 3270 or 5250 environments, the driver can be downloaded as follows:

1. In the above form click “Files of Type”
2. Select “FSL Top Firmware”
3. On the screen you will see a number of drivers.

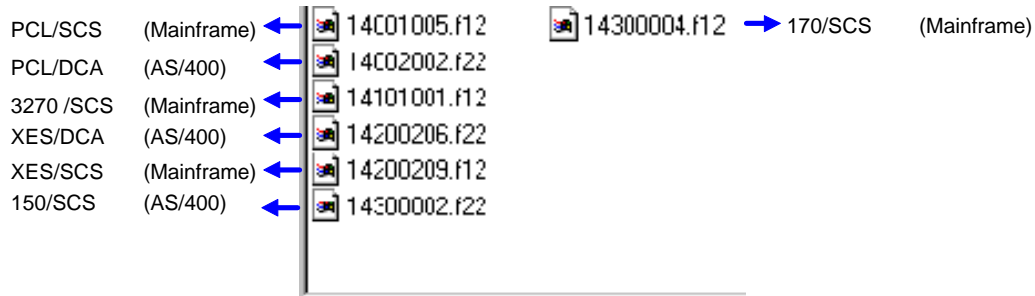

4. Highlight the driver you wish to use and click “ **Open**”.
5. Now the Monitor Form screen with the attached devices will appear. In this menu, you highlight the device to where you wish to download the PrintServer driver.
6. When selected, click “ **OK**” and the firmware is downloaded to the device.

3.3.9 Broadcasting

One of the strong features of PSinst32 is the ability to detect and configure devices via the LAN. When the DLC port has been selected as download port, it is possible to detect devices even before an IP address has been associated. This kind of detection is called *broadcasting*. A broadcast message is issued through all bridges on the LAN. All associated devices will be able to recognize this message, and will return an identification message. The monitor sheet displays all devices which respond to the broadcast message.

NOTE:

Since broadcasting puts a heavy burden on the network, it should be limited to a minimum.

If you only need to update the status of the devices attached to the LAN, you are recommended to use the “Refresh” command instead of the “Discover” to lower network burden.

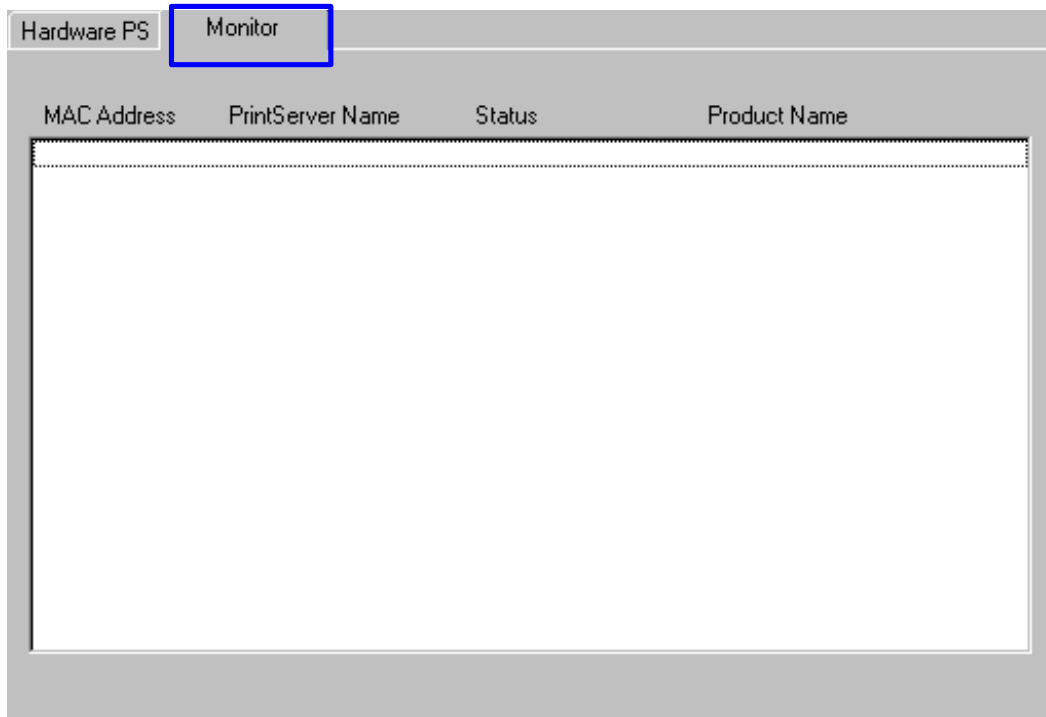

The Monitor menu screen consists of the following information fields:

- *MAC address:*
This is the MAC address of the device. When activating the discover (or Refresh) command, the device will sort the devices according to MAC address and Name. New configured devices will be displayed at the top.
- *Name:*
This is the name (*if any*) the user has attached to the PrintServer
- *Status:*
The status menu will show the present status of the output ports on the device. For detailed status information, double-click on a specific device.

3.4 Configuration using Web Browser

With a standard Web Browser, the *PrintServer* supports configuration and status tasks. This section provides an outline description of the settings to be performed using the Web browser.



3.4.1 Requirements

A standard Web browser with Frame support.
If you use a no-frame browser (e.g. Microsoft Explorer), certain functions will not be supported.

3.4.2 Access to ida HTML configuration

A configuration session requires the log on to the *PrintServer* entering your IP address.

At the URL prompt type:

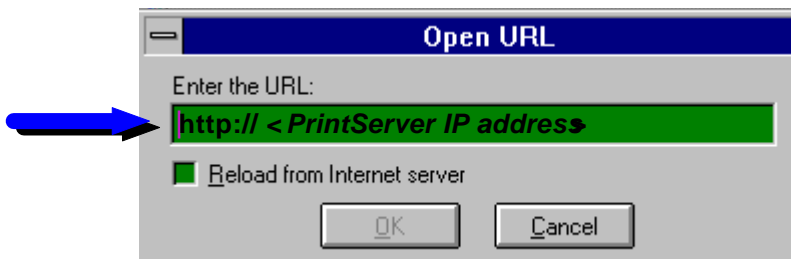

3.4.2.1 IP address

The IP address may be defined using one of these configuration tools:

- PSinst32
- Setup file
- BOOTP

These configuration methods are described elsewhere in this manual. For details on the IP address, you are to consult your system manager.

When you have executed the URL command, you will be presented with the following *PrintServer* HTML configuration panel:

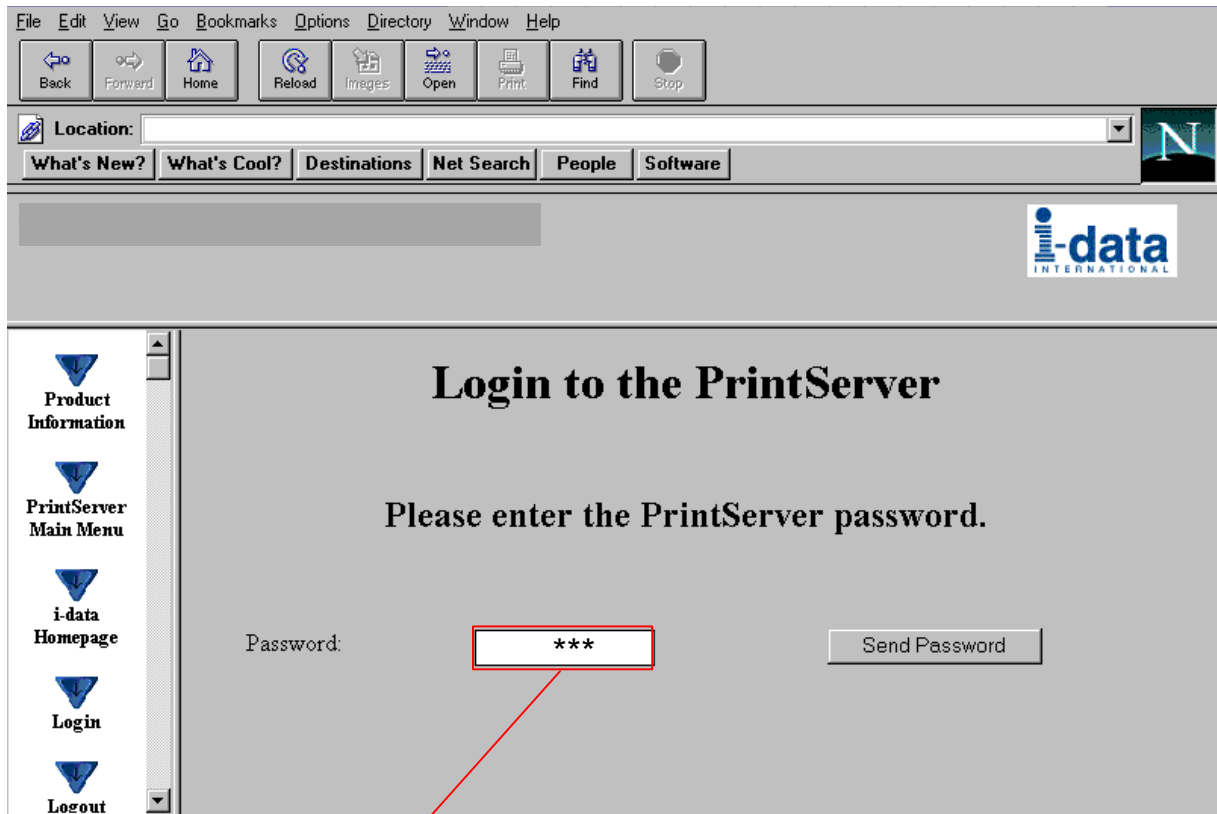

3.4.2.2 Password

You will now be prompted for a password. From the factory, the password is “**adm**”.

Once the <PRINTSERVER> has accepted the default password, you are ready to make the desired configuration / view status on your PrintServer.

NOTE:

- You are recommended to change this password. See the menu “**Change Password**” for details.
- All settings must be confirmed using the menu “**Save Configuration**” to become effective.

3.4.3 Overview

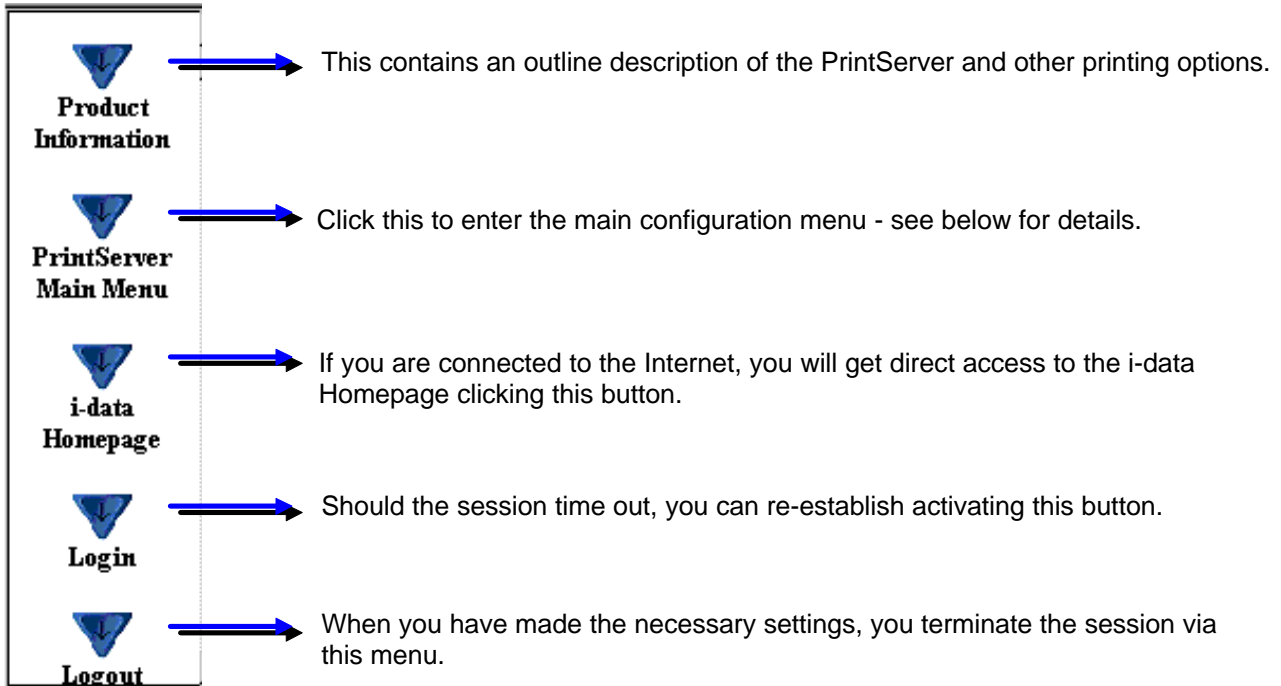

3.4.4 Configuration chart

This is a chart of the configuration and status options supported with the *PrintServer*

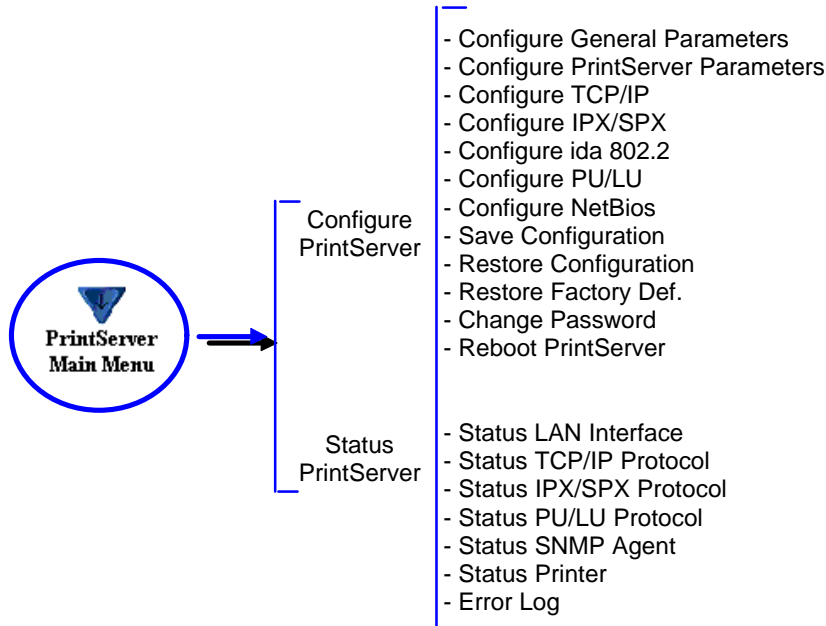

3.4.5 Main Menu

When you click the Main Menu, you will be presented with the two main tasks in the PrintServer HTML configuration program:

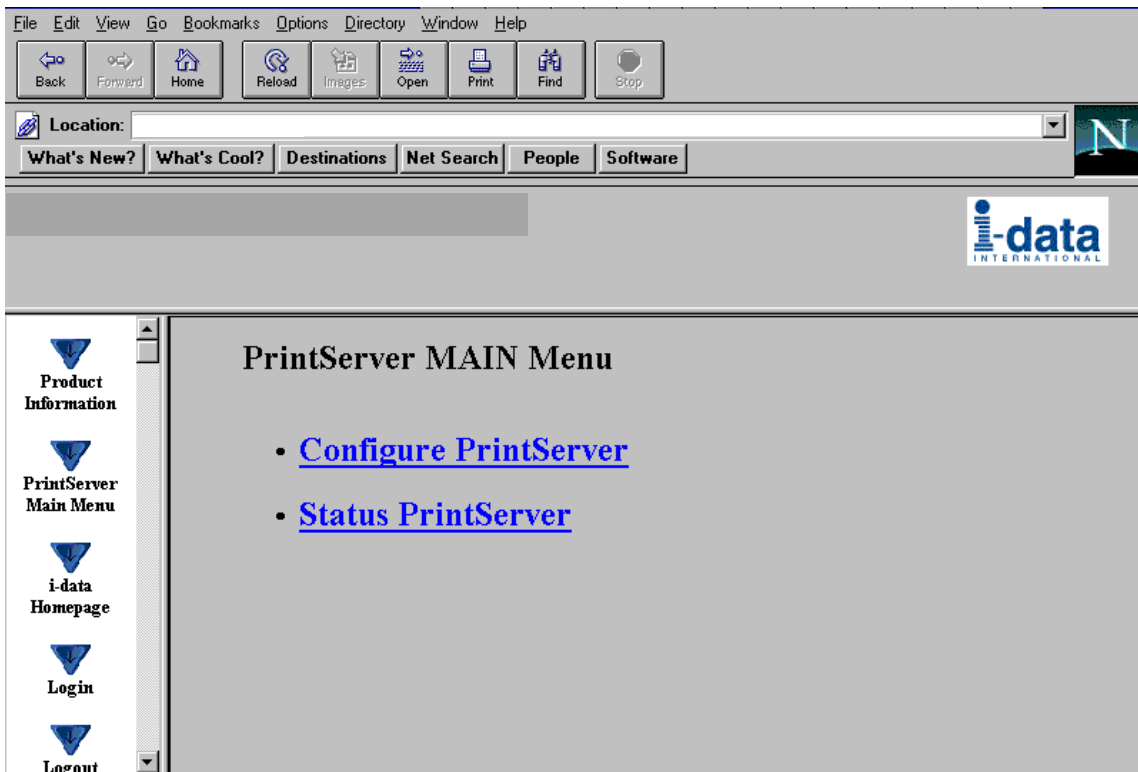

3.4.6 Configure PrintServer

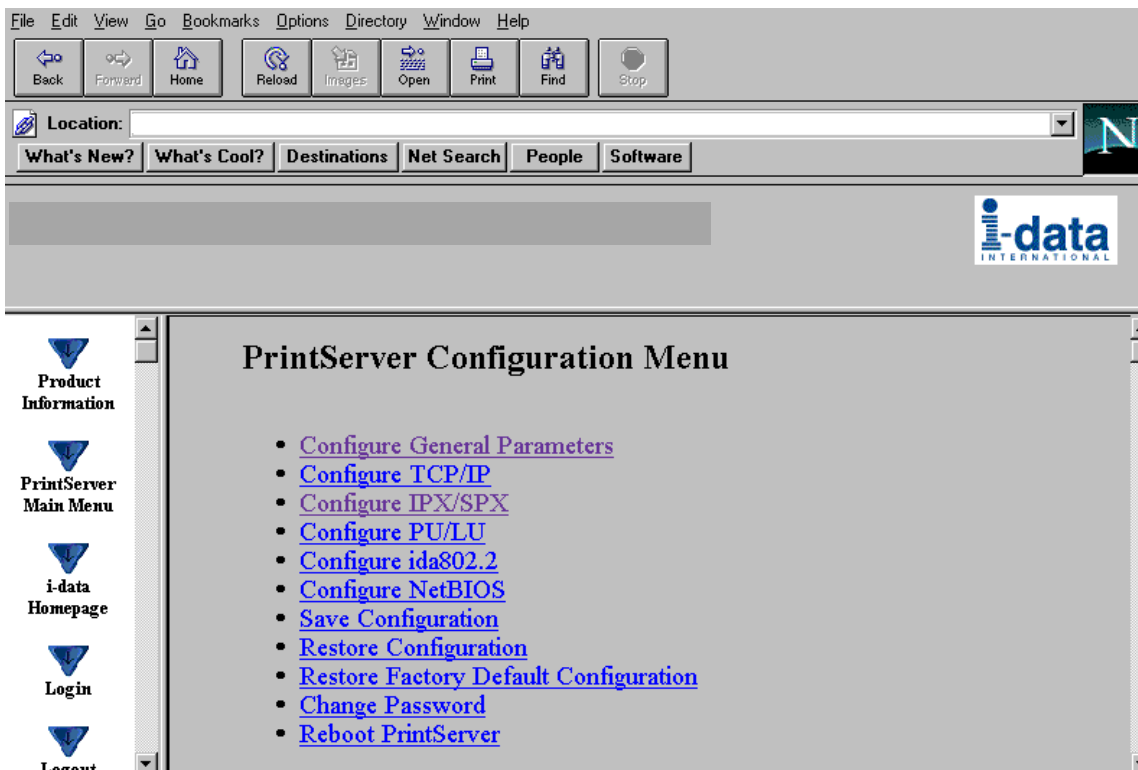

When you have made all the necessary configurations via this entry menu, click the menu at the very bottom to the right - [Previous Menu](#) (not visible on this screen).

Remember to save via “Save Configuration” for the changes to become effective

3.4.7 PrintServer Status Menu

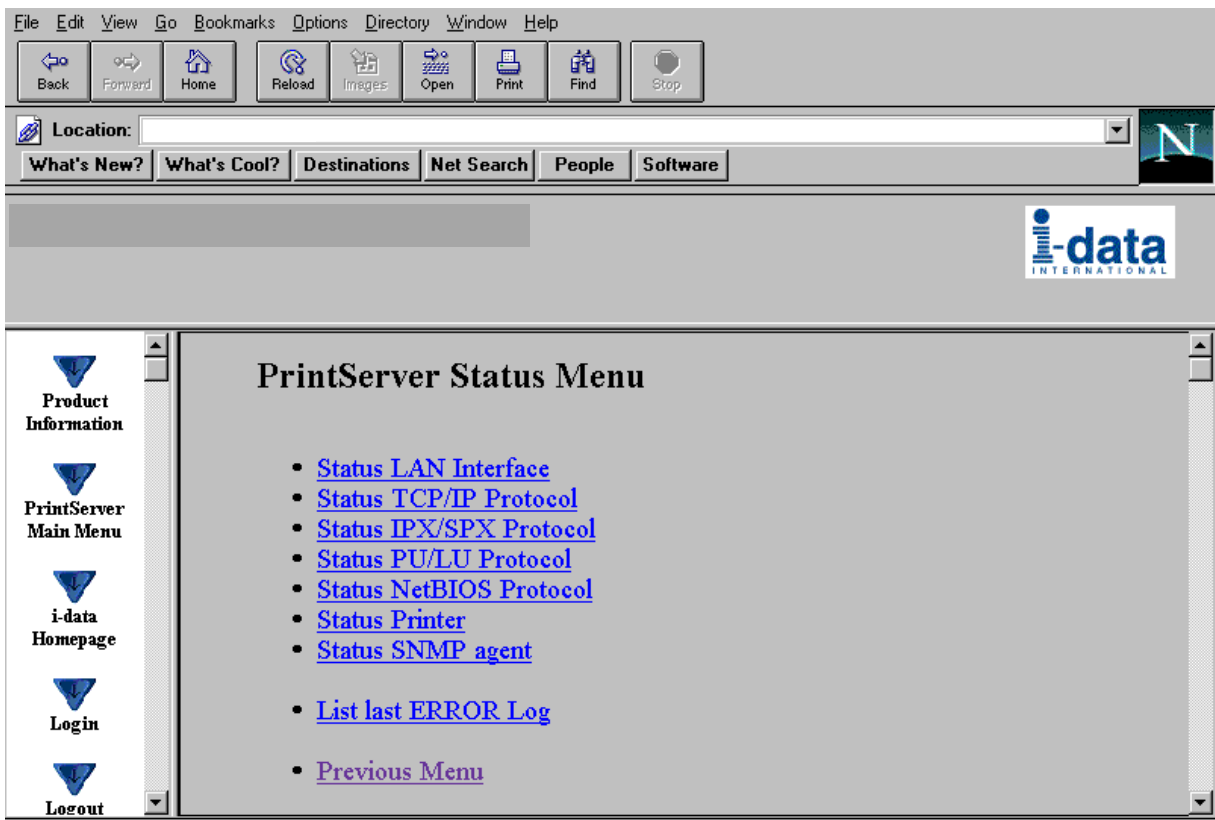

The status menus provide you with various product information depending on which panel you select.

You can update the information by clicking the menu “ **Refresh**”.

NOTE: Some browsers (no-Frame) do not support the Refresh function.

3.5 Configuration using Telnet

The Telnet support (Terminal Emulation Protocol) offers yet another way of configuring and monitoring the *PrintServer*. For this you will need the emulations VT 100 and NVT. Telnet is a standard TCP/IP application permitting access from TCP/IP attached host systems.

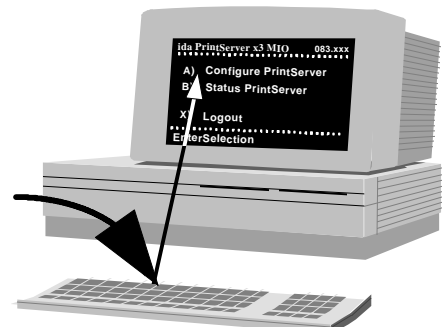

NOTE:

As Telnet requires NVT and VT100 terminal emulations, Telnet configuration support is not valid when running VM and MVS.

Due to restrictions in the AS/400 Telnet implementation, the following information should be considered:

"If you do not want the characters that are being typed to be displayed, the function key associated with the "Hide" function should be pressed (F6 on the default keyboard map). This function should be used when typing a password.

If you want the characters that have been typed to be sent to the remote system for processing without pressing the Enter key, you should press the function key associated with the "SENDWOCR" function (F11 on the default keyboard map)."

(source: IBM: Network in Red Books, SK 2T-6022).

To establish a Telnet session with a *PrintServer* interface you need to program the *PrintServer* with an IP address. This address may also be configured via one of the many other configuration methods available (as described in this chapter).

EXAMPLE

To start a Telnet session on a Telnet capable host, type the following:

Telnet 192.0.110.1.

where

192.0.110.1. is the IP address of the *PrintServer*.

(For IP address details contact your system administrator)

When a Telnet session has been established, the *PrintServer* will prompt the host for a *userid* and *password*.

The *userid* will be **adm** and the password will initially be defined as **adm**. You are recommended to change this initial password. To change the default password, see section 3.5.5 .

Once the *PrintServer* has accepted the default password, the following screen will appear. For details on the main menu, see section 3.5.1

```
<PrintServer>      Main Menu      0xx.xxx
-----
      A)  Configure PrintServer
      B)  Status PrintServer

      X)  Logout
-----
EnterSelection
```

Navigation keys

When configuring using the Telnet, the following navigation keys will be used:

Selecting menu fields	Key value (e.g. type A)
Toggling between entry options	Space bar
Selecting a given value	ENTER key
Return to previous level/exit	X

Other menu keys will be ignored for navigation purposes.

Validation will be performed in the various Telnet menus to make sure that only valid field updates are performed. An error message will appear if an entry is made incorrectly.

Important:

The new settings will only take effect when you select the menu "Save Configuration" and then "Reboot PrintServer".

3.5.1 Menu Structure

This section provides an *outline* description of how to configure and monitor the *PrintServer* using Telnet.

Main Menu

<PrintServer>	Main Menu	0xx.xxx
	A) Configure PrintServer	<i>section 3.5.2</i>
	B) Status PrintServer	<i>section 3.5.11</i>
	X) Logout	
EnterSelection		

If you wish to configure the *PrintServer*, type **A** at the selection prompt.

3.5.2 Configuring PrintServer

Configure PrintServer - Submenu

<PrintServer>	Configuration Menu	0xx.xxx
	A) Configure General Parameters	<i>section 3.5.3</i>
	B) Configure Sessions	<i>section 3.5.4</i>
	C) Save Configuration	<i>section 3.5.6</i>
	D) Restore Configuration	<i>section 3.5.7</i>
	E) Restore Factory defaults	<i>section 3.5.8.</i>
	F) Change Password	<i>section 3.5.5</i>
	R) Reboot PrintServer	<i>section 3.5.9.</i>
	T) Trace Destination	<i>section 3.5.10.</i>
	X) Return to previous menu	
EnterSelection		

3.5.3 General Parameters Menu

Type **A** to enter the submenu for further configuration of the *PrintServer*.

<PrintServer>	Configure PrintServer	0xx.xxx

A)	Configure PrintServer Parameters	
B)	Configure TCP/IP	NOTE: Remember to <u>enable</u> the protocol first. Press A.
C)	Configure IPX/SPX	
D)	Configure ida 802.2	
E)	Configure PU/LU	
F)	Configure NetBios	
F)	Configure SNMP	
X)	Return to previous menu	

EnterSelection		

PrintServer Configuration

<PrintServer>	Configure PrintServer	0xx.xxx

A)	PS Name	
B)	Location	
C)	ContactPerson	
D)	Local MAC address.....:	E) Early Token Release.....:
F)	MAC address enabled.....:	G) Broadcast Type
H)	TCP/IP enabled.....:	I) IPX/SPX enabled.....:
J)	PU/LU enabled.....:	K) NetBeui enabled.....:
L)	Share Timeout.....:	
M)	IRQ Timeout.....:	
N)	Hold Timeout.....:	
O)	BOOT enabled.....:	
X)	Save and Return	Z) Return without saving

Enter Selection		

Enter Selection

To make an entry for the local MAC address, type A. This will place you in the prompt for the local MAC address. If the entry is incorrect, you will receive an error message.

To return to the “Enter Selection” prompt, press Enter.

For action fields other than text entries (e.g. MAC Address) use the space bar to toggle the entry options.

TCP/IP Configuration

→ Remember to set “TCP/IP enabled” to **YES**.

<PrintServer>	Configure TCP/IP	0xx.xxx
A)	HostName.....	← You may use this entry field to write specific information on e.g. target printer: <i>NET1stFloor</i> or <i>John Doe's Ipt.</i> A maximum of 15 characters is recommended for host name
B)	Use BOOTP Server.....:	
C)	TCP MSS.....:	
D)	TCP Window.....:	
E)	Default IP address.....:	
F)	Default SubNet Mask.....:	
G)	Default Gateway Address...:	
H)	Microcode Filename.....:	
X)	Save and Return	Z) Return without saving

EnterSelection		

IPX/SPX Configuration

→ Remember to set "IPX/SPX enabled" to **YES**.

Use the space bar to toggle through the options

```
<PrintServer>      Configure IPX/SPX      0xx.xxx
-----
Frames:1)802.2:YES 2) SNAP: YES

      A)   NCP mode.....:
      B)   NCP preferred Server.....:
      C)   NCP preferred DStree.....:
      D)   NCP DSname context.....:

      E)   EPS mode.....:
      F)   EPS PrintServer.....:
      G)   EPS FileServer.....:
      H)   EPS Bindery Poll Tim.....:
      I)   EPS Password.....:

      X) Save and Return      Z) Return without saving
-----
EnterSelection
```

NOTES:

Bindery Poll Time

If version 4.x (DS) is selected as NCP mode, the entry "Bindery Poll Time" will NOT appear in the *test printout*. It will, however, be maintained as an entry in Telnet, regardless of NCP mode.

EPS Password

This password must be a match of the NetWare PServer password.

When printing you should check the connection to the PServer viewing the NetWare menu "Active Connections".

ida 802.2 Configuration

```
<PrintServer>      Configure ida 802.2      0xx.xxx
-----

      A)   Alias Name.....:

      X) Save and Return      Z) Return without saving
-----
Enter Selection:
```

PU/LU Configuration

→ Remember to set "PU/LU enabled" to **YES**.

<PrintServer>	Configure PU/LU	0xx.xxx

A)	Blocknumber.....: 05D	
B)	ID number.....: 00000	
C)	Remote MACaddress...: 	Upstream PU MAC address
D)	Local SAP.....:	
E)	Remote SAP.....: 04	
X) Save and Return		Z) Return without saving

Enter Selection:		

NetBios Configuration

→ Remember to set "NetBeui enabled" to **YES**.

<PrintServer>	Configure NetBios	0xx.xxx

A)	Servername.....:	
B)	Work Group.....: WORKGROUP	
X) Save and Return		Z) Return without saving

Enter Selection:		

SNMP Configuration

```
<PrintServer>      Configure SNMP agent      0xx.xxx
-----
SNMP Trap Destinations  Authentication Traps:

No. Index Community Name  IP Address
-
-
-

SNMP Manager Access Authorization

No. Index Community Name  Access Network Address Mask
-
-
-

-----
A) Add D) Delete C) Change AuthTrap X) Return Enter Action
```

For adding an SNMP Trap parameter or configuring the access parameters press **A** for ADD.

You can now select between T)rap or A)uthorize parameters.

Selecting Trap will present the following screen:

```
<PrintServer>      Configure SNMPTrap Parameters  0xx.xxx
-----
A) Destination IP Address .....:
B) Destination Community Name.....:

X) Save and Return

-----
Enter Selection
```

Selecting Authorize will present the following screen:

```
<PrintServer>  Configure SNMPAccess Parameters 0xx.xxx
-----
A) Community Name.....:
B) Manager IP Address.....:
C) IP Address Mask.....:
D) Manager Access Type.....:

X) Save and Return
-----
Enter Selection
```

3.5.4 Configure Sessions

In the sub-menu for the “Configure PrintServer”, select “Configure Sessions” typing **B** at the selection prompts. You will see the following screen:

“+” Means that Trace has been activated

<PrintServer>	Configure sessions	0xx.xxx
No.	Enabled	Session Description
1	YES*	+PPD 5001 -> IPDS DATA --> PRINTER
2	YES*	+PPD 5002 --> IPDS DATA --> PRINTER
3	YES*	+LPD q: LPDPRT1 --> PRINTER
4	YES*	+LPD q: LPDPRT1ACR --> PRINTER
5	YES*	+ENP PNO:0 -->PRINTER
6	YES*	+SNA Print --> SCS data --> PRINTER
7	---	-----
8	---	-----
9	---	-----
10	---	-----
11	---	-----
12	---	-----
13	---	-----
14	---	-----
T) Trace U) Untrace S) Status D) Delete E) Edit X) Return Enter action:		

Means session is active

↓

To edit a specific sub-menu, type E (Edit) and the required parameter to modify and then press <ENTER>.

3.5.5 Change Password

In the sub-menu for the “Configure PrintServer” select “Change Password” by typing **F** at the selection prompts.

You are now prompted for the old password.

<PrintServer>	Change Password	0xx.xxx
Old Password:	*****	

When entered, you will be prompted for a new password. Finally, the new password must be re-entered to be confirmed by the system.

NOTE:

Only the password for the current session can be changed. If an invalid password is entered, the previous menu level is displayed.

3.5.6 Save Configuration

NOTE: When you have made new settings or changed existing, you must save the settings with this menu. Then reboot the printserver (see section "Reboot PrintServer below). If you fail to do this the new/modified settings will be lost when the printer is turned off.

In the sub-menu for the "Configure PrintServer" select "Save Configuration" by typing **C** at the selection prompts. You will see the following screen:

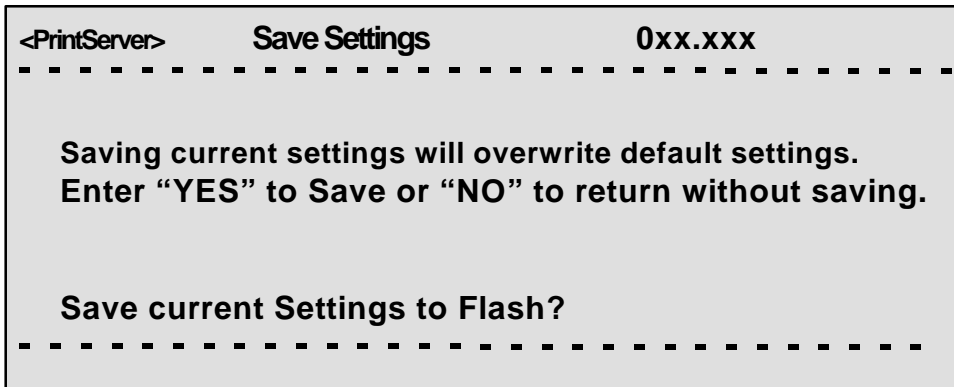

3.5.7 Restore Configuration

In the sub-menu for the "Configure PrintServer" select "Restore Configuration" by typing **D** at the selection prompts. Follow the instructions on the screen.

3.5.8 Restore Factory Default

In the sub-menu for the "Configure PrintServer" select "Restore Factory Default" by typing **E** at the selection prompts. Follow the instructions on the screen.

3.5.9 Reboot PrintServer

In the sub-menu for the “Configure PrintServer” select “Reboot PrintServer” by typing **R** at the selection prompts. Follow the instructions on the screen.

3.5.10 Trace destination

Type **T** at the selection prompt to enable the trace facility.

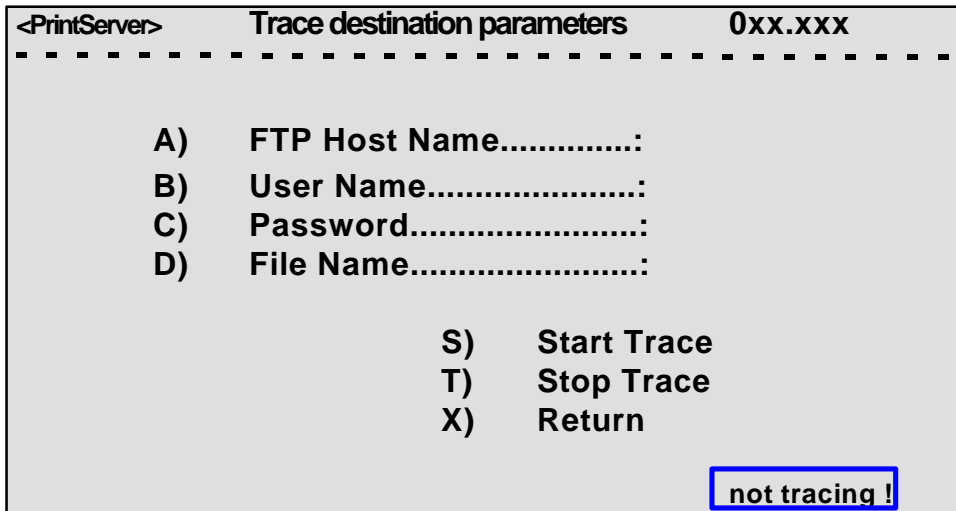

↓
indicates the trace status

Type e.g. **A** (FTP Host Name) to be prompted for making entries to the trace destination parameters.

Press Enter when you have made your entries.

NOTE:
By default all sessions have trace enabled

3.5.11 Status PrintServer

From the *main menu* select the menu “Status PrintServer” by typing **B** at the selection prompt. This will lead to the following screen.

<PrintServer>	Status Menu	0xx.xxx
A)	Status LAN interface	
B)	Status TCP/IP	
C)	Status IPX/SPX	
D)	Status PU/LU	
E)	Status NetBios	
F)	Status Printer	
G)	Status SNMP Agent	
L)	List Last Error Log	
X)	Return to previous menu	
Enter Selection:		

Enter a selection to view the current status.

3.6 Configuration using Setup File

Only modify or change the settings via the configuration file if strictly necessary. Otherwise, you are recommended to use one of the other configuration tools (see above)

The sample configuration files supplied with the *PrintServer* may be used to configure or re-configure the product. The files may be sent directly via the LAN. The protocols used may be programmed in the *PrintServer*.

Setup File Identifier

The configuration file must be started with the following string:

&&??##N1,0#

and be terminated with this string.

&&??<space>

These strings are used for identifying the setup file when being downloaded. ***They must not in any way be altered.***

You are recommended to stop all printer sessions before the downloading of (new) configuration settings as active print sessions may be interrupted.

Default settings for the *PrintServer* are supplied with each unit.

3.6.1 Sample minimum configuration file

```
-----
&&??##N1,0# : Start of file - Don't remove this!
Short configuration for a PrintServer
(This is an example. Please modify the parameters to match your configuration).
00XXX00X
-----
*****
                                IDAPS
*****
BEGIN_CONFIGURATION      IDAPS
ENABLE_TCPIP             YES           ; ENABLE TCP/IP protocol
ENABLE_802_2             YES           ; ENABLE 802.2 protocol
ENABLE_NETWARE           NO            ; ENABLE Netware protocol
ENABLE_PU_LU             NO            ; DISABLE PU/LU protocol
ENABLE_NETBEUI           YES           ; ENABLE NetBEUI protocol
BOOT                     YES           ; Reboot PS if conf.has changed
*****

                                TCP/IP
*****
BEGIN_CONFIGURATION TCP/IP
BOOT                     YES           ; BOOT from BOOTP server
DEFAULT_IP               192.0.0.1    ; IP addr. if not booted by BOOTP
DEFAULT_SM               255.255.255.0; Subnet Mask if not booted by BOOTP
DEFAULT_GW               192.0.0.0    ; Gateway addr. if not booted by BOOTP
END
;*****

                                P U
;*****
BEGIN_CONFIGURATION PU
; BLOCKNUMBER            05D           ; Fill in your Block number
; IDNUMBER                00000        ; Fill in your ID number
; REMOTE_MAC              400000000000 ; Fill in HOST / GW MAC address.
END
;*****

                                NETWARE
;*****
BEGIN_CONFIGURATION NETWARE
LSL_FRAME_802_2          YES           ; Use 802.2 protocol
LSL_FRAME_802_SNAP       NO            ; Disable SNAP protocol
NCP_MODE                 DS            ; BINDERY or DS, match server
NCP_PREFERRED_SERVER     XXXXXXXXXX    ; Name of fileserver
NCP_PREFERRED_DSTREE     XXXXXXXXXX    ; NetWare 4.x only
NCP_DSNAME_CONTEXT       XXXXXXXXXX    ; NetWare 4.x only
*****

                                802.2
*****
BEGIN_CONFIGURATION 802_2
ALIASNAME                 XXXXXXXXXX   ; Shown in the idaPMUTL window
*****

                                IDA802_2 ID 1
*****
BEGIN_CONFIGURATION 802_2 1
INSTREAM_802_2           NATIVE        ; Transparent print
*****

                                ENP ID 1
*****
BEGIN_CONFIGURATION ENP 1
PRINTERNUMBER            XXXXXXXXXX    ; Capture printer 0 on Novell server
FILESERVER                XXXXXXXXXX    ; Name of fileserver
PRINTSERVER              XXXXXXXXXX    ; Name of printserver
MODE                      XXXXXXXXXX    ; BINDERY or DS, match server
*****
```

../continued

```
*****
                                ENP ID 2
*****
BEGIN_CONFIGURATION ENP 2
PRINTERNUMBER      XXXXXXXXXX   ; Capture printer 1 on Novell server
FILESERVER         XXXXXXXXXX   ; Name of fileserver
PRINTSERVER        XXXXXXXXXX   ; Name of printserver
MODE               XXXXXXXXXX   ; BINDERY or DS, match server

*****
                                NETBIOS
*****
BEGIN_CONFIGURATION NETBIOS
SERVE_NAME         XXXXXXXXXX   ; NetBIOS server name
WORKGROUP          WORKGROUP    ; Workgroup for the PrintServer
END

&&??
```

3.6.2 Advanced configuration

In this section you will find examples of how to configure the various setup file parameters. The purpose of these examples is to provide you with simple guidelines for configuration using the setup file.

The chart below provides an overview of the various configuration options.

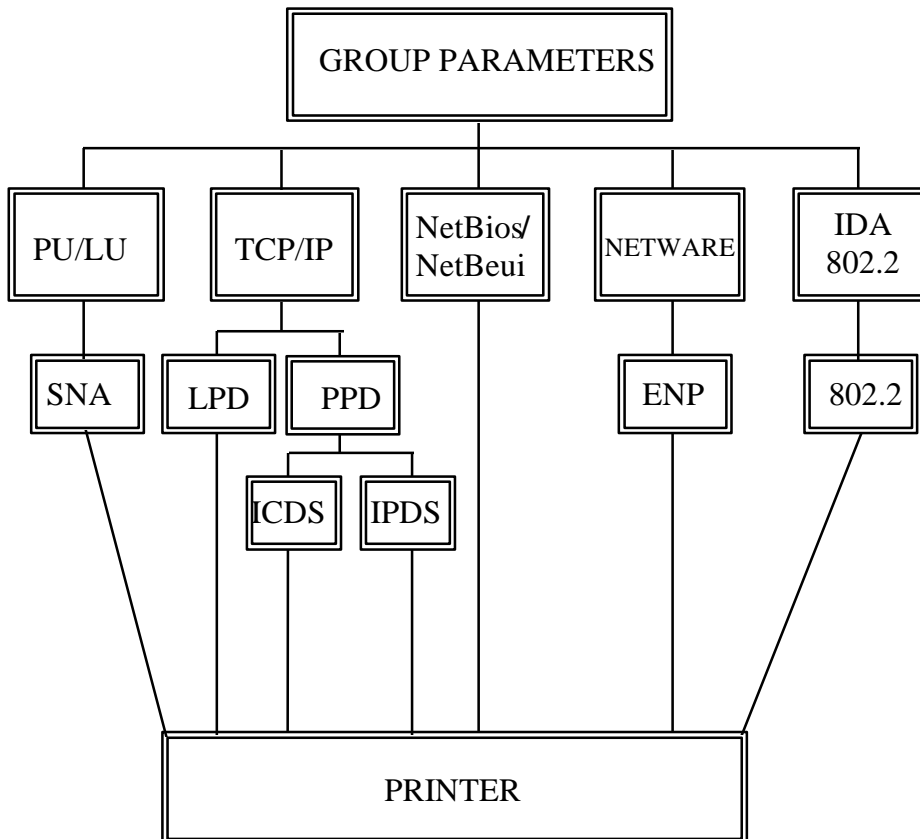

Enabling IDAPS

Here the following group parameters are enabled / disabled.

If a group parameter is following the setup definitions for the various sessions, e.g. IPDS input for a session, these must be configured. See the following sections.

```
BEGIN_CONFIGURATION IDAPS
LOCAL_MAC           4XXXXXXXXXXXXX
SEL_MAC             UNIVERSAL
EARLY_TOKEN        NO
ENABLE_TCPIP       YES
ENABLE_NETWARE     NO
ENABLE_802_2       YES
ENABLE_NETBIOS     YES
ENABLE_PU_LU       NO
BOOT               YES
SHARETIMEOUT       20
HOLDTIMEOUT        600
IRQTIMEOUT         60
END
```

Defining PU_LU

NOTE: The PU_LU session requires the installation of an FSL or IPDS add-on module.

To enable a PU_LU session (SNA), the following keywords are used. The keywords must match the values configured in the chapter "SCS Printing Using SNA".

```
BEGIN_CONFIGURATION PU
BLOCKNUMBER        05D
IDNUMBER           0    (set exchange ID number)
REMOTE_MAC         000  (set the MAC address of the upstream device)
LOCAL_SAP          4
REMOTE_SAP         4
END
```

Define SNA

To define a SNA session, see the following configuration example:

```
BEGIN_CONFIGURATION SNA_PRINT    3
  INSTREAM_SNA_PRINT            SCS
END
```

Define TCP/IP

To select and define TCP/IP session see the following sample configuration. The details on configuration parameters are available in Appendix A.

NOTE:

The values to be configured must match your environment.

```
BEGIN_CONFIGURATION TCPIP
BOOTP                YES
TCP_MSS              1400
TCP_WINDOW           4200
DEFAULT_IP           ??????
DEFAULT_SM           ??????
DEFAULT_GW           ???????
END
```

Printing LPD

To select and define an LPD session see the following sample configuration. The details on configuration parameters are available in Appendix A.

```
BEGIN_CONFIGURATION LPD x
LPD_QUEUE            "LPDPRT1"
LPD_AUTOOCR          NO
END
```

Define PPD

To select and define a PPD session see the following sample configuration. The details on configuration parameters are available in Appendix A.

NOTE:

The port values to be configured must match the values defined on the relevant host.

```
BEGIN_CONFIGURATION PPD X
PPD_PORT
RESPONSE
KEEPALIVE
END
```

PPD port selection for IPDS print: **5001** and **5002**.

PPD port selection for ICDS print: **5005** and **5006**.

Printing IPDS

To select and define an IPDS session see the following sample configuration. The details on configuration parameters are available in Appendix A.

```
BEGIN_CONFIGURATION SESSION
  SESSION 1
    PRESENT                YES
    INPUT_DEF
      INPUT_SEL            PPD
      ID                    1
    END_SET
    TRANSFORM_DEF 1
      TRANSFORM_SEL        IPDS
      ID                    1
    END_SET
    OUTPUT_DEF
      OUTPUT_SEL           PRINTER
      ID                    1
    END_SET
  END_SET
.
.
.
.
.
.
.
.
BEGIN_CONFIGURATION IPDS x
  IPDS_VP                  x
END
```

NOTE: The number of sessions defined and the number of **virtual printers** used will depend on the number of concurrent IPDS sessions required.

PPD port selection for IPDS print is port no. 5001 and 5002.

See the “Define PPD” section.

Printing ICDS

To select and define an ICDS session see the following sample configuration. The details on configuration parameters are available in Appendix A.

```
BEGIN_CONFIGURATION ICDS X
LANGUAGE
AUTOCONFIG
NOGRAPHICS
QUERYPAGE
HOLDTIMEOUT
IRQTIMEOUT
DLDTIMEOUT

AFPTRAY_DEF X
    TRAY_SELECT
    MANUAL
    ENVELOPE
END_SET
END
```

NOTE: PPD port selection for ICDS print is port no. 5005 and 5006.

See the “Define PPD”.

Define NetWare

To select and define a NetWare session see the following sample configuration. The details on configuration parameters are available in Appendix A.

```
BEGIN_CONFIGURATION_NETWARE
  LSL_FRAME_802_2          YES
  LSL_FRAME_802_SNAP      NO
  NCP_MODE                 DS
  NCP_PREFERRED_SERVER
  NCP_PREFERRED_DSTREE    I-DATA
  NCP_DSNAME_CONTEXT      O=IDA
  EPS_MODE                 DS
  EPS_PRINTSERVER         _PS.IDA
  EPS_PASSWORD
  EPS_FILESERVER           IDA1_FS
  EPS_MSG_FILENAME
  EPS_BINDERY_POLL_TIMEOUT 15
END
```

a typeful distinguished context name of the EPS.

a typeless distinguished login name of the EPS.

Define ENP session

To select and define an ENP session see the following sample configuration. The details on configuration parameters are available in Appendix A.

```
BEGIN_CONFIGURATION ENP x
  PRINTERNUMBER
  FILESERVER
  PRINTSERVER
  MODE
  SHARETIMEOUT
END
```

Define ida 802.2

To select and define an ida 802.2 protocol for a session, see the following sample configuration. The details on configuration parameters are available in Appendix A.

```
BEGIN_CONFIGURATION 802_2
  ALIASNAME
END
```

Define ida 802.2

Subsequently you should check the configuration of the ida 802.2. See the sample below.

```
BEGIN_CONFIGURATION ida802_2 1
  INSTREAM_802_2          NATIVE
END

BEGIN_CONFIGURATION ida802_2 2
  INSTREAM_802_2          IPDS
END
```

Define NetBEUI/NetBios

Check the configuration of the NetBEUI/NetBios. As default this protocol is enabled. See the sample below.

```
BEGIN_CONFIGURATION NETBIOS
  SERVER_NAME              <NetBIOS server name>
  WORKGROUP                WORKGROUP
END
```

Define Printer session

To select and define a Printer session see the following sample configuration. The details on configuration parameters are available in Appendix A.

```
BEGIN_CONFIGURATION PRINTER X
  DESCRIPTION
  DUPLEXINSTALLED
  OFFSETINSTALLED

  PRINTPORT_SER

  TRAY_DEF X
    DESCRIPTION
    PAPER_SEL
  END_SET
  .
  .
  .
  .
  .

  LANGUAGE_DEF_PCL5
    OFFSETREG
    GMACROS
    RASTEROP
    PATTERNS
    CTABLES
  .
  .
  .
  .

END
```

3.7 Setting Up via BOOTP server

The TCP/IP BOOTP daemon on the server supports one or more remote devices. When the *PrintServer* is powered on, it broadcasts an initialisation request to all LAN systems. The BOOTP server receives the hardware address and looks for a match of the hardware address in the BOOTPTAB file. The BOOTP server has a BOOTPTAB file which is a correspondence file for hardware addresses and IP addresses. When the matching hardware address is located, the BOOTP server sends back (using UDP protocol) an IP address, a subnet mask and other information to the *PrintServer* in order to activate the unit. The data flow is as follows:

1. Upon startup, the remote device broadcasts its MAC address. (The universal MAC address is stated on the rear panel of the remote device). Upon receipt of this broadcast, the BOOTP server makes a reply.
2. The BOOTP daemon searches for a corresponding MAC address in the BOOTPTAB configuration file. If a match is found, the BOOTP daemon returns an IP address and other pieces of information defining the unit in the network.

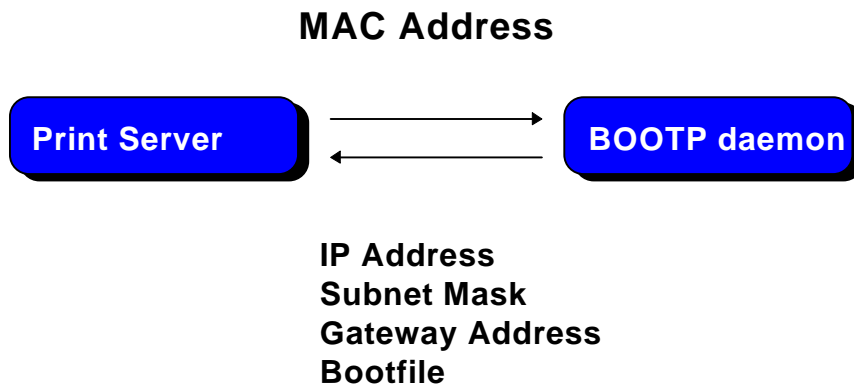

Defining the unit in the network

BOOTPTAB Device Entry

Each device has its own special entry. In this entry the name of the device, MAC address etc. are given. References may also be given to a bootfile (bf).

NOTE: Do not confuse BOOTPTAB file with bootfile (bf).

Bootfile Entry

The bootfile entry refers to a file which contains the additional configuration settings for the particular device. In the bootfile, a reference may also be given to a microcode file.

Microcode File

This file contains the microcode file that can be downloaded to the print server. For further details please see *Appendix B: Microcode Upgrading*.

Setting up BOOTPTAB Device Entry

A device entry is made up with the following notations:

Notations used in BOOTPTAB file:

bf	=	bootfile
ds	=	domain name server address list
gw	=	gateway address list
ha	=	host hardware address (must follow ht and be in hex)
hd	=	home directory
hn	=	send host name (boolean tag)
ht	=	host hardware type (must precede ha)
ip	=	host IP address
sm	=	subnet mask
tc	=	template host (points to similar host entry)

Typical BOOTPTAB file entry:

```
ps13: ht=6: ha=00036e00172a: ip=192.0.110.1:\  
sm=255.255.255.0: gw=192.0.110.0: bf=/tcp/etc/myfile.cf2
```

Fig. 3-2 BOOTPTAB file sample (OS/2 environment)

where

ht = 6 (Token Ring hardware type)
ha= 00036E00172A (MAC address)
ip = 192.0.110.1 (IP address)
sm = 255.255.255.0 (subnet mask)
gw = 192.0.110.0 (gateway)
bf = /TCP/etc/myprint.cf2 (path to boot file; i.e. name of the bootfile that is used for print server setting)

For a full list of notations used in the BOOTPTAB file please see above.

NOTES:

1. The bootfile and microcode must be in the same disk partition as BOOTPTAB.
2. A **forward slash** indicates directory path in bootfile specification
3. A **back slash** means line continuation

For details on modifying the configuration file, see section 3.6.

3.7.1 BOOTP process

So far, this chapter has only been dealing with the setting up of the *PrintServer* from a BOOTP server. However, the *PrintServer* can also be equipped with a so-called “ default configuration”. This default configuration will be carried out if the *PrintServer* cannot detect a BOOTP server at the time the *PrintServer* is powered on. The default settings are similar to the ones defined on the BOOTP server. For an illustration of this boot event, please see the flow chart below.

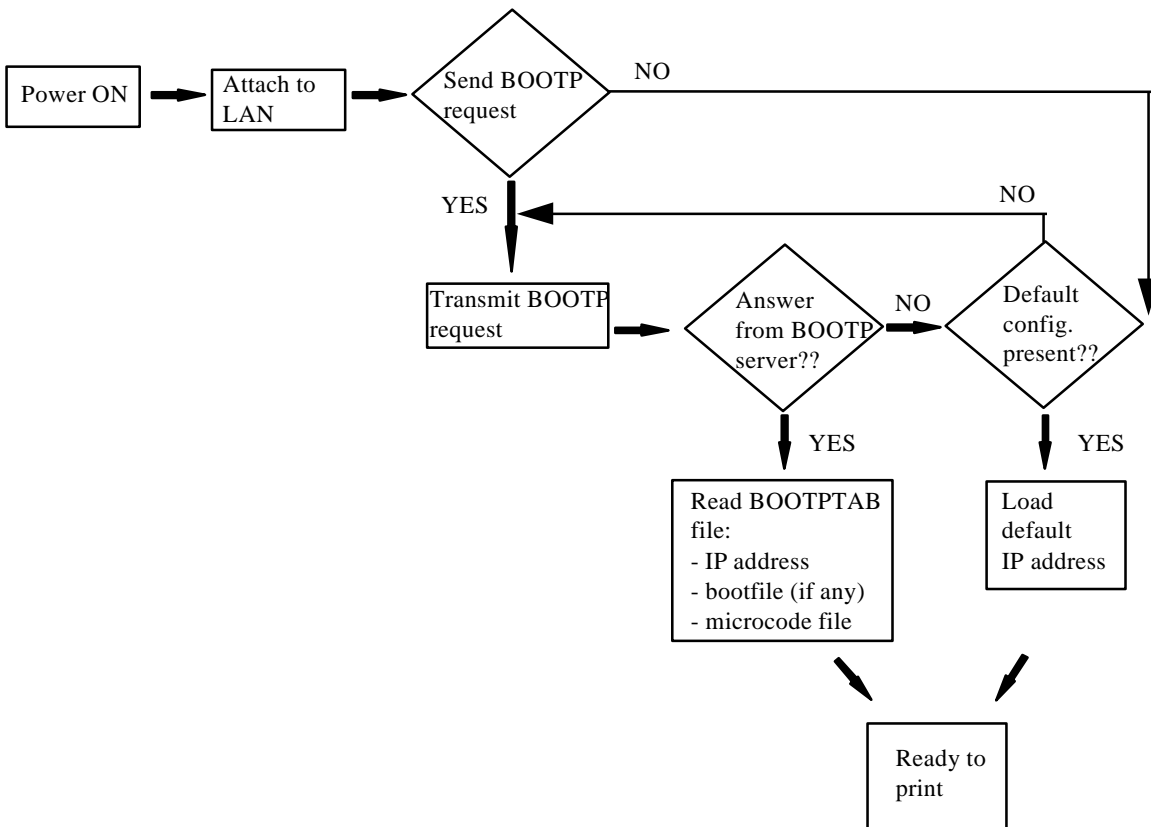

Default Configuration

3.7.2 Setting up the TFTP Daemon

For the BOOTP server to download the settings to the print server, TFTP must be enabled.

TFTP in AIX Environment

The TFTP daemon is normally managed by the INETD super-daemon. The INETD starts a TFTP daemon when a request is received. The TFTP daemon satisfies the request and then dies. You need to configure INETD so that it performs this service. This can be done in the following way using the SMIT command (**S**ystem **M**anagement **I**nterface **T**ool):

NOTE: It can only be done with superuser authority (i.e. use the su command to switch to root user).

1. Type SMIT.
2. Select the following items in order to configure the TFTP daemon.
 - Communications Applications and Services
 - TCP/IP
 - Further Configuration
 - Server Network Services
 - Other Available Services
 - Super Daemon (INETD)
 - INETD Subservers
 - Add an INETD Subserver
3. When the menu "Available Subservers" appears, use the "LIST" function .

NOTE: The TFTP daemon will only be on the list if not already created.

You can also check `/etc/inetd.conf` to see whether the tftpd line is commented out. But you should use SMIT to update `inetd.conf` for TFTP daemon. Do not update `/etc/inetd.conf` manually for TFTP daemon as you would for the BOOTPD.

SMIT does not allow you to place the BOOTPD under INETD. The `/etc/inetd.conf` file must be updated manually for the BOOTPD.

You should ensure that there is no `/etc/tftpaccess.cfg` file. It can be used to control access to files by remote TFTP users.

TFTP in OS/2 Environment

1. Start TCP/IP Configuration located in the T CP/IP folder.
2. Select the Autostart tab.
3. Tick the box labelled "Enable this machine to start the INETD super server".
4. Tick the box labelled "Enable others to access your files by using TFTP". Also tick the "INETD" push-button.
5. Shutdown your "TCP/IP Configuration" and check that the new settings have been saved.
6. Restart the INETD.

3.7.3 Starting the BOOTP Server

This section provides you with instructions for starting the BOOTP server.

After making the necessary amendments to the BOOTPTAB file, you are now ready to start the BOOTP server and then verify the configuration by performing a test printout.

1. Start the BOOTP server

Use the BOOTP server debug option (-d) to verify the correct operation.

E.g. **bootpd -b -d -d -d -d -d**

If the *PrintServer* and the BOOTP server are not on the same LAN segment, the BOOTP server must be started with the -b option. This enables the BOOTP reply to cross bridges.

2. Power the *PrintServer* off and back on.
3. After a while, check that the Power LAN LED stays lit.
4. Proceed to section: "Testing *PrintServer*".

3.8 Testing PrintServer

1. Perform a test printout by pressing the TEST key on the rear panel.
2. Verify that the settings match the definitions in the BOOTPTAB file and the bootfile. Appendix F contains settings printout.
3. "PING" the unit from the workstation to verify physical LAN and IP network connectivity.
 - a. Invoke the PING command and the IP address or host name of the unit. For example:

```
PING 192.0.110.1
```

- b. If the PING is OK, you receive a system response like this:

```
PING 192.0.110.1: 56 data bytes
64 bytes from 192.0.110.1: icmp_seq=0.  time=0.
ms
64 bytes from 192.0.110.1: icmp_seq=1.  time=0.
ms
64 bytes from 192.0.110.1: icmp_seq=2.  time=0.
ms
64 bytes from 192.0.110.1: icmp_seq=3.  time=0.
ms
64 bytes from 192.0.110.1: icmp_seq=4.  time=0.
ms
```

```
....
....
```

3. Press CTRL-BREAK to end the PING process. You will then get the following output statistics:

```
----192.0.110.1 PING Statistics ----
5 packets transmitted, 5 packets received, 0%
packet loss round-trip (ms)  min/avg/max 0/0/0
```

NOTE:

If the PING does not reoccur, only reoccurs once, or if problems arise with another LAN device, please check the chapter on "Problem Determination"

3.9 About the PING function

The ICMP PING function sends an echo request to the *PrintServer* stated in the IP address. The PING function is useful for:

- Determining the status of the network and various foreign hosts
- Tracking and isolating hardware and software problems.
- Testing, measuring and managing networks.

4. Novell Setup for IPX/SPX

This chapter provides instructions as to the configuration of Novell NetWare to connect the *PrintServer* using the IPX/SPX protocol.

The *PrintServer* is able to run with NetWare v.3.1x in BINDERY emulation as well as v.4.xx (the latter being backwards compatible) in Directory Services (DS) or BINDERY emulation.

The *PrintServer* supports printing through an embedded PSERVER (EPS) fully emulating a standard NetWare PSERVER.NLM. Printing through the embedded NPRINT (ENP) can also be performed. Up to two ENPs is supported. The Novell NetWare protocols supported are: SPX, SAP, NCP and IPX.

The NetWare set-up consists of the following basic steps:

- Check the pre-requisites (described in the section “Before you begin” in the following).
- Check that the connection with the NetWare server has been established by printing a file e.g. from a NetWare connected client.

The following sections will guide you through the configuration of the Novell NetWare for IPX/SPX printing on the *PrintServer* using standard NetWare tools.

4.1 Before you begin.....

Before you proceed to the following sections, please make sure that the following settings on the *PrintServer* have been made:

- **Enable NetWare**
- **Enable IPX/SPX**
- **Set Frametype**

These settings can be set by using one of the following configuration tools:

TELNET	(see chapter 3)
PSInst32	(see chapter 3)
Web browser	(see chapter 3)
Configuration file	(see chapter 3 and Appendix A)

The following sections provide instructions for setup of the IPX/SPX protocol for the embedded PSERVER and the embedded NPRINTERS via the standard NetWare tools PCONSOLE or NetWare Administrator.

4.2 Using the embedded PSERVER

To set up the embedded PSERVER, select either TELNET or the configuration file as a configuration tool.

- ☞ The physical location of the embedded PSERVER (EPS) is the *Xerox 4500 PS TR*.

4.2.1 Embedded PSERVER setup

To use the embedded PSERVER in the *Xerox 4500 PS TR* it must be defined in the Novell NetWare system and the definitions here must match the settings made for the PSERVER in the configuration file or set via the TELNET.

Configuring the EPS via TELNET, see chapter 3.
Configuring via PSInst32, see chapter 3.
Configuring via Web browser, see chapter 3.
Configuring the EPS via configuration file, see chapter 3.

The following keywords are EPS specific and must be specified either via TELNET, PSInst32 or via the configuration file.

- EPS mode: The PSERVER is able to run in both Bindery (3.1x) and Directory Service (4.xx) modes.
- EPS printserver: The print server name (i.e. logon name).
(NOTE: In DS mode, it must be a typeless distinguished name, e.g. `_PS.international.i-data #####`), except if “Country” is top level of the NDS tree (typefull), it will be e.g. `CN=_PS.OU=international.O=i-data.C=DK`
- EPS password: The password to use when logging in to the operating environment (Bindery and DS).
- EPS fileserver: The fileserver to where the EPS is to log into.
NOTE: On the Novell Server you must set “Reply to get nearest server” to **ON**.

NOTE: The EPS residing in the *Xerox 4500 PS TR* is able to support up to 16 ENPs.

4.3 Using the embedded NPRINTER

To setup up the embedded NPRINTER, select either TELNET or the configuration file as a configuration tool.

- ☞ The physical location of the embedded NPRINTER is in the *Xerox 4500 PS TR*.

4.3.1 Embedded NPRINTER setup

With the implementation of ENP (NPRINTER) in the *Xerox 4500 PS TR*, the attached printer can be directly connected to the network. The NPRINTER runs in both Bindery and Directory Services environments.

The embedded NPRINTER receives the print job from the Novell print server (PSERVER) or the embedded PSERVER in the PS and prints it.

The embedded NPRINTER supports native print data only (PCL, PostScript).

The NetWare PCONSOLE or NetWare Administrator are the tools to be used when setting up the embedded NPRINTER.

Configuring the ENP via TELNET, see chapter 3.
Configuring via PSInst32, see chapter 3.
Configuring via Web browser, see chapter 3
Configuring the ENP via configuration file, see chapter 3.

The following keywords are ENP specific and must be specified in either TELNET, PSinst32 or the configuration file.

ENP mode:	Selects which mode to use. Options are Bindery and DS mode.
ENP printer number:	Selects which Novell NetWare printer number to use.
Printserver:	Selects which Novell NetWare printserver to use.
Fileserver:	Selects which Novell NetWare fileserver to attach to.

NOTE: The *Xerox 4500 PS TR* is able to support up to 2 ENPs. Each *Xerox 4500 PS TR* with a defined EPS is able to support up to 16 ENPs.

Printing command example

When the user wishes to send a print job to the attached printer, the following command can be used:

Example: `NPRINT MYPRINT Q=PQ2`

Where PQ2 is the queue supported by the NPRINTER.

This functionality is set via keyword parameters in the configuration file.

4.4 NetWare setup - Bindery mode

This section describes the setting up of the NetWare version 3.1x or later for IPX/SPX printing using *Bindery* mode. If you use NetWare version 4.xx you should consider using DS mode as described in the next section.

NOTE:

You must either load the PSERVER.NLM on the server or define the embedded PRINTSERVER in the *Xerox 4500 PS TR* before connecting the NPRINT.

1. Type "**PCONSOLE**" to start the PCONSOLE program
2. Make sure that you have selected the correct file server. If not, select the correct by selecting the menu "**Change current file server**"
3. Select "**Print Queue Information**" from the main menu to set up a queue to service the *PrintServer*.
4. Press **INS** to create a new queue and type a name for this new queue. The queue name is user-defined and used for printing and monitoring.
5. Select the new queue and press **ENTER**.
6. From the menu "**Print Queue Information**" select "Queue Server" and press **ENTER**.
7. Press **INS** for a list of Print Servers.
The list will show both non-embedded Print Servers and embedded Print Servers.
8. Select the appropriate Print Server from the list "Queue Servers Candidates" and press **ENTER**.
If defined on the system, one of the candidates is the embedded Print Server.
9. Press **ESC** three times to go to the main menu "**Available Options**" and select "**Print Server Information**"
10. Select the appropriate Print Server and press **ENTER**
11. From the "**Print Server Information**" menu select "**Print Server Configuration**".

12. Then from the “**Print Server Configuration**” menu select “**Printer Configuration**” and press **ENTER**
13. From the list “**Configured Printers**” select either an already configured printer to change or select one of the printers “ **Not Installed**” and press **ENTER**.
Notice that the number of the printer must correspond to the ENP number in the *PrintServer* configuration of ENPs. The default *PrintServer* ENP numbers are 0 and 1.
14. Type a name for the printer in the “ **Printer X Configuration**” menu
15. Select “**Type**” and press **ENTER** and select “**Remote Other/Unknown**”.
- Now make other NPRINT configuration if so required*
16. Press **ESC** to leave the menu and select **YES** to save changes.
17. Press **ESC** to return to the “**Print Server Configuration**” menu.
18. Select “**Queues Serviced by Printer**” and press **ENTER**
19. Select the appropriate printer and press **ENTER**.
20. Press **INS** and select the queue for the printer, then press **ENTER**
21. Select “**Priority**” for the printer
22. Press **ESC** six times and answer **YES** to exit PCONSOLE

**Proceed to the configuration of the various settings.
For configuration details, see chapter 3.**

4.5 NetWare setup - DS mode

This section describes the setting up of the NetWare version 4.xx for IPX/SPX printing using Directory Services (DS) mode.

NOTE:

You must either load the PSERVER.NLM on the server or define the embedded PRINTSERVER in the *Xerox 4500 PS TR* before connecting the NPRINT.

1. Type **PCONSOLE** to start the PCONSOLE program.
2. Make sure that you have the correct current context. If not specify a new by selecting the menu "**Change Context**".
Notice that if the embedded Print Server in the Xerox 4500 PS TR is used, the context must match the EPS context settings in the Xerox 4500 PS TR.
3. Choose "**Print Servers**" from the menu to service the *Xerox 4500 PS TR* and select the appropriate printer by pressing **ENTER**.
4. Select "**Printers**" from the Print Server Information menu and press **INS** twice to create a new network printer.
Notice that the number of the network printer must correspond to the number of one the ENP printer definitions in the Xerox 4500 PS TR configuration.
5. Write a name for the printer you wish to create and press **ENTER**.
6. Select the new printer and press **ENTER**.
7. In the "**Serviced Printers**" menu, select the new printer and press **ENTER**.
8. In the configuration menu, select "**Printer type**".
9. Select "**Other / Unknown**".
10. In the configuration menu, select "**Print queues assigned**".
11. Press **INS** twice to create a new queue.

12. Type the name of the new queue.
The name of the queue is user-defined. A commonly used convention is to give it the same name as the print server with the addition of “_Q”. (e.g. sales4_Q)
13. Select the volume where you want the print jobs to be stored.
Do not use the volume SYS as this may cause problems in certain situations.
14. Select the new printer and press **ENTER** and then **ESC**.

Now make other NPRINT configurations if so required.
15. Press **ESC** twice. .
16. Save the changes (YES) and press **ENTER**.
17. Press **ESC** three times.
18. Exit the program by pressing **ESC** a fourth time.

**Proceed to the configuration of the various settings.
For configuration details, see chapter 3.**

4.6 Illustration

See the illustration in the following how the print request from the user is sent to the assigned printer.

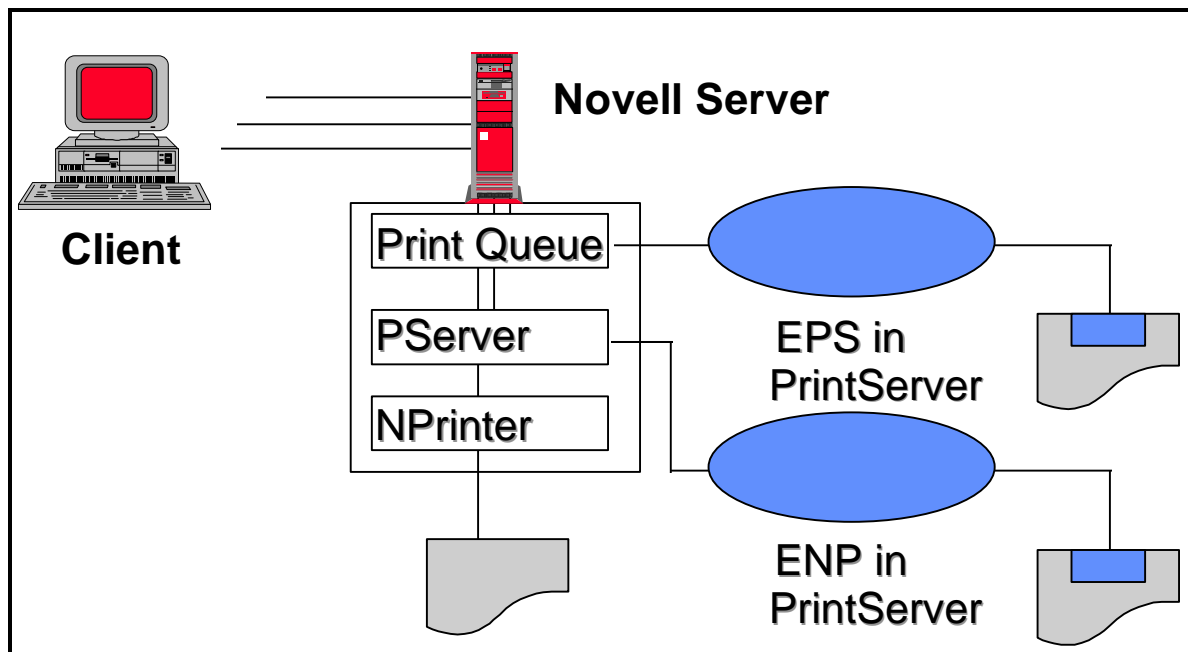

Novell LAN Printing with PrintServer

5. NetBEUI/NetBIOS Printing Using Windows '95, NT or OS/2

This chapter provides instructions for setting up the Windows '95, NT or OS/2 operating systems for native printing via the Xerox 4500 PS TR using the NetBEUI/NetBIOS protocols.

Before you begin the setup procedure, please ensure that the NetBEUI/NetBIOS protocols have been properly installed on your network.

5.1 Windows '95 and NT Setup

To set up the Windows '95 and NT systems follow the below instructions:

Via the "Network Neighborhood" icon on your desktop, you select the "entire network" entry. Now open the default "Workgroup".

The default name of the PrintServer will appear in the workgroup like this:

Last 6 digets of MAC address

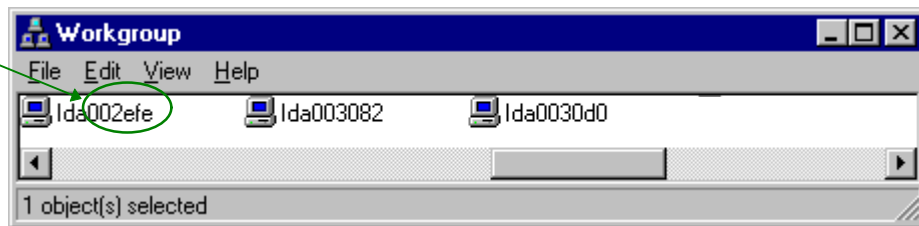

Now doubleclick the name of the PrintServer for configuration of the printers available in the PrintServer:

Only appears if PAR2 has been set to output

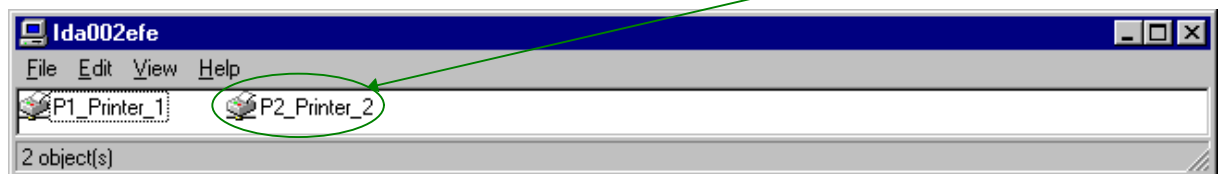

Again you doubleclick this entry to enter the printer selection mode. You will encounter the following query to which you answer "yes":

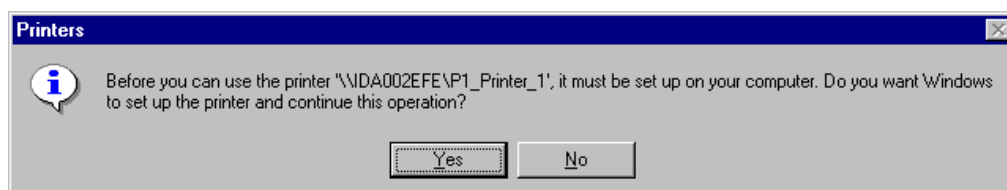

The "Add Printer Wizard" will then open and you may select manufacturer and printer model via the wizard.

NOTE:

Windows '95 Xerox drivers may be obtained from the Xerox Web Site at: <http://www.xerox.com> or you may contact your point of purchase for details.

NOTE:

During the set up, you may need access to the original installation CDROM for Windows '95 and NT.

5.2 OS/2 Setup

To set up the OS/2 operating system follow these instructions:

1. Open an OS/2 window
2. Enter the following command at the prompt:
net view \\ <PrintServer name>

NOTE:

The default PrintServer name is "idaxxxxx" where the six "x'es" represent the last six digets of the MAC address

3. Press RETURN
4. Now enter this command:
net use lptx \\ida002efe\Px_Printer_x
5. You have now captured your port for the PrintServer and you next step is then to install a printer.

```
[D:\] net view \\ida002efe
Shared resources at \\ida002efe

Net name      Type      Used as      Comment
-----
P1_Printer_1  Print     idaPS printer
P2_Printer_2  Print     idaPS printer
The command completed successfully.

[D:\] net use lpt1 \\ida002efe\P1_Printer_1
The command completed successfully.
```

Example of setup for OS/2

5.3 Changing the default PrintServer Name and Workgroup

This can be done using any of the available configuration methods:

Psinst32: see section 3.3

Web Browser: see section 3.4

Telnet: see section 3.5

Setup file: see section 3.6

6. OS/2 Printing Using TCP/IP LPR/LPD

This chapter provides the three methods available for printing from OS/2 based PC's with TCP/IP installed:

1. Via print queue output port selection
(see *Section 5.1* below for details).
2. Via redirection of LPTx port with LPR command
(see *Section 5.2* below for details).
3. Redirection of LPTx port with LPRMON command
(see *Section 5.3* below for details).

Once these parameters have been configured, and the basic TCP/IP installation of the *Xerox 4500 PS TR* has been completed, direct printing from OS/2 will be possible.

6.1 OS/2 printing via a print queue

1. Open the “**Templates**” folder.
2. Drag and drop the printer icon onto the desktop.

The “Settings” menu for the printer will now open automatically.
3. Give the printer a name and select the printer driver required.
4. Select the output port to be used by clicking one of the “LPD pipes”.

e.g. \PIPE\LPD0.

6. Give the LPD server a name
This may be either the IP address or the name which the *Xerox 4500 PS TR* has been given on a Name Server.
7. Give the LPD printer a name
The default LPD printer names defined in *Xerox 4500 PS TR* are LPTPRT1 and LPDPRT2.

The LPDPrt1acr and LPTPrt2acr may also be used if a <CR> is required at each linefeed.

The rest of the fields in this panel are optional.

8. Click on “**OK**” and the window will close.
9. Click on “**Create**” to create the printer

NOTE: The LPRPORTD program must be started for this facility to function.

6.2 OS/2 printing using LPR command

The LPR command may be used to print to the *Xerox 4500 PS TR*

To invoke the LPR command from the command line, type e.g. the following command::

```
LPR -b -pLPDPrt1 -s192.0.110.1 myprint.pcl
```

To avoid having to type this every time, the parameters can be included in a **.CMD** file.

For more details on the options available with the LPR command you are referred to the chapter “Entering the LPR Command” in the “TCP/IP for OS/2 User’s Guide” or to the “TCP/IP Command Reference”.

6.3 OS/2 printing via redirection of LPTx Port with LPRMON command

The LPRMON command is similar to the LPR command but provides an on-screen monitoring facility of the data transfer to the *Xerox 4500 PS TR*.

The LPRMON command may be invoked from the command line typing e.g.:

```
LPRMON -b -pLPDPrt1 -s192.0.110.1 LPT1
```

The above command may also be included in a **.CMD** file for ease of operation.

For more details of the LPRMON command, please consult the LPRMON section of the “TCP/IP for OS/2 User’s Guide” or the “TCP/IP Command Reference”.

7. UNIX Printing Using TCP/IP LPR/LPD

Below is information on how you print from the three following UNIX systems.

1. **AIX** Version 3.2.5
 Version 4.1
 (see *Section 6.1* below for details)
2. **SunOS** Rel. 5.3, Open Windows Version 3.3 (equ ivalent to
 Solaris)
 (see *Section.6.2* below for details)
3. **HP-UX** (TCP/IP spooler not used)
 (see *Section 6.3* below for details)

Once these parameters have been configured, and the basic TCP/IP installation of the *PrintServer* completed, direct printing from UNIX will be possible.

7.1 AIX printing using TCP/IP LPR/LPD

Version 3.2.5

Before you can print via AIX version 3.2.5, the following 2 steps must have been completed:

1. Host Configuration

You must make sure that the *Xerox 4500 PS TR* is defined as a host system. This can be done by using the **smit** command. Use of this command requires root authority (i.e. use the **su** command to switch to the root user). Alternatively, you may add the additional IP entries manually by editing the */etc/hosts* file and appending the additional IP address and name for the *Xerox 4500 PS TR*.

2. Define the remote printer using smit

1. Enter the **smit** command.
2. Use the following menu selections to supply the printer information:
 - Spooler (Print Jobs)
 - Manage Remote Printer Subsystem
 - Client Services
 - Remote Printer Queues
 - Add a Remote Queue

The entries shown in the [Entry Fields] column below are sample entries for the "Add a remote queue" panel.

	[Entry Fields]
NAME of queue to add	[your name]
ACTIVATE the queue?	yes
Will this become the DEFAULT queue?	no
Queuing DISCIPLINE	first come first served
ACCOUNTING FILE pathname	[]
DESTINATION HOST for remote jobs	[your host]
Pathname of the SHORT FORM FILTER for queue status output	[/usr/lpd/bsdshort]
Pathname of the LONG FORM FILTER for queue status output	[/usr/lpd/bsdlong]
Name of QUEUE on remote printer	[LPDPrt1]
NAME of device to add	[LPDPrt1]
BACKEND PROGRAM pathname	[/usr/lpd/rembak]

NOTE:

Make sure that the pathname of the short and long form filter are modified to **bsdshort/bsdlong**

The name of QUEUE on remote printer and NAME of device to add should be the same and one of the following

- LPDPrt1
- LPDPrt2
- LPDPrt1acr
- LPDPrt2acr

Once the printer has been defined, printing can be performed using the lp, lpr, qprt or enq commands.

Version 4.1

Before you can print via AIX version 4.1, the following 2 steps must have been completed.

1. Host Configuration

You must make sure that the *Xerox 4500 PS TR* is defined as a host system. This can be done by using the **smit** command. Use of this command requires root authority (i.e. use the su command to switch to the root user). Alternatively, you may add the additional IP entries manually by editing the /etc/hosts file and appending the additional IP address and name for the *Xerox 4500 PS TR*.

2. Define the remote printer using smit

1. Enter the smit command
2. Use the following menu selections so supply the printer information:
 - print spooling
 - add a print queue
 - ↳ select "remote"
 - ↳ select "standard processing"

		[Entry Fields]
	NAME of queue to add	[your name]
Mandatory	HOST name of remote server	[user definable]
	NAME of queue on remote server (see NOTE)	[user definable]
Optional	Type of print spool on remote server	bsd
	Description of printer on remote server	[user definable]

NOTE:

You should make sure that the path name of the short and long form filter are modified to **bsdshort/bsdlong**

The name of QUEUE on remote printer and NAME of device to add should be the same and one of the following

LPDPrt1
 LPDPrt2
 LPDPrt1acr
 LPDPrt2acr

Once the printer has been defined, printing can be performed using the lp, lpr, qprt or enq commands.

7.2 SUN OS printing using TCP/IP LPR/LPD

The following procedure can be used to configure a printer on a remote system without using the TCP/IP print spooler function.

1. Host Configuration

Ensure that the *Xerox 4500 PS TR* is defined as a host system. This can be done using the '*admintool*' function. Use of this command requires root authority (i.e. use the **su** command to switch to the root user). Alternatively, you may add the additional IP entries manually by editing the */etc/hosts* file and appending the additional IP address and name for the *PrintServer (non-IPDS)*

2. Defining the remote printer/plotter using **admintool**

1. Enter the **admintool** command. (*Use of this command will require root authority*)
2. Use the following menu items to supply the printer information:

Printer manager (Edit)
Add printer
Add access to remote printer

The following information must be supplied on the "Add access to remote printer panel":

Printer Name

The printer name is the queue name on the *Xerox 4500 PS TR*. Depending on the type of print that will be printed (raw or auto-carriage return (ACR)) and the attached output printer (LPT1 or LPT2), this name can be one of the following:

LPDPrt1
LPDPrt2
LPDPrt1acr
LPDPrt2acr

Print Server

The printer server name must be the same as the host name supplied in the host table.

Printer Server OS:

For LPDPrt1 and LPTPr2, BSD (Berkeley) should be selected.

3. Enable the printer using the **admintool**

Ensure that the printer is enabled by using the **admintool** and selecting the modify printer option and use the enable function.

Print can be directed to the defined printer using the supplied **lp** commands. The **lpr** command may not be supplied with the base operating system.

7.3 HP-UX printing with SAM using TCP/IP LPR/LPD

This procedure can be used to configure a printer on a remote system without using the TCP/IP print spooler function.

1. Host Configuration

Ensure that the *Xerox 4500 PS TR* is defined as a host system. This can be done using the "System Administrator Manager (SAM)". Use of this command requires root authority (i.e. use the **su** command to switch to the root user). Alternatively, you may add the additional IP entries manually by editing the */etc/hosts* file and appending the additional IP address and name for the *Xerox 4500 PS TR*.

2. Defining the remote printer/plotter using SAM

1. Enter **SAM** from a HP term or xterm session.
2. Use the following menu items to supply the printer information:

Printers and plotters
Printers/plotters
Add remote print/plotter

The following information must be supplied on the "Add remote print/plotter" panel:

Printer name

This name is the symbolic name that you will be using to refer to the printer.

Remote Print Name

The remote print name is the queue name on the *Xerox 4500 PS TR*. Depending on the type of print that will be printed (raw or auto-carriage return (ACR)), and the attached output printer (LPT1 or LPT2), this name can be one of the following:

LPDPrt1
LPDPrt2
LPDPrt1acr
LPDPrt2acr

For LPDPrt1 and LPDPrt2, the option "Remote printer is on a BSD system" should be selected.

Print can be directed to the defined printer using the supplied *lp* or *lpr* commands, *lpr -dmyprint /users/root/sam.log*.

8. Windows NT Printing Using TCP/IP LPR/LPD

This section describes how to select an LPR/LPD printer from Windows NT.

1. From the Main menu select the icon “**Control Panel**”.
2. Select the “**Network**” icon.

Make certain that the entry “**Microsoft TCP/IP Printing**” is entered into the menu “**Installed Network Software**”

If not, click on “**Add Software**”.

From here you select the above mentioned network software from the list.

For details on installation, refer to your Windows NT documentation.

3. From the “**Control Panel**” menu select the “**Printer**” icon.
4. From the “**Print Manager**” select the menu “**Printers**” and double-click on “**Create Printers**”.
5. Enter a name for the printer in “**Printer Name**”.
6. Select appropriate driver.
7. From the pull-down list in “**Print to**”, select the option “**Other**”.
8. From the list in “**Print Destination**” select “**LPR Port**”.
9. Press “**OK**” to confirm.
10. You are now prompted to enter the IP address of the *Xerox 4500 PS TR* and the name providing LPD.
11. In the menu “**Name of printer on that machine**” you make an entry for the default configuration “LPDPRT1”.
12. Press “**OK**” to confirm.

An LPD printer has now been added.

9. AS/400 Printing Using Host Print Transform and TCP/IP

This chapter provides:

AS/400 definitions for ASCII printing

Once these parameters have been configured, and the basic TCP/IP configuration of the *Xerox 4500 PS TR* has been completed, printing from AS/400 will be possible. This will use the AS/400 Host Print Transform to format and translate EBCDIC data, the command language used by the printer selected on the AS/400.

If 3812-1 emulation is required then the TCP/IP connection described in the “AS/400 SCS/DCA Printing using TCP/IP” section, should be considered.

If an SNA connection is required then the “AS/400 SCS Printing Using SNA” chapter should be considered.

If IPDS printing is required, chapter 13 “PSF/400 AFP Printing Using TCP/IP” should be considered.



Requirements:

- AS/400 version 3.1 with TCP/IP installed and a TCP/IP configured *Xerox 4500 PS TR*

The defined Output queue will be specified in print options when printing the document.

9.1 Create a remote output queue

The CRTOUTQ command is used to create a Remote output queue. This will enable the AS/400 to automatically output data that has been translated by Host Print Transform to the *Xerox 4500 PS TR*.

The following example shows the values required to create an output queue called PSX3OUTQ.

```
                Create Output Queue (CRTOUTQ)

Type choices, press Enter.

Output queue . . . . . OUTQ          > PSX3OUTQ
Library . . . . .                  *CURLIB
Maximum spooled file size:  MAXPAGES
Number of pages . . . . .          *NONE
Starting time . . . . .
Ending time . . . . .
                                + for more values
Order of files on queue . . . . SEQ   > *FIFO
Remote system . . . . . RMTSYS      > *INTNETADR

Remote printer queue . . . . . RMPRTQ > XXXXXXXX
Writers to autostart . . . . . AUTOSTRWTR > 1
```

The value XXXXXXXX used for RMPRTQ must match the LPD printer queue defined in the *Xerox 4500 PS TR*. The default value is LPDPRT1.

```
                Create Output Queue (CRTOUTQ)

Type choices, press Enter.

Queue for writer messages . . . . MSGQ      QSYSOPR
Library . . . . .                  *LIBL
Connection type . . . . . CNNTYPE        > *IP
Destination type . . . . . DESTTYPE      > *OS400
Transform SCS to ASCII . . . . . TRANSFORM > *YES
Manufacturer type and model . . . MFRTYPMDL *XXXXXXX
Internet address . . . . . INTNETADR     > '   YYY:YYY:YYY:YYY '
Destination options . . . . . DESTOPT     *NONE

Text 'description' . . . . . TEXT        > 'ASCII outq for Sales PSx3'
```

The value *IP must be used for CNNTYPE
The value *OS400 must be used for DESTTYPE
The value *YES must be used for TRANSFORM
The value used for MFRTYPMDL will depend on the attached printer. Use the 'F4' to obtain a list of the possible choices
The value YYY:YYY:YYY:YYY used for INTNETADR must be the same as the IP address of the *Xerox 4500 PS TR*.

9.2 AS/400 printing

In order to print to the *Xerox 4500 PS TR*, the OUTQ defined above must be started with the STRRMWTR command.

The data to be printed must be associated with the defined OUTQ via the various PRTF commands.

10. PSF/400 AFP Printing Using TCP/IP

This chapter provides configuration guidelines for AS/400 using TCP/IP. The versions differ somewhat in the setup.

If you are running AS/400 version 3.1 or 3.6, you should see section 13.1. If you are running AS/400 version 3.2 or 3.7, see section 13.2.

Requirements:



Before IPDS printing using TCP/IP can be accomplished, the following points need to be checked:

1. TCP/IP is installed and enabled
2. The relevant PTFs are applied
(for AS/400 3.1 and 3.6 only)
3. The WRKAFP2 command is compiled
(for AS/400 3.1 and 3.6 only)

Details on how to verify these items are supplied in a separate document included on the documentation diskette.



See the file: **AS400PTF**.

PSF/400 is also a pre-requisite for IPDS printing. IPDS printing is however possible for a period of time as a license can be obtained.

Once the above conditions have been met, the parameters have been configured. The basic TCP/IP installation of the *Xerox 4500 PS TR IPC* (IPDS) must also have been completed before direct AFP / IPDS from PSF/400 will be possible.

NOTE:

- The Maximum Transmission Unit (MTU) of the IP packet size that can be used is 2000.

10.1 AS/400 version 3.1 and 3.6

This section describes the following configuration:

CRTDEVPRT samples
WRKAFP2 samples

10.1.1 CRTDEVPRT

Create a printer device description for version 3.1 or 3.6.

The value must be unique within the network.

When using TCP/IP support from PSF/400 version 3.1, the stated value is not used, but must be set to a unique name that is NOT used on your AS/400.

```
CRTDEVPRT DEVD(PRTPS123)
          DEVCLS(*RMT)
          TYPE(*IPDS)
          MODEL(0)
          AFP(*YES)
          AFPATTACH(*APPC)
          FONT (11)
          FORMFEED(*AUTOCUT)
          RMTLOCNAME(TCPIP)
          TEXT(Using TCP/IP support)
```

DEVCLS	*RMT is required
TYPE	*IPDS is required
MODEL	0 is required
AFP	*YES is required
AFPATTACH	*APPC is required
FONT	A value appropriate for the environment is required
FORMFEED	A value appropriate for the printer is required
RMTLOCNAME	Use any name that will not be used as a remote location name on the network.

NOTE:

This configuration of a printer device description is as if an APPC attachment is to be used.

10.1.2 Configuring WRKAFP2 for direct TCP/IP connection

```
WRKAFP2 DEVD (PRTPS123 )  
        RETRY (2)  
        TCPIP (*YES)  
        RMTSYS ('192.0.110.21')  
        PORT (5001)  
        ACTTMR (170)  
        INACTTMR (*NOMAX)
```

DEVD This value must match the DEVD in the printer device description.

RETRY Specifies the number of retry attempts to establish a session

TCPIP This value must be set to *YES.

RMTSYS An IP address or a host name may be used for this parameter. In this example, an IP address is used. When configuring the IP address parameter for the *Xerox 4500 PS TR IPC(IPDS)*, an IP address (and not a host name) must be used.

PORT This value must match the value used for the *Xerox 4500 PS TR (IPDS) TCP* port parameter. The Port no. 5001 is the default port number of the first IPDS port on the *Xerox 4500 PS TR(IPDS)*.

ACTTMR This value specifies the number of seconds PSF/400 will wait for the *Xerox 4500 PS TR* to respond to an activation request. If the printer does not respond within this period, PSF/400 will terminate.

INACTTMR This value specifies the length of time PSF/400 will maintain a session with the printer while there are no spooled files with a status of RDY.

NOTE: The values in the WRKAFP2 command vary slightly according to the PTF level and the operating system version. Consult the following document supplied on the diskette for details:



AS400PTF

10.1.3 Setting the CHGTCPA

If your environment has a need to make certain that a TCP/IP attached device has not been powered off, you may use the TCP KEEP ALIVE parameter in CHGTCPA. This value used for this parameter determines how long PSF/400 will wait for a response from a device before terminating.

10.2 AS/400 version 3.2 and 3.7

This section describes the following configuration:

CRTDEVPRT samples
 CRTPSFCFG samples (version 3.2 only)

10.2.1 CRTDEVPRT

Create a printer device (CRTDEVPRT) description for version 3.2 or 3.7.
 Type the entry of choice and press Enter.

The value must be unique within the network.

Device description	> < >	Name	
Device class	> *LAN	*LCL, *RMT, *VRT, *SNPT, *LAN	
Device type	> *IPDS	3287, 3812, 4019, 4201...	
Device model	> 0	0, 1, 2, 3, 4, 10, 13, 301...	
LAN attachment	*IP	*LEXLINK, *IP, *USRDFN	
Advanced function printing . . .	*YES	*NO, *YES	
Port number	5001	0-65535	
Online at IPL	*YES	*YES, *NO	
Font:			
Identifier	11	3, 5, 11, 12, 13, 18, 19...	
Point size	*NONE	000.1-999.9, *NONE	
Form feed	*TYPE	*TYPE, *CONT, *CUT, *AUTOCUT	
Separator drawer	*FILE	1-255, *FILE	
Separator program	*NONE	Name, *NONE	
Library		Name, *LIBL, *CURLIB	
Message queue	QSYSOPR	Name, QSYSOPR	
Library	*LIBL	Name, *LIBL, *CURLIB	
Activation timer	170	1-2550, *NOMAX	
Maximum pending requests	6	1-31	
Print while converting	*YES	*NO, *YES	
Print request timer	*NOMAX	1-3600, *NOMAX	
Form definition	F1C10110	Name	
Library	*LIBL	Name, *LIBL, *CURLIB	
Remote location:			
Name or address	192.0.110.111		

NOTE: The bolded entries are mandatory settings. The “Font Identifier” is not mandatory in a strict PrintServer related configuration, but is necessary for the system’s own identification purposes.

PORT This value must match the value used for the *Xerox 4500 PS TR IPC* (IPDS) TCP port parameter. The Port no. 5001 is the default port number of the first IPDS port on the *Xerox 4500 PS TR IPC*(IPDS).

10.2.2 CRTPSFCFG (version 3.2 only)

When the printer device has been created, you are to make the configuration for direct TCP/IP connection using PSF/400 running version 3.2. Below you will find a sample configuration.

Create PSF Configuration (CRTPSFCFG)

```

PSF configuration . . . . . Name
Library . . . . . *CURLIB Name, *CURLIB
User resource library list . . *JOBLIBL *JOBLIBL, *CURLIB, *PRTF...
Device resource library list . . *DFT Name, *DFT
      + for more values
IPDS pass through . . . . . *NO *NO, *YES
Activate release timer . . . . *NORDYF *NORDYF, *IMMED...
Release timer . . . . . *NOMAX 1-1440, *NOMAX,
*SEC15...
Restart timer . . . . . *IMMED 1-1440, *IMMED
SNA retry count . . . . . 2 1-99, *NOMAX
Delay time between SNA retries 0 0-999
Text 'description' . . . . . *BLANK
      Create PSF Configuration (CRTPSFCFG)
  
```

Type choices, press Enter.

Additional Parameters

```

Blank page . . . . . *YES *YES, *NO
Page size control . . . . . *NO *NO, *YES
Resident fonts . . . . . *YES *YES, *NO
Resource retention . . . . . *YES *YES, *NO
Edge orient . . . . . *NO *YES, *NO
Remote location:
  Name or address . . . . . *192.0.110.111

TCP/IP port . . . . . *NONE 1-65535, *NONE
TCP/IP activation timer . . . . 170 1-2550, *NOMAX
Use outline fonts . . . . . *NO
*YES, *NO
  
```

11. AS/400 SCS Printing Using SNA

This chapter provides:

AS/400 definitions for 3270 SCS printing

Once these parameters have been configured, and the basic SNA installation of the *Xerox 4500 PS TR* (equipped with an FSL top module) has been completed, direct SCS print will be possible. This method enables printing of datasets that would have been printed on a 5256 twinax or 3287 coax attached printer.

If 3812-1 emulation is required then the TCP/IP connection described in the “AS/400 SCS/DCA Printing using TCP/IP” section, should be considered.

If AS/400 Host Print Transform is being used then the TCP/IP connection described in the “AS/400 Printing using TCP/IP LPR/LPD” section, should be considered.

If IPDS printing is required, the TCP/IP connection described in the chapter “PSF/400 AFP Printing Using TCP/IP” should be considered.



Requirements:

- *Xerox 4500 PS TR* (equipped with an FSL top module) with 3270 emulation

11.1 AS/400 controller definition

The CRTCTRLWS command is used to create a Remote Work Station Controller.

The following example shows the values required to create a controller called PS3174.

```
      Create Ctl Desc (Remote WS) (CRTCTRLWS)

Type choices, press Enter.

Controller description . . . . . CTLD           > PS3174
Controller type . . . . . TYPE                > 3174
Controller model . . . . . MODEL              > 0
Link type . . . . . LINKTYPE                  > *LAN
Online at IPL . . . . . ONLINE                > *YES
Switched line list . . . . . SWTLINLST       > XXXXXXXXXX
                                         + for more values
Maximum frame size . . . . . MAXFRAME        *LINKTYPE
Exchange identifier . . . . . EXCHID         > YYYYYYYY
Initial connection . . . . . INLCNN          *DIAL
Dial initiation . . . . . DIALINIT           *LINKTYPE
LAN remote adapter address . . . . . ADPTADR > ZZZZZZZZZZZZ
Autocreate device . . . . . AUTOCRTDEV       *ALL
Text 'description' . . . . . TEXT            > 'SNA PS 23 in Sales'
```

More... F9=All parameters F11=Choices F14=Command string F24=More keys

The value XXXXXXXXX used for SWTLINLST must be replaced by the name of the LAN adapter being used on the AS/400

The value YYYYYYYY used for EXCHID must be the same as the Block and ID Numbers of the *Xerox 4500 PS TR*. The default value is 05D00000.

The value ZZZZZZZZZZZZ used for ADPTADR must be the same as the MAC address of the *Xerox 4500 PS TR*. The default value is Universal MAC address indicated on the side of the *Xerox 4500 PS TR*. The current value can be found on the first page of the test printout.

11.2 AS/400 printer definition

The CRTDEVPRT command is used to create a Printer device.

The following example shows the values required to create a printer called PS3287.

```
                Create Device Desc (Printer) (CRTDEVPRT)

Type choices, press Enter.

Device description . . . . . DEVD          > PS3287
Device class . . . . . DEVCLS             > *RMT
Device type . . . . . TYPE                > 3287
Device model . . . . . MODEL              > 0
Local location address . . . . . LOCADR    > 02
Online at IPL . . . . . ONLINE            > *YES
Attached controller . . . . . CTL         > PS3174
Separator program . . . . . SEPPGM        > *NONE
Library . . . . .
Printer error message . . . . . PRTERMSG   > *INQ
Message queue . . . . . MSGQ              > QSYSOPR
Library . . . . . *LIBL
Application type . . . . . APPTYPE        > *NONE
Text 'description' . . . . . TEXT         > '3287 Printer in sales'
```

More...
F3=Exit F4=Prompt F5=Refresh F12=Cancel F13=How to use this display F24=More
keys

The value PS3174 used for CTL must match the name given in the CTLD parameter in the Controller definition made on the previous page.

11.3 AS/400 printing

Once the above definitions have been made the devices should be varied on and printing can be accomplished in the normal way.

12. AS/400 SCS-DCA Printing Using TCP/IP

This chapter provides:

AS/400 definitions for SCS/DCA printing

Once these parameters have been configured, and the basic TCP/IP installation of the *Xerox 4500 PS TR* (equipped with an FSL top) has been completed, direct SCS/DCA will be possible. This will off-load the AS/400 as Host Print Transform is not used.

Requirements:

- AS/400 version 3.1 or higher with TCP/IP installed and a TCP/IP configured *Xerox 4500 PS TR* (equipped with an FSL top) with 5250 emulation

12.1 Create a remote output queue

The CRTOUTQ command is used to create a Remote output queue. This will enable the AS/400 to automatically output SCS/DCA data directly to an *Xerox 4500 PS TR* (equipped with an FSL top).

The following example shows the values required to create queue called PS23OUTQ.

```
                                Create Output Queue (CRTOUTQ)
Type choices, press Enter.
Output queue . . . . . OUTQ          > PS23OUTQ
Library . . . . .                   *CURLIB
Maximum spooled file size:  MAXPAGES
Number of pages . . . . .           *NONE
Starting time . . . . .
Ending time . . . . .
                                + for more values
Order of files on queue . . . . SEQ   *FIFO
Remote system . . . . . RMTSYS       > *INTNETADR

Remote printer queue . . . . . RMPRTQ > LPDPRT1SCS

Writers to autostart . . . . . AUTOSTRWTR > 1
```

The value LPDPRT1SCS used for RMPRTQ must match the SCS printer queue defined in the *Xerox 4500 PS TR* (equipped with an FSL top). The default value is LPDPRT1SCS.

```
                Create Output Queue (CRTOUTQ)

Type choices, press Enter.

Queue for writer messages . . . . . MSGQ           QSYSOPR
  Library . . . . .                               *LIBL
Connection type . . . . . CNNTYPE                 > *IP
Destination type . . . . . DESTTYPE               > *OS400
Transform SCS to ASCII . . . . . TRANSFORM        > *NO
Internet address . . . . . INTNETADR              192.0.110.111
Destination options . . . . . DESTOPT             *NONE

Text 'description' . . . . . TEXT                 SCS/DCA Outq PS32 Sales PrintServer
```

More...
F3=Exit F4=Prompt F5=Refresh F12=Cancel F13=How to use this display F24=More keys

The value *IP must be used for CNNTYPE
The value *OS400 must be used for DESTTYPE
The value *NO must be used for TRANSFORM

12.2 AS/400 Printing

This method of printing supports various printer emulations.
For **Laser printers** all non-IPDS emulations are supported.
Matrix printers support the traditional IBM matrix emulations.

When printing from OFFICE/400 care must be taken when submitting data to be printed. The printer defined in the Print Option menu panel of OFFICE/400 must have a similar emulation to the printer defined in the OUTQ parameter.

In order to print to the *Xerox 4500 PS TR* (equipped with an FSL top), the OUTQ defined above must be started with the STRRMTWTR command.

13. PSF/MVS AFP Printing Using TCP/IP

This chapter provides:

JES installation statements
PSF Startup Procedures

Once these parameters have been configured, and the basic TCP/IP installation of the *Xerox 4500 PS TR IPC* (equipped with an IPDS top) has been completed, direct AFP / IPDS from PSF / MVS will be possible.



Requirements:

- use of PSF/MVS version 2.2.0 with PTF level UW21345

MTU size

- The Maximum Transmission Unit (MTU) of the IP packet for the MVS system is *recommended* to be set up to 2000.

NOTE: The MTU size should not exceed the maximum size sent through the control unit. Failure may lead to transmission problems.

13.1 PSF/MVS direct attachment

Sample PSF/MVS JES2 initialisation statements

```
FSSDEF ( FSS1 ) PROC=PSF4 , HASPFSSM=HASPFSSM
```

```
PRT420 , FSS=FSS1 , MODE=FSS , PRMODE= ( LINE , PAGE ) ,  
CLASS=A , UCS=0 , SEP , NOSEPDS , CKPTPAGE=100 ,  
DRAIN , WS= ( R , Q / FCB )
```

Example of PSF/MVS JES2 printer definition

13.2 PSF/MVS startup procedure

```

000001 //PSF4   PROC
000002 //STEP01 EXEC PGM=APSPPIEP,REGION=1750K
000003 //JOBHDR OUTPUT PAGEDEF=V06483,          /* JOB SEPARATOR PAGEDEF */
000004 //      FORMDEF=A10110,CHARS=GT15         /* JOB SEPARATOR FORMDEF  */
000005 //JOBTLR OUTPUT PAGEDEF=V06483,          /* JOB SEPARATOR PAGEDEF */
000006 //      FORMDEF=A10110,CHARS=GT15         /* JOB SEPARATOR FORMDEF  */
000007 //DSHDR  OUTPUT PAGEDEF=V06483,          /* DS SEPARATOR PAGEDEF   */
000008 //      FORMDEF=A10120,CHARS=GT15         /* DS SEPARATOR FORMDEF   */
000009 //MSGDS  OUTPUT PAGEDEF=A06462,          /* MESSAGE DATASET PAGEDEF */
000010 //      FORMDEF=A10110                     /* MESSAGE DATASET FORMDEF */
000011 //*****
000012 //*
000013 //*      THIS PROC. IS TO BE USED FOR 300 DPI DEVICES
000014 //*
000015 //*****
000016 //FONT01 DD DSN=IDAPBJ.AFPLIB,DISP=SHR     /* PBJ   FONTS - 300 DPI  */
000017 //      DD DSN=SYS2.FONT300,DISP=SHR      /* SYSTEM FONTS - 300 DPI */
000020 //*-----
000021 //PSEG01 DD DSN=IDAPBJ.AFPLIB,DISP=SHR     /* SYSTEM PAGE SEGMENTS  */
000022 //      DD DSN=SYS2.PSEGLIB,DISP=SHR      /* SYSTEM PAGE SEGMENTS  */
000023 //      DD DSN=SYS1.PSEGLIB,DISP=SHR      /* SYSTEM PAGE SEGMENTS  */
000024 //*-----
000025 //OLAY01 DD DSN=IDAPBJ.AFPLIB,DISP=SHR     /* SYSTEM MEDIUM OVERLAYS */
000026 //      DD DSN=SYS2.OVERLIB,DISP=SHR      /* SYSTEM MEDIUM OVERLAYS */
000027 //      DD DSN=SYS1.OVERLIB,DISP=SHR      /* SYSTEM MEDIUM OVERLAYS */
000028 //*-----
000029 //PDEF01 DD DSN=SYS2.PDEFLIB,DISP=SHR      /* SYSTEM PAGEDEFS       */
000030 //      DD DSN=SYS1.PDEFLIB,DISP=SHR      /* SYSTEM PAGEDEFS       */
000031 //*-----
000032 //FDEF01 DD DSN=SYS2.FDEFLIB,DISP=SHR      /* SYSTEM FORMDEFS       */
000033 //      DD DSN=SYS1.FDEFLIB,DISP=SHR      /* SYSTEM FORMDEFS       */
000034 //*****
000035 //*      STANDARD          PRINTDEV          */
000036 //*****
000037 //PRT420 CNTL
000038 //PRT420 PRINTDEV FONTDD=* .FONT01,        /* FONT      LIBRARY DD   */
000039 //      OVLYDD=* .OLAY01,                  /* OVERLAY   LIBRARY DD   */
000040 //      PSEGDD=* .PSEG01,                  /* SEGMENT   LIBRARY DD   */
000041 //      PDEFDD=* .PDEF01,                  /* PAGEDEF   LIBRARY DD   */
000042 //      FDEFDD=* .FDEF01,                  /* FORMDEF   LIBRARY DD   */
000043 //      JOBHDR=* .JOBHDR,                  /* JOB HEADER SEPARATOR OUTPUT */
000044 //      JOBTRLR=* .JOBTRLR,                /* JOB TRAILER SEPARATOR OUTPUT */
000045 //      DSHDR=* .DSHDR,                    /* DATA SET HEADER SEPERATOR */
000046 //      MESSAGE=* .MSGDS,                  /* MESSAGE DATA SET OUTPUT */
000047 //      PAGEDEF=A06462,                    /* DEVICE PAGEDEF DEFAULT */
000048 //      FORMDEF=A10110,                    /* DEVICE FORMDEF DEFAULT */
000049 //      CHARS=(GT10,                        /* DEVICE */
000050 //      GT12,GT15,GT10),                   /* DEFAULT FONT SET */
000051 //      PIMSG=YES,                          /* ACCUMULATE DATA SET MESSAGES */
000052 //      DATAK=BLOCK,                       /* REPORT ALL DATA-CHECK ERRORS */
000053 //      TRACE=NO,                           /* CREATE INTERNAL TRACE */
000054 //      FAILURE=WCONNECT,                   /* ACTION ON PRINTER FAILURE */
000055 //      TIMEOUT=REDRIVE,                     /* PSF ACTION ON TIMEOUT */
000056 //      DISCINTV=0,                          /* DISCONNECT INTERVAL IN SECS. */
000057 //      MGMTMODE=IMMED,                     /* ACTIVATE PRINTER AT STARTUP */
000058 //      IPADDR='192.0.110.21'                /* IP ADDRESS */
000059 //      PORTNO=5001                          /* IP ADDRESS */
000060 //PRT420 ENDCNTL

```

Using IP address 192.0.110.21 and port number 5001

The IP address of the *Xerox 4500 PS TR IPC*(IPDS) should be programmed in the IPADDR statement. The PORTNO 5001 is the default port number of the first IPDS port on the *Xerox 4500 PS TR IPC*(IPDS).

14. SNA IPDS and SCS Printing from MVS or VM

This chapter provides:

- sample LU1 printer logmode definitions for SCS and IPDS print
- sample definitions for installation in association with a locally attached 3174 and 3745
- sample definitions for installation in association with a locally attached 3174 and a downstream OS/2 gateway.
- method of configuring a Novell SAA gateway so as to attach an PS as a PU type 2.
- notes on use of FSL configuration

Once these definitions have been configured, performing direct printing via SNA will be possible.



Requirements:

- Xerox 4500 PS TR (equipped with FSL top) with 3270 code for SCS printing .
- Xerox 4500 PS TR IPC (IPDS) for IPDS printing.

14.1 Logmode

The Xerox 4500 PS TR uses standard IBM LU1 printer logmodes. Please refer to your IBM VTAM documentation for particular configurations that best meet your network requirements. Two sample definitions are listed below:

IPDS printer:	SCS printer:
IPDSPSF1 MODEENT LOGMODE=IPDSPSF1,	RSCSPRT1 MODEENT LOGMODE=RSCSPRT1,
FMPROF=X'03', X	FMPROF=X'03', X
TSPROF=X'03', X	TSPROF=X'03', X
PRIPROT=X'B1', X	PRIPROT=X'B1', X
SECPROT=X'B0', X	SECPROT=X'30', X
COMPROT=X'7080', X	COMPROT=X'7080', X
SRCVPAC=X'02', X	SSNDPAC=X'00', X
RUSIZES=X'85C7', X	SRCVPAC=X'00', X
SSNDPAC=X'00', X	RUSIZES=X'8787', X
PSNDPAC=X'02', X	PSNDPAC=X'80', X
PSEVIC=X'014000010000000001000000'	PSEVIC=X'01000000E10000000000000000'

14.2 PS PU definition for 3174

Sample definition for installation in association with a locally attached 3174.

VTAM definition

```
V1SNA1C2  VBUILD TYPE=LOCAL
*
* LOCAL SNA 3174
*
V1LS1C2  PU      CUADDR=3C3,                      X
                DLOGMOD=D4A32782,                 X
                PACING=3,                          X
                VPACING=3,                          X
                MAXBFRU=10,                         X
                SSCPFM=USSSCS,                      X
                USSTAB=VUSSTAB,                     X
                LOGTAB=VMODETAB,                     X
                MODETAB=VMODETAB
*
* SINGLE TOKEN RING DEVICE WITH ID=40005A0001C2
*
IDS1C2P1  LU      LOCADDR=02,DLOGMOD=RSCSPRT1,PACING=0,MODETAB=RSCSTAB, X
                USSTAB=VUSSTAB1,VPACING=3
```

3174 Definition

```
*****
* LOCAL TOKEN RING DEFINITION 3174
*
* CHANNEL ADDRESS 1C1-1C8
* 3174 /11L Microcode EC=A78831 ML=90095
* Prompt 900 - 400031740001 * Token-Ring Gateway Address
*
* Prompt 940 * Token-Ring Assignment
* C1 - 40005A0001C1
* C2 - 40005A0001C2
* C3 - 40005A0001C3
* Prompt 941 * Token-Ring Address Configuration
* SAP F W
* C1 - 40005A00001C1 4 3 3
* C2 - 40005A00001C2 4 3 3
* C3 - 40005A00001C3 4 3 3
```

PrintServer Definition file extract

```
&&??##N1,0# ; Start of file - Don't remove this !
;-----
; Configuration for the TokenRing PrintServer
; (This is an example. Please modify the parameters to match
; your configuration).
; 00824001
;-----
;*****#*****
;
; I D A P S
;*****#*****
BEGIN_CONFIGURATION IDAPS
LOCAL_MAC 40005A0001C2; Set LOCAL MAC-address
SEL_MAC LOCAL ; Use universal MAC-address
EARLY_TOKEN YES ; Early Token Release DISABLED.
ENABLE_TCPIP YES ; ENABLE TCP/IP protocol.
ENABLE_NETWARE YES ; ENABLE Netware protocol .
ENABLE_802_2 YES ; ENABLE 802.2 protocol .
ENABLE_PU_LU YES ; ENABLE PU/LU protocol.
BOOT YES ; Reboot PS if conf. has changed.
SHARETIMEOUT 20 ; Share timeout (sec.)
HOLDTIMEOUT 600 ; Timeout for OFFLINE condition (sec.)
IRQTIMEOUT 60 ; Timeout for IRQ forwarding (Sec.)
END

;*****#*****
;
; T C P I P
;*****#*****
BEGIN_CONFIGURATION TCPIP
HOSTNAME "idaPS005" ; The TCP/IP host name of the PS
BOOTP NO ; Boot from BOOTP server
TCP_MSS 1400 ; Message Segment Size
TCP_WINDOW 4200 ; Receive window
DEFAULT_IP 192.0.16.12 ; IP-address if not booted by BOOTP
DEFAULT_SM 255.255.0.0 ; Subnet Mask if not booted by BOOTP
DEFAULT_GW 192.0.16.3 ; Gateway addr. if not booted by BOOTP
END

;*****#*****
;
; P U
;*****#*****
BEGIN_CONFIGURATION PU
BLOCKNUMBER 05D ; Fill in your Block number
IDNUMBER 00000 ; Fill in your ID number
REMOTE_MAC 400031740001; Fill in HOST / GW MAC address
LOCAL_SAP 4 ; Fill in your local SAP value
REMOTE_SAP 4 ; Fill in your HOST SAP value
END

&&??
```

14.3 3174 - OS/2 Gateway - PS PU definition

Sample definition for installation in association with a locally attached 3174 and a downstream OS/2 gateway

3174 and OS/2 VTAM definition

```
V1SNA1C3  VBUILD TYPE=LOCAL
*
* LOCAL SNA 3174
*
V1LS1C3  PU      CUADDR=3C3,                                X
                DLOGMOD=D4A32782,                          X
                PACING=3,                                    X
                VPACING=3,                                    X
                MAXBFRTU=10,                                  X
                SSCPFM=USSSCS,                                X
                USSTAB=VUSSTAB,                              X
                LOGTAB=VMODETAB,                              X
                MODETAB=VMODETAB
*
* SINGLE TOKEN RING PC WITH ID=40005A0001C3 TEST'S
*
IDS1C3D0  LU      LOCADDR=02,DLOGMOD=D4A3290,LOGAPPL=VM
IDS1C3P0  LU      LOCADDR=03,DLOGMOD=IPDSL62,PACING=0,MODETAB=RSCSTAB, X
                USSTAB=VUSSTAB1,VPACING=3
IDS1C3P1  LU      LOCADDR=04,DLOGMOD=IPDSL62,PACING=0,MODETAB=RSCSTAB, X
                USSTAB=VUSSTAB1,VPACING=3
IDS1C3P2  LU      LOCADDR=05,DLOGMOD=RSCSPRT1,PACING=0,MODETAB=RSCSTAB, X
                USSTAB=VUSSTAB1,VPACING=3
```

3174 Definition

```
*****
* LOCAL TOKEN RING DEFINITION 3174
*
* CHANNEL ADDRESS 1C1-1C8
* 3174 /11L Microcode EC=A78831 ML=90095
* Prompt 900 - 400031740001 * Token-Ring Gateway Address
*
* Prompt 940 * Token-Ring Assignment
* C1 - 40005A0001C1
* C2 - 40005A0001C2
* C3 - 40005A0001C3
* Prompt 941 * Token-Ring Address Configuration
* SAP F W
* C1 - 40005A00001C1 4 3 3
* C2 - 40005A00001C2 4 3 3
* C3 - 40005A00001C3 4 3 3
```

OS/2 Protocol.ini definitions

[LANDD_nif]

```
DriverName = LANDD$  
Bindings = OLITOKCE_nif  
NETADDRESS = "40005a0001c3"  
ETHERAND_TYPE = "I"
```

OS/2 CM/2 gateway definitions

```
DEFINE_LOCAL_CP FQ_CP_NAME(DKIDTN01.LT)  
                CP_ALIAS(LT)  
                NAU_ADDRESS(INDEPENDENT_LU)  
                NODE_TYPE(EN)  
                NODE_ID(X'05D00000')  
                NW_FP_SUPPORT(NONE)  
                HOST_FP_SUPPORT(YES)  
                HOST_FP_LINK_NAME(HOST0001)  
                MAX_COMP_LEVEL(NONE)  
                MAX_COMP_TOKENS(0);  
  
DEFINE_LOGICAL_LINK LINK_NAME(HOST0001)  
                    ADJACENT_NODE_TYPE(LEARN)  
                    DLC_NAME(IBMTRNET)  
                    ADAPTER_NUMBER(0)  
                    DESTINATION_ADDRESS(X'40003174000104')  
                    ETHERNET_FORMAT(NO)  
                    CP_CP_SESSION_SUPPORT(YES)  
                    ACTIVATE_AT_STARTUP(NO)  
                    LIMITED_RESOURCE(USE_ADAPTER_DEFINITION)  
                    LINK_STATION_ROLE(USE_ADAPTER_DEFINITION)  
                    SOLICIT_SSCP_SESSION(YES)  
                    MAX_ACTIVATION_ATTEMPTS(USE_ADAPTER_DEFINITION)  
                    USE_PUNAME_AS_CPNAME(NO)  
                    EFFECTIVE_CAPACITY(USE_ADAPTER_DEFINITION)  
                    COST_PER_CONNECT_TIME(USE_ADAPTER_DEFINITION)  
                    COST_PER_BYTE(USE_ADAPTER_DEFINITION)  
                    SECURITY(USE_ADAPTER_DEFINITION)  
                    PROPAGATION_DELAY(USE_ADAPTER_DEFINITION)  
                    USER_DEFINED_1(USE_ADAPTER_DEFINITION)  
                    USER_DEFINED_2(USE_ADAPTER_DEFINITION)  
                    USER_DEFINED_3(USE_ADAPTER_DEFINITION);  
  
DEFINE_LOGICAL_LINK LINK_NAME(L1C302)  
                    ADJACENT_NODE_TYPE(LEARN)  
                    DLC_NAME(IBMTRNET)  
                    ADAPTER_NUMBER(0)  
                    DESTINATION_ADDRESS(X'40005A01C30204')  
                    ETHERNET_FORMAT(NO)  
                    ....  
  
DEFINE_GATEWAY_WORKSTATION WORKSTATION_LINK_NAME(L1C302)  
                           WORKSTATION_LU(WORKSTATION_LU_NAME(L1C302)  
                                           HOST_LINK_NAME(HOST0001)  
                                           NAU_ADDRESS_AT_WORKSTATION(2)  
                                           NAU_ADDRESS_AT_HOST(5));
```

PrintServer Definition file extract

```
&&??##N1,0# ; Start of file - Don't remove this!  
;-----  
; Configuration for the TokenRing PrintServer x3  
; (This is an example. Please modify the parameters to match  
; your configuration).  
; 00824001  
;-----  
;*****#*****
```

```

;
;*****#*****
;
;                               I D A P S
;*****#*****
BEGIN_CONFIGURATION IDAPS
LOCAL_MAC      40005A01C302; Set LOCAL MAC-address
SEL_MAC        LOCAL      ; Use universal MAC-address
EARLY_TOKEN    YES        ; Early Token Release DISABLED.
ENABLE_TCPIP   YES        ; ENABLE TCP/IP protocol.
ENABLE_NETWARE YES        ; ENABLE Netware protocol.
ENABLE_802_2   YES        ; ENABLE 802.2 protocol.
ENABLE_PU_LU   YES        ; ENABLE PU/LU protocol.
BOOT           YES        ; Reboot PS if conf. has changed.
SHARETIMEOUT   20         ; Share timeout (sec.)
HOLDTIMEOUT    600        ; Timeout for OFFLINE condition (sec.)
IRQTIMEOUT     60         ; Timeout for IRQ forwarding (Sec.)
END
;*****#*****
;
;                               T C P I P
;*****#*****
BEGIN_CONFIGURATION TCPIP
HOSTNAME       "idaPS0006" ; The TCP/IP host name of the PS
BOOTP          NO         ; Boot from BOOTP server
TCP_MSS        1400       ; Message Segment Size
TCP_WINDOW     4200       ; Receive window
DEFAULT_IP     192.0.16.12 ; IP-address if not booted by BOOTP
DEFAULT_SM     255.255.0.0 ; Subnet Mask if not booted by BOOTP
DEFAULT_GW     192.0.16.3 ; Gateway addr. if not booted by BOOTP
END
;*****#*****
;
;                               P U
;*****#*****
BEGIN_CONFIGURATION PU
BLOCKNUMBER    05D        ; Fill in your Block number
IDNUMBER       12345      ; Fill in your ID number
REMOTE_MAC     40005A0001C3; Fill in HOST / GW MAC address
LOCAL_SAP      4          ; Fill in your local SAP value
REMOTE_SAP     4          ; Fill in your HOST SAP value
END
&&??
```

14.4 PS PU definition for 3745

Sample definition for installation in association with a locally attached 3745.

Logmode

```
PS1xMOD MODETAB
*
*MODE TABLE
*
MODPS1X MODEENT LOGMODE=MODPS1X,FMPROF=X'03',TSPROF=X'03',
    PRIPROT=X'B1',SECPROT=X'B0',COMPROT=X'7080',
    RUSIZES=X'85C6',
    PSNDPAK=X'02',SRCVPAC=X'02,SSNDPAC=X'00',
    PSERVIC=X'014000010000000001000000'
MODEEND
END
```

PU/LU Definitions

```
SPPRKEN VBUILD TYPE=SWNET, SWITHCED MAJOR NODE
    MAXNO=1,
    MAXGRP=1
*    STATOPT='NN PRINTER'
PA01B91 PU ADDR=C1,
    IDBLK=017,
    IDNUM=E2961,
    DISCNT=NO,
    MAXOUT=1,
    MAXDATA= 1033,
    MODETAB=PS1xMOD,
    PACING=7,
    VPACING=7,
    MAXPATH=1,
    PUTYPE=2,
    DLOGMOD=PS1xMOD
*
TA01B911 LU LOCADDR=2,
    DLOGMOD=MODMIO13
```

PSF JCL

```
//PRTN CNTL
//PRTN PRINTDEV FONTDD=*.FONT300,/*FONT LIBRARY DD */
//    OVLYDD=*.OLAY01, /*OVERLAY LIBRARY DD */
//    PSEGDD=*.PSEG01, /*SEGMENT LIBRARY DD */
//    PDEFDD=*.PDEF01, /*PAGEDEF LIBRARY DD */
//    FDEFDD=*.FDEF01, /*FORMDEF LIBRARY DD */
//    JOBHDR=*.JOBHDR, /*JOB HEADER SEPARATOR OUTPUT */
//    JOBTRLR=*.JOBTLR, /*JOB TRAILER SEPARATOR OUTPUT*/
//    DSHDR=*.DSHDR, /*DATA SET HEADER SEPARATOR */
//    MESSAGE=*.MSGDS, /*MESSAGE DATA SET OUTPUT */
//    FORMDEF=A10110, /*DEVICE FORMDEF DEFAULT */
//    PAGEDEF=P06683, /*DEVICE PAGEDEF DEFAULT */
//    CHARS=GT57, /*DEVICE FONT DEFAULT */
```

14.4 Configuring NetWare SAA gateway for direct SNA connection to PS

The following will describe the normal procedures for configuring the PS to a NetWare for SAA Gateway version 2.0. The main advantage for this type of connection is that the print application on the mainframe has direct printer control through VTAM.

NOTE Most NetWare SAA installations use the IPX/SPX protocol as downstream protocol for the workstations. The PS supports the IPX/SPX protocols, but currently **not** for SNA traffic. The downstream protocol for the *Xerox 4500 PS TR* must be 802.2 SNA. If you wish to use the IPX/SPX protocol for downstream printing, you will need a 3270 print emulation package on the NetWare server.

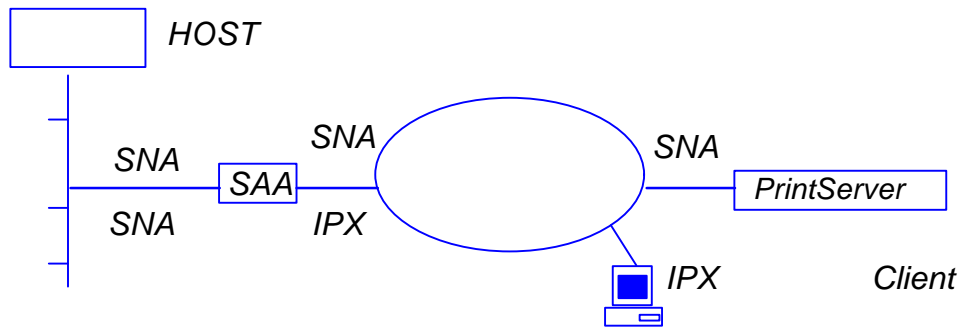

When is a network node or PU **Downstream or Upstream?**

This may cause some confusion, but is important to know when configuring the SAA gateway.

In the above example, the following is true:

1. The host is an upstream node and PU to the SAA gateway.
2. The SAA gateway is a downstream node and PU to the host.
3. The SAA gateway is an upstream node and PU to the *Xerox 4500 PS TR*.
4. The PS is a downstream node and PU to the SAA gateway.
5. The SAA gateway is an upstream node to the NetWare client, but PU definitions are not used on the client since the protocol used is IPX. Other protocols could have been TCP/IP.
6. The NetWare Client is a downstream node to the SAA gateway, but downstream link and downstream PU definitions are not used since the protocol used is IPX.

When configuring the SAA environment, the host will always be an upstream PU and the *Xerox 4500 PS TR* will always be a downstream PU.

The following definitions are based on an assumption that the SAA server is already up and running. If this is not the case, please refer to the appropriate NetWare documentation before proceeding with the following.

1. Log in to the NetWare server running NetWare for SAA as supervisor.
2. Run SYSTEM\CSCON\cscon.exe and choose the appropriate SAA server. It is also possible to configure via SAA Administrator for Windows.

3. Choose **Configure Data Link Adapters**

You will now be able to choose between one or more adapters. Note the name of the adapter that should be used when communicating from the SAA gateway to the *Xerox 4500 PS TR*, i.e. the adapter used for the same physical network as the *Xerox 4500 PS TR* connects to.

If only one adapter is listed, ***you may have to create the missing adapter***. Unless this is done, the *Xerox 4500 PS TR* has to be located on same LAN as the upstream node. In an installation resembling the figure above, this means that the *Xerox 4500 PS TR* can only be found by SAA on the Ethernet side, NOT on the Token Ring side. Names and numbers for network adapters can be found in the autoexec.ncf file on the same server.

The entries look like this:

```
load TOKEN name=TOKEN_IP port=A20 int=2 frame=TOKEN-RING_SNAP
```

```
load 3c5x9 port=300 frame=ETHERNET_802.2 name=ETHER1
```

To create the missing adapter:

- a) Press <Insert>
- b) Type <Name> (i.e. TOKEN) <Enter>
- c) Choose <adapter type> (i.e. Token Ring) <enter>
- d) Type <Number> (note that each adapter needs a separate number)
- e) Press <ESC>
- f) Choose <YES> to create **Data Link Adapter Definition**

4. Choose **Configure for Host Connections**

You can now use an existing PU profile or you can add a new profile. Multiple PU profiles can be active at the same time. This configures the connection to the Host. The following describes the creation of a new PU profile.

- a) Press <Insert>
- b) Enter <New Profile Name> e.g. IDAPROF

- c) Press <Enter> on <Configure default LU attributes>
- d) Select:
 - Dedicated
 - Printer
 - <VTAM LU Name Prefix> (the name defined in VTAM)
 - <Hex> or <Decimal> (system dependant)
 - <ESC>
- e) Enter <Starting dependent LU address>
(Make sure that the number is not already in use by the existing profile)
- f) Enter <Number of dependent LUs>
(This number should reflect the number of *Xerox 4500 PS TR*s that will connect to this SAA gateway. Each *Xerox 4500 PS TR* uses one LU)
- g) Enter the rest of the parameters. They should be copied from the existing PU profile.
- h) **NOTE**
The value for '802.2 Local Service Access Point' must be defined in the *Xerox 4500 PS TR* as 'Remote SAP'.
The value for 'node id' must be defined in the *Xerox 4500 PS TR* as 'Block number' (first three digits) and 'ID number' (last five digits).
- i) Press <ESC> and choose <YES> to create a new PU profile

5. Choose **Configure Downstream PUs**

This is where you actually define each of the *Xerox 4500 PS TR*s to the SAA gateway.
Each *Xerox 4500 PS TR* is considered a PU.

- a) Press <insert>
- b) Enter <downstream PU name> (e.g. ida01)
- c) Enter <downstream LU address> (always 02)
- d) Enter <Number of downstream LUs> (always 1)
- e) Enter <Logical Adapter Name> (the name of the SAA logical adapter that should be used to communicate with the *Xerox 4500 PS TR*. In the above figure it would be the Token Ring adapter. If you have created a new **Data Link Adapter** in step 3), this is the one.
- f) Enter <MAC address> and <802.2 remote node address> (The MAC address of the *Xerox 4500 PS TR*)
- g) Leave the rest of the parameters at default value, press <ESC> and choose <YES> to create a downstream PU.
- h) **NOTE:**
The <802.2 remote service access point> is the 'Local SAP' in the *Xerox 4500 PS TR*.

6. Choose **Configure LUs for Downstream PUs**

- a) Press <enter> on the highlighted line showing: 002 (0x02)
- b) Choose <Host PU profile>

- (If you have created a new PU profile in main step 4) you should choose this one, e.g. IDAPROF. If not, choose the existing PU profile)
- c) Choose the LU to be used by the first *Xerox 4500 PS TR*
 - d) Press <ESC> three times

You have now completed the configuration of the NetWare SAA Gateway. To activate the new configuration, please restart the SAA gateway. This is done by issuing the following command from an RCONSOLE session:

```
unload nwsaa  
load nwsaa
```

In most cases it will also be necessary to restart the SAA gateway in VTAM. This is done by issuing the following commands on the host operator console:

```
V NET,INACT,ID=puname,F  
V NET,ACT,ID=puname
```

Hints

1. Start the cscon.exe program and do the following:

```
choose <configure for host connections>  
choose <configure host PU profiles>  
choose <configure for host connections>  
select the profile for the Xerox 4500 PS TR  
choose <configure dependant LUs>
```

In the panel displayed you should now have the following:

```
002 (0x02) Printer luname No Mapped: puname
```

The luname is the name defined for the VTAM printer, defined in step 6..
The category MUST be 'mapped'
The 'puname' MUST be the name of the downstream PU defined in step 5.
If the above is not true, you need to reconfigure your definitions.
The above information can also be found using CSTATUS.

2. When starting NWSAA, the following message should be on the NWSAA console:

```
3-10-96 22.28.08 NWSAA-7.0-2100BD [SNACP] Informational  
A link definition to remote LLC8022 node 00036e001cfb-04 on adapter  
ETHERNET1 has been opened.  
where
```

00035e001cfb is the MAC address for the *Xerox 4500 PS TR* and
ETHERNET1 is the name of the downstream link.

If the above is not true, you need to reconfigure your definitions.

14.5 FSL Configuration

The FSL top can be configured using FSL from the host.

FSL Configuration

FSL support will be as on the standard i-data PCL platform with the exception of non-relevant coax line functions which will be received but ignored.

Please observe that the LU1 language power-on default value '0' (download language from controller) is not supported. The consequence of this is that the national language has to be set (FSL function Y8).



For details, see the separate file: **FSL_REF.PDF**

15. PSS/MVS AFP Printing Using TCP/IP

This chapter provides:

JES installation statements
PSS Startup Procedure
PSS Printer Profile

Once these parameters have been configured and the basic TCP/IP installation of the *PrintServer* (non-IPDS) has been completed, direct AFP/ICDS from PSS / MVS will be possible.



Requirements:

- use of ida PSS, version 6.01 or higher
- use of TCP/IP for MVS, version 2, release 1

MTU size

Gateway statement for TCP/IP profile

- The Maximum Transmission Unit (MTU) of the IP packet for the MVS system is *recommended* to be set up to 2000.

NOTE: The MTU size should not exceed the maximum size sent through the control unit. Failure may lead to transmission problems.

15.1 Sample PSS/MVS JES2 initialisation statements

```
FSSDEF (PSS4) PROC=PSS4 ,HASPFSM=HASPFSM
```

```
/* From the system PARMLIB  
PRT410 ,CLASS=A ,DRAIN ,MODE=FSS ,ROUTECD= PSS410 ,FSS=PSS4  
PRMODE=( LINE , PAGE ) ,UCS=0 ,WS=( W , R , Q / F )  
  
PRT411 ,CLASS=A ,DRAIN ,MODE=FSS ,ROUTECD= PSS411 ,FSS=PSS4  
PRMODE=( LINE , PAGE ) ,UCS=0 ,WS=( W , R , Q / F )
```

Example of PSS/MVS JES2 printer definition

15.2 PSS printer profile using TCP/IP attachment

```
*TCPIP DEFINITIONS
TCPIP      USER=TCPIP
NAMESRV    IP=192.0.15.0
NAMESRV    IP=192.0.14.1
*-----
* PSS PRINTER DEFINITION FOR USE WITH DIRECT TCP/IP CONNECTION
*-----
PRINTER    PRTID=PRT411, IP=192.0.110.21,
           LOGDD=CONSOLE,
           TIMEOUT=255,
           RETRY=10,
           PORT=5005
*-----
```

Example of PSS printer profile using TCP/IP

The IP address of the *PrintServer* (non-IPDS) should be programmed in the IP statement. The Port no. 5005 is the default port number of the first ICDS port on the *PrintServer* (non-IPDS as well as IPDS) products.

16. PSS/VM AFP Printing Using TCP/IP

This chapter provides:

PSS VM printer profile statements

Once these parameters have been configured, and the basic TCP/IP installation of the *PrintServer* (non-IPDS) has been completed, direct AFP/ICDS from PSS / VM will be possible.



Requirements:

- use of ida PSS, version 6.01 or higher
- use of TCP/IP for VM, version 2, release 2.1

16.1 Sample PSS VM printer profile definition using TCP/IP

```
KEY          KEY=12345678901234567890
CONSLOG      NO
*****TCP/IP DEFINITIONS*****
*
TCPIP        USER=TCPIP
NAMESERV     IP=192.0.15.0
NAMESERV     IP=192.0.15.1
*
*****DEFAULT DEFINITIONS *****
*
DEFAULT      PDELIB=PDEF38PP ,OVLYLIB=OVLY38PP ,
              FONTLIB=FONT300 ,PSEGLIB=PSEG38PP ,
              PDEFLIB=PDEF38PP , COMPRESS ,SCALE ,
              RESOURCE= , FONT=PR12 ,PAGEDEF=DEFAULT ,
              XSIZE=8 ,YSIZE=11 ,XOFFSET=0 ,YOFFSET=0
              HPDEF=P1HEAD ,HFDEF=F1HEAD ,
              TPDEF=P1HEAD ,TFDEF=F1HEAD ,
              BINM=2
\
*****TCP/IP ATTACHMENT*****
*
PRINTER      PRTID=NET022 ,IP=192.0.118.2 ,PORT=5005
*
*****
```

The IP address of the *PrintServer* (non-IPDS) should be programmed in the IP statement. The Port no. 5005 is the default port number of the first ICDS port on the *PrintServer* (non-IPDS as well as IPDS) products.

17. PSF/2 AFP Printing Using TCP/IP

This chapter provides details on how to:

- Create an IPDS printer profile
- Setup the “Keep Alive” TCP/IP feature



Requirements:

Before IPDS printing using TCP/IP can be accomplished, the following points need to be checked:

1. OS/2 2.0 with APAR IR28716 or later version must be installed.
2. TCP/IP 2.0 with CSD UN64092 or later version must be installed
3. PSF/2 1.10 with CSD UR41102 or later version must be installed

Once the above conditions have been met and the basic TCP/IP installation of the *PrintServer* (IPDS) been completed before direct AFP/IPDS from PSF/2 will be possible.

17.1 Creating a new printer profile

From the PSF/2 control panel you make the following selections:

1. Select **Profile**
2. Select **New**

The following panel will appear:

New device

Enter the following information to create a new device:

Device name:

Path:

Description:

Attachment Type

Parallel
TCP/IP

Settings...

Device Resolution:

Create Cancel Help

Create New Profile

3. Enter the **Device Name**
4. Select **Resolution** 240 or 300 according to the resolution of emulation used on the *PrintServer*(IPDS).
5. Select **TCP/IP** in the menu “Attachment Type”
6. Click on **Settings**(see figure in the following)

TCP/IP Settings

IP Address:

TCP/IP Port Number:

Form Definition:

Connect Timeout: sec

OK Reset

Cancel Help

Select Settings

7. Enter **IP Address**
Enter the IP address of the *PrintServer*(IPDS).

8. Select **Port Number**

If the output device is attached to PARALLEL 1 of the print server, then select TCP/IP port number 5001. The value 5002 may also be used. The value chosen must match the value defined for the session in the *PrintServer*(IPDS)

9. Select **OK**

10. Select **Create**

The device created can be used with PSF/2 direct and with PSF/2 DPF printing methods.

17.2 KEEPALIVE support for OS/2

The TCP/IP components in OS/2 offer network attachment for printers. However, these TCP/IP components do not always detect connection failures if a point-to-point session between the OS/2 machine and the device has failed (e.g. in connection with a printer being abruptly powered off). This may result in serious problems for IPDS printers in sessions with PSF/2.

Now, support for the TCP KEEPALIVE facility has been added to the TCP/IP components of OS/2 to detect all communication failures. PSF/2 directs TCP to send a KEEPALIVE transmission on a TCP connection remaining inactive for an extended period. If the KEEPALIVE transmission is not acknowledged, the TCP assumes that the connection partner has been lost and subsequently reports a failure to PSF/2.

The frequency of these transmissions depends on the configuration of the OS/2 TCP/IP environment. The default for OS/2 is two hours or more. This, however, can be adjusted. These values apply to all TCP applications that request KEEPALIVE transmissions.

In the following, you are provided with instructions for using the KEEPALIVE support facility added to the TCP/IP components for OS/2.

17.3 OS/2 KEEPALIVE configuration

The TCP/IP "inetcfg" command can be used to configure the "KEEPALIVE" parameter.

```
inetcfg KEEPALIVE=nnn
```

where nnn is the number of minutes a TCP connection must remain inactive before TCP generates a KEEPALIVE transmission for an application that requests them. Default is 120 minutes.

The inetcfg command must be run each time the OS/2 system is started. Adding the inetcfg command to \tcpip\bin\tcpstart.cmd is a convenient way of automating this step.

Adding, e.g.

```
inetcfg KEEPALIVE=4
```

to \tcpip\bin\tcpstart.cmd causes TCP to send a KEEPALIVE transmission if a TCP connection has been inactive for 4 minutes and the application requested KEEPALIVE transmissions, as OS/2 now does. OS/2 recommends this TCP configuration setting to customers who use TCP/IP attached printers and the device.

If the KEEPALIVE transmission is not acknowledged, the TCP will attempt to re-connect up to 9 times. The interval between these attempts is fixed but short.

18. PSF/AIX Printing Using TCP/IP

This chapter provides details on:

Adding a TCP/IP attached printer
Setup of the KEEPALIVE TCP/IP feature



Requirements

Before IPDS printing using TCP/IP can be accomplished, the following points need to be checked:

1. AIX1.2 with PTF U436937 or later must be installed.

The above conditions must have been met and the basic TCP/IP installation of the *PrintServer*(IPDS) completed before direct AFP / IPDS from PSF/AIX will be possible.

18.1 Adding TCP/IP attached printer

The port number is defined in the PSF/AIX SMIT “ Add a TCP/IP-Attached Printer” panel.

1. Enter **Printer name**
PSF/AIX uses the printer name you specify. Enter a name of up to 8 characters.
2. Enter **Internet address**
The address in the TCP/IP network where the *PrintServer* is installed. Enter a 32-bit dotted decimal notation (e.g. 192.0.2.1).
3. Enter **Port number (5001)**
If the output device is attached to PARALLEL 1 of the print server, then select TCP/IP port number 5001. The value chosen must match the value defined for the session in the *PrintServer*(IPDS). 5001 is the default port number of the first IPDS port no. in the *PrintServer* (IPDS).

18.2 KEEPALIVE support for AIX

The TCP/IP components in AIX offer network attachment for printers. However, these TCP/IP components do not always detect connection failures if a point-to-point session between the AIX machine and the device has failed (e.g. in connection with a printer being abruptly powered off). This may result in serious problems for IPDS printers in sessions with PSF/AIX

Now, support for the TCP KEEPALIVE facility has been added to the TCP/IP components of AIX to detect all communication failures. PSF/AIX directs TCP to send a KEEPALIVE transmission on a TCP connection remaining inactive for an extended period. If the KEEPALIVE transmission is not acknowledged, the TCP assumes that the connection partner has been lost and subsequently reports a failure to PSF/AIX

The frequency of these transmissions depends upon the configuration of AIX TCP/IP environment. The default for AIX is two hours or more. This, however, can be adjusted. These values apply to all TCP applications that request KEEPALIVE transmissions.

In the following, you are provided with instructions for using the KEEPALIVE support facility added to the TCP/IP components for AIX

18.3 AIX KEEPALIVE support

The "**no**" (network options) command can be used by the root user to configure KEEPALIVE frequencies.

```
no -o tcp_keepidle=nnn
```

```
no -o tcp_keepintvl=nnn
```

where nnn is in half-seconds.

The command "**tcp_keepidle**" specifies the interval of inactivity causing the TCP to generate a KEEPALIVE transmission for an application that requests them. The default is 14400 (2 hours).

The command "**tcp_keepintvl**" specifies the interval between the nine retry attempts if a KEEPALIVE transmission is not acknowledged. The default is 150 (75 seconds).

The "no" commands must be run each time the AIX system is started. Adding the "no" commands to /etc/rc.net is a convenient way of automating this step.

Adding e.g.

```
no -o tcp_keepidle=480
```

```
no -o tcp_keepintvl=80
```

to /etc/rc.net causes the TCP to send a KEEPALIVE transmission if a TCP connection has been inactive for 4 minutes and the application requested KEEPALIVE transmissions, as AIX now does. AIX recommends these TCP configuration settings to customers who use TCP/IP attached printers and the device.

To view current settings enter

```
no -a
```

When the installation and configuration procedures for the PSF/AIX have been completed, you are ready for printing.

19. Problem Determination

This chapter describes how to monitor the operations of the *Xerox 4500 PS TR* and how to troubleshoot the supported protocols during installation, configuration, and printing.

19.1 Monitoring tools

The operations of the *Xerox 4500 PS TR* may be monitored using the SNMP (MIB II) or the LEDs on the rear panel.

19.1.1 SNMP support

The *Xerox 4500 PS TR* has been added support for SNMP using TCP/IP as protocol for LAN access. The SNMP operates as a monitoring tool for the *Xerox 4500 PS TR*.

19.1.1.1 What is SNMP

(Source: NMS Management Guide,
Novell ManageWise 2.0)

SNMP (Simple Network Management Protocol) is an application protocol offering network management services in the Internet Protocol suite to operate in connection with installation, configuration and management of the PS.

SNMP defines a client/server relationship. The client program is the connection to the SNMP agent (the PS) which is referred to as the SNMP Management Information Base (MIB). The SNMP implementation in the *Xerox 4500 PS TR* supports the MIB II.

There are, however, exceptions to the extension of MIB II support:

- ⊗ The SET option on different objects (ARP table, ROUTE table, etc.) will not be supported and any attempt to SET the objects will be rejected.
- ⊗ No support for EGP and Transmission Group.

By default the application uses the community string "public" for SNMP GET and SET operations. If the community string used by NMS (Network Management System) does not match the one expected by the SNMP agent in the managed device, the operation fails.

NOTE:

You should be aware that a small amount of knowledge is required for general use the SNMP. It is assumed that you have basic networking knowledge (protocols, addressing, network errors, etc). For more advanced use of SNMP, you are required a substantial amount of knowledge.

19.1.1.2 Preparing for use of SNMP

To use the SNMP, the SNMP related parameters for the *Xerox 4500 PS TR* must be defined using one of the supported configuration tools (see chapter 3).

PS name

Specifies the attached PrintServer.

Contact name:

Specifies the contact person for this managed node.

System location:

Specifies the physical location of this node.

When the parameters have been defined, the operations may be monitored by the system administrator using **any** SNMP browser.

*In the example below we have chosen the **NetGuardian** as the browser.*

This NetGuardian browser is available on the BBS.

The NetGuardian browser runs in Windows 3.1 environment.

19.1.1.3 Using the NetGuardian browser

To install the NetGuardian, change your current drive to where you have placed the netg2b3.zip.

Then type:

```
PKUNZIP -d {source path\netg2b3.zip} {destination path }
```

You have now created a directory containing the NetGuardian program. Run the browse from the Windows Program Manager.

19.1.2 LED Status error messages

The LED status error messages below indicate some problems encountered during printing.

Condition	LED Status		
	LAN	SES	PRT
Unit powered off/ power failure	OFF	OFF	OFF
Ring failure (e.g. Ring not present)	Fast blink	OFF	OFF
No LAN contact (e.g. Boot reply)	Slow blink	OFF	OFF
Printer intervention or error/printed cable removed	ON	OFF	Slow blink on specific LEDs
Bad RAM	OFF	Fading ON OFF	ON OFF
LAN Error	ON ON	Fading ON OFF	ON OFF
Main checksum error (Microcode download needed)	ON ON	Fading ON OFF	ON OFF
Baseblock checksum error (Microcode download needed - Centronics only!)	OFF	Fading ON OFF	ON
DPRAM error (comm. error with IPDS top)	ON OFF	Fading ON OFF	ON OFF
BOOTBLOC checksum error (device needs new FLASH proms)	ON	Fading ON OFF	OFF
Side panel switch in wrong position)	ON ON	ON OFF	ON ON

LED status error messages

19.2 Troubleshooting

This chapter helps you resolve some problems you may encounter when installing, configuring or operating the *Xerox 4500 PS TR*.

To maintain print integrity if the *Xerox 4500 PS TR* is powered off, the attached printer must also be powered off. The printers can be powered off independently of the *Xerox 4500 PS TR*.

19.2.1 When installing

TCP/IP

The following are general guidelines for correcting problems with the installation of the *Xerox 4500 PS TR*.

The functioning of the LEDs on the front panel is described below:

LAN, and PRT LEDs all flash

- Check the connection to the LAN. Reseat the LAN connector.

LAN LED continues to flash

- Check BOOTP server definition (including BOOTPTAB file definitions)
- Check that BOOTP server can be accessed
- Check that the BOOTP server is running.
- Check that the bootfile can be located (by comparing bootp type statement with file location; i.e. path).
- Run the BOOTP server diagnostics (that is using the debug option with the "-d-d-d-d-d" parameters).
- use "-b" option if you have a bridged network.
- The *Xerox 4500 PS TR* and an OS/2 BOOTP daemon can be separated by one or more LAN bridges or IP routers.
- In some cases, the *Xerox 4500 PS TR* and OS/2 BOOTP daemon can also be separated by an IP router. The IP router must be specifically configured to pass certain broadcast frames.

NOTE: With certain IP router implementations, it is not possible to pass BOOTP requests. The *Xerox 4500 PS TR* and the

BOOTP server should therefore not be separated by such router.

LAN LED is lit but PRT LED is not lit

- *AFP printing using TCP/IP*
- check that the port number and IP address used by the PPR (idaPSS, *ida ReRouter*, AS/400, PSF/2, PSF/AIX) are the same as those defined on the *Xerox 4500 PS TR* .

IPDS applications must use port nos. 5001 and 5002
ICDS applications must use port nos. 5005 and 5006

- *Non-AFP printing using TCP/IP*
- check that the IP address used by the host is that defined in the *Xerox 4500 PS TR non-IPDS*

PSF indicated communication errors

- Ensure that a PCL printer is attached and powered on.

Message AIN1048E or 0420-049

PSF cannot link to the printer address.

- Check that port number matches that set up for the *'Xerox 4500 PS TR*.
- Check that your network is operational (e.g. by using the PING command).
- Check that the printer session you are accessing is not already assigned to another host such as PSF/2, PSF/AIX, PSF for S/370-S/390 or PSF/400.

LAN, LEDs is lit, PRT flashes, but no print is produced

- Check that the printer is online.
- Check that a printer intervention is not pending.

Message AIN0029 or 0420-029

- Check that the printer is online.

- Check that a printer intervention is not pending.

PRT LED flashes slowly

- Check that a printer intervention is not pending.
- Check that either a PCL or PostScript printer is attached.

Message AIN1049

Communication failure

- Check that the printer is ready (powered on and on-line).
- Check cabling.

19.2.2 When configuring

The following guidelines help you detect problem areas, particularly when configuring the *Xerox 4500 PS TR*.

BOOTPTAB file errors

You should avoid making the following syntax errors in the bootptab file:

- Line continuation character must be " \ " (i.e. backslash)
- Do not leave out " : " after tag values
- Remember to keep comments on separate lines
(Comment lines are indicated as blank lines, spaces or a number sign (i.e. " # ")).

Does the printer indicate an error message?

(for example status code, alarm and so on)

- Check the connection to the *Xerox 4500 PS TR*.
- Check for printer physical errors (for example paper jam, out of paper, toner out, and so on).

Does the LED status of the Xerox 4500 PS TR appear normal?

- Check for status of the LEDs.

Can you PING the Xerox 4500 PS TR?

- If not, the reason may be that one of the bridges is actually a router. In that case, the Xerox 4500 PS TR and PSF/2-PSF/AIX should have different IP network IDs. PSF2/PSF6000 should have a default router and the Xerox 4500 PS TR should be configured with a gateway address.
- You may also have used an invalid IP address in network.

Refer to the section: "Testing the Xerox 4500 PS TR" for a description of how to "PING".

Are you unable / able to generate a test printout?

Unable:

- Check the connection and the configuration to the BOOTP server.
- Check the status of the attached PCL printer.

Able:

- Check the configuration of PSF/2 or PSF/AIX.
- Check the connection from the Xerox 4500 PS TR to the PSF/2 or PSF/AIX servers.

Have changes been made since the initial installation and configuration of the Xerox 4500 PS TR?

If you suspect that changes have been made to LAN, PSF/2 or PSF/AIX or the bootp server since the initial installation and configuration of the Xerox 4500 PS TR, contact your system administrator.

- Check that the configuration of the bootp server complies with the requirements.

What are the symptoms you have recorded or detected?

Host systems record all errors in an error log file. For additional information, see the documentation for PSF/2, PSF/AIX, *ida PSS*, *ida ReRouter* or *ida IPPC*.

- Have any messages been produced?
- Make a list of all the symptoms you have recorded for subsequent problem determination.

Has an upgrade of microcode been performed?

Successfully

A successful microcode upgrade is indicated on the test printout with a new Version number.

Unsuccessfully

Turn the printer off for a few seconds and back on. If problems persist, revert to the microcode from the bootfile and repeat the upgrade process. Refer to *Appendix B: Microcode Upgrading*.

If the problem persists, refer to your general problem reporting procedures or contact your point of purchase.

19.2.3 When printing

When operating via Win/OS2, you must make sure that the PS is connected.

NetWare:

If you are printing via Novell NetWare you must check that the settings for the PSERVER (EPS) and the NPRINT (ENP) are made correctly.

Make a settings printout to check whether you have configured correctly.

Below are examples of possible error situations and hints as how to remedy the situations.

NOTE:

When printing you should check the connection to the PServer viewing the NetWare menu "Active Connections".

Excerpt from test page with NetWare settings:

```
----- NetWare settings -----  
NEST Component      : 00755.008  
NCP mode            : DS  
Frame Types         : 802.2:YES  SNAP: NO  
Preferred Server    :  
Preferred DS Tree   :  
DS Name Context     :o=IDA  
  
EPS:  
    Mode            : Bindery  
    File Server     : xxxxxxxx  
    Print Server    : xxxxxxxx  
    Bindery Poll Timeout : 15  
    Password usage  : Disabled  
    Pserver State   : Connecting... ← 1)  
                    OR  
                    Running... ← 2)  
  
ENP 1:  
    Mode            : DS  
    File Server     : xxxxxxxx  
    Print Server    : xxxxxxxx  
    Printer Number  : 9  
    Printer State   : Waiting for job ← 3)  
    Share Timeout   : 20 secs  
  
ENP 2:  
    Mode            : Bindery  
    File Server     : xxxxxxxx  
    Print Server    : xxxxxxxx  
    Printer Number  : 0  
    Printer State   : Connecting ← 4)  
                    OR  
                    Session undefined/invalid ← 5)  
  
    Share Timeout   : 20 secs
```

1. **Pserver State: Connecting**

If the test page reports that the state of the PServer is “**Connecting...**” then the PServer has not been configured correctly. Check the configuration and make the necessary changes and amendments.

Possible errors could be:

- A password is configured on the server for this EPS, but may be missing in the *Xerox 4500 PS TR*
- The Preferred Server, File Server or Print Server is not configured correctly.

2. **PServer state : Running.**
“**Running...**”means that the PServer has been configured correctly and is ready to receive print jobs and Nprinters can be attached.
3. **Printer State : Waiting for job**
“**Waiting for job...**”status. The” printer is idle and ready for processing print jobs.
4. **Printer State : Connecting**
“**Connecting...**”There is an error in the configuration of the ENP or the PServer.
Network attachment is achieved.
Verify that the specified PServer is running either as an embedded PServer or externally on a server.
The ENP error can e.g. be:
 - The configuration of the ENP on the NetWare server does not match the one in the *Xerox 4500 PS TR*.
 - The printer number is incorrect or someone else is currently using the very printer

Check the configuration and correct the error(s).
5. **Printer State: Session undefined / invalid**
“**Session undefined / invalid**”indicates that there is no connection to the network for the ENP.
Check the ENP Mode and File Server name.

19.3 Intervention required (IRQ)

The *Xerox 4500 PS TR* supports IRQ - Intervention Required. When the intervention required status message is sent, the print session will be responsible for the recovery action.

To control the printer error conditions, two separate IRQ timers are available:

- IRQ timeout
Used to report printer error / fault conditions to the initiating application
- Hold timeout
Used to report printer hold conditions to the initiating application.

The *Xerox 4500 PS TR* handles the following intervention status conditions:

- Online/Offline - i.e. is the printer Ready?

The IRQ conditions vary, however, depending on the print session. For a description of the differences, see below.

IPDS

Ready?	<ol style="list-style-type: none">1) Intervention conditions that can be reported presently will be supported.2) The HOLD timeout parameter is used to determine when hold conditions are reported to the host.
---------------	--

ICDS

Ready?	<ol style="list-style-type: none">1) The intervention condition is reported to the host. The user is required to perform intervention recovery (i.e. attend to the printer problem). Once the printer is Online, printing will restart from the last checkpoint.2) The HOLD timeout parameter is used to determine when hold conditions are reported to the host.
---------------	--

LPD

Ready?	<ol style="list-style-type: none">1) There will be no response or notification with any intervention condition, i.e. the print data remains pending in the printer (printer appears busy).2) The HOLD timeout parameter is used to determine when hold conditions are reported to the host.
---------------	--

ENP

Ready?	<ol style="list-style-type: none">1) The intervention condition is reported to the host. The user is required to perform intervention recovery (i.e. attend to the printer problem). Once the printer is Online, printing will restart from the last checkpoint.2) The HOLD timeout parameter is used to determine when hold conditions are reported to the host
---------------	---

SCS

Ready?	<ol style="list-style-type: none">1) There will be no response or notification with any intervention condition, i.e. the print data remains pending in the printer (printer appears busy).2) The HOLD timeout parameter is used to determine when hold conditions are reported to the host.
---------------	--

PRT

Ready?	There will be no response or notification with any intervention condition, i.e. the print data remains pending in the printer (printer appears busy).
---------------	---

19.4 Printer errors in front panel

The PCL printer may also display error messages. Try to correct the problem by turning power off for a few seconds and then back on again. If the error message is still displayed, use the following:

Printer may indicate a physical printer intervention message

- Check for pending printer intervention messages, such as paper jam, out of paper, out of toner, and so on.

Printer indicates an error code

- Error codes are printer specific, refer to the printer specific documentation.

19.5 Problem reporting

If you have a problem which you are unable to solve, contact your point of purchase for help. Have the following information available:

- Microcode version number (see the test page for the number)
- Printer type and model
- Product serial number (affixed to the base of the unit)
- Test page
- A short description of the error symptoms
- All error.log files (PSF/2 or PSF/AIX)

APPENDICES

Appendix A: Configuration using setup file

Appendix B: Microcode upgrading

Appendix C: idaSetup

Appendix D: IPDS resident codepages

Appendix E: Test printout

Appendix F: Error messages

Appendix G: List of abbreviations

Appendix H: Selected products for Xerox Printers

Appendix A: Configuration Using Setup File

You should only modify or change the settings via the bootfile for strictly necessary purposes.
Otherwise, you are recommended to use e.g. Telnet. (see the chapter on Configuration)

Appendix A 1: Configuring via parallel port

The default LAN and TCP/IP parameters may be set up via the parallel port.

If this method is used instead of using the configuration file, then the IP default (IP address gateway and subnet mask) must be specified in the configuration file when the *Xerox 4500 PS TR* is set up for the first time.

The configuration file must be sent via the centronics port.

NOTE:

On OS/2 workstations use **IBMNULL** as printer driver

On DOS or Windows use a **Generic /Textprinter** driver only.

1. Select the file you wish to send to the parallel port.
2. In this file you write the following command sequence at the *top* of the file:

```
&&??##N1,0#<CR>
```

3. Type: END
4. To send the file, you write the following at the command prompt.

```
copy <filename> <lpt1>
```

where lpt1 is the PC's centronics port.

5. For the settings to become effective you must either:
 - turn the *Xerox 4500 PS TR* off and on
 - or
 - define the *Xerox 4500 PS TR* to boot from the configuration file

```
Type:  
BEGIN_CONFIGURATION IDAPS  
BOOT  
END
```

6. Make a settings printout to verify the new settings.

Appendix A 2: Configuration file parameters

This appendix describes the entire range of parameters available for programming the *Xerox 4500 PS TR*.

BEGIN_CONFIGURATION IDAPS

LOCAL_MAC

Description: Sets the locally administered MAC address

Range: 0x400000000000 - 0x7FFFFFFFFFFFFF

Default: N/A

SEL_MAC

Description: Selects the universally defined or the locally administered MAC address

Range: LOCAL (0)

UNIVERSAL (1)

Default: UNIVERSAL

EARLY_TOKEN

Description: Enables or disables Early Token Release support.
Only valid for 16 Mbps

Range: NO:Disabled

YES: Enabled

Default: NO

ENABLE_TCPIP

Description: Enables or disables the TCP/IP protocol

Range: NO (0)

YES (1)

Default: YES

ENABLE_NETWORKWARE

Description: Enables or disables NetWare (IPX/SPX) protocols.

Range: NO (0)

YES (1)

Default: YES

ENABLE_802_2

Description: Enables or disables the 802.2 settings

Range: NO (0)

YES (1)

Default: YES

ENABLE_PU_LU

Description: Enables or disables the use of the NetWare (IPX/SPX) protocols.

Range: NO (0)
YES (1)

Default: YES

BOOT

Description: The BOOT parameter causes the *Xerox 4500 PS TR* to compare new and old settings. If the current configuration is identical to the new setting, the latter will become non-operational. If on the other hand the new setting is different from the current, the *Xerox 4500 PS TR* is rebooted immediately.

Range: NO (0)
YES (1)

Default: N/A

SHARETIMEOUT

Description: Sets the share timeout value

Range: 0 - 9999 secs

Default: 20 secs

HOLDTIMEOUT

Description: Sets the hold timeout interval for an Offline condition.

Range: 0 - 9999 secs

Default: 600 secs

IRQTIMEOUT

Description: Sets the IRQ timeout value. Paper Error / Paper out conditions

Range: 0 - 9999 secs

Default: 60 secs

PS_NAME

Description: An administratively assigned name for the managed node. By convention, this is the node's fully qualified domain name.

Range: 255 ASCII characters

Default: --

CONTACT_PERSON

Description: Textual identification of the contact person for this managed node together with information on how to contact this person.

Range: 255 ASCII characters

Default:

LOCATION

Description: The physical location of this node (be it building, floor or office room).

Range: 255 ASCII character

Default:

END

Description: Ends the substate and sets the settings state to HOME state.

BEGIN_CONFIGURATION SESSION

SESSION

Description: Starts definitions for a session. A session contains one INPUT_DEF, one TRANSFORM_SEL and one OUTPUT_DEF (see these descriptions below).

Range: 0-255

Default: N/A

INPUT_DEF

Description: Starts definitions for an input definition. Contains the Session Master type and incarnation (see Incarnation below)

Range: N/A

Default: N/A

TRANSFORM_DEF

Description: Starts definitions for a transformation definition. Contains the Session Transform type and ID (see ID below)

Range: N/A

Default: N/A

OUTPUT_SEL

Description: Starts definitions for output. Contains the Session Slave type and ID.

Range: N/A

Default: N/A

ID

Description: Selects the identification of the settings

Range: 0-255

Default: N/A

PRESENT

Description:

Range:

Default:

BEGIN_CONFIGURATION TCPIP

HOSTNAME

Description: Sets the Host name for the device
Range: String of printable characters
Default: -

BOOTP

Description: Defines the use of a Bootp server
Range: NO (0)
YES (1)
Default: YES

TCP_MSS

Description: Sets the TCP/IP Maximum Segment Size in bytes
Range: 256-4096
Default: 1400

TCP_WINDOW

Description: Sets the TCP/IP Window Size in bytes
Range: 256-8192
Default: 4200

MICROCODE

Description: Defines the path on the Bootp server where a microcode is placed. Used for subsequently download via TFTP.
Range: Fully qualified path without derive assignment. Path must reside on the same drive as the TCP/IP software on the Bootp server.
Default:

DEFAULT_IP

Description: Sets the default IP address
Range: 0.0.0.0 - 255.255.255.255
Default:

DEFAULT_SM

Description: Sets the default Subnet Mask
Range: 0.0.0.0 - 255.255.255.255
Default:

DEFAULT_GW

Description: Sets the default Gateway address
Range: 0.0.0.0 - 255.255.255.255
Default:

BEGIN_CONFIGURATION NETWORK

LSL_FRAME_802_2

Description: Selects 802.2 frametype support

Range: NO (0)
YES (!)

Default: YES

LSL_FRAME_802_SNAP

Description: Selects 802.2 SNAP frametype support

Range: NO (0)
YES (1)

Default: NO

NCP_MODE

Description: Selects NPC mode

Range: DISABLED
BINDERY
DS

Default: DISABLED

NCP_PREFERRED_SERVER

Description: Selects preferred server (*in Bindery mode only*)

Range: ASCII string

Default: -

NCP_PREFERRED_DSTREE

Description: Selects preferred DS tree (*in DS mode only*)

Range: ASCII string

Default: -

NCP_DSNAME_CONTEXT

Description: Selects DS name context (*in DS mode only*)

Range: ASCII string

Default: -

EPS_MODE

Description: Selects EPS mode

Range: DISABLED
BINDERY
DS

Default: DISABLED

EPS_PRINTSERVER

Description: Selects the particular EPS

Range: ASCII string

Default:

EPS_PASSWORD

Description: Selects which password the EPS should use when logging into the fileserver.

Range: ASCII string

Default:

EPS_FILESERVER

Description: Selects which fileserver the EPS logs into.

Range: ASCII string

Default:

EPS_MSG_FILENAME

Description: Selects which msgfile the EPS should use.

Range: ASCII string

Default:

BEGIN_CONFIGURATION IDA 802.2

ALIASNAME

Description: The Alias name of the 802.2 protocol

Range:

Default:

BEGIN_CONFIGURATION PU

BLOCKID

Description: An IBM product specific number

Range: 0 - 4095

Default: 0x05D

IDNUMBER

Description: A binary value which together with Block ID identify a specific station uniquely within a customer network installation.

Range: 0 - 1048575

Default: 0

REMOTE_MAC_ADDR

Description: The MAC address of the remote host

Range: 0x000000000000 - 0xFFFFFFFFFFFF

Default:

REMOTE_SAP

Description: Service Access Point of the remote host

Range: 0x04 - 0xEC, modulus 4

Default: 0x04

LOCAL_SAP

Description: Service Access Point of the device
Range: 0x04 - 0xEC modulus 4
Default: 0x04

BEGIN_CONFIGURATION PPD

PORT_PORT

Description: The TCP/IP port number
Range: 5001, 5002, 5005, 5006
Default: N/A

RESPONSE

Description: Sets the Response timeout. The response timeout is used when a KEEPALIVE message is sent. If the message is not deleted from the socket (sent and TCP acknowledged), before response timeout, the session is assumed interrupted.

Range: 0-9999
Default: 20

KEEPALIVE

Description: Sets the KEEPALIVE timeout. For every KEEPALIVE period, an empty data buffer is sent to the remote node to check whether the connection is still active.

Range: 0 (disabled)
1-9999
Default: 60

BEGIN_CONFIGURATION LPD

LPD_QUEUE

Description: The LPD queue name. This parameter is used for matching the "instream" queue name. For details, see the Begin_Configuration PAR2IN x keyword.

Range: ASCII string
Default:

LPD_AUTOOCR

Description: Specifies the LPD to convert all CR to a CR and LF.

Range: NO (0)
YES (1)
Default: N/A

BEGIN_CONFIGURATION ENPX

PRINTERNUMBER

Description: Selects which printer number to be used. .
Range: 0-255
Default: 0

FILESERVER

Description: Selects which fileserver to attach.
Range: ASCII string
Default: -

PRINTSERVER

Description: Selects which printserver to use.
Range: ASCII string
Default: -

MODE

Description: Selects ENP mode.
Range: DISABLED
BINDERY
DS
Default: DISABLED

SHARETIMEOUT

Description: Sets the sharetimeout value
Range: 0-9999
Default: 20

BEGIN_CONFIGURATION PAR2IN X

INSTREAM_PAR2IN

Description: Specifies the data path for PRT1 and IPDS data.
Range: PRT1 (0)
IPDS (1)
Default: N/A

SHARETIMEOUT

(see description above)

BEGIN_CONFIGURATION TESTPGX

INSTREAM_TESTPG

Description: Specifies the incoming data

Range: BASE (0)
IPDS (1)

Default: N/A

BEGIN_CONFIGURATION IPDS1

IPDS_VP

Description: Selects the IPDS Virtual Printer to be used in the data path.

Range: 1 --> X

Default: N/A

BEGIN_CONFIGURATION SNA_PRINT

INSTREAM_SNA_PRINT

Description:

Range:

Default:

BEGIN_CONFIGURATION ICDS 1

LANGUAGE_SEL

Description: Selects the printer language

Range: POSTSCRIPT (0)
PCL 5 (1)

Default: N/A

AUTOCONFIG

Description: Defines whether the printer should be queried for its configuration.

Range: BASE (Executed by base interface (2))
YES (TRUE, (1))
NO (FALSE, (2))

Default: YES

COLORAFP

Description: Printing with AFP colours.

Range: NO (0)
YES (1)

Default: NO

NOGRAPHICS

Description: Selects whether to send HPGL graphics or bitmaps to the printer.

Range: NO (0)
YES (1)

Default: NO

QUERYPAGES

Description: Defines whether to query for printed pages.

Range: NO (0)
YES (1)

Default: NO

HOLDTIMEOUT

(See description above)

IRQTIMEOUT

(See description above)

DLDTIMEOUT

Description: Deadlock detection used to release forced queries.

Range: -

Default: -

AFPTRAY_DEF 1

Description: Starts definitions for an AFP tray

Range: 0 - 255

Default: N/A

TRAY_SEL

Description: Selects the tray mapping to the printer definition.

Range: 1 255

Default: N/A

MANUAL

Description: Selects the tray for manual feed operation

Range: NO (0)
YES (1)

Default: NO

ENVELOPE

Description: Selects the tray for envelope feed
Range: NO (0)
YES (1)
Default: NO

BEGIN_CONFIGURATION PRINTERX

DUPLEXINSTALLED

Description: Defines whether the attached printer supports
duplex printing
Range: YES (TRUE (!))
NO (FALSE (0))
Default: NO

OFFSETINSTALLED

Description: Used for offset stacker
Range: NO (0)
YES (1)
IIISI (2)
Default: NO

TRAY_DEF X

Description: Starts definition of a printer tray
Range: 1 - 9
Default N/A

PAPER_SEL

Description: Selects the paper type
Range: ASCII string
Default N/A

PAPER_DEF

Description: Starts definition of a paper type
Range: ASCII string
Default N/A

PAPERSOURCE

Description: PCL paper source identifier.
Range: -
Default N/A

PAGEWIDTH

Description: PostScript page size width
Range: -
Default N/A

PAGEHEIGHT

Description: PostScript page size height
Range: -
Default N/A

PAGESIZE

Description: PCL page size identifier
Range: 0-255
Default N/A

PRINTAREAX

Description: Defines X-offset from the left edge of the paper to the printable area. The value is defined in 300 dpi dots.
Range: 0..9999
Default 50

PRINTAREAY

Description: Defines Y-offset from the top edge of the paper to the printable area. The value is defined in 300 dpi dots.
Range: 0..9999
Default 50

PRINTAREAWIDTH

Description: Defines the width (X-extent) of the printable area. The value is defined in 300 dpi dots.
Range: 0..9999
Default 2380 (for A4 paper)

PRINTAREAHEIGHT

Description: Defines the height (Y-extent) of the printable area. The value is defined in 300 dpi dots.
Range: 0..9999
Default 3407 (for A4 paper)

LOGICALPAGEX

Description: Defines X-offset from the left edge of the paper to the printer's logical page. The value is defined in 300 dpi dots.
Range: -999..999
Default 71 (for A4 paper)

LOGICALPAGEY

Description: Defines Y-offset from the top edge of the paper to the printer's logical page. The value is defined in 300 dpi dots.

Range: -999..999

Default: 0

LOGICALPAGEWIDTH

Description: Defines the width (X-extent) of the printer's logical page. The value is defined in 300 dpi dots.

Range: 0..9999

Default: 2338 (for A4 paper)

LOGICALPAGEHEIGHT

Description: Defines the height (Y-extent) of the printer's logical page. The value is defined in 300 dpi dots.

Range: 0..9999

Default: 3507

LANGUAGE_DEF PCL 5

OFFSETREG

Description: Defines the automatic PCL offset registration

Range: YES (0)
IIISI (1)

Default: YES

GMACROS

Description: Selects the use of graphic macros in printer

Range: NO (0)
YES (1)

Default: NO

RASTEROP

Description: Selects PCL ROP3/MC raster operation

Range: NO (0)
YES (1)

Default: NO

PATTERNS

Description: Selects PCL patterns

Range: NO (0)
YES (1)

Default: NO

CTABLES

Description: Selects PCL colour tables
Range: NO (0)
YES (1)
Default: NO

LANGUAGE_DEF POSTSCRIPT

TRAY_DEFX:

INPUTPRIO

Description: PostScript input priority
Range:
Default: N/A

MANUALFEED

Description: PostScript manual feed selection
Range:
Default: N/A

PAPER_DEF: (see description above)

DEFINE SNMP

AUTHEN_TRAPS

Description: Indicates whether the SNMP agent is permitted to generate authentication failure.
Range: DISABLED (0)
ENABLED (1)
Default: ENABLED

TRAP_DEST

Description: Starts the definition for an SNMP TRAP destination. Contains a community name and a destination host.
Range: 0-255
Default: N/A

DEST_HOST

Description: The internet protocol (IP) address of a host (SNMP manager) to receive TRAP messages.
Range: 0.0.0.0 - 255.255.255.255
Default: N/A

TRAP_COMM_NAME

Description: Community name. A unique string of characters used by the manager to recognise and validate the source of the TRAP information. .

Range: 255 ASCII characters

Default: -

ACCESS_AUTH

Description: Starts definition for an SNMP Manager Access Authorisation used for verifying the fact that a host is authorised to request SNMP information from the node. Contains community name, network address, network mask and read/write access. .

Range: 0-255

Default: N/A

AUTH_COMM_NAME

Description: Community name. A Unique string of characters used to verify that a request for SNMP information is valid. The community name is similar to a password.

Range: 255 ASCII characters

Default: -

NETWORK_ADDR

Description: Used for validating access authorisation for the requesting manager.

Range: 0.0.0.0. - 255.255.255.255

Default: N/A

NETWORK_MASK

Description: Used for validating access authorisation for the requesting manager.

Range: 0.0.0.0. - 255.255.255.255

Default: N/A

ACCESS

Description: Allows authorised managers to read or read/write to the management information base on this SNMP agent. .

Range: R (0)
R/W (1)

Default: N/A

Appendix B: Microcode upgrading

The *Xerox 4500 PS TR* supports an online microcode upgrade facility permitting the installation of revised product microcode.

Operation of this facility will be possible in the following ways:

1. Via the TCP/IP boot server
2. Via the centronics port

CAUTION:

- During the initial 20-30 seconds after the microcode download, a failure (power off) will have fatal consequences, because the code will be lost and the previously stored code erased. If this happens, a basic code still remains in the flash to allow redownload of code. But download can then only take place via the parallel port.
- You must always connect printer to PARALLEL port.

Appendix B.1: Upgrading microcode via Parallel port

The *Xerox 4500 PS TR* microcode can be upgraded via the PAR1 port by using a PC containing the microcode in the form of a file.

To download the microcode via the parallel port follow these guidelines:

1. Power printer off.
2. Connect a PC to the parallel port using a centronics cable.
3. Power up the printer. When the session LED is lit, press the TEST key shortly.
4. When the printer generate a test page with the message: "xxx | 5108 Awaiting microcode download", the *Xerox 4500 PS TR* is ready for microcode download.
5. Type the following command at the PC's command-prompt :

```
"copy 0xxxxx.B80 lpt1 /b"
```

where "0xxxxx.B80" is an example of a firmware file.¹

¹ The suffix .B80 may be case sensitive depending on the operating system.

NOTE:

If you are making use of printer drivers in connection with your PC's centronics port, it is important that these drivers are temporarily disabled while you perform the actual microcode download using the "copy"-command. Otherwise the printer drivers may interfere in the microcode image sent to the *Xerox 4500 PS TR* implying serious problems. *You should use a generic/text printer driver when running Windows environment and IBM NULL when running in OS/2.*

6. Pay attention to the LED's on the *Xerox 4500 PS TR* front-panel. These will now blink very quickly - one after the other. This is an indication of the microcode download taking place.
7. After the download process (time will depend on the PC's hardware) the "PRT" LED will stay lit. The remaining LEDs will be off.
8. Your *Xerox 4500 PS TR* has now been equipped with a new microcode.
9. Power the *Xerox 4500 PS TR* printer **off** and back **on** for the new microcode to become effective.
10. Press the test key in order to verify the new microcode level stated on the test printout page.

Appendix B.2: Upgrading Microcode via TCP/IP Boot Server

The microcode can be downloaded to the *Xerox 4500 PS TR* using the TCP/IP protocol TFTP:

1. Customising the BOOTP server data base access file (BOOTPTAB file entry for the device with a bootfile parameter).
2. Customising the bootfile entry (customising the bootfile to indicate the path to the microcode).
3. Power the printer off/on.
4. Validate the update microcode.

Preparing for Microcode Upgrade via TCP/IP

Prerequisites:

- Microcode update file supplied by your i-data distributor
- BOOTP server access (BOOTPTAB file)
- Bootfile (configuration file **<name.cf2>**)

Update process

1. Generate a test printout from the *Xerox 4500 PS TR* by pressing the TEST key. (Ensure that no sessions are active.)
2. Edit the BOOTPTAB file for the *Xerox 4500 PS TR* device address. Add the bootfile parameter, e.g. `bf = /<pathname>/<filename>` (remembering to use the forward slash for the path)

OS/2:

```
xer.tcp.network3.com: sm=255.255.255.0: bf=/tcpip/etc/myfile.cf2:\  
gw=192.0.110.0: ht=6: ha=00036E0004A9: ip=192.0.110.1:
```

AIX:

```
xer.tcp.network3.com: sm=255.255.255.0: bf=/etc/myfile.cf2:\  
gw=192.0.110.0: ht=6: ha=00036E0004A9: ip=192.0.110.1:
```

3. Edit either the configuration file or use the Telnet to change the microcode (Change or add the value for the microcode keyword parameter to indicate the new microcode, pathname, and file.)

NOTE:

- **Do NOT rename the microcode file** (as the filename reflects the microcode version). If it does not have a file type, do not give it one. Renaming the file will cause the *Xerox 4500 PS TR* to hang in a loop.

- On AIX, you must ensure general read access to the microcode file (TFTP users have login "nobody").

The microcode filename has the following format and should not be changed:

095XXYZZ.B80

where

XX represents version

Y represents variant

ZZ represents release no. - generally not stated.

e.g.: 095022.B80

(microcode level 2, xerox product (2))

- Ensure that TFTP read access to this file is allowed.
4. Restart the BOOTP server. The *Xerox 4500 PS TR* checks for new microcode.
 5. Power the *Xerox 4500 PS TR* off and back on again.

NOTE:

A microcode upgrade will only be performed if the name of the microcode file is different from the name of the version currently operating in the *Xerox 4500 PS TR*.

6. "PSX3 | 5108 Awaiting microcode download" message is now printed.
7. During download, the LEDs will be blinking alternately.
8. Now print a Test Page (by pressing Test button) and check that the Version number on the test printout has changed to the new Version (see the following section: "Problem Determination").

Appendix B.3: Problem determination

- **What action do I take if a communication error occurs during the upgrade process?**

If the microcode download fails while you are using the TCP/IP boot server, power the *Xerox 4500 PS TR* off and back on again.

If a baseblock checksum error occurs during microcode download, download via the centronics port is the only way to upgrade the microcode (below is shown LED status if a baseblock checksum error occurs):

Condition	LEDStatus		
	LAN	SES	PRT
Baseblock checksum error (Micro-code download needed, Centronics only)	ON OFF	ON OFF	ON ON

Appendix C: idaSetup - IPDS configuration

idaSetup is a GUI (*graphical user interface*) program developed with the purpose of setting up the wide range of IPDS protocol converters via a PC share port or from a Host.

For details on how to configure the IPDS parameters for the PrintServer using the program *idaSetup*, see the separate documentation for this. The manual is available as an electronic document. See the supplied "Documentation" kit.

Appendix D: IPDS resident codepages

CPGID	GROUP NAME
<i>Decimal</i>	
37	USA/Canada
38	US ASCII-L
256	International #1
260	Canadian French
273	Germany/ Austria
274	Begium
275	Brazil
276	Canada (French)
277	Denmark/Norway
278	Finland/Sweden
280	Italy
281	Japan (English)
282	Portugal
283	Spanish
284	Spain/Latin America
285	United Kingdom
286	Austria/Germany (alt)
287	Denmark/Norway (alt)
288	Finland/Sweden
289	Spain
297	France
361	International Typographic 500
367	EBCDIC ASCII
382	Austria Germany
383	Belgium
384	Brazil
385	Canadian French
386	Denmark Norway
387	Finland Sweden
388	France Luxembourg
389	Italy
390	Japan - Latin
391	Portugal
392	Spain Philippines
393	Spanish Speaking
394	United Kingdom
395	United States
500	International #5
831	Portugal (Alternate)
850	PC Multilingual
870	Latin 2 Multilingual
871	Iceland
1002	DCF REL 2 Compatibility
1003	U. S Text Subset

Appendix E: Test printout

TEST key

Pressing the TEST key on the side panel once generates a settings printout. This test printout consists of six or more pages: The first six pages contain details of device settings and information related to the protocol used (i.e. TCP/IP). The remaining pages contain settings printout for the IPDS or FSL module.

Test PrintoutPages

Xerox 4500 PS TR

General Information

(C) 1996 i-data international a-s
e-mail: i-data@i-data.com
www: www.i-data.com

Base Product version : XXXXXXXX
Main Component Number : 00849.015
Boot Component Number : 80047.001
NEST Component Number : 00755.014

Device Settings

Installed RAM : 1 Mbyte
Installed FLASH : 2 Mbyte
Token Ring speed : 16 Mbps
Early token release :
Universal MAC address : 00036e000A98 (selected)
Local MAC address : 400000000000
Broadcast type : All routes
Share Timeout (secs) : 20
Hold Timeout (secs) : 600
IRQ Timeout (secs) : 60
PS Name :
PS Contact :
PS Location :
LAN Status : Inserted on the ring

TCP/IP Settings

TCP/IP : ENABLED
Host Name :
Bootp : NO
Boot Status : boot default
BootServer : 0.0.0.0
MSS : 1400
Window : 4200
IP address : 129.1.72.10
Subnet Mask : 255.255.0.0
Gateway : 129.1.1.1
Broadcast address : 129.1.255.255
Default IP Address : 129.1.72.10
Default Subnet Mask : 255.255.0.0
Default Gateway : 129.1.1.1

NetWare Settings

NetWare : Disabled
FrameType 802.2 : YES
FrameType SNAP : NO
NCP mode : DS
Preferred server :
Preferred DS Tree :
DS Name Context :
EPS :
EPS mode : disabled
Password specified : NO
Pserver :
File Server :

PU LU Settings

PU LU : Enabled
Block number : 05D
ID number : 0000F
Local SAP : 04
Remote SAP : 04
Remote SAP : 40005A0001C4

ida802.2 Settings

Alias Name :
Association Status : Not associated

SNMP Settings

Authentication Traps : Enabled
Trap Destinations :
Access Authorizations : 1MB PrintServer
(1) Community Name :
Access Rights : Read
Network address : 0.0.0.0
Network Mask : 0.0.0.0

NetBeui Settings

NetBEUI : Enabled
NetBeui Name : IDA000A98
NetBeui GroupName : WORKGROUP

PRINTER 1

Autoconfig : NO
Duplex : YES
Tray 1
PaperType,Descrip : (A4,Upper tray)
PaperSrc,Input Prio : (1,0)
Tray 2
PaperType,Descrip : (A4,Lower tray)
PaperSrc,Input Prio : (4,1)
Tray 3
PaperType,Descrip : (A4,Manual tray)
PaperSrc,Input Prio : (2,)
Tray 4
PaperType,Descrip : (DL,Envelope tray)
PaperSrc,Input Prio : (6,)

PRINTER 2

Duplex : NO

Xerox 4500 PS TR

Description	Session	Status
NetBIOS Printer name : P1_PRINTER_1 Output Destination : PSIO	(NETB_PRINT 1) (PRINTER 1, PSIO)	Active
TCP/IP Port : 5002 PrinterLanguage : ICDS to PCL5 Output destination : PSIO Duplex : YES Graphics Disbaled : NO (AFP.Printer) trays: (1,1) (2,2) (64,4) (100,3)	(PPD 5, 5005) (ICDS 1, PCL5) (PRINTER 1, PSIO)	Not Active No remote hosts
TCP/IP Port : 5006 PrinterLanguage : ICDS to PCL Output destination : Duplex : NO Graphics Disbaled : NO (AFP.Printer) trays: (1,1) (2,2) (64,4) (100,3)	(PPD 6, 5006) ICDS 2, PCL5) (PRINTER 2,)	Not Active No remote hosts
ENP Mode : DS File Server : Print Server : ENP Printer Number : Output destination : PSIO	(ENP 1, Pno 0) (PRINTER 1, PSIO)	Not Active Waiting for job
ENP Mode : DS File Server : Print Server : ENP Printer Number : 1 Output destination :	(ENP 2, Pno 1) (PRINTER 2,)	Not Active Connecting...
LPD Queue : LPDPRT1 Output destination :	(LPD 1, LPDPRT1) (PRINTER 2,)	Not Active
LPD Queue : LPDPRT1ACR Output destination :	(LPD 2, LPDPRT1ACR) (PRINTER 1, PSIO)	Active No Remote Host
LPD Queue : LPDPRT2 Output destination :	(LPD 3, LPDPRT2) (PRINTER 2,)	Not Active No remote hosts
LPD Queue : LPDPRT2ACR Output destination :	(LPD 4, LPDPRT2ACR) (PRINTER 2,)	Not Active No remote hosts
ida802.2 DataStream : NATIVE Output Destination : PSIO	(IDA802_2 1, NATIVE) (PRINTER 1, PSIO)	Active

Then follows the pages listing IPDS and printer settings as well as IPDS resident fonts and codepages. In addition, if equipped with an FSL module, a test print out will be generated stating the settings of the supported FSL functions.

Appendix F: Error messages

The error codes stated below may occur during operation. If you are faced with an error situation, i.e. if a **Fatal** error or an **Error** code occur, you should contact your system administrator or your local i-data distributor for help and assistance.

Valid error levels:

Information
Warning
Error
Fatal Error

<i>Error code</i>	<i>Error level</i>	<i>Description</i>
0x4604	F	Internal logical error
0x4700	E	ICDS scanner error, ICDS command = %x, error code = %x

The error code (E) is a bitmap with the following definition:

		0x01	Data truncated
		0x02	Unsolicited data
		0x04	Lacking parameter
		0x08	Surplus parameter
		0x10	Unknown command
0x4701	E		ICDS driver detected error, ICDS command = %x, error code = %x

The following error codes (E) are defined:

0x00	Driver has been cancelled
0x01	Range check
0x02	Printer lost
0x03	State check
0x04	Sequence check
0x05	Memory exhausted
0x06	Undefined font
0x07	Undefined macro
0x08	Deadlock timeout
0x09	Path error
0x0a	Not supported

0x5002	F	Hardware error in EEPROM
0x5003	F	EEPROM checksum error
0x5004	E	Settings invalid
0x5010	F	Side Panel switch in invalid position
0x5100	F	Checksum error in FLASH (boot block)
0x5101	F	Checksum error in FLASH (base block)
0x5102	F	Checksum error in FLASH (main block)
0x5108	I	Awaiting microcode download
0x5109	I	Awaiting microcode download (bad base block)
0x5110	I	Awaiting microcode download (bad main block)
0x7001	F	RAM error
0x8100	F	DPRAM error
0x8101	F	DPRAM error. (Communication error with IPDS top)
0x8200	E	LAN error
0x9100	W	TFTP error : File doesn't exist
0x9101	W	TFTP error : Couldn't connect to TFTP server
0x9102	W	BOOTP error : Couldn't access BOOTP server
0x9200	E	Microcode download failure
0x9201	E	Microcode error : Bad id string
0x9202	E	Microcode error : Bad boot block checksum
0x9203	E	Microcode error : Bad base block checksum
0x9204	E	Microcode error : Bad main block checksum

Appendix G: List of abbreviations

ARP	Address Resolution Protocol
BOOTP	Bootstrap Protocol
CSD	Corrective Services Diskette
ENP	Embedded Nprinter
EPS	Embedded Print Server
FTP	File Transfer Protocol
ICDS	i-data Compressed Data Stream
ICMP	Internet Control Message Protocol
IP	Internet Protocol
IPDS	Intelligent Printer Data Stream
IRQ	Intervention ReQuired
LED	Light Emitting Diode
LPD	Line Printer Daemon
LPR	Line Printer Requester
MAC	Medium Access Control
IOP	Modular Input / Output
PPD	Page Printer Daemon
PPR	Page Printer Requester
PS	PostScript
PSF	Print Service Facility
PSS	Printer SubSystem
SCS	SNA Character String
SMIT	System Management Interface Tool
SNA	System Network Architecture
TCP	Transmission Control Protocol
TFTP	Trivial File Transfer Protocol
UDP	User Datagram Protocol

Appendix H: Selected products for Xerox printers

Coax	Supported Printers
External	
Xerox LS 3270	Any Xerox decentralized PCL printer
Xerox 3270 C/RS	Any Xerox decentralized PCL printer
Xerox 3270/X C/RS	Any Xerox decentralized XES & PCL printer
Xerox Flex + Xerox 3270 PCL/XES	Any Xerox decentralized XES & PCL printer
External IPDS	
Xerox 3270 IPC C/RS	Any Xerox decentralized PCL printer
Xerox 3270/X IPC C/RS	Any Xerox decentralized PCL printer
Internal	
Xerox 4500/3270	Xerox 4505, 4510, 4517, 4520
Xerox 4030/3270 XES/PCL	Xerox 4030, 4197
Xerox 4213/3270 XES/PCL	Xerox 4213
Internal IPDS	
Xerox 4500/3270 IPC	Xerox 4505, 4510, 4517, 4520
Xerox 4030/3270 IPC	Xerox 4030, 4197
Xerox 4213/3270 IPC	Xerox 4213
Twinax	Supported Printers
External	
Xerox LS 5250	Any Xerox decentralized XES & PCL printer
Xerox 5250 C/RS	Any Xerox decentralized XES & PCL printer
Xerox Flex + Xerox 3x-400 PCL/XES	Any Xerox decentralized XES & PCL printer
External IPDS	
Xerox 5250 IPC C/RS	Any Xerox decentralized PCL printer
Internal	
Xerox 4500/3x-400	Xerox 4505, 4510, 4517, 4520
Xerox 4030/3x-400 XES/PCL	Xerox 4030 and 4197
Xerox 4213/3x-400 XES/PCL	Xerox 4213
Internal IPDS	
Xerox 4500/3x-400 IPC	Xerox 4505, 4510, 4517, 4520
Xerox 4030/3x-400 IPC	Xerox 4030 and 4197
Xerox 4213/3x-400 IPC	Xerox 4213
Token Ring	Supported Printers
External	
Xerox PS TR	Any Xerox decentralized printer
External SCS	
Xerox PS TR 3270	Any Xerox decentralized PCL printer
External SCS/DCA	
Xerox PS TR 5250	Any Xerox decentralized PCL printer
External IPDS	
Xerox PS IPC TR	Any Xerox decentralized PCL printer
Internal	
Xerox 4500 PS TR	Xerox 4505, 4510, 4517, 4520
Internal IPDS	
Xerox 4500 PS TR IPC	Xerox 4505, 4510, 4517, 4520
Ethernet	Supported Printers
External	
Xerox PS ETH	Any Xerox decentralized printer
External SCS	
Xerox PS ETH 3270	Any Xerox decentralized PCL printer
External SCS/DCA	
Xerox PS ETH 5250	Any Xerox decentralized PCL printer
External IPDS	
Xerox PS IPC ETH	Any Xerox decentralized PCL printer
Internal	
Xerox 4500 PS ETH	Xerox 4505, 4510, 4517, 4520
Internal IPDS	
Xerox 4500 PS ETH IPC	Xerox 4505, 4510, 4517, 4520