Xerox Laser Printing Systems Tape Formats Manual

**THE DOCUMENT COMPANY
XEROX**

Version 4
January 1999
600P86176

Xerox Corporation
701 S. Aviation Boulevard
El Segundo, CA 90245

©1999 by Xerox Corporation. All rights reserved.

Copyright protection claimed includes all forms and matters of copyrightable material and information now allowed by statutory or judicial law or hereinafter granted, including without limitation, material generated from the software programs which are displayed on the screen, such as icons, screen displays, looks, etc.

Printed in the United States of America.

Publication number: 600P86176

Xerox®, The Document Company, the stylized X, and all Xerox product names mentioned in this publication are trademarks of Xerox Corporation. Products and trademarks of other companies are also acknowledged.

Changes are periodically made to this document. Changes, technical inaccuracies, and typographic errors will be corrected in subsequent editions.

Notice

This manual describes the characteristics of various tape formats which can be processed by Xerox laser printing systems Operating System Software (OSS). Printer carriage control conventions are also included. The information is organized into chapters by vendor.

Laser safety

WARNING: Use of controls or adjustments, or performances other than specified herein, may result in hazardous radiation exposure.

Xerox laser printing systems are certified to comply with laser performance standards set by the U.S. Department of Health, Education, and Welfare as Class 1 laser products. This is a class of laser products that does not emit hazardous radiation. This is possible only because the laser beam is totally enclosed during all modes of customer operation.

When performing operator functions, laser warning labels may be visible. These labels are to alert and remind the service representative and are placed on or near panels or shields which require a tool for removal. **THE PANELS TO WHICH THESE LABELS ARE FIXED OR NEAR ARE NOT TO BE REMOVED BY ANYONE OTHER THAN A XEROX SERVICE REPRESENTATIVE.**



This label is located inside the left door, on the machine frame just above the directions for clearing a jam in area 4.

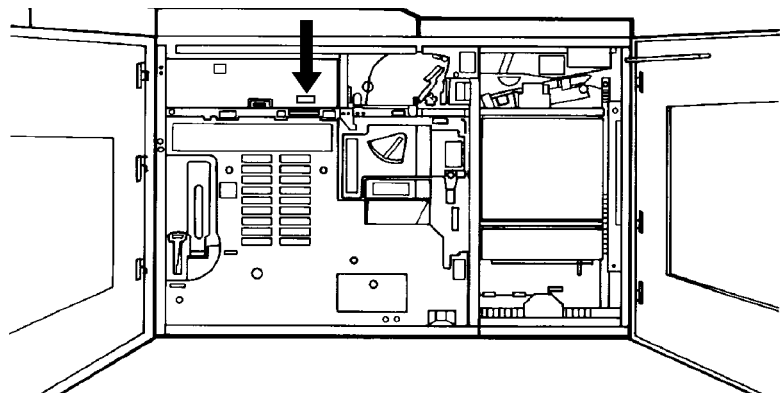

Operation safety

Your Xerox equipment and supplies have been designed and tested to meet strict safety requirements. These include safety agency examination and approval, and compliance with established environmental standards. Attention to the following notes will ensure the continued safe operation of your equipment.

Always connect equipment to a properly grounded power source receptacle. If in doubt, have the receptacle checked by a qualified electrician.



Warning: WARNING: Improper connection of the equipment grounding conductor can result in electrical shock.



Always place equipment on a solid support surface with adequate strength for the weight of the machine.

Always use materials and supplies specifically designed for your Xerox equipment. Use of unsuitable materials may result in poor performance and can possibly create a hazardous situation.

Never move or relocate either the printer or the system controller without first contacting Xerox for approval.

Never use a ground adapter plug to connect equipment to a power source receptacle that lacks a ground connection terminal.

Never attempt any maintenance function that is not specifically described in your operator guide.

Never remove any covers or guards that are fastened with screws. There are no operator-serviceable areas within these covers.

Never override or “cheat” electrical or mechanical interlock devices.

Never use supplies or cleaning materials for other than their intended purposes. Keep all materials out of the reach of children.

Never operate the equipment if unusual noises or odors are noticed. Disconnect the power cord from the power source receptacle and call Xerox service to correct the problem.

If you need any additional safety information concerning the equipment or materials Xerox supplies, call Xerox Product Safety at the following toll-free number:

1-800-828-6571

Related publications

A number of related documents are listed below for your convenience. For a complete list and description of available Xerox documentation, please refer to the Xerox Documentation Catalog (Publication 610P17517) or call the Xerox Document Subscription Service (XDSS) at 1-800-445-5554.

Publication	Number
<i>Xerox Laser Printing Systems Message Guide—Version 3</i>	720P10661
<i>Xerox 4850 HighLight Color Laser Printing System Reference Set</i>	720S90680
<i>Xerox 4850 HighLight Color Laser Printing System Product Guide</i>	720P86211
<i>Xerox 4850 HighLight Color Laser Printing System Applications Guide</i>	720P86231
<i>Xerox 4850 HighLight Color Laser Printing System System Guide</i>	720P86241
<i>Xerox 4850 HighLight Color Laser Printing System System Operator Guide</i>	720P86160
<i>Xerox 4850 HighLight Color Laser Printing System Operations Reference</i>	720P87140
<i>Xerox 4850 HighLight Color Laser Printing System PDL/DJDE Reference</i>	720P87161
<i>Xerox 4850 HighLight Color Laser Printing System Operator Command Summary</i>	720P85990
<i>Xerox 4135 Laser Printing System Product Guide</i>	720P85931
<i>Xerox 4135 Laser Printing System Operator Guide</i>	720P85961
<i>Xerox 4135 Laser Printing System PC User Interface Reference</i>	720P86751
<i>Xerox 4135 Laser Printing System Operations Reference</i>	720P87151
<i>Xerox 4135 Laser Printing System PDL/DJDE Reference</i>	720P87171
<i>Xerox Laser Printing Systems Forms Creation Guide</i>	720P90081
<i>Xerox Laser Printing Systems System Generation Guide</i>	720P90061

*Contact the Xerox Document Subscription Service (XDSS) at 1-800-445-5554 for special ordering instructions.

* *Order directly from the Xerox Systems Institute at 1-408-737-4652.

Table of Contents

Notice	iii
Laser safety	iii
Operation safety	iv
Related publications	v
1. American National Standards Institute (ANSI) labeled tapes	1-1
Tape marks	1-1
Labels	1-1
ANSI labeled tape structures	1-2
VOL1 label	1-7
HDR1, EOVI, EOF1 labels	1-8
HDR2, EOVI, EOF2 labels	1-10
HDR3-9, EOVI-9, EOF3-9 labels	1-11
UVL, UHL, UTL labels	1-11
Block sequence indicator	1-11
Printer carriage control conventions	1-12
ANSI tape JSL sample	1-13
2. IBM OS/360 and DOS/360 standard labeled tapes	2-1
IBM labeled tapes	2-1
OS/360 ANSI labeled tapes	2-1
IBM standard labeled tapes	2-1
VOL1 label	2-5
VOL2 through VOL8 labels	2-5
HDR1, EOVI, EOF1 labels	2-6
HDR2, EOVI, EOF2 labels	2-7
UHL1-8, UTL1-8 labels	2-9
Printer carriage control conventions	2-9
IBM OS and DOS tape JSL sample	2-11
3. IBM DOS/360 GRASP tape organization	3-1
Record format	3-1
Identification segment	3-2
Data records	3-2
Line-up records	3-2
Physical record size	3-2
Sample data block	3-3
GRASP carriage control conventions	3-3

GRASP interspersed block tapes	3-4
POWER and GRASP tapes	3-5
4. IBM DOS/360 POWER II tape organization	4-1
Tape formats	4-1
Block version characteristics (4.0, 4.1, 4.2)	4-1
Version 4.1	4-2
Version 4.2	4-2
Tape format examples	4-3
POWER and GRASP tape JSL sample	4-4
5. IBM POWER/VS and POWER/VSE tape organization	5-1
Tape formats	5-1
File formats	5-1
Data formats	5-2
POWER and GRASP tape JSL sample	5-5
6. UNIVAC Series 70 (US70) magnetic tape organization	6-1
Labeled tapes	6-1
Label groups and sets	6-1
Header label group	6-1
Header label sets	6-2
Volume label	6-2
File header label	6-2
User header label	6-4
Trailer labels	6-4
Trailer label sets	6-5
File trailer labels	6-5
User trailer label	6-6
Tape configurations	6-6
Unlabeled tapes	6-7
Tape marks	6-8
Labeled tapes	6-8
Unlabeled tapes	6-8
Data formats	6-9
US70 labeled and unlabeled tape formats	6-9
Alternate device tapes	6-9
Tape organization	6-9
Carriage control byte	6-10
COBOL print tapes	6-10
Format 1	6-10
Format 2	6-11

	Format 3	6-11
	Format 4	6-11
	US70 printer control conventions	6-11
	Printer control byte	6-12
	Printer carriage control tape	6-13
	UNIVAC tape JSL sample	6-14
7.	Xerox ANSI standard labeled tapes and unlabeled tapes	7-1
	Xerox labeled tapes	7-1
	Control Program-Five (CP-V) and ANSI labeled tapes	7-1
	Unlabeled tapes	7-1
	Nonstandard labels	7-2
	Carriage control conventions	7-3
	Xerox tape JSL sample	7-6
8.	Medium Burroughs system tapes	8-1
	Record format	8-1
	Label types	8-2
	Tape configurations	8-3
	Carriage control conventions	8-3
	Burroughs tape JSL sample	8-5
9.	Large Burroughs system tapes	9-1
	Burroughs labeled tapes	9-1
	Record format	9-1
	Line-up records	9-2
	Carriage control	9-3
	Character set	9-4
	Burroughs tape JSL sample	9-4
10.	Honeywell tapes	10-1
	4 x 3 packed 6-bit character format	10-1
	Honeywell 200/2000 tape formats	10-3
	Honeywell 200/2000 data formats	10-8
	Bannered data format	10-8
	Variable length record format	10-8
	Fixed length record format	10-9
	System print tape data format	10-10
	Honeywell 200/2000 carriage control	10-10
	Honeywell 600/6000 tape formats	10-12
	Honeywell 600/6000 data formats	10-16
	Variable length record format, Honeywell 6000 standard system tapes	10-16

	Data format with embedded control characters, normal edit mode (4 x 3 packed BCD)	10-17
	Single control characters	10-18
	Paired control characters	10-18
	Data format with embedded control characters, normal edit mode (9 x 8 packed ASCII)	10-19
	Single control characters	10-19
	Paired control characters	10-20
	Carriage control (Honeywell 600/6000)	10-21
	Honeywell 2000 and 6000 tape JSL samples	10-23
11.	Univac SDF tape format	11-1
	Univac ASCII character set	11-1
	Control records	11-4
	Print image control record	11-8
	Heading string "H"	11-8
	Setup string "S"	11-9
	Margin string "M"	11-9
	Line string "L"	11-9
	Data records	11-10
	Appropriate JSL coding for Univac tapes	11-11
12.	IBM OS Writer tape organization	12-1
	OS Writer report tape format	12-1
	Job Descriptor Library (JDL) specification	12-2
	Sample report creation under an OS Writer	12-2
	Procedure	12-3
	Steps to creating an OS Writer tape	12-4
	WRITER tape JSL sample	12-5
13.	NCR tapes	13-1
	Carriage control conventions	13-1
	Printer control block codes	13-2
	Function code (F)	13-2
	Graphics code (G)	13-3
	Selective print character (P)	13-3
	Space code (S)	13-3
14.	Undefined tapes	14-1
	File format	14-1
	Data format	14-2
	Undefined tape JSL sample	14-3
15.	DEC PDP-11 tapes	15-1

Tape formats	15-1	
File formats	15-1	
	ANSI labeled tapes	15-3
Data formats	15-3	
	Data structure characteristics	15-3
	Operating system operations	15-4
	FONTINDEX	15-4
	Control codes	15-4
	Points to note	15-5
PDP-11 (RSX) tape JSL sample	15-7	
16. ICL 2900 VME/B tape format	16-1	
	Tape formats	16-1
	Data block formats	16-1
	Carriage control conventions	16-2
	Normal format effectors	16-3
	Embedded format effectors	16-4
	ICL tape JSL sample	16-5
Glossary	GLOSSARY-1	
Index	INDEX-1	

1. American National Standards Institute (ANSI) labeled tapes

The American National Standards Institute has defined standard labeled magnetic tapes in ANSI Standard X3.27—1969. The structure of these tapes is described in the following sections on tape marks and labels.

Tape marks

The tape mark is used on ANSI tapes in the following places:

- Following every file header label group
- Preceding and following the end-of-life label group (a double tape mark follows the last, or only, file on tape)
- Preceding and following the end-of-volume label group (a double tape mark follows the last volume).

Used in the manner described above, the tape mark identifies the boundaries between the data and label groups of a file, and the label groups in consecutive files.

Double tape mark

A double tape mark (two consecutive tape marks) indicates that no further data follows on the tape. A double tape mark also occurs between a header label group and a trailer label group when a file containing no information (a null file) is written. This null file double tape mark is formed by the tape mark following the file header label group and the one preceding the end-of-file label group.

Labels

There are two general classes of labels for ANSI tapes: operating system labels and user labels. Operating system labels are generated and processed by the operating system. User labels are generated and processed by user programs.

Four types of labels

Within these general classes, there are four types of labels, each 80 characters long. They are beginning-of-volume, beginning-of-file, end-of-volume, and end-of-file. The names of the various classes and types of labels are defined in table 1-1.



Note: In user labels, the letter 'a' refers to any of the graphic characters defined in ANSI Standard X3.4-1968.



Table 1-1. ANSI labels

Type	Operating system labels	User labels
Beginning-of-volume	VOL1 (required (Additional VOL labels prohibited))	UVL1 to UVL9 (optional)
Beginning-of-file	HDR1 (required) HDR2 to HDR9 (optional)	UHLA (optional; unlimited number allowed)
End-of-volume	EOV1 (required) EVO2 to EOVS9 (optional)	UTL1a (optional; unlimited number allowed)
End-of-file	EOF1 (required) EOF2 to EOF9 (optional)	UTL1a (optional; unlimited number allowed)

The beginning-of-volume label identifies the volume and its owner and is often referred to as a volume label. Other labels are called "file labels" and are either header labels (if they precede the file) or trailer labels (if they follow the file).

The Xerox/OSS can process four tape configurations:

- Single file, single volume
- Single file, multiple volume
- Multiple file, single volume
- Multiple file, multiple volume.

ANSI labeled tape structures

The locations of the types and classes of labels in these configurations are shown in figures 1-1, 1-2, and 1-3. Figure 1-1 shows ANSI labeled tape structure when no optional labels are used.

Figure 1-2 shows ANSI labeled tape structures with end-of-file (EOF) and end-of-volume (EOV) marks coinciding.

- In general, the pattern shown in option 1, figure 1-2, occurs when the end-of-tape reflective strip is reached while writing the last block of a file. Usually, the operating system does not yet know that this is the last block, and the EOV label group is recorded at this time.
- On the other hand, the pattern shown in option 2, figure 1-2, occurs when the reflective strip is reached after the EOF label group has been started.
- The pattern shown in option 3, figure 1-2, permits the initiation of any file within a file set at the beginning of a volume. When this configuration is used, the block count (field 12) of the end-of-volume label is undefined. File sets are not terminated by an end-of-volume label group.

Structures with optional labels

Figure 1-3 shows ANSI labeled tape structure when optional labels are used. Optional operating system and user labels are used to structure files, as follows, without otherwise modifying the relationship between the required labels and files.

- Optional operating system labels of a given type follow a required label of the same type.
- User labels of a given type directly follow a consecutive group of operating system labels of the same type. When no optional operating system labels are used in the label group, the user labels directly follow a required label of the same type.
- There are no tape marks within a group of labels.
- Every label is completed on the volume where the first label of a group was reached.

Figure 1-1. ANSI labeled tape structure

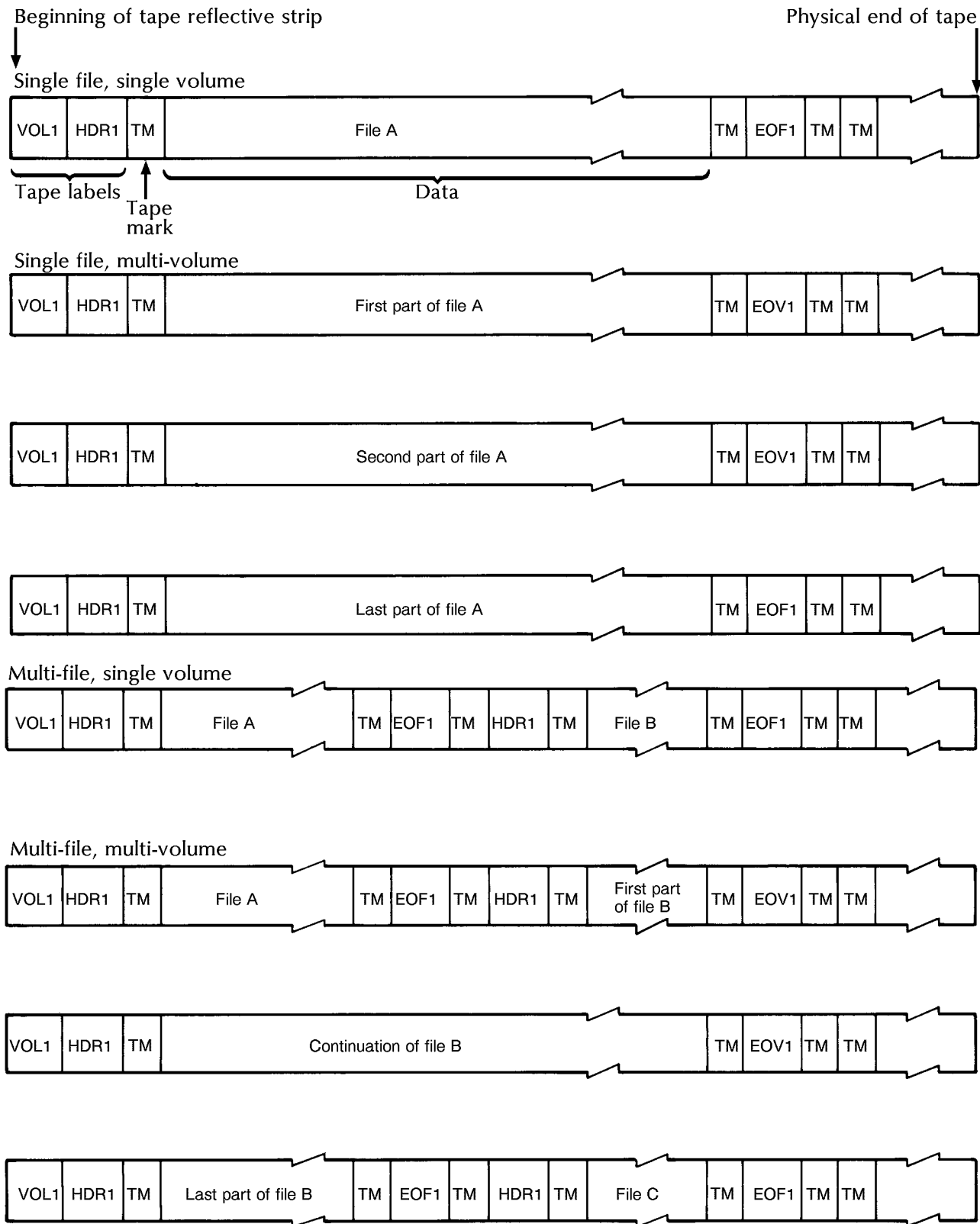
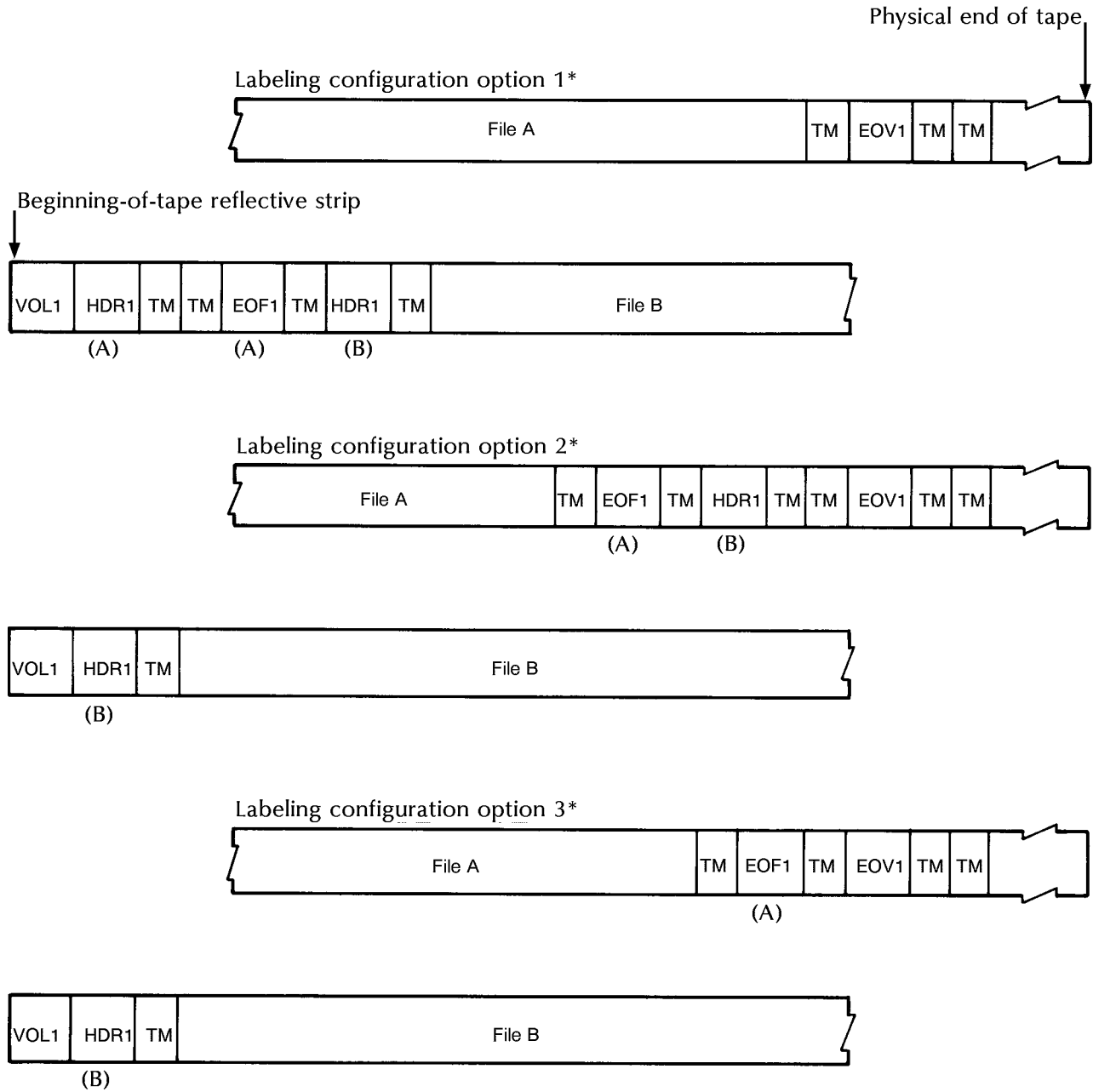
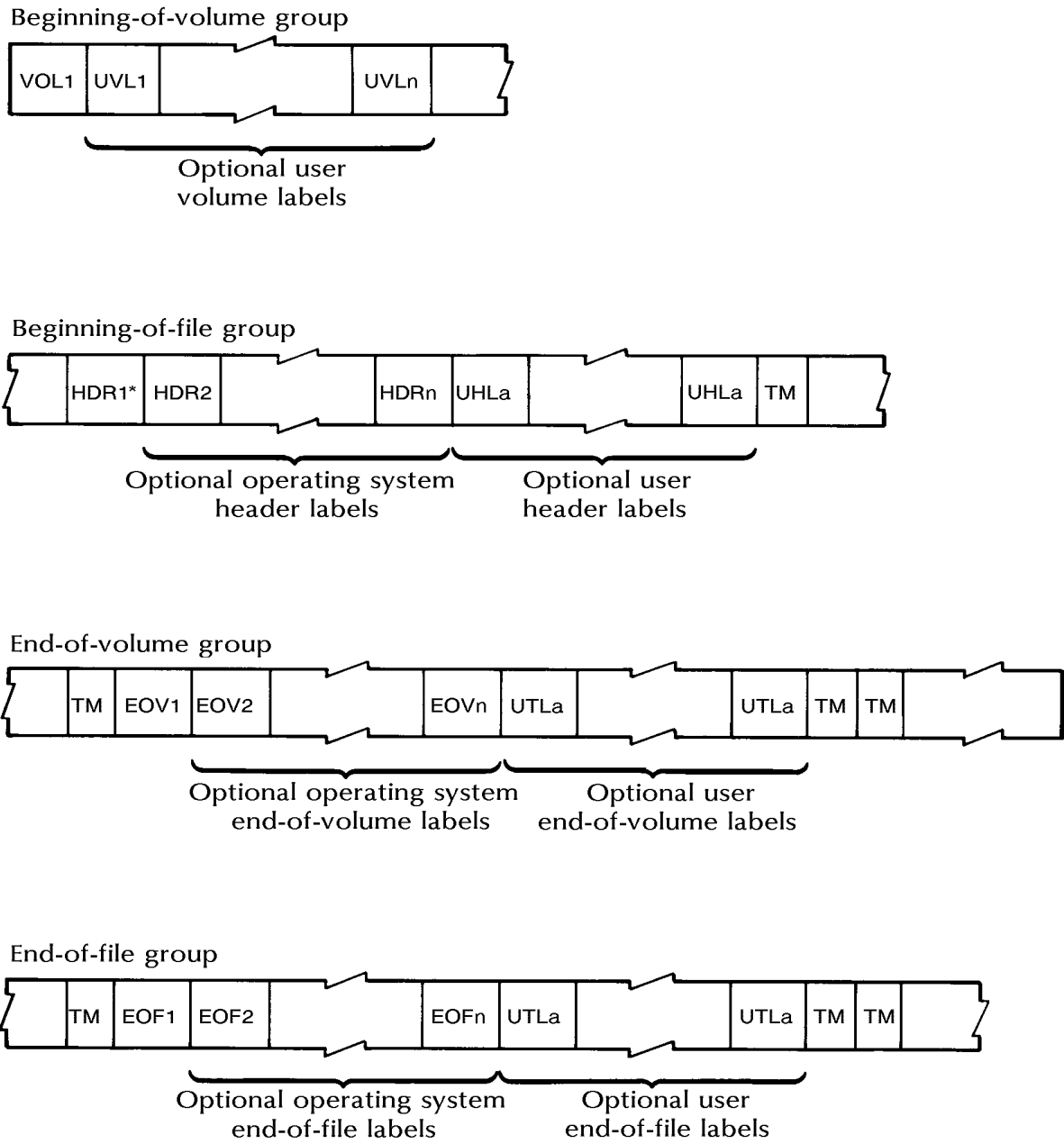

Figure 1-2. ANSI labeled tape structure-assuming coincident end-of-life and end-of-volume where a continuation volume exists



* If end-of-volume and end-of-file coincide, the labeling configuration is as shown above. The letters (A) and (B) indicate to which file the labels belong. These tapes assume no optional operating system or user labels are used

Figure 1-3. ANSI label groups with optional labels



* For the first file on a volume, HDR1 immediately follows the last volume label without an intervening tape mark.



Note:

1. The letter "a" refers to any of the graphic characters defined in the ANSI Standard X3.4—1968.
2. The letter "n" refers to a number 2 through 9.



VOL1 label

The VOL1 label must appear as the first block on every ANSI labeled tape and in no other position. It provides the identification for a particular reel of tape. No other label is permitted whose identifier (first three characters) is VOL. The VOL1 label is described in table 1-2.

Table 1-2.VOL1 label (ANSI tapes)

Name	Character position(s)	Field	Description
Label identifier	1-3	1	This is the 3-character identifier VOL.
Label number	4	2	This is the number 1.
Volume serial —number	5-10	3	This is a 6-character code assigned by the owner to identify this reel (physical volume) of tape. These characters must be those defined in ANSI Standard X3.27—1969 as “a” characters.
Accessibility	11	4	This is an access code. Any of the characters specified for the volume serial number may be used. A space means unlimited access; any other character means special handling.
Reserved	12-31	5	Spaces.
Reserved	32-37		Spaces.
Owner identification	38-51	8	This is an owner identification code composed of characters defined in ANSI Standard X3.27—1969 as “a” characters.
Reserved	52-79	8	Spaces.
Label standard level	80	9	This is a standard level code. A number 1 indicates that the labels and data formats on this volume conform to ANSI Standard X3.27—1969. A space indicates that they do not.

HDR1, EOVI, EOF1 labels



Note: The formats and contents of these labels are identical except for the block count. The formats are shown in table 1-3.



Table 1-3.HDR1, EOVI, and EOF1 labels (ANSI) tapes

Name	Character position(s)	Field	Description
Label identifier	1-3	1	This is the 3-character identifier HDR, EOVI, or EOF.
Label number	4	2	This is the number 1.
File identifier	5-21	3	This may be made up of any of the characters defined in the ANSI Standard X3.27—1969 as “a” characters.
Set identification	22-27	4	This identifies the set of files to which this belongs and may be any of the characters defined in the ANSI Standard X3.27—1969 as “a” characters. The identification is the same for all files of a multi-file set.
File section number*	28-31	5	This number is 0001 for the first header label of each file. This applies to the first or only file on a volume and to subsequent files on a multi-file volume. The field is incremented by 1 on each subsequent volume of the file.
File sequence number	32-35	6	This is a 4-digit numeric field that specifies the sequence number of files within the volume or set of volumes. Within all the labels for a given file, this field contains the same number.
Generation number (optional)	36-39	7	This is a 4-digit numeric field that specifies the sequence number of files within the volume or set of volumes. Within all the labels for a given file, this field contains the same number.
Generation version (optional)	40-41	8	This is a 2-digit numeric field that specifies successive iterations of the same generation. The generation version number of the first attempt to produce a file is 00.
Creation date	42-47	9	This consists of a space, followed by two numeric digits for the year, followed by three numeric digits for the day (001 to 365) within the year.
Expiration date	48-53	10	This field has the same format as field nine. An “expired” file is one in which today’s date is equal to, or later than, the date given in this field. If this condition is satisfied, the remainder of this volume may be overwritten. To be effective on multi-file volumes, the expiration date of a file must be less than or equal to the previous “expire from” date of all previous files on the volume.

* Fields 3, 5, and 12 are used by the operating system.

Table 1-3.HDR1, EOVI, and EOF1 labels (ANSI) tapes (continued)

Name	Character position(s)	Field	Description
Accessibility	54	11	This indicates any restriction on who may have access to information in this file and may be any one of the characters defined in the ANSI Standard X3.27—1969 as “a” characters. A space indicates unlimited access; any other character indicates special handling.
Block count*	55-60	12	For HDR1, this field contains zeros. For EOVI and EOF1, it is a 6-digit numeric field specifying the number of data blocks (exclusive of labels and tape marks) since the preceding HDR group.
System code (optional)	61-73	13	This is a 13-character field specifying the operating system that recorded this file. Any of the characters defined in ANSI Standard X3.27—1969 as “a” characters may be used
Reserved	74-80	14	Spaces

* Fields 3, 5, and 12 are used by the operating system.

The *HDR1 label* is required for all files and for continuation of files on succeeding reels. It identifies the file and contains operating system information that relates to the file.

The *EOVI* label is required following the last data block on a tape when the file or file set is continued on a succeeding tape. It is separated from the last data block by the tape mark that must precede every end-of-volume label group.

The *EOF1* label is required following the last data block of every file. It is separated from the last data block by the tape mark that must precede every end-of-file group.

HDR2, EO2, EOF2 labels

These labels are optional. EOF2 and EO2 may be formatted differently by different operating systems.

The *HDR2 label* is optional but is provided automatically by some operating systems. When used, it must directly follow HDR1. HDR2 generally provides data relating to the physical parameters of the recorded file, including record format, record length, and block length. Table 1-4 describes the format of HDR2 labels.

Table 1-4. HDR2, EO2, and EOF2 labels (ANSI tapes)

Name	Character position(s)	Field	Description
Label identifier	1-3	1	This is the 3-character identifier HDR, EO2, or EOF.
Label number	4	2	This is the number 2.
Record format*	5	3	F = fixed length. D = variable length with the number of characters in the record specified in decimal. U = undefined length.
Block length*	6-10	4	This specifies the maximum number of characters per block and is a 5-digit numeric field. For Burroughs large systems ANSI format, this field represents Burroughs' words (6 characters per word) rather than a character count.
Record length*	11-15	5	This specifies record length if record format is F, maximum record length including any count fields if record format is D or V, or undefined if record format is undefined. Record length is a 5-digit numeric field.
Reserved for operating systems	16-49	6	This field may have any of the characters defined in the ANSI Standard X3.27—1969 as "a" characters.
Block attribute* (IBM only)	50	7	In the HDR2 label for IBM labels only, this field is the block attribute.
Buffer offset*	51-52	8	This is a 2-digit numeric field specifying the character length of any additional field inserted before a data block (e.g., block length). This length is included in block length (field 4).
Reserved	53-80	9	Spaces

* Fields 3, 4, 5, 7, and 8 are used by the operating system.

The *EO2 label* is optional and is provided automatically by some operating systems. When used, it must directly follow EO1. In some operating systems, EO2 is identical to HDR2. Table 1-4 describes the format of these labels. In other operating systems, EO2 has the format described in table 1-5. (Refer to next section.)

The *EOF2 label* is optional but is provided automatically by some operating systems. When used, it must follow EOF1 directly. In some operating systems, EOF2 is identical to HDR2. Table 1-4 describes the format of these labels. In other operating systems, EOF2 has the format described in table 1-5. (Refer to next section.)

HDR3-9, EOVS-9, EOF3-9 labels

These operating system labels are optional. The formats of the labels are shown in table 1-5.

Table 1-5.HDR3-9, EOVS-9, EOF3-9 labels

Name	Character position(s)	Field	Description
Label identifier	1-3	1	This is the 3-character identifier HDR, EOVS, or EOF.
Label number	4	2	This is a 1-digit number from 3 to 9.
Operating system option	5-80	3	This field may have any of the characters defined as "a" characters in ANSI Standard X3.37—1969.

*In some operating systems, EOF2 and EOVS2 may use this format.

UVL, UHL, UTL labels

These are optional user labels. Their format is described in table 1-6.

Table 1-6.UVL, UHL, and UTL labels (ANSI tapes)

Name	Character position(s)	Field	Description
Label identifier	1-3	1	This is the 3-character identifier UVL, UHL, or UTL.
Label name	4	2	For UVL, this may be a number from 1 to 9. For UHL and UTL, this may be any of the characters defined in ANSI Standard X3.27-1969 as "a" characters.
User option	5-80	3	This may be any character defined in ANSI Standard X3.27-1969 as "a" characters.

Block sequence indicator

Tapes recorded with the optional block sequence indicator referred to by the appendix of the ANSI Standard X3.27—1969 cannot be printed.

Printer carriage control conventions

The ANSI control characters for IBM tapes are shown in table 1-7.

Table 1-7. ANSI control characters for IBM tapes

Hexadecimal control characters			
USASCII GRAPHIC	USASCII TAPES	EBCDIC TAPES	Control function
blank	20	40	Space one line before printing.
0	30	F0	Space two lines before printing.
-	2D	60	Space three lines before printing.
+	2B	4E	Suppress space before printing.*
1	31	F1	Skip to channel 1 and print.
2	32	F2	Skip to channel 2 and print.
3	33	F3	Skip to channel 3 and print.
4	34	F4	Skip to channel 4 and print.
5	35	F5	Skip to channel 5 and print.
6	36	F6	Skip to channel 6 and print.
7	37	F7	Skip to channel 7 and print.
8	38	F8	Skip to channel 8 and print.
9	39	F9	Skip to channel 9 and print.
A	40	C1	Skip to channel 10 and print.
B	42	C2	Skip to channel 11 and print.
C	43	C3	Skip to channel 12 and print.

*A record with a write-type control character immediately followed by a record with the "Write (no space)" control character will be processed according to the job descriptor entry option selected for overprint handling.

The processing parameters for ANSI carriage control are as follows.

ANSI	
INITIAL	BOF
DEFAULT	(OVR,SP1P)
ADVTAPE	YES
MASK	X'FF'
ASSIGN	See values in table 1-7

ANSI tape JSL sample

Figure 1-4. JSL sample for IBM OS, DOS, ANSI, WRITER tapes.

```

IBMRC: JDL;                                000010
/*                                          */ 000020
/* SYSTEM TO PRINT IBM OS STANDARD AND DOS STANDARD */ 000030
/* LABELED TAPES, IBM ANSI LABELED TAPES, IBM OS */ 000040
/* WRITER TAPES, AND US70 (RCA) LABELED TAPES. */ 000050
/*                                          */ 000060
V1: VFU ASSIGN=(1,5), ASSIGN=(2,10), ASSIGN=(3,15), 000070
      ASSIGN=(4,20), ASSIGN=(5,25), ASSIGN=(6,30), 000080
      ASSIGN=(7,35), ASSIGN=(8,40), ASSIGN=(9,45), 000090
      ASSIGN=(10,50), ASSIGN=(11,55), ASSIGN=(12,60), 000100
      TOF=5, BOF=66; 000110
/*                                          */ 000120
/* VFU FOR OS WRITER WITH CHANNEL 9 ASSIGNED TO LINE 66 */ 000130
/*                                          */ 000140
WR: VFU ASSIGN=(1,5), ASSIGN=(2,10), ASSIGN=(3,15), 000150
      ASSIGN=(4,20), ASSIGN=(5,25), ASSIGN=(6,30), 000160
      ASSIGN=(7,35), ASSIGN=(8,40), ASSIGN=(10,45), 000170
      ASSIGN=(11,50), ASSIGN=(12,60), ASSIGN=(9,66), 000180
      TOF=5, BOF=66; 000190
/*                                          */ 000200
      VOLUME HOST=IBMOS, LABEL=STANDARD, CODE=EBCDIC, PLABEL=YES; 000210
      LINE DATA=(1,132), PCCTYPE=ANSI, PCC=(0,NOTRAN), 000220
      OVERPRINT=(MERGE,NODISP), VFU=V1; 000230
      ACCT USER=(BIN,TRAY); 000240
/*                                          */ 000250
/* CATALOG FOR OS VARIABLE BLOCKED TAPES */ 000260
/*                                          */ 000270
OSVB: CATALOG; 000280
      BLOCK LENGTH=2660, PREAMBLE=4, LTHFLD=2, FORMAT=BIN; 000290
      RECORD LENGTH=136, PREAMBLE=4, STRUCTURE=VB, 000300
      LTHFLD=2, OFFSET=0, FORMAT=BIN; 000310
/*                                          */ 000320
/* CATALOG FOR OS WRITER TAPES */ 000330
/*                                          */ 000340
OS: CATALOG; 000350
      VOLUME HOST=OSWTR, OSCHN=9, OSTLP=0, OSHDP=1, 000360
      PLABEL=YES; 000370
      BLOCK LENGTH=2400, PREAMBLE=4, LTHFLD=2, FORMAT=BIN; 000380
      RECORD LENGTH=136, PREAMBLE=4, STRUCTURE=VB, 000390
      LTHFLD=2, FORMAT=BIN; 000400
      LINE DATA=(1,132), PCCTYPE=ANSI, PCC=(0,NOTRAN), 000410
      OVERPRINT=(MERGE,NODISP), VFU=WR; 000420

```

```

/*                                          */ 000430
/*          CATALOG FOR UNIVAC SERIES 70    */ 000440
/*          (FORMERLY RCA)                  */ 000450
/*                                          */ 000460
US:CATALOG;
    VOLUME  HOST=US70, LABEL=STANDARD, PLABEL=YES;    000480
    BLOCK   LENGTH=1330, PREAMBLE=0;                 000490
    RECORD  LENGTH=133, STRUCTURE=FB;                000500
    LINE    DATA=(1,132), PCCTYPE=US70, PCC=(0,NOTRAN),
            OVERPRINT=(MERGE,NODISP), VFU=V1;        000510
/*                                          */ 000520
/*                                          */ 000530
/*          IBM OS/DOS STANDARD LABELED TAPES    */ 000540
/*          -----                            */ 000550
/*                                          */ 000560
/*          THE FOLLOWING JDES PROVIDE SUPPORT FOR IBM OS STANDARD */ 000570
/*          AND IBM DOS STANDARD LABELED TAPES    */ 000580
/*                                          */ 000590
/*          CHARACTERISTICS                      JOB      */ 000600
/*          -----                            -----    */ 000610
/*          OS STANDARD LABELS, 1403 PCC          1        */ 000620
/*          OS STANDARD LABELS, 1401 PCC          3        */ 000630
/*          OS STANDARD LABELS, ANSI PCC          2        */ 000640
/*          OS STANDARD LABELS, NO PCC            4        */ 000650
/*          DOS STANDARD LABELS, 1403 PCC        5        */ 000660
/*          DOS STANDARD LABELS, ANSI PCC        6        */ 000670
/*          DOS STANDARD LABELS, 1401 PCC        7        */ 000680
/*          DOS STANDARD LABELS, NO PCC          8        */ 000690
/*          OS STANDARD LABELS, 1403 PCC          1        */ 000700
/*          OS STANDARD LABELS, ANSI PCC          2        */ 000710
1:JOB  INCLUDE=(OSVB);
    VOLUME  HOST=IBMOS, LABEL=STANDARD, CODE=EBCDIC;    000720
    LINE    PCCTYPE=IBM1403;                            000730
2:JOB  INCLUDE=(OSVB);
    VOLUME  HOST=IBMOS, LABEL=STANDARD, CODE=EBCDIC;    000740
    LINE    PCCTYPE=ANSI;                               000750
3:JOB  INCLUDE=(OSVB);
    VOLUME  HOST=IBMOS, LABEL=STANDARD, CODE=EBCDIC;    000760
    LINE    PCCTYPE=IBM1401;                            000770
4:JOB  INCLUDE=(OSVB);
    VOLUME  HOST=IBMOS, LABEL=STANDARD, CODE=EBCDIC;    000780
    LINE    PCCTYPE=IBM1401;                            000790
5:JOB  INCLUDE=(OSVB);
    VOLUME  HOST=IBMOS, LABEL=STANDARD, CODE=EBCDIC;    000800
    LINE    PCCTYPE=IBM1401;                            000810
6:JOB  INCLUDE=(OSVB);
    VOLUME  HOST=IBMOS, LABEL=STANDARD, CODE=EBCDIC;    000820
    LINE    PCCTYPE=NONE;                               000830
7:JOB  INCLUDE=(OSVB);
    VOLUME  HOST=IBMOS, LABEL=STANDARD, CODE=EBCDIC;    000840
    LINE    PCCTYPE=IBM1403;                            000850
8:JOB  INCLUDE=(OSVB);
    VOLUME  HOST=IBMOS, LABEL=STANDARD, CODE=EBCDIC;    000860
    LINE    PCCTYPE=IBM1403;                            000870
9:JOB  INCLUDE=(OSVB);
    VOLUME  HOST=IBMOS, LABEL=STANDARD, CODE=EBCDIC;    000880
    LINE    PCCTYPE=ANSI;                               000890
10:JOB INCLUDE=(OSVB);
    VOLUME  HOST=IBMOS, LABEL=STANDARD, CODE=EBCDIC;    000900
    LINE    PCCTYPE=ANSI;                               000910
11:JOB INCLUDE=(OSVB);
    VOLUME  HOST=IBMOS, LABEL=STANDARD, CODE=EBCDIC;    000920
    LINE    PCCTYPE=IBM1401;                            000930
12:JOB INCLUDE=(OSVB);
    VOLUME  HOST=IBMOS, LABEL=STANDARD, CODE=EBCDIC;    000940
    LINE    PCCTYPE=IBM1401;                            000950
13:JOB INCLUDE=(OSVB);
    VOLUME  HOST=IBMOS, LABEL=STANDARD, CODE=EBCDIC;    000960
    LINE    PCCTYPE=NONE;                               000970
14:JOB INCLUDE=(OSVB);
    VOLUME  HOST=IBMOS, LABEL=STANDARD, CODE=EBCDIC;    000980
    LINE    PCCTYPE=NONE;                               000990
15:JOB INCLUDE=(OSVB);
    VOLUME  HOST=IBMOS, LABEL=STANDARD, CODE=EBCDIC;    001000
    LINE    PCCTYPE=NONE;                               001010
16:JOB INCLUDE=(OSVB);
    VOLUME  HOST=IBMOS, LABEL=STANDARD, CODE=EBCDIC;    001020
    LINE    PCCTYPE=NONE;                               001030
17:JOB INCLUDE=(OSVB);
    VOLUME  HOST=IBMOS, LABEL=STANDARD, CODE=EBCDIC;    001040
    LINE    PCCTYPE=NONE;                               001050
18:JOB INCLUDE=(OSVB);
    VOLUME  HOST=IBMOS, LABEL=STANDARD, CODE=EBCDIC;    001060
    LINE    PCCTYPE=NONE;                               001070
19:JOB INCLUDE=(OSVB);
    VOLUME  HOST=IBMOS, LABEL=STANDARD, CODE=EBCDIC;    001080
    LINE    PCCTYPE=NONE;                               001090
20:JOB INCLUDE=(OSVB);
    VOLUME  HOST=IBMOS, LABEL=STANDARD, CODE=EBCDIC;    001100
    LINE    PCCTYPE=NONE;                               001110
/*                                          */ 001100

```

```

/*
/*          IBM ANSI LABELED AND OS WRITER TAPES
/*          -----
/*
/*    THE FOLLOWING JDES PROVIDE SUPPORT FOR IBM ANSI LABELED
/*    TAPES AND OS WRITER TAPES.
/*
/*          CHARACTERISTICS                JOB
/*          -----                -----
/*
/*    ANSI LABELS, ASCII CODE, ANSI PCC      21
/*    ANSI LABELS, ASCII CODE, NO PCC        22
/*    OS WRITER, ANSI PCC                     23
/*    OS WRITER, 1403 PCC                     24
21:JOB;
VOLUME  HOST=IBMOS, LABEL=ANSI, CODE=ASCII, LCODE=ASCII;
LINE    PCCTYPE=ANSI;
22:JOB;
VOLUME  HOST=IBMOS, LABEL=ANSI, CODE=ASCII, LCODE=ASCII;
LINE    PCCTYPE=NONE;
23:JOB  INCLUDE=(OS);
VOLUME  HOST=OSWTR;
LINE    PCCTYPE=ANSI;
24:JOB  INCLUDE=(OS);
VOLUME  HOST=OSWTR;
LINE    PCCTYPE=IBM1403;
/*
/*          US70 (RCA) STANDARD LABELED TAPES
/*          -----
/*
/*    JDES 41 AND 42 PROVIDE SUPPORT FOR US70 (FORMERLY RCA)
/*    STANDARD LABELED TAPES.
/*
41:JOB  INCLUDE=(US);
VOLUME  HOST=US70, LABEL=STANDARD;
END;END;

```

```

*/ 000960
*/ 000970
*/ 000980
*/ 000990
*/ 001000
*/ 001010
*/ 001020
*/ 001030
*/ 001040
*/ 001050
*/ 001060
*/ 001070
*/ 001080
*/ 001090
001110
001120
001130
001140
001150
001160
001170
001180
001190
001200
001210
001220
*/ 001230
*/ 001240
*/ 001250
*/ 001260
*/ 001270
*/ 001280
*/ 001290
001300
001310
001320

```

2. IBM OS/360 and DOS/360 standard labeled tapes

This chapter describes the standard labeled tapes for the IBM OS/360 and DOS/360.

IBM labeled tapes

The Xerox/OSS accepts any of the following IBM 360 9-track tapes:

- ANSI labeled tapes created under OS/360
- OS/360 standard labeled tapes
- DOS/360 standard labeled tapes
- Nonstandard unlabeled tapes whose data files conform to the record format, blocking factor, and carriage control requirements as described within this section.

OS/360 ANSI labeled tapes

ANSI labeled tapes created under OS/360 conform to ANSI Standard X3.27—1969. These tapes always have the HDR2, EOF2, and EOVS labels.

The EOF2 and EOVS labels are always identical to the HDR2 and the actual count in EOF2 and EOVS. The recording code for both labels and data files is ASCII.

IBM standard labeled tapes

OS/360 and DOS/360 standard labeled tapes are similar in principle to ANSI labeled tapes but differ enough in detail to require separate processing. The labels created by these operating systems and, optionally, by users, are shown in table 2-1. The location of these labels in the various tape configurations are illustrated in figures 2-1 and 2-2.

Table 2- 1. IBM OS/360 and DOS/360 tape labels

Type	Class and originator		
	OS/360	DOS/360	User (optional)
Beginning-of-volume	VOL1	VOL1	OS: None permitted DOS:VOL2—VOL8.
Beginning-of-file	HDR1, HDR2	HDR1	UHL1—UHL8
End-of-volume	EOV1, EOV2	EOV1	UTL1—UTL8
End-of-file	EOF1, EOF2	EOF1	UTL1—UTL8

Table 2-2 shows the principal differences between IBM standard labeled tape structures and ANSI tape structures.

Figure 2-1. IBM labeled tape structure

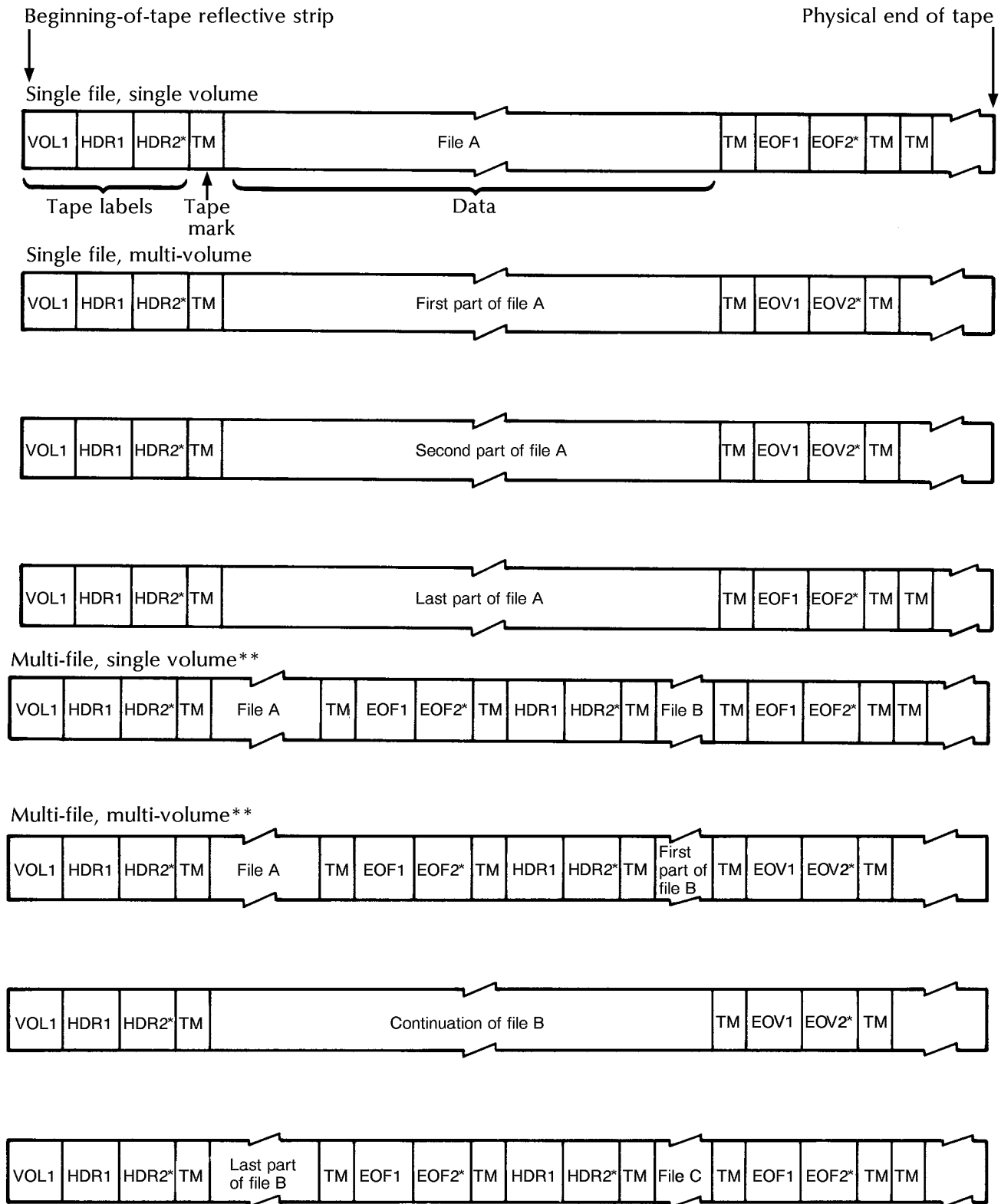

- * HDR2, EOVS2, and EOF2 are provided under OS/360 but not under DOS/360. Note that optional labels are not shown.
- ** Multiple file tapes created under DOS/360 must be created with the DTF TPMARK = NO specification to avoid incorrectly placing two tape marks between files.

Table 2- 2. **ANSI and IBM labeled tape structure**

Feature	ANSI labels	IBM OS/360 standard labels
Tape marks	A double tape mark follows the last EOF or EOVS label group on a tape to indicate the end of recorded data on the tape.	A double tape mark follows only the last EOF label group on a tape. This indicates that end of recorded data has been encountered, and there is not a continuation reel.
VOL	VOL1 only.	OS:VOL1 only DOS:VOL1 provided. VOL2-9 permitted.
UVL	1-9 allowed.	None allowed
HDR, EOF, EOVS	1 required; 2-9 optional.	OS:1 and 2 provided. DOS:1 provided; additional labels not used.
UHL, UTL	These are limited only by the 63 USASCII graphics available as "a" characters for the label "number."	Only UHL 1-8 allowed.
Recorded code	USASCII	EBCDIC

Figure 2-2. IBM standard label groups

Beginning-of-volume group



Optional under DOS/360 only.
Not available under OS/360.

Beginning-of-file group



Optional user header labels

End-of-volume group

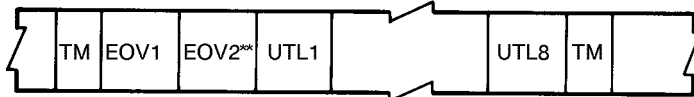

Optional user trailer labels

End-of-file group



Optional user trailer labels

The second tape mark is used only if this EOF label group terminates the last or only file on this volume.

* For the first file on a volume, HDR1 immediately follows the last volume label without an intervening tape mark.

** HDR2, EOVI, and EOF2 are created by OS/360 but not DOS/360.

VOL1 label

This label is always the first record on a tape. The format is described in table 2-3.

Table 2- 3. **VOL1 label (IBM tapes)**

Name	Character position(s)	Field	Description
Label identifier	1-3	1	This is the 3-character identifier VOL.
Label number	4	2	This is the number 1.
Volume serial number	5-10	3	This is an identification code assigned to the volume when it enters the system.
Reserved	11	4	Zero.
VTO pointer (direct access only)	12-21	5	Blanks.
Reserved	22-31	6	Blanks.
Reserved	32-41	7	Blanks.
Owner name and address code	42-51	8	This identifies the owner of the volume.
Reserved	52-80	9	Blanks.

VOL2 through VOL8 labels

These labels are optional under DOS/360 and are bypassed by the Xerox/OSS.

HDR1, EOVI, EOF1 labels

The formats of these labels are identical except for block count. The formats are shown in table 2-4.

Table 2- 4. **HDR1, EOVI, and EOF1 labels (IBM tapes)**

Name	Character position(s)	Field	Description
Label identifier	1-3	1	This is the 3-character identifier HDR, EOVI, or EOF.
Label number	4	2	This is the number 1.
File identifier*	5-21	3	These are the rightmost 17 bytes of the file name and includes GnnnVnn if part of a generation data group.
File serial number	22-27	4	This is the volume serial number of the tape volume containing the file.
Volume sequence number*	28-31	5	This number (0001-9999) indicates the order of the volume within the multi-volume group created at the same time.
File sequence	32-35	6	This number (0001-9999) indicates the relative position of the file within a multi-file group.
Generation number	36-39	7	This field contains a number from 0000 to 9999 indicating the absolute generation number if the file is part of a generation data group (the first generation is 0000).
Version number	40-41	8	This field contains a number from 00 to 99 indicating the version number of the generation if the file is part of a generation data group (the first version is 00).
Creation date	42-47	9	This is the year and day the file was created and is of the form: byydd b = blank yy = year (00-99) ddd = day (001-366)
Expiration date	48-53	10	This is the year and day when the file may be scratched or overwritten. The data is of the same form as described for creation date
File security	54	11	0 means no security. 1 means security protection; additional ID of file required before it can be read, written, or deleted. 3 means security protection; additional ID of file required before it can be read, written, or deleted.
Block count*	55-60	12	This is the number of data blocks in the file on the current volume (exclusive of labels and tape marks). For HDR1, this field contains zeros.
System code	61-73	13	This code identifies the system.
Reserved	74-80	14	Blanks.

*Fields 3, 5, and 12 are used by the operating system.

The *HDR1 label* is always the first beginning-of-file label. When the file is the first on the tape, the HDR1 label immediately follows the last VOL label without an intervening tape mark. When the file is not the first on the tape, HDR1 is the first block following the tape mark that followed the previous end-of-file label group. The HDR1 label is created by both OS/360 and DOS/360.

The *EOV1 label* is always the first (or only) label following the last data block on a tape when a file is continued on a succeeding tape. It is separated from the final data block by a tape mark.

The *EOF1 label* is always the first (or only) label following the last data block of a file. It is separated from the final data block by a tape mark.

HDR2, EOV2, EOF2 labels

The formats of these labels are identical and are described in table 2-5. Only HDR2 labels are processed. EOV2 and EOF2 are bypassed.

Table 2- 5. **HDR2, EOV2, and EOF2 labels (IBM tapes)**

Name	Character position(s)	Field	Description
Label identifier	1-3	1	This is the 3-character identifier HDR, EOV, or EOF.
Label number	4	2	This is the number 2.
Record format*	5	3	This is an alphabetic character that indicates the format of the records in the associated file. The characters are: F = fixed length. V = variable length. U = undefined length.
Block length*	6-10	4	This is a binary number (up to 32,764) that indicates the block length in bytes. Format F—Must be an integral multiple of record length (field 5). Format V—Indicates maximum block length in file, including the 4-byte length field. Format U—Indicates maximum block length.
Record length*	11-15	5	This is a number that indicates record length in bytes. Format F—Indicates actual record length. Format V—Indicates maximum record length in file, including the 4-byte length field. Format U—Zeros.
Tape density	16	6	This is a code that indicates the recording density of the tape. 2 = 800 bpi 3 = 1600 bpi

* Fields 3, 4, 5, and 12 are used by the operating system.

Table 2- 5. **HDR2, EOVS2, and EOF2 labels (IBM tapes)**
(continued)

Name	Character position(s)	Field	Description
File position	17	7	This is a code that indicates a volume switch. 0 indicates no volume switch has occurred; 1 indicates a volume switch has occurred.
Job/job step identification	18-34	8	This is an indication of the job/job step that created the file.
Tape recording technique	35-36	9	This is either a code for 7-track tapes or blanks for 9-track tapes.
Printer control character	37	10	This is a code indicating whether a control character set was used to create the file, and the type of control characters used: A = ANSI control characters. M = machine control characters. blank = no control characters.
Reserved	38	11	Blank.
Block attribute*	39	12	This is a code indicating the block attribute used to create the file. The codes are: B = blocked records. S = spanned records. R = blocked and spanned records. blank = not blocked and not spanned records.
Reserved	40-80	13	Blanks.

* Fields 3, 4, 5, and 12 are used by the operating system.

The *HDR2 label* is always created by OS/360 and immediately follows HDR1 on OS/360 standard labeled tapes. It is not created by DOS/360. The HDR2 label provides data relating to the physical parameters of the recorded file such as record format, record length, and block length.

The *EOVS2 label* is always created by OS/360 and immediately follows EOVS1 on OS/360 standard labeled tapes. It is not created by DOS/360.

The *EOF2 label* is always created by OS/360 and immediately follows EO1 on OS/360 standard labeled tapes. It is not created by DOS/360.

UHL1-8, UTL1-8 labels

These are optional user labels and are bypassed by the Xerox/OSS. Their formats are described in table 2-6.

Table 2- 6. **UHL and UTL labels (IBM tapes)**

Name	Character position(s)	Field	Description
Label identifier	1-3	1	This is the 3-character identifier UHL or UTL.
Label number	4	2	This is a number from 1 to 8.
User option	5-80	3	Specified by user

The *UHLn labels* immediately follow HDR2 for OS/360 and HDR1 for DOS/360.

The *UTLn labels* immediately follow EOVS for OS/360 and EOVS for DOS/360.

Printer carriage control conventions

The Xerox/OSS accepts IBM 1401 "Emulation" control characters, IBM 1403 "Machine" control characters, and IBM ANSI control characters.

Table 2- 7. **IBM 1401 emulation control codes**

Code (hexadecimal)	1401 function	Code (hexadecimal)	1401 function
E1	Print, space 1 line.	D1	No print, space 1 line.
E2	Print, space 2 lines.	D2	No print, space 2 lines.
E3	Print, space 3 lines.	D3	No print, space 3 lines.
C1	Print, skip to channel 1.	F1	No print, skip to channel 1.
C2	Print, skip to channel 2.	F2	No print, skip to channel 2.
C3	Print, skip to channel 3.	F3	No print, skip to channel 3.
C4	Print, skip to channel 4.	F4	No print, skip to channel 4.
C5	Print, skip to channel 5.	F5	No print, skip to channel 5.
C6	Print, skip to channel 6.	F6	No print, skip to channel 6.
C7	Print, skip to channel 7.	F7	No print, skip to channel 7.
C8	Print, skip to channel 8.	F8	No print, skip to channel 8.
C9	Print, skip to channel 9.	F9	No print, skip to channel 9.
C0	Print, skip to channel 10.	F0	No print, skip to channel 10.
4B	Print, skip to channel 11.	7B	No print, skip to channel 11.
4C	Print, skip to channel 12.	7C	No print, skip to channel 12.

Table 2- 8. IBM 1403 emulation control codes

Code (hexadecimal)	1403 function	Code (hexadecimal)	1401 function
01	Write (no automatic space)*	0B	Space 1 line immediately.
02	Write and space 1 line after printing.	13	Space 2 line immediately.
11	Write and space 2 line after printing.	1B	Space 3 line immediately.
19	Write and space 3 line after printing	8B	Skip to channel 1 immediately.
89	Write and skip to channel 1 after printing.	93	Skip to channel 2 immediately.
91	Write and skip to channel 2 after printing.	9B	Skip to channel 3 immediately.
99	Write and skip to channel 3 after printing.	A3	Skip to channel 4 immediately.
A1	Write and skip to channel 4 after printing.	AB	Skip to channel 5 immediately.
A9	Write and skip to channel 5 after printing.	B3	Skip to channel 6 immediately.
B1	Write and skip to channel 6 after printing.	BB	Skip to channel 7 immediately.
B9	Write and skip to channel 7 after printing.	C3	Skip to channel 8 immediately.
C1	Write and skip to channel 8 after printing.	CB	Skip to channel 9 immediately.
C9	Write and skip to channel 9 after printing.	D3	Skip to channel 10 immediately.
D1	Write and skip to channel 10 after printing.	DB	Skip to channel 11 immediately.
D9	Write and skip to channel 11 after printing.	E3	Skip to channel 12 immediately.
E1	Write and skip to channel 12 after printing.	03	No operation.

*A record with a write-type control character immediately preceded by a record with the "Write (no automatic space)" control character is processed according to the option selected for overprint handling.

The processing parameters for IBM 1401 and IBM 1403 carriage control are as follows:

	IBM 1401	IBM 1403
INITIAL	TOF	TOF
DEFAULT	(OVR,PSPI)	(OVR,PSPI)
ADVTAPE	YES	NO
MASK	X'FF'	X'FF'
ASSIGN	See values in table 2-7	See values in table 2-8.

IBM OS and DOS tape JSL sample

The following figure provides a JSL sample.

Figure 2-3. JSL sample for IBM OS, DOS, ANSI, WRITER tapes.

```

IBMRC: JDL;                                000010
/*                                          */ 000020
/* SYSTEM TO PRINT IBM OS STANDARD AND DOS STANDARD */ 000030
/* LABELED TAPES, IBM ANSI LABELED TAPES, IBM OS */ 000040
/* WRITER TAPES, AND US70 (RCA) LABELED TAPES. */ 000050
/*                                          */ 000060
V1: VFU ASSIGN=(1,5), ASSIGN=(2,10), ASSIGN=(3,15), 000070
      ASSIGN=(4,20), ASSIGN=(5,25), ASSIGN=(6,30), 000080
      ASSIGN=(7,35), ASSIGN=(8,40), ASSIGN=(9,45), 000090
      ASSIGN=(10,50), ASSIGN=(11,55), ASSIGN=(12,60), 000100
      TOF=5, BOF=66; 000110
/*                                          */ 000120
/* VFU FOR OS WRITER WITH CHANNEL 9 ASSIGNED TO LINE 66 */ 000130
/*                                          */ 000140
WR: VFU ASSIGN=(1,5), ASSIGN=(2,10), ASSIGN=(3,15), 000150
      ASSIGN=(4,20), ASSIGN=(5,25), ASSIGN=(6,30), 000160
      ASSIGN=(7,35), ASSIGN=(8,40), ASSIGN=(10,45), 000170
      ASSIGN=(11,50), ASSIGN=(12,60), ASSIGN=(9,66), 000180
      TOF=5, BOF=66; 000190
/*                                          */ 000200
      VOLUME HOST=IBMOS, LABEL=STANDARD, CODE=EBCDIC, PLABEL=YES; 000210
      LINE DATA=(1,132), PCCTYPE=ANSI, PCC=(0,NOTRAN), 000220
      OVERPRINT=(MERGE,NODISP), VFU=V1; 000230
      ACCT USER=(BIN,TRAY); 000240
/*                                          */ 000250
/* CATALOG FOR OS VARIABLE BLOCKED TAPES */ 000260
/*                                          */ 000270
OSVB: CATALOG; 000280
      BLOCK LENGTH=2660, PREAMBLE=4, LTHFLD=2, FORMAT=BIN; 000290
      RECORD LENGTH=136, PREAMBLE=4, STRUCTURE=VB, 000300
      LTHFLD=2, OFFSET=0, FORMAT=BIN; 000310
/*                                          */ 000320
/* CATALOG FOR OS WRITER TAPES */ 000330
/*                                          */ 000340
OS: CATALOG; 000350
      VOLUME HOST=OSWTR, OSCHN=9, OSTLP=0, OSHDP=1, 000360
      PLABEL=YES; 000370
      BLOCK LENGTH=2400, PREAMBLE=4, LTHFLD=2, FORMAT=BIN; 000380
      RECORD LENGTH=136, PREAMBLE=4, STRUCTURE=VB, 000390
      LTHFLD=2, FORMAT=BIN; 000400
      LINE DATA=(1,132), PCCTYPE=ANSI, PCC=(0,NOTRAN), 000410
      OVERPRINT=(MERGE,NODISP), VFU=WR; 000420

```

```

/*                                          */ 000430
/*          CATALOG FOR UNIVAC SERIES 70    */ 000440
/*          (FORMERLY RCA)                  */ 000450
/*                                          */ 000460
US:CATALOG;
    VOLUME  HOST=US70, LABEL=STANDARD, PLABEL=YES;    000480
    BLOCK   LENGTH=1330, PREAMBLE=0;                  000490
    RECORD  LENGTH=133, STRUCTURE=FB;                 000500
    LINE    DATA=(1,132), PCCTYPE=US70, PCC=(0,NOTRAN),
            OVERPRINT=(MERGE,NODISP), VFU=V1;        000510
/*                                          */ 000520
/*                                          */ 000530
/*          IBM OS/DOS STANDARD LABELED TAPES    */ 000540
/*          -----                            */ 000550
/*                                          */ 000560
/*          THE FOLLOWING JDES PROVIDE SUPPORT FOR IBM OS STANDARD    */ 000570
/*          AND IBM DOS STANDARD LABELED TAPES    */ 000580
/*                                          */ 000590
/*          CHARACTERISTICS                      JOB        */ 000600
/*          -----                            -----        */ 000610
/*                                          */ 000620
/*          OS STANDARD LABELS, 1403 PCC          1          */ 000630
/*          OS STANDARD LABELS, ANSI PCC         2          */ 000640
/*          OS STANDARD LABELS, 1401 PCC         3          */ 000650
/*          OS STANDARD LABELS, NO PCC           4          */ 000660
/*          DOS STANDARD LABELS, 1403 PCC        5          */ 000670
/*          DOS STANDARD LABELS, ANSI PCC        6          */ 000680
/*          DOS STANDARD LABELS, 1401 PCC        7          */ 000690
/*          DOS STANDARD LABELS, NO PCC          8          */ 000700
/*                                          */ 000710
1:JOB  INCLUDE=(OSVB);
      VOLUME  HOST=IBMOS, LABEL=STANDARD, CODE=EBCDIC;    000720
      LINE    PCCTYPE=IBM1403;                            000730
2:JOB  INCLUDE=(OSVB);
      VOLUME  HOST=IBMOS, LABEL=STANDARD, CODE=EBCDIC;    000740
      LINE    PCCTYPE=ANSI;                               000750
3:JOB  INCLUDE=(OSVB);
      VOLUME  HOST=IBMOS, LABEL=STANDARD, CODE=EBCDIC;    000760
      LINE    PCCTYPE=IBM1401;                            000770
4:JOB  INCLUDE=(OSVB);
      VOLUME  HOST=IBMOS, LABEL=STANDARD, CODE=EBCDIC;    000780
      LINE    PCCTYPE=IBM1401;                            000790
5:JOB  INCLUDE=(OSVB);
      VOLUME  HOST=IBMOS, LABEL=STANDARD, CODE=EBCDIC;    000800
      LINE    PCCTYPE=IBM1401;                            000810
6:JOB  INCLUDE=(OSVB);
      VOLUME  HOST=IBMOS, LABEL=STANDARD, CODE=EBCDIC;    000820
      LINE    PCCTYPE=NONE;                               000830
7:JOB  INCLUDE=(OSVB);
      VOLUME  HOST=IBMOS, LABEL=STANDARD, CODE=EBCDIC;    000840
      LINE    PCCTYPE=NONE;                               000850
8:JOB  INCLUDE=(OSVB);
      VOLUME  HOST=IBMOS, LABEL=STANDARD, CODE=EBCDIC;    000860
      LINE    PCCTYPE=NONE;                               000870
9:JOB  INCLUDE=(OSVB);
      VOLUME  HOST=IBMOS, LABEL=STANDARD, CODE=EBCDIC;    000880
      LINE    PCCTYPE=NONE;                               000890
10:JOB INCLUDE=(OSVB);
      VOLUME  HOST=IBMOS, LABEL=STANDARD, CODE=EBCDIC;    000900
      LINE    PCCTYPE=NONE;                               000910
11:JOB INCLUDE=(OSVB);
      VOLUME  HOST=IBMOS, LABEL=STANDARD, CODE=EBCDIC;    000920
      LINE    PCCTYPE=NONE;                               000930
12:JOB INCLUDE=(OSVB);
      VOLUME  HOST=IBMOS, LABEL=STANDARD, CODE=EBCDIC;    000940
      LINE    PCCTYPE=NONE;                               000950

```



```

/*          IBM ANSI LABELED AND OS WRITER TAPES          */
/*          -----          */
/*          THE FOLLOWING JDES PROVIDE SUPPORT FOR IBM ANSI LABELED */
/*          TAPES AND OS WRITER TAPES.          */
/*          CHARACTERISTICS          JOB          */
/*          -----          -----          */
/*          ANSI LABELS, ASCII CODE, ANSI PCC          21          */
/*          ANSI LABELS, ASCII CODE, NO PCC          22          */
/*          OS WRITER, ANSI PCC          23          */
/*          OS WRITER, 1403 PCC          24          */
/*          */
21:JOB;
VOLUME  HOST=IBMOS, LABEL=ANSI, CODE=ASCII, LCODE=ASCII;
LINE    PCCTYPE=ANSI;
22:JOB;
VOLUME  HOST=IBMOS, LABEL=ANSI, CODE=ASCII, LCODE=ASCII;
LINE    PCCTYPE=NONE;
23:JOB  INCLUDE=(OS);
VOLUME  HOST=OSWTR;
LINE    PCCTYPE=ANSI;
24:JOB  INCLUDE=(OS);
VOLUME  HOST=OSWTR;
LINE    PCCTYPE=IBM1403;
/*          */
/*          US70 (RCA) STANDARD LABELED TAPES          */
/*          -----          */
/*          JDES 41 AND 42 PROVIDE SUPPORT FOR US70 (FORMERLY RCA) */
/*          STANDARD LABELED TAPES.          */
/*          */
41:JOB  INCLUDE=(US);
VOLUME  HOST=US70, LABEL=STANDARD;
END;END;

```

3. IBM DOS/360 GRASP tape organization

This chapter describes the IBM DOS/360 GRASP tape organization. It also includes a sample JSL.

Record format

Each physical record on a GRASP tape consists of two basic elements: the identification segment and a segment containing a variable number of logical data records (refer to figure 3-1).

Figure 3-1. GRASP physical record format

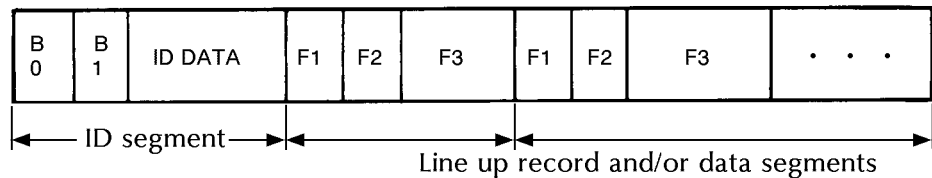

- *B0* is a byte which contains the length of the ID segment in binary.
- *B1* is used as a flag byte. If bit zero of byte 1 is set to 1, then the first logical record following the ID segment contains a line up message-to be used for job control information by the operator.
- *ID DATA*, bytes 26 and 27 (zero-indexing from the start of the block) contain the address of the phantom printer device to be used for block selection/deletion criteria, if desired.
- *F1* is a one-byte binary value which gives the length of *F3*. A zero value implies end of logical records in block.
- *F2* is the channel control word after resetting bit 5 to zero. In a line-up record, the channel control word stored here is treated as a "no operation" (NOP) by the printer.
- *F3* is either a line-up message or a line of print data.

Identification segment

The identification segment is a logical record used by GRASP. It consists of a length byte (byte 0), a flag byte (byte 1), and identification data used only by GRASP.

- The length byte contains the length of the identification segment, including the length byte, flag byte, and identification data.
- Bit 0 of the flag byte is set to one if the current data block contains a line-up record. This line-up record, if present, appears as the first logical data record in the block.

Data records

The logical data records consist of three fields.

- Field one contains a one-byte binary value which specifies the length of field three. If zero is specified, the end of logical records in the current physical record is indicated.
- Field two contains a one-byte code which, after turning off bit five, should be used as the IBM System 360/370 (1403) printer carriage control code.
- Field three is the print line data. The length of the data is specified in field one.

GRASP tapes are single file tapes ending with a single tape mark. Multiple reel tapes are signified by an ending tape mark coinciding with an EOT reflector.

Line-up records

Line-up records conform to the field three format mentioned previously. The length byte of the line-up record includes the length of the message identifier and the length of the message text. To locate the message text, scan the record for a hexadecimal 15 (X'15'). The text of the message begins with the character immediately following the hexadecimal 15. The channel control word in the line-up record is the code for a printer "no operation" (NOP).

Physical record size

The physical record size for each block of data on a GRASP tape is equal to the GRASP disk buffer size. This buffer size is specified at GRASP generation time and must be obtained from the user installation's software support group.

Sample data block

A sample GRASP data block is shown in figure 3-2.

Figure 3-2. **Sample GRASP data block**

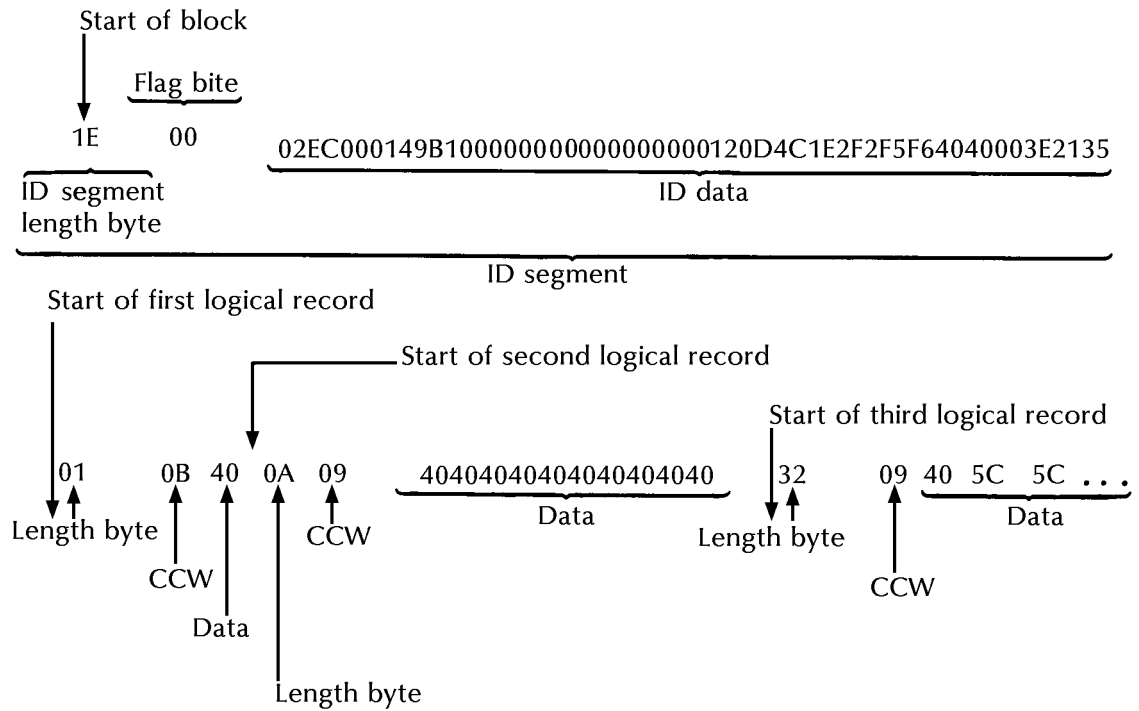

Note:

1. This block does not contain a line-up record. If it did, the line-up record would be in the first logical record position and it would have the same format as all other logical records in the block.
2. The identification segment length byte includes itself in the length count, while the data record length byte gives the length of the print data within the logical record.
3. The carriage control bytes shown in this example could be used directly without resetting bit 5 (it is already 0). "0B" indicates space 1 immediate (no printing), "09" indicates space 1 after printing, and so on.
4. CCW indicates channel control word.

GRASP carriage control conventions

GRASP carriage control is identical to IBM 1403 carriage control except bit five (counting from the left of the byte) is set. This is equivalent to adding binary four to each of the IBM 1403 control codes. For example, GRASP code X'0D' is processed as 1403 code X'09', or "print and space one line."

GRASP interspersed block tapes

GRASP can produce interspersed block tapes by using multiple phantom printers. Byte 27 of each block (in the ID segment of each block) contains the address of a phantom printer. To process these requests, the user should set up a block selection/deletion function.

POWER and GRASP tapes

The following figure provides a JSL sample.

Figure 3-3. JSL sample for POWER and GRASP tapes

```
POWGRP:JDL;                                000010
/*                                          */ 000020
/*          SYSTEM FOR POWER, POWER VS, AND GRASP          */ 000030
/*                                          */ 000040
V1:      VFU      ASSIGN=(1,5), ASSIGN=(2,10), ASSIGN=(3,15), 000050
          ASSIGN=(4,20), ASSIGN=(5,25), ASSIGN=(6,30), 000060
          ASSIGN=(7,35), ASSIGN=(8,40), ASSIGN=(9,45), 000070
          ASSIGN=(10,50), ASSIGN=(11,55), ASSIGN=(12,60), 000080
          TOF=4, BOF=66;                                000090
/*                                          */ 000100
/*          TABLES AND CRITERIA FOR LOGICAL PROCESSING    */ 000110
/*          FOR GRASP INTERLEAVED TAPES                    */ 000120
/*                                          */ 000130
T1:      TABLE   CONSTANT=('B');                                000140
T2:      TABLE   CONSTANT=('C');                                000150
/*                                          */ 000160
C1:      CRITERIA CONSTANT=(27,1,EQ,T1);                        000170
C2:      CRITERIA CONSTANT=(27,1,EQ,T2);                        000180
/*                                          */ 000190
/*          SYSTEM FOR POWER VS                            */ 000200
/*                                          */ 000210
          VOLUME   HOST=POWERSVS, PLABEL=YES;                  000220
          BLOCK    LENGTH=2048;                                000230
          RECORD   LENGTH=136, STRUCTURE=VB, LTHFLD=2, OFFSET=0, 000240
                  ADJUST=0, FORMAT=BIN, PREAMBLE=3;          000250
          LINE     DATA=(1,132), PCCTYPE=IBM1403, PCC=(0,NOTRAN), 000260
                  OVERPRINT=(MERGE,NODISP), VFU=V1;          000270
          ACCT     USER=(BIN,TRAY);                            000280
/*                                          */ 000290
/*          CATALOG FOR POWER VERSIONS                      */ 000300
/*                                          */ 000310
PW:CATALOG;                                000320
          VOLUME   HOST=POWER;                                  000330
          BLOCK    LENGTH=2048, PREAMBLE=6, LTHFLD=2, FORMAT=BIN, 000340
                  OFFSET=4;                                  000350
          RECORD   LENGTH=135, STRUCTURE=VB, PREAMBLE=2,      000360
                  LTHFLD=2, FORMAT=BIN, OFFSET=0, ADJUST=3;  000370
/*                                          */ 000380
/*          CATALOG FOR GRASP                               */ 000390
/*                                          */ 000400
GR:CATALOG;                                000410
          VOLUME   HOST=GRASP;                                  000420
          BLOCK    LENGTH=4096, PREAMBLE=0, ZERO=YES;         000430
          RECORD   LENGTH=135, STRUCTURE=VB, PREAMBLE=1,      000440
                  LTHFLD=1, FORMAT=BIN, OFFSET=0, ADJUST=2;  000450
/*                                          */ 000460
          RSTACK   TEST=(C1,OR,C2), DELIMITER=YES, PRINT=TRAY; 000470
/*                                          */ 000480
/*                                          */ 000490
```

```

/*          POWER VS, POWER 4.0, AND POWER 4.1/4.2          */ 000500
/*          -----                                          */ 000510
/*                                                         */ 000520
/* THE FOLLOWING JDES PROVIDE SUPPORT FOR IBM POWER VS TAPES, */ 000530
/* POWER VERSION 4.0 TAPES, AND POWER VERSIONS 4.1/4.2 TAPES */ 000540
/*                                                         */ 000550
/*          CHARACTERISTICS                                JOB   */ 000560
/*          -----                                -----   */ 000570
/*                                                         */ 000580
/*          POWER VS TAPES                                1     */ 000590
/*          POWER VERSION 4.0 TAPES                       2     */ 000600
/*          POWER VERSIONS 4.1/4.2 TAPES                  3     */ 000610
/*                                                         */ 000620
1:JOB;                                                    000630
VOLUME  HOST=POWERVS;                                    000640
2:JOB  INCLUDE=(PW);                                     000650
VOLUME  HOST=POWER;                                      000660
RECORD  LTHFLD=1, PREAMBLE=1, ADJUST=2;                 000670
3:JOB  INCLUDE=(PW);                                     000680
VOLUME  HOST=POWER;                                      000690
/*                                                         */ 000700
/*          IBM DOS GRASP TAPES                            */ 000710
/*          -----                                          */ 000720
/*                                                         */ 000730
/* THE FOLLOWING JDES PROVIDE SUPPORT FOR GRASP TAPES      */ 000740
/*                                                         */ 000750
/*          CHARACTERISTICS                                JOB   */ 000760
/*          -----                                -----   */ 000770
/*                                                         */ 000780
/*          NORMAL GRASP TAPES                            21     */ 000790
/*          GRASP WITH INTERSPERSED REPORTS - SELECT     22     */ 000800
/*          REPORTS FROM PHANTOM DEVICE B                 */ 000810
/*          GRASP WITH INTERSPERSED REPORTS - DELETE     23     */ 000820
/*          REPORTS FROM PHANTOM DEVICE C                 */ 000830
/*                                                         */ 000840
21:JOB  INCLUDE=(GR);                                    000850
VOLUME  HOST=GRASP;                                      000860
22:JOB  INCLUDE=(GR);                                    000870
VOLUME  HOST=GRASP;                                      000880
BSELECT TEST=(C1);                                       000890
23:JOB  INCLUDE=(GR);                                    000900
VOLUME  HOST=GRASP;                                      000910
BSELECT TEST=(C2);                                       000920
/*                                                         */ 000930
/*          END OF POWER AND GRASP SYSTEM                 */ 000940
END;END;                                                    000950

```

4. IBM DOS/360 POWER II tape organization

This chapter describes the IBM DOS/360 POWER II tape organization. It also includes tape format examples and a sample JSL.

Tape formats

The Xerox/OSS accepts labeled tapes produced by IBM DOS/360 POWER II, Versions 4.0, 4.1, and 4.2. POWER II produces tapes with one 20-byte header label, variable length blocks up to 1024 bytes long, and blocks with variable length records. Each block is preceded by a 6-byte prefix which contains the block size in bytes (including the block prefix). Each record has a prefix which contains the record length field and carriage control information.

Block version characteristics (4.0, 4.1, 4.2)

The block Version 4.0 format is shown in figure 4-1.

Figure 4-1. POWER Version 4.0, block format

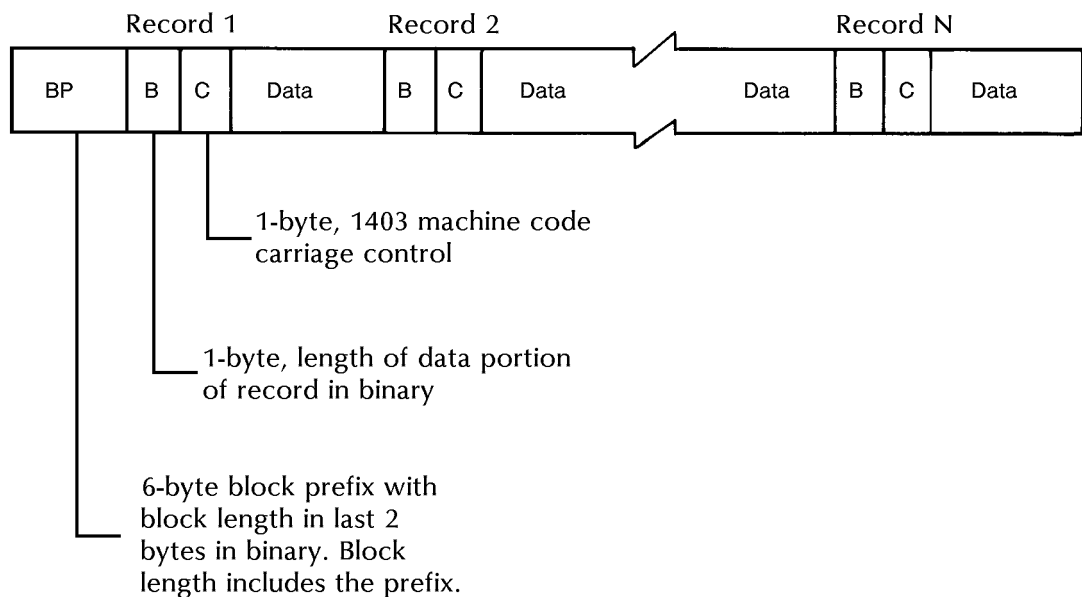

- The 20-byte header label contains the characters PRTRDRPUN in the first 9 positions followed by 11 blanks. (This is the same as Version 4.0.)
- Each block begins with a 6-byte block prefix which contains the block length in bytes in the last 2 bytes of the prefix. (This is the same as Version 4.0.)
- Each record is prefaced with a 2-byte field. The first byte is the length of the data portion of the record in bytes, and the second byte is an IBM 1403 Machine Control Code used for carriage control.

Version 4.1

The block Version 4.1 is shown in figure 4-2.

Figure 4-2. **POWER Version 4.1 and 4.2, block format**

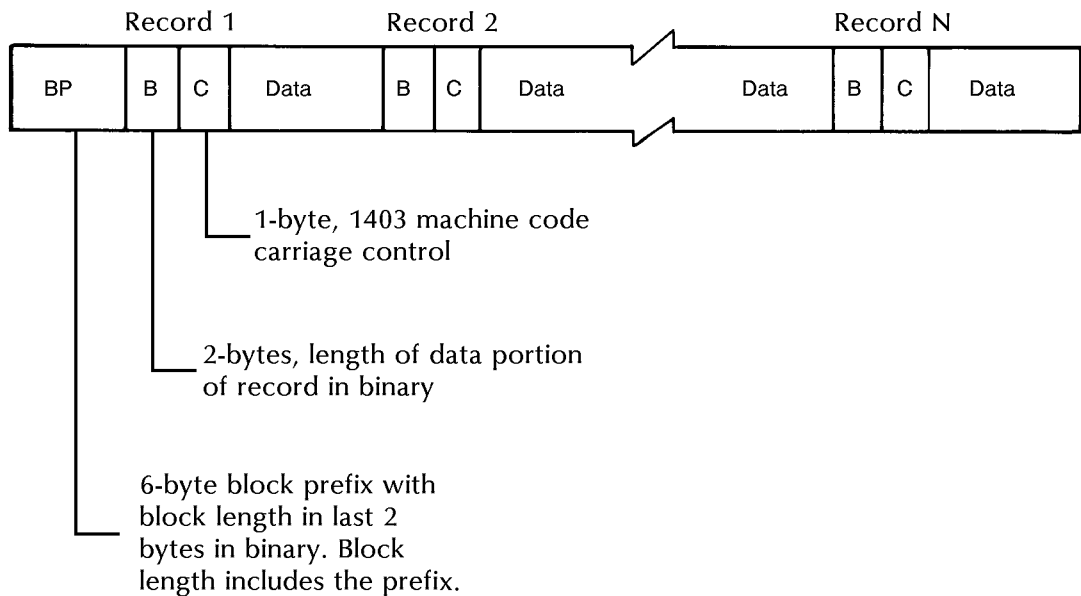

- The 20-byte header label contains the characters PRTRDRPUN in the first 9 positions followed by 11 blanks. (This is the same as Version 4.0.)
- Each block begins with a 6-byte block prefix which contains the block length in bytes in the last 2 bytes of the prefix. (This is the same as Version 4.0.)
- Each record is prefaced with a 3-byte field. The first two bytes contain the length of the data portion of the record in bytes, and the third byte is an IBM 1403 Machine Control Code used for carriage control.

Version 4.2

The block and record format for Version 4.2 is identical to Version 4.1. (Refer to previous section.)

Tape format examples

An example of a Version 4.0 POWER II tape is shown in figure 4-3.
 An example of a Version 4.1 POWER II tape is shown in figure 4-4.

Figure 4-3. **POWER II, Version 4.0 sample tape format**

First record, header label* D7D9E3D9C4D9D7E4D540404040404040404040404040

* Header label contents shown are in hexadecimal.

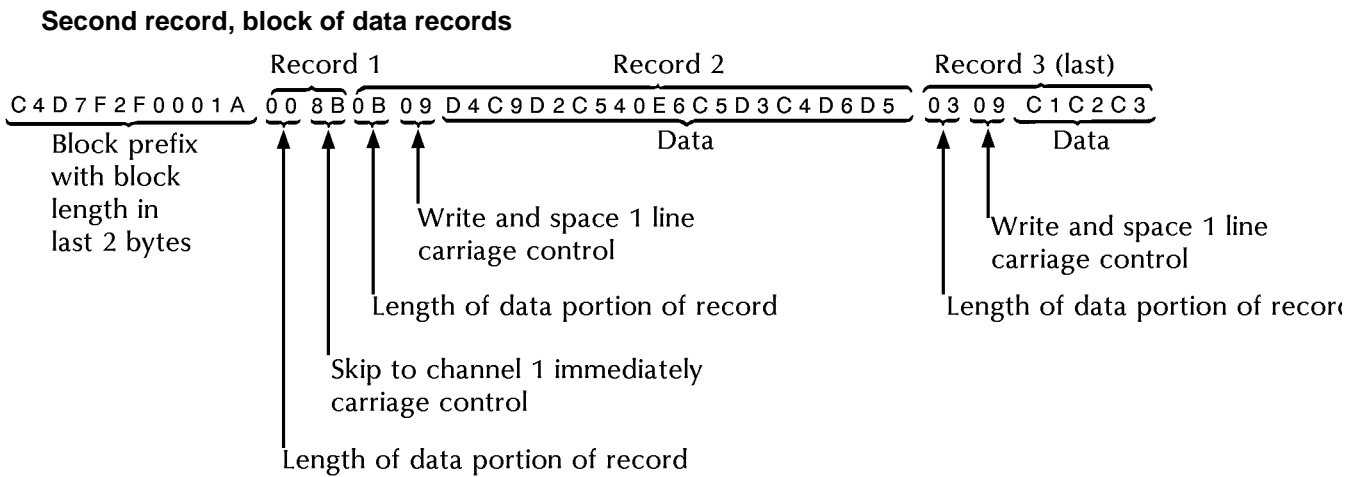
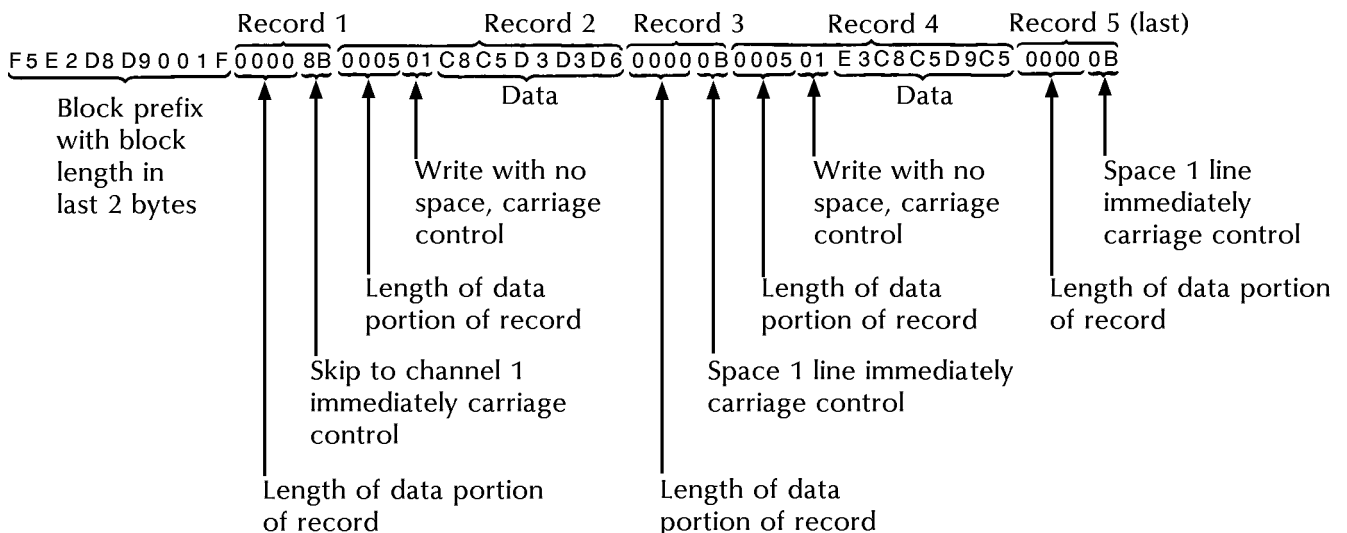

Figure 4-4. **POWER II, Version 4.1 sample tape format**

First record, header label* D7D9E3D9C4D9D7E4D540404040404040404040404040

* Header label contents shown are in hexadecimal.



POWER and GRASP tape JSL sample

The following figure provides a JSL sample.

Figure 4-5. JSL sample for POWER and GRASP tapes.

```

POWGRP:JDL;                                000010
/*                                          */ 000020
/*          SYSTEM FOR POWER, POWER VS, AND GRASP          */ 000030
/*                                          */ 000040
V1:      VFU      ASSIGN=(1,5), ASSIGN=(2,10), ASSIGN=(3,15), 000050
          ASSIGN=(4,20), ASSIGN=(5,25), ASSIGN=(6,30), 000060
          ASSIGN=(7,35), ASSIGN=(8,40), ASSIGN=(9,45), 000070
          ASSIGN=(10,50), ASSIGN=(11,55), ASSIGN=(12,60), 000080
          TOF=4, BOF=66; 000090
/*                                          */ 000100
/*          TABLES AND CRITERIA FOR LOGICAL PROCESSING    */ 000110
/*          FOR GRASP INTERLEAVED TAPES                    */ 000120
/*                                          */ 000130
T1:      TABLE  CONSTANT=('B'); 000140
T2:      TABLE  CONSTANT=('C'); 000150
/*                                          */ 000160
C1:      CRITERIA CONSTANT=(27,1,EQ,T1); 000170
C2:      CRITERIA CONSTANT=(27,1,EQ,T2); 000180
/*                                          */ 000190
/*          SYSTEM FOR POWER VS                            */ 000200
/*                                          */ 000210
          VOLUME  HOST=POWERVS, PLABEL=YES; 000220
          BLOCK   LENGTH=2048; 000230
          RECORD  LENGTH=136, STRUCTURE=VB, LTHFLD=2, OFFSET=0, 000240
          ADJUST=0, FORMAT=BIN, PREAMBLE=3; 000250
          LINE    DATA=(1,132), PCCTYPE=IBM1403, PCC=(0,NOTRAN), 000260
          OVERPRINT=(MERGE,NODISP), VFU=V1; 000270
          ACCT    USER=(BIN,TRAY); 000280
/*                                          */ 000290
/*          CATALOG FOR POWER VERSIONS                     */ 000300
/*                                          */ 000310
PW:CATALOG; 000320
          VOLUME  HOST=POWER; 000330
          BLOCK   LENGTH=2048, PREAMBLE=6, LTHFLD=2, FORMAT=BIN, 000340
          OFFSET=4; 000350
          RECORD  LENGTH=135, STRUCTURE=VB, PREAMBLE=2, 000360
          LTHFLD=2, FORMAT=BIN, OFFSET=0, ADJUST=3; 000370
/*                                          */ 000380
/*          CATALOG FOR GRASP                              */ 000390
/*                                          */ 000400
GR:CATALOG; 000410
          VOLUME  HOST=GRASP; 000420
          BLOCK   LENGTH=4096, PREAMBLE=0, ZERO=YES; 000430
          RECORD  LENGTH=135, STRUCTURE=VB, PREAMBLE=1, 000440
          LTHFLD=1, FORMAT=BIN, OFFSET=0, ADJUST=2; 000450
/*                                          */ 000460
          RSTACK  TEST=(C1,OR,C2), DELIMITER=YES, PRINT=TRAY; 000470
/*                                          */ 000480
/*                                          */ 000490

```

```

/*          POWER VS, POWER 4.0, AND POWER 4.1/4.2          */ 000500
/*          -----                                          */ 000510
/*                                                         */ 000520
/* THE FOLLOWING JDES PROVIDE SUPPORT FOR IBM POWER VS TAPES, */ 000530
/* POWER VERSION 4.0 TAPES, AND POWER VERSIONS 4.1/4.2 TAPES */ 000540
/*                                                         */ 000550
/*          CHARACTERISTICS                                JOB    */ 000560
/*          -----                                          ----- */ 000570
/*                                                         */ 000580
/*          POWER VS TAPES                                1      */ 000590
/*          POWER VERSION 4.0 TAPES                       2      */ 000600
/*          POWER VERSIONS 4.1/4.2 TAPES                   3      */ 000610
/*                                                         */ 000620
1:JOB;                                                    000630
VOLUME  HOST=POWERVS;                                    000640
2:JOB  INCLUDE=(PW);                                     000650
VOLUME  HOST=POWER;                                      000660
RECORD  LTHFLD=1, PREAMBLE=1, ADJUST=2;                 000670
3:JOB  INCLUDE=(PW);                                     000680
VOLUME  HOST=POWER;                                      000690
/*                                                         */ 000700
/*          IBM DOS GRASP TAPES                             */ 000710
/*          -----                                          */ 000720
/*                                                         */ 000730
/* THE FOLLOWING JDES PROVIDE SUPPORT FOR GRASP TAPES       */ 000740
/*                                                         */ 000750
/*          CHARACTERISTICS                                JOB    */ 000760
/*          -----                                          ----- */ 000770
/*                                                         */ 000780
/*          NORMAL GRASP TAPES                             21     */ 000790
/*          GRASP WITH INTERSPERSED REPORTS - SELECT      22     */ 000800
/*          REPORTS FROM PHANTOM DEVICE B                  */ 000810
/*          GRASP WITH INTERSPERSED REPORTS - DELETE      23     */ 000820
/*          REPORTS FROM PHANTOM DEVICE C                   */ 000830
/*                                                         */ 000840
21:JOB  INCLUDE=(GR);                                    000850
VOLUME  HOST=GRASP;                                      000860
22:JOB  INCLUDE=(GR);                                    000870
VOLUME  HOST=GRASP;                                      000880
BSELECT TEST=(C1);                                       000890
23:JOB  INCLUDE=(GR);                                    000900
VOLUME  HOST=GRASP;                                      000910
BSELECT TEST=(C2);                                       000920
/*                                                         */ 000930
/*          END OF POWER AND GRASP SYSTEM                   */ 000940
END;END;

```

5. IBM POWER/VS and POWER/VSE tape organization

This chapter describes the IBM POWER/VS and POWER/VSE tape organization. It also includes example file formats and a sample JSL.

Tape formats

The Xerox printing system accepts tapes produced by IBM DOS/VS POWER and DOS/VSE POWER as illustrated in figure 5-1. These tapes have no labels per se; however, the first and last blocks of a file, which are identical, have a special length and content and, in a limited sense, act as labels. Figure 5-2 presents an example of one such special block or POWER/VS.

File formats

A tape mark precedes the first file on the tape. A single tape mark separates files, and two tape marks end the tape. A tape mark encountered in conjunction with an end-of-tape reflector denotes an end-of-volume condition. (Refer to figure 5-1.)

For POWER VS, the file consists of one 152-byte special block, followed by data blocks as described below in the section "Data formats." The last block in the file is another 152-byte special block.

For POWER/VSE, both special blocks are 184 bytes long, although their format remains the same otherwise.

For POWER/VSE II, both special blocks are 216 bytes long, although their format remains the same otherwise.

Data formats

The data formats are fixed length blocks with variable length records; no block length fields are present. The record format has a 2-byte length field, a general purpose byte, a carriage control byte from the 1403 carriage control set, and zero to 132 print characters. (See figures 5-3 and 5-4 which illustrate block and record formats, respectively.)

A general purpose byte gives record or block identification; the codes and functions of this byte are listed and described in table 5-1.

Table 5-1. **General purpose byte-codes and functions**

Codes	Functions
00,01	Normal record
02	3540 (floppy disk) record
04	End-of-data (occurs in the last record of the last print data block in the file)
08	Break record
0C,0D	End-of-block for Version 30.1 of DOS/ VS POWER
10,11	End-of-block for Version 31 of DOS/VS POWER and subsequent releases
20	End of 3540 records

Figure 5-1. POWER VS and POWER/VSE file formats

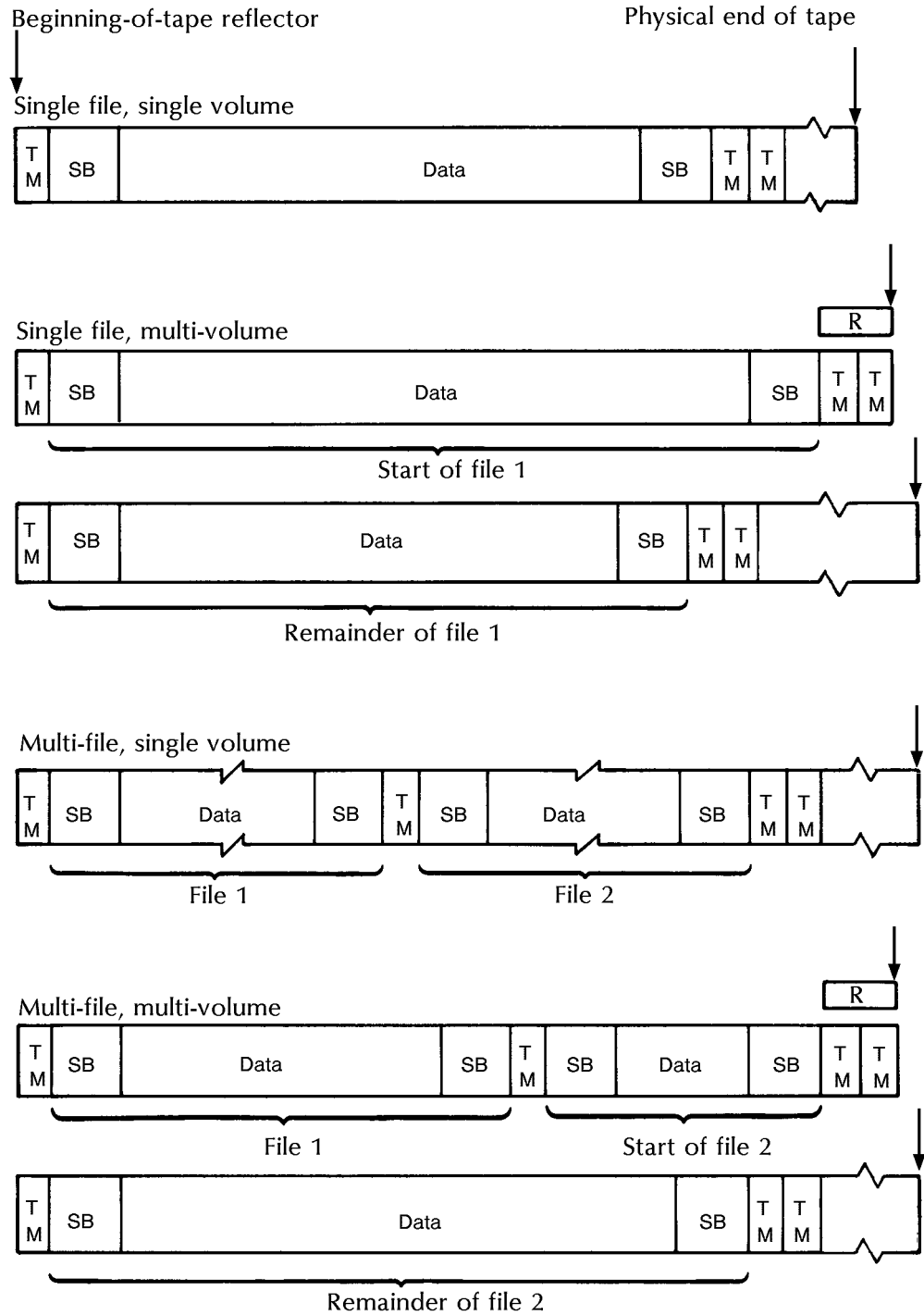

Interpretation	
TM	= Tape mark
DATA	= One or more data blocks (see figure 5-3 for further details)
SB	= Special block (see figure 5-2 for further details)
R	= Reflector

Figure 5-2. Format of a POWER VS special block

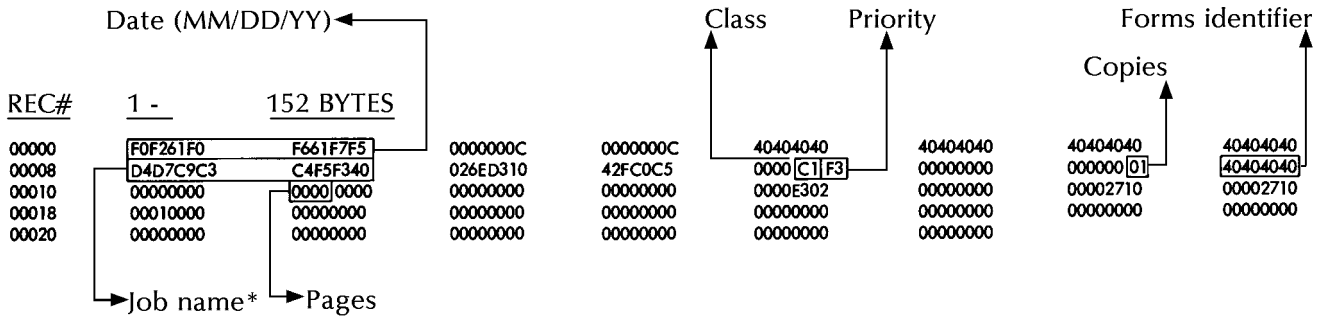
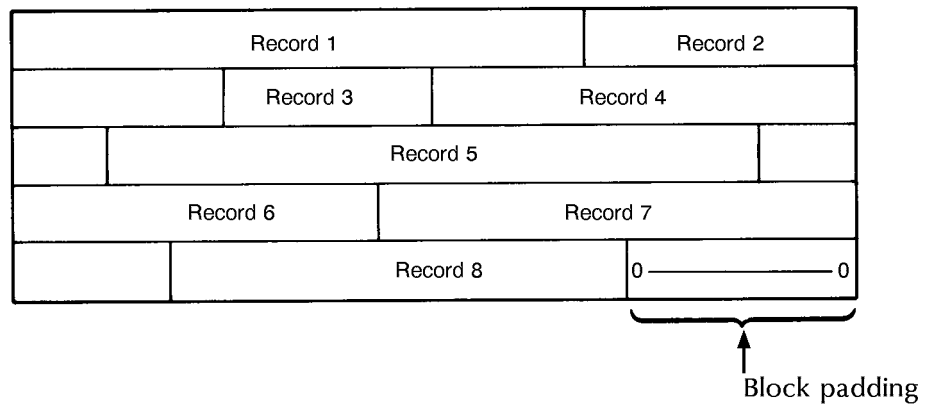
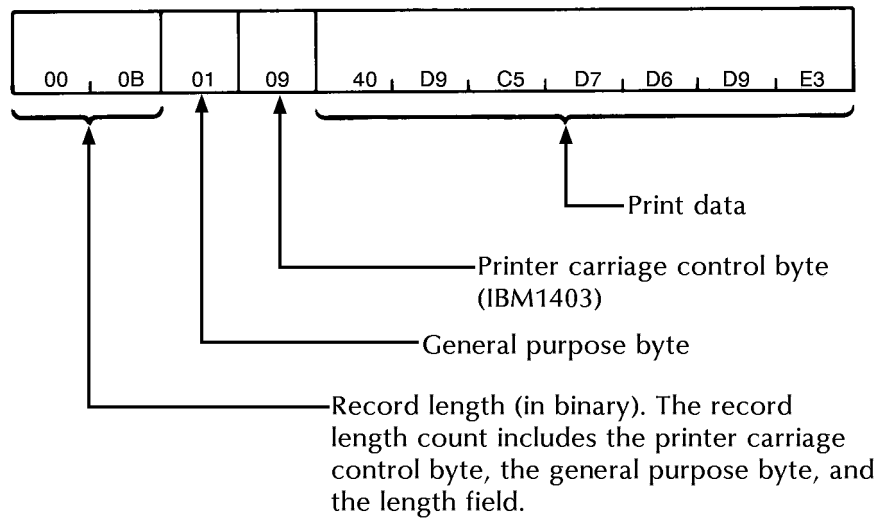

Figure 5-3. POWER VS data block format



Blocks are fixed in length with variable length records. There is no block length field, block offset, or block postamble.

Figure 5-4. POWER VS record format



See table 5-1, earlier in this chapter, for general purpose byte codes and functions.

POWER and GRASP tape JSL sample

The following figure provides a JSL sample.

Figure 5-5. JSL sample for POWER and GRASP tapes

```

POWGRP:JDL;                                000010
/*                                          */ 000020
/*          SYSTEM FOR POWER, POWER VS, AND GRASP          */ 000030
/*                                          */ 000040
V1:      VFU      ASSIGN=(1,5), ASSIGN=(2,10), ASSIGN=(3,15), 000050
          ASSIGN=(4,20), ASSIGN=(5,25), ASSIGN=(6,30), 000060
          ASSIGN=(7,35), ASSIGN=(8,40), ASSIGN=(9,45), 000070
          ASSIGN=(10,50), ASSIGN=(11,55), ASSIGN=(12,60), 000080
          TOF=4, BOF=66;                                000090
/*                                          */ 000100
/*          TABLES AND CRITERIA FOR LOGICAL PROCESSING    */ 000110
/*          FOR GRASP INTERLEAVED TAPES                    */ 000120
/*                                          */ 000130
T1:      TABLE  CONSTANT=( 'B' );                    000140
T2:      TABLE  CONSTANT=( 'C' );                    000150
/*                                          */ 000160
C1:      CRITERIA CONSTANT=(27,1,EQ,T1);              000170
C2:      CRITERIA CONSTANT=(27,1,EQ,T2);              000180
/*                                          */ 000190
/*          SYSTEM FOR POWER VS                            */ 000200
/*                                          */ 000210
          VOLUME  HOST=POWERVS, PLABEL=YES;            000220
          BLOCK   LENGTH=2048;                          000230
          RECORD  LENGTH=136, STRUCTURE=VB, LTHFLD=2, OFFSET=0, 000240
          ADJUST=0, FORMAT=BIN, PREAMBLE=3;             000250
          LINE    DATA=(1,132), PCCTYPE=IBM1403, PCC=(0,NOTRAN), 000260
          OVERPRINT=(MERGE,NODISP), VFU=V1;            000270
          ACCT    USER=(BIN,TRAY);                      000280
/*                                          */ 000290
/*          CATALOG FOR POWER VERSIONS                     */ 000300
/*                                          */ 000310
PW:CATALOG;                                    000320
          VOLUME  HOST=POWER;                            000330
          BLOCK   LENGTH=2048, PREAMBLE=6, LTHFLD=2, FORMAT=BIN, 000340
          OFFSET=4;                                      000350
          RECORD  LENGTH=135, STRUCTURE=VB, PREAMBLE=2, 000360
          LTHFLD=2, FORMAT=BIN, OFFSET=0, ADJUST=3;    000370
/*                                          */ 000380
/*          CATALOG FOR GRASP                              */ 000390
/*                                          */ 000400
GR:CATALOG;                                    000410
          VOLUME  HOST=GRASP;                             000420
          BLOCK   LENGTH=4096, PREAMBLE=0, ZERO=YES;    000430
          RECORD  LENGTH=135, STRUCTURE=VB, PREAMBLE=1, 000440
          LTHFLD=1, FORMAT=BIN, OFFSET=0, ADJUST=2;    000450
/*                                          */ 000460
          RSTACK  TEST=(C1,OR,C2), DELIMITER=YES, PRINT=TRAY; 000470
/*                                          */ 000480
/*                                          */ 000490

```

```

/*          POWER VS, POWER 4.0, AND POWER 4.1/4.2          */ 000500
/*          -----                                          */ 000510
/*          */ 000520
/* THE FOLLOWING JDES PROVIDE SUPPORT FOR IBM POWER VS TAPES, */ 000530
/* POWER VERSION 4.0 TAPES, AND POWER VERSIONS 4.1/4.2 TAPES*/ 000540
/*          */ 000550
/*          CHARACTERISTICS                                JOB          */ 000560
/*          -----                                          -----          */ 000570
/*          */ 000580
/*          POWER VS TAPES                                1          */ 000590
/*          POWER VERSION 4.0 TAPES                        2          */ 000600
/*          POWER VERSIONS 4.1/4.2 TAPES                  3          */ 000610
/*          */ 000620
1:JOB;                                                    000630
VOLUME  HOST=POWERVS;                                    000640
2:JOB  INCLUDE=(PW);                                     000650
VOLUME  HOST=POWER;                                      000660
RECORD  LTHFLD=1, PREAMBLE=1, ADJUST=2;                000670
3:JOB  INCLUDE=(PW);                                    000680
VOLUME  HOST=POWER;                                    000690
/*          */ 000700
/*          IBM DOS GRASP TAPES                          */ 000710
/*          -----                                          */ 000720
/*          */ 000730
/* THE FOLLOWING JDES PROVIDE SUPPORT FOR GRASP TAPES      */ 000740
/*          */ 000750
/*          CHARACTERISTICS                                JOB          */ 000760
/*          -----                                          -----          */ 000770
/*          */ 000780
/*          NORMAL GRASP TAPES                            21          */ 000790
/*          GRASP WITH INTERSPERSED REPORTS - SELECT     22          */ 000800
/*          REPORTS FROM PHANTOM DEVICE B                */ 000810
/*          GRASP WITH INTERSPERSED REPORTS - DELETE    23          */ 000820
/*          REPORTS FROM PHANTOM DEVICE C                */ 000830
/*          */ 000840
21:JOB  INCLUDE=(GR);                                    000850
VOLUME  HOST=GRASP;                                      000860
22:JOB  INCLUDE=(GR);                                    000870
VOLUME  HOST=GRASP;                                      000880
BSELECT TEST=(C1);                                       000890
23:JOB  INCLUDE=(GR);                                    000900
VOLUME  HOST=GRASP;                                      000910
BSELECT TEST=(C2);                                       000920
/*          */ 000930
/*          END OF POWER AND GRASP SYSTEM                */ 000940
END;END;                                                    000950

```

6. UNIVAC Series 70 (US70) magnetic tape organization

This chapter describes the UNIVAC Series 70 (formerly RCA Spectra 70 Magnetic Tapes) magnetic tape organization. It also describes header and trailer labels, tape configurations, data formats, and includes a sample JSL.

Labeled tapes

A minimum set of US70 standard labels includes a volume label (VOL 1), one standard file header label (HDR1), and one end-of-file trailer label (EOF1) or one standard end-of-volume label (EOV1).

The minimum set of labels may be expanded by adding up to seven of each label type. For example, a file label could contain eight file header labels, HDR1, HDR2, HDR3, up to and including HDR8.

Additionally, the user may include both user header labels (UHL) and user trailer labels (UTL). Up to eight of each of these labels may be used. For example, UHL1 through UHL8 and UTL1 through UTL8 can be added.

Label groups and sets

This section describes header label groups and sets, and trailer label sets.

Header label group

The header label group consists of the volume label, file header label, and user header label sets. These label sets are contiguous within the header label. For example, if a HDR2 label is used, it must follow a HDR1 label.

The header label group is always ended with a tape mark (see figure 6-1).

Figure 6-1. Header label organization

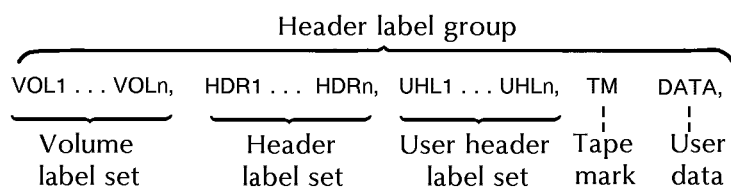

Header label sets

This section describes volume, file, and user labels.

Volume label

Volume labels provide a means of identifying a given tape. The volume label set is the first label set on a tape. There may be up to eight volume labels per tape, but the data field in volumes two (VOL2) through eight (VOL8) are undefined. The contents of a VOL1 label are contained in table 6-1. The contents of VOL2 through VOL8 labels are contained in table 6-2.

Table 6-1. **Volume label format (VOL1)**

Field	Character position(s)	Name	Length	Description
1	1-3	Label identifier	3	VOL
2	4	Volume label number	1	1
3	5-10	Volume serial number	6	Identifies the volume
4	11	Volume security	1	0=No security 1=The volume has or had security protection
5	12-21	Not used for tape files	10	Ten spaces
6	22-31	Reserved	10	Ten spaces
7	32-41	Reserved	10	Ten spaces
8	42-51	Owner's name and address code	10	Identifies the owner of the volume
9	52-80	Reserved	29	Twenty-nine spaces



Note: Unused and reserved fields should be recorded as EBCDIC spaces (hexadecimal 40).



Table 6-2. **Volume label format (VOL2 through VOL8)**

Field	Character position(s)	Name	Length	Description
1	1-3	Label identifier	3	VOL
2	4	Volume label number	1	2 through 8 in ascending sequence
3	5-80	Unidentified	76	Any characters the user wishes

File header label

The standard file header label (HDR1) identifies a file and indicates the sequence of the file within a multi-file set. Additionally, it contains the volume serial number (identical to the volume one [VOL1] serial number) and the sequence of a volume in a file for multi-volume files.

Each file on a volume with standard labels contains a standard header label (see table 6-3). Additionally, the standard label may be

followed by up to seven file header labels, HDR2 through HDR8 (see table 6-4).

Table 6-3. **Standard header label format (HDR1)**

Field	Character position(s)	Name	Length	Description												
1	1-3	Label identifier	3	HDR												
2	4	File header label number	1	1												
3	5-21	File identifier*	17	Identifies the entire file.												
4	22-27	File serial number	6	Identifies a file/volume relationship. This field is identical to the volume label (field 3). On a multi-volume file, this field is identical to the volume serial number on the first volume.												
5	28-31	Volume sequence number*	4	Indicates the sequence of a volume in file (0001-9999). Used with multi-volume files.												
6	32-35	File sequence number	4	Indicates the sequence of a file in a multifile set (0001-9999).												
7	36-39	Generation number	4	Indicates the editions of the file (0001-9999).												
8	40-41	Version number of generation	5	Indicates the version of a generation of a file (01-99).												
9	42-47	Creation date	6	Indicates the year and the day of the year the file was created. The format is: <table border="1"> <thead> <tr> <th>Position</th> <th>Content</th> <th>Meaning</th> </tr> </thead> <tbody> <tr> <td>1</td> <td>Space</td> <td>None</td> </tr> <tr> <td>2-3</td> <td>00-99</td> <td>Year</td> </tr> <tr> <td>4-6</td> <td>001-366</td> <td>Day of the year</td> </tr> </tbody> </table> March 4, 1967 would be entered as <u>6</u> <u>7</u> <u>0</u> <u>6</u> <u>3</u>	Position	Content	Meaning	1	Space	None	2-3	00-99	Year	4-6	001-366	Day of the year
Position	Content	Meaning														
1	Space	None														
2-3	00-99	Year														
4-6	001-366	Day of the year														
10	48-53	Expiration date	6	Indicates the year and the day of the year the volume may be written on. This field has the same format as Field 9.												
11	54	File security	1	0 = No security protection 1 = This file has security protection.												
12	55-60	Block count	6	Six spaces. This field in the file header label is not used.												
13	61-70	Reserved	13	Thirteen spaces.												
14	74-80	Reserved	7	Seven spaces.												

* Fields 3 and 5 are used by the operating system.

Table 6-4. Header label format (HDR2 through HDR8)

Field	Character position(s)	Name	Length	Description
1	1-3	Label identifier	3	HDR
2	4	File header label number	1	2 through 8 in ascending sequence
3	5-80	Undefined	76	Reserved

User header label

The user has the option of including up to eight user header labels on a labeled volume. A user header label contains one field which consists of any characters the user wishes to include. User header labels, if included, follow the file header labels. Their contents are contained in table 6-5.

Table 6-5. User header label format (UHL)

Field	Character position(s)	Name	Length	Description
1	1-3	Label identifier	3	UHL
2	4	User label number	1	1 through 8 in ascending sequence within the UHL set or UTL set.
3	5-80	User's option	76	May contain any characters

Trailer labels

The trailer label group consists of the end-of-file or end-of-volume trailer label sets and the user trailer label set. The end-of-file trailer label set indicates the end of a file. It is followed by one tape mark unless the file under consideration is the last file on the volume. In this case, the end-of-file trailer label set is followed by two tape marks. The end-of-volume trailer label set is used when a file is continued on a subsequent volume. This label set is followed by two tape marks.

The trailer label group format is shown in figure 6-2.

Figure 6-2. Trailer label organization

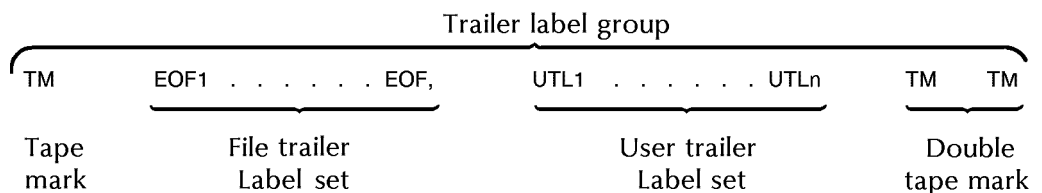

Trailer label sets

File trailer labels

The first label of a trailer label set is called the standard trailer label. This is either an end-of-file (ECF1) label or an end-of-volume (EOV1) label. An end-of-file label indicates the end of a given file; an end-of-volume label indicates the end of useful data on a tape volume. The contents of the standard trailer label are contained in table 6-6.

Table 6-6. **Standard file trailer label format**

Field	Character position(s)	Name	Length	Description
1	1-3	Label identifier	3	EOF=End-of-file trailer label EOV=End-of-volume trailer label
2	4	File trailer label number	1	1
3-11	5-54	Same as corresponding fields in file header label	50	Same as corresponding fields in file header label
12	55-60	Block count*	6	Indicates the number of data blocks written on the file from the last file header label to the first file trailer label, excluding tape marks and checkpoint records.
13	61-73	Same as corresponding fields in file header label	13	Same as corresponding fields in file header label
14	74-80	Same as corresponding fields in file header label	7	Same as corresponding fields in file header label

* Field 12 is used by the operating system.

In addition to the standard trailer label, the user may specify up to seven additional file trailer labels, EOF2 through EOF8 or EOV2 through EOV8. These labels, if used, would follow the standard trailer label. Their contents are shown in table 6-7.

Table 6-7. **File trailer label format**

Field	Character position(s)	Name	Length	Description
1	1-3	Label identifier	3	EOF=End-of-file trailer label EOV=End-of-volume trailer label
2	4	File trailer label number	1	2 through 8 in ascending sequence within the EOF set or EOV set.
3	5-80	Undefined	76	Reserved

User trailer label

The user optionally may specify up to eight user trailer labels, UTL1 through UTL8. If used, these labels follow the file trailer labels. The contents of these labels are contained in table 6-8.

Table 6-8. **User trailer label format (UTL)**

Field	Character position(s)	Name	Length	Description
1	1-3	Label identifier	3	UTL
2	4	User label number	1	1 through 8 in ascending sequence within the UHL set or UTL set.
3	5-80	User's option	76	May contain any characters

Tape configurations

The organization of standard labeled tapes varies from user to user. For example, optional labels may or may not be included, and tape files may occupy many volumes. The four basic configurations that can be processed by the printing system are enumerated below. An example of a standard label tape for each configuration is contained in the figure referenced.

- Single file, single volume (figure 6-3)
- Single file, multi-volume (figure 6-4)
- Single file, multi-volume (figure 6-5)
- Multi-file, multi-volume (figure 6-6)

Figure 6-3. **Standard labeled tape example: Single file, single volume**

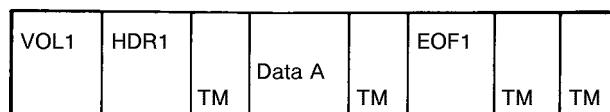
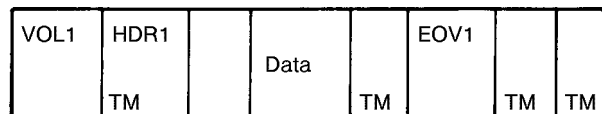

Figure 6-4. **Standard labeled tape example: Single file, multi-volume**

First and intermediate volume



Final volume

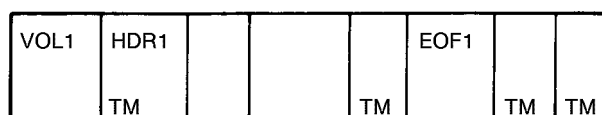

Figure 6-5. **Standard labeled tape example: Multi-file, single volume**

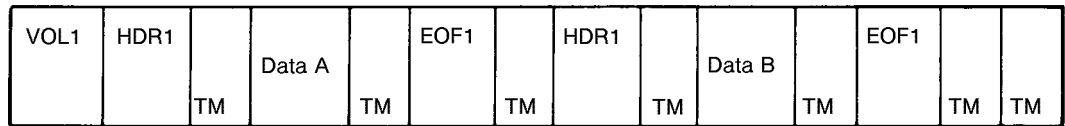
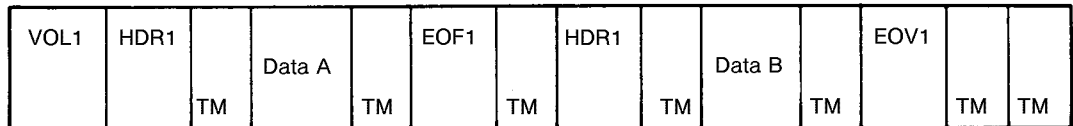
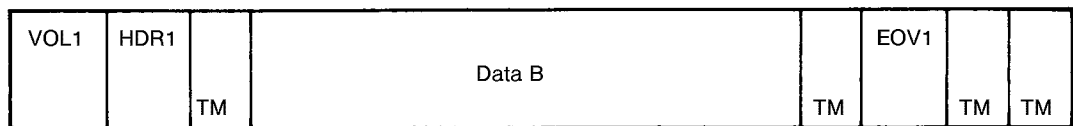

Figure 6-6. **Standard labeled tape example: Multi-file, multi volume**

First volume



Second and intermediate volumes



Final volume

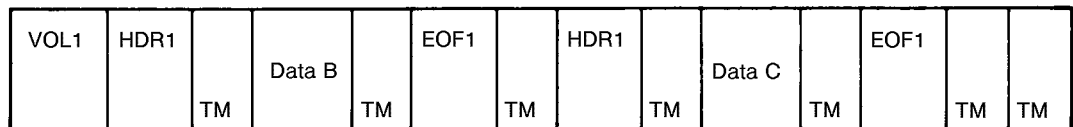

Unlabeled tapes

Magnetic tapes that contain no labels may also be processed on the printing system. Unlabeled tapes optionally may begin with a tape mark. Files are separated by a tape mark and two tape marks follow the last data file. An example of an unlabeled tape is shown in figure 6-7.

Figure 6-7. **Standard labeled tape example: Multi-file, multi volume**

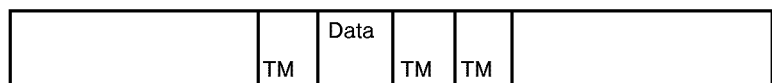

Note: The first tape mark in this illustration is normally written on output but may be omitted at the programmer's option.



Tape marks

This section describes labeled and unlabeled tape marks.

Labeled tapes

A tape mark follows every header label group and precedes and follows every trailer label group. Two tape marks following a trailer label group indicate the end of data on a volume. Figure 6-8 shows an example of tape mark placement for standard labeled tapes.

Figure 6-8. **Tape mark placement: Tapes with standard labels, additional labels, and user labels**

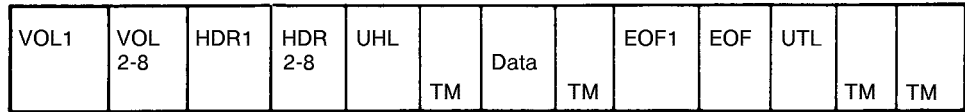

Null files It is possible, however, for two consecutive tape marks to appear on tape and not signify the end of useful data on the volume. This condition (null file) occurs when the end-of-volume and end-of-file coincide (see figure 6-9).

Figure 6-9. **Tape mark placement: Null files**

Volume 1 of 2

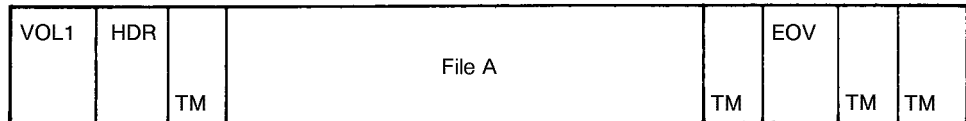

Volume 2 of 2

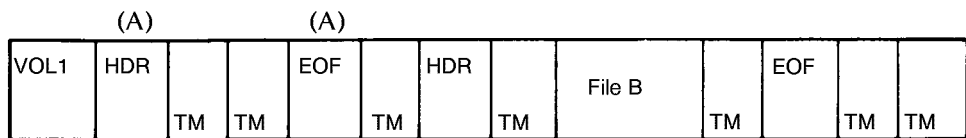

Null file



Note: The notation (A) indicates the labels are part of File A.



Unlabeled tapes

Tapes using no labels optionally may begin with a single tape mark. Files on these tapes normally are separated by tape marks. Two adjacent tape marks signify the end of data on the tape (see figure 6-7).

Data formats

Users may generate magnetic tape files composed of fixed length, variable length, and undefined length records. The fixed and variable length records may be collected further into fixed or variable length blocks. All data blocks must contain 13 or more bytes.

US70 labeled and unlabeled tape formats

Listed below are the record formats that may appear on US70 labeled and unlabeled tapes.

Description	Record lengths, blocked/unblocked
	<ul style="list-style-type: none"> • Fixed length, unblocked • Fixed length records, blocked (block lengths are variable, so that the block length parameter is present) • Variable length, unblocked • Variable length, blocked • Undefined length, unblocked.



Note:

1. The US70 system does not create blocked, undefined record format.
2. Block and record length values always include the block or record length field (4 bytes each) in the count.
3. The record or block length is of binary format and is contained in the first 2 bytes of the 4-byte field. For example, variable length blocked records have the format shown in figure 6-10.



Alternate device tapes

The US70 operating system contains a facility for allocating devices to files at execution time. One situation in which this might be used is when a file that is generally printed on-line is written alternatively to magnetic tape.

A file printed on-line may not generally contain printer cartridge control information as a part of the file. Alternate device print tapes, however, must contain carriage control characters. The programmer is responsible for including them in each print line.

Tape organization

Alternate device tapes may be generated with standard labels, non-standard labels, or no labels. Similarly, these tapes may contain fixed or variable length records and may be blocked or unblocked.

Carriage control byte

Fixed length and variable length print records are described as follows:

Fixed length print records The carriage control byte for fixed length records is the first byte of each fixed length record.

Variable length print records The carriage control byte in variable length records immediately follows the record length for each record.

In both fixed and variable length records, the carriage control byte is considered part of the data of the record and not part of any other control bytes associated with the record.

COBOL print tapes

COBOL language programs executed under the US70 operating system may produce print tapes with up to four different formats. These formats are a result of changes in device assignments at run time. Also, reports written by the Report Writer feature of COBOL may be written to magnetic tape.

Subsequent paragraphs discuss possible formats that may be processed on the printed system and how they are produced. Use the following code to interpret the examples:

cc	A single byte code for controlling carriage spacing on the printer.
P	COBOL Monitor output code of one byte appended to the record; indicates the record is to be printed.
c	COBOL Monitor output code of one byte appended to the record; indicates the record is to be punched onto a card.
RC	The report code specified in Special Names for the WITH CODE option on the Report Writer.



Note: If the records are variable length, the block and record counts precede the first character in the examples shown below.



Format 1

This is a printer-destined file assigned to the external name SYSnn or a report written by Report Writer to the external name SYSnn. Records of these types of files have a single byte carriage control character appended to the front of the record.

cc	Print record
----	--------------

Format 2

These are reports written to the external name SYSnn when the WITH CODE of the Report Writer is specified.

Records with this format include a single byte report, which is specified in Special Names for the WITH CODE option.

When more than one report is written on a file, this report code is used by a user on utility routine (US70's TPR Utility) to select a specific report for printing. The report code lies between the carriage control byte and the beginning of the print data.

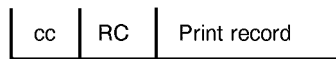
**Format 3**

This is a printer-destined file assigned to S (or a report written to) SYSLST/SYSOUT and executed under Monitor control.

Print tapes of this type have a single byte appended at the beginning of the print record. The byte is added by the Monitor to indicate that the record is to be printed. The byte precedes the carriage control byte.

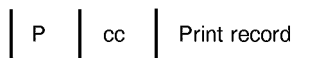
**Format 4**

These are reports written to SYSLST/SYSOUT and executed under Monitor control specified with the WITH CODE option.

Print records in this form have three control bytes preceding the print data. The first byte is the Monitor output code, indicating the record is to be printed. The second byte is the carriage control byte. The third byte is the report code produced by the WITH CODE option of Report Writer.

**US70 printer control conventions**

US70 printer models 242, 243, and 246 accept a 1-byte command to control printer spacing. When printing is performed on-line, this control byte is sent to the printer before the print record and is not part of the print record. When printing is performed off-line, the control byte becomes part of the record (see "Alternate device tapes").

Printer control byte

Line spacing may be performed before or after printing the current file. From 0 to 15 lines may be spaced at one time (refer to table 6-10).

Table 6-9. **US70, 242, 243, and 246 machine codes**

Code (hexadecimal)	Printer function
00	Advance paper 0 lines after printing.
.
.
.
0F	Advance paper 15 lines after printing.
40	Advance paper 0 lines immediately, print, then automatic upspace one line.
41	Advance paper 1 line immediately, print, then automatic upspace one line.
.
.
.
4F	Advance paper 15 lines immediately, print, then automatic upspace one line.
80*	Skip to channel 0 after printing.
81	Skip to channel 1 after printing.
.
.
.
88	Skip to channel 8 after printing.
89*	Skip to channel 9 after printing.
8A	Skip to channel 10 after printing.
8B	Skip to channel 11 after printing.
8C	Skip to channel 12 after printing.
C0*	Skip to channel 0 immediately, print, automatic upspace one line.
C1	Skip to channel 1 immediately, print, automatic upspace one line.
.
.
.
C8	Skip to channel 8 immediately, print, automatic upspace one line.
C9*	Skip to channel 9 immediately, print, automatic upspace one line.
CA	Skip to channel 10 immediately, print, automatic upspace one line.

* This skip command is valid only for printers equipped with Special Forms Control F5278.

Table 6-9. **US70, 242, 243, and 246 machine codes** (continued)

Code (hexadecimal)	Printer function
CB	Skip to channel 11 immediately, print, automatic upspace one line.
CC	Skip to channel 11 immediately, print, automatic upspace one line.

* This skip command is valid only for printers equipped with Special Forms Control F5278.

Figure 6-10. **US70 variable length block records**

Block length 4 bytes	Record 1		Record 2		Record 3	
	Record length 1 4 bytes	Text 72 bytes	Record length 2 4 bytes	Text 80 bytes	Record length 3 4 bytes	Text 30 bytes
198	78		84		34	Length in decimal
C6	4C		54		22	Length in hexadecimal
00C64040	004C4040		00544040		00224040	Edit listing

Printer carriage control tape

Printer spacing may be performed by a skip-to-channel command in which the control byte directs the printer to skip to the next hole punched in a given channel of the carriage control tape. The control byte may request a skip to channels 1 through 8, 10, and 11. Skipping may be performed before or after printing the current line.



Note: A request to skip to channels 0, 9, or 12 through 15 is illegal and should not appear on print tapes generated for standard US70 printers. US70 printers fitted with Special Forms Control F5278-10-10, -30, however, can accept a skip to channel 0, 9, or 12 command, and these control commands may appear on the print tapes.



The US70 carriage control conventions are shown in table 6-9.

The processing parameters for US70 carriage control are as follows:

US70	
INITIAL	TOF
DEFUALT	(OVR,PSP1)
ADVTAPE	YES
MASK	X'FF'
ASSIGN	See values in table 6-10.

UNIVAC tape JSL sample

The following figure provides a JSL sample

Figure 6-11. JSL sample for UNIVAC tapes

```

UNIVAC:JDL;                                000010
/*                                          */ 000020
/*      SYSTEM FOR UNIVAC SDF              */ 000030
/*                                          */ 000040
V1:    VFU TOF=4, BOF=63;                   000050
/*                                          */ 000060
        VOLUME      HOST=UNIVAC, LABEL=STANDARD, UNPACK=T4X3, 000070
                CODE=ASCII, LCODE=ASCII; 000080
        BLOCK       LENGTH=1344, FORMAT=PACK; 000090
        RECORD      LENGTH=400, FORMAT=PACK, PREAMBLE=6  STRUCTURE=VB, 000100
                LTHFLD=1; 000110
        LINE        DATA=(0,132), PCCTYPE=NONE, VFU=V1; 000120
/*                                          */ 000130
/*      TABLES AND CRITERIA FOR LOGICAL PROCESSING  */ 000140
/*                                          */ 000150
T1:    TABLE CONSTANT='0'77';              000160
T2:    TABLE CONSTANT='0'3056';            000170
/*                                          */ 000180
C1:    CRITERIA CONSTANT=(0,1,EQ,T1);        000190
C2:    CRITERIA CONSTANT=(0,2,EQ,T2);        000200
/*                                          */ 000210
        BDELETE TEST=(C1);                  000220
/*                                          */ 000230
/*                                          */ 000240
/*                                          */ 000250
/*      UNIVAC SDF                            */ 000260
/*                                          */ 000270
/*      THE FOLLOWING JDES WILL SUPPORT 9 TRACK LABELED AND NON  */ 000280
/*      LABELED UNIVAC SDF FORMATS. LABEL=STANDARD IS USED TO  */ 000290
/*      PROVIDE INPUT PROCESSOR WITH INFORMATION CONCERNING THE  */ 000300
/*      PRESENCE OF A LABEL CONDITION ONLY. THE LABEL FORMAT IS  */ 000310
/*      EXPECTED AS UNPACKED. CODE=ASCII IS REQUIRED IN ORDER TO  */ 000320
/*      OBTAIN THE ASCII TABLE FROM DISC, HOWEVER THE DATA FORMAT  */ 000330
/*      WITHIN THE REPORTS CAN BE EITHER FIELD DATA OR ASCII.  */ 000340
/*      PREAMBLE=6 IS REQUIRED IN ORDER TO PROCESS THE UNIVAC  */ 000350
/*      DATA CONTROL WORD PROCEEDING EACH DATA RECORD.  */ 000360
/*      BLOCKS SATISFYING CRITERIA C1 WILL BE DELETED.  */ 000370
/*                                          */ 000380
/*      CHARACTERISTICS                            */ 000390
/*                                          */ 000400
/*      LABELED TAPE                                1          */ 000410
/*      NON-LABELED, STACKED REPORTS, DJDE'S        2          */ 000420
/*      NON-LABELED                                3          */ 000430
/*      NON-LABELED, RECORD LENGTH=400              4          */ 000440
/*                                          */ 000450

```

```
/*                                     */ 000450
1:JOB;                                */ 000460
2:JOB;                                000470
    VOLUME LABEL=NONE;                000480
    RSTACK TEST=(C2);                 000490
    IDEN PREFIX=O'74', OFFSET=0, SKIP=4; 000500
3:JOB;                                000510
    VOLUME LABEL=NONE;                000520
4:JOB;                                000530
    VOLUME LABEL=NONE;                000540
    RECORD LENGTH=400;                000550
END;END;/* END OF UNIVAC SDF JDL */    000560
```

7. Xerox ANSI standard labeled tapes and unlabeled tapes

This chapter describes Xerox ANSI standard labeled and unlabeled tapes. It also includes carriage control conventions and a sample JSL.

Xerox labeled tapes

The Xerox/OSS accepts any of the following Xerox 9-track tapes:

- ANSI labeled tapes created under the CP-V system
- Unlabeled tapes whose data files conform to record formats, blocking factor, and carriage control requirements of this printing system
- Tapes with other label conventions if the data files conform to the record format, blocking factor, and carriage control requirements when these nonstandard labels are bypassed by operator procedures.

Control Program-Five (CP-V) and ANSI labeled tapes

ANSI labeled tapes created under CP-V conform to the requirements of ANSI Standard X3.27–1969 (refer to the ANSI tape section at the beginning of this manual). Labels processed by CP-V and the optional user labels are described in table 7-1.

Table 7-1. **CP-V ANSI labels**

Type	Operating system labels	User labels
Beginning-of-volume	VOL1	None permitted
Beginning-of-file	HDR1, HDR2	UHL1 (optional)
End-of-volume	EOF1, EOF2	UTL1 (optional)
End-of-file	EOF1, EOF2	UTL1 (optional)

Unlabeled tapes

Unlabeled tapes whose data files conform to the requirements of this printing system can be processed by Xerox/OSS. Unlabeled file arrangements and formats are shown in figure 7-1.

Nonstandard labels

Tapes that have nonstandard labels, but whose data files conform to the requirements of this printing system can be processed by the Xerox/OSS. This is done by bypassing the labels using a simple operator procedure, then treating the data file as unlabeled. Nonstandard labeled tapes can also be processed as undefined tapes (see chapter 14, "Undefined tapes").

Figure 7-1. Unlabeled tape structure

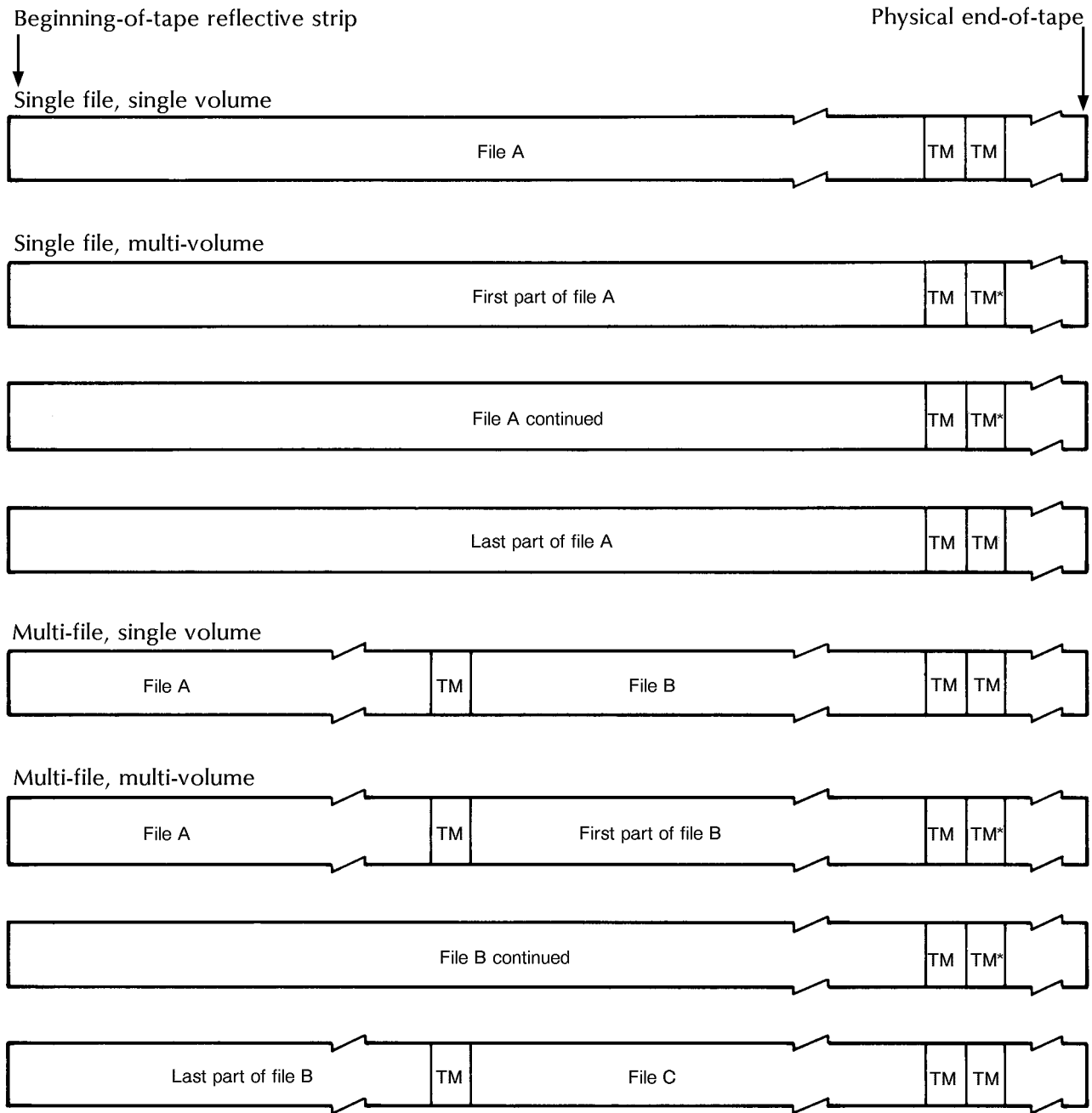

* The tape marks must appear after the end-of-tape reflective strip

Carriage control conventions

The Xerox/OSS accepts Xerox 7440, 7445, and 7446 printer carriage control characters (Xerox tapes). These conventions are shown in table 7-2.

Table 7-2. **Xerox printer control characters**

Code (hexadecimal)	Function
60 or E0	Inhibit automatic upspace after printing.*
C0 or 40	Space 0 lines, print, and upspace 1 line.
C1	Space 1 line, print, and upspace 1 line.
C2	Space 2 line, print, and upspace 1 line.
C3	Space 3 line, print, and upspace 1 line.
C4	Space 4 line, print, and upspace 1 line.
C5	Space 5 line, print, and upspace 1 line.
C6	Space 6 line, print, and upspace 1 line.
C7	Space 7 line, print, and upspace 1 line.
C8	Space 8 line, print, and upspace 1 line.
C9	Space 9 line, print, and upspace 1 line.
CA	Space 10 line, print, and upspace 1 line.
CB	Space 11 line, print, and upspace 1 line.
CC	Space 12 line, print, and upspace 1 line.
CD	Space 13 line, print, and upspace 1 line.
CE	Space 14 line, print, and upspace 1 line.
CF	Space 15 line, print, and upspace 1 line.
D0	Skip to channel 0, print, and inhibit upspace.
D1	Skip to channel 1, print, and inhibit upspace.
D2	Skip to channel 2, print, and inhibit upspace.
D3	Skip to channel 3, print, and inhibit upspace.
D4	Skip to channel 4, print, and inhibit upspace.
D5	Skip to channel 5, print, and inhibit upspace.
D6	Skip to channel 6, print, and inhibit upspace.
D7	Skip to channel 7, print, and inhibit upspace.
E0	Space 0 lines, print, and inhibit automatic upspace after printing.

* These characters in combination with the characters that inhibit automatic upspace will be processed according to the job descriptor entry selected for overprint handling.

Table 7-2. Xerox printer control characters (continued)

Code (hexadecimal)	Function
E1	Space 1 lines, print, and inhibit automatic upspace after printing.
E2	Space 2 lines, print, and inhibit automatic upspace after printing.
E3	Space 3 lines, print, and inhibit automatic upspace after printing.
E4	Space 4 lines, print, and inhibit automatic upspace after printing.
E5	Space 5 lines, print, and inhibit automatic upspace after printing.
E6	Space 6 lines, print, and inhibit automatic upspace after printing.
E7	Space 7 lines, print, and inhibit automatic upspace after printing.
E8	Space 8 lines, print, and inhibit automatic upspace after printing.
E9	Space 9 lines, print, and inhibit automatic upspace after printing.
EA	Space 10 lines, print, and inhibit automatic upspace after printing.
EB	Space 11 lines, print, and inhibit automatic upspace after printing.
EC	Space 12 lines, print, and inhibit automatic upspace after printing.
ED	Space 123lines, print, and inhibit automatic upspace after printing.
EE	Space 14 lines, print, and inhibit automatic upspace after printing.
EF	Space 15 lines, print, and inhibit automatic upspace after printing.
F0	Skip to channel 0, print, and upspace 1 line.
F1	Skip to channel 1, print, and upspace 1 line.
F2	Skip to channel 2, print, and upspace 1 line.
F3	Skip to channel 3, print, and upspace 1 line.
F4	Skip to channel 4, print, and upspace 1 line.
F5	Skip to channel 5, print, and upspace 1 line.
F6	Skip to channel 6, print, and upspace 1 line.

* These characters in combination with the characters that inhibit automatic upspace will be processed according to the job descriptor entry selected for overprint handling.

Table 7-2. **Xerox printer control characters** (continued)

Code (hexadecimal)	Function
F7	Skip to channel 7, print, and upspace 1 line.

* These characters in combination with the characters that inhibit automatic upspace will be processed according to the job descriptor entry selected for overprint handling.



Note: Under Xerox carriage control, a special case of page overflow processing can occur. If the bottom-of-form line number is encountered as the result of a skip-to-channel command, then print-and-space commands below bottom-of-form are allowed.



The processing parameters for Xerox carriage control are as follows:

	Xerox
INITIAL	TOF
DEFAULT	(IGN, PSP1)
ADVTAPE	YES
MASK	X'FF'
ASSIGN	Use values in table 7-2

Xerox tape JSL sample

The following figure provides a JSL sample.

Figure 7-2. JSL sample for Xerox tapes

```

XEROX:JDL;                                000010
/*          SYSTEM FOR XEROX TAPES          */ 000020
/*                                          */ 000030
V1:      VFU      ASSIGN=(1,5), ASSIGN=(2,10), ASSIGN=(3,15), 000040
          ASSIGN=(4,20), ASSIGN=(5,25), ASSIGN=(6,30), 000050
          ASSIGN=(7,35), ASSIGN=(8,40), ASSIGN=(9,45), 000060
          ASSIGN=(10,50), ASSIGN=(11,55), ASSIGN=(12,60), 000070
          TOF=5, BOF=66; 000080
/*                                          */ 000090
          VOLUME  HOST=XEROX, LABEL=ANSI, CODE=EBCDIC, PLABEL=YES; 000100
          BLOCK   LENGTH=4096, PREAMBLE=0, LTHFLD=0; 000110
          RECORD  PREAMBLE=0, STRUCTURE=FB; 000120
          LINE    DATA=(1,132), PCCTYPE=XEROX, PCC=(0,NOTRAN), 000130
          OVERPRINT=(MERGE,NODISP), VFU=V1; 000140
          ACCT    USER=(BIN,TRAY); 000150
PR:CATALOG; 000160
          BLOCK   LENGTH=4000, LTHFLD=2, PREAMBLE=4, FORMAT=BIN; 000170
          RECORD  LENGTH=136, PREAMBLE=4, STRUCTURE=VB, LTHFLD=2, 000180
          FORMAT=BIN; 000190
UU:CATALOG; 000200
          VOLUME  LABEL=NONE; 000210
          BLOCK   LENGTH=133; 000220
          RECORD  STRUCTURE=U; 000230
          LINE    PCCTYPE=NONE, DATA=(0,132); 000240
U4:CATALOG; 000250
          VOLUME  LABEL=NONE; 000260
          BLOCK   LENGTH=4096; 000270
          RECORD  STRUCTURE=U; 000280
          LINE    PCCTYPE=NONE, DATA=(0,132); 000290
FB:CATALOG; 000300
          VOLUME  LABEL=NONE; 000310
          BLOCK   LENGTH=3990; 000320
          RECORD  LENGTH=133, STRUCTURE=FB; 000330
          LINE    PCCTYPE=NONE, DATA=(0,132); 000340
/*                                          */ 000350
/*                                          */ 000360
/*          XEROX ANSI LABELED AND UNLABELED TAPES          */ 000370
/*          -----                                          */ 000380
/*                                          */ 000390
/*          THE FOLLOWING JDES WILL PRINT A VARIETY OF XEROX TAPES - */ 000400
/*          BOTH ANSI LABELED AND UNLABELED          */ 000410
/*                                          */ 000420
/*          CHARACTERISTICS          JOB          */ 000430
/*          -----          -----          */ 000440
/*          */ 000450
/*          ANSI-LABELED, FB, BLOCKED 3990, XEROX 11          */ 000460
/*          PCC          */ 000470
/*          ANSI-LABELED, U, BLOCKED 133, XEROX PCC 12          */ 000480
/*          UNLABELED, BLOCKED 3990, FB, XEROX PCC 13          */ 000490
/*          UNLABELED, BLOCKED 3960, FB, XEROX PCC 14          */ 000500
/*          UNLABELED, BLOCKED 133, U, XEROX PCC 15          */ 000510
/*          */ 000520

```

```

11:JOB;                                000530
    VOLUME    HOST=XEROX, LABEL=ANSI;  000540
    BLOCK     LENGTH=3990;             000550
    RECORD    LENGTH=133, STRUCTURE=FB; 000560
12:JOB;                                000570
    VOLUME    HOST=XEROX, LABEL=ANSI;  000580
    BLOCK     LENGTH=133;              000590
    RECORD    LENGTH=133, STRUCTURE=FB; 000600
13:JOB;                                000610
    VOLUME    HOST=XEROX, LABEL=NONE;  000620
    BLOCK     LENGTH=3990;             000630
    RECORD    LENGTH=133, STRUCTURE=FB; 000640
14:JOB;                                000650
    VOLUME    HOST=XEROX, LABEL=NONE;  000660
    BLOCK     LENGTH=3960;             000670
    RECORD    LENGTH=132, STRUCTURE=FB; 000680
15:JOB;                                000690
    VOLUME    HOST=XEROX, LABEL=NONE;  000700
    BLOCK     LENGTH=133;              000710
    RECORD    LENGTH=133, STRUCTURE=U;  000720
/*                                     */ 000730
/*           JDES FOR UTILITY PRINTOUTS  */ 000740
/*           -----                    */ 000750
/*                                     */ 000760
/* THE FOLLOWING JDES WILL ALLOW PRINTOUTS OF MOST TAPES  */ 000770
/* WITHOUT ATTEMPTING TO PROPERLY DEBLOCK THE TAPE.      */ 000780
/*                                     */ 000790
/*           CHARACTERISTICS                JOB           */ 000800
/*           -----                    -----           */ 000810
/*                                     */ 000820
/*           UNBLOCKED, NO PCC                31           */ 000830
/*           BLOCKED 4096, U. NO PCC          32           */ 000840
/*           BLOCKED 3990, FB, NO PCC        33           */ 000850
/*                                     */ 000860
31:JOB;                                000870
    VOLUME    LABEL=NONE;              000880
    BLOCK     LENGTH=133;              000890
    RECORD    STRUCTURE=U;             000900
    LINE      PCCTYPE=NONE, DATA=(0, 132); 000910
32:JOB;                                000920
    VOLUME    LABEL=NONE;              000930
    BLOCK     LENGTH=4096;             000940
    RECORD    STRUCTURE=U;             000950
    LINE      PCCTYPE=NONE, DATA=(0, 132); 000960
33:JOB;                                000970
    VOLUME    LABEL=NONE;              000980
    BLOCK     LENGTH=3990;             000990
    RECORD    LENGTH=133, STRUCTURE=FB; 001000
    LINE      PCCTYPE=NONE, DATA=(0, 132); 001010
END;END; /* END OF JDL */             001020

```

8. Medium Burroughs system tapes

The Xerox/OSS accepts two basic tape formats from the Medium Burroughs systems (B2500, B2700, B3500, B3700, and B4700 computers): printer backup and non-printer backup ANSI. The features which distinguish printer backup tapes are:

- "BACKUP" in the label field
- Block length is 136 words (6 characters per word)
- Record structure is FB
- Carriage control is a 4-byte field.

Figure 8-1. **Format of the Burroughs standard label for a printer backup tape**

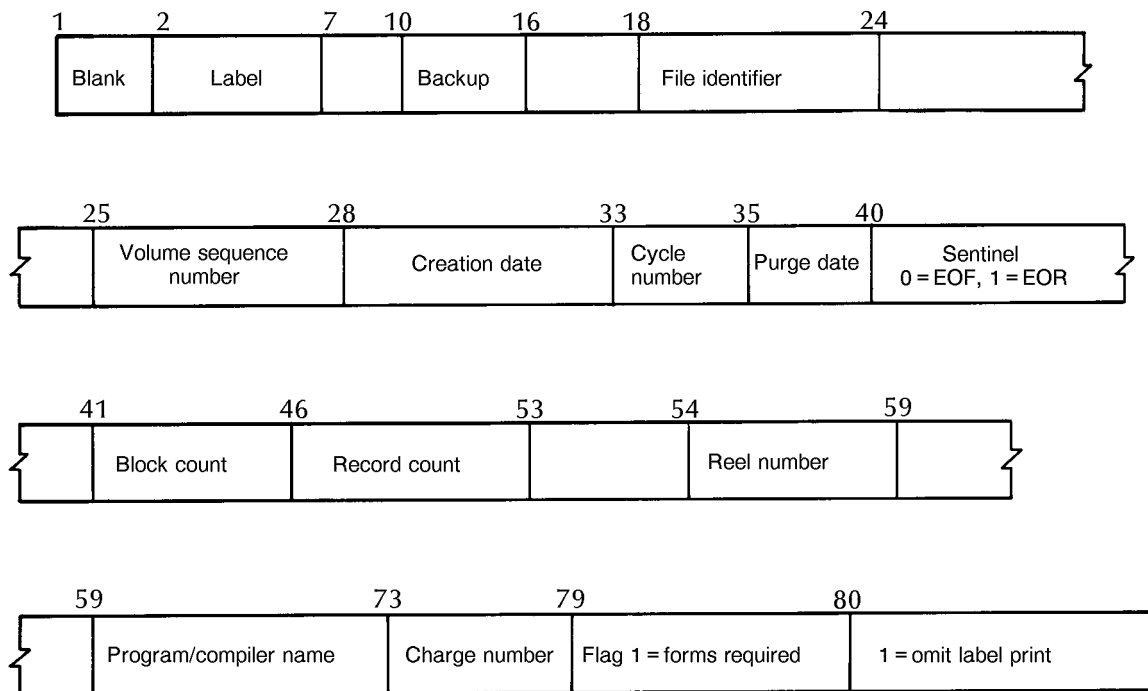

Record format

The record structure is "FB" for blocked, fixed length records. The block has no header, length indicator, or postamble; it may be truncated to less than maximum block size, but always contains a number of bytes equal to an exact multiple of the record length.

The record structure consists of 4 bytes of carriage control information followed by 132 bytes of print data (which may not be used if the carriage control code selects a "no-print" option).

Label types

ANSI labeled tapes created under a Burroughs operating system conform to the requirements of ANSI labels detailed at the beginning of this manual. Burroughs standard labels are shown in figures 8-2 through 8-5.

Figure 8-2. **Standard label tape example #1 (Burroughs)**

Single file, single volume

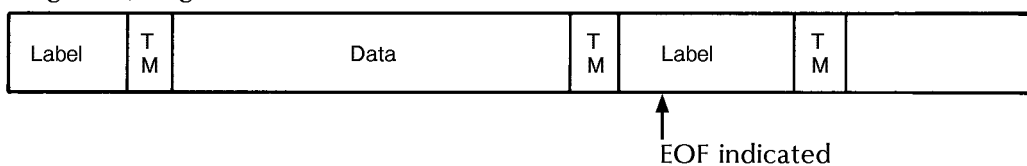

Figure 8-3. **Standard label tape example #2 (Burroughs)**

Single file, multi-volume

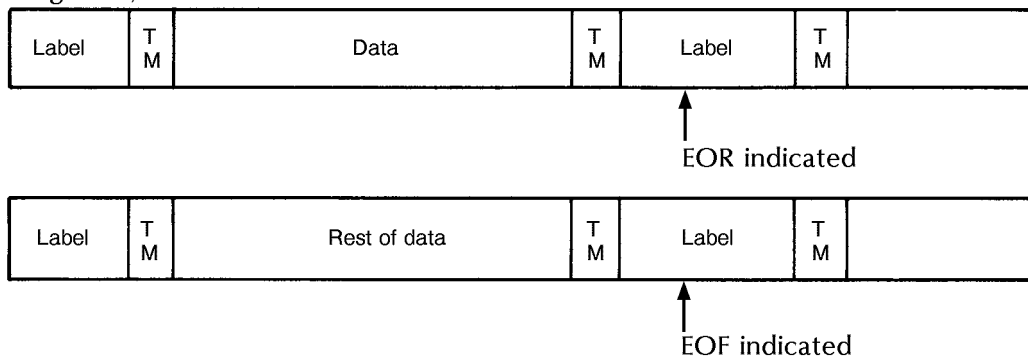

Figure 8-4. **Standard label tape example #3 (Burroughs)**

Multi-file, single volume

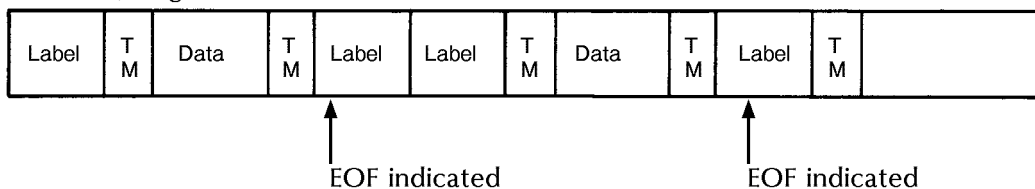
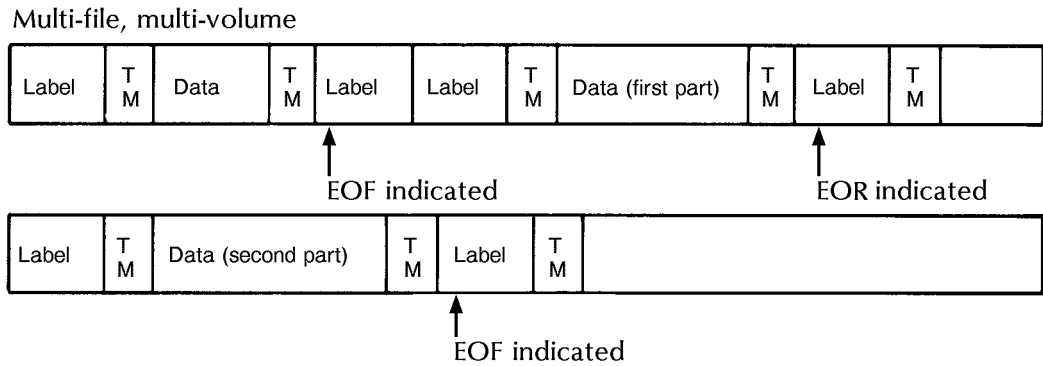

Figure 8-5. **Standard label tape example #4 (Burroughs)**

Tape configurations

The four basic configurations which can be processed by the printing system are listed below; an example of a standard label tape for each configuration is contained in the figure which is referenced.

- Single-file, single-volume (figure 8-2)
- Single-file, multi-volume (figure 8-3)
- Multi-file, single-volume (figure 8-4)
- Multi-file, multi-volume (figure 8-5).

Carriage control conventions

The Xerox/OSS accepts Burroughs printer carriage control conventions as shown in table 8-1. Note that the values listed are represented as EBCDIC characters: for example, the hexadecimal equivalent for the first listing is X'F0F0F2F0' (no print and space zero lines).

Table 8-1. **Burroughs 4700 four-byte printer carriage control**

Value	Function	Value	Function
0020	No print, space 0 lines (No operation)	0021	No print, skip to channel 1
0120	No print, space 1 line	0022	No print, skip to channel 2
0220	No print, space 2 line	0023	No print, skip to channel 3
.	.	.	.
.	.	.	.
.	.	.	.
9820	No print, space 98 line	0028	No print, skip to channel 8
9920	No print, space 99 line	0029	No print, skip to channel 9
		0030	No print, skip to channel 10

Table 8-1. **Burroughs 4700 four-byte printer carriage control** (continued)

Value	Function	Value	Function
		0031	No print, skip to channel 11
0000		0001	Print, skip to channel1
0100	Print, space 1 lines	0002	Print, skip to channel2
0200	Print, space 2 lines	0003	Print, skip to channel3
.	.	.	.
.	.	.	.
.	.	.	.
9800	Print, space 98 lines	0009	Print, skip to channel9
9900	Print, space 99 lines	0010	Print, skip to channel10
		0011	Print, skip to channel11

The processing parameters for all medium Burroughs carriage control are as follows:

medium Burroughs B2500, B2700, B3500, B3700, or B4700	
INITIAL	TOF
DEFAULT	(OVR, PSP1)
ADVTAPE	YES
MASK	X'FF
ASSIGN	Use values in table 8-1.

1. During label processing the printing software ascertains whether or not a tape is a printer backup tape. Therefore, no special specification for printer backup is needed in the LABEL left/right parts.
2. The label is printed on a printer backup tape if one or more of the following is true
 - The JDE contains the specification PLABEL = YES.
 - The label print flag in the label is zero.
 - The forms required flag in the label is set.

In the first case above, the ending labels as well as the start-of-file labels are printed.

Burroughs tape JSL sample

The following figure provides a JSL sample.

Figure 8-6. JSL sample for Burroughs tapes

```

BUR:JDL;                                000010
/*                                     */ 000020
/* SYSTEM TO PRINT BURROUGHS MEDIUM SYSTEM AND BURROUGHS */ 000030
/* LARGE SYSTEM PRINTER BACKUP TAPE FORMATS */ 000040
/*                                     */ 000050
/*                                     */ 000060
V1: VFU ASSIGN=(1,5), ASSIGN=(2,10), ASSIGN=(3,15), 000070
      ASSIGN=(4,20), ASSIGN=(5,25), ASSIGN=(6,30), 000080
      ASSIGN=(7,35), ASSIGN=(8,40), ASSIGN=(9,45), 000090
      ASSIGN=(10,50), ASSIGN=(11,55), TOF=5, BOF=66; 000100
/*                                     */ 000110
/* USER TRANSLATION TABLE FOR BURROUGHS ALTERS LEFT AND */ 000120
/* RIGHT BRACKETS AND EXCLAMATION MARK */ 000130
/*                                     */ 000140
/* CODE DEFAULT=EBCDIC, ASSIGN=(X'4A',X'B4'), ASSIGN=(X'5A', 000150
      X'B5'), ASSIGN=(X'D0',X'5A'); 000160
/*                                     */ 000170
/* VOLUME HOST=B4700, LABEL=STANDARD, CODE=US LCODE=USER, 000180
      PLABEL=YES; 000190
/* BLOCK LENGTH=816, PREAMBLE=0, POSTAMBLE=0; 000200
/* RECORD LENGTH=136, STRUCTURE=FB; 000210
/* LINE DATA=(4,132), PCCTYPE=B4700, PCC=(0,NOTRAN), 000220
      OVERPRINT=(MERGE,NODISP), VFU=V1; 000230
/* ACCT USER=(BIN,TRAY); 000240
/*                                     */ 000250
/*                                     */ 000260
/* CATALOG TO PRINT BURROUGHS LARGE SYSTEM (B6700 AND B7700)*/ 000270
/* PRINTER BACKUP TAPES */ 000280
/*                                     */ 000290
LB:CATALOG; 000300
/* VOLUME HOST=B6700, LABEL=ANSI, CODE=USER, LCODE=USER, 000310
      BMULT=6, RMULT=6, PLABEL=YES; 000320
/* BLOCK LENGTH=1800, LTHFLD=0, PREAMBLE=0, POSTAMBLE=0; 000330
/* RECORD LENGTH=138, STRUCTURE=VB, LTHFLD=2, OFFSET=4, 000340
      LMULT=6, FORMAT=BIN, ADJUST=6, PREAMBLE=6; 000350
/* LINE MARGIN=1, DATA=(0,132), PCCTYPE=B670 PCC=(0,NOTRAN), 000360
      OVERPRINT=(MERGE,NODISP), VFU=V1; 000370
/*                                     */ 000380
/*                                     */ 000390
/*                                     */ 000400
/* BURROUGHS MEDIUM SYSTEM SUPPORT */ 000410
/* ----- */ 000420
/* ----- */ 000430
/* THE FOLLOWING JDES WILL PRINT BOTH LABELED AND UNLABELED */ 000440
/* TAPES FROM THE BURROUGHS MEDIUM SYSTEMS (B2500, B2700, */ 000450
/* B3500,B3700, AND B4700. */ 000460
/*                                     */ 000470

```

```

/*      CHARACTERISTICS                JOB                */      000480
/*      -----                -----                */      000490
/*      */      000500
/*      LABELED PRINTER BACKUP TAPE      1                */      000510
/*      UNLABELED PRINTER BACKUP TAPE    2                */      000520
/*      NON-PRINTER BACKUP ANSI TAPE     3                */      000530
/*      */      000540
1:JOB;                                     000550
      VOLUME  HOST=B4700, LABEL=STANDARD, CODE=USER, LCODE=USER; 000560
2:JOB;                                     000570
      VOLUME  HOST=B4700, LABEL=NONE, CODE=USER;                   000580
3:JOB;                                     000590
      VOLUME  HOST=B4700, LABEL=STANDARD, CODE=USER, LCODE=USER; 000600
      BLOCK   LENGTH=1330;                                         000610
      RECORD  LENGTH=133, STRUCTURE=FB                             000620
      LINE    DATA=(1, 132), PCCTYPE=ANSI, PCC=(0,NOTRAN         000630
/*      */      000640
/*      */      000650
/*      BURROUGHS LARGE SYSTEM SUPPORT      */      000660
/*      -----                -----                */      000670
/*      */      000680
/*      THE FOLLOWING JDES WILL PRINT BOTH LABELED PRINTER BACKUP*/      000690
/*      AND STANDARD ANSI-LABELED TAPES FROM THE BURROUGHS LARGE */      000700
/*      SYSTEMS (B6700 AND B7700).          */      000710
/*      */      000720
/*      CHARACTERISTICS                JOB                */      000730
/*      -----                -----                */      000740
/*      */      000750
/*      LABELED PRINTER BACKUP TAPE      31                */      000760
/*      STANDARD ANSI LABELED TAPE       32                */      000770
/*      */      000780
31:JOB  INCLUDE=(LB);                                               000790
      VOLUME  HOST=B6700, LABEL=ANSI;                               000800
32:JOB;                                     000810
      VOLUME  HOST=B6700, LABEL=ANSI, CODE=USER, LCODE=USER,     000820
      BMULT=6, RMULT=6;                                           000830
      BLOCK   LENGTH=1330;                                         000840
      RECORD  LENGTH=133, STRUCTURE=FB;                             000850
      LINE    DATA=(1,132), PCCTYPE=ANSI, PCC=(0,NOTRAN);       000860
END;END;      /*      END OF BURROUGHS JDL */      000870

```

9. Large Burroughs system tapes

The Xerox/OSS accepts Burroughs large system printer backup tapes generated on the B6700 computer.

Burroughs labeled tapes

With the exception that labels may be multiples of six bytes in length, Burroughs printer backup tapes are labeled following the specifications for ANSI standard labels described previously in this manual.

Record format

Records are variable in length and are blocked into fixed length blocks of 300 6-byte words each. Each record begins with a 6-byte Input/Output Control Word (IOCW). The IOCW contains the printer carriage control, record length, and residual character count (variable length of record postamble). There is no block length given since each block is fixed at 300 6-byte words. Partially filled blocks are padded with zeros. An IOCW of all zeros signifies the end of data within a given block. (Refer to figure 9-1.)

Figure 9-1. Printer backup tape record format (Burroughs)

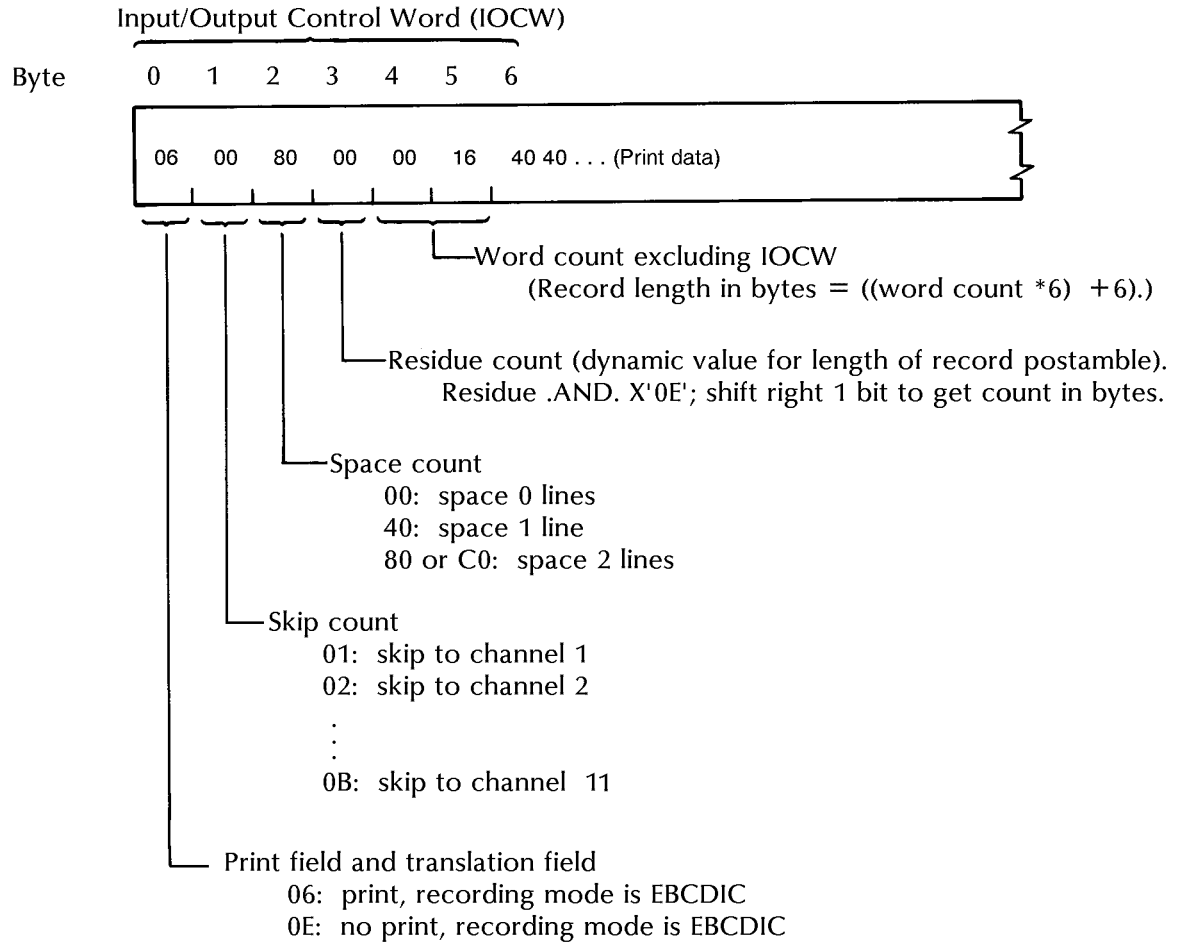

Line-up records

The first record of the first block in a Burroughs 6700 printer backup tape may be a line-up record containing a forms message.

- If this record is longer than 12 6-byte words and if a flag bit is set (bit 47 in the third 6-byte word following the IOCW), then the record does contain a forms message.
- The length byte of the line-up record includes the length of the forms message identifier and the length of the forms message text.
- The text of the message begins with the character immediately following the hexadecimal 15 (X'15').
- The channel control word in the line-up record is the code for a printer "no operation" (NOP).

The line-up record is recognized automatically as a stacked report delimiter by the Xerox/OSS. Furthermore, the line-up record is displayed to the operator when the printer is printing in single-report mode.

Carriage control

Burroughs carriage control does not have a character representative but, rather, is represented by a bit pattern in the IOCW. Refer to table 9-1 for the carriage control actions induced by each of the carriage control codes. Pre-job forms alignment is to top of form; the default for an invalid carriage control is to print and space one line.

Table 9-1. **Burroughs B6700 carriage control (IOCW*)**

IOCW*			
Byte 0	Byte 1	Byte 2	Function
06	01	00	Print, skip to channel 1
06	02	00	Print, skip to channel 2
06	03	00	Print, skip to channel 3
06	04	00	Print, skip to channel 4
06	05	00	Print, skip to channel 5
06	06	00	Print, skip to channel 6
06	07	00	Print, skip to channel 7
06	08	00	Print, skip to channel 8
06	09	00	Print, skip to channel 9
06	0A	00	Print, skip to channel 10
06	0B	00	Print, skip to channel 11
06	00	00	Print, skip to channel 1
06	00	00	Print, np space or skip
06	00	40	Print, space 1 line
06	00	80 or C0	Print, space 2 lines

The above series may also appear with byte 0 equal to 0E which means "no print."

*IOCW is the input/output control word.

The processing parameters for large Burroughs carriage control are as follows:

B6700	
INITIAL	TOF
DEFAULT	(OVR,PSPI)
ADVTAPE	YES
MASK	X'FF'
ASSIGN	Values are decoded from the IOCW when the print record is processed (see table 9-1).

Character set

The Burroughs EBCDIC character set is used. This character set differs from the Xerox EBCDIC character set for the following characters:

- [(left bracket) = X'4A'
-] (right bracket) = X'5A'
- ! (exclamation mark) = X'D0'

Burroughs 6700 printer backup tapes may be written either in EBCDIC or BCD. Only EBCDIC mode printer backup tapes are supported.

Burroughs tape JSL sample

The following figure provides a JSL sample.

Figure 9-2. JSL sample for Burroughs tapes

```

/*                                     */ 000250
/*                                     */ 000260
/* CATALOG TO PRINT BURROUGHS LARGE SYSTEM (B6700 AND B7700) */ 000270
/* PRINTER BACKUP TAPES                                     */ 000280
/*                                                         */ 000290
LB:CATALOG;
  VOLUME  HOST=B6700, LABEL=ANSI, CODE=USER, LCODE=USER,    000310
          BMULT=6, RMULT=6, PLABEL=YES;                    000320
  BLOCK   LENGTH=1800, LTHFLD=0, PREAMBLE=0, POSTAMBLE=0;  000330
  RECORD  LENGTH=138, STRUCTURE=VB, LTHFLD=2, OFFSET=4,    000340
          LMULT=6, FORMAT=BIN, ADJUST=6, PREAMBLE=6;      000350
  LINE    MARGIN=1, DATA=(0,132), PCCTYPE=B6700, PCC=(0,NOTRAN),
          OVERPRINT=(MERGE,NODISP), VFU=V1;                000370
/*                                     */ 000380
/*                                     */ 000390
/*                                     */ 000400
BUR:JDL;
/*                                     */ 000020
/* SYSTEM TO PRINT BURROUGHS MEDIUM SYSTEM AND BURROUGHS  */ 000030
/* LARGE SYSTEM PRINTER BACKUP TAPE FORMATS                 */ 000040
/*                                                         */ 000050
/*                                                         */ 000060
V1:    VFU    ASSIGN=(1,5), ASSIGN=(2,10), ASSIGN=(3,15),   000070
          ASSIGN=(4,20), ASSIGN=(5,25), ASSIGN=(6,30),     000080
          ASSIGN=(7,35), ASSIGN=(8,40), ASSIGN=(9,45),     000090
          ASSIGN=(10,50), ASSIGN=(11,55), TOF=5, BOF=66;   000100
/*                                     */ 000110
/* USER TRANSLATION TABLE FOR BURROUGHS ALTERS LEFT AND  */ 000120
/* RIGHT BRACKETS AND EXCLAMATION MARK                       */ 000130
/*                                                         */ 000140
/* CODE    DEFAULT=EBCDIC, ASSIGN=(X'4A',X'B4'),ASSIGN=(X'5A',  000150
          X'B5'), ASSIGN=(X'D0',X'5A');                    000160

```

```

/*          */ 000170
VOLUME  HOST=B4700, LABEL=STANDARD, CODE=USER, LCODE=USER, 000180
          PLABEL=YES; 000190
BLOCK   LENGTH=816, PREAMBLE=0, POSTAMBLE=0; 000200
RECORD  LENGTH=136, STRUCTURE=FB; 000210
LINE    DATA=(4,132), PCCTYPE=B4700, PCC=(0,NOTRAN), 000220
          OVERPRINT=(MERGE,NODISP), VFU=V1; 000230
ACCT    USER=(BIN,TRAY); 000240
/*          BURROUGHS MEDIUM SYSTEM SUPPORT          */ 000410
/*          -----          */ 000420
/*          */ 000430
/*          THE FOLLOWING JDES WILL PRINT BOTH LABELED AND UNLABELED */ 000440
/*          TAPES FROM THE BURROUGHS MEDIUM SYSTEMS (B2500, B2700, */ 000450
/*          B3500,B3700, AND B4700.          */ 000460
/*          */ 000470
/*          CHARACTERISTICS          JOB          */ 000480
/*          -----          -----          */ 000490
/*          */ 000500
/*          LABELED PRINTER BACKUP TAPE          1          */ 000510
/*          UNLABELED PRINTER BACKUP TAPE          2          */ 000520
/*          NON-PRINTER BACKUP ANSI TAPE          3          */ 000530
/*          */ 000540
1:JOB; 000550
VOLUME  HOST=B4700, LABEL=STANDARD, CODE=USER, LCODE=USER; 000560
2:JOB; 000570
VOLUME  HOST=B4700, LABEL=NONE, CODE=USER; 000580
3:JOB; 000590
VOLUME  HOST=B4700, LABEL=STANDARD, CODE=USER, LCODE=USER; 000600
BLOCK   LENGTH=1330; 000610
RECORD  LENGTH=133, STRUCTURE=FB; 000620
LINE    DATA=(1,132), PCCTYPE=ANSI, PCC=(0,NOTRAN); 000630
/*          */ 000640
/*          */ 000650
/*          BURROUGHS LARGE SYSTEM SUPPORT          */ 000660
/*          -----          */ 000670
/*          */ 000680
/*          THE FOLLOWING JDES WILL PRINT BOTH LABELED PRINTER BACKUP */ 000690
/*          AND STANDARD ANSI-LABELED TAPES FROM THE BURROUGHS LARGE */ 000700
/*          SYSTEMS (B6700 AND B7700).          */ 000710
/*          */ 000720
/*          CHARACTERISTICS          JOB          */ 000730
/*          -----          -----          */ 000740
/*          */ 000750
/*          LABELED PRINTER BACKUP TAPE          31          */ 000760
/*          STANDARD ANSI LABELED TAPE          32          */ 000770
/*          */ 000780
31:JOB  INCLUDE=(LB); 000790
VOLUME  HOST=B6700, LABEL=ANSI; 000800
32:JOB; 000810
VOLUME  HOST=B6700, LABEL=ANSI, CODE=USER, LCODE=USER, 000820
          BMULT=6, RMULT=6; 000830
BLOCK   LENGTH=1330; 000840
RECORD  LENGTH=133, STRUCTURE=FB; 000850
LINE    DATA=(1,132), PCCTYPE=ANSI, PCC=(0,NOTRAN); 000860
END;END; /*          END OF BURROUGHS JDL          */ 000870

```

10.

Honeywell tapes

The Xerox/OSS accepts magnetic tapes generated on Honeywell 200/2000 and 600/6000 systems. Supported label formats include standard 80-character labels, standard 120-character COBOL labels, System Print Type (SPR) labels, and standard system tape labels. Fixed-length records (bannered or unbannered) are supported on 9-track tapes in EBCDIC or 4 x 3 packed BCD; the SPR data format is a subset of this format. Variable-length records (bannered or unbannered) are supported on 9-track tapes in 4 x 3 packed BCD.

4 x 3 packed 6-bit character format

Octal data, 6-bit binary, or 6-bit character may be written on 9-track tape in a compressed 4 x 3 format. That is, four 6-bit data bytes are compressed into three 8-bit data bytes when the data is written to 9-track tape. Each 6-bit data byte is extracted and two high-order zeros are appended.

Two separate methods are used on Honeywell tapes to pack and code 6-bit characters. Figure 10-1 shows an example of how BCD characters on Honeywell 200/2000 tapes are translated to ASCII by the Xerox/OSS.

Figure 10-1. Pictorial representation of T4X3H2 packing

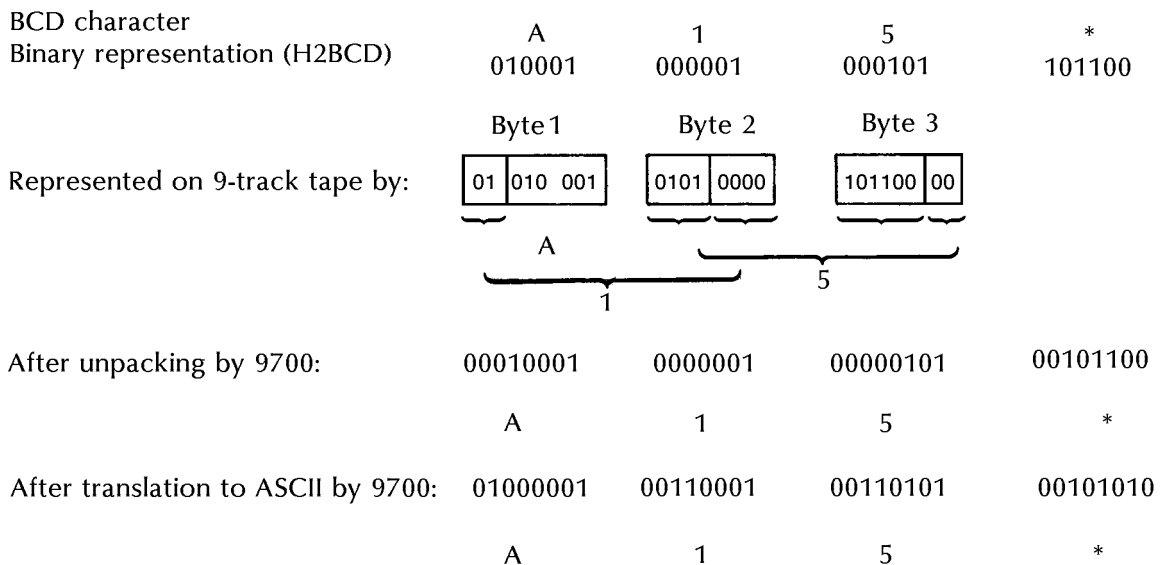

Table 10-1 shows the BCD to ASCII translation correspondences for Honeywell 200/2000. The corresponding packing and coding methods for Honeywell 600/6000 tapes are described later in this chapter.

Table 10-1. **Honeywell 200/2000 BCD table (6-bit representation)^t**

		Most Significant Bits								
		Octal (columns)	0	1	2	3	4	5	6	7
Least Significant Bits	(rows)	Binary	000	001	010	011	100	101	110	111
	0	000	0	8	+	H	-	Q	<	Y
	1	001	1	9	A	I	J	R	/	Z
	2	010	2	'	B	;	K	#	S	@
	3	011	3	=	C	.	L	\$	T	,
	4	100	4	:	D)	M	*	U	(
	5	101	5		E	%	N	"	V	{
	6	110	6	>	F	[O]	W	}
7	111	7	&	G	?	P	!	X		

Notes: '0'15' is the official blank character; '0'77' is the padding character.
^tCorresponds to BCD code set used by Honeywell 200/2000 users and defined by PDL command CODE = H2BCD.

Honeywell 200/2000 tape formats

The organization of Honeywell 200/2000 standard, COBOL, and SPR labeled tapes varies from user to user. The four basic file configurations are:

- Single-file, single-volume
- Single-file, multi-volume
- Multi-file, single-volume
- Multi-file, multi-volume.

These are illustrated in figure 10-2. The different label formats are shown in tables 10-2 through 10-7. Note that the tape marks shown in figure 10-2 are optional for the Honeywell 200/2000 formats.

Table 10-2. **Standard 1HDR label (Honeywell 200/2000 standard 80-character labeled tapes)**

Name	Character position(s)	Description
Label identifier	1-5	This is the 5-character identifier 1HDRb.
Volume serial number	6-10	This is the serial number unique to the physical tape reel.
File sequence number	11-16	This number is the same for all reels of a file, but is unique for each file.
Volume sequence number*	17-19	This number identifies the order of processing for this particular reel within the file
Reserved	20	Unspecified contents.
File identifier*	21-30	File name.
Creation date	31-35	This is the date the file was created (yyddd where yy = year and ddd = day).
Expiration date	36-40	This is the number of days the tape is to be retained before it may be scratched or overwritten (-ccc b where ccc = days).
Reserved	41-8	Unspecified contents.

* Used by the operating system.

Figure 10-2. **Standard, COBOL, and SPR labeled tape structure (Honeywell 200/2000)**

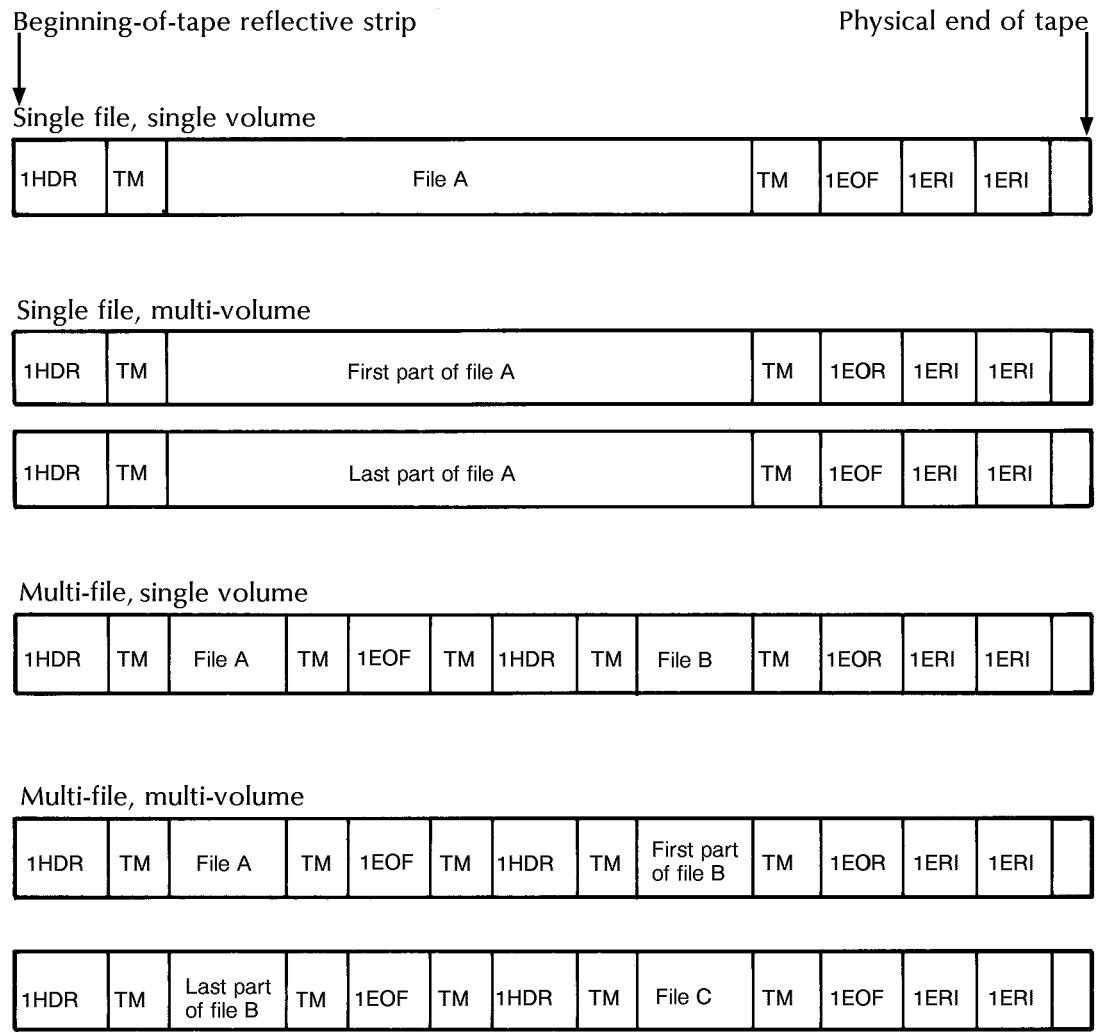

Table 10-3. **Standard 1EOF, 1EOR, 1ERL labels (Honeywell 200/2000 standard 80-character labeled tapes)**

Name	Character position(s)	Description
Label identifier	1-5	This is the 5-character identifier 1EOFb, 1EORb, or 1ERlb. 1EOFb denotes the end of a completed file. 1EORb denotes that the file continues onto another tape reel. 1ERlb denotes the end of all information on this reel.
Block count*	6-10	This is the number of data blocks contained on this reel of this file.
Record count	11-20	This is the number of data records (items) processed on this reel of this file. This field is blank for COBOL trailer labels.
Hash total	21-30	This is a host computer-generated value, which is altered each time the tape file is updated.
Reserved	31-80	Unspecified contents.

* Used by the operating system.

Table 10-4. **COBOL 1EOF, 1HDR, 1EOR labels (Honeywell 200/2000 standard 120-character labeled tapes)**

Name	Character position(s)	Description
Label identifier	1-5	This is a 5-character identifier 1HDRb, 1EOFb, or 1EORb. 1HDRb denotes the beginning-of-file. 1EOFb denotes the end of a completed file. 1EORb denotes that the file continues onto another tape reel.
Reserved	6	Unspecified contents.
Expiration date	7-10	This is the number of days the tape is to be retained before it may be scratched or overwritten (cccc in days).
Creation date	11-15	This is the date the file was created (yyddd where yy = year and ddd = day).
File identifier*	16-25	File name.
File sequence number	26-30	This number is the same for all reels of a file, but is unique for each file.
Volume serial number	31-35	This is the serial number unique to the physical tape reel.
Reserved	36	Unspecified contents.
Volume sequence number*	37-40	This number identifies the order of processing for this particular reel within the file.
Reserved	41-50	Unspecified contents.
System identifier	51-54	This identifies the operating system used to create this file.
Record structure	55	F indicates fixed format. V indicates variable format.
Record length*	56-60	This is a number that indicates the record length in characters.
Block length*	61-65	This is a number that indicates the block length in characters.
Checkpoint indicator	66	Checkpoint indicator (IBM format).
Block count*	67-72	This is the number of data blocks contained on this reel of a file. This field is processed from the 1EOF and 1EOR labels only.
Reserved	73-120	Unspecified contents.

* Used by the operating system.

Table 10-5. **SPR 1HDR label (Honeywell 200/2000 system print tapes)**

Name	Character position(s)	Description
Label identifier	1-5	This is a 5-character identifier 1HDRb.
Reserved	6-20	Unspecified contents.
Program-segment name	21-28	Program-segment name in the host EXEC statement for this job step.
Job step number	29	Octal number which denotes this job step.
Form type	30 31 32 33	Denotes printed paper form type (f) to be used for reports 1 through 4, where f = type (0-9, A-Z).
Reserved	34-40	Unspecified contents.
Record length	41-42	Octal number that indicates maximum record (item) length in bytes (always 0205).
Blocking factor	43-44	Octal number that indicates tape blocking factor.
Fixed record-length indicator	45	Fixed record-length indicator (always 1).
Block length	46-48	Octal number that indicates maximum block (physical record) length.
Reserved	49	Unspecified contents
Banner length*	50	Banner character length.
Volume sequence number*	51	Octal number (1-63) that indicates the tape reel number. This number is the order of the volume within the multi-volume group created at the same time.
File identifier*	52-61	ob name.
Job step part number	62	Octal number which denotes the job step part.
Beginning volume sequence number	63	Octal number (1-63) that indicates the tape reel number on which this job step part started.
Reserved	64-76	Unspecified contents.
File designator	77	Octal number which designates a file (always 40).
Peripheral control character length	78	Peripheral control character length (always 1).
Peripheral control character position	79-80	Relative position of the peripheral control character within each record (item) of the file (always 1).

* Used by the operating system.

Table 10-6. **SPR 1EOF, 1EOR labels (Honeywell 200/2000 system print tapes)**

Name	Character position(s)	Description
Label identifier	1-5	This is a 5-character identifier 1EOFb or 1EORb. 1EOFb denotes the end of a completed file. 1EORb denotes that the file continues onto another tape reel.
Reserved	6-10	Unspecified contents.
Block count (SPR)*	11-15	Decimal number that indicates SPR tape block count. Note that SPR tapes are written in odd parity.
Block count (SPU)*	16-20	Decimal number that indicates the SPU block count.
Program-segment name	21-30	Program-segment name in the host EXEC statement for this job step.
Reserved	31-80	Unspecified contents.

* Used by the operating system.

Table 10-7. **SPR 1ERL labels (Honeywell 200/2000 system print tapes)**

Name	Character position(s)	Description
Label identifier	1-5	This is a 5-character identifier 1ERlb which denotes the end of recorded information on this tape reel.
Reserved	6-80	Unspecified contents

Honeywell 200/2000 data formats

Records may be fixed or variable, blocked or unblocked, bannered or unbannered.

Bannered data format

Files with fixed and variable length records may be bannered. The banner characters appear as the first characters in the data block. Bannered files must be written in odd parity. The second banner character may contain a report number (refer to figure 10-3).

Figure 10-3. **Honeywell 200/2000 records with banner characters**

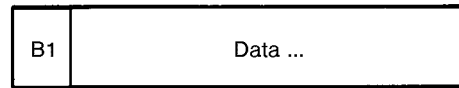

↑ Banner character; designates whether the data block is to be printed.

P = Print block
U = Punch block



↑ { Report number; designates which of four reports/files this block is associated with.
Banner character; designates whether the data block is to be printed.

P = Print block
U = Punch block

Variable length record format

Variable length tape blocks may be bannered or unbannered and may contain one or more variable length logical records (refer to figure 10-4). The actual block length is given by a three octal character binary number if the input tape is recorded in odd parity. The actual block length is given by a four octal character decimal number if the input tape is recorded in even parity. The block length includes its own length plus the banner character, if present.

The actual record length for a record is given by a two octal character binary number if the input tape is recorded in odd parity. The record length is given by a three octal character number if the input tape is recorded in even parity.

Figure 10-4. Honeywell 200/2000 variable length bannered and unbannered record format

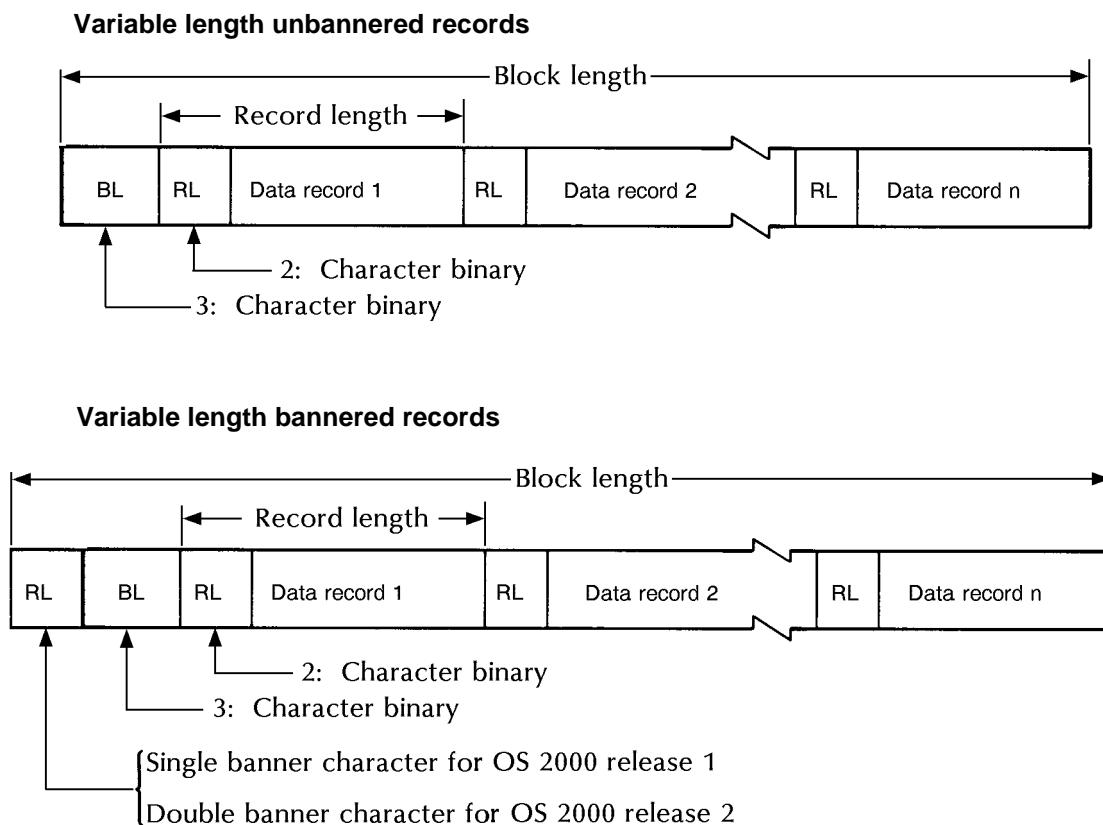

Fixed length record format

Fixed length tape blocks may be bannered or unbannered; they may contain one or more fixed length logical records. Each block contains the same number of records. The structure of fixed length records, as shown in figure 10-5, does not vary with the parity in which the input file is recorded.

Figure 10-5. Honeywell 200/2000 fixed length record structure

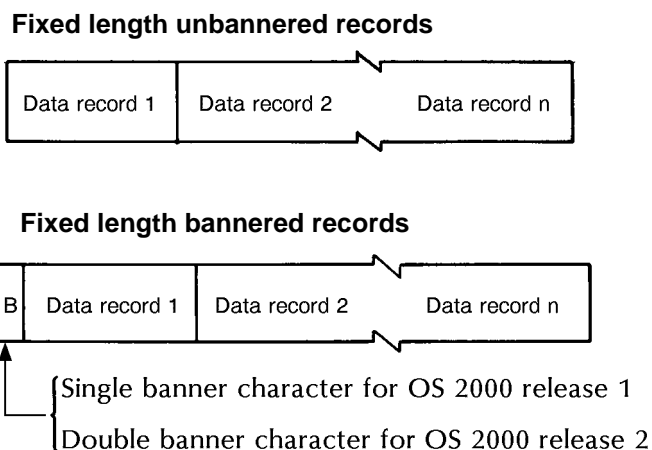

System print tape data format

System print tape (SPR) data consists of bannered data blocks. The record format is fixed, with 133 characters per record. The printer or carriage control character is the first character of the block. The number of records per block is set at system generation time.

Honeywell 200/2000 carriage control

Printer carriage control codes used on a system print (SPR) tape are shown in table 10-8.

Table 10-8. **Printer carriage control (Honeywell 200/2000 system printer tapes)**

Octal	Code		Function
	Hexadecimal		
00	00		Print, space 0 lines.*
01	01		Print, space 1 lines.*
02	02		Print, space 2 lines.*
03	03		Print, space 3 lines.*
04	04		Print, space 4 lines.
05	05		Print, space 5 lines.
06	06		Print, space 6 lines.
07	07		Print, space 7 lines.
10	08		Print, space 8 lines.
11	09		Print, space 9 lines.
12	0A		Print, space 10 lines.
13	0B		Print, space 11 lines.
14	0C		Print, space 12 lines.
15	0D		Print, space 13 lines.
16	0E		Print, space 14 lines.
17	0F		Print, space 15 lines.
20	10		Print, space 0 lines.*
21	11		Print, space 1 lines.*
22	12		Print, space 2 lines.*
23	13		Print, space 3 lines.*
24	14		Print, space 4 lines.*
25	15		Print, space 5 lines.*
26	16		Print, space 6 lines.*

* If bottom-of-form (BOF) detected during spacing, skip to top-of-form (TOF) and discontinue spacing.

Table 10-8. **Printer carriage control (Honeywell 200/2000 system printer tapes)** (continued)

Octal	Code		Function
	Hexadecimal		
27	17		Print, space 7 lines.*
30	18		Print, space 8 lines.*
31	19		Print, space 9 lines.*
32	1A		Print, space 10 lines.*
33	1B		Print, space 11 lines.*
34	1C		Print, space 12 lines.*
35	1D		Print, space 13 lines.*
36	1E		Print, space 14 lines.*
37	1F		Print, space 15 lines.*
40	20		Print, skip to channel 3.
41	21		Print, skip to channel 4.
42	22		Print, skip to channel 5.
43	23		Print, skip to channel 1.
44	24		Print, skip to channel 6.
45	25		Print, skip to channel 7.
46	26		Print, skip to channel 8.
47	27		Print, skip to channel 1.
50	28		No print, skip to channel 3.
51	29		No print, skip to channel 4.
52	2A		No print, skip to channel 5.
53	2B		No print, skip to channel 1.
54	2C		No print, skip to channel 6.
55	2D		No print, skip to channel 7.
56	2E		No print, skip to channel 8.
57	2F		No print, skip to channel 1.
60	30		No print, space 0 lines.
61	31		No print, space to 1 line.
62	32		No print, space to 2 lines.
63	33		No print, space to 3 lines.
64	34		No print, space to 4 lines.
65	35		No print, space to 5 lines.

* If bottom-of-form (BOF) detected during spacing, skip to top-of-form (TOF) and discontinue spacing.

Table 10-8. **Printer carriage control (Honeywell 200/2000 system printer tapes (continued)**

Octal	Code	
	Hexadecimal	Function
66	36	No print, space to 6 lines.
67	37	No print, space to 7 lines.
70	38	No print, space to 8 lines.
71	39	No print, space to 9 lines.
72	3A	No print, space to 10 lines.
73	3B	No print, space 11 lines.
74	3C	No print, space 12 lines.
75	3D	No print, space 13 lines.
76	3E	No print, space 14 lines.
77	3F	No print, space to 15 lines.

* If bottom-of-form (BOF) detected during spacing, skip to top-of-form (TOF) and discontinue spacing.

Processing parameters for Honeywell 200/2000 carriage control are as follows:

H200/H2000	
INITIAL	TOF
DEFAULT	(OVR, PSP1)
ADVTAPE	YES
MASK	'FF'
ASSIGN	Values shown in table 10-8.

Honeywell 600/6000 tape formats

Standard system format tape labels, which are described in the following section, are the only Honeywell 6000 tape labels supported. Variable length records on labeled tapes are supported on 9-track tapes when the data code is 4 x 3 packed BCD. The packing method and BCD coding used on Honeywell 6000 tapes are described in figure 10-6 and table 10-9. This tape format includes embedded control characters and normal edit printer carriage control.

Figure 10-6. Pictorial representation of T4X3 packing

BCD character	A	1	5	*
Binary representation	010001	000001	000101	101100
	1 byte	1 byte	1 byte	
Represented on 9-track tape by:	01000100 00010001 01101100			
	A	1	5	*
After unpacking by 9700:	00010001	00000001	00000101	00101100
	A	1	5	*
After translation to ASCII by 9700:	01000001	00110001	00110101	00101010
	A	1	5	*

Table 10-9. BCD to EBCDIC input/output correspondence (6-bit representation)[†]

		Most Significant Bits								
Octal (columns)		0	1	2	3	4	5	6	7	
(rows) Binary		000	001	010	011	100	101	110	111	
Least Significant Bits	0	000	0	8	space	H	$\neg 1$ $\wedge 2$	Q	+	Y
	1	001	1	9	A	I	J	R	/	Z
	2	010	2	[B	&	K	-	S	_
	3	011	3	#	C	.	L	\$	T	,
	4	100	4	@	D]	M	*	U	%
	5	101	5	:	E	(N)	V	=
	6	110	6	>	F	<	O	;	W	"
	7	111	7	?	G	\	P	'	X	!

- Notes: 1. Usual BCD Character
2. Printer Character

[†]Corresponds to BCD code set used by Honeywell 600/6000 series SSF tapes and defined by PDL command CODE = BCD or CODE = H6BCD.

The basic file configurations which are supported for Honeywell 6000 tapes are illustrated in figure 10-7. Label formats are shown in tables 10-10 through 10-12.

Figure 10-7. Honeywell 6000 standard labeled tape structure

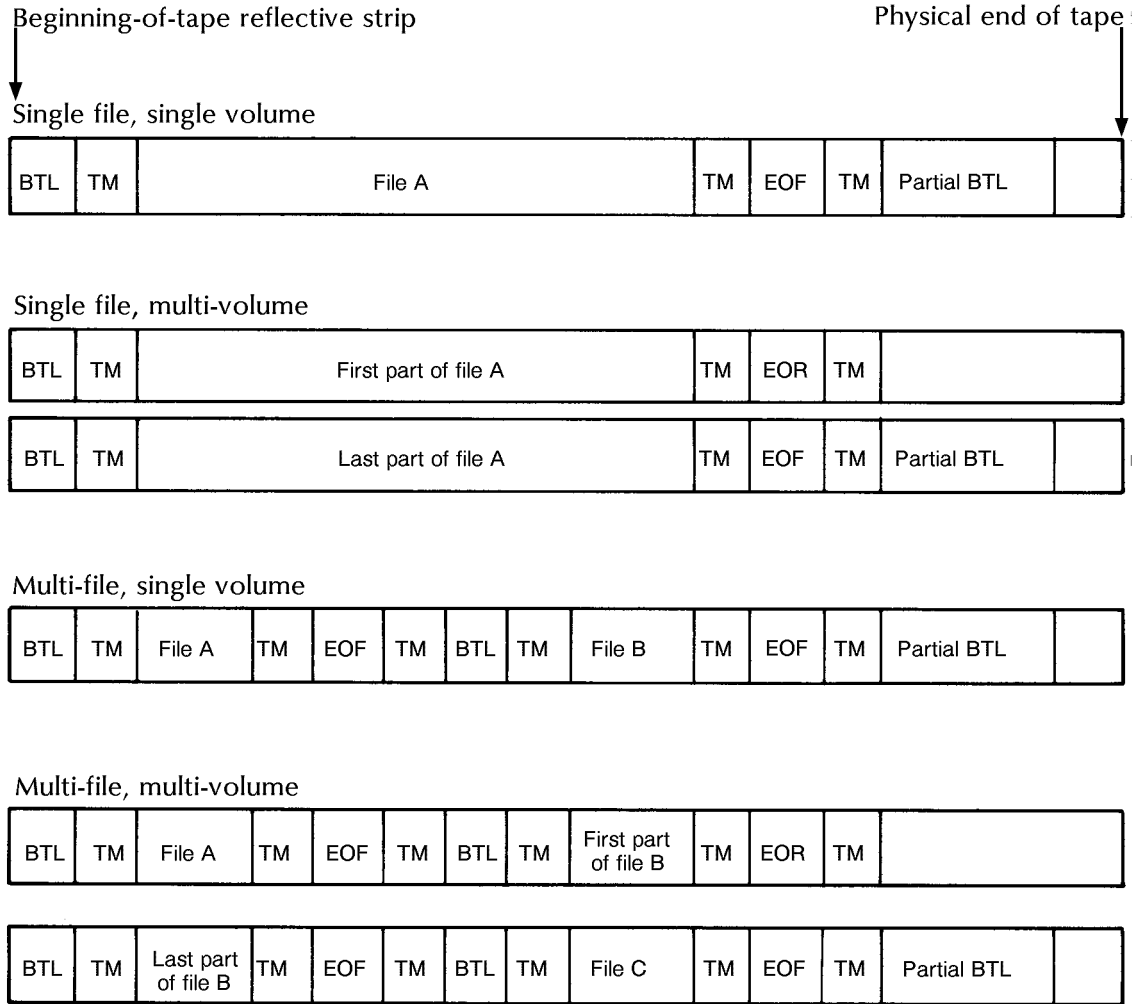

Key

BLT	Basic
TM	Tape Mark
EOF	End-of-File
EOR	End-of-Record

Table 10-10. **Standard basic tape label (Honeywell 600/6000 standard system format labeled tapes)**

Name	Character position	Description
Label identifier	1-12	This is a 12-character identifier: GEbb600bBTLb
Installation identification	13-18	This is constant information for a given user installation.
Volume serial number	19-24	This is the serial number of the physical tape reel.
Volume sequence number*	31-36	This is the number of the reel within a given file.
Creation date	37-42	This is the date the file was created (byydd where yy = year and ddd = day).
Expiration date	43-48	This is the number of days the tape is to be retained before it may be scratched
Expiration date	43-48	This is the number of days the tape is to be retained before it may be scratched or overwritten (bbbxxx where xxx = days).
File identifier*	49-60	File name.
Reserved	61-78	Unspecified contents.
Reel number error	79-84	Reel number in preceding EOR label is erroneous (always bbbbbb or PRVERR).

* Used by the operating system.

Table 10-11. **Standard EOR, EOF labels (Honeywell 600/6000 standard system format labeled tapes)**

Name	Character position(s)	Description
Label identifier	1-6	This is a 6-character identifier bEORbb or bEOFbb. bEORbb denotes that the file continues onto another tape reel. bBEOFbb denotes the end of a completed file.
Block count*	7-12	This is the number of data blocks contained on this reel of this file.
Reserved	13-78	Unspecified contents.
Next volume serial number	79-84	This is the serial number of the next physical tape reel if the tape contains an EOR label.

*Used by the operating system.

Table 10-12. **Standard partial basic tape label (Honeywell 600/6000 standard system format labeled tapes)**

Name	Character position(s)	Description
Label identifier	1-12	This is a 12-character identifier: GEbb600bBTLb.
Installation identification	13-18	This is constant information for a given user installation.
Volume serial number	19-24	This is the serial number of the physical tape reel.
Zeros*	26-60	Must be all zeros.
Reserved	61-84	Unspecified contents.

*Checked by the operating system.

Honeywell 600/6000 data formats

This section describes the data formats for the Honeywell 600/6000.

Variable length record format, Honeywell 6000 standard system tapes

Variable length records are limited to those files recorded in the binary mode (refer to figure 10-8).

Figure 10-8. **Honeywell 600/6000 variable length record format**

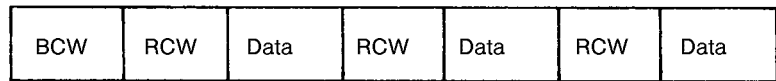

Key BCW Block Control Word
 RCW Record Control Word

The Block Control Word (BCW) exists as the first word of each physical tape block. It is structured as shown in table 10-13.

Table 10-13. **Honeywell 600/6000 block control word format**

Character position(s)	Bits	Description
1-3	0-17	Block serial number is the sequential number of this physical block.
4-6	18-35	Block size is the size of the block in words of (6 characters/word), not including this block control word BCW (octal).

The Record Control Word (RCW) is the first word of each logical record. It is structured as shown in table 10-14

Table 10-14. **Honeywell 600/6000 record control word format**

Character position(s)	Bits	Description
1-3	0-17	Record size is the size of the record in words (6 characters/word), not including this record control word RCW (octal).
4	18-19	Next available character position in the last data word: 00: full word (4 characters) used 01: 1 character used 10: 2 characters used 11: 3 characters used
4	20-23	Not used unless bits are zero.
5	24-29	Logical record media code. 0: not a media conversion record, or no printer slew controls 1: binary card image 2: Hollerith card image 3: print line image 4: reserved for user 5: time-sharing system ASCII 6: standard system format ASCII 7: ASCII print line images, with trailing printer slew control information 8: TSS information record
6	30-35	Report code identifying this record as one belonging to a specific report or punch deck. May be any combination of 6 bits.
Note: The printing system automatically selects records with media codes 02, 03, and 07 for printing.		

Data format with embedded control characters, normal edit mode (4 x 3 packed BCD)

Embedded control characters appear within the print line image and may appear singly or in pairs. These control characters must be processed on a left-to-right scan basis.



Note: Hexadecimal character codes have the 6-bit octal character in the rightmost six bits with the leftmost two bits set to zero, for example, the unpacked data format. References to character codes refer to the character value prior to translation to EBCDIC.



Single control characters

Ignore. The ignore character is an octal 17 (hexadecimal 0F). This character is deleted from the print line when not preceded by escape-escape paired control characters. That is, the print character preceding the ignore character, and the print character following the ignore character, are printed adjacent to each other.

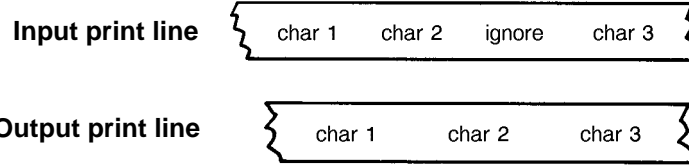

Paired control characters

The first character of all paired control characters is the escape character, which is an octal 77 (hexadecimal 3F).

Escape-escape. This pair is an octal 7777 (hexadecimal 3F3F). These characters are deleted (as in the single ignore character), and the character following the pair is always printed. When the ignore character is preceded by this pair of control characters, the pair is deleted from the print line, and the ignore character is printed.

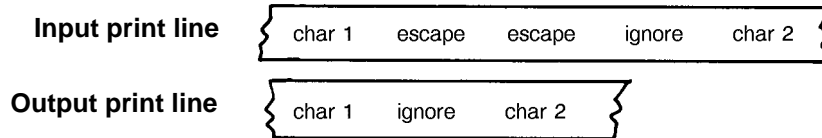

Escape-skip. This pair is an octal 77 followed by a 6-bit binary 10nnnn (hexadecimal 3F followed by an 8-bit binary 0010nnnn). The escape-skip pair is deleted from the output print line and causes spaces to be inserted into the output print line. The 8-bit binary number, 0nnnn000 (i.e., the binary number nnnn, 0 nnnn 15), multiplied by 8 is the number of spaces (0-120) to be inserted.

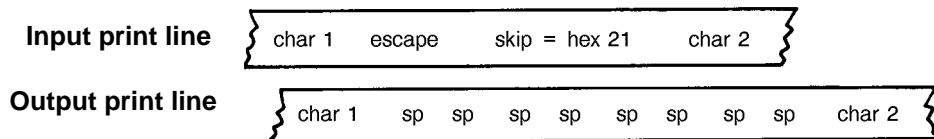

Escape-line feed. This pair is an octal 77 followed by a 6-bit binary 00xxxx (hexadecimal 3F followed by an 8-bit binary 0000xxxx). The escape-line feed pair, when deleted from the output print line, terminates the output print line and causes the paper to be fed xxxx binary number of lines after printing (where 0 xxxx F). Characters following this pair, but preceding the end of this logical record, are ignored.

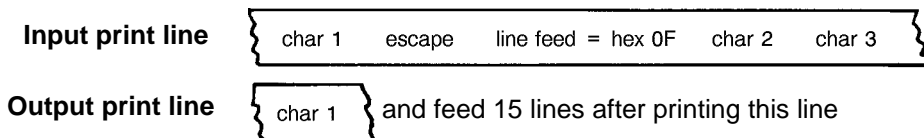

Escape-channel skip. This pair is an octal 77 followed by a 6-bit binary 01xxxx (hexadecimal 3F followed by an 8-bit binary 0001xxxx). The escape-channel skip pair, when deleted from the output print line, terminates the output print line and causes a skip to channel operation after printing (where xxxx is the binary channel number and 0 xxxx F). Characters following this pair, but preceding the end of this logical record, are ignored. Input print lineOutput print lineand skip to channel 12 after printing this line

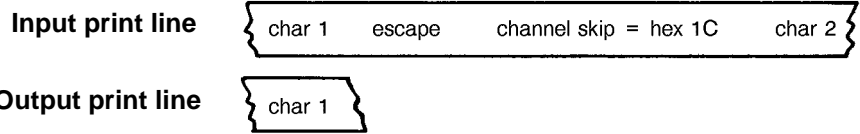

Escape-“other character”. This pair is an octal 77 followed by a 6-bit 11xxxx (hexadecimal 3F followed by an 8-bit binary 0011xxxx), where xxxx is not 1111. The pair is deleted from the output print line and no other action occurs.

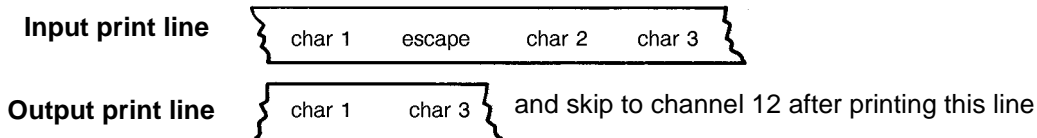

Data format with embedded control characters, normal edit mode (9 x 8 packed ASCII)

Embedded control characters appear within the print line image and may appear singly or in pairs. These control characters must be processed on a left-to-right scan basis.



Note: Hexadecimal character codes have the 9-bit octal character packed into an 8-bit byte with the 9th (high order) bit dropped. References to character codes refer to the character value prior to translation to EBCDIC.



Single control characters

Ignore. The ignore character is an octal 177 (hexadecimal 7F). This character is deleted from the print line when not preceded by escape-escape paired control characters. That is, the print character preceding the ignore character, and the print character following the ignore character, are printed adjacent to each other.

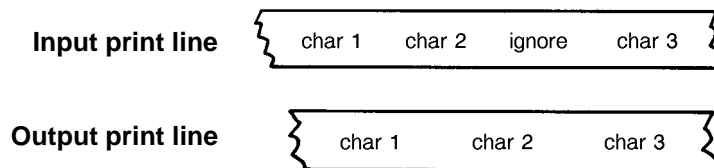

Paired control characters

Skip. This pair is an octal 37 (hexadecimal 1F) followed by a binary value from 0-127. The skip pair is deleted from the output print line and causes spaces to be inserted into the output print line. The binary value is the number of spaces to be inserted.

Input print line

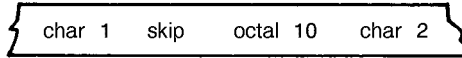

Output print line

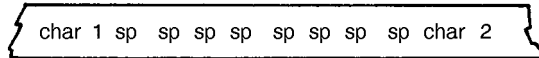

Line Feed. This pair is an octal 13 (hexadecimal 0B) followed by a binary value 0-127. The line feed pair, when deleted from the output print line, terminates the output print line and causes the paper to be fed xxx binary number of lines after printing (where 0 xxx F). Characters following this pair, but preceding the end of this logical record, are ignored.

Input print line

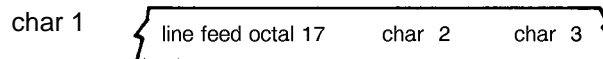

Output print line

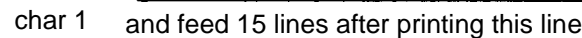

Channel skip. This pair is octal 14 (hexadecimal 0C) followed by a binary value 0-15. The channel skip pair, when deleted from the output print line, terminates the output print line and causes a skip to channel operation after printing (where xxx is the binary channel number and 0 xxx F). Characters following this pair, but preceding the end of this logical record, are ignored.

Input print line

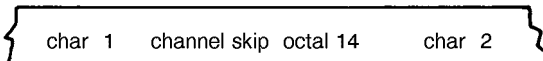

Output print line

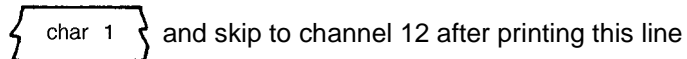

Tab. This pair is an octal 11 (hexadecimal 09) followed by a binary value 0-127. This tab pair, when deleted from the output print line, causes spaces to be inserted into the output print line. The binary value 0-127 specifies the print position to which it is desired to tab. Backward tabbing is allowed and causes print data to be replaced with blanks.

Input print line

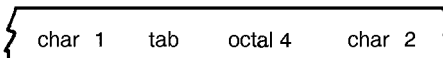

Output print line

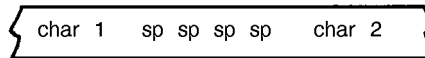

Carriage control (Honeywell 600/6000)

Carriage control codes to be paired with an escape character for the Honeywell 600/6000 normal edit mode are shown in table 10-15. (Note that the default value of print-and-space-1 is used when a line has been processed without encountering an escape-line feed or escape-channel skip pair.)

Table 10-15. **Printer carriage control (Honeywell 200/2000 system printer tapes)**

Code		
Octal	Hexadecimal	Function
00	00	Print, space 0 lines.
01	01	Print, space 1 line.
02	02	Print, space 2 lines.
03	03	Print, space 3 lines.
04	04	Print, space 4 lines.
05	05	Print, space 5 lines.
06	06	Print, space 6 lines.
07	07	Print, space 7 lines.
10	08	Print, space 8 lines.
11	09	Print, space 9 lines.
12	0A	Print, space 10 lines.
13	0B	Print, space 11 lines.
14	0C	Print, space 12 lines.
15	0D	Print, space 13 lines.
16	0E	Print, space 14 lines.
17	0F	Print, space 15 lines.
20	10	Print, skip to channel 0.
21	11	Print, skip to channel 1.
22	12	Print, skip to channel 2.
23	13	Print, skip to channel 3.
24	14	Print, skip to channel 4.
25	15	Print, skip to channel 5.
26	16	Print, skip to channel 6.
27	17	Print, skip to channel 7.
30	18	Print, skip to channel 8.
31	19	Print, skip to channel 9.

Note: An invalid code will be processed as a print and space 1 line.

Table 10-15. **Printer carriage control (Honeywell 200/2000 system printer tapes)** (continued)

Octal	Code	
	Hexadecimal	Function
32	1A	Print, skip to channel 10.
33	1B	Print, skip to channel 11.
34	1C	Print, skip to channel 12.
35	1D	Print, skip to channel 13.
36	1E	Print, skip to channel 14.
37	1F	Print, skip to channel 15.

Note: An invalid code will be processed as a print and space 1 line.

Processing parameters for Honeywell 600/6000 carriage control are as follows:

H600/H60009	
INITIAL	TOF
DEFAULT	(OVR, PSP1)
ADVTAPE	YES
MASK	X'FF'
ASSIGN	Use values in table 10-15.

Honeywell 2000 and 6000 tape JSL samples

The following figure provides a JSL sample.

Figure 10-9. JSL sample for Honeywell 2000 tapes

```

H2000:JDL;                                000010
/*                                         */ 000020
/*           SYSTEM FOR HONEYWELL 2000    */ 000030
/*           -----                      */ 000040
/*                                         */ 000050
/*                                         */ 000060
/*           VFU FOR HONEYWELL 2000 SPR   */ 000070
/*           TAPES - CHANNEL 2 IS BOF    */ 000080
V1:    VFU    ASSIGN=(1,5), ASSIGN=(2,61), 000090
        ASSIGN=(3,10),
        ASSIGN=(4,15), ASSIGN=(5,20),     000100
        ASSIGN=(6,25),
        ASSIGN=(7,30), ASSIGN=(8,35),     000110
        ASSIGN=(9,40),
        ASSIGN=(10,45), ASSIGN=(11,50),   000120
        ASSIGN=(12,55),
        TOF=5, BOF=66;                    000130
/*                                         */ 000140
/*                                         */ 000150
/*           VFU FOR HONEYWELL 2000     */ 000160
/*           STANDARD TAPES - CHANNEL 12  */ 000170
/*           IS BOF*/
V2:    VFU    ASSIGN=(1,5), ASSIGN=(2,10), 000180
        ASSIGN=(3,15),
        ASSIGN=(4,20), ASSIGN=(5,25),     000190
        ASSIGN=(6,30),
        ASSIGN=(7,35), ASSIGN=(8,40),     000200
        ASSIGN=(9,45),
        ASSIGN=(10,50), ASSIGN=(11,55),   000210
        ASSIGN=(12,60),
        TOF=5, BOF=66;                    000220
/*                                         */ 000230
/*           VOLUME    HOST=H2000, LABEL= 000240
/*           SPR, CODE=EBCDIC LCODE=EBCDIC, 000250
/*           PLABEL=YES;
/*           BLOCK    LENGTH=1331, PREAMBLE=1, LTHFLD=0; 000260
/*           RECORD   LENGTH=133, LTHFLD=0, STRUCTURE=FB; 000270
/*           LINE     DATA=(1,132), PCC=(0,TRAN), PCCTYPE=H2000, 000280
/*           OVERPRINT=(MERGE,NODISP), VFU=V1; 000290
/*           ACCT     USER=(BIN,TRAY); 000300
/*                                         */ 000310
/*           TABLES AND CRITERIA FOR    */ 000320
/*           LOGICAL PROCESSING          */ 000330
/*                                         */
T1:    TABLE    CONSTANT=('P');          000340
T2:    TABLE    CONSTANT=('P0');        000350
T3:    TABLE    CONSTANT=('P1');        000360
T4:    TABLE    CONSTANT=(O'47');      000370
/*                                         */ 000380
C1:    CRITERIA  CONSTANT=(0,1,EQ,T1);   000390
C2:    CRITERIA  CONSTANT=(0,2,EQ,T2);   000400
C3:    CRITERIA  CONSTANT=(0,2,EQ,T3);   000410
C4:    CRITERIA  CONSTANT=(0,1,EQ,T4);   000420
/*                                         */ 000430
/*                                         */ 000440
/*                                         */ 000450

```

```

/*          HONEYWELL 2000 SPR          */ 000460
/*          -----                    */ 000470
/*          */                          */ 000480
/* JDES 1-5 AND 11-15 DEFINE 5 COMMON HONEYWELL 2000 SPR */ 000490
/* LABELED FORMATS.                    */ 000500
/* THE FORMATS ARE AS FOLLOWS:        */ 000510
/*          */                          */ 000330
/*          */                          */ 000520
/*          */                          */ 000530
/*          CHARACTERISTICS              JOB          */ 000540
/*          -----                    -----        */ 000550
/*          */                          */ 000560
/*          BLOCKED 1331, SINGLE BANNER          1      */ 000570
/*          BLOCKED 668, SINGLE BANNER, 2 BYTE    2      */ 000580
/*          POSTAMBLE                               */ 000590
/*          BLOCKED 1332, DOUBLE BANNER,          3      */ 000600
/*          SINGLE REPORT PER FILE                */ 000610
/*          BLOCKED 1332, DOUBLE BANNER, SELECT  4      */ 000620
/*          REPORT 0 IN INTERSPERSED REPORT      */ 000630
/*          BLOCKED 1332, DOUBLE BANNER, SELECT  5      */ 000640
/*          REPORT 1 IN INTERSPERSED REPORT      */ 000650
/*          */                          */ 000660
/*          */                          */ 000670
1:JOB;                                          000680
VOLUME  HOST=H2000, LABEL=SPR ;              000690
BLOCK   LENGTH=1331, PREAMBLE=1, LTHFLD=0;   000700
RECORD  LENGTH=133, STRUCTURE=FB, LTHFLD=0;  000710
BSELECT TEST=(C1);                           000720
2:JOB;                                          000730
VOLUME  HOST=H2000, LABEL=SPR;              000740
BLOCK   LENGTH=668, PREAMBLE=1, LTHFLD=0, POSTAMBLE=2; 000750
RECORD  LENGTH=133, STRUCTURE=FB;           000760
BSELECT TEST=(C1);                           000770
3:JOB;                                          000780
VOLUME  HOST=H2000, LABEL=SPR;              000790
BLOCK   LENGTH=1332, PREAMBLE=2, LTHFLD=0;  000800
RECORD  LENGTH=133, STRUCTURE=FB;           000810
BSELECT TEST=(C1);                           000820
4:JOB;                                          000830
VOLUME  HOST=H2000, LABEL=SPR;              000840
BLOCK   LENGTH=1332, PREAMBLE=2, LTHFLD=0;  000850
RECORD  LENGTH=133, STRUCTURE=FB;           000860
BSELECT TEST=(C2);                           000870
5:JOB;                                          000880
VOLUME  HOST=H2000, LABEL=SPR;              000890
BLOCK   LENGTH=1332, PREAMBLE=2, LTHFLD=0;  000900
RECORD  LENGTH=133, STRUCTURE=FB;           000910
BSELECT TEST=(C3);                           000920

```



```

/*
/*          HONEYWELL 2000 STANDARD, COBOL AND SPR BCD TAPES*/
/*          -----*/
/*
/*
/*          JDES 21-26 DEFINE 6 COMMON HONEYWELL 2000 FORMATS
/*          UTILIZING STANDARD 80-BYTE LABELS AND COBOL 120-BYTE LABELS
/*          AS WELL AS BCD-CODED SPR LABELED TAPES.  THE FORMATS ARE AS
/*          FOLLOWS:
/*
/*          CHARACTERISTICS          JOB
/*          -----          -
/*          BCD-CODED SPR LABELS, BLOCKED 1201          21
/*          BCD-CODED SPR LABELS, BLOCKED 1332          22
/*          EBCDIC-CODED STANDARD LABELS,
/*          BLOCKED 1340          23
/*          BCD-CODED STANDARD LABELS, BLOCKED
/*          1009          24
/*          EBCDIC-CODED COBOL LABELS, BLOCKED
/*          1440          25
/*          EBCDIC-CODED COBOL LABELS, BLOCKED
/*          1500          26
/*
21:JOB;
VOLUME  HOST=H2000, LABEL=SPR, CODE=H2BCD, LCODE=H2BCD,
UNPACK=T4X3H2;
BLOCK   LENGTH=1201, PREAMBLE=2, POSTAMBLE=2;
BSELECT TEST=(C4);
22:JOB;
VOLUME  HOST=H2000, LABEL=SPR, CODE=H2BCD, LCODE=H2BCD,
UNPACK=T4X3H2;
BLOCK   LENGTH=1332, PREAMBLE=2;
BSELECT TEST=(C4);
23:JOB;
VOLUME  HOST=H2000, LABEL=STANDARD, CODE=EBCDIC;
BLOCK   LENGTH=1340, PREAMBLE=0;
RECORD  STRUCTURE=FB, LENGTH=134;
LINE    VFU=V2;
24:JOB;
VOLUME  HOST=H2000, LABEL=STANDARD, CODE=H2BCD,LCODE=H2BCD,
UNPACK=T4X3H2;
BLOCK   LENGTH=1009, PREAMBLE=0, POSTAMBLE=1;
RECORD  LENGTH=144, STRUCTURE=FB;
LINE    DATA=(8,132), VFU=V2;
25:JOB;
VOLUME  HOST=H2000, LABEL=COBOL,
CODE=EBCDIC;
BLOCK   LENGTH=1440, PREAMBLE=0;
RECORD  LENGTH=144, STRUCTURE=FB;
LINE    DATA=(2,132), VFU=V2, PCCTYPE=ANSI, PCC=(1,NOTRAN);
26:JOB;
VOLUME  HOST=H2000, LABEL=COBOL,
CODE=EBCDIC;
BLOCK   LENGTH=1500, PREAMBLE=0;
RECORD  LENGTH=150, STRUCTURE=FB
LINE    DATA=(1, 32), VFU=V2, PCCTYPE=H2000
END;END;          /*END OF HONEYWELL 2000 JDL */

```

Figure 10-10.JSL sample for Honeywell 6000 tapes

```

H6000:JDL;                                000010
/*                                          */ 000020
/*      HONEYWELL 6000 JOB DESCRIPTOR  LIBRARY      */ 000030
/*                                          */ 000040
V1: VFU ASSIGN=(1,10), ASSIGN=(2,15), ASSIGN=(3,20), ASSIGN=(4,25), 000050
      ASSIGN=(5,30), ASSIGN=(6,35), ASSIGN=(7,40), ASSIGN=(8,45), 000060
      ASSIGN=(9,50), ASSIGN=(10,55), ASSIGN=(11,60), ASSIGN=(12,62), 000070
      ASSIGN=(0,5), TOF=5, BOF=66; 000080
/*                                          */ 000090
      VOLUME  HOST=H6000, LABEL=STANDARD, UNPACK=T4X3, CODE=H6BCD, 000100
              LCODE=H6BCD, PLABEL=YES; 000110
      BLOCK   LENGTH=1920, LTHFLD=3, OFFSET=3, ADJUST=6 PREAMBLE=6, 000120
              POSTAMBLE=0; 000130
      RECORD  STRUCTURE=VB, LENGTH=134, LTHFLD=3, OFFSET=0, 000140
              ADJUST=6, PREAMBLE=6, POSTAMBLE=0; 000150
      LINE    DATA=(0,132), PCC=(0,NOTRAN), PCCTYPE=H6000, 000160
              OVERPRINT=(MERGE,NODISP), VFU=V1; 000170
      ACCT    USER=(BIN,TRAY); 000180
/*                                          */ 000190
/*      TABLES AND CRITERIA FOR LOGICAL PROCESSING */ 000200
/*                                          */ 000210
C1:  CRITERIA CHANGE=(5,1,NE, LAST); 000220
/*                                          */ 000230
/*                                          */ 000240
/*                                          */ 000250
/*      HONEYWELL 6000 SSF BCD AND ASCII TAPES */ 000260
/*      ----- */ 000270
/*                                          */ 000280
/*                                          */ 000290
/* THE FOLLOWING JDES WILL SUPPORT 9 TRACK BCD AND ASCII TAPES */ 000300
/* FOR HONEYWELL 6000 SSF FORMATS. */ 000310
/* THE JDES ARE AS FOLLOWS: */ 000320
/*                                          */ 000330
/*      CHARACTERISTICS                JOB */ 000340
/*      -----                ----- */ 000350
/*                                          */ 000360
/*      BCD-CODED SSF                1 */ 000370
/*      BCD-CODED SSF, STACKED REPORTS 2 */ 000380
/*      ASCII-CODED SSF                3 */ 000390
/*      ASCII-CODED SSF, STACKED REPORTS 4 */ 000400
/*                                          */ 000410
1:JOB; 000420
      VOLUME  HOST=H6000, LABEL=STANDARD, CODE=H6BCD, LCODE=H6BCD, 000430
              UNPACK=T4X3; 000440
2:JOB; 000450
      VOLUME  HOST=H6000, LABEL=STANDARD, CODE=H6BCD, LCODE=H6BCD, 000460
              UNPACK=T4X3; 000470
      RSTACK  TEST=(C1), PRINT=NONE; 000480
3:JOB; 000490
      VOLUME  HOST=H6000, LABEL=STANDARD, CODE=ASCII, LCODE=H6BCD, 000500
              UNPACK=T4X3; 000510
4:JOB; 000520
      VOLUME  HOST=H6000, LABEL=STANDARD, CODE=ASCII, LCODE=H6BCD, 000530
              UNPACK=T4X3; 000540
      RSTACK  TEST=(C1), PRINT=NONE; 000550
END; END; /* END OF HONEYWELL 6000 JDL */ 000560

```

11. Univac SDF tape format

The Univac SDF tape format is created on the Univac Operating System 1100-OS, level 32, and later versions. It is designed in a fixed block format with variable length records. This format is characterized by two types of character representation and packing interspersed record by record.

Univac ASCII character set

Nine-bit ASCII characters (refer to table 11-1) are recorded in 8 x 9 packing mode. Six-bit Fielddata characters (refer to table 11-2) are recorded in 4 x 3 packing mode. The characters within a print line are all either in Fielddata or in ASCII. Records of different translation, however, may be intermixed in a block. The records are generally preceded by a 36-bit (Univac) word in Fielddata characters, giving record length and other control information.

Table 11-1. Univac ASCII character set

Octal	Character	Octal	Character
040	(blank)	064	4
041	!	065	5
042	"	066	6
043	#	067	7
044	\$	070	8
045	%	071	9
046	&	072	:
047	'	073	;
050	(074	<
051)	075	=
052	*	076	>
053	+	077	?
054	,	100	@
055	-	101	A
056	.	102	B
057	/	103	C
060	0	104	D
061	1	105	E

Table 11-1. **Univac ASCII character set** (continued)

Octal	Character	Octal	Character
062	2	106	F
063	3	107	G
110	H	144	d
111	I	145	e
112	J	146	f
113	K	147	g
114	L	150	h
115	M	151	i
116	N	152	j
117	O	153	k
120	P	154	l
121	Q	155	m
122	R	156	n
123	S	157	o
124	T	160	p
125	U	161	q
126	V	162	r
127	W	163	s
130	X	164	t
131	Y	165	u
132	Z	166	v
133	[167	w
134	\	170	x
135]	171	y
136	^	172	z
137	_	173	{
140	'	174	
141	a	175	}
142	b	176	~
143	c	177	(null)

Table 11-2. Fielddata translation table

		Most Significant Bits								
		0	1	2	3	4	5	6	7	
Octal	(columns)	0	1	2	3	4	5	6	7	
(rows)	Binary	000	001	010	011	100	101	110	111	
Least Significant Bits	0	000	@	C	K	S)	*	0	8
	1	001	[D	L	T	-	(1	9
	2	010]	E	M	U	+	%	2	'
	3	011	#	F	N	V	<	:	3	;
	4	100	^	G	O	W	=	?	4	/
	5	101	(blank)	H	P	X	>	!	5	.
	6	110	A	I	Q	Y	&	,	6	"
	7	111	B	J	R	Z	\$	\.	7	-

The Univac labeled SDF formats offer single and multi-file options on single and multi-volume tapes. The formats of these options are shown in figure 11-1.

Univac also produces a labeled ANSI tape format that conforms to the standard ANSI format for both single- and multi-file, single-volume formats as shown in figure 11-2. However, the multi-volume format differs as shown in figure 11-2.

EOT reflector

An additional data file is appended following the EOT reflector. The presence of the EOT reflector is necessary for proper processing of the multi-volume tape, since the coincidence of the EOT reflector and the tape mark that terminates a volume spanning file is the signal that the volume transition is required. The normal SDF format, including the label control block, is present within the data.

Control and data records

Within a file, there are two basic record types: control records and data records. Control records are identified by the first bit in the record (bit 35) being set. The control record format is shown in table 11-3; the only control codes supported are shown in this table.

Control records

This section provides information about control records.

Label control block

The first of the control records, the label control block (type O'50') is actually the first record of the file. The Xerox printer checks to see that the tape is a print tape (O'25' for "P"). It also checks that the length of the label control block is 6 or 9 Univac words or some other length. If other than 6 or 9 Univac words in length, the label control block is assumed to have the same initial structure as the 9 Univac word record. This provides for processing of label control blocks of 20 Univac words in length as well as other nonstandard lengths that might be produced by given sites. The label control block is described in table 11-4.

Processing of other control record codes

Control record codes for continuation of previous data record (O'51'), end-of-reel (O'54'), and end-of-file (O'77') are also processed. Continuation records are discussed in the "Data records" section.

End-of-file or end-of-volume processing is initiated upon recognition of control image records with code O'77' or O'54'. In either case, the rest of the current input block is truncated.

Translation mode change control records (type O'42') indicate a character representation change from Fielddata to ASCII (or vice versa) and are also processed.

Figure 11-1. Univac unlabeled SDF tape formats

Single file, single volume

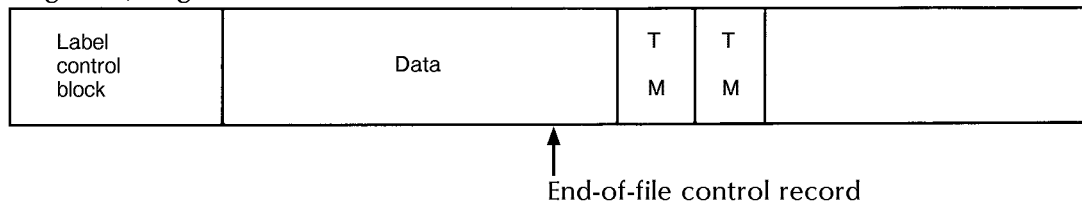

Single file, multi-volume

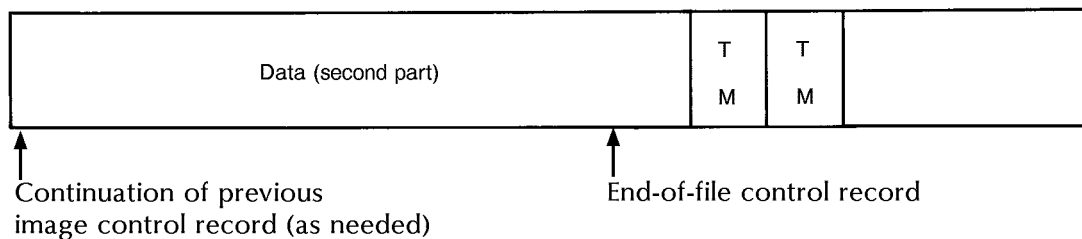
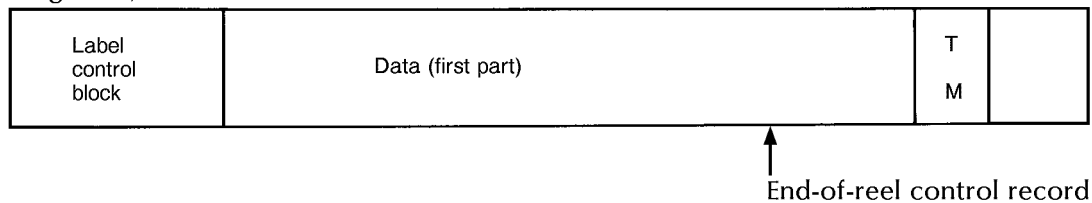

Multi-file, single volume

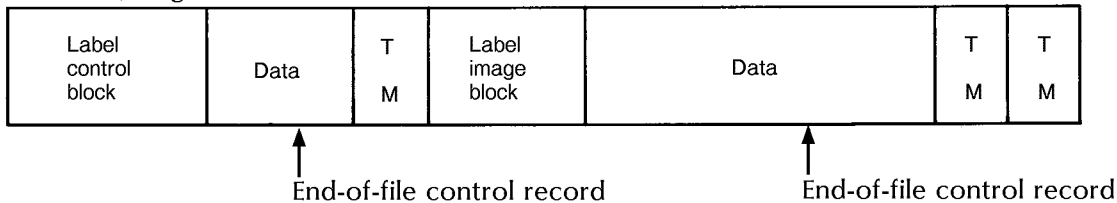

Multi-file, multi-volume

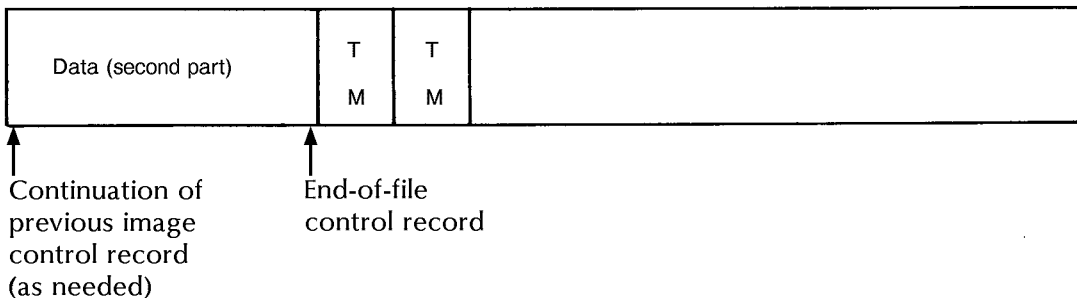
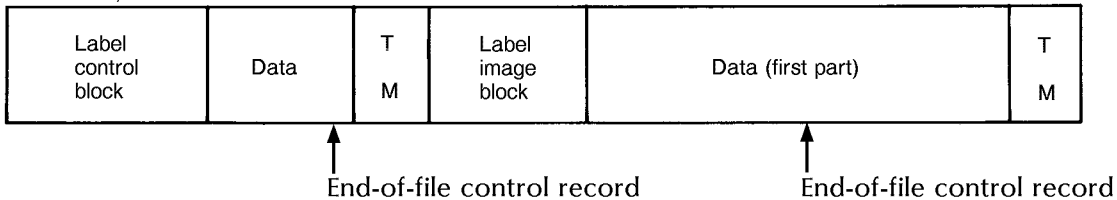

Figure 11-2. Univac labeled SDF tape formats

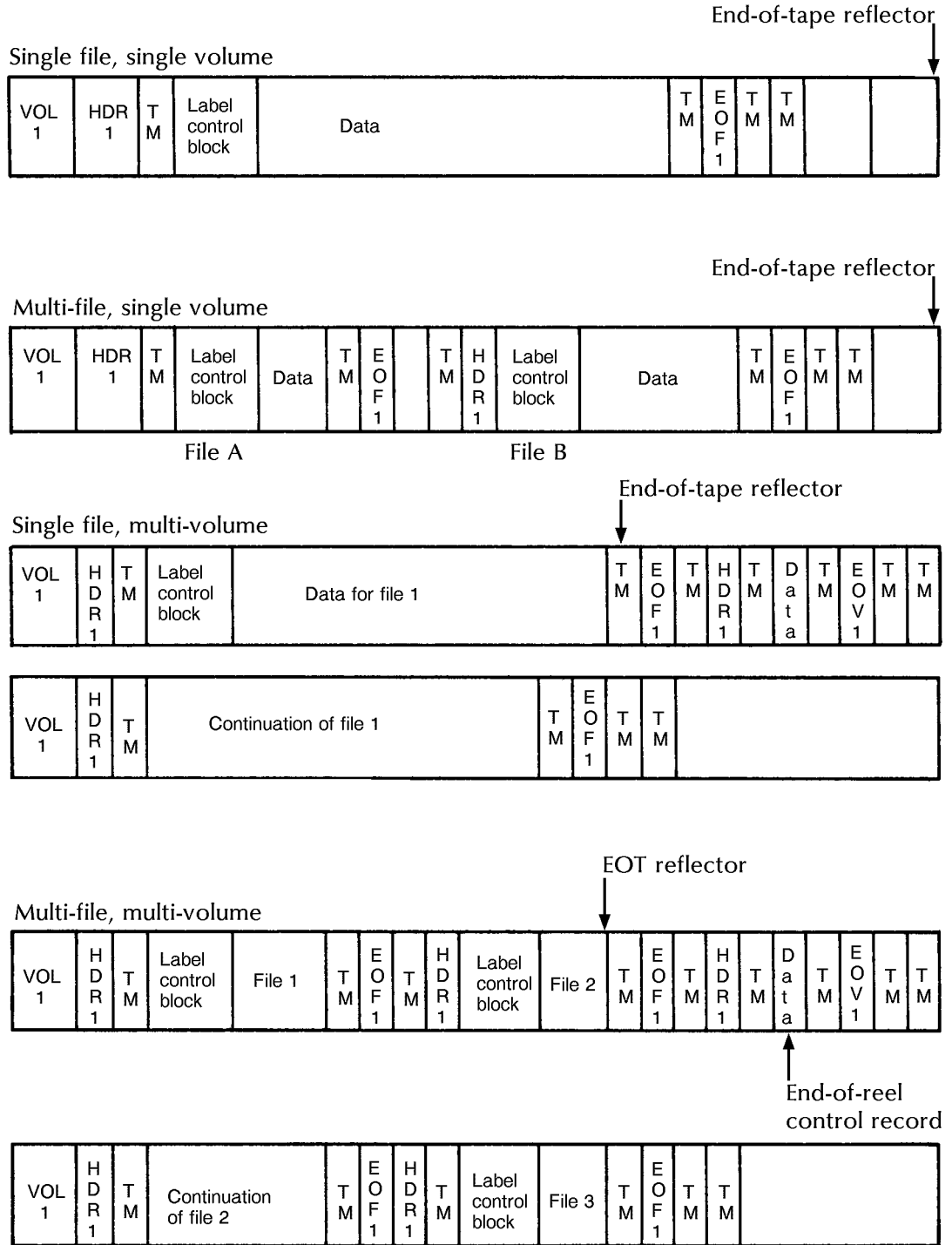

Table 11-3. Univac SDF control record format

Name	Character position(s)	Field	Description
Control record type code	1	1	Type code of control record O'50' —Label control block O'51' —Continuation record O'42' —Translation mode change O'54' —End-of-reel O'60' —Print image control O'77' —End-of-file All other codes are ignored
Length field	2	2	Length of record text in Univac words (6 characters per word). May be zero if only control record is present.
File type	3	3	File type. Must be "P" for symbiont print file.
Part number	4	4	Sequential file count
Reserved	5	5	Reserved
Code type	6	6	0 —Fielddata 1 —ASCII
Record text	Variable	7	Text for type codes O'51', O'50', and O'60'.

Table 11-4. Univac SDF label control block

Name	Character position(s)	Field	Description
Control record type code	1	1	This is O'50' for the label control block.
Length field	2	2	This is O'11' for the normal 9-word label, O'06' for the 6-word label, or O'24' for the 20-word label.
File type	3	3	This is O'25' (P) for symbiont print file.
Reserved	4-5	4	Unused
Code type	6	5	0 —Fielddata 1 —ASCII Must be Fielddata for labels.
File name	7-18	6	File name
Device association	19-24	7	Unused.
Run I.D.	25-30	8	Unused.
Date and time	31-36	9	Date portion is used when headings are specified by the "H" string.
Site I.D.	37-48	10	Unused.
Reserved	49-180	11	Unused.

Print image control record

The print image control record (type O'60') is also processed. It consists of strings of commands with letter identifiers. The identifiers which are recognized and processed by the Xerox/OSS are H, L, S, and M. A period separates the command strings within the print image control record. Any identifiers other than H, L, S, and M are bypassed.

Heading string "H"

The string "H, options, page, text" causes the heading insertion and automatic pagination by the Xerox/OSS. The options in the "H" string are "N" for no heading printing, or "X" for page numbering and date print suppression.

The page parameter gives the beginning page number for the report. If the page number is not given, page numbering starts at page 1. The text is a message of up to 96 characters which is printed two lines above the given top-of-form line number, followed by automatic spacing down to the top-of-form (TOF). Therefore, there is a Xerox/OSS generated minimum of one blank line between the heading and the first print line of the page. Details of processing the "H" string are summarized below.

- No page numbering or heading is printed if a top-of-form value is specified, either in the JDE or via the "M" string (which does not allow two extra lines above it). In other words, the smallest TOF value that allows page heading and/or numbering is 3.
- If both page heading and numbering are requested, the heading starts at the left page margin; at position (left margin + 96 + 1), the word "DATE" appears with the date from the label. "PAGE" is then concatenated to the heading line followed by a page value of up to five digits.

If a left margin, as specified in the offset part of the JDE command DATA (offset, length) does not allow sufficient characters for the full heading line, the line is truncated from the right margin, as necessary, to be equal to the length.

- If no page heading or page numbering is requested, the space normally occupied by the field not selected is blank filled.
- If a page number initialization value is not given in the "H" string, then 1 is used as the base page number value. As this may give undesirable results from file to file, the user is encouraged always to specify an initial page number in the "H" string.
- The page number maintained and incremented by the Xerox/OSS never exceeds 65,536. If incrementing continues, the page number returns to 1.
- Within a single report, the page number continues to be incremented for every page whenever the "H,N" option is in effect, even though the header record is suppressed. If page number printing is later turned back on by a subsequent "H" command in the same report (without specifying a starting page number), the printed page number includes the counts for all intervening pages.

Setup string "S"

The string "S, text message" indicates a special forms request for use in processing the next part of the print file. Xerox/OSS uses this record as a report delimiter.

Margin string "M"

The string "M, page length, top, bottom" causes reassignment of the top- and bottom-of-form line numbers. Top-of-form is the line number on which the first print line after the heading may occur.

- Examples:**
- 1 The option "M, 66, 3, 3" results in a top-of-form at line 4.
Bottom-of-form is the line number below which no print lines may occur.
 - 2 The option "M, 66, 3, 3" results in a bottom-of-form at line 63.
The logical page length is then set to "page length minus top-of-form minus bottom-of-form".
 - 3 The option "M, 66, 3, 3" results in a logical page length of 60.

Line string "L"

The string "L, line number" causes a skip to the line number calculated as the given line number plus the top-of-form line number minus 1. This is an analogous command to a skip to an assigned channel.

There are some special conditions that apply to "L" string processing:

- If the line number "m" specified in the L string is less than the current line number, a page overflow occurs and the new current line number is set to the top-of-form line number + m - 1.
- If the line number "m" is 0, 1, or greater than the logical page length, the current line number is set to the bottom-of-form, thus causing the next line to be printed on the top of the next page.
- The line number "m" must be five digits or less.

Data records

Data records (format is shown in figure 11-3) are identified by the first field of the record having a positive value. The first 36 bits of the data record contain the length of the print data, a line spacing value indicating the number of lines to be spaced before printing, and a code type indicating whether the print data is Fielddata or ASCII.

Figure 11-3. Univac SDF data record format

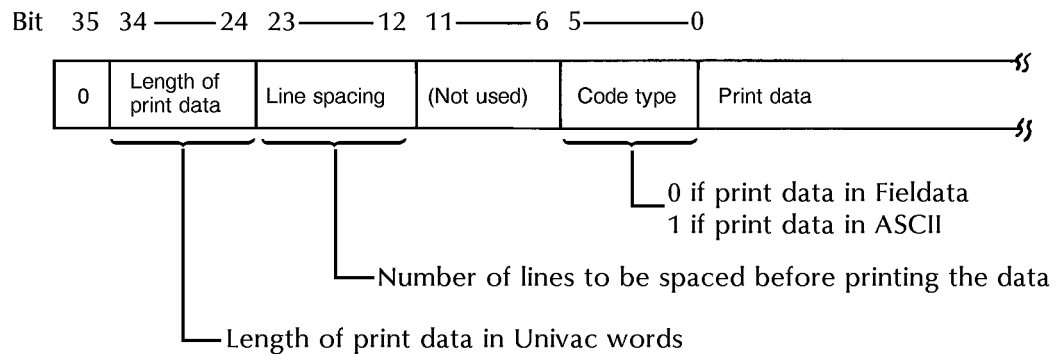

Length Data records are of variable length. At the end of a block that is a fixed length, a data record probably spans to the next block. The data record is split into two parts and the second block starts with a continuation data record (type O'51'). The two parts of the data record are rejoined and printed as one.

In release levels prior to Level 37 for Univac software, blocks were always 224 Univac words in length. The continuation data record (type O'51') generally appeared at the beginning of each block. In release level 37 and above, block sizes have been increased to multiples of 224 words, up to 1792 words. The O'51' record can then occur on any 224 word boundary within the data block.

Overprint/merge processing On print lines for which carriage control requires overprinting, overprint/merge processing is handled according to the JDE option selected.

Spacing Data record spacing of "m" lines is processed as follows:

- In general, the new current line number is set to the old calculated line number + m.
- If the new current line number is then greater than bottom-of-form, a page overflow occurs and the new current line number is set to top-of-form - 1 (to allow the next line to be printed top-of-form).

Appropriate JSL coding for Univac tapes

Use the following special guidelines when coding a JDE to handle a Univac tape format:

- Univac data can be formatted in both Fielddata and ASCII codes in the same file. To provide for easily managed logical processing test criteria, all Univac Fielddata is first translated into ASCII. Thus, when specifying CRITERIA tables for RSTACK, DJDE prefixes, and other logical processing functions, the user should define these search criteria with ASCII string tape.
- Some data blocks at the end of a file may have no valid data. These blocks are identified with an O'77' in the first control byte in the block. Delete any blocks of this type with the BDELETE command to prevent any printing of transient data. This criteria test must be coded in octal since this block is not yet translated.
- In the Univac format, the actual print data starts in the first byte of each record. Therefore, change the DATA parameter for all Univac JSLs to DATA = (0,132). Failure to specify the initial value of zero normally results in the loss of the first byte of each print record.
- Code the Setup string S in the print image control record as an RSTACK report delimiter.
- When the FONTINDEX option is specified, the font index byte should be located at the beginning of the record (since Fielddata and ASCII records can be intermixed).

Figure 11-4. JSL sample for UNIVAC tapes

```

UNIVAC:JDL;                                000010
/*                                          */ 000020
/*      SYSTEM FOR UNIVAC SDF              */ 000030
/*                                          */ 000040
V1:    VFU TOF=4, BOF=63;                   000050
/*                                          */ 000060
      VOLUME      HOST=UNIVAC, LABEL=STANDARD, UNPACK=T4X3, 000070
              CODE=ASCII, LCODE=ASCII;          000080
      BLOCK      LENGTH=1344, FORMAT=PACK;      000090
      RECORD     LENGTH=400, FORMAT=PACK, PREAMBLE=6, STRUCTURE=VB, 000100
              LTHFLD=1;                          000110
      LINE       DATA=(0,132), PCCTYPE=NONE, VFU=V1; 000120
/*                                          */ 000130
/*      TABLES AND CRITERIA FOR LOGICAL PROCESSING  */ 000140
/*                                          */ 000150
T1:    TABLE CONSTANT=O'77';               000160
T2:    TABLE CONSTANT=O'3056';             000170
/*                                          */ 000180
C1:    CRITERIA CONSTANT=(0,1,EQ,T1);       000190
C2:    CRITERIA CONSTANT=(0,2,EQ,T2);       000200
/*                                          */ 000210
      BDELETE TEST=(C1);                     000220
/*                                          */ 000230
/*                                          */ 000240
/*                                          */ 000250
/*      UNIVAC SDF                             */ 000260
/*                                          */ 000270
/* THE FOLLOWING JDES WILL SUPPORT 9 TRACK LABELED AND NON  */ 000280
/* LABELED UNIVAC SDF FORMATS. LABEL=STANDARD IS USED TO  */ 000290
/* PROVIDE INPUT PROCESSOR WITH INFORMATION CONCERNING THE  */ 000300
/* PRESENCE OF A LABEL CONDITION ONLY. THE LABEL FORMAT IS  */ 000310
/* EXPECTED AS UNPACKED. CODE=ASCII IS REQUIRED IN ORDER TO  */ 000320
/* OBTAIN THE ASCII TABLE FROM DISC, HOWEVER THE DATA FORMAT  */ 000330
/* WITHIN THE REPORTS CAN BE EITHER FIELD DATA OR ASCII.  */ 000340
/* PREAMBLE=6 IS REQUIRED IN ORDER TO PROCESS THE UNIVAC  */ 000350
/* DATA CONTROL WORD PROCEEDING EACH DATA RECORD.  */ 000360
/* BLOCKS SATISFYING CRITERIA C1 WILL BE DELETED.  */ 000370
/*                                          */ 000380
/*      CHARACTERISTICS                          JOB      */ 000390
/*                                          */ 000400
/*      LABELED TAPE                             1         */ 000410
/*      NON-LABELED, STACKED REPORTS, DJDE'S     2         */ 000420
/*      NON-LABELED                              3         */ 000430
/*      NON-LABELED, RECORD LENGTH=400          4         */ 000440
/*                                          */ 000450
1:JOB;                                       000460
2:JOB;                                       000470
      VOLUME LABEL=NONE;                       000480
      RSTACK TEST=(C2);                         000490
      IDEN PREFIX=O'74', OFFSET=0, SKIP=4;     000500
3:JOB;                                       000510
      VOLUME LABEL=NONE;                       000520
4:JOB;                                       000530
      VOLUME LABEL=NONE;                       000540
      RECORD LENGTH=400;                       000550
END;END; /* END OF UNIVAC SDF JDL */        000560

```

At IBM OS and OS/VS installations, jobs are categorized by class for the purpose of scheduling job execution by priority and required computer resources. Similarly, the job's output may also be assigned to a certain class, which causes the OS or OS/VS system to buffer the output data to a relatively high-speed device. This buffering causes the output reports of one or more jobs to be collected under a single class identifier. The operator then starts up a special job, which transfers the output reports to a bulk storage device such as magnetic tape and/or line printer. The special job, which supervises the report transfer, is called an OS Writer.

An installation may have one or more writers depending on the particular site's requirements. Usually, however, there are two standard writers: the Class A Writer supervises reports destined for output on a line printer. The Class B Writer supervises reports destined for output on a card punch. An installation generally assigns a special class of jobs whose output is to be printed by the Xerox printing system. An example of report creation under an OS Writer is explained later in this section.

OS Writer report tape format

An OS Writer report tape is an OS Standard label, single-file tape consisting of stacked reports. Each report is usually separated from the preceding report by header banner pages, and is separated from the succeeding report by optional trailer banner pages.

Banner page format

A banner page is distinctively formatted to contain the job name and MSGCLASS in block letters in the middle of the page. Additionally, there is a row of asterisks or zeros at the edges of a page on the fanfold perforations. These perforation lines are often overprinted several times to provide identification of jobs for the operator who must burst the fanfold for distribution.

The line printer VFU channel value that causes alignment of the banner page to the perforation is an installation option, but at most sites the perforation is assigned to channel 9. The skip to channel 9 command is followed by one or more "space zero lines and print" commands. It is the skip-to-channel command which enables the system to determine the location of banner pages, and to separate stacked reports on the OS Writer report tape.

The trailer banner pages (if any) of one report are generally followed immediately by the header banner page of the next report, with no intervening delimiter records, DJDE records, tape marks, or tape labels.

The JCL used in creating the OS Writer report tape is output by OS or OS/VS to the MSGCLASS specified on the IBM JOB card.

Job Descriptor Library (JDL) specification

The Xerox system looks for banner page delineation of OS Writer stacked reports whenever the HOST=OSWTR left/right parts are specified in the VOLUME statement. Additionally, "LABEL=STANDARD" should be specified.

While the HOST and LABEL left/right parts are mandatory, the VOLUME left/right parts "OSCHN", "OSTLP", and "OSHDP" may be specified at the PDL programmer's discretion, according to the criteria specified in table 12-1.

The full selection of PDL commands may be used in selecting the OS Writer option. Generally, however, only the LINE and OUTPUT commands are needed (in addition to the VOLUME command) due to the override of BLOCK and RECORD values by the HDR2 label information contained on these tapes.

Table 12-1. **Volume command OS Writer options**

Command	Left part	Right part	Default	Interpretation
VOLUME	HOST =	OSWTR,		These left/right parts are required of OS Writer Tapes.
	LABEL =	STANDARD,		The right part "value" is the VFU channel number which results in the alignment on the fanfold perforation.
	OSCHN =	value,	9	The right part "value" is the number of trailer pages following each report on the OS Writer report tape.
	OSTLP =	value,	0	The right part "value" is the number of header pages which precede the report.
	OSHDP =	value	0	

Sample report creation under an OS Writer

An installation's management and systems analyst usually determine how to apply the OS Writer feature of the Xerox system to the installation's processing scheme. An example of OS Writer report generation has been included in this section to assist those unfamiliar with OS and OS/VS Writers. The description is meant to be illustrative rather than exhaustive, as each OS installation varies widely in actual application.

Procedure

The following steps are an example to create an OS Writer.

- Step 1.** The systems analyst begins by creating an OS Writer procedure that will operate on the chosen job class, Class X. The OS Writer “proc” for the example is shown in figure 12-.

Figure 12-1. **Sample OS Writer “PROC” to create “XEROXWTR”**

```
//XEROX2      JOB (T,999,999,XEROX),CLASS=F
// EXEC PGM=IEBUPDTE
//SYSPRINT    DD      SYSOUT=A
//SYSUT1     DD      DSN=SYS1.PROCLIB,DISP=SHR
//SYSUT2     DD      DSN=SYS1.PROCLIB,DISP=SHR
//SYSIN      DD DATA.DLM='XX'
./ REPL NAME=XEROXWTR,LIST=ALL,SSI=524601B7
./ NUMBER NEWI=1000,INCR=1000
//XEROXWTR   PROC   IMG=IMG1.SEPNAM=IEF0SC06.NUMHDR=1.NUMTRL=1.
//   TRAIN=RN,WCLASS=PX,LABL=SL,
//   BLK=1364,REC=136,RECFORM=VBM
//IEFPROC    EXEC   PGM=IEF0SC01,
//   PARM='&WCLASS,&SEPNAM,&NUMHDR. . . .&NUMTRL'
//IEFRDER    DD
UNIT=TAPE,LABEL=(. &LABL,EXPDT=98000),DSNAME=SYSOUT,
//
DISP=(NEW,KEEP),UCS=(&TRAIN,FOLD,VERIFY),FCB=(&IMG,VERIFY),
//   DCB=(BLKSIZE=&BLK,LRECL=&REC,RECFM=&RECFORM,BUFNO=2)
XX
//
```

The Writer’s name in this example is XEROXWTR. The Writer creates reports with one header banner page (NUMHDR) and one trailer banner page (NUMTRL). These values must correspond to the JDL parameters OSHDP and OSTLP. All the parameters preceded by an ampersand (&) may be replaced by the operator when he starts up the Writer. Parameters preceded by an ampersand may also be replaced by parameters on the EXEC statement of the JCL which creates an OS Writer report. Note that many of the parameters correspond to HDR2 label fields, such as record and block length, and record format or structure. This Writer “proc” is read into the OS system and catalogued to remain resident for later use.

- Step 2.** The next step in this procedure is to create the JCL for the job. In particular, the user must specify a MSGCLASS of Class X on the // JOB card. The DD statement to direct the report output to the Xerox printer must also specify Class X, as shown in the following statement:

```
//FT02F001    DD      SYSOUT=X
```

This statement also shows that the output directed to device 2 will be held in class X.

- Step 3.** The third step is to initialize the tape volume labels, since the OS Writer updates tape labels but does not create these labels. The INITT processor may be used for this purpose.
- Step 4.** The user then runs one or more jobs creating output reports in class X.

- Step 5.** When the time comes to transfer the output to a tape, the operator mounts the tape and starts up the Xerox Writer by keying in:

S XEROXWTR

The Xerox Writer then copies (to tape) the entire contents of Class X as a multi-report, single-file, multi-volume job, blocking the output as described in the OS Writer generation procedure (or as changed by the operator key-in parameters or by parameters on the EXEC statements that created the reports—not shown).

- Step 6.** Finally, the operator dismounts the tape and prints it on the Xerox printer using the JDL which contains the correct OSTLP, OSHDP, and OSCHN values and, of course, the HOST=OSWTR and LABEL=STANDARD left/right parts.

Steps to creating an OS Writer tape

A brief summary of the operations leading to an OS Writer tape is as follows:

1. Create the Writer "proc" and catalog it in the OS or OS/VS system.
2. Create the JCL for the job which corresponds to the OS Writer message class.
3. Initialize the tape volume labels, if necessary.
4. Run the jobs that generate the reports.
5. Start up the Writer with an operator key-in.
6. Unload the tape and print it on the printing system.

WRITER tape JSL sample

The following figure provides a JSL sample.

Figure 12-2. JSL sample for IBM OS, DOS, ANSI, WRITER tapes

```

IBMRC: JDL;                                000010
/*                                          */ 000020
/* SYSTEM TO PRINT IBM OS STANDARD AND DOS STANDARD */ 000030
/* LABELED TAPES, IBM ANSI LABELED TAPES, IBM OS */ 000040
/* WRITER TAPES, AND US70 (RCA) LABELED TAPES. */ 000050
/*                                          */ 000060
V1: VFU ASSIGN=(1,5), ASSIGN=(2,10), ASSIGN=(3,15), 000070
      ASSIGN=(4,20), ASSIGN=(5,25), ASSIGN=(6,30), 000080
      ASSIGN=(7,35), ASSIGN=(8,40), ASSIGN=(9,45), 000090
      ASSIGN=(10,50), ASSIGN=(11,55), ASSIGN=(12,60), 000100
      TOF=5, BOF=66; 000110
/*                                          */ 000120
/* VFU FOR OS WRITER WITH CHANNEL 9 ASSIGNED TO LINE 66 */ 000130
/*                                          */ 000140
WR: VFU ASSIGN=(1,5), ASSIGN=(2,10), ASSIGN=(3,15), 000150
      ASSIGN=(4,20), ASSIGN=(5,25), ASSIGN=(6,30), 000160
      ASSIGN=(7,35), ASSIGN=(8,40), ASSIGN=(10,45), 000170
      ASSIGN=(11,50), ASSIGN=(12,60), ASSIGN=(9,66), 000180
      TOF=5, BOF=66; 000190
/*                                          */ 000200
      VOLUME HOST=IBMOS, LABEL=STANDARD, CODE=EBCDIC, PLABEL=YES; 000210
      LINE DATA=(1,132), PCCTYPE=ANSI, PCC=(0,NOTRAN), 000220
      OVERPRINT=(MERGE,NODISP), VFU=V1; 000230
      ACCT USER=(BIN,TRAY); 000240
/*                                          */ 000250
/* CATALOG FOR OS VARIABLE BLOCKED TAPES */ 000260
/*                                          */ 000270
OSVB: CATALOG; 000280
      BLOCK LENGTH=2660, PREAMBLE=4, LTHFLD=2, FORMAT=BIN; 000290
      RECORD LENGTH=136, PREAMBLE=4, STRUCTURE=VB, 000300
      LTHFLD=2, OFFSET=0, FORMAT=BIN; 000310
/*                                          */ 000320
/* CATALOG FOR OS WRITER TAPES */ 000330
/*                                          */ 000340
OS: CATALOG; 000350
      VOLUME HOST=OSWTR, OSCHN=9, OSTLP=0, OSHDP=1, 000360
      PLABEL=YES; 000370
      BLOCK LENGTH=2400, PREAMBLE=4, LTHFLD=2, FORMAT=BIN; 000380
      RECORD LENGTH=136, PREAMBLE=4, STRUCTURE=VB, 000390
      LTHFLD=2, FORMAT=BIN; 000400
      LINE DATA=(1,132), PCCTYPE=ANSI, PCC=(0,NOTRAN), 000410
      OVERPRINT=(MERGE,NODISP), VFU=WR; 000420
/*                                          */ 000430
/* CATALOG FOR UNIVAC SERIES 70 */ 000440
/* (FORMERLY RCA) */ 000450
/*                                          */ 000460
US: CATALOG; 000470
      VOLUME HOST=US70, LABEL=STANDARD, PLABEL=YES; 000480
      BLOCK LENGTH=1330, PREAMBLE=0; 000490
      RECORD LENGTH=133, STRUCTURE=FB; 000500
      LINE DATA=(1,132), PCCTYPE=US70, PCC=(0,NOTRAN), 000510
      OVERPRINT=(MERGE,NODISP), VFU=V1; 000520

```

```

/*
/*          IBM OS/DOS STANDARD LABELED TAPES
/*          -----
/*
/*    THE FOLLOWING JDES PROVIDE SUPPORT FOR IBM OS STANDARD
/*    AND IBM DOS STANDARD LABELED TAPES
/*
/*          CHARACTERISTICS          JOB
/*          -----          -----
/*
/*    OS STANDARD LABELS, 1403 PCC          1
/*    OS STANDARD LABELS, ANSI PCC          2
/*    OS STANDARD LABELS, 1401 PCC          3
/*    OS STANDARD LABELS, NO PCC           4
/*    DOS STANDARD LABELS, 1403 PCC          5
/*    DOS STANDARD LABELS, ANSI PCC          6
/*    DOS STANDARD LABELS, 1401 PCC          7
/*    DOS STANDARD LABELS, NO PCC           8
/*
1:JOB INCLUDE=(OSVB);
      VOLUME  HOST=IBMOS, LABEL=STANDARD, CODE=EBCDIC;
      LINE    PCCTYPE=IBM1403;
2:JOB INCLUDE=(OSVB);
      VOLUME  HOST=IBMOS, LABEL=STANDARD, CODE=EBCDIC;
      LINE    PCCTYPE=ANSI;
3:JOB INCLUDE=(OSVB);
      VOLUME  HOST=IBMOS, LABEL=STANDARD, CODE=EBCDIC;
      LINE    PCCTYPE=IBM1401;
4:JOB INCLUDE=(OSVB);
      VOLUME  HOST=IBMOS, LABEL=STANDARD, CODE=EBCDIC;
      LINE    PCCTYPE=NONE;
5:JOB;
      VOLUME  HOST=IBMDOS, LABEL=STANDARD, CODE=EBCDIC;
      LINE    PCCTYPE=IBM1403;
6:JOB;
      VOLUME  HOST=IBMDOS, LABEL=STANDARD, CODE=EBCDIC;
      LINE    PCCTYPE=ANSI;
7:JOB;
      VOLUME  HOST=IBMDOS, LABEL=STANDARD, CODE=EBCDIC;
      LINE    PCCTYPE=IBM1401;
8:JOB;
      VOLUME  HOST=IBMDOS, LABEL=STANDARD, CODE=EBCDIC;
      LINE    PCCTYPE=NONE;
/*
/*          IBM ANSI LABELED AND OS WRITER TAPES
/*          -----
/*
/*    THE FOLLOWING JDES PROVIDE SUPPORT FOR IBM ANSI LABELED
/*    TAPES AND OS WRITER TAPES.
/*
/*          CHARACTERISTICS          JOB
/*          -----          -----
/*
/*    ANSI LABELS, ASCII CODE, ANSI PCC          21
/*    ANSI LABELS, ASCII CODE, NO PCC           22
/*    OS WRITER, ANSI PCC                       23
/*    OS WRITER, 1403 PCC                       24
/*

```

```
21:JOB;                                001110
      VOLUME  HOST=IBMOS, LABEL=ANSI, CODE=ASCII, LCODE=ASCII; 001120
      LINE    PCCTYPE=ANSI;                                001130
22:JOB;                                001140
      VOLUME  HOST=IBMOS, LABEL=ANSI, CODE=ASCII, LCODE=ASCII; 001150
      LINE    PCCTYPE=NONE;                                001160
23:JOB  INCLUDE=(OS);                                001170
      VOLUME  HOST=OSWTR;                                001180
      LINE    PCCTYPE=ANSI;                                001190
24:JOB  INCLUDE=(OS);                                001200
      VOLUME  HOST=OSWTR;                                001210
      LINE    PCCTYPE=IBM1403;                            001220
/*                                        */ 001230
/*          US70 (RCA) STANDARD LABELED TAPES          */ 001240
/*          -----                                     */ 001250
/*                                        */ 001260
/*  JDES 41 AND 42 PROVIDE SUPPORT FOR US70 (FORMERLY RCA) */ 001270
/*  STANDARD LABELED TAPES.                               */ 001280
/*                                        */ 001290
41:JOB  INCLUDE=(US);                                001300
      VOLUME  HOST=US70, LABEL=STANDARD;                001310
END;END;                                            001320
```

The Xerox printer accepts NCR Century B1 Operating System tapes that meet the following criteria:

- ASCII character code
- ANSI standard label or unlabeled
- Four-byte carriage control, as described in this section
- Fixed block format or other supported generalized format
- B1 COM spool tapes or B1 Interim Print Files, as described below.

The ANSI labels conform to the requirements of ANSI Standard X3.27–1969 (see chapter 1). The block and record format may be any of the types that can be described by a JDL.

The print record should not have any embedded control characters such as those for blank compression. If embedded control characters are contained in a print record, they cause no carriage control action to occur and generally print as a blank.

Carriage control conventions

The carriage control is 4 bytes long. Processing parameters for NCR carriage control, using the PCC definitions from the PDL system command set, are as follows:

NCR	
INITIAL	TOF
DEFAULT	IGN,SP1P
ADVTAPE	NO
MASK	X'FF'
ASSIGN	See "Printer control block codes."

Printer control block codes

Figure 13-1 shows the each position of the printer control block codes.

Figure 13-1. **printer control block codes**

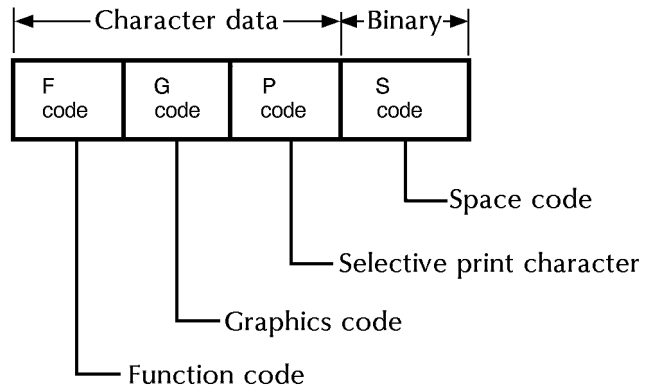

Each position of the printer control block has a specific meaning:

- The first position (F) defines the function to be performed.
- The second position (G) defines the graphics set to be used.
- The third position (P) defines the selective print character to be stored for an interim print-file record.
- The fourth position (S) defines either the bulber of lines to advance or the line bulber on which printing is to occur.

The first three positions contain character data, and the fourth position contains a binary-type character.

Function code (F)

The following tables list and describe the various function codes.

Table 13-1. **Function codes (B1 Interim Print File)**

Hex	Action
04	TOF (S code is zero)
04	Space "n" lines
06	Space "n" lines and print

Table 13-2. **Function codes (B1 COM Spool Tape)**

Hex	ASCII	Action
45	E	OVR (non-FX)/TOF (FX)
4C	L	Skip to line "n" and print
4E	N	Space "n" lines
4F	O	Space "n" lines and print
50	P	Space "n" lines and print

A function code (relative location 0) instructs the printer to perform one of five possible functions. Each function is identified by a code: E, L, N, O, P, 04, or 06.

04 or E	The E or 04 (with S code of 0) function code causes the printer to advance the paper to the top of the next form. Note: The TOF value is used for the E function.
L	The L function code causes the printer to advance the paper to the line number specified by the space code, then print. If the line number specified is 0, the carriage control action is space-one-and-print. If the line number specified is less than the current line number, a skip to the specified line on the next page occurs. Line numbers are calculated as follows: physical line number = "N" value + TOF - 1.
04 or N	The N or 04 function causes the printer to advance the paper the number of lines specified by the space code (without printing).
O	The O function code is applicable only to the 640-200/210 printers; it is used to inhibit the automatic one-line advance so that overprinting can occur with the next print function. It is treated the same as "P."
06 or P	The P or 06 function code causes the printer to advance the paper the number of lines specified by the space code, then print. When using code 06 and the BOF is encountered, spacing continues on the next page from the TOF (see the OVR option of the PCC command in the printing system reference manual).

Graphics code (G)

The graphics code (relative location 1) is ignored.

Selective print character (P)

The selective print character (relative location 2) identifies the individual reports within an interim print file. If multiple reports are created at the same time, you may use a different selective print character to identify the records pertaining to each report and store all reports generated by the program on one tape for printing at a later time. The selective print character may be any numeric or alphabetic character (symbol characters and spaces are not permitted).

To print the reports separately, use the RSELECT option in the JDE.

Space code (S)

The space code (relative location 3) specifies either the number of lines to advance or the actual line number on which printing is to occur, depending on the function being performed (see the function code explanation for details). The space code may contain any value from 0 to 255.

Figure 13-2. JSL sample for NCR tapes

```

NCR:JDL;                                000010
/*                                       */ 000020
/*   SYSTEM TO PRINT NCR STANDARD      */ 000030
/*   LABELED TAPES                     */ 000040
/*                                       */ 000050
V1:   VFU      ASSIGN=(1,5), TOF=5, BOF=66; 000060
      VOLUME   HOST=NCR, LABEL=STANDARD, CODE=EBCDIC; 000070
      BLOCK    LENGTH=2040;                000080
      RECORD   LENGTH=136, STRUCTURE=FB;    000090
      LINE     DATA=(4,132), PCCTYPE=NCR, VFU=V1; 000100
/*                                       */ 000110
/*                                       */ 000120
/*   CHARACTERISTICS                   JOB    */ 000130
/*   -----                           ---    */ 000140
/*   CODE=EBCDIC                        1      */ 000150
/*   CODE=ASCII, LCODE=ASCII            2      */ 000160
/*                                       */ 000170
/*                                       */ 000180
1:JOB;                                   000190
2:JOB;                                   000200
      VOLUME   CODE=ASCII, LCODE=ASCII;    000210
END;END;                                 000220

```

To process tapes with labels that are not specifically defined in any of the other chapters of this manual, the user may specify undefined host and undefined labels. Labels are identified by virtue of their length. Minimum and maximum unpacked label lengths can be specified using the MAXLAB and MINLAB options on the VOLUME command. If unspecified, label length defaults to include records of 80 to 81 bytes. The operating system software groups together any combination of label records and their surrounding tape marks at the beginning of a file. Since these labels are not otherwise defined, there is no additional checking or use of their contents (other than the JDE-selected option of printing them).

Unpacking of data and labels may be specified. If unpacking is specified for the labels, the data must also require the same unpacking method. The labels do not have to be unpacked even though the data may require unpacking, if the MINLAB/MAXLAB parameters are specified properly for the unpacked length.

The data tape blocks must be definable by the JDE parameters of the BLOCK and RECORD commands.



Note: It should be noted that any data block that is the same length as a label block is treated as a label; 80 is the minimum and 81 is the maximum default label size



File format

A file under this system has the following characteristics:

- A file starts at the initial tape position and includes any labels or single tape marks which precede the first data record. The file ends on the last data record preceding a tape mark or label record.
- Since a label record or a tape mark is used to terminate a file, trailer labels for a given file are considered to be header labels for the following file, if any.

At the end of processing of a file, the tape is positioned prior to the tape mark or label record which caused termination of the file processing. Thus, in the event that a file is terminated by a single tape mark or a label without any following tape marks, the preceding file is properly processed and any tape-related errors (timeout, unreadable block, etc.) do not occur until the operator starts processing on the nonexistent file.

- At the end of processing of a file, the tape is positioned prior to the tape mark or label record which caused termination of the file processing. Thus, in the event that a file is terminated by a single tape mark or a label without any following tape marks, the preceding file is properly processed and any tape-related

errors (timeout, unreadable block, etc.) do not occur until the operator starts processing on the nonexistent file.

- A double tape mark termination leaves the tape positioned after the second tape mark.
- An EOT coincident with a tape mark causes multi-reel processing to occur.

Some samples of file structure that may be processed by specifying undefined Host and undefined labels are shown in figure 14-1.

Figure 14-1. Undefined labeled tape structures

Example 1

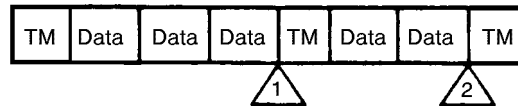

Example 2

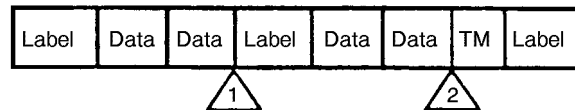

Example 3

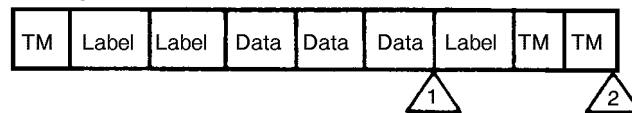

Example 4

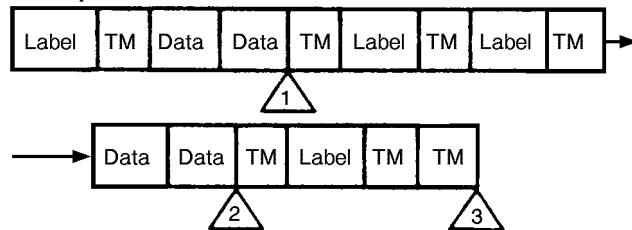

Key TM Tape mark
 △₁ Triangles are assumed file breaks

Data format

Any data format that is describable by the BLOCK and RECORD commands can be processed. The parameters in the JDE take precedence and control deblocking of data. The LINE command controls printer carriage control and other print controls. The user should note that any data block of the same length as a label is treated as a label.

Undefined tape JSL sample

The following figure provides a JSL sample.

Figure 14-2. JSL sample for Xerox tapes

```

XEROX:JDL;                                000010
/*          SYSTEM FOR XEROX TAPES          */ 000020
/*                                          */ 000030
V1:      VFU      ASSIGN=(1,5), ASSIGN=(2,10), ASSIGN=(3,15), 000040
          ASSIGN=(4,20), ASSIGN=(5,25), ASSIGN=(6,30), 000050
          ASSIGN=(7,35), ASSIGN=(8,40), ASSIGN=(9,45), 000060
          ASSIGN=(10,50), ASSIGN=(11,55), ASSIGN=(12,60), 000070
          TOF=5, BOF=66; 000080
/*                                          */ 000090
          VOLUME  HOST=XEROX, LABEL=ANSI, CODE=EBCDIC, PLABEL=YES; 000100
          BLOCK   LENGTH=4096, PREAMBLE=0, LTHFLD=0; 000110
          RECORD  PREAMBLE=0, STRUCTURE=FB; 000120
          LINE    DATA=(1,132), PCCTYPE=XEROX, PCC=(0,NOTRAN), 000130
          OVERPRINT=(MERGE,NODISP), VFU=V1; 000140
          ACCT    USER=(BIN,TRAY); 000150
PR:CATALOG;                                000160
          BLOCK   LENGTH=4000, LTHFLD=2, PREAMBLE=4, FORMAT=BIN; 000170
          RECORD  LENGTH=136, PREAMBLE=4, STRUCTURE=VB, LTHFLD=2, 000180
          FORMAT=BIN; 000190
UU:CATALOG;                                000200
          VOLUME  LABEL=NONE; 000210
          BLOCK   LENGTH=133; 000220
          RECORD  STRUCTURE=U; 000230
          LINE    PCCTYPE=NONE, DATA=(0,132); 000240
U4:CATALOG;                                000250
          VOLUME  LABEL=NONE; 000260
          BLOCK   LENGTH=4096; 000270
          RECORD  STRUCTURE=U; 000280
          LINE    PCCTYPE=NONE, DATA=(0,132); 000290
FB:CATALOG;                                000300
          VOLUME  LABEL=NONE; 000310
          BLOCK   LENGTH=3990; 000320
          RECORD  LENGTH=133, STRUCTURE=FB; 000330
          LINE    PCCTYPE=NONE, DATA=(0,132); 000340
/*                                          */ 000350
/*                                          */ 000360
/*          XEROX ANSI LABELED AND UNLABELED TAPES          */ 000370
/*          ----- */ 000380
/*                                          */ 000390
/*          THE FOLLOWING JDES WILL PRINT A VARIETY OF XEROX TAPES - */ 000400
/*          BOTH ANSI LABELED AND UNLABELED          */ 000410
/*                                          */ 000420
/*          CHARACTERISTICS          JOB          */ 000430
/*          -----          ----- */ 000440
/*                                          */ 000450
/*          ANSI-LABELED, FB, BLOCKED 3990, XEROX 11 */ 000460
/*          PCC          */ 000470
/*          ANSI-LABELED, U, BLOCKED 133, XEROX PCC 12 */ 000480
/*          UNLABELED, BLOCKED 3990, FB, XEROX PCC 13 */ 000490
/*          UNLABELED, BLOCKED 3960, FB, XEROX PCC 14 */ 000500
/*          UNLABELED, BLOCKED 133, U, XEROX PCC 15 */ 000510
/*                                          */ 000520

```

```

11:JOB;                                000530
      VOLUME  HOST=XEROX, LABEL=ANSI;  000540
      BLOCK   LENGTH=3990;             000550
      RECORD  LENGTH=133, STRUCTURE=FB; 000560
12:JOB;                                000570
      VOLUME  HOST=XEROX, LABEL=ANSI;  000580
      BLOCK   LENGTH=133;              000590
      RECORD  LENGTH=133, STRUCTURE=U;  000600
13:JOB;                                000610
      VOLUME  HOST=XEROX, LABEL=NONE;  000620
      BLOCK   LENGTH=3990;             000630
      RECORD  LENGTH=133, STRUCTURE=FB; 000640
14:JOB;                                000650
      VOLUME  HOST=XEROX, LABEL=NONE;  000660
      BLOCK   LENGTH=3960;             000670
      RECORD  LENGTH=132, STRUCTURE=FB; 000680
15:JOB;                                000690
      VOLUME  HOST=XEROX, LABEL=NONE;  000700
      BLOCK   LENGTH=133;              000710
      RECORD  LENGTH=133, STRUCTURE=U;  000720
/*                                     */ 000730
/*           JDES FOR UTILITY PRINTOUTS  */ 000740
/*           -----                    */ 000750
/*                                     */ 000760
/* THE FOLLOWING JDES WILL ALLOW PRINTOUTS OF MOST TAPES  */ 000770
/* WITHOUT ATTEMPTING TO PROPERLY DEBLOCK THE TAPE.      */ 000780
/*                                     */ 000790
/*           CHARACTERISTICS                JOB           */ 000800
/*           -----                    -----           */ 000810
/*                                     */ 000820
/*           UNBLOCKED, NO PCC                31           */ 000830
/*           BLOCKED 4096, U, NO PCC          32           */ 000840
/*           BLOCKED 3990, FB, NO PCC        33           */ 000850
/*                                     */ 000860
31:JOB;                                000870
      VOLUME  LABEL=NONE;              000880
      BLOCK   LENGTH=133;              000890
      RECORD  STRUCTURE=U;             000900
      LINE    PCCTYPE=NONE, DATA=(0,132); 000910
32:JOB;                                000920
      VOLUME  LABEL=NONE;              000930
      BLOCK   LENGTH=4096;             000940
      RECORD  STRUCTURE=U;             000950
      LINE    PCCTYPE=NONE, DATA=(0,132); 000960
33:JOB;                                000970
      VOLUME  LABEL=NONE;              000980
      BLOCK   LENGTH=3990;             000990
      RECORD  LENGTH=133, STRUCTURE=FB; 001000
      LINE    PCCTYPE=NONE, DATA=(0,132); 001010
END;END; /* END OF JDL */             001020

```

This chapter describes tape and file formats for the DEC PDP-11 system. It also includes a JSL sample.

Tape formats

The Xerox printing system accepts tapes produced on DEC PDP-11 computers by the FLX utility. These tapes are often defined as the DOS format available on the PDP-11 computer operating systems.

File formats

Each file on a magnetic tape is followed by a single tape mark, and two tape marks end the tape. A tape mark encountered in conjunction with an end-of-tape reflector indicates an end-of-volume condition. (Refer to figure 15-1.)

Each tape file begins with a tape label record, followed by any number of data records (generally 512 bytes per record) and ends with a tape mark. These files may contain zero data records.

The label record is 14 bytes long. The format of the label is shown in table 15-1. The Xerox/OSS uses the protection code of X'9B' or O'233' to verify a DEC PDP-11 label. A BDELETE is used to delete the label block (see the printing system reference manual for block deletion).

Table 15-1. **FLX label**

Field	Character position(s)	Name	Length	Description
1	1-4	File name	4	2 words stored in RADIX 50 format
2	5-6	File type	2	1 word in RADIX 50
3	7-8	Programmer and project number	2	—
4	9	Protection code	1	X'9B' or O'233'
5	10	Unused	1	—
6	11-12	Creation date	2	Internal date format
7	13-14	Unused	2	—

Figure 15-1. DEC PDP-11 FLX tape formats

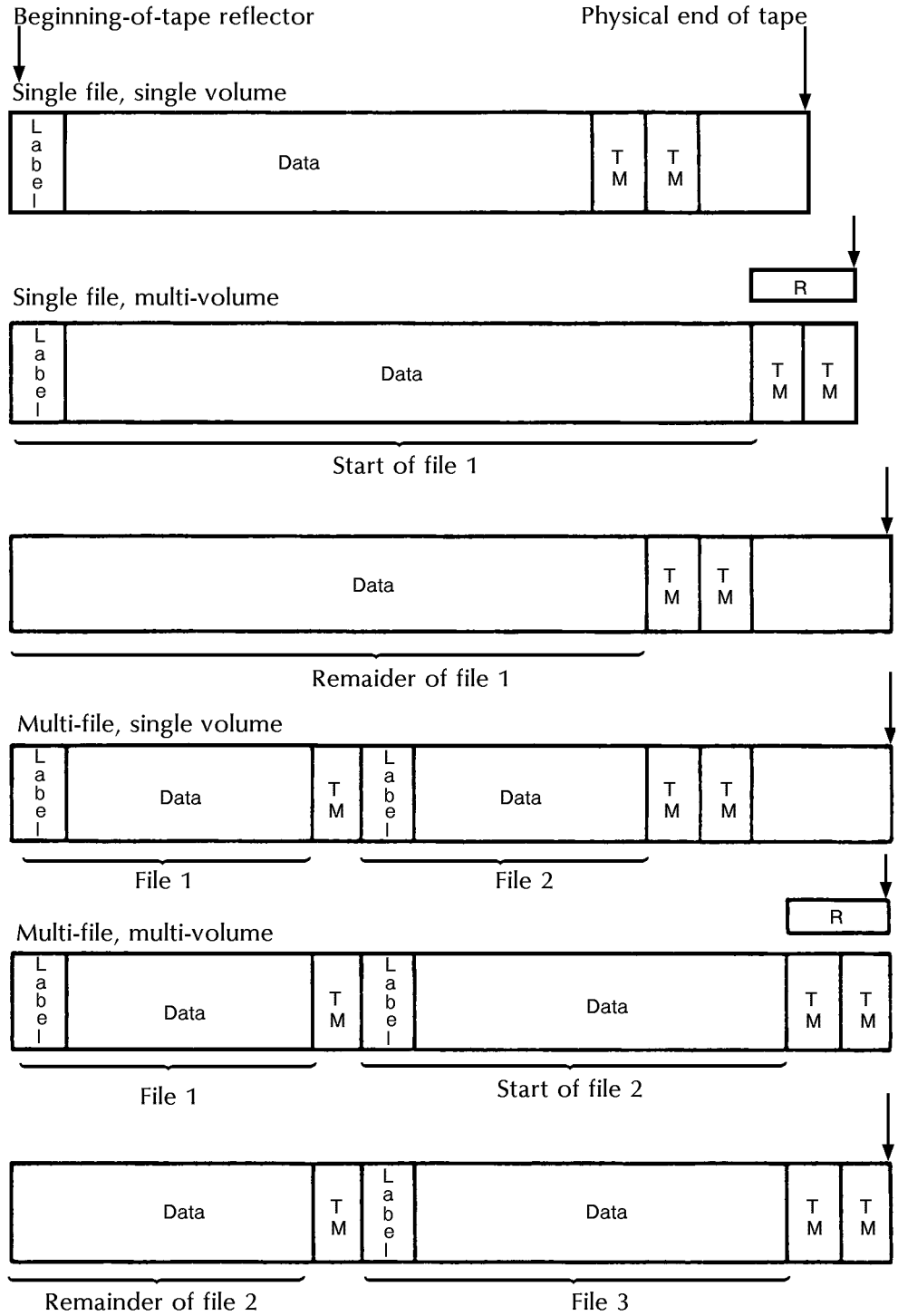

Interpretation	
TM	= Tape mark
Data	= One or more data blocks
R	= Reflectors

ANSI labeled tapes

The above format may optionally be bracketed by standard ANSI labels conforming to the requirements of the ANSI standard X3.27 (see the ANSI tape section at the beginning of this manual).

Data formats

The processing involved by HOST=RSX11 handles tapes having the following characteristics:

1. Variable record length
2. Data portion of records terminated by a carriage-related control code (see table 15-3)ASCII character code
3. ASCII character code
4. Records may span blocks.
5. The format for such tapes actually created on a DEC system is referred to as "FLX."

Data structure characteristics

The data in the record can be thought of as one long stream of characters processed serially by the printer. The stream consists of two types of characters: printable characters and control codes.

Processing of printable characters and control codes

Printable characters are accumulated until either a specified line length has been reached or one of the carriage-related control codes is encountered. The carriage-related control codes are intercepted and used to initiate the appropriate function, such as print or skip to channel. There can be several consecutive control codes with no intervening printable data. If the number of printable characters exceeds the defined print line length, the accumulated line is printed followed by a space to the next line. The next data character is used as the first character of the following print line.

The output stream is typically batched onto the tape at 512 characters per block. Any print line and its associated control code may span from one block to the next.

Null characters

Null characters (octal zero) may appear any place in the stream of characters. The nulls are discarded and are not considered in any computation of print line length. Additionally, nulls do not terminate the characters being accumulated as a print line.

Number of bytes selected for printing

Generally, all of the printable characters are intended to be printed. The exception to this is noted in the "FONTINDEX" section. With all other types of data extraction, the second parameter of the DATA= statement controls the number of bytes to be selected for printing. In the RSX11 data extraction process, the second parameter of the DATA= option indicates the number of bytes to be selected for printing on a given line. If the record is longer than that value, the following portion is printed on the next line.

Operating system operations

Within the Xerox Printing System Operating System, a record from the PDP-11 FLX format is considered to be zero or more printable characters followed by a single carriage-related control code. This processing is important in relation to the Xerox Printing System logical processing commands. It is also different from the way the application program creates the records—as data followed by multiple carriage codes.

FONTINDEX

To implement a FONTINDEX capability for this data extraction process, the first parameter of the DATA= statement must be interpreted differently from other tape formats. Normally, the first parameter is an offset to the first byte of the record that is selected for printing. Since multiple lines may result from what might otherwise appear to be a single data line (as a function of the relation between the second parameter of the DATA= and the length of the record), the bytes that are “skipped” at the beginning of the record are saved and used to provide the font selection control for the following lines, if any.

In basic function the FONTINDEX processing is no different from that used in any other data extraction; however, the byte used for specifying the font may apply to several lines instead of just one print line.

Control codes

The individual control codes are defined in table 15-3. The codes define skips to defined channels 1-7. These channels are normally set to the following sets of line numbers to emulate a standard PDP-11 carriage tape. (These assignments must be included in the Job Descriptor Entry used to print the tape.)

Table 15-2. DEC PDP-11 suggested channel assignments

Channel	Set of line numbers	Purpose
1	1	(T-O-F)
2	1, 31	(1/2 page)
3	1, 3, 5..., 59	(every other line)
4	1, 4, 7..., 58	(every third line)
5	1, 2, 3..., 65	(every line without regard for TOF or BOF)
6	1, 11, 21..., 51	(every ten lines)
7	1, 21, 41	(1/3 of a page)

The horizontal tab (octal 11) is set to every eighth position (8, 16, 24, etc.). When a tab is encountered, spaces are generated to the next tab position.

Table 15-3. DEC PDP-11 control codes

Carriage related		
Octal	Hex	Interpretation
12	0A	Line feed (print and space 1)
13	0B	Vertical tab (print and skip to channel 7)
14	0C	Form feed (print and skip to channel 1)
15	0D	Carriage return (print, without spacing)
20	10	Print and skip to channel 2
21	11	Print and skip to channel 3
22	12	Print and skip to channel 4
23	13	Print and skip to channel 5
24	14	Print and skip to channel 6

Other functions		
Channel	Set of line numbers	Purpose
00	00	Null
11	09	Horizontal tab (Move to the next multiple of 8 bytes.)

Points to note

The following guidelines pertain to the DEC PDP-11:

- The data must be in ASCII. The data extraction process assumes that the control codes (carriage-related as well as null and horizontal tab) are in ASCII. Specifying a different code (VOLUME CODE=) does not modify the control codes for which the software is searching.
- The initial reference point from which a report performs its first carriage control function is bottom-of-form (BOF). If it is necessary to override this default, a PCC user table should be created and then referenced in the appropriate LINE command. In the special PCC table, the INITIAL=TOF left-right part may be used to change the default.
- The second parameter of the DATA= specifies the number of bytes to be selected for printing on a given line. If the record is longer than that value, the remaining characters are printed on the following line.
- HOST=RSX-11 does not automatically process all the possible formats that might be created on a DEC (or equivalent) computer. It is intended to process only those tapes in the "FLX" format.
- One special aspect of the processing associated with RSX-11 is that an attempt is made to eliminate blank pages that may

come at the report's start. With some of the RSX-11 output generators, the first record generated may be a form feed. If a form feed is detected as the first record, it is deleted.

- Although "normal" data records may well span blocks, there is a restriction associated with DJDE, RSTACK, and ACCTINFO records. These records may not span blocks. The complications associated with processing these records do not allow any reasonable provision for spanning blocks. Also, since these records are most often generated as an "add on" processing to the rest of the data generation, this restriction is not a handicap to the system's usage.

PDP-11 (RSX) tape JSL sample

The following figure provides a JSL sample.

Figure 15-2. JSL sample for RSX tapes

```

/*                                     */ 000010
/*           RSX.JSL                   */ 000020
/*                                     */ 000030
/*   (   MAINTAINED ON THE RELEASE PACK   ) */ 000040
/*                                     */ 000050
/*           JDE             FUNCTION     */ 000060
/*                                     */ 000070
/*   DFLT           1-UP WITH OFFSETTING */ 000080
/*   NOFSET        1-UP WITHOUT OFFSETTING */ 000090
/*   BOTTOM        1-UP WITH HOLES AT THE BOTTOM */ 000100
/*   ONEUPD       1-UP DUPLEX OFFSET FOR HOLES */ 000110
/*   TWoup        2-UP PORTRAIT           */ 000120
/*   2UPCOV       2-UP PORTRAIT WITH COVER=FRONT*/ 000130
/*   HDR ETC.     FOR PRINTING HEADERS     */ 000140
/*                                     */ 000150
RSX:  SYSTEM;                             000160
PDE1: PDE FONTS=LAS08B, BEGIN=(1.0,1.5); /*FOR HOLES AT THE TOP!!!*/ 000170
PDE12: PDE FONTS=LAS08B, BEGIN=(.5,.5); /*FOR HOLES AT THE TOP,SHIFT*/ 000180
PDE15: PDE FONTS=LAS08B, BEGIN=(.3,1.5); /*FOR HOLES AT THE BOTTOM!!!*/ 000190
PDE2: PDE FONTS=PAS06B, BEGIN=(.22,.51), PMODE = PORTRAIT; 000200
VFU1: VFU ASSIGN=(1,1), TOF=1, BOF=66; 000210
VFU2: VFU ASSIGN=(1,1,67), TOF=1, BOF=132; 000220
T1: TABLE CONSTANT = (A' '); 000230
T2: TABLE CONSTANT = (A';+?',A'; +'), MASK = A'?'; 000240
T3: TABLE CONSTANT = (A';-?',A'; -'), MASK = A'?'; 000250
C1: CRITERIA CONSTANT = (0,1,NE,T1), LINENUM = (1,2); 000260
C2: CRITERIA CONSTANT = (40,3,EQ,T2); 000270
C3: CRITERIA CONSTANT = (40,3,EQ,T3); 000280
P1: PCC INITIAL=TOF; 000290
RSXT1: TABLE CONSTANT=X'9B'; 000300
RSXC1: CRITERIA CONSTANT=(8,1,EQ,RSXT1); 000310
      VOLUME HOST=RSX11, CODE=ASCII; 000320
      BLOCK LENGTH=512; 000330
      RECORD STRUCTURE=VB, LTHFLD=1; 000340
      ACCT USER=NONE; 000350
      BDELETE TEST=RSXC1; 000360
      LINE PCCTYPE=P1, DATA=0; 000370
DFLT: JOB; 000380
      OUTPUT FORMAT=PDE1; 000390
      LINE VFU=VFU1; 000400
NOFSET: JOB; 000410
      OUTPUT FORMAT=PDE1, DUPLEX=YES, OFFSET = NONE; 000420
      LINE VFU=VFU1; 000430
BOTTOM: JOB; /* FOR PRINTING 1-UP WITH HOLES AT THE BOTTOM */ 000440
      OUTPUT FORMAT = PDE15; 000450
      LINE VFU = VFU1; 000460
TWoup: JOB; /* PRINTS "DOUBLE-UP" PORTRAIT MODE */ 000470
      OUTPUT FORMAT=PDE2, DUPLEX=YES,SHIFT=YES,OFFSET=NONE; 000480
      LINE VFU=VFU2; 000490

```

```
2UPCOV: JOB; /* PRINTS "DOUBLE-UP" PORTRAIT MODE WITH COVERS */ 000500
        OUTPUT FORMAT=PDE2,DUPLEX=YES,SHIFT=YES,OFFSET=NONE,COVER=FRONT; 000510
        LINE VFU=VFU2; 000520
ONEUPD: JOB; /* Prints one-up duplex with room for holes */ 000530
        OUTPUT FORMAT=PDE12,DUPLEX=YES,SHIFT=YES,OFFSET=NONE; 000540
        LINE VFU=VFU1; 000550
HDRCAT: CATALOG; 000560
        OUTPUT OFFSET = NONE; 000570
        LINE VFU = VFU1; 000580
        RSUSPEND TEST = C3, BEGIN = NEXT; 000590
        RRESUME TEST = C2, BEGIN = CURRENT; 000600
        RDELETE TEST = C1; /* WITH PATCHES SKIPS RRE/RSU CHECK */ 000610
        ABNORMAL RES = 998; /* FLAG SPECIAL JDE */ 000620
HDR: JOB INCLUDE = HDRCAT; /* FOR HEADERS WITH HOLES AT THE TOP */ 000630
        OUTPUT FORMAT = PDE1; 000640
HDRBOT: JOB INCLUDE = HDRCAT; /* FOR HEADERS WITH HOLES AT THE BOTTOM */ 000650
        OUTPUT FORMAT = PDE15; 000660
        END; END; 000670
/* */ 000680
/* To convert a Xerox character code assignment */ 000690
/* font to the ASCII assignment use these FED */ 000700
/* comands: */ 000710
/* INPUT <fontname-type> */ 000720
/* HEX */ 000730
/* INCLUDE 1E-7A */ 000740
/* RECODE 7B=1A-1D */ 000750
/* OUTPUT <newfontname.type> */ 000760
/* */ 000770
```

16. ICL 2900 VME/B tape format

The Xerox/OSS accepts ICL 2900 tapes of variable and fixed length blocks.

Tape formats

Each block, including label blocks but not tape marks, is preceded by the following 6-byte preamble:

Bytes 1 through 4 Block sequence number

Bytes 5 and 6 Block length (including preamble)

Label blocks comply with ANSI label specifications beyond the 6-byte preamble. (Refer to chapter 1 of this manual.)

Data block formats

ICL 2900 VME/B variable length data blocks include an extra 2-byte field, in addition to the 6-byte block preamble, which contains the offset from byte 7 to the first byte in the last or only record in the block.

The record format for a variable block tape has the following 4-byte record preamble as shown in figure 16-1.

Bytes 1 and 2 Record length (including preamble)

Bytes 3 and 4 File management and record spanning indicators

Figure 16-1. ICL 2900 variable block data format

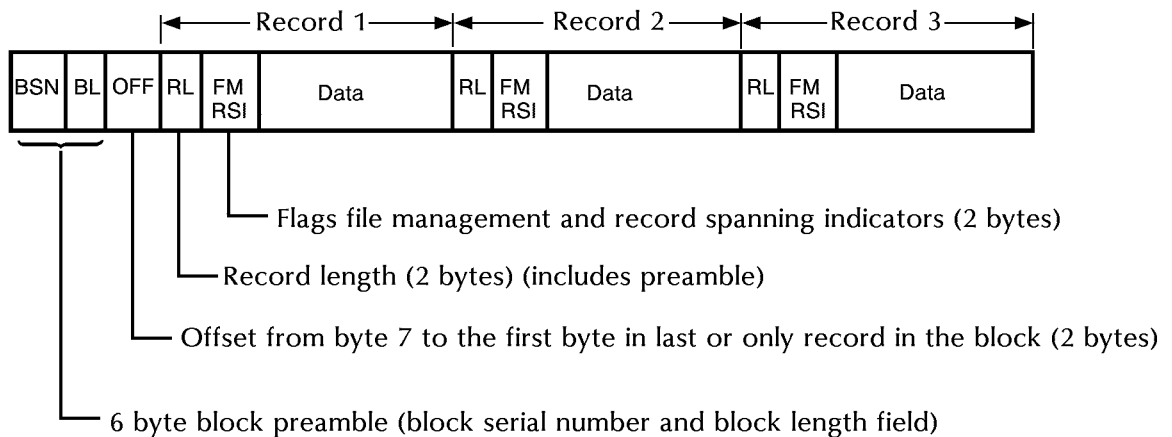

Bytes 3 and 4 of the record preamble contain information concerning spanned records, but spanned records are not processed. If spanned records are encountered, the tape being processed is considered to have an invalid format, and the job aborts with appropriate messages displayed.

ICL 2900 VME/B fixed blocks have the following format:

Figure 16-2. **ICL 2900 VME/B fixed block data format**

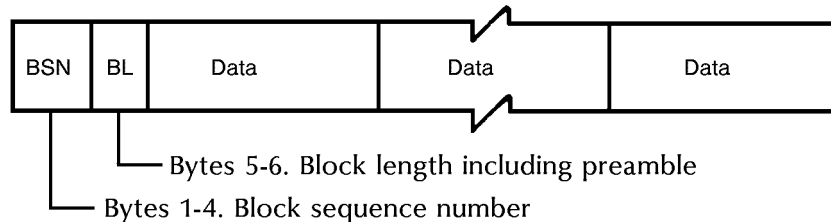

Carriage control conventions

The ICL 2900 VME/B tape format allows printer carriage control codes, called format effectors, to be embedded throughout the user portion of a record. However, the Xerox/OSS processes only format effectors that appear and begin in the first four bytes of the user portion of a record.

Format effectors

There are two types of carriage controls: normal format effectors and embedded format effectors. Normal format effectors are one or two byte codes which appear and begin in the first four bytes of a record. Embedded format effectors are also one or two bytes in length, but can appear anywhere in the user portion of a record.

Format effectors (FE) must adhere to the following restrictions:

- The first or only byte of the first FE in a record must be in the first byte of the user portion of a record.
- Multiple FEs must be contiguous, as the first byte encountered that is not a valid FE is considered the start of print data.
- The first or only byte of all format effectors for a record must be contained in the first four bytes of the user portion of a record.

Each user record can contain zero to four format effectors. The following table (table 16-1, "Format effector interpretation") outlines the action taken depending on the format effectors:

Table 16-1. **Format effector interpretation**

Formal effector	Action
No format effectors or all FEs are filler	Carriage control action is space-one-and-print.
Multiple FEs	Processed left to right. All carriage control action occurs prior to printing.
Multiple FEs causing page skips (within a record or in consecutive records)	Processed as ADVTAPE = YES*
First FE in report	INITIAL = BOF*
All FEs causing bottom-of-form to be encountered (except X'2200' and X'0C')	Processed as IGN*

* See PCC command in *Printing System Reference Manual* for interpretation.

Normal format effectors

Normal format effectors are one- or two-byte codes that may only appear and begin in the first four bytes of a record. They are composed of any combination of the following:

Table 16-2. **Normal format effectors**

Code	Function
X'07'	Filler
X'21nn'	Space 'nn' lines
X'22nn'	If 'nn' = 0, skip to channel 1 If 'nn' = 0, space to line number 'nn'
X'0C'	Skip to channel 1

X'22nn' is used to space to line number 'nn' relative to Top-of-Form. Line numbers must be greater than or equal to one, and cannot exceed 255. If 'nn' is less than or equal to the current line number, a space to line 'nn' on the next page occurs. If X'21nn' causes BOF to be encountered (i.e., line 'nn' is greater than BOF minus TOF), the space is processed as IGN. To process X'0C' and X'2200' properly, channel 1 must be assigned a line number by the user; otherwise, a print-and-space-one carriage control is substituted.

Embedded format effectors

On ICL tapes, embedded format effectors (FEs) must appear and begin within the first four bytes of the user portion of a record, and comply with the restrictions previously stated under carriage control conventions in order to be processed correctly. FEs that do not comply with the restrictions do not cause any printer carriage control action to occur, and normally print as a blank. A non-blank character can be generated if the 'nn' portion of an embedded format is greater than X'80'.

Embedded format effectors, one or two bytes in length, are composed of any combination of the following:

Table 16-3. **Embedded format effectors**

Code	Function
X'0C'	Skip to channel 1 and print
X'15'	Space 1 line and print
X'25'	Space 1 line and print
X'0D'	Space 0 lines (end line with no advance)
X'22nn'	If 'nn' = 0, skip to channel 1 If 'nn' __, space to line number 'nn'
X'21nn'	Space 'nn' lines and print
X'20nn'	Insert 'nn' spaces horizontally

If X'20nn' causes the maximum line length to be exceeded, the line is truncated to the maximum line length. Although format effectors are processed from left to right, horizontal spacing FEs are performed for the current line of data regardless of any vertical spacing that follows. If a two-byte FE appears as the fourth byte of a string of multiple FEs, it is processed normally.

ICL tape JSL sample

The following figure provides a JSL sample.

Figure 16-3. JSL sample for ICL tapes

```

ICL:JDL;                                                    000010

/*                                                         */ 000020
/* SYSTEM TO PRINT ICL 2900 VME/B STANDARD                */ 000030
/* LABELED TAPES                                          */ 000040
/*                                                         */ 000050
V1: VFU ASSIGN=(1,5), TOF=5, BOF=66;                      000060
    VOLUME HOST=ICL2900, LABEL=STANDARD, CODE=EBCDIC;    000070
    BLOCK LENGTH=2054, PREAMBLE=8, LTHFLD=2, OFFSET=4,   000080
        FORMAT=BIN;                                       000090
    LINE PCCTYPE=NONE, VFU=V1;                             000100
/*                                                         */ 000110
/*                                                         */ 000120
/* CHARACTERISTICS                                         */ 000130
/* ----- JOB -----                                     */ 000140
/* VARIABLE,BLOCKED LTHFLD=2          1                   */ 000150
/* VARIABLE,BLOCKED LTHFLD=4          2                   */ 000160
/* FIXED,BLOCKED                      3                   */ 000170
/*                                                         */ 000180
/*                                                         */ 000190
1:JOB;                                                      000200
    BLOCK ZERO=YES;                                         000210
    RECORD LENGTH=168, STRUCTURE=VB, PREAMBLE=4, LTHFLD=2, 000220
        OFFSET=0, FORMAT=BIN;                               000230
2:JOB;                                                      000240
    BLOCK ZERO=YES;                                         000250
    RECORD LENGTH=168, STRUCTURE=VB, PREAMBLE=4, LTHFLD=4, 000260
        OFFSET=0, FORMAT=BIN;                               000270
3:JOB;                                                      000280
    BLOCK LENGTH=2048;                                       000290
    RECORD LENGTH=136, STRUCTURE=FB;                         000300
END;END;                                                    000310

```

Glossary

- A3** Paper size measuring 297 by 420 mm.
- A4** Paper size measuring 210 by 297 mm.
- abort** To terminate the printing of a job or execution of a program before it completes.
- algorithm** Computational procedure that can be repeated any number of times.
- alignment** Positioning of an image on a page for printing.
- alphanumeric** Set of characters including the letters A through Z, numerals 0 through 9, and all printable special symbols.
- AIM** Ancillary IOT message processor. System task that initializes the client layer between the printer and the system controller. It also displays the Fault, Hint, and information messages.
- ASCII** American Standard Code for Information Interchange. Standard 7-bit code that represents alphanumeric information. Each alphanumeric character and several nonprinting characters are assigned a binary number, covering 128 possible characters. It is used for information interchange among data processing systems, data communication systems, and associated equipment.
- application** Use to which a computer program or system is put, for example, sorting employee records.
- applications software** Host- or LPS-resident software that directs the computer to perform specific tasks or functions as opposed to the software used to operate the computer. Common business applications include payroll, accounting, and inventory.

ascender Portion of alphabetic character that rises above the body of the character (its x-height portion). *See also* descender; x height.

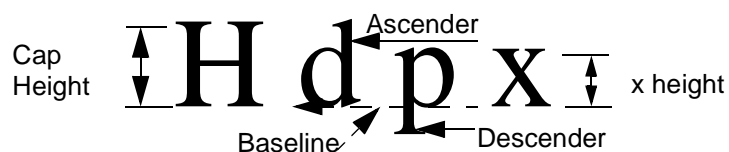

asynchronous Transmission in data communications controlled by start and stop elements at the beginning and end of each character. Thus, time intervals between transmitted characters may be unequal in length.

B4	Paper size measuring 250 by 353 mm.
background job	Low-priority job, usually batched, that is executed automatically as system resources become available.
backup file	File copied to a storage medium for safekeeping in case the original is damaged or lost.
band	Rectangular area in printer memory into which an image sent to the printer from a computer is divided.
batch processing	Allows for repetitive operations to be performed sequentially on batched data without much involvement of the computer operator.
baud	Measurement of data rate in bits per second. This term is used to describe information flow between two devices. Unit of data transmitting and receiving speed is roughly equal to a single bit per second. Common baud rates are 110, 300, 1200, 2400, 4800, and 9600.
binary	Numbering system based on 2 that uses only the symbols 0 and 1. Binary is used in computers and related devices since information can be represented with electric pulses (0=off, 1=on). Most computer calculations are binary.
binary digit (bit)	<p>In the binary numbering system, either of the characters 0 or 1. The "bit" is the base unit of information used by computers. It can take the form of a magnetized spot, an electric pulse, or a positive or negative charge. A sequentially stored set of bits represents a character on a computer.</p> <p>Multipliers are:</p> <ul style="list-style-type: none">1 or 0 byte = 8 bytes1 kilobyte(KB) or 1,024 = 8,192 bits1 megabyte(MB) or 1,048,576 = 8,388,608 <p>Computer space equivalents are:</p> <ul style="list-style-type: none">1.5 KB = about 1 single-spaced typed page30 KB = about 20 typed pages150 KB = about 100 typed pages
binary synchronous transmission	Data transmission in which synchronization of characters is controlled by timing signals generated at the sending and receiving stations.
bit	Abbreviation for binary digit, the smallest unit of information recognized by a computer. <i>See also</i> binary digit.
bit map	Visual representation of graphic images in which a bit defines a picture element (pixel); for example, if a bit is 1, the corresponding pixel is printed.

bit mapped	Display image generated bit by bit for each point or dot. A software-driven scanner is used to create characters or graphics.
blocking	Process of combining two or more records into a single block of data which can then be moved, operated upon, or stored, as a single unit by the computer.
block length	Number of characters or bytes contained in a block of data (the block is treated as a unit within the computer). Block length is usually invariable within a system and may be specified in units such as records, words, computer words, or characters.
boot	To load the initial instructions of a program into computer memory; these instructions then direct the loading of the rest of the program. Booting may require entry of a few commands at the keyboard or the flip of a switch to begin the process.
bps	bits per second. In serial communication, the instantaneous bit speed with which a device or channel transmits a character.
BSC	binary synchronous communication. 1. Communication using binary synchronous line discipline. 2. Uniform procedure using a standardized set of control characters and control character sequences for synchronous transmission of binary-coded data between stations.
buffer	Compartment of memory in which this data is stored during transfer from one device to another. This is useful for accumulating data into blocks before storage or processing and for adjusting differences of speed between devices, or between a device and a communicating facility.
Bypass Transport	Optional module that moves paper from the last stacker bin to a finishing device.
byte	Fixed number of bits (in data processing, usually 8) operated upon as a unit. A byte may represent a character, a machine instruction, or some other logical unit of information.
carriage return	Control character that causes the printing system to start printing at the left margin of the current line unless set to be interpreted as a line end.
channel	1. In data communications, a path or line that enables two or more devices to communicate (sometimes called a circuit, facility, or link). 2. In computers, a path for communication between the central processing unit (CPU) and input/output units, or between the CPU and peripheral devices.
character	Single printable letter (A-Z), numeral (0-9), symbol (& % #), or punctuation mark (, . ! ?) used to represent data. Characters can also be nonprinting, such as space, tab, or carriage return.

character cell	Digitized space containing a single character within a font set.
character code	Code representing alphanumeric information, for example, ASCII.
character code identifier	Code associated with the universal identifier "Xerox" to indicate the version of the Xerox character code standard used to code Interpress strings.
character set	Number of different characters used by a particular device, including alphabetic, numeric, and special characters such as symbols.
client layer	The software interface used by the AIM task and the Output task to communicate with the printer, allowing printing commands and fault and status information to be exchanged.
clocking	A method of synchronizing the sending and receiving of data communications devices. Clocking allows synchronous transmission at high speeds.
cluster	Group of paper feeder trays, usually containing the same size and type of paper (stock). Each cluster has a name, consisting of one to six alphanumeric characters. <i>See also</i> stock; stockset.
CME	copy modification entry. Entry modifying the output printing characteristics of a report on a copy-to-copy basis.
code	1. Set of symbols representing data or instructions to a computer. 2. To write a list of instructions (software) to cause the product/system to perform specified operations.
code conversion	Translation of one type of character or symbol code to another.
collate	To arrange or assemble into ordered sets.
column	Vertical arrangement of characters.
command	User instruction to a computer, using the system controller keyboard display. Commands are words, mnemonics, or characters that cause a computer to perform predefined operations. Coded instruction to a computer or computer-based system.
command language	Set of commands that can be used for a system, such as how the system can be instructed to perform a task.
comment	Explanations written with program instructions. They are ignored by the computer.
communication line	Telecommunication line connecting devices at one location with devices at other locations in order to transmit and receive information.

communication link	Physical means, such as data link, connecting one location to another to transmit and receive information.
communications	Ability of two devices to transmit information to each other.
compatibility	Characteristic of computer equipment permitting one device to use the same information or programs as another device without conversion or code modification.
compiler	Software that translates instructions written in high-level language into machine language for execution by a system.
computer	Functional unit capable of performing substantial computations, including numerous arithmetic or logic operations without human intervention during a run.
computer language	Computer-oriented language consisting solely of computer instructions. <i>See also</i> machine language.
computer system	Central processing unit (CPU) with main storage, input/output channels and devices, control units, and external storage devices connected to it.
concatenate	To connect or link in a series, as when files are grouped together for faster processing. <i>See also</i> job concatenation mode.
console	Functional unit containing devices used by an operator to communicate with an operating system. It may consist of a display, keyboard, and certain switches or other controls.
consumable supplies	Supplies such as paper and dry ink that are depleted (used up) during the course of normal printer operation.
continuous printing	Refers to Interpress job integrity under any of the following conditions: excessive graphics, forms, or font use problems.
control program	Program that supports the operating system by monitoring the flow of jobs, tasks, processing, and so on, within the system; for example, a data communication program.
coordinate	Point on the x and y axis that determines a grid position.
copy	To duplicate data in a new location or on an additional storage medium, for example, to copy files from disk to tape.
copy-sensitive	Term used to indicate jobs in which multiple copies of a report will contain different data, as with paychecks and banking statements.
cpi	characters per inch. Designates the number of characters per inch for a particular typeface. <i>See also</i> pitch.

CPU	central processing unit. Interprets and executes instructions, performs all operations and calculations, and controls input and output units and auxiliary attachments.
data	1. In general, facts, numbers, letters, symbols, and so on, which can be processed or produced by a computer. 2. In data processing, the source data or raw data entered for processing, as opposed to the results obtained by processing.
database	Information to meet specific processing and retrieval needs. Generally applies to integrated file of data, arranged for access by many subsystems.
data communications	Transmission and reception of encoded information over telecommunication lines.
data file	Collection of related data records organized in a specific manner so that each record is similarly structured, for example, a payroll file set up with one record for each employee, last name first, indicating the rate of pay and all deductions.
data processing	Operations carried out on data by means of algorithms and programs to produce information or a specific result. The rearrangement of data into a suitable form for further use.
data rate	In data communications, the rate at which a channel carries data, measured in bits per second (bps).
data storage	Preservation of data on various media, for example, tape, disks, magnetic bubble memory, and so on.
data transmission	Transmission of coded data over telephone or other telecommunication lines.
debug	To detect and correct errors in a program.
decompose	To break down into component parts, such as when Interpress breaks down a Font Interchange Standard (FIS) master to compile font information.
default	Value assigned to a field by the system. Default fields may be used for such items as document formats, menu selections, input fields, font selection, and paper or image size. The default value of a field may be changed.
descender	Portion of alphabetic character that extends below the baseline. See <i>also</i> ascender, x height.
device	Any piece of hardware other than the central processing unit (CPU).

digitize	To express or represent data in digital (binary) form so that it can be processed electronically.
disk drive	Device that can read or write magnetic media.
display	Viewing device (monitor) that visually communicates system warnings, status, and error messages and reflects operator interaction with the system on a display.
DJDE	Dynamic Job Descriptor Entry. Command within an input data stream used to modify the printing environment dynamically.
document	1. Data medium and the data recorded on it, usually permanent, which can be read by you or a computer. 2. Collection of information pertaining to a specific subject or related subjects.
dot	Unit of measurement representing a fraction of an inch, for example, 300 dots per inch (dpi). It may also be referred to as a picture element (pixel) or spot.
download	To copy files using communication lines from the host onto LPS system disks.
dry ink	Minute dry particles of resin and carbon black used to create images. Dry ink can accept an electrical charge.
duplex printing	Printing on both sides (front and back) of a page. <i>See also</i> simplex printing.
EBCDIC	Extended Binary Coded Decimal Interchange Code. Coded character set consisting of 8-bit coded characters. It can accommodate 256 characters.
edgemarking	Use of graphic objects, usually lines or boxes, that bleed off the edge of the physical page. <i>See also</i> physical page.
electronic publishing	Integrated production of documents on demand, using digitally stored documents, computerized composition, and electronic printing systems.
elite	Smallest size standard typewriter type: 12 characters per horizontal inch. <i>See also</i> pica.
embedded blanks	Blank spaces within a command line.
Ethernet	Xerox local area network (LAN) that allows data to be transmitted by cable from one device to another, enabling it to share the network.

extended metrics	Measurements used in Interpress to alter the size of fonts, allowing more precision with character escapement. Used for rendered characters.
FCB	forms control buffer. Buffer for controlling the vertical format of printed output.
FDL	forms description language. LPS-resident source language used for designing electronic forms. <i>See also</i> FSL; form.
field	1. Part of a record that serves a similar function in all records of that group, such as name and address field. 2. Area or setting of practical activity or application.
file	Set of records or text that can be stored and retrieved. An organized, named collection of records treated as a unit. For offline, it is the data between the two tape marks. For online, it is the data between banner pages.
file protection	To prevent the contents on a disk or tape from being erased or written over by disabling the write head of a unit.
firmware	Permanent programs stored in read-only memory (ROM).
FIS	Font Interchange Standard. Standard that defines the digital representation of fonts and character metrics for the generation of an entire series of Interpress fonts.
fixed font	Font containing characters with fixed spacing. <i>See also</i> proportional font.
fixed pitch	Font set in which every character cell has the same width. In reference to character sets, this term describes typefaces in which all character cells are of equal width. Monospaced as opposed to proportional spaced.
fixed spacing	Arrangement of characters on a line so that all characters occupy the same amount of horizontal space.
floating accent	Nonspacing accent characters that can be combined with characters and printed as a composite.
font	Set of images, usually characters and symbols, having common characteristics such as style, width, height, and weight.
form	1. Compiled forms source library (.FSL) file. 2. Printed or typed document with blank spaces for inserting information. Specific arrangement of lines, text, and graphics stored in a computer under an identifying name. Page of data that, when preceded by proper commands, is stored on the system disk as a permanent file. It may be merged with variable data by a form start command. <i>See also</i> FDL; FSL.

format	1. Layout of a document, including margins, page length, line spacing, typeface, and so on. 2. In data storage, the way the surface of a disk is organized to store data. 3. To prepare the surface of a disk for acceptance of data.
form feed	Keyboard or printer control character that causes the printer to skip the top of the next page.
FSL	forms source library. Uncompiled collection of user-created files containing FDL commands. See <i>a/so</i> FDL; form.
function keys	Keyboard keys that produce no character but initiate a particular machine function, such as delete.
fuse	To affix dry ink to paper by heat or pressure or a combination of both.
GCR	group code recording mode. Refers to the specific density of data (such as 6250 bpi) as it is recorded on tape, which is measured in bits per inch (bpi).
graphics	Use of lines and figures to display data, as opposed to using text.
grid	Imaginary pattern of evenly spaced horizontal and vertical lines on a page.
grid unit	Smallest rectangle enclosed by horizontal and vertical lines on a grid. The size of a grid unit is expressed as the length of one side of a rectangle.
halftone screen	A tool used in offset printing, typesetting, and laser printing to convert a continuous tone (such as photographic) image to dots, which allows the image to be rendered accurately in these printing processes.
hardcopy	Machine output in permanent form, such as printed reports, listings, and so on. Output in a permanent form (usually on paper or paper tape) rather than in temporary form, as on a display. Contains readable printed copy of machine (for example, computer) output.
hard values	Nonoptimal adjustment of particular FIS fonts in terms of point size and orientation.
hardware	Physical components, such as mechanical, magnetic, and electronic elements of a system, as opposed to programs, procedures, rules, and associated documentation. Hardware is operated by software and firmware.
HCF	High-capacity feeder. Feeder tray capable of holding 2500 sheets of 20 pound/80 gsm paper. The high-capacity feeder tray is the primary paper supply for the DocuPrint 96 LPS. It is located in the bottom half of the feeder/stacker module.

HCS	high-capacity stacker. Stacker bin capable of holding 2500 sheets of 20 pound/80 gsm paper. In the LPS, the high-capacity stacker bins are located in the top half of the feeder/stacker modules.
hexadecimal	Numbering system with a base of 16. In this system, 10 through 15 are represented by A through F, respectively.
hierarchy	Relative priority assigned to arithmetic or logical operations that must be performed.
high-level language	Language consisting of words and symbols that are close to normal English and, therefore, readily understandable by the user. High-level languages are oriented to problems or commercial procedures and are the source languages for most programs.
host	Computer accessed by users which serves as a source of high-speed data processing for workstations with less computer power. <i>See also</i> mainframe.
host interface	Connection between network and host computer.
id	identifier. Character used to identify or name data and possibly to indicate certain properties of that data.
image area	Area on a physical page that may contain text or graphics.
information processing	Generic term encompassing both word and data processing, used to describe the entire scope of operations performed by a computer.
initialize	1. To prepare the magnetic surface of a blank diskette so that it can accept data. 2. To set all information in a computer system to its starting values (usually the first step is accomplished when a program is booted).
input	Data or text introduced into a computer-based system.
input/output	General term encompassing the flow of data into and out of a system.
input processing	Formatting control for the pages of a report.
insert	To add text or graphics to a document.
interface	Device by which two systems connect and communicate with each other.
interpolation	Series of logical rules implemented in the printer to convert a 300 spi input video stream to a 600 spi output video stream. Interpolation is functionally analogous to bit doubling (2x scaling), except the logical rules result in superior output.

Interpress	Xerox standard that defines digital representation of lines for printing. Interpress documents can be printed on any sufficiently powerful printer equipped with Interpress print software.
Interpress font utility (IFU) program	Program used to convert FIS fonts to LPS fonts.
Interpress master	File written according to the Interpress standard.
IPL	initial program load. For the optional open-reel tape drive, the internal initialization sequence whereby certain functions are loaded into random access memory (RAM).
JDE	job descriptor entry. Collection of job descriptions. <i>See also</i> job; JSL.
JDL	job descriptor library. Collection of compiled job descriptions. <i>See also</i> JSL.
job	1. Set of instructions (JDEs) defining a unit of work for the system. 2. In setting a separation boundary through the Bin Full Criteria task, job refers to everything printed as the result of a single start command. <i>See also</i> JDE.
job concatenation mode	In HIP, a mode in which multiple print jobs are processed as reports in one print job. <i>See also</i> concatenate.
job control	Program called into storage to prepare each job or job step to be run.
job management	Collective functions of job scheduling and command processing.
JSL	job source library. Collection of uncompiled job descriptions. <i>See also</i> job; JDE; and JDL.
keyboard	Group of alphabetic, numeric, and/or function keys used to enter information into a system.
keyword	Required part of a command. <i>See also</i> operator command.
label	1. In data storage, a reference to a file saved on tape or disk, a record indicating the file name or date created, or other control information. 2. In programming, a name assigned to a particular instruction or portion of a program as a locational reference (the computer translates the label into an address).
landscape page orientation	Orientation of print lines or top of an illustration parallel to the long edge of the paper if the sheet is within the standard size range. (Sheets larger than standard have the reverse print orientation.)
language	Defined set of characters and symbols combined together by specific rules. <i>See also</i> high-level language; low-level language.

laser printing	Technology that uses a laser to transfer character forms to a page by direct or indirect means.
latent image	Static charge present on the photoconductor before contact with dry ink particles.
leading	1. Vertical distance between lines (also called line space), measured from a baseline of one line to the baseline of the next. 2. Extra spacing between lines of type. 3. In typography, spacing between lines and paragraphs.
LED	light emitting diode. Solid substance that glows when a current is passed through it. Often used for indicator lights on disk drives or modems, as well as for displays on other electronic equipment.
LEF	long-edge feed. The movement of paper through the printer in the direction of the paper length (the longer side of a sheet of paper).
legal size	Sheet the standard size of legal briefs, 8.5 by 14 inches.
letter size	Paper sized 8.5 by 11 inches/216 by 279 mm.
library	In data storage, a collection of related files or programs.
line	One horizontal flow of characters.
line feed	Control character that, unless set to be interpreted as a line end, causes the printing system to begin printing in the current character position of the next line.
line tables	Internal data structures providing a record in memory of lines to be drawn on a page.
listing	Printout or display of the statements in a program, usually used as a convenience in examining or editing programs.
literal	Alphanumeric beginning with a letter, optionally including an asterisk, period, colon, or slash, and not enclosed in single quotes.
load	To enter data into storage or working registers.
location	Place in which data can be stored.
log	Collection of messages or message segments placed on an auxiliary storage device for accounting or data collection purposes.

logical page	In the Xerox printing systems environment, a formatted page that is smaller than the physical page. A logical page is defined by an origin, thus allowing more than one logical page to be placed on a physical page.
logo	Small illustration or design, usually simple, typically used to identify a company.
log off	Procedure by which a user ends a session.
log on	Procedure by which a user begins a session between an application program and a logical unit.
magnetic media	Term for all storage devices, such as disks, diskettes, and tape, on which data is stored in the form of magnetized spots on surface of the media.
magnetic storage	Use of magnetic media to store data, programs, and so on.
magnetic tape	Flexible plastic tape, with one side offering a magnetic surface suitable for storing computer data in the form of magnetized spots. Magnetic tape is often used for long-term storage since it can accommodate large volumes of information.
mainframe	Central processing unit (CPU) and memory of a large computer. More often used to denote any large computer of the type that might be used to control a group of smaller computers, terminals, or other devices. <i>See also</i> host.
margins	White space on each side of printed text.
mask	1. Selection of bits from a storage unit by using an instruction that eliminates the other bits in the unit. 2. In accessing files, a file name mask is used to reference one or more files with similar file-id (identifier) syntax. 3. In Interpress, a mask serves as a template, indicating the shape and position of an object on a page.
MB	megabyte. Unit of one million bytes.
media	Vehicles or devices by which information is stored or transmitted. Classifications include source, input, and output.
medium	Object or material on which data is stored, for example, magnetic tape or floppy disk.
memory	Space in a device where information is kept, or the ability of a device to keep information until needed.
menu	List of available functions, commands, and options.

message	Unit of information transmitted by one facility to another in a form that the receiving facility can understand and act upon. The standard message format consists of a header (containing identifying and control information), followed by the actual message content, followed by a trailer (indicating that the message is completed).
metacode	Same as "native mode." The method of speaking to and controlling the image generator. These controls are used by the character dispatcher to generate scan line information. This information is sent in the form of character specifications to the image generator, which uses it to compose the bit stream that modulates the laser.
MHz	megahertz. 1. Unit of cycling speed (one million cycles per second) for an electromagnetic wave (in particular, a radio wave). 2. Sending and receiving stations of a radio wave transmission must be tuned in to the same unit of megahertz.
mode	Manner in which an activity or process is carried out.
modem	Device that converts digital information into an analog signal suitable for sending over analog telecommunication lines. Also converts an analog signal from telecommunication lines into digital information.
module	Cohesive unit within a program. It is consistent in its level and identifiable in terms of loading or with other units.
network	1. System of geographically separate computers, linked to one another over transmission lines. 2. Communication lines connecting a computer to its remote terminals.
nonimpact printer	Printer that forms characters without any strikes of a key or element against the paper.
object file	Source file converted into machine language (binary code).
offline	Devices not under the active control of a central processing unit. For example, a computer makes output to a magnetic tape. The tape is then used by an offline printing system to produce printed data. Offline operations are much slower than online operations. <i>See also</i> online.
offset	To place pages currently being printed in slightly different positions from previous pages.
offset printing	Widely-used method of commercial and corporate printing, where ink is picked up by a metal or paper plate, passed to an offset drum, and then passed to the paper.
online	Devices under the direct control of a central processing unit, for example a printing system in interactive communication with a mainframe. <i>See also</i> offline.

operating system	Basic host- or LPS-resident controlling program that governs the operations of a computer, such as job entry, input/output, and data management. The operating system is always running when the computer is active. Unlike other types of programs, it does not run to an end point and stop. The operating system of a Xerox LPS is referred to as the operating system software (OSS).
operation	Well-defined action that, when applied to any permissible combination of known entities, produces a new entity.
operator area	The 24-inch exclusive clearance that must be available directly in front of each component of an LPS for operator activities.
operator command	Statement to control a program, issued through a console device or terminal, causing a control program to provide requested information, alter normal operations, initiate new operations, or terminate existing operations.
orientation	1. In reference to image area, orientation describes whether the printed lines are parallel to the long edge of the paper or the short edge of the paper. 2. Choice of printing portrait (vertically) or landscape (horizontally).
origin	In reference to image area, this is the upper left corner of a sheet.
output	1. Material produced by a peripheral device of a computer, such as a printout or a magnetic tape. 2. Result of completed operations.
overprinting	Printing more than one character at the same position.
overprint lines	Print lines whose carriage control specifies printing with no line spacing after the last printed line.
overprint ratio	Maximum number of variable data and form characters that may be intersected by a single scan line.
override	To take precedence or priority over, to overrule.
overstrike	To print characters over each other.
page	1. In computer programming, a block of instruction, data, or both that can be located in main or auxiliary storage. 2. In word processing, a defined section of a document.
page orientation	Direction in which data is printed on a report. <i>See also</i> landscape page orientation; portrait page orientation.
parameter	Part of a command, other than the keyword. <i>See also</i> keyword; operator command.

pass-through job	On systems with XPAF, a job that is sent directly from a host to a Xerox printer using XPAF, without undergoing XPAF processing.
password	Unique word or set of characters that an operator or user must supply to log on to a system.
patch	In programming, to modify a portion of the program at the machine language level, as opposed to modifying at the source program level.
PDL	print description language. Language used to describe printing jobs to an LPS. PDL describes the input (type, format, characteristics), performs the processing functions (logical processing), and describes the output (type, format, font selection, accounting options).
physical page	Sheet of paper on which printing is done. <i>See also</i> edgemarking.
pitch	1. Horizontal character spacing; 10-pitch (10 characters per inch) spacing is called pica, and 12-pitch (12 characters per inch) spacing is called elite. 2. The number of page images placed on the xerographic belt during one revolution. The DocuPrint 96 LPS operates in a multi-pitch mode, allowing the mode to be adjusted according to the width of the paper used.
pixel	Acronym for picture element. Smallest addressable point of a bit-mapped screen that can be independently assigned color and intensity. Pixels are definable locations on a display used to form images. For graphic displays, more pixels generally provide higher resolution. Spots, dots, and pixels are used interchangeably.
point	Unit of measurement equal to 0.0139 inch. Points are always used to express type size and leading. There are 12 points to a pica and about 72 points to every inch. <i>See also</i> pica.
point size	Height of character set from the top of its ascenders to the bottom of its descenders in units (points). Point size does not always include leading.
portrait page orientation	Orientation of print lines or the top of an illustration parallel to the short edge of the paper if the sheet is within the standard size range. Sheets larger than standard have the reverse print orientation.
printer	Output device that produces hardcopy printouts. Also referred to as the IOT.
print file	Position of the system disk memory (up to 4 MB) received for temporary storage of formatted pages for printing. Pages are retained until they are delivered to the output tray.
printout	Informal expression referring to almost anything printed by a computer peripheral device.

process	1. To perform a systematic sequence of operations, such as add, edit, delete. 2. To produce a specific result by manipulating data.
program	Complete set of instructions in language compatible with the device to be used. A program directs a system to perform each operation at the right time in the proper sequence.
programmer	Person involved in designing, writing, and testing computer programs.
prompt	Message or symbol displayed on a system console requiring the operator to take action.
proportional font	Font containing characters that vary in width. <i>See also</i> fixed font.
proportional spacing	Text in which each alphanumeric character is given a weighted amount of space. Such output has print-like appearance. Proportional spacing allows more space for wide characters and less space for narrow characters
proportional type	Characters that vary in width.
protocol	Formal set of conventions governing the format of data and the control of information exchange between two communication devices.
purge	To delete data from a system.
queue	List of documents waiting to be processed.
RAM	random access memory. Storage that allows data, such as documents, to be stored and retrieved directly by address location without reading through any other data.
raster data	Binary data, usually consisting of dots arranged in scan lines, according to the print order.
rasterization	Creation of a page's bit map image for printing.
read/write head	Input/output device that reads and writes data in the form of magnetic dots on the surface of an external storage medium, such as a magnetic disk.
record	Collection of data or words treated as a unit.
recovery	Act of overcoming a problem or error during processing. Typically, a specialized software recovery routine gains control and attempts to resolve the error without crashing the system.

remote access	Access to a central computer by terminals or devices geographically separated from that computer.
replace	Process of exchanging one portion of text for another. This process encompasses two functions: deleting old text and inserting new.
report	In setting a separation boundary through the Bin Full Criteria task, report refers to a subset of a job (a job may consist of one or more reports).
resolution	Number of dots per unit. The LPS imaging system converts a character from digitized data into a printed image composed of these tiny dots. The greater the number of dots per inch, that is, the resolution, the clearer the image that is produced.
ROM	read-only memory. Solid-state memory for programs. It cannot be rewritten.
save	To store programs, data, or text for retrieval at a later time.
scale	To adjust font or image size according to given proportions.
scroll	Manipulation of a display to bring upper or lower portions of a document page into view when no space is available for the entire document at once.
scroll bar	Part of a window that allows you to view information extending beyond the window display.
SCSI	small computer system interface. Accepted standard for connecting peripheral devices to computers.
secondary storage	Form of storage external to a system, such as magnetic tapes or floppy disks.
security	1. Procedure for limiting access to the system resources, programs, or files, to authorized personnel. 2. Protecting programs and files from unintentional or undesired modification.
SEF	short-edge feed. The movement of paper through the printer in the direction of the paper width (the shorter side of a sheet of paper). For the DocuPrint 96 LPS, short-edge feed allows larger sizes of paper (up to 11 by 17 inches/279 by 432 mm) to be printed.
sequential	In numeric sequence, usually in ascending order. As applied to a file organization, describes files in which records are written one after another and cannot be randomly accessed. For example, the first 99 records in a sequential file-access file have to be read before the 100th record is accessible.

set	In setting a separation boundary through the Bin Full Criteria task, set refers to multiple copies of the same report.
simplex printing	Printing on one side of the page. See <i>also</i> duplex printing.
software	Programs, including operating systems, procedures, utilities, and applications programs, written for a system. Software can be supplied by the hardware manufacturer or other firms but does not include programs written by the user.
sort	To rearrange data records according to a particular item (field) which they all contain, using a predetermined ordering scheme.
source	Terminal node at which data enters a network. For example, a computer transmitting data through telecommunication lines to several other computers or receiving terminals.
source file	File containing source language statements or commands.
source language	Language, high-level or low-level, used by a programmer. A source language must be converted by a compiler to machine language for the instructions to be executed.
source program	Program written in source language
space	Blank area between words, recognized as a character by word and data processing systems.
special processing	Commands allowing the user to process special reports, such as printing certain records, or printing on special paper.
spooling	Process of releasing data from main memory and storing it temporarily until a peripheral device is ready to accept it, for example storing text before sending it to a printer.
spot	Unit of measurement representing a fraction of an inch, for example, 300 spots per inch (spi). May also be referred to as a picture element (pixel) or dot.
statement	Detailed written instructions in a program step. A statement is written according to specific rules called syntax.
static data	Information usually found on preprinted forms or overlays.
stock	User-defined name in the JSL that specifies a certain type of paper for printing a job. See <i>also</i> cluster.
stockset	Collection of stocks to be used on a print job. See <i>also</i> stock; cluster.

storage	Retention of information. Primary storage refers to internal storage where data and program instructions pertinent to current operations/jobs are held. Auxiliary storage refers to external media, such as disks or tapes, for use at a later time.
string	Connected sequence of alphanumeric characters treated as one unit of data by a program.
symbol	Character used in a computer language to specify a particular function.
synchronous	Efficient encoding of data suitable for high-speed, block-oriented data transmission by using equal time elements.
syntax	Rules governing the structure of expressions in a programming language.
syntax error	System response to a mistake in a command entry.
system	1. In data processing, a collection of parts and procedures organized to accomplish a set of specific functions. 2. Assembly of components united by some form of regulated interaction to form an organized whole. 3. Operations or procedures through which a business activity is accomplished.
system controller	Part of the LPS that provides interfacing capability, data handling, formatting, buffering, and operator control for the system. Also referred to as the "ESS".
system disk	Magnetic disk storage medium, usually of large capacity, that is not removable as opposed to floppy disk or disk packs.
system file	Master software program that keeps all components working together.
system generation	Process whereby the system is made ready to operate. Typically involves selecting the operative parameters and activating the relevant software.
system page	Maximum area in which text and graphics can be imaged on a printing system.
system software	Software programs that support and/or control system functions by governing hardware operation and input/output processes, interpreting source programs and breaking them down into machine language, distributing tasks among various processors, and so on.
tab	To move the cursor on a display or printer to a prespecified column on the display or paper, most often by using the <TAB> key on a keyboard.

tape	Recording media for data or computer programs. Tape can be in permanent form, such as perforated paper tape. Generally, tape is used as a mass storage medium in magnetic form and has a far higher storage capacity than disk storage, but it takes longer to write or recover data from tape than from disk.
tape density	The number of characters that can be stored on magnetic media, such as how close together data can be recorded. The Xerox LPS may use either 1600 bpi or 6250 bpi density magnetic media.
tape drive	Input/output device that controls the movement of magnetic storage tape past the read/write head while data is accessed or stored.
task	1. Any major job performed by a computer. 2. One of several programs being executed by a system.
telecommunications	Voice or data communications transmitted and received through telephone lines.
teleprocessing	Sending and receiving data through telecommunication lines for processing among various remote terminals and the central processing unit (CPU).
terminal	Device equipped with a keyboard and connected to a computer or a network
testing	1. Process of running a program for the express purpose of discovering any errors it may contain. 2. For computer-oriented systems, the process of verifying a system's ability to meet performance objectives in a simulated environment or validating its actual performance in a live environment.
text	In communications, the content portion of a transmitted message.
text string	Consecutive series of characters to be printed exactly as specified in a command.
throughput	In data processing systems, the amount of data that can be processed, transmitted, printed, and so on, per a specified unit of time.
toggle	To switch (alternate) from one tray to another. The system switches from an active feeder or stacker tray to an inactive one to allow continuous printing when the proper commands are invoked.
trailer	In data communications, the last portion of a message that signals the end.
transaction processing	Method of data processing in which files are updated and results are generated immediately after data entry.

translation	1. In data communications, the conversion of one code to another on a character-by-character basis. 2. In programming, the function of a language processor which converts a source program from one programming language to another.
transmission speed	In data communications, the rate at which data is passed through communication lines, usually measured in bits per inch (bpi).
transmit	To send data from one place to another.
truncated	Cut off before completion, as when data transfer from a host to a printer is cut off before all data has been transmitted.
two-up	Application that prints two logical pages on one side of a physical page.
typeface	1. All type of a single design. 2. Set of characters with design features that make them similar to one another.
type size	Height of a typeface, measured from the bottom of its descenders to the top of its ascenders, expressed in points.
type style	Italic, condensed, bold, and other variations of typeface that form a type family.
UCS	Universal Character Set. Printer feature that permits the use of a variety of character
upload	To copy files from a remote peripheral device to a host. LPS files are not copied to the host because one of the LPS functions is to store files for the host.
utility program	General-purpose program that performs activities, such as initializing a disk or sorting, which are not specific to any application.
validation	Process of testing a system's ability to meet performance objectives by measuring and monitoring its performance in a live environment.
variable	Information of a changeable nature which is merged with a standard or a repetitive document to create specialized or personalized versions of that document.
variable data	Variable data is not a part of a form design. It varies from page to page.
variable text	Text of changing nature, such as various names and addresses combined with a form letter to make a complete document.
virtual page	Page area selected by a forms designer for printing.

warning message	System-issued message indicating that an error has been encountered even though the program has not failed.
weight	Characteristic of type determined by how light or dark it appears.
wildcard	Part of a command (* symbol, / symbol, ? symbol) that represents a category for which the possible options are requested.
wildcarding	In a command, calling out a general category rather than a specific item within that category. The purpose of wildcarding is to generate the options within the given category.
write	To record data in memory or an external storage medium.
write protection	Data protection feature implemented on magnetic media (for example floppy disk, 9-track tape) to prevent stored data from being modified, written over, or erased.
x axis	Horizontal axis on a forms grid.
xdot	Unit of measurement representing a fraction of an inch. It may also be referred to as a picture element (pixel) or spot, for example, 1/600 spots per inch (spi).
xerographic engine	Component of a printer that develops an image, transfers it to paper, and fuses it for output as hardcopy.
x height	Height of lowercase letters without their ascenders or descenders (height of letter "x"). <i>See also</i> ascender; descender.
y axis	Vertical axis on a forms grid
ACT	Advanced Customer Training
AFP	Advanced Function Printing
ANSI	American National Standards Institute
ASCII	American Standard Code for Information Interchange
BCD	binary coded decimal
BOF	bottom of form
BOT	beginning of tape
bpi	bits per inch

bps	bits per second
BSC	binary synchronous communications
CD	character dispatcher
CDC	control data communications
CD/IG	character dispatcher/image generator
CM	control module
CME	copy modification entry
cpi	characters per inch
CPU	central processing unit
CR	carriage return
DCE	data communications equipment
DDCMP	Digital Data Communication Message Protocol
DEC	Digital Equipment Corporation
DFA	Document Feeding and Finishing Architecture
DJDE	dynamic job descriptor entry
DOS	disk operating system
dpi	dots per inch
DSDD	double sided double density
DSU	digital signal unit
DSR	disk save and restore
DSSD	double sided single density
DTE	data terminal equipment
EBCDIC	Extended Binary Coded Decimal Interchange Code

ENET	Ethernet network
EOT	end of tape
EP	electronic publishing
ESS	electronic subsystem, also referred to as the system controller
FCB	forms control buffer
FCG	finishing configuration utility
FCP	file control parameter
FDL	forms description language
FDR	file directory
FFM	font file management
FIS	Font Interchange Standard
FMS	file management subsystem
FPS	formatting print service
FSL	forms source library
FST	font specification table
GCR	group code recording
gsm	grams per square meter
HCF	high-capacity feeder
HCS	high-capacity stacker
HFDL	host forms description language
HIP	Host Interface Processor
hpos	horizontal positioning
IBM	International Business Machines Corporation

IFU	Interpress font utility
IG	image generator
IGM	image generator module
I/O	input/output
IOM	image output module
IOT	input output terminal, also referred to as "printer"
IPD	Interpress decomposer
IPFONTS	Interpress fonts
IPL	initial program load
IPM	Interpress mapping
ips	inches per second
JCB	job control block
JCL	job control language
JDE	job descriptor entry
JDL	job descriptor library
JID	job identifier
JSL	job source library
LAN	local area network
laser	light amplification by stimulated emission of radiation
LED	light-emitting diode
LEF	long-edge feed
LF	long-edge feed
lpi	lines per inch

LPS	Laser Printing System
MTU	magnetic tape unit (refers to the 9-track magnetic tape drive; also referred to as "magnetic tape drive")
OCR	optical character recognition
OCS	operator communications subsystem
OLI	online interface
OS	operating system
OSDS	operating system diagnostic software
OSEXEC	operating system executive
OSS	operating system software
PC	personal computer
PCC	printer carriage control
PDL	print description language
PE	phase encoded
ppm	pages per minute
PQA	print quality adjustment
PROM	programmable read-only memory
PSC	printer subsystem controller
pt	point
PWBA	printed wiring board assembly
QIC	1/4 inch cartridge
RAM	random access memory
ROS	raster output scanner

SAFES	stand-alone field engineering software
SAN	software analysis number
sci	START command index
SCSI	small computer system interface
SDLC	synchronous data link control
SEF	short-edge feed
SFS	status file services
SIF	sequence insert file
SNA	system network architecture
spi	spots per inch
SST	system software tape
sysgen	system generation
TL/DL	text line/display list
TOF	top of form
tpi	tracks per inch
TPJ	test pattern job
TXC	total xerographic convergence
UCS	Universal Character Set
UCSB	Universal Character Set Buffer
UI	user interface
VM	virtual memory
vpos	vertical positioning
VS	virtual storage

WAN	wide area network
XCSC	Xerox Customer Support Center
XDGI	Xerox DCF and GDDM Interface
XDSS	Xerox Documentation and Software Services
XICS	Xerox Integrated Composition System
XJCF	Xerox Job Control Facility
XMP	xerographic mode persistence
XMS	xerographic mode switching
XNS	Xerox Network Systems
XPAF, XPF	Xerox Printer Access Facility
XPMF-VMS	Xerox Print Management Facility - VMS Version
XPPI	Xerox Pen Plotter Interface
XPS	Xerox Publishing System

Numerics

1401 emulation control codes, 2-9
1403 emulation control codes, 2-10
1HDR label
 Honeywell 200/2000
 COBOL, 10-3
 SPR, 10-6
4 x 3 packed BCD, 10-1 to 10-2
 Honeywell 600/6000, 10-17 to 10-19
 Honeywell 6000, 10-12 to 10-13
4 x 3 packing mode
 Fielddata characters, 11-1
9 x 8 packed ASCII, 10-19 to 10-20
9-track tapes, 7-1

A

American National Standards Institute, *see* ANSI
ANSI

 Burroughs systems
 medium, 8-2 to 8-3

 CP-V, 7-1

 DEC PDP-11, 15-3

 labels

 EOF1, 1-8 to 1-9

 EOF2, 1-10

 EOF3-9, 1-11

 EOV1, 1-8 to 1-9

 EOV2, 1-10

 HDR1, 1-8 to 1-9

 HDR2, 1-10

 types, 1-1 to 1-2

 UHL, 1-11

 UTL, 1-11

 UVL, 1-11

 VOL1, 1-7

 tape marks

 doubles, 1-1

 placement, 1-1

 tapes

 JSL sample, 1-13 to 1-15

 Univac, 11-3

see also Xerox ANSI

ASCII character set, Univac, 11-1 to 11-3

B

banner page format, OS Writer, 12-1

bannered data format, 10-8

BCD, 10-1 to 10-2

see also 4 x 3 packed BCD

Beginning-of-file label, 1-1 to 1-2

Beginning-of-volume label, 1-1 to 1-2

block

 characteristics, POWER II, 4-1 to 4-2

 identification, VS and VSE, 5-2

 sequence indicator, 1-11

Burroughs systems

 large

 JSL sample, 9-4 to 9-5

 line-up records, 9-2

 record format, 9-1 to 9-2

 medium

 ANSI types, 8-2 to 8-3

 carriage control conventions, 8-3 to 8-4

 formats, 8-1

 JSL sample, 8-5 to 8-6

 record structure, 8-1

 tape configurations, 8-3

C

carriage control conventions

 ANSI, 1-12

 Burroughs systems

 large, 9-3

 medium, 8-3 to 8-4

 DEC PDP-11, 15-3

 GRASP, 3-3

 Honeywell 200/2000, 10-10 to 10-12

 Honeywell 600/6000, 10-21 to 10-22

 IBM, 2-9 to 2-10

 ICL 2900 VME/B, 16-2 to 16-3

 NCR, 13-1 to 13-3

 US70, 6-10, 6-13

 Xerox ANSI, 7-3 to 7-5

carriage control tape, 6-13

channel control word, 3-2

channel skip, control character, 10-20

Class 1 laser products, iii

Class A Writer, 12-1

Class B Writer, 12-1

COBOL

 Honeywell tapes, 10-1

 labels, Honeywell 200/2000, 10-4 to 10-5

 print tapes, formats, 6-10 to 6-11

control characters

embedded, 10-17 to 10-19
ignore, 10-19
paired, 10-18 to 10-19, 10-20
single, 10-18
control codes, DEC PDP-11, 15-4 to 15-5
Control Program-Five, see CP-V
control records, Univac, 11-4 to 11-9
CP-V ANSI labels, 7-1

D

data formats
DEC PDP-11, 15-3 to 15-6
Honeywell 200/2000, 10-8 to 10-9
Honeywell 600/6000, 10-16 to 10-20
ICL 2900 VME/B, 16-1 to 16-2
SPR, 10-10
unlabeled tapes, 14-2
US70, 6-9 to 6-10
data records
GRASP tapes, 3-2
Univac, 11-10
DEC PDP-11
ANSI, 15-3
carriage control conventions, 15-3
control codes, 15-4 to 15-5
data formats, 15-3 to 15-6
file formats, 15-1 to 15-2
guidelines, 15-5 to 15-6
tape formats, 15-1
disk buffer size, GRASP, 3-2
documentation, related, v to vi
DOS/360
GRASP tape organization, 3-1 to 3-6
JSL sample, 2-11 to 2-13
labeled tapes, 2-1

E

EBCDIC character set, Burroughs, 9-4
embedded control characters, 10-17 to 10-19
End-of-file label, 1-1 to 1-2
End-of-volume label, 1-1 to 1-2
EOF1
ANSI, 1-8 to 1-9
OS/360, 2-6 to 2-7
EOF2
ANSI, 1-10
OS/360, 2-7 to 2-8
EOF3-9 tape label, 1-11
EOT reflector, 3-2, 11-3
EOV1
ANSI, 1-8 to 1-9
OS/360, 2-6 to 2-7
EOV2
ANSI, 1-10
OS/360, 2-7 to 2-8

escape-"other character, control characters, 10-19
escape-channel skip, control characters, 10-19
escape-escape, control characters, 10-18
escape-line feed, control characters, 10-18
escape-skip, control characters, 10-18

F

FEs, see format effectors, ICL 2900 VME/B,
embedded
Fieldata
characters, 11-1
translation table, 11-3
file formats, DEC PDP-11, 15-1 to 15-2
file header label, US70, 6-2 to 6-4
FLX
format, Xerox operating system, 15-4
label, 15-1 to 15-2
FONTINDEX option, 11-11
format effectors, ICL 2900 VME/B
embedded, 16-4
normal, 16-3
formats
Burroughs systems
large, 9-1 to 9-2
medium, 8-1
COBOL print tapes, 6-10 to 6-11
files, 14-1 to 14-2
Honeywell 200/2000, 10-3 to 10-7
function codes, NCR, 13-2 to 13-3

G

graphics code, NCR, 13-3
GRASP
disk buffer size, 3-2
interspersed block tapes, 3-4
JSL sample, 3-5 to 3-6, 4-4 to 4-5
record format, 3-1
sample data block, 3-3

H

HDR1
ANSI, 1-8 to 1-9
OS/360, 2-6 to 2-7
US70, 6-2
HDR2
ANSI, 1-10
OS/360, 2-7 to 2-8
header label group
ANSI, 1-1
US70, 6-1
heading string "H", 11-8
Honeywell 200/2000
carriage control conventions, 10-10 to 10-12
data formats, 10-8 to 10-9

JSL sample, 10-23 to 10-26
 label 1hdr, 10-3
 record formats
 fixed, 10-9
 variable, 10-8 to 10-9
 tape formats, 10-3 to 10-7
 Honeywell 600/6000
 4 x 3 packed BCD, 10-17 to 10-19
 9 x 8 packed ASCII, 10-19 to 10-20
 carriage control codes, 10-21 to 10-22
 data formats, 10-16 to 10-20
 JSL sample, 10-23 to 10-26
 labels, 10-14 to 10-16
 record formats, 10-16 to 10-17
 tape formats, 10-12 to 10-16
 Honeywell tapes
 COBOL, 10-1
 SPR, 10-1

I

IBM
 1401 emulation control codes, 2-9
 1403 emulation control codes, 2-10
 carriage control, 1-12
 carriage control conventions, 2-9 to 2-10
 see also OS/360; DOS/360; and POWER II
 IBM OS Writer, *see* OS Writer
 IBM POWER/VS, *see* POWER/VS
 IBM POWER/VSE, *see* POWER/VSE
 ICL 2900 VME/B
 carriage control conventions, 16-2 to 16-3
 data formats, 16-1 to 16-2
 format effectors
 embedded, 16-4
 normal, 16-3
 JSL sample, 16-5
 tape formats, 16-1
 identification format, GRASP, 3-2
 ignore, control character, 10-18, 10-19
 interspersed block tapes, GRASP, 3-4
 IOCW (Input/Output Control Word), 9-1

J

JDL specifications, 12-2
 Job Descriptor Library, *see* JDL
 JSL sample
 ANSI, 1-13 to 1-15
 Burroughs systems
 large, 9-4 to 9-5
 medium, 8-5 to 8-6
 GRASP, 3-5 to 3-6, 4-4 to 4-5
 Honeywell 2000/6000, 10-23 to 10-26
 IBM, 2-11 to 2-13
 ICL 2900 VME/B, 16-5
 NCR, 13-4

OS Writer, 12-5 to 12-7
 PDP-11, 15-7 to 15-8
 POWER, 3-5 to 3-6, 5-5 to 5-6
 POWER II, 4-4 to 4-5
 undefined tapes, 14-3 to 14-4
 UNIVAC, 6-14 to 6-15, 11-12
 Xerox ANSI, 7-6 to 7-7
 JSL, Univac guidelines, 11-11

L

label control block, 11-4 to 11-7
 labels
 ANSI, 1-1 to 1-11
 ANSI tape
 EOF1, 1-8 to 1-9
 EOF2, 1-10
 EOF3-9, 1-11
 EOV1, 1-8 to 1-9
 EOV2, 1-10
 HDR1, 1-8 to 1-9
 HDR2, 1-10
 UTL, 1-11
 UVL, 1-11
 VOL1, 1-7
 Burroughs systems
 large, 9-1 to 9-4
 medium, 8-2 to 8-3
 CP-V, 7-1
 FLX, 15-1 to 15-2
 Honeywell 600/6000, 10-14 to 10-16
 IBM, 2-1 to 2-9
 NCR, 13-1
 SDF formats, 11-4 to 11-7
 undefined, 14-1
 US70, 6-1 to 6-10
 Xerox ANSI, 7-1 to 7-2
 laser safety, iii
 line feed, control character, 10-20
 line spacing, US70, 6-12 to 6-13
 line string "L", Univac, 11-9
 line-up records, 3-2
 line-up records, Burroughs systems, large, 9-2

M

margin string "M", 11-9
 merge processing, 11-10

N

NCR
 carriage control conventions, 13-1 to 13-3
 function codes, 13-2 to 13-3
 JSL sample, 13-4
 labels, 13-1
 printer control block codes, 13-2 to 13-3

null

- files, 1-1
- US70, 6-8

null characters, 15-3

O

operating system labels, 1-1 to 1-2

operation safety, iv

OS Writer

- banner page format, 12-1
- creating
 - report sample, 12-2 to 12-4
 - tapes, 12-4
- JSL sample, 12-5 to 12-7
- PDL commands, 12-2
- tape formats, 12-1
- VOLUME command, 12-2

OS/360

- JSL tape sample, 2-11 to 2-13
- labeled tapes, 2-1
- labels
 - EOF1, 2-6 to 2-7
 - EOF2, 2-7 to 2-8
 - EOV1, 2-6 to 2-7
 - EOV2, 2-7 to 2-8
 - HDR1, 2-6 to 2-7
 - HDR2, 2-7 to 2-8
 - UHL, 2-9
 - VOL1, 2-5
 - VOL2, 2-5

overprint processing, 11-10

P

page numbering, Univac, 11-8

PDL commands, OS Writer, 12-2

PDP-11

- JSL sample, 15-7 to 15-8

POWER

- JSL sample, 3-5 to 3-6, 5-5 to 5-6

POWER II

- block characteristics, 4-1 to 4-2
- JSL sample, 4-4 to 4-5
- tape format, 4-1
- tape formats, 4-3

POWER/VS

- data formats, 5-2
- file formats, 5-1
- special block, 5-4
- tape formats, 5-1

POWER/VSE

- data formats, 5-2
- file formats, 5-1
- tape formats, 5-1

print image control record, 11-8 to 11-9

printer carriage control conventions, *see* carriage control conventions

printer carriage control tape, 6-13

printer control block codes, NCR, 13-2 to 13-3

printer control conventions

- US70, ?? to 6-13

printer control conventions, US70, 6-11 to ??

publications, other, v to vi

R

RCA Spectra 70 Magnetic Tapes, *see* US70

record format

- Burroughs systems
 - large, 9-1 to 9-2
 - medium, 8-1

record formats

- fixed
 - Honeywell 200/2000, 10-9
 - POWER VS, 5-4
 - US70, 6-9
- variable
 - Honeywell 200/2000, 10-8 to 10-9
 - Honeywell 600/6000, 10-16 to 10-17

record formats, GRASP, 3-1

reflective strip, 1-2

report tape format, OS Writer, 12-1

Report Writer feature, 6-10

S

safety

- laser, iii
- operating, iv

SDF

- control record formats, 11-7
- formats, 11-4 to 11-7
- heading string, 11-8
- label control block, 11-7

selective print character, NCR, 13-3

setup string "S", 11-9

size, physical record, 3-2

skip, control character, 10-20

space code, NCR, 13-3

spacing, Univac, 11-10

SPR

- 1HDR labels
 - Honeywell 200/2000, 10-6
- data format, 10-10
- Honeywell tapes, 10-1
- labels, Honeywell 200/2000, 10-4 to 10-5

System Print Type, *see* SPR

T

tab, control character, 10-20

tape configurations

Burroughs systems, medium, 8-3
 DOS/360, 2-1
 IBM OS/360, 2-1
 US70, 6-6 to 6-7

tape marks
 doubles, 14-2
 US70, 6-8

tapes
 alternate devices, 6-9
 ANSI labeled, 1-1 to 1-15
 formats
 DEC PDP-11, 15-1
 Honeywell 600/6000, 10-12 to 10-16
 ICL 2900, 16-1
 GRASP record format, 3-1
 report format< OS Writer>, 12-1
 structure
 ANSI labels, 2-3
 IBM OS/360, 2-3
 POWER II, 4-1, 4-3
 undefined, 14-1 to 14-2
 undefined, JSL sample, 14-3 to 14-4
 unlabeled
 US70, 6-7

trailer banner pages, 12-1
 trailer label group, 1-1

U

UHL
 ANSI, 1-11
 OS/360, 2-9
 US70, 6-4

UNIVAC
 JSL sample, 6-14 to 6-15

Univac
 control records, 11-4 to 11-9
 data records, 11-10
 JSL sample, 11-12
 line string "L", 11-9
 margin string "M", 11-9
 page numbering, 11-8
 SDF
 control record format, 11-7
 label control block, 11-7
 setup string "S", 11-9
 SDF tape format, *see also* SDF

UNIVAC Series 70, *see* US70

US70
 data formats, 6-9 to 6-10
 file header label, 6-2 to 6-4
 header label group, 6-1
 line spacing, 6-12 to 6-13
 null file, 6-8
 printer control conventions, 6-11 to 6-13
 standard labels, 6-1
 tape configurations, 6-6 to 6-7

tape marks, 6-8
 unlabeled tapes, 6-7
 user header label, 6-4
 user trailer label, 6-6
 UTL, 6-6
 volume labels, 6-2
 user header label, US70, 6-4
 user labels, 1-1 to 1-2
 user trailer label, US70, 6-6
 UTL
 tape label, 1-11
 US70, 6-6
 UVL tape label, 1-11

V

VOL1
 ANSI labeled tape, 1-7
 OS/360, 2-5

VOL2
 OS/360, 2-5

VOLUME command
 OS Writer, 12-2
 undefined tapes, 14-1
 volume labels, US70, 6-2

X

Xerox 9-track tapes, 7-1
 Xerox ANSI
 carriage control conventions, 7-3 to 7-5
 JSL sample, 7-6 to 7-7
 Xerox/OSS, FLX format, 15-4

