



print | copy | scan | fax | email

User Guide



© 2008 by Fuji Xerox Co., Ltd. All rights reserved.

Copyright protection claimed includes all forms and matters of copyrighted material and information now allowed by statutory or judicial law or hereinafter granted, including without limitations, material generated from the software programs which are displayed on the screen, such as icons, screen displays, looks etc.

Xerox[®] and all Xerox products mentioned in this publication are trademarks of Xerox Corporation. Product names and trademarks of other companies are hereby acknowledged.

The information in this document is correct at the time of publication. Xerox reserves the right at any time to change the information without notice. Changes and technical updates will be added in subsequent editions of the documentation. For the latest information go to www.xerox.com.

Products Subject To Ordinary Export Regulations

An export of this product is strictly limited in accordance with Laws concerning Foreign Exchange and Foreign Trade of Japan and/or the export control regulations of the United States. You must obtain, if you wish to export this product, any appropriate export license from the Japanese Government or its agency and/or re-export approval from the U.S. Government or its agency.

Products Subject To Supplementary Export Regulations

An export of this product is strictly limited in accordance with Laws concerning Foreign Exchange and Foreign Trade of Japan and/or the export control regulations of the United States. You must obtain, if you know the product is to be used, or was used for development, manufacturing or use of any mass destructive weapons including nuclear weapon, chemical weapon or biological weapon because of a dealing document such as legal contract or information from the importer, any appropriate export license from the Japanese Government or its agency and/or re-export approval from the U.S. Government or its agency.

Table of Contents

1	Before Using the Machine	9
	Xerox Welcome Center	9
	Serial Number	9
	Language Displayed on the Touch Screen	10
	Conventions	10
	Related Information Sources	12
	Cautions and Limitations	12
	Safety Notes	12
	Electrical Safety Information	14
	Machine Installation Safety Information	14
	Operational Safety Information	15
	Battery Safety Information	15
	Laser Safety Information	16
	Ozone Information	16
	For Consumables	16
	Radio Frequency Emissions (Class A digital device)	17
	Product Safety Certification (UL, CB)	17
	Regulatory Information	17
	Certifications in Europe (CE)	17
	For FAX Function	18
	Regulatory Information for RFID	20
	Environmental Compliance	20
	USA	20
	About License	21
	RSA BSAFE	21
	Heimdal	21
	JPEG Code	21
	Libcurl	22
	FreeBSD	22
	OpenLDAP	23
	DES	25
	AES	25
	TIFF (libtiff)	25
	XPS	25
	Illegal Copies	26
	USA	26
	Canada	27
	Other Countries	27
	Product Recycling and Disposal	28
	Battery Recycling and Disposal	28

All Countries, North America - USA/Canada	28
European Union.....	28
Other Countries	29
2 Product Overview.....	31
Machine Components	32
Control Panel	36
Machine Services.....	37
Power On/Off	39
Powering On.....	39
Powering Off.....	39
Ground Fault Interrupter (GFI)	40
Energy Saver Modes.....	40
Modes	41
All Services.....	41
Features	41
Job Status.....	42
Machine Status.....	42
Job Interrupt.....	42
Attaching the Tray Attachment to the Office Finisher LX (Optional)	42
Recycled Paper.....	43
3 Copy	45
Copying Procedure	45
1. Load the Documents	45
2. Select the Features	47
3. Enter the Quantity.....	48
4. Start the Copy Job.....	48
5. Check the Status of the Copy Job	48
Stopping a Copy Job	49
Copy.....	49
Reduce/Enlarge.....	49
Paper Supply	51
2 Sided Copying	52
Copy Output	53
Image Quality	55
Original Type	56
Image Options	56
Background Suppression	57
Layout Adjustment	57
Book Copying	57
2 Sided Book Copying	58
Original Size	59
Edge Erase.....	59
Image Shift	60
Image Rotation	60

Invert Image.....	61
Original Orientation.....	61
Output Format.....	62
Booklet Creation.....	62
Covers.....	65
Transparency Options.....	65
Page Layout.....	66
Poster.....	67
Annotations.....	68
Watermark.....	70
ID Card Copying.....	71
Job Assembly.....	72
Build Job.....	72
Sample Job.....	74
Combine Original Sets.....	74
Form Overlay.....	75
Delete Outside/Delete Inside.....	75
4 Fax.....	77
Country Code for the Fax Service.....	77
Fax Procedure.....	78
1. Load the Documents.....	78
2. Select the Features.....	79
3. Specify a Destination.....	80
4. Enter an E-mail Subject and Message (for Internet Fax Only).....	81
5. Start the Fax Job.....	81
6. Check the Status of the Fax Job.....	82
Stopping a Fax Job.....	82
Specifying Fax Destinations.....	83
New Recipients.....	83
Address Book.....	86
Cover Page.....	87
Specifying Internet Fax Destinations.....	89
New Recipients.....	89
Address Book.....	90
From.....	91
Subject.....	91
Message.....	91
Specifying Server Fax Destinations.....	92
New Recipients.....	92
Address Book.....	93
General Settings - Fax/Internet Fax/Server Fax.....	94
Lighten/Darken.....	95
2 Sided Scanning.....	95
Original Type.....	95
Resolution.....	96

Layout Adjustment - Fax/Internet Fax/Server Fax	97
Original Size	97
Book Faxing.....	98
Reduce/Enlarge.....	98
Fax Options - Fax.....	99
Confirmation Options.....	100
Starting Rate.....	100
Priority Send/Delay Start	100
Transmission Header Text	102
Recipient Print Sets	102
Multiple-Up	103
Remote Mailbox.....	103
F Code.....	104
More Fax Options - Fax	105
Remote Polling	105
Store for Polling.....	106
On-hook (Manual Send/Receive)	108
Internet Fax Options - Internet Fax	108
Acknowledgement Report	109
Internet Fax Profile	109
Multiple-Up	110
Encryption.....	111
Digital Signature	111
Starting Rate.....	111
Transmission Header Text	112
Fax Options - Server Fax	112
Delay Start.....	113
5 Scan/E-mail.....	115
Scanning Procedure.....	115
1. Load the Documents	116
2. Select the Features	116
3. Start the Scan Job.....	117
4. Check the Status of the Scan Job	118
5. Save the Scanned Data.....	118
Stopping a Scan Job	119
E-mail	120
New Recipients.....	120
Address Book.....	121
Add Me	122
From	122
Subject.....	123
Message	123
Scan to Mailbox.....	124
Network Scanning.....	124
Scan to PC	125

Transfer Protocol	126
Address Book	127
Browse.....	127
General Settings.....	128
Color Scanning (WorkCentre 5225A/5230A).....	128
Lighten/Darken (WorkCentre 5222/5225/5230).....	129
2 Sided Scanning.....	129
Original Type	129
Scan Presets	130
Advanced Settings	131
Photographs (WorkCentre 5225A/5230A).....	131
Image Options	132
Background Suppression (WorkCentre 5222/5225/5230).....	132
Image Enhancement (WorkCentre 5225A/5230A)	132
Shadow Suppression (WorkCentre 5225A/5230A)	133
Color Space (WorkCentre 5225A/5230A).....	133
Layout Adjustment.....	134
Resolution.....	134
Book Scanning.....	135
Original Size	136
Edge Erase.....	136
Reduce/Enlarge	137
Original Orientation.....	137
E-mail Options/Filing Options.....	139
Quality / File Size (WorkCentre 5225A/5230A)	139
File Format.....	140
Read Receipts	142
Split Send	142
Document Name/File Name	143
File Name Conflict	143
Reply To	144
Encryption.....	144
Digital Signature	145
Login Name	145
Password	145
Meta Data	146
6 Send from Mailbox	147
Send from Mailbox	147
Printing/Deleting Mailbox Documents.....	148
Job Flow Settings	149
Job Flow Sheet Restrictions	153
7 Job Flow Sheets	155
Using the Job Flow Sheets Service.....	155
Job Flow Sheets.....	156
Sheet Filtering.....	156

Details.....	156
Change Settings.....	157
Search by Name/Search by Keyword/Select Keyword.....	158
8 Stored Programming	159
Recalling a Stored Program	159
9 CentreWare Internet Services	161
Accessing CentreWare Internet Services	161
User Interface.....	162
Services	163
10 Glossary.....	165
Terms Defined.....	165
11 Index.....	175

1 Before Using the Machine

Welcome to the Xerox family of WorkCentre products.

This User Guide provides detailed information and procedures for using the integral features of the machine.

Xerox Welcome Center

If you need assistance during or after product installation, visit the Xerox website for online solutions and support.

<http://www.xerox.com/support>

If you require further assistance, contact our experts at the Xerox Welcome Center. A telephone number for the local representative may have been provided when the product was installed. For convenience and future reference, please record the telephone number in the space below.

Welcome Center or local representative telephone number:

Xerox US Welcome Center: 1-800-821-2797

Xerox Canada Welcome Center: 1-800-93-XEROX (1-800-939-3769)

Serial Number

When you call the Welcome Center you will need to provide the serial number which is located on the left side of the machine behind Cover A, as shown in the diagram.

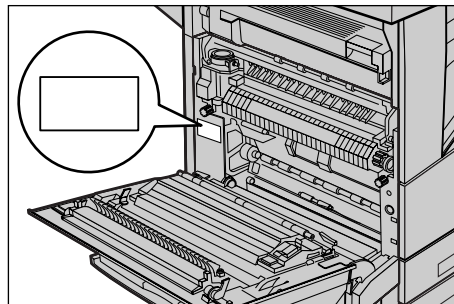

For your convenience, record the serial number in the space below.

Serial Number:

Keep a record of any error messages. This information helps us solve problems faster.

Language Displayed on the Touch Screen

The language displayed on the touch screen can be changed in the following two ways:

- To change the language for temporary use, press the <Language> button on the control panel, then select the required language.

NOTE: The language returns to the default language after rebooting the machine.

- To change the default language, enter the System Administration mode, press the <Machine Status> button, and then select [Tools] > [System Settings] > [Common Service Settings] > [Screen/Button Settings] > [Default Language]. On the [Default Language] screen, select the required language as the default language. For more information, refer to the System Administration Guide.

Conventions

This section describes the conventions used throughout this User Guide. In this guide, you will find that some terms are used interchangeably:

- Paper is synonymous with media.
- Document is synonymous with original.
- Xerox WorkCentre 5222/5225/5225A/5230/5230A is synonymous with the machine.

Orientation

Orientation is used to mean the direction of images on the page. When the image is upright, the paper (or other media) can be either long edge feed or short edge feed.

Long Edge Feed (LEF)

When loading documents long edge feed into the document feeder, load with one of the long edges facing into the document feeder, with the short edges facing the front and back of the document feeder. When loading paper long edge feed into a paper tray, place the paper with one of the long edges toward the left-hand side and one of the short edges toward the front of the tray.

Short Edge Feed (SEF)

When loading documents short edge feed into the document feeder, load with one of the short edges facing into the document feeder, with the long edges facing the front and back of the document feeder. When loading paper short edge feed into a paper tray, place the paper with one of the short edges toward the left-hand side and one of the long edges toward the front of the tray.

LEF Orientation

SEF Orientation

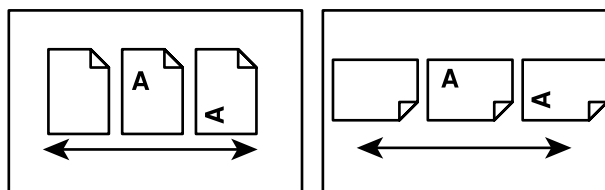

Paper feed direction

Paper feed direction

Text in [Square Brackets]

Indicates the names of the screens, tabs, buttons, features, and option categories. Square brackets are also used when referring to file and folder names on a PC.

For example:

- Select [Original Type] on the [Image Quality] screen.
- Select [Save].

Text in <Angle Brackets>

Indicates the names of the hard buttons, numeric or symbol buttons, lights on the control panel, or symbols on the power switch label.

For example:

- Press the <Machine Status> button to display the [Machine Information] screen.
- Press the <C> button on the control panel to clear the suspended job.

Italic Typeface

Italic typeface is used to indicate references to other sections and chapters.

For example:

- For more information, refer to *2 Sided Copying on page 52*.
- *Paper Supply – page 51*

Warnings

Warnings are statements that alert you to the possibility of personal harm.

For example:



WARNING: Do not use aerosol cleaners. Aerosol cleaners can be explosive or flammable when used on electromechanical equipment.

Before cleaning this product, unplug the product from the electrical outlet. Always use materials specifically designated for this product. The use of other materials may result in poor performance and create a hazardous situation.

Always unplug this equipment from the electrical outlet before cleaning.

Notes

Notes are statements that provide additional information.

For example:

NOTE: If the document feeder is not installed, this feature is not available.

Related Information Sources

The following sources of information are available for the machine:

User Guide

This guide is intended for general users and describes how to use the features of the machine, such as copy, scan, and fax.

System Administration Guide

This guide is intended for the System Administrator and provides information such as the supported paper and media, troubleshooting tips, how to configure network and security settings, and how to replace consumables.

Quick Network Setup Guide

This guide is intended for the System Administrator and provides TCP/IP setup procedures.

Quick Use Guide

This guide is intended for general users and the System Administrator, and describes how to use some useful features on the machine and how to replace toner and drum cartridges.

Quick Scan Features Setup Guide

This guide is intended for the System Administrator and describes how to configure scanning services.

NOTE: Please note that the screens shown in these guides apply to a fully configured machine and therefore may not exactly represent the configuration being used.

Cautions and Limitations

This section describes the cautions and limitations to observe when using this machine.

- When moving the machine, hold the middle part of the machine, and not the control panel or document feeder area. Excessive pressure on the document feeder may cause machine malfunction.

Safety Notes

Please read the following instructions carefully before operating the machine and refer to them as needed to ensure the continued safe operation of your machine.

Your Xerox product and supplies have been designed and tested to meet strict safety requirements. These include safety agency evaluation and certification, and compliance with electromagnetic regulations and established environmental standards.

The safety and environment testing and performance of this product have been verified using Xerox materials only.

WARNING: Unauthorized alterations, which may include the addition of new functions or connection of external devices, may impact the product certification. Please contact your Xerox representative for more information.

This product and recommended supplies have been tested and found to comply with strict safety requirements including safety agency approvals and compliance with environmental standards. Follow the following instructions for safety use.

WARNING: Any unauthorized alteration including an addition of new functions or connection to external devices may not be covered by the product warranty. Contact your local Xerox representative for more information.

Warning Markings

All warnings and instructions marked on or supplied with the product should be followed.



WARNING This symbol alerts users to areas of the equipment where there is the possibility of personal injury.



WARNING This symbol alerts users to areas of the equipment where there are heated or hot surfaces, which should not be touched.



CAUTION This symbol alerts users to areas of the equipment which require special attention to avoid the possibility of personal injury or damage to the equipment.



WARNING This symbol indicates a Laser is being used in the equipment and alerts the user to refer to the appropriate safety information.

Electrical Supply

This product shall be operated by the power source as indicated on the product's data plate. Consult your local power company to check if your power source meets the requirements.



WARNING: Connect this product to a protective earth circuit.

This product is supplied with a plug that has a protective earth pin. The plug fits only into an earthed electrical outlet. This is a safety feature. If the plug doesn't fit to the outlet, contact an electrician to replace the outlet to avoid risk of electric shock. Never use an earthed adapter plug to connect the product to the electrical outlet that has no earth connection terminal.

Improper connection of a grounding conductor may cause electric shock.

Operator Accessible Areas

This product is designed to prohibit operator access to hazardous areas. The hazard areas are isolated from operators by covers or protectors which require a tool to remove. To prevent electric shock and injuries, never remove those covers and protectors.

Maintenance

The operator's product maintenance procedures are described in the customer documentation supplied with this product. Do not carry out any other maintenance procedures not described in the documentation.

Cleaning Your Product



WARNING: Do not use aerosol cleaners. Aerosol cleaners can be explosive or flammable when used on electromechanical equipment.

Before cleaning this product, unplug the product from the electrical outlet. Always use materials specifically designated for this product. The use of other materials may result in poor performance and create a hazardous situation. Always unplug this equipment from the electrical outlet before cleaning.

Electrical Safety Information

- Plug the power cord directly into a grounded electrical outlet. Do not use an extension cord. Consult your local Xerox representative to check if an outlet is grounded.
- Connect this product to a branch circuit or an outlet that has larger capacity than the rated ampere and voltage of this product. See the data plate on the rear panel of this product for its rated ampere and voltage.
- Never touch the power cord with wet hands.
- Do not place an object on the power cord.
- Always keep the plug connection free of dust.
- Only use the power cord supplied with the product or the ones designated by Xerox.
- Hold the plug not the cord when unplugging this product.
- Your Xerox machine is equipped with an energy saving device to conserve power when the machine is not in use. The machine may be left on continuously.

Disconnect Device

The power cable is the disconnect device for this equipment. It is attached to the back of the machine as a plug-in device. To remove all electrical power from the equipment, disconnect the power cable from the electrical outlet.

Machine Installation Safety Information

- Do not locate this product where people might step on or trip over the power cord.
- Always locate the machine on a solid support surface (not on plush carpet) that has adequate strength to support the weight of the machine.
- Always locate the machine in an area that has adequate ventilation and room for servicing.
- This equipment should not be placed in a room unless proper ventilation is provided. Please contact your local Authorized dealer for further information.
- Never locate this product in the following places:
 - Near radiators or any other heat sources
 - Near volatile flammable materials such as curtains

- In a hot, humid, dusty or poorly ventilated environment
- In direct sunlight
- Near ovens or humidifiers
- Always lock the wheels of this product after installation.

Operational Safety Information

- To avoid the risk of electric shock and a fire accident, switch off and unplug the product promptly in the following conditions, then contact your local Xerox representative.
 - The product emits smoke or its surface is unusually hot.
 - The product emits unusual noise or odor.
 - The power cord is cracked or worn down.
 - A circuit breaker, fuse or any other safety device is activated.
 - Any liquid is spilled into the product.
 - The product is soaked in water.
 - Any part of the product is damaged.
- Do not insert any object into slots or openings of this product. Do not place any of the followings on the product:
 - Liquid container such as flower vases or coffee cups
 - Metal parts such as staples or clips
 - Heavy objects
- Do not use conductive paper, e.g. carbonic paper or coated paper.
- Do not use aerosol cleaners. Aerosol cleaners can be explosive or flammable when used on electromechanical equipment.
- If you need to pull out a tray to remove paper jam, contact your local Xerox representative.
- Always follow all warning instructions marked on or supplied with this product.
- Keep electrical and mechanical safety interlocks active. Keep the safety interlocks away from magnetic materials.
- Do not attempt to remove a paper jammed deeply inside the product, particularly a paper wrapped around a fuser or a heat roller. Switch off the product promptly and contact your local Xerox representative.
- Never touch the paper output area of the finisher during operation.
- Be careful in removing jammed staples.
- Do not apply excessive force when placing a thick document on the document glass.
- To move this product to another location, contact your local Xerox representative.

Battery Safety Information

CAUTION: RISK OF EXPLOSION IF BATTERY IS REPLACED BY AN INCORRECT TYPE. DISPOSE OF USED BATTERIES ACCORDING TO THE INSTRUCTIONS.

Laser Safety Information



CAUTION: Use of controls, adjustments, or performance of procedures other than those specified in this guide may result in hazardous light exposure.

This equipment complies with international safety standards and is classified as a Class 1 Laser Product.

With specific reference to lasers, the equipment complies with laser product performance standards set by governmental, national, and international agencies as a Class 1 Laser Product. It does not emit hazardous light, as the beam is totally enclosed during all phases of customer operation and maintenance.

Ozone Information

This product produces ozone during normal operation. The ozone produced is heavier than air and is dependent on copy volume. Install the system in a well-ventilated room.

If you need additional information about ozone, please request the Xerox publication Facts About Ozone (part number 610P64653) by calling 1-800-828-6571 in the United States and Canada. In other markets, please contact your local Xerox representative.

For Consumables

- Store all consumables in accordance with the instructions given on the package or container.
- Use a broom or a wet cloth to wipe off spilled toner. Never use a vacuum cleaner for the spills.
- Keep the drum and toner cartridges out of the reach of children. If a child accidentally swallows toner, spit it out, rinse mouth with water, drink water and consult a physician immediately.
- When replacing the drum and toner cartridges, be careful not to spill the toner. In case of any toner spills, avoid contact with clothes, skin, eyes and mouth as well as inhalation.
- If toner spills onto your skin or clothing, wash it off with soap and water.
- If you get toner particles in your eyes, wash it out with plenty of water for at least 15 minutes until irritation is gone. Consult a physician if necessary.
- If you inhale toner particles, move to a fresh air location and rinse your mouth with water.
- If you swallow toner, spit it out, rinse your mouth with water, drink plenty of water and consult a physician immediately.
- Always use materials and supplies specifically designed for this product. Use of unsuitable materials may result in poor performance.

Radio Frequency Emissions (Class A digital device)

European Union

WARNING: In order to allow this equipment to operate in close proximity to Industrial, Scientific and Medical (ISM) equipment, the external radiation from ISM equipment may have to be limited or special mitigation measures taken.

Changes or modifications to this equipment not specifically approved by the Xerox Corporation may void the user's authority to operate this equipment.

WARNING: This is a Class A product. In a domestic environment this product may cause radio interference in which case the user may be required to take adequate measures.

USA

NOTE: This equipment has been tested and found to comply with the limits for a Class A digital device, pursuant to Part 15 of the FCC Rules. These limits are designed to provide reasonable protection against harmful interference when the equipment is operated in a commercial environment. This equipment generates, uses, and can radiate radio frequency energy and, if not installed and used in accordance with the instruction manual, may cause harmful interference to radio communications. Operation of this equipment in a residential area is likely to cause harmful interference in which case the user will be required to correct the interference at his own expense.

Changes or modifications to this equipment not specifically approved by the Xerox Corporation may void the user's authority to operate this equipment.

Product Safety Certification (UL, CB)

This product is certified by the following agency using the safety standards listed.

<u>Agency</u>	<u>Standard</u>
Underwriters Laboratories Inc.	UL60950-1
NEMKO	IEC60950-1:ed. 1

Regulatory Information

Certifications in Europe (CE)

The CE mark applied to this product, symbolizes XEROX's declaration of conformity with the following applicable European Union Directives, as of the dates indicated:

December 12, 2006: Council Directive 2006/95/EC as amended. Approximation of the laws of the member states related to low voltage equipment.

December 15, 2004: Council Directive 2004/108/EC as amended. Approximation of the laws of the member states related to electromagnetic compatibility.

March 9, 1999 Council Directive 99/5/EC, on radio equipment and telecommunications terminal equipment and the mutual recognition of the conformity.

A full declaration of conformity, defining the relevant directives and referenced standards, can be obtained from your XEROX Limited representative.

For FAX Function

USA

FAX Send Header Requirements:

The telephone Consumer Protection Act of 1991 makes it unlawful for any person to use a computer or other electronic device, including a Fax machine, to send any message unless such message clearly contains in a margin at the top or bottom of each transmitted page or on the first page of the transmission, the date and time it is sent and an identification of the business or other entity, or other individual sending the message and the telephone number of the sending machine or such business, other entity or individual. (The telephone number provided may not be a 900 number or any other number for which charges exceed local or long distance transmission charges.)

In order to program this information into your FAX machine, refer to the Fax chapter in this User Guide and the Setups chapter in the System Administration Guide and follow the steps provided.

Data Coupler Information:

This equipment complies with Part 68 of the FCC rules and the requirements adopted by the Administrative Council for Terminal Attachments (ACTA). On the rear of this equipment is a label that contains, among other information, a product identifier in the format US:AAAEQ##TXXXX. If requested, this number must be provided to the Telephone Company.

A plug and jack used to connect this equipment to the premises wiring and telephone network must comply with the applicable FCC Part 68 rules and requirements adopted by the ACTA. A compliant telephone cord and modular plug is provided with this product. It is designed to be connected to a compatible modular jack that is also compliant. See installation instructions for details.

You may safely connect the machine to the following standard modular jack: USOC RJ-11C using the compliant telephone line cord (with modular plugs) provided with the installation kit. See installation instructions for details.

The Ringer Equivalence Number (or REN) is used to determine the number of devices that may be connected to a telephone line. Excessive RENs on a telephone line may result in the devices not ringing in response to an incoming call. In most but not all areas, the sum of RENs should not exceed five (5.0). To be certain of the number of devices that may be connected to a line, as determined by the total RENs, contact the local Telephone Company. For products approved after July 23, 2001, the REN for this product is part of the product identifier that has the format US:AAAEQ##TXXXX. The digits represented by ## are the REN without a decimal point (e.g., 03 is a REN of 0.3). For earlier products, the REN is separately shown on the label.

If this Xerox equipment causes harm to the telephone network, the Telephone Company will notify you in advance that temporary discontinuance of service may be required. But if advance notice isn't practical, the Telephone Company will notify the customer as soon as possible. Also, you will be advised of your right to file a complaint with the FCC if you believe it is necessary.

The Telephone Company may make changes in its facilities, equipment, operations or procedures that could affect the operation of the equipment. If this happens the Telephone Company will provide advance notice in order for you to make necessary modifications to maintain uninterrupted service.

If trouble is experienced with this Xerox equipment, for repair or warranty information, please contact the appropriate service center; details of which are displayed either on the machine or contained within the System Administration Guide. If the equipment is

causing harm to the telephone network, the Telephone Company may request that you disconnect the equipment until the problem is resolved.

Repairs to the machine should be made only by a Xerox representative or an authorized Xerox service agency. This applies at any time during or after the service warranty period. If unauthorized repair is performed, the remainder of the warranty period is null and void. This equipment must not be used on party lines. Connection to party line service is subject to state tariffs. Contact the state public utility commission, public service commission or corporation commission for information.

If your office has specially wired alarm equipment connected to the telephone line, ensure the installation of this Xerox equipment does not disable your alarm equipment. If you have questions about what will disable alarm equipment, consult your Telephone Company or a qualified installer.

CANADA

This product meets the applicable Industry Canada technical specifications.

NOTE: The Ringer Equivalence Number (REN) assigned to each terminal device provides an indication of the maximum number of terminals allowed to be connected to a telephone interface. The termination on an interface may consist of any combination of devices subject only to the requirement that the sum of the Ringer Equivalence Numbers of all of the devices does not exceed 5.

Repairs to certified equipment should be coordinated by a representative designated by the supplier. Any repairs or alterations made by the user to this equipment, or equipment malfunctions, may give the telecommunications company cause to request the user to disconnect the equipment.

Users should ensure for their own protection that the electrical ground connections of the power utility, telephone lines and internal metallic water pipe systems, if present, are connected together. This precaution may be particularly important in rural areas.

CAUTION: Users should not attempt to make such connections themselves, but should contact the appropriate electric inspection authority, or electrician, as appropriate.

EUROPE

Radio Equipment & Telecommunications Terminal Equipment Directive

This Xerox product has been self-certified by Xerox for pan-European single terminal connection to the analogue public switched telephone network (PSTN) in accordance with Directive 1999/5/EC.

The product has been designed to work with the national PSTNs and compatible PBXs of the following countries:

Austria, Belgium, Bulgaria, Cyprus, Czech Republic, Denmark, Estonia, Finland, France, Germany, Greece, Hungary, Ireland, Italy, Latvia, Lithuania, Luxembourg, Malta, Netherlands, Poland, Portugal, Romania, Slovakia, Slovenia, Spain, Sweden, Switzerland, United Kingdom, Iceland, Liechtenstein, Norway

In the event of problems, you should contact your local Xerox representative in the first instance.

This product has been tested to and is compliant with TBR21 OR ES 103 021-1/2/3 or ES 203 021-1/2/3, technical specifications for terminal equipment for use on analogue-switched telephone networks in the European Economic Area.

The product may be configured to be compatible with other country networks.

Please contact your Xerox representative if it needs to be reconnected to another country's network.

NOTE: Although this product can use either loop disconnect (pulse) or DTMF (tone) signaling it is recommended that it is set to use DTMF signaling. DTMF signaling provides reliable and faster call setup. Modification, connection to external control software or to external control apparatus not authorized by Xerox, will invalidate its certification.

Regulatory Information for RFID

Regulatory Information for RFID

This product generates 13.56 MHz using an Inductive Loop System as a Radio Frequency Identification device (RFID). This RFID device complies with the requirements specified in FCC Part 15, Industry Canada RSS-210, European Council Directive 99/5/EC, and all applicable local laws and regulations.

Operation of this device is subject to the following two conditions:

1. this device may not cause harmful interference, and
2. this device must accept any interference received, including interference that may cause undesired operation.

Changes or modifications to this equipment not specifically approved by the Xerox Corporation may void the user's authority to operate this equipment.

Environmental Compliance

USA

ENERGY STAR®



As an ENERGY STAR® partner, Xerox Corporation has determined that this product meets the ENERGY STAR guidelines for energy efficiency.

The ENERGY STAR and ENERGY STAR MARK are registered United States trademarks. The ENERGY STAR Imaging Equipment Program is a team effort between U.S., European Union and Japanese governments and the office equipment industry to promote energy-efficient copiers, printers, fax, multifunction machine, personal computers, and monitors. Reducing product energy consumption helps combat smog, acid rain and long-term changes to the climate by decreasing the emissions that result from generating electricity.

Xerox ENERGY STAR equipment is preset at the factory. Your machine will be delivered with the timer for switching to Sleep Mode from the last copy/print out, set at 10 minutes. A more detailed description of this feature can be found in the Setups chapter in the System Administration Guide.

About License

RSA BSAFE



This product includes RSA BSAFE® Cryptographic software from RSA Security Inc.

Heimdal

Copyright (c) 2000 Kungliga Tekniska Högskolan (Royal Institute of Technology, Stockholm, Sweden). All rights reserved.

Redistribution and use in source and binary forms, with or without modification, are permitted provided that the following conditions are met:

1. Redistributions of source code must retain the above copyright notice, this list of conditions and the following disclaimer.
2. Redistributions in binary form must reproduce the above copyright notice, this list of conditions and the following disclaimer in the documentation and/or other materials provided with the distribution.
3. Neither the name of the Institute nor the names of its contributors may be used to endorse or promote products derived from this software without specific prior written permission.

THIS SOFTWARE IS PROVIDED BY THE INSTITUTE AND CONTRIBUTORS "AS IS" AND ANY EXPRESS OR IMPLIED WARRANTIES, INCLUDING, BUT NOT LIMITED TO, THE IMPLIED WARRANTIES OF MERCHANTABILITY AND FITNESS FOR A PARTICULAR PURPOSE ARE DISCLAIMED. IN NO EVENT SHALL THE INSTITUTE OR CONTRIBUTORS BE LIABLE FOR ANY DIRECT, INDIRECT, INCIDENTAL, SPECIAL, EXEMPLARY, OR CONSEQUENTIAL DAMAGES (INCLUDING, BUT NOT LIMITED TO, PROCUREMENT OF SUBSTITUTE GOODS OR SERVICES; LOSS OF USE, DATA, OR PROFITS; OR BUSINESS INTERRUPTION) HOWEVER CAUSED AND ON ANY THEORY OF LIABILITY, WHETHER IN CONTRACT, STRICT LIABILITY, OR TORT (INCLUDING NEGLIGENCE OR OTHERWISE) ARISING IN ANY WAY OUT OF THE USE OF THIS SOFTWARE, EVEN IF ADVISED OF THE POSSIBILITY OF SUCH DAMAGE.

JPEG Code

Our printer software uses some of the codes defined by the Independent JPEG Group.

Libcurl

COPYRIGHT AND PERMISSION NOTICE

Copyright (c) 1996 - 2006, Daniel Stenberg, <daniel@haxx.se>.

All rights reserved.

Permission to use, copy, modify, and distribute this software for any purpose with or without fee is hereby granted, provided that the above copyright notice and this permission notice appear in all copies.

THE SOFTWARE IS PROVIDED "AS IS", WITHOUT WARRANTY OF ANY KIND, EXPRESS OR IMPLIED, INCLUDING BUT NOT LIMITED TO THE WARRANTIES OF MERCHANTABILITY, FITNESS FOR A PARTICULAR PURPOSE AND NONINFRINGEMENT OF THIRD PARTY RIGHTS. IN NO EVENT SHALL THE AUTHORS OR COPYRIGHT HOLDERS BE LIABLE FOR ANY CLAIM, DAMAGES OR OTHER LIABILITY, WHETHER IN AN ACTION OF CONTRACT, TORT OR OTHERWISE, ARISING FROM, OUT OF OR IN CONNECTION WITH THE SOFTWARE OR THE USE OR OTHER DEALINGS IN THE SOFTWARE.

Except as contained in this notice, the name of a copyright holder shall not be used in advertising or otherwise to promote the sale, use or other dealings in this Software without prior written authorization of the copyright holder.

FreeBSD

This product contains FreeBSD codes.

The FreeBSD Copyright

Copyright 1994-2006 The FreeBSD Project. All rights reserved.

Redistribution and use in source and binary forms, with or without modification, are permitted provided that the following conditions are met:

Redistributions of source code must retain the above copyright notice, this list of conditions and the following disclaimer.

Redistributions in binary form must reproduce the above copyright notice, this list of conditions and the following disclaimer in the documentation and/or other materials provided with the distribution.

THIS SOFTWARE IS PROVIDED BY THE FREEBSD PROJECT "AS IS" AND ANY EXPRESS OR IMPLIED WARRANTIES, INCLUDING, BUT NOT LIMITED TO, THE IMPLIED WARRANTIES OF MERCHANTABILITY AND FITNESS FOR A PARTICULAR PURPOSE ARE DISCLAIMED. IN NO EVENT SHALL THE FREEBSD PROJECT OR CONTRIBUTORS BE LIABLE FOR ANY DIRECT, INDIRECT, INCIDENTAL, SPECIAL, EXEMPLARY, OR CONSEQUENTIAL DAMAGES (INCLUDING, BUT NOT LIMITED TO, PROCUREMENT OF SUBSTITUTE GOODS OR SERVICES; LOSS OF USE, DATA, OR PROFITS; OR BUSINESS INTERRUPTION) HOWEVER CAUSED

AND ON ANY THEORY OF LIABILITY, WHETHER IN CONTRACT, STRICT LIABILITY, OR TORT (INCLUDING NEGLIGENCE OR OTHERWISE) ARISING IN ANY WAY OUT OF THE USE OF THIS SOFTWARE, EVEN IF ADVISED OF THE POSSIBILITY OF SUCH DAMAGE.

The views and conclusions contained in the software and documentation are those of the authors and should not be interpreted as representing official policies, either expressed or implied, of the FreeBSD Project.

OpenLDAP

Copyright 1998-2006 The OpenLDAP Foundation All rights reserved.

Redistribution and use in source and binary forms, with or without modification, are permitted only as authorized by the OpenLDAP Public License.

A copy of this license is available in the file LICENSE in the top-level directory of the distribution or, alternatively, at <http://www.OpenLDAP.org/license.html>.

OpenLDAP is a registered trademark of the OpenLDAP Foundation.

Individual files and/or contributed packages may be copyright by other parties and/or subject to additional restrictions.

This work is derived from the University of Michigan LDAP v3.3 distribution. Information concerning this software is available at <http://www.umich.edu/~dirsvcs/ldap/ldap.html>.

This work also contains materials derived from public sources.

Additional information about OpenLDAP can be obtained at <http://www.openldap.org/>.

Portions Copyright 1998-2006 Kurt D. Zeilenga.

Portions Copyright 1998-2006 Net Boolean Incorporated.

Portions Copyright 2001-2006 IBM Corporation.

All rights reserved.

Redistribution and use in source and binary forms, with or without modification, are permitted only as authorized by the OpenLDAP Public License.

Portions Copyright 1999-2005 Howard Y.H. Chu.
Portions Copyright 1999-2005 Symas Corporation.
Portions Copyright 1998-2003 Hallvard B. Furuseth.
All rights reserved.

Redistribution and use in source and binary forms, with or without modification, are permitted provided that this notice is preserved.

The names of the copyright holders may not be used to endorse or promote products derived from this software without their specific prior written permission. This software is provided "as is" without express or implied warranty.

Portions Copyright (c) 1992-1996 Regents of the University of Michigan.

All rights reserved.

Redistribution and use in source and binary forms are permitted provided that this notice is preserved and that due credit is given to the University of Michigan at Ann Arbor. The name of the University may not be used to endorse or promote products derived from this software without specific prior written permission. This software is provided "as is" without express or implied warranty.

The OpenLDAP Public License

Version 2.8, 17 August 2003

Redistribution and use of this software and associated documentation ("Software"), with or without modification, are permitted provided that the following conditions are met:

1. Redistributions in source form must retain copyright statements and notices,
2. Redistributions in binary form must reproduce applicable copyright statements and notices, this list of conditions, and the following disclaimer in the documentation and/or other materials provided with the distribution, and
3. Redistributions must contain a verbatim copy of this document..

The OpenLDAP Foundation may revise this license from time to time.

Each revision is distinguished by a version number. You may use this Software under terms of this license revision or under the terms of any subsequent revision of the license.

THIS SOFTWARE IS PROVIDED BY THE OPENLDAP FOUNDATION AND ITS CONTRIBUTORS "AS IS" AND ANY EXPRESSED OR IMPLIED WARRANTIES, INCLUDING, BUT NOT LIMITED TO, THE IMPLIED WARRANTIES OF MERCHANTABILITY AND FITNESS FOR A PARTICULAR PURPOSE ARE DISCLAIMED. IN NO EVENT

SHALL THE OPENLDAP FOUNDATION, ITS CONTRIBUTORS, OR THE AUTHOR(S) OR OWNER(S) OF THE SOFTWARE BE LIABLE FOR ANY DIRECT, INDIRECT, INCIDENTAL, SPECIAL, EXEMPLARY, OR CONSEQUENTIAL DAMAGES (INCLUDING, BUT NOT LIMITED TO, PROCUREMENT OF SUBSTITUTE GOODS OR SERVICES; LOSS OF USE, DATA, OR PROFITS; OR BUSINESS INTERRUPTION) HOWEVER CAUSED AND ON ANY THEORY OF LIABILITY, WHETHER IN CONTRACT, STRICT LIABILITY, OR TORT (INCLUDING NEGLIGENCE OR OTHERWISE) ARISING IN ANY WAY OUT OF THE USE OF THIS SOFTWARE, EVEN IF ADVISED OF THE POSSIBILITY OF SUCH DAMAGE.

The names of the authors and copyright holders must not be used in advertising or otherwise to promote the sale, use or other dealing in this Software without specific, written prior permission. Title to copyright in this Software shall at all times remain with copyright holders.

OpenLDAP is a registered trademark of the OpenLDAP Foundation.

Copyright 1999-2003 The OpenLDAP Foundation, Redwood City, California, USA. All Rights Reserved. Permission to copy and distribute verbatim copies of this document is granted.

DES

This product includes software developed by Eric Young(eay@mincom.oz.au)

AES

Copyright (c) 2003. Dr Brian Gladman. Worcester. UK. All rights reserved.

This product uses published AES software provided by Dr Brian Gladman under BSD licensing terms.

TIFF (libtiff)

Lib TIFF copyright (c) 1988-1997 Sam Leffler
Copyright (c) 1991-1997 Silicon Graphics. Inc.

XPS

This product may incorporate intellectual property owned by Microsoft Corporation. The terms and conditions upon which Microsoft is licensing such intellectual property may be found at <http://go.microsoft.com/fwlink/?LinkId=52369>.

Illegal Copies

USA

Congress, by statute, has forbidden the reproduction of the following subjects under certain circumstances. Penalties of fine or imprisonment may be imposed on those guilty of making such reproductions.

1. Obligations or Securities of the United States Government, such as:

Certificates of Indebtedness	National Bank Currency
Coupons from Bonds	Federal Reserve Bank Notes
Silver Certificates	Gold Certificates
United States Bonds	Treasury Notes
Federal Reserve Notes	Fractional Notes
Certificates of Deposit	Paper Money

Bonds and Obligations of certain agencies of the government, such as FHA, etc.

Bonds (U.S. Savings Bonds may be photographed only for publicity purposes in connection with the campaign for the sale of such bonds.)

Internal Revenue Stamps. If it is necessary to reproduce a legal document on which there is a canceled revenue stamp, this may be done provided the reproduction of the document is performed for lawful purposes.

Postage Stamps, canceled or uncanceled. For philatelic purposes, Postage Stamps may be photographed, provided the reproduction is in black and white and is less than 75% or more than 150% of the linear dimensions of the original.

Postal Money Orders.

Bills, Checks, or Draft of money drawn by or upon authorized officers of the United States.

Stamps and other representatives of value, of whatever denomination, which have been or may be issued under any Act of Congress.

2. Adjusted Compensation Certificates for Veterans of the World Wars.
3. Obligations or Securities of any Foreign Government, Bank, or Corporation.
4. Copyrighted materials, unless permission of the copyright owner has been obtained or the reproduction falls within the "fair use" or library reproduction rights provisions of the copyright law. Further information of these provisions may be obtained from the Copyright Office, Library of Congress, Washington, D.C. 20559. Ask for Circular R21.
5. Certificates of Citizenship or Naturalization. Foreign Naturalization Certificates may be photographed.
6. Passports. Foreign Passports may be photographed.
7. Immigration Papers.
8. Draft Registration Cards.
9. Selective Service Induction Papers that bear any of the following Registrant's information:

Earnings or Income	Dependency Status
Court Record	Previous military service
Physical or mental condition	

Exception: United States military discharge certificates may be photographed.

10. Badges, Identification Cards, Passes, or Insignia carried by military personnel, or by members of the various Federal Departments, such as FBI, Treasury, etc. (unless photograph is ordered by the head of such department or bureau.)

Reproducing the following is also prohibited in certain states:

Automobile Licenses - Drivers' Licenses - Automobile Certificates of Title.

The above list is not all inclusive, and no liability is assumed for its completeness or accuracy. In case of doubt, consult your attorney.

Canada

Parliament, by statute, has forbidden the reproduction of the following subjects under certain circumstances. Penalties of fine or imprisonment may be imposed on those guilty of making such reproductions.

1. Current bank notes or current paper money.
2. Obligations or securities of a government or bank.
3. Exchequer bill paper or revenue paper.
4. The public seal of Canada or of a province, or the seal of a public body or authority in Canada, or of a court of law.
5. Proclamations, orders, regulations or appointments, or notices thereof (with intent to falsely cause same to purport to have been printed by the Queen's Printer for Canada, or the equivalent printer for a province).
6. Marks, brands, seals, wrappers or designs used by or on behalf of the Government of Canada or of a province, the government of a state other than Canada or a department, board, Commission or agency established by the Government of Canada or of a province or of a government of a state other than Canada.
7. Impressed or adhesive stamps used for the purpose of revenue by the Government of Canada or of a province or by the government of a state other than Canada.
8. Documents, registers or records kept by public officials charged with the duty of making or issuing certified copies thereof, where the copy falsely purports to be a certified copy thereof.
9. Copyrighted material or trademarks of any manner or kind without the consent of the copyright or trademark owner.

The above list is provided for your convenience and assistance, but it is not all-inclusive, and no liability is assumed for its completeness or accuracy. In case of doubt, consult your solicitor.

Other Countries

Copying certain documents may be illegal in your country. Penalties of fine or imprisonment may be imposed on those found guilty of making such reproductions.

- Currency notes
- Bank notes and cheques
- Bank and government bonds and securities
- Passports and identification cards
- Copyright material or trademarks without the consent of the owner
- Postage stamps and other negotiable instruments

This list is not inclusive and no liability is assumed for either its completeness or accuracy. In case of doubt, contact your legal counsel.

Product Recycling and Disposal

Battery Recycling and Disposal

Dispose of all batteries in accordance with local legislation.

For recovery of scarce resources, Xerox reuses the rechargeable batteries used in this product after the product is returned. Those batteries can be reused to make recycle materials and energy recovery.

All Countries, North America - USA/Canada

Xerox operates a worldwide equipment takeback and reuse/recycle program. Contact your Xerox sales representative at (1-800-ASK-XEROX) to determine whether this Xerox product is part of the program. For more information about Xerox environmental programs, visit www.xerox.com/environment.

If you are managing the disposal of your Xerox product, please note that the product contains lamp(s) with mercury, and may contain lead, Perchlorate and other materials whose disposal may be regulated due to environmental considerations. The presence of these materials is fully consistent with global regulations applicable at the time that the product was placed on the market. For recycling and disposal information, contact your local authorities. In the United States, you may also refer to the Electronic Industries Alliance web site:

www.eiae.org <<http://www.eiae.org>>.

Perchlorate Material - This product may contain one or more Perchlorate-containing devices, such as batteries. Special handling may apply, please see:

www.dtsc.ca.gov/hazardouswaste/perchlorate.

European Union

WEEE Domestic/Household



Application of this symbol on your equipment is confirmation that you should not dispose of the equipment in the normal household waste stream. In accordance with European legislation, end of life electrical and electronic equipment subject to disposal must be segregated from household waste.

Private households within EU member states may return used electrical and electronic equipment to designated collection facilities free of charge. Please contact your local disposal authority for information.

In some member states, when you purchase new equipment, your local retailer may be required to take back your old equipment free of charge. Please ask your retailer for information.

Prior to disposal, please contact your local dealer or Xerox representative for end of life takeback information.

WEEE Professional/Business



Application of this symbol on your equipment is confirmation that you must dispose of this equipment in compliance with agreed national procedures. In accordance with European legislation, end of life electrical and electronic equipment subject to disposal must be managed within agreed procedures.

Private households within EU member states may return used electrical and electronic equipment to designated collection facilities free of charge. Please contact your local disposal authority for information.

Other Countries

Please contact your local waste authorities and request disposal guidance.

2 Product Overview

This machine is not simply a conventional copier, but a digital device capable of copying, faxing, printing and scanning, depending on the configuration.

The screens shown in this manual are from a fully configured machine to cover all the features.

The content of the screens may vary slightly depending on the system settings and machine configuration. The button names and icons on the control panel also vary depending on the machine configuration. However, the machine features described here remain the same.

For more information on available options not described here, visit the Xerox website or contact your Xerox Sales Representative.

Machine Components

The following diagrams show the standard and optional components of the machine.

Front View

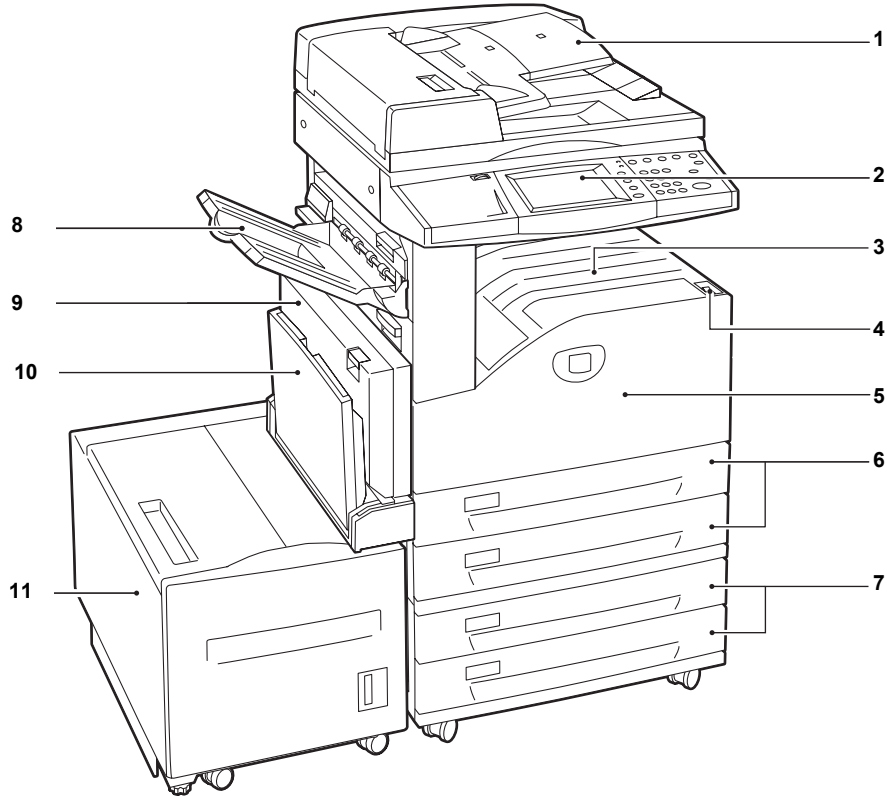

No.	Component	Function
1	Duplex automatic document feeder	Automatically feeds multiple-page documents into the machine.
2	Control panel	Consists of operation buttons, LED indicators, and a touch screen. NOTE: For more information, refer to <i>Control Panel on page 36</i> .
3	Center tray	Delivers copies or prints face down.
4	Power switch	Switches the machine on/off.
5	Front cover	Open this cover when replacing consumables.
6	Trays 1 & 2	Load paper here. NOTE: The optional Envelope Tray can be inserted into the slot for Tray 1. The standard Tray 1 cannot be used when the Envelope Tray is used.
7	Two Tray Module (Trays 3 & 4) (optional)	Load paper here. These trays can be added to the standard 2-tray configuration.
8	Left Side tray (optional)	Delivers copies or prints face up.
9	Automatic duplex unit	Automatically copies or prints on both sides of the paper.
10	Tray 5, bypass tray	Use this tray when copying or printing on non-standard paper (e.g., thick-stock paper and other special media) that cannot be loaded in Trays 1 to 4.
11	High Capacity Feeder (optional)	Allows you to load up to 2,000 sheets of 20 lb bond or 80 g/m ² paper in B5, 7.25 x 10.5", 8.5 x 11", or A4 size, long edge feed.

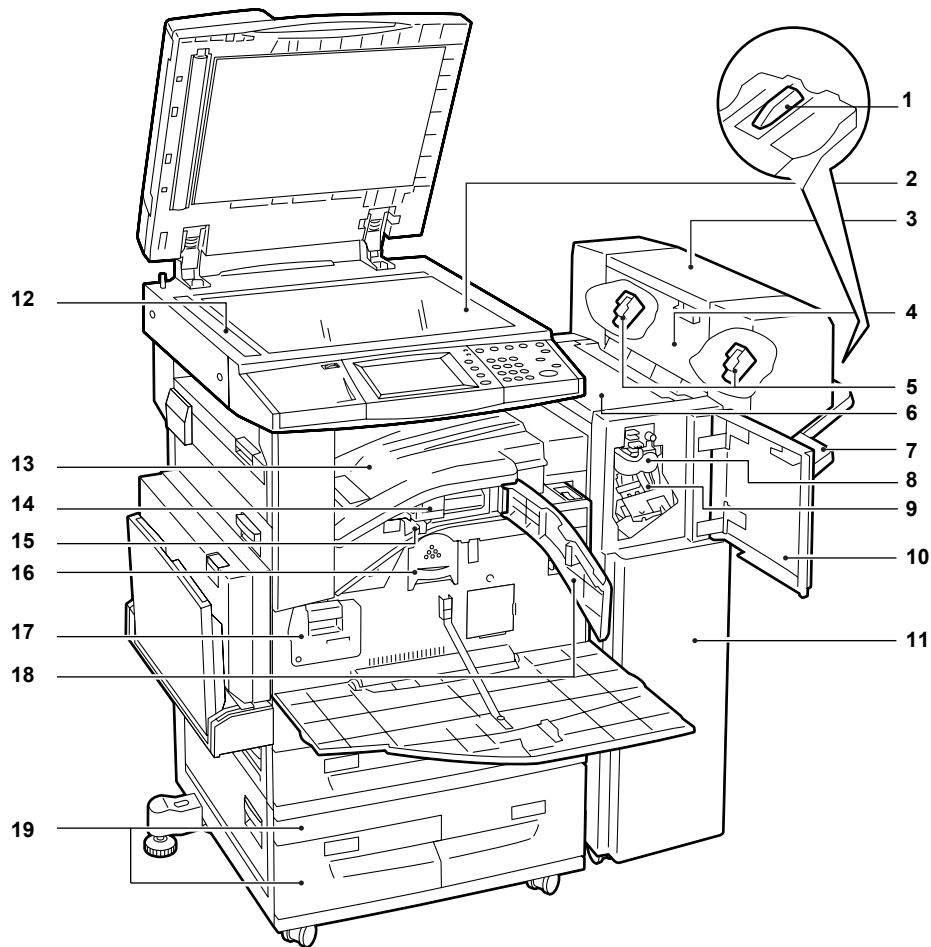

No.	Component	Function
1	Tray attachment (Office Finisher LX)	Use this attachment when outputting unstapled A4 LEF, 8.5 x 11" LEF, or B5 LEF paper to the Office Finisher LX tray. NOTE: For information on how to use the tray attachment, refer to <i>Attaching the Tray Attachment to the Office Finisher LX (Optional)</i> on page 42.
2	Document glass	Place a single-page or bound document here.
3	Booklet Maker (optional) (Office Finisher LX)	Makes stapled copies or prints with a crease for easy folding.
4	Booklet Maker side cover (Office Finisher LX)	Open this cover when replacing the booklet staple cartridges.
5	Booklet staple cartridges (Office Finisher LX)	Staple cartridges for booklet creation. The Booklet Maker contains two booklet staple cartridges.
6	Top cover (Office Finisher LX)	Open this cover when clearing paper jams.
7	Finisher tray (Office Finisher LX)	Delivers outputs processed by the Office Finisher LX.
8	Folding Unit (Office Finisher LX)	Makes a crease in each sheet of copies or prints for easy folding.

No.	Component	Function
9	Staple cartridge (Office Finisher LX)	Contains staples.
10	Front cover (Office Finisher LX)	Open this cover when clearing paper jams or loading staples.
11	Office Finisher LX (optional)	Staples or punches copies or prints.
12	Document feeder glass	Scans documents.
13	Top transport cover (Office Finisher LX)	Open this cover when clearing paper jams or loading staples.
14	Hole-Punch Unit 2 & 3 Holes, 2 & 4 Holes, or 4 Holes (optional) (Office Finisher LX)	Hole-punches copies or prints.
15	Hole punch waste container (Office Finisher LX)	Collects punch waste.
16	Toner cartridge	Contains toner (Image forming pigments).
17	Drum cartridge	Contains the photoreceptor.
18	Front transport cover (Office Finisher LX)	Open this cover when emptying the hole punch waste container.
19	High Capacity Tandem Tray (Trays 3 & 4) (optional)	Load paper here. These trays can be added to the standard 2-tray configuration.

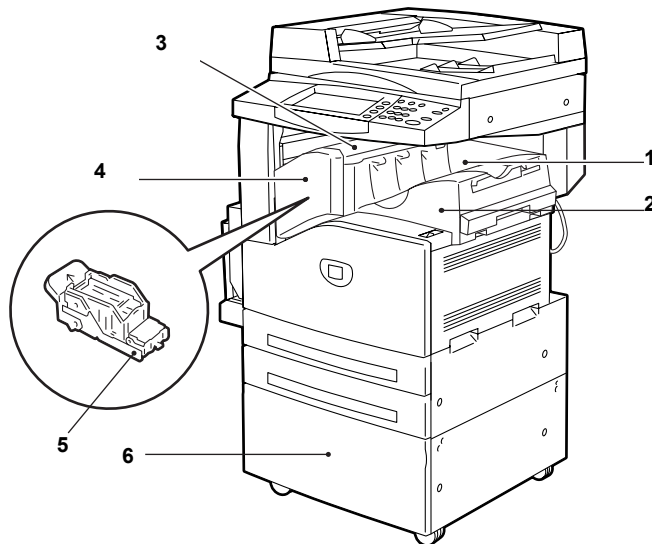

No.	Component	Function
1	Center tray (Integrated Office Finisher)	Delivers copies or prints.
2	Integrated Office Finisher (optional)	Staples copies or prints.

No.	Component	Function
3	Top cover (Integrated Office Finisher)	Open this cover when clearing paper jams.
4	Front cover (Integrated Office Finisher)	Open this cover when loading staples or clearing staple jams.
5	Staple cartridge (Integrated Office Finisher)	Contains staples.
6	Stand (Optional)	Supports the main unit.

Rear View

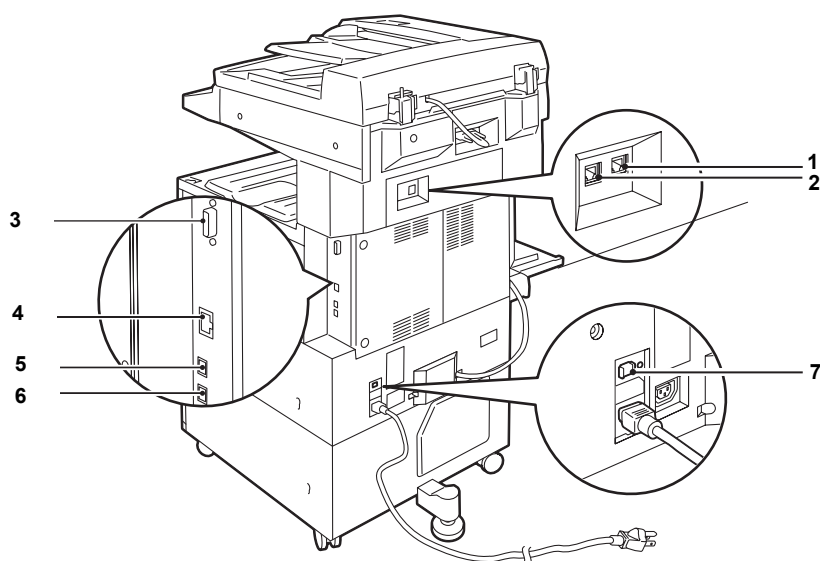

No.	Component	Function
1	Line 1	Use this connector to connect the machine to a telephone line.
2	TEL	Use this connector to connect the machine to a telephone device. Depending on the region, this connector may not be provided.
3	Foreign Device Interface (FDI) connector	Use this connector to connect the machine to a third-party device (such as an access control device, coin machine, or card reader). NOTE: Foreign Device Interface (FDI) is an optional interface that supports a variety of vending stations available through the Xerox Custom Application Service.
4	10Base-T/100Base-TX connector	Use this connector to connect a network cable to the machine.
5	USB 2.0 interface connector	Use this connector to connect a USB cable to the machine.
6	Connector	This connector is to be used only by customer engineers.
7	Ground fault interrupter	Automatically shuts off electricity in the event of current leakage.

Control Panel

The following diagram shows the names and functions of the buttons on the control panel.

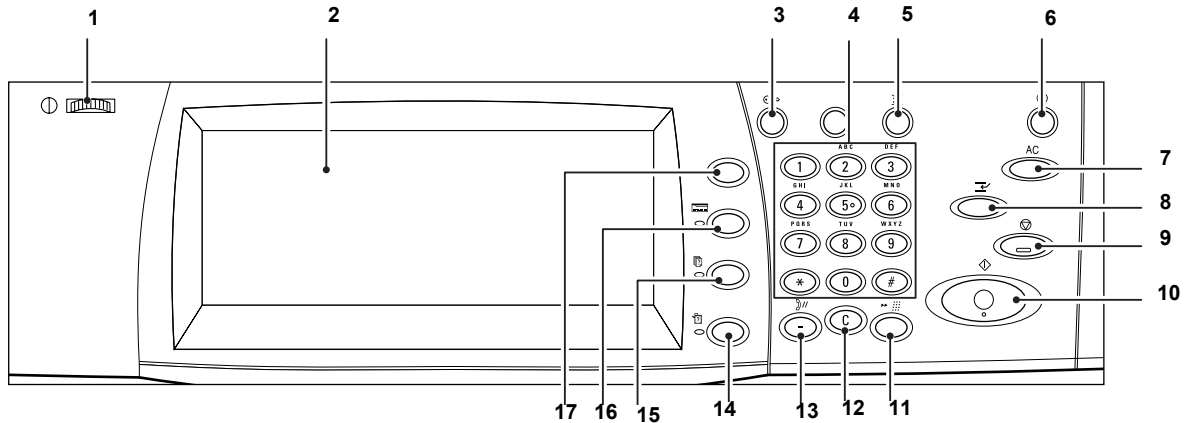

No.	Button	Function
1	Brightness dial	Use this dial to adjust the contrast of the touch screen.
2	Touch screen	Displays messages and screen buttons for the various features. Touch the screen to access the features.
3	<Log In/Out> button	Displays the login screen to enter the System Administration mode or when the Authentication/Accounting feature is enabled. Pressing this button again after you have logged in will log you out immediately.
4	Numeric keypad	Press these buttons to enter the number of copies, passwords, and other numerical values.
5	<Language> button	Changes the language of the touch screen.
6	<Energy Saver> button/ indicator	When the machine is left idle for a certain period of time, it enters the Energy Saver mode to reduce power consumption. This indicator lights up when the machine is in the Energy Saver mode. To exit this mode, press this button.
7	<Clear All> button	Press this button twice to reset the status of all services to the default settings. The machine will return to the default state after it is switched on.
8	<Interrupt> button	Press this button to temporarily interrupt a copy or print job and give another job a higher priority. This button lights up while the priority job is being processed. Press this button after the priority job is finished to resume the job that was interrupted.
9	<Stop> button	Press this button to suspend a job. When multiple jobs are being processed, pressing this button suspends all the jobs. The jobs can be cancelled by selecting [Stop] on the Job Status screen.
10	<Start> button	Press this button to start a job.
11	<Speed Dial> button	Press this button to enter speed dial codes.
12	<C> (clear) button	Press this button to delete a numeric value or the last digit entered, or to replace the current value with the default value. The button also cancels a suspended job.

No.	Button	Function
13	<Dial Pause> button	Inserts a pause while dialing a fax number.
14	<Machine Status> button	Displays a screen where you can check the machine status, billing meter, and the status of consumables, or print various reports. Use this button also when accessing the System Administration mode.
15	<Job Status> button	Displays a screen where you can check the progress of active jobs, or display the detailed information of completed jobs.
16	<Features> button	Returns the display to the previous service screen when the Job Status screen or Machine Status screen is displayed.
17	<All Services> button	Displays a screen where you can access the services available on the machine. NOTE: The services that appear on the All Services screen can be programmed under the System Administration mode. For more information, refer to the System Administration Guide.

Machine Services

The machine provides various services that can be accessed by pressing the <All Services> button on the control panel. The following description outlines the services available on the machine.

NOTE: In this manual, the screen that is displayed by pressing the <All Services> button is referred to as the “All Services screen”.

NOTE: The arrangement of icons for the services displayed on the screen can be changed by the System Administrator.

1. Press the <All Services> button on the control panel.
2. Select the required service on the All Services screen.

NOTE: Use the scroll bar to switch between screens.

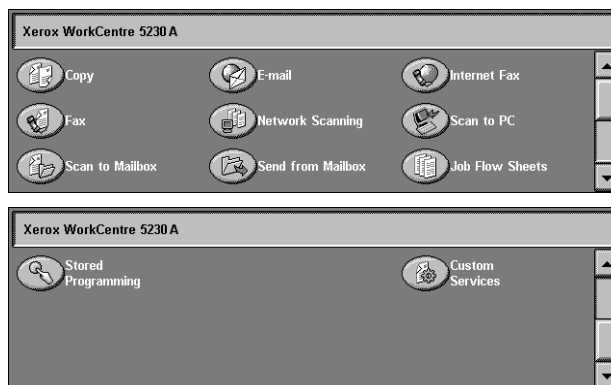

Copy

Allows you to copy documents in various ways. For example, you can produce output which has been reduced or enlarged to a different size, or copy two or four independent documents onto one sheet of paper. For more information, refer to the *Copy chapter on page 45*.

E-mail

Allows you to send scanned documents by e-mail in various ways. For example, you can set the density for scanning, or specify the file format for saving the documents. For more information, refer to the *Scan/E-mail chapter on page 115*.

Internet Fax

Allows you to send and receive faxes over the Internet or intranet. Internet Fax provides reduced cost of transmissions compared to the use of a conventional phone line. After scanning documents, you can send scanned data by e-mail, and can also receive scanned data in an e-mail attachment sent from an Internet Fax compatible machine. For more information, refer to the *Fax chapter on page 77*.

Fax

Allows you to fax documents in various ways. For example, you can send documents in a reduced or enlarged format, or specify destinations using the Address Book or speed dialing features. For more information, refer to the *Fax chapter on page 77*.

Server Fax

Allows you to send and receive image data by using the fax feature of a fax server. The Server Fax service cannot be used concurrently with the Fax or Internet Fax service. For more information, refer to the *Fax chapter on page 77*.

Network Scanning

Allows you to scan documents and store them as electronic documents on a file server on the network by selecting a job template which has various assigned parameters. You can retrieve the stored electronic documents by accessing the file server from a PC. For more information, refer to *Network Scanning in the Scan/E-mail chapter on page 124*, and *Services in the CentreWare Internet Services chapter on page 163*.

Scan to PC

Allows you to scan and store documents into specified destinations using the FTP or SMB protocol. For more information, refer to *Scan to PC in the Scan/E-mail chapter on page 125*.

Scan to Mailbox

Enables the confidential mailbox or polling feature by storing the scanned documents into private mailboxes. For more information, refer to *Scan to Mailbox in the Scan/E-mail chapter on page 124*.

Send from Mailbox

Allows you to confirm, print, or delete the documents in a mailbox. It also allows you to change or release linkage with a job flow sheet, and execute the linked job flow sheets. For more information, refer to the *Send from Mailbox chapter on page 147*.

Job Flow Sheets

Allows you to execute a series of actions on scanned documents using a job flow sheet created on a networked computer. For more information, refer to the *Job Flow Sheets chapter on page 155*.

Custom Services

Allows independent software vendors and partners to develop customized programs to access directly from the machine. Users can enter their authentication login at the machine and access a set of features and options designed specifically for their business needs. Refer to Xerox Extensible Interface Platform (XEIP) in the Appendix chapter of the System Administration Guide on how to set up this feature.

Stored Programming

Allows you to store frequently-used settings as a program and recall them with just one button. This service is not available on the All Services screen by default, but can be displayed by the System Administrator. For instructions on how to display the service on the All Services screen, refer to the System Administration Guide or ask your System Administrator. For more information on this feature, refer to the *Stored Programming chapter on page 159* or the Setups chapter in the System Administration Guide.

Power On/Off

Powering On

Ensure that the machine is connected to a suitable power supply and that the power plug is firmly connected to the electrical outlet.

The machine is ready to make copies after a maximum of 26 seconds from powering on (varies with the machine configuration).

1. Press the power switch to the <|> position.

NOTE: If the machine does not start up, check that the RESET button on the back of the machine is in the reset position (depressed).

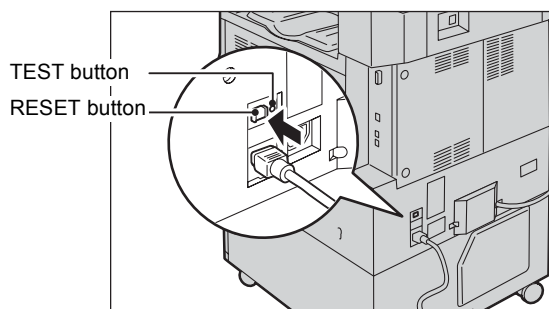
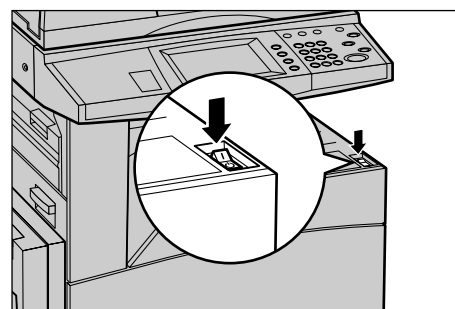

Powering Off

Before switching off the machine, wait at least 5 seconds after all copy or print jobs have completely finished.

After you switch off the machine, it remains on for approximately 10 seconds while it stores files on the hard disk drive and prepares for shutdown. The machine then shuts down completely. Be careful not to unplug the power cord immediately after you switch off the machine.

NOTE: If the machine is switched off while processing data stored in the memory, the data may be lost.

NOTE: When switching on the machine again, wait at least 10 seconds after the touch screen is turned off and the machine completely shuts down.

Ground Fault Interrupter (GFI)

If a fault is detected in the power supply to the machine, a Ground Fault Interrupter (GFI) device on the machine automatically cuts all electrical power. If power is interrupted, locate the RESET button on the back of the machine. If the GFI has been triggered, the RESET button will be in the tripped position. To restore power to the machine, press the RESET button.

Before using the machine, press the TEST button. If the GFI is working properly, the RESET button should pop up. If it does, press the RESET button.

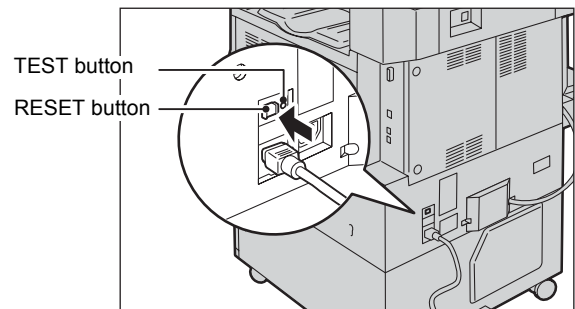

NOTE: If the RESET button pops back up when you press it, or if power is not restored by this procedure, contact the Xerox Welcome Center.

Energy Saver Modes

The machine has a power saving feature that significantly reduces power consumption during periods of inactivity. The <Energy Saver> button is located on the upper-right portion of the control panel, and lights up when the power saving feature is enabled. The power saving feature operates in the following modes.

- Low Power Mode
- Sleep Mode

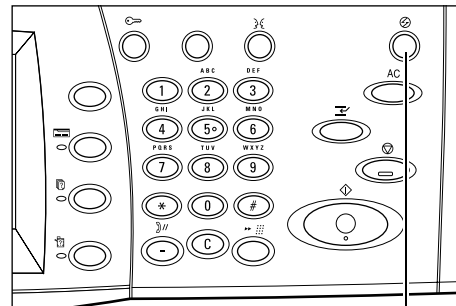

<Energy Saver>
light/button

Low Power Mode

The machine automatically switches to the Low Power Mode after a certain period of time from the last copy, fax, scan, or print operation. In this mode, the touch screen is turned off, and the <Energy Saver> light is on. The Low Power Mode is cancelled when the <Energy Saver> button on the control panel is pressed, or a fax or print job is received by the machine. The factory default setting of 5 minutes is customer changeable within the range of 2 to 60 minutes.

Sleep Mode

The machine automatically switches from the Low Power Mode to the Sleep Mode after a further period of inactivity. The Sleep Mode has a reduced power consumption compared to Low Power Mode. In this mode, the touch screen is turned off, and the

<Energy Saver> light is on. The Sleep Mode is cancelled when the <Energy Saver> button is pressed, or a fax or print job is received by the machine. The factory default setting of 5 minutes is customer changeable within the range of 2 to 60 minutes, and must be longer than the Low Power Mode time value. The time specified for entering the Sleep Mode will be counted from when the machine enters the Low Power Mode.

NOTE: For information on how to change the default time settings, refer to the Setups chapter in the System Administration Guide.

Modes

Use the following buttons to access the screens which allow you to select features, monitor the status of jobs, and obtain general information on the machine:

- All Services
- Features
- Job Status
- Machine Status

NOTE: These buttons do not respond when the machine is in the System Administration mode.

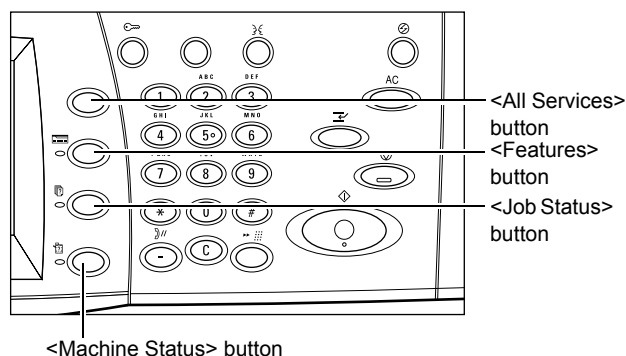

All Services

Use this button to access all the services available on the machine.

NOTE: The arrangement of service icons displayed on the screen can be changed by the System Administrator.

1. Press the <All Services> button on the control panel.



Features

Use this button to return the display to the previous service screen when the Job Status screen or Machine Status screen is displayed. The previous service screen may not appear, even if you press this button, if you are in one of the service screens. In this case, use the <All Services> button to select the required service.

Job Status

Use this button to check the progress of a job, or display the log and detailed information of completed jobs. The latest job is displayed at the top of the list. Use this button to also check, delete, or print stored documents or documents in the machine's mailboxes. For more information, refer to the Job Status chapter in the System Administration Guide.

Machine Status

Use this button to check the machine status, the billing meter, and the status of consumables, or to print various reports. This button is also used when accessing the System Administration mode. For more information, refer to the Machine Status chapter in the System Administration Guide.

Job Interrupt

Use this feature to temporarily suspend the current job to allow an urgent job to be initiated.

NOTE: The machine identifies a convenient point to interrupt the current job.

1. Press the <Interrupt> button on the control panel.
2. Enter the commands for the new job.
3. Press the <Start> button on the control panel.
4. To restart the interrupted job, press the <Interrupt> button again, and press the <Start> button.

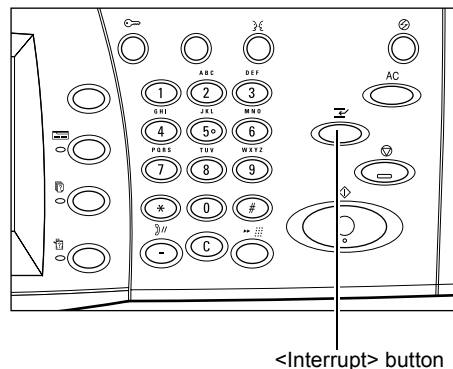

NOTE: Interrupted jobs cannot be promoted, released, or deleted in the print queue.

Attaching the Tray Attachment to the Office Finisher LX (Optional)

When you output unstapled A4 LEF, 8.5 x 11" LEF, or B5 LEF paper to the Finisher tray, using the tray attachment is recommended.

1. Remove the tray attachment from under the Office Finisher LX tray.

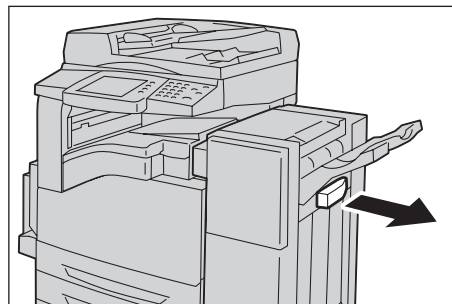

2. Attach the tray attachment to the tray, as shown in the illustration.

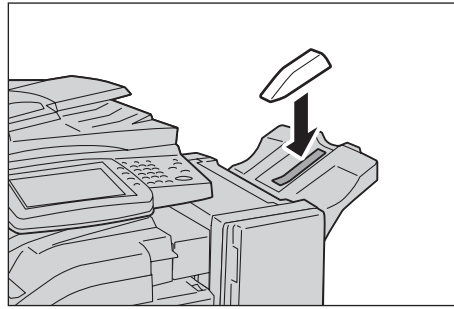

Recycled Paper

The use of recycled paper in the machine benefits the environment with no degradation in performance. Xerox recommends recycled paper with 20% post consumer content which can be obtained both through Xerox and other office suppliers. Contact your Xerox representative or go to www.xerox.com for more information on other types of recycled paper.

3 Copy

This chapter contains information on the copy screens and the features available.

NOTE: Some of the features described in this chapter are optional, and may not apply to your machine configuration.

Copying Procedure

This section describes the basic copy procedure. Follow the steps below.

1. *Load the Documents – page 45*
2. *Select the Features – page 47*
3. *Enter the Quantity – page 48*
4. *Start the Copy Job – page 48*
5. *Check the Status of the Copy Job – page 48*
Stopping a Copy Job – page 49

NOTE: If the Authentication and Accounting feature is enabled, you may be required to enter your user ID and passcode (if they are set up) before using the machine. For further information, contact the System Administrator.

1. Load the Documents

The machine provides the following document input areas:

- Document feeder - for single or multiple-page documents
- Document glass - for single-page or bound documents

NOTE: The document glass cover will be installed in the non-document feeder configuration.

NOTE: The machine automatically detects standard document sizes. The sizes that can be detected vary depending on the paper size table specified by the System Administrator. For more information on setting the paper size table, refer to the Setups chapter in the System Administration Guide. If the document is of a non-standard size or not identified as a standard size, the machine will prompt you to check the document or manually enter the document size. For information on how to enter a document size manually, refer to *Original Size on page 59*.

Document Feeder

The following explains how to load documents using the document feeder.

The maximum capacity of the document feeder is shown below:

Document Type (Weight)	Capacity
Lightweight (38-49 g/m ²)	75 sheets
Plain (50-80 g/m ²)	75 sheets
Heavyweight (81-128 g/m ²)	50 sheets

Documents can be any size from 139.7 to 297 mm (4.9 to 11.7 inches) for the width and 210 to 432 mm (4.5 to 17 inches) for the length, and the standard sizes of 5.5 x 8.5" SEF/LEF to 7.25 x 10.5" SEF/LEF. Make sure that documents are in good condition, and remove all staples or paper clips before loading.

NOTE: To reduce the risk of document feeder jams, use the document glass to copy folded or creased documents.

NOTE: A paper jam may occur when custom sized originals are loaded in the document feeder and the original size feature is set to [Auto Detect]. In this case, entering a custom paper size is recommended. For more information, refer to *Original Size* on page 59.

The machine is capable of sequentially scanning mixed size documents using the document feeder. Align the documents against the top corner of the document feeder.

For information on how to copy mixed size originals using the document feeder, refer to *Mixed Sized Originals* on page 59.

1. Before loading the documents into the document feeder, remove all staples and paper clips.
2. Insert the documents neatly in the document feeder face up, aligning the left edge with the document feeder tray. The first page should be on top with the headings towards the back or left of the machine.

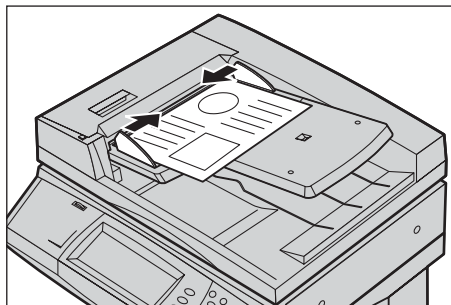

3. Position the guides to just touch the edge of the documents.

When [Auto Paper Select] is selected in [Paper Supply], the machine automatically selects an appropriate tray according to the document size. The selected tray, paper size, and paper orientation in the selected tray are displayed on the screen.

NOTE: This feature is available when the machine finds an appropriate tray. If there is no appropriate tray, manually select a tray or use Tray 5 (Bypass). For more information on tray selection, refer to *Paper Supply* on page 51.

Document Glass

The following explains how to load a document using the document glass.

The document glass is used for a single-page or bound document up to 297 mm (11.7 inches) for the width and up to 432 mm (17 inches) for the length.

NOTE: Before you place a document on the document glass, make sure that the touch screen is ready. If you place the document on the document glass before the touch screen is ready, the paper size may not be detected correctly.

1. Raise the document feeder or the document glass cover.

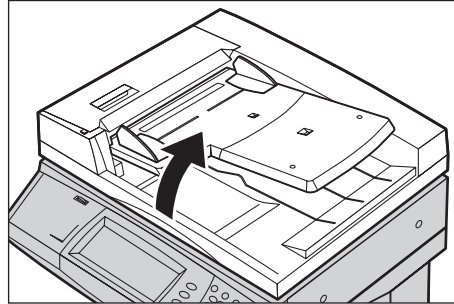

2. Place the document face down on the document glass, aligned with the tip of the registration arrow near the top left of the document glass.

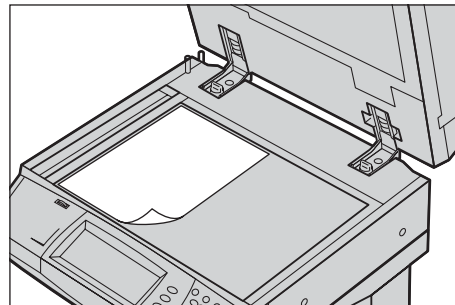

3. Lower the document feeder or the document glass cover.

2. Select the Features

NOTE: The features displayed on the copy screens vary depending on your machine configuration.

1. Press the <All Services> button on the control panel.

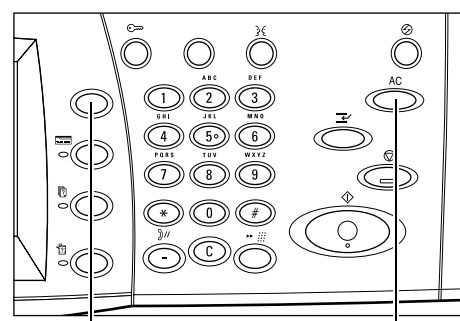

<All Services> button

<Clear All> button

2. Select [Copy] on the All Services screen.



NOTE: If the Authentication and Accounting feature is enabled, you may be required to enter your user ID and passcode (if they are set up). If you need assistance, contact the System Administrator.

- Set the required features on each tab. If [More] is selected, select [Save] to confirm the selected feature or [Cancel] to return to the previous screen.

For information on the features available on each tab, refer to the following:

Copy – page 49

Image Quality – page 55

Layout Adjustment – page 57

Output Format – page 62

Job Assembly – page 72

3. Enter the Quantity

The maximum copy quantity is 999.

- Use the numeric keypad to enter the number of copies required. The number entered is displayed in the upper right corner of the touch screen.

NOTE: To cancel an incorrect entry, press the <C> button, and enter the correct quantity.

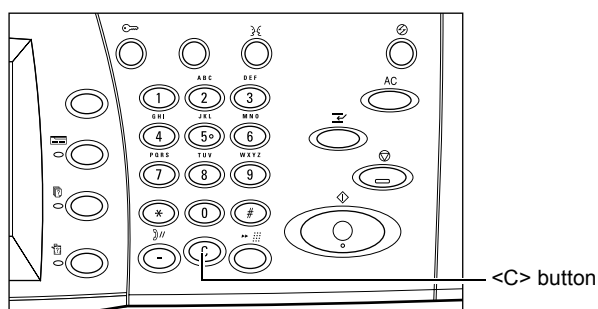

4. Start the Copy Job

- Press the <Start> button. Each document is scanned. The number of copies remaining is displayed in the upper right corner of the touch screen.

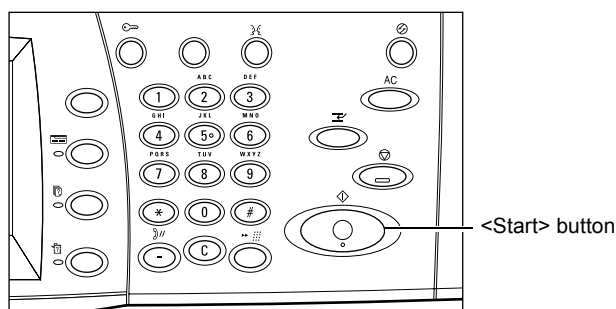

While copying, if the document feeder or document glass is ready, you can scan the next document or program the next job. You can also program the next job while the machine is warming up.

5. Check the Status of the Copy Job

- Press the <Job Status> button on the control panel to display the [Active Jobs] tab.

Active Jobs		Completed Jobs	Secure Print Jobs & More	Print Waiting Jobs	View by Job Type
#	Owner	Name		Status	
001	-	Copy	-	Printing	
002	-	File 123	00002	Job in Progress	
003	-	FTP Transfer	00003	Transferring	
004	-	Fax Send	00005	Sending	

The queued copy job is displayed. If the job is not displayed, it may have already been processed.

For more information, refer to the Job Status chapter in the System Administration Guide.

Stopping a Copy Job

Follow the steps below to manually cancel an activated copy job.

1. Press the <Stop> button on the control panel to suspend the current copy job.

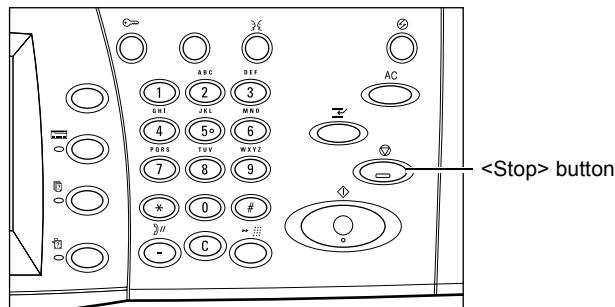

2. If required, press the <Job Status> button to display the [Active Jobs] tab. To exit the [Active Jobs] tab, press the <Features> button.

Active Jobs		Completed Jobs	Secure Print Jobs & More	Print Waiting Jobs	View by Job Type
#	Owner	Name	Status		
001	-	Copy	-	Printing	
002	-	File 123	00002	Job in Progress	
003	-	FTP Transfer	00003	Transferring	
004	-	Fax Send	00005	Sending	

3. On the [Stop/Pause] screen displayed, select [Cancel] to delete the suspended copy job.

NOTE: To resume the job, select [Resume] on the [Stop/Pause] screen.

Copy

This section describes the features on the [Copy] screen. For information on the features available, refer to the following:

- Reduce/Enlarge – page 49*
- Paper Supply – page 51*
- 2 Sided Copying – page 52*
- Copy Output – page 53*

1. Press the <All Services> button on the control panel.
2. Select [Copy] on the touch screen.
3. Set the required feature.
4. Select [Save].

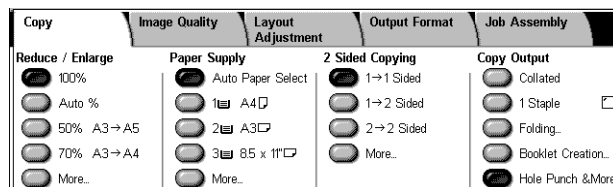

Reduce/Enlarge

This feature allows you to reduce or enlarge copies by a specified ratio within the range of 25-400%.

1. Select the [Reduce/Enlarge] feature on the [Copy] screen.

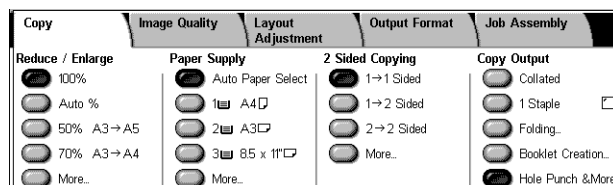

More

Displays the [Reduce/Enlarge] screen. For more information, refer to *[Reduce/Enlarge] Screen on page 50*.

[Reduce/Enlarge] Screen

Provides additional reduction/enlargement options.

NOTE: The options displayed on this screen vary depending on the selected paper size series.

Proportional %

- Text box - Allows you to enter a desired reduction/enlargement ratio using the scroll buttons. You can also enter the value by touching the text box and using the numeric keypad on the control panel. The value can be specified within the range of 25-400% in 1% increments.
- 100% - Copies at the same size as the original document.
- Auto % - Automatically reduces/enlarges the image of the document to fit on the paper size selected.
- Presets - Allows you to select from seven preset enlargement/reduction ratios. The presets are set up by the System Administrator.

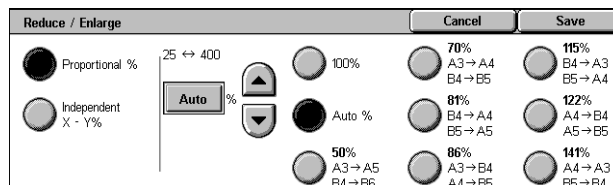

Independent X - Y %

Allows you to specify a reduction/enlargement ratio individually for the width and length within the range of 25-400% in 1% increments.

- Width - X%, Length - Y% - Allows you to enter the desired reduction/enlargement ratios for the width and length using the scroll buttons. You can also enter the values by touching the text boxes and using the numeric keypad on the control panel. The values can be specified within the range of 25-400% in 1% increments.
- Lock X - Y% - Specifies the same ratio adjustment for the width and length at the same time.
- Width:100%, Length:100% - Sets the reduction/enlargement ratio of both the width and length to 100%.
- Auto - Automatically specifies the reduction/enlargement ratio individually for the width and length to fit on the paper.
- Copy All X - Y% - Enables the [Auto] feature, and reduces the image of the document slightly from the reduction/enlargement ratio to copy the complete image of the document onto the paper.
- Width:50%, Length:100% - Sets the reduction/enlargement ratio of the width to 50% and that of the length to 100%.

NOTE: The above options are displayed when the paper size series is set to [A/B Series]. When [Inch Series] or other paper size series is selected, the options displayed will be different. For information on how to change the paper size series, refer to the Setup chapter in the System Administration Guide.

NOTE: When [Auto %] is selected, Tray 1 is automatically selected, even when [Auto Paper Select] is selected in [Paper Supply].

Paper Supply

The available paper trays are displayed on the touch screen together with the media size and orientation preset for each tray.

When changing the size or type of media in a tray, the tray must be reprogrammed by the System Administrator to match the media being loaded. For more information on reprogramming the tray, contact the System Administrator.

For information on the sizes and types of media supported by the machine, refer to the Paper and Other Media chapter in the System Administration Guide.

1. Select a preset button or [More] for the [Paper Supply] feature on the [Copy] screen.

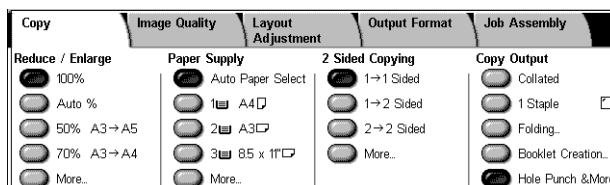

More

Displays the [Paper Supply] screen. For more information, refer to *[Paper Supply] Screen on page 51*.

[Paper Supply] Screen

Allows you to select a paper tray from the preset trays, including Tray 5 (Bypass).

Presets

Allows you to select a paper tray from the three preset trays set up by the System Administrator. The tray number, paper size, and paper orientation are also displayed for all trays.

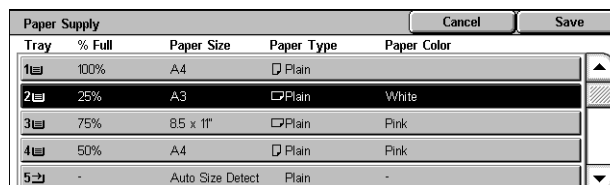

5 →

Displays the [Tray 5] screen when a paper size and type are not preset by the System Administrator. For more information, refer to *[Tray 5] Screen on page 51*.

Auto Paper Select

Allows you to select an appropriate tray automatically according to the document size, amount of reduction or enlargement, and related features settings.

NOTE: When [Paper Supply] is set to [Auto Paper Select], [Reduce/Enlarge] is automatically set to [100%] and [Auto %] cannot be selected.

[Tray 5] Screen

You can temporarily use Tray 5 (Bypass) to load paper that is unavailable from Trays 1-4. Up to a 10 mm (0.4 inch) stack of paper (approximately 95 sheets of 80 g/m² paper) can be loaded in Tray 5 (Bypass).

Paper Size

- Auto Size Detect - Detects the paper size automatically.
- Standard Size - Displays the preset paper sizes on the touch

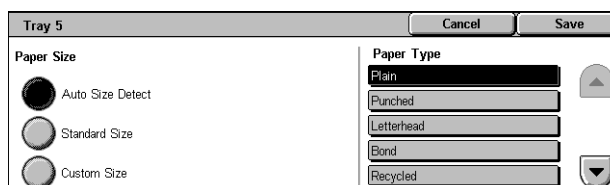

screen, and allows you to select a paper size. The presets are set up by the System Administrator.

- Custom Size - Allows you to specify the width and length of the paper size using the scroll buttons in 1 mm (0.1 inch) increments. The acceptable ranges of paper sizes are 89-297 mm (3.5-11.7 inches) for the width and 99-432 mm (3.9-17.0 inches) for the length.

Paper Type

Displays the preset paper types on the touch screen, and allows you to select the paper type. The presets are set up by the System Administrator. The setting is only temporary and applies only to the current copy job.

2 Sided Copying

This feature allows you to automatically make single or double-sided copies from single or double-sided documents.

NOTE: Before using the feature, specify the document orientation to indicate the top of the document in [Original Orientation] on the [Layout Adjustment] screen.

NOTE: The 2 Sided Copying option cannot be used with the following paper types: Transparency, Lightweight, Heavyweight, Labels, Bond, as well as paper already printed on one side.

1. Select a preset button or [More] for the [2 Sided Copying] feature on the [Copy] screen.

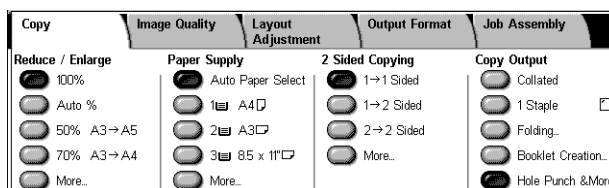

More

Displays the [2 Sided Copying] screen. For more information, refer to [2 Sided Copying] Screen on page 52.

[2 Sided Copying] Screen

Allows you to select the 2 sided copying options, document feed direction, and original orientation.

NOTE: When using the document glass for [1 → 2 Sided] or [2 → 2 Sided], the machine will display a message when it is ready to scan the next document.

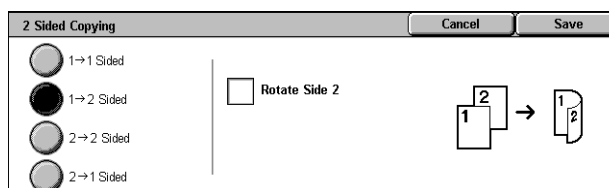

1 → 1 Sided

Makes single-sided copies from single-sided documents.

1 → 2 Sided

Makes double-sided copies from single-sided documents.

2 → 2 Sided

Makes double-sided copies from double-sided documents.

2 → 1 Sided

Makes single-sided copies from double-sided documents

Rotate Side 2

Rotates side 2 of the printouts head to toe.

NOTE: This check box is available for all options except [1 → 1 Sided].

Copy Output

This feature allows you to sort copy outputs. If an optional finisher has been installed, the stapling, hole-punching, and/or folding feature is also available. You can select the staple and/or hole-punch position on the copy output.

NOTE: The features displayed on the screen vary depending on whether a finisher is installed on your machine, whether the installed finisher is an Office Finisher LX or an Integrated Office Finisher, and what options are installed on the finisher.

NOTE: If the correct size paper is not loaded in the machine when the stapling and/or hole-punching feature is applied to a copy or print job, a paper size error may occur. When this happens, the finisher contains the wrong size paper already processed up to this point. If the machine displays a message saying that the paper loaded in a tray is different from the settings, open the finisher top cover, and remove the wrong size paper, load the correct size paper in the tray, and restart the job. If you simply replace the paper in a tray, and resume the job without removing the processed paper in the finisher, the machine will staple and/or hole punch the wrong size paper still in the finisher together with the correct size paper from the tray.

1. Select a preset button or [More] for the [Copy Output] feature on the [Copy] screen.

NOTE: The screen shown on the right is displayed when the Office Finisher LX is installed. If the

Integrated Office Finisher is installed, or if a finisher is not installed, the display will be different.

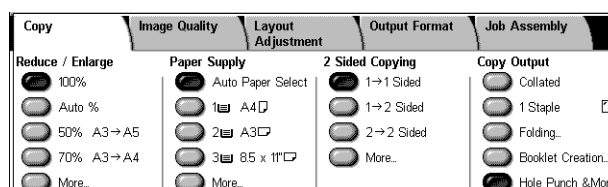
**Collated**

Delivers the specified number of copy sets in the same order as the documents. Other collation options are available on the [Copy Output] screen. For more information, refer to *[Copy Output] Screen on page 54*.

1 Staple

Attaches one staple to the top left corner of your output. Other stapling options are available on the [Copy Output] tab. For more information, refer to *[Copy Output] Screen on page 54*.

Folding

Displays the [Folding] screen where you can select a folding option for your output.

NOTE: When copying a document using this feature, wait until the copy job is completed before taking the copies out of the output tray.

- No Folding - Disables the Folding function.
- Single Fold - Makes a crease in each sheet of the outputs for easy folding.

Booklet Creation

Displays the [Booklet Creation] screen. This feature is identical to [Booklet Creation] on the [Output Format] tab. For information, refer to *Booklet Creation on page 62*.

Hole Punch & More

Displays the [Copy Output] Screen. For more information, refer to *[Copy Output] Screen on page 54*.

NOTE: [Hole Punch & More] appears when the Office Finisher LX is installed. When the Integrated Office Finisher is installed, or when a finisher is not installed, [More] is displayed instead.

[Copy Output] Screen

Allows you to select the staple and/or hole-punch position and sorting method for your output, and to specify the output tray.

NOTE: The screen shown on the right is displayed when the Office Finisher LX is installed. If the Integrated Office Finisher is installed, or if a finisher is not installed, the display will be different.

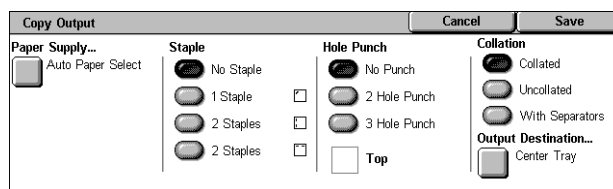

Paper Supply

Displays the [Paper Supply] screen. Select a paper tray for your copy job.

Staple

Allows you to specify the staple position.

- No Staple - Disables the feature.
- 1 Staple - Attaches one staple to the top left corner of the output.
- 2 Staples (Left) - Attaches two staples along the left edge of the output.
- 2 Staples (Top) - Attaches two staples along the top edge of the output.

NOTE: When the Integrated Office Finisher is installed, or when a finisher is not installed, the [2 Staples (Left)] and [2 Staples (Top)] options are not available.

Hole Punch

Allows you to specify the hole-punch position.

NOTE: When the Integrated Office Finisher is installed, or when a finisher is not installed, the [Hole Punch] options are not available.

- No Punch - Disables the feature.
- 2 Hole Punch - Punches two holes in the left edge of the output.
- 3 Hole Punch - Punches three holes in the left edge of the output.
- Top - Selecting [2 Hole Punch] or [3 Hole Punch] and this check box punches two holes or three holes in the top edge of the output.

NOTE: The above Hole Punch options are displayed when the 2 & 3 Hole Punch Unit is installed. When the 2 & 4 Punch Unit is installed, the options available are [No Punch], [2 Hole Punch], [4 Hole Punch], and [Top]. When the 4 Hole Punch Unit is installed, the options available are [No Punch], [4 Hole Punch], and [Top].

Collation

- Collated - Delivers the specified number of copy sets in the same order as the documents. For example, two copies of a three-page document are delivered in the order 1-2-3, 1-2-3.

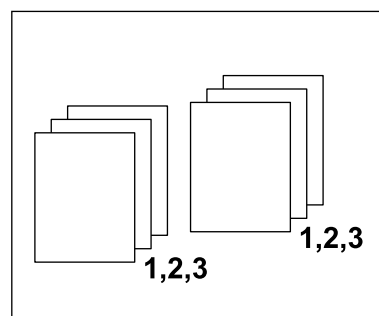

- Uncollated - Delivers the copies in stacks based on the number of copies required for each document. For example, two copies of a three-page document are delivered in the order 1-1, 2-2, 3-3. Stapling is not available when [Uncollated] is selected.

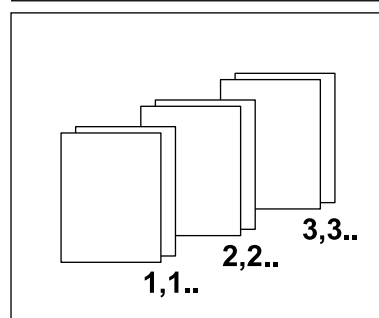

- With Separators - Delivers the copies in stacks, based on the number of copies required for each document, with a separator between each stack. Select the [Paper Supply] button to specify the paper tray containing the separator paper. Stapling is not available when [With Separators] is selected.

Output Destination

Displays the [Output Destination] screen. Select an output tray for the copy job.

Image Quality

This section describes the features used to adjust the quality of the output image. For more information on the features available, refer to the following:

Original Type – page 56

Image Options – page 56

Background Suppression – page 57

1. Press the <All Services> button on the control panel.
2. Select [Copy] on the touch screen.
3. Select the [Image Quality] tab.
4. Set the required feature.
5. Select [Save].

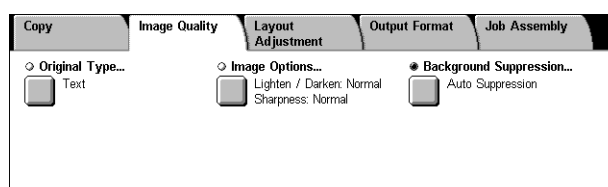

Original Type

This feature allows you to copy at optimum image quality by selecting the type of the original documents.

1. Select [Original Type] on the [Image Quality] screen.
2. Select the required option.
3. Select [Save].

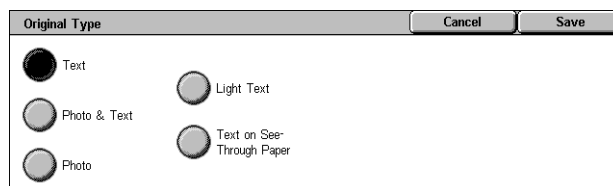

Text

Select this option to copy documents that contain text only, where the text must be copied crisply.

Photo & Text

Select this option to copy documents that contain both text and photographs. Text and photographs are automatically distinguished, and an appropriate quality mode is selected for individual areas.

Photo

Select this option to copy documents that contain photographs only.

Light Text

Select this option to copy documents that contain faint text, such as that written in pencil.

Text on See-Through Paper

Select this option to copy documents that use see-through paper.

NOTE: [Text on See-Through Paper] is available only when [System Settings] > [Copy Service Settings] > [Copy Control] > [Original Type - See-Through Paper] is enabled.

Image Options

This feature allows you to adjust the brightness and sharpness levels for copying documents.

1. Select [Image Options] on the [Image Quality] screen.
2. Select the required levels.
3. Select [Save].

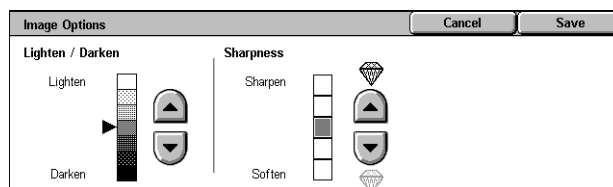

Lighten/Darken

Allows you to adjust the copy density using seven levels between [Lighten] and [Darken]. The copy density increases the nearer the level is to [Darken], and decreases the nearer the level is to [Lighten].

Sharpness

Allows you to adjust the copy sharpness using five levels between [Sharpen] and [Soften]. The sharpness of contours increases the nearer the level is to [Sharpen], and decreases the nearer the level is to [Soften].

Background Suppression

This feature suppresses background colors and image bleed-through when copying.

NOTE: This feature is not available when [Photo] is selected on the [Original Type] screen.

1. Select [Background Suppression] on the [Image Quality] screen.
2. Select the required options.
3. Select [Save].

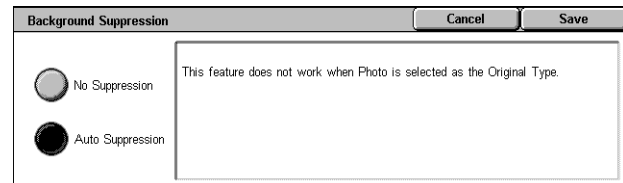

No Suppression

Disables the feature.

Auto Suppression

Automatically suppresses background colors.

Layout Adjustment

This section describes the layout adjustment features for copying. For more information on the features available, refer to the following:

Book Copying – page 57

2 Sided Book Copying – page 58

Original Size – page 59

Edge Erase – page 59

Image Shift – page 60

Image Rotation – page 60

Invert Image – page 61

Original Orientation – page 61

1. Press the <All Services> button on the control panel.
2. Select [Copy] on the touch screen.
3. Select the [Layout Adjustment] tab. Use the side tabs to switch between screens.
4. Select the required feature.

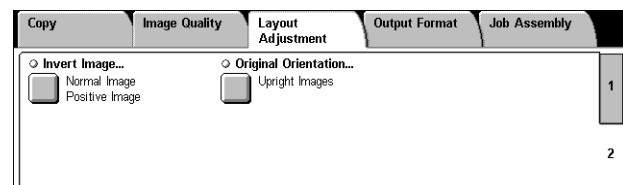
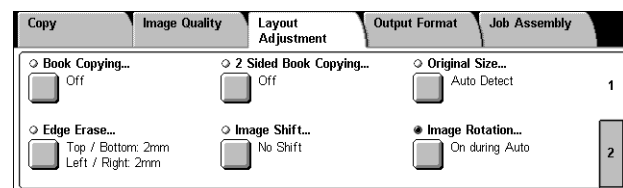

Book Copying

This feature allows you to copy facing pages of a bound document in the correct page sequence using the document glass. The two pages will be copied onto two separate pages.

1. Select [Book Copying] on the [Layout Adjustment] screen.
2. Select the required options.
3. Select [Save].

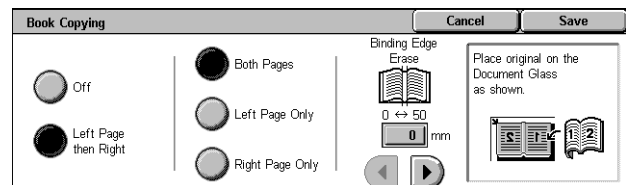

NOTE: The facing pages of a bound document must be placed in a horizontal orientation on the document glass.

Off

Disables the feature.

Left Page then Right

Copies pages of an open book in the direction from left to right.

- Both Pages - Copies both the left and right pages.
- Left Page Only - Copies the left pages only.
- Right Page Only - Copies the right pages only.

Binding Edge Erase

Erases printing of the center binding area of the book that tends to be shadowed due to the fold in the pages. Use the scroll buttons to specify the area to be erased from the center of an open book within the range of 0-50 mm (0.0-2.0 inches) in 1 mm (0.04 inch) increments.

2 Sided Book Copying

This feature allows you to make double-sided copies in the same order and image layout as the original bound document, using the document glass. A blank sheet is automatically inserted as the first page.

1. Select [2 Sided Book Copying] on the [Layout Adjustment] screen.
2. Select the required options.
3. Select [Save].

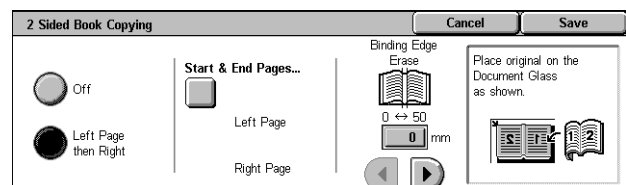

NOTE: This feature and the [Book Copying] or [Build Job] feature cannot be activated simultaneously.

Off

Disables the feature.

Left Page then Right

Copies both pages of an open book in the direction from left to right.

Start & End Pages

Displays the [Starting & Ending Pages] screen where you can specify the start page and the end page for copying. The page sides must be specified using the bound original.

Binding Edge Erase

Erases printing of the center binding area of the book that tends to be shadowed due to the fold in the pages. Use the scroll buttons to specify the area to be erased from the center of an open book within the range of 0-50 mm (0.0-2.0 inches) in 1 mm (0.04 inch) increments.

Original Size

This feature allows you to set the size of the document automatically, to select from a list of preset sizes, or to mix different size documents. If you select a preset size, documents will be copied according to the specified size regardless of their actual size.

1. Select [Original Size] on the [Layout Adjustment] screen.
2. Select the required option.
3. Select [Save].

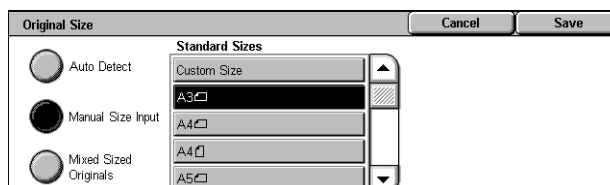

Auto Detect

Automatically detects the size of standard sized documents.

Manual Size Input

Allows you to select the input size from the 11 preset standard sizes in portrait or landscape orientations, or select a custom size within the ranges of 15-297 mm (0.6-11.7 inches) for length and 15-432 mm (0.6-17.0 inches) for width. The presets are set up by the System Administrator.

Mixed Sized Originals

Allows you to copy more than one original size document. The machine senses the mixed sized originals automatically, and copies each document at the same size as the originals. Load different size documents, with top left corners aligned, into the Document Feeder.

NOTE: 5.5 × 8.5" and A5 originals must be loaded in portrait orientation.

NOTE: Confirm that the orientation of the documents and the [Original Orientation] setting on the [Layout Adjustment] screen are the same.

Edge Erase

This feature allows you to erase unwanted marks such as hole-punch marks from each edge of the copy.

NOTE: Make sure that the orientation of the documents and the [Original Orientation] setting on the [Layout Adjustment] screen are the same.

1. Select [Edge Erase] on the [Layout Adjustment] screen.
2. Select the required options.
3. Select [Save].

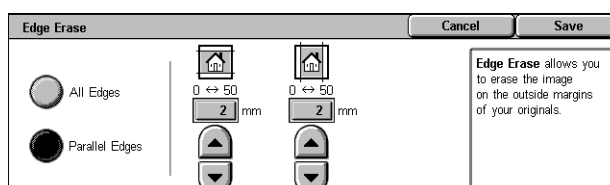

All Edges

Erases the same amount from all four edges of your document. If you do not want to erase any edges, select [Parallel Edges] and select 0.0 using the scroll buttons.

Parallel Edges

Allows you to specify the edge erase amounts for top and bottom and/or left and right edges. Up to 50 mm (2 inches) can be erased from each edge.

Image Shift

This feature allows you to change the position of the image on the output copy paper.

NOTE: Make sure that the orientation of the documents and the [Original Orientation] setting on the [Layout Adjustment] screen are the same.

NOTE: The amount of the image shift depends on the size of paper loaded in the machine.

NOTE: When [Mixed Sized Originals] is selected, the amount shifted is determined by the image position of the first sheet, and is applied to all subsequent sheets of the documents.

1. Select [Image Shift] on the [Layout Adjustment] screen.
2. Select the required option.
3. Select [Save].

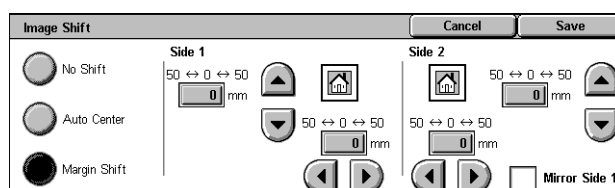

No Shift

Disables the feature.

Auto Center

Automatically places the image in the center of the copy paper.

Margin Shift

Moves the image by specified amounts on the copy paper in the Up/Down and Left/Right directions. You can enter up to 50 mm (2 inches) for both dimensions.

If your machine is configured to make double-sided copies, you can select the options below for both Side 1 and Side 2.

- Side 1 - Allows you to move the image on Side 1. You can specify an offset of up to 50 mm (2 inches) for both dimensions using the scroll buttons.
- Side 2 - Allows you to move the image on Side 2. You can specify an offset of up to 50 mm (2 inches) for both dimensions using the scroll buttons.
- Mirror Side 1 - Automatically shifts the image on Side 2 to mirror Side 1.

Image Rotation

This feature allows you to automatically rotate the image to match the orientation of the paper in the tray.

1. Select [Image Rotation] on the [Layout Adjustment] screen.
2. Select the required option.
3. Select [Save].

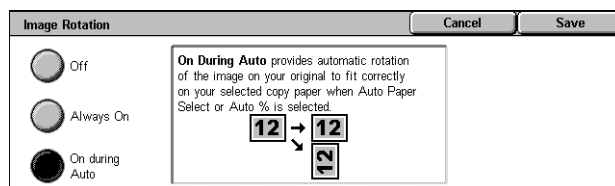

Off

Disables the feature.

Always On

Automatically rotates the image, as required, to fit on the selected copy paper.

On during Auto

Automatically rotates the image, as required, to fit on the selected copy paper. This feature is available only when [Auto Paper Select] is selected in the [Paper Supply] feature or [Auto %] is selected in the [Reduce/Enlarge] feature.

Invert Image

This feature allows you to mirror the image, and to make negatives of the image on the copy output.

1. Select [Invert Image] on the [Layout Adjustment] screen.
2. Select the required options.
3. Select [Save].

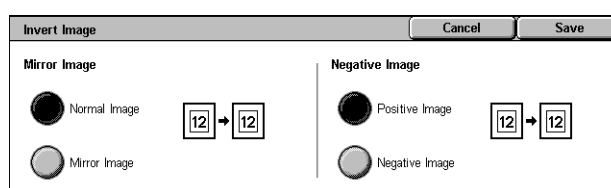
**Mirror Image**

Allows you to create a mirror image of the document.

- Normal Image - Select this option for normal image output.
- Mirror Image - Creates a mirror image of the original for the copy output.

Negative Image

Allows you to create a negative image of the document.

- Positive Image - Select this option for normal positive image output.
- Negative Image - Creates a negative image of the original for the copy output. All the black images on the page will be inverted to white, and all the white images will be inverted to black.

Original Orientation

This feature allows you to specify the orientation of the documents. The document orientation must be specified before using the [Image Shift], [Edge Erase], [Multiple-Up], [Repeat Image], [Annotations], and [Booklet Creation] features.

1. Select [Original Orientation] on the [Layout Adjustment] screen.
2. Select the required option.
3. Select [Save].

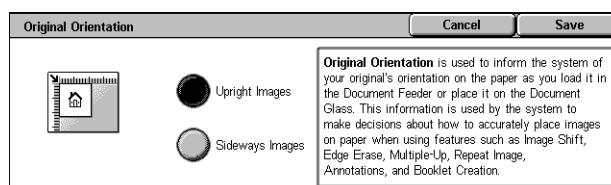
**Upright Images**

Selects the vertical orientation, where the top of the document is orientated towards the back of the machine.

Sideways Images

Selects the horizontal orientation, where the top of the document is orientated towards the left of the machine.

Output Format

This section describes features that enhance the appearance of a copy job. For more information on the features available, refer to the following:

Booklet Creation – page 62

Covers – page 65

Transparency Options – page 65

Page Layout – page 66

Poster – page 67

Annotations – page 68

Watermark – page 70

ID Card Copying – page 71

1. Press the <All Services> button on the control panel.
2. Select [Copy] on the touch screen.
3. Select the [Output Format] tab. Use the side tabs to switch between screens.
4. Select the required feature.
5. Select [Save].

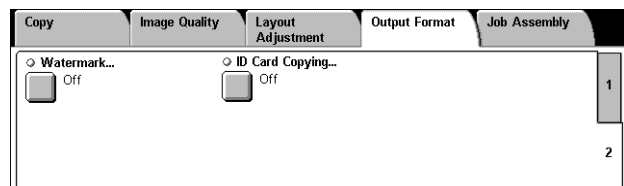
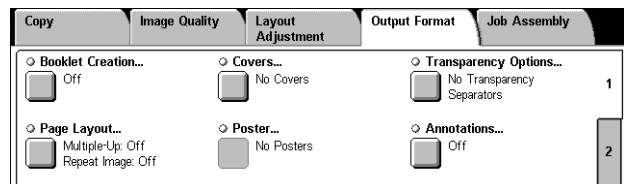

Booklet Creation

This feature allows you to create multi-page booklets from a set of 1 or 2 sided originals. It reduces and correctly positions each image to produce output that, when folded, will be ordered to read like a booklet.

NOTE: If the number of document pages is a multiple of four, the booklet will not have blank pages. Otherwise the extra pages in the book will be blank.

NOTE: This feature is available only when [Collated] is selected in [Copy Output].

NOTE: Wait until the copy job is completed before taking copies out of the output tray.

1. Select [Booklet Creation] on the [Output Format] screen.
2. Select the required options.
3. Select [Save].

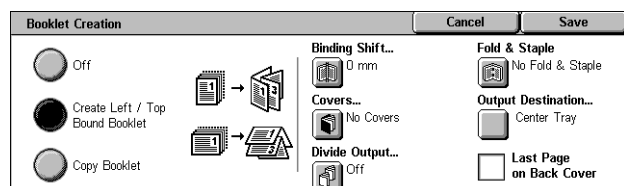

Off

Disables the feature.

Create Left/Top Bound Booklet

Makes a booklet from a document. Images are automatically placed in a sequence that, when folded, the copies are bound at the top or left edge of the output.

Copy Booklet

Allows you to copy booklet sheets by maintaining the order of the images. The [Fold and Staple] option binds the copies to create the same type of booklet as the original one.

Binding Shift

Displays the [Booklet Creation - Binding Shift] screen. For more information, refer to *[Booklet Creation - Binding Shift] Screen on page 63*.

Covers

Displays the [Booklet Creation - Covers] screen. For more information, refer to *[Booklet Creation - Covers] Screen on page 63*.

Divide Output

Displays the [Booklet Creation - Divide Output] screen. For more information, refer to *[Booklet Creation - Divide Output] Screen on page 64*.

Fold & Staple

Displays the [Booklet Creation - Fold & Staple] screen. For more information, refer to *[Booklet Creation - Fold & Staple] Screen on page 64*.

Output Destination

Displays the [Output Destination] screen. Select an output tray for your copy job.

Last Page on Back Cover

Uses the last page of the original document as the back cover of the booklet. When using [Divide Output] to separate booklets, the cover will be the last page of the last subset.

[Booklet Creation - Binding Shift] Screen

Allows you to specify the amount of inside margin in 1 mm (0.04 inch) increments between 0 to 50 mm (0.0-2.0 inches) using the scroll buttons on the screen or the numeric keypad on the control panel.

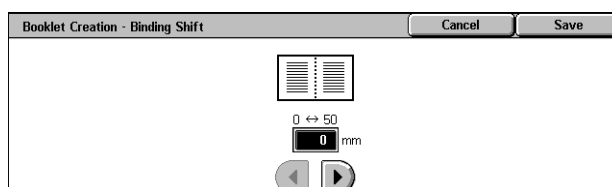

[Booklet Creation - Covers] Screen

Allows you to add a cover sheet to the booklet. When the output is folded in half to make a booklet, the cover will be on both the front and back.

Off

Makes a booklet without a cover sheet.

On

Adds a cover sheet to the booklet from the cover stock tray. When selected, the [Covers] option becomes available.

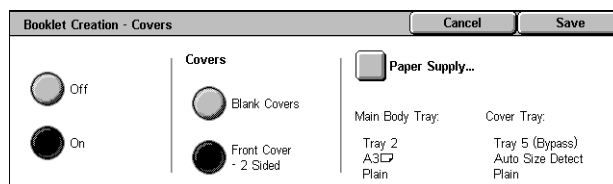
**Covers**

- Blank Covers - Adds a blank cover to the booklet.
- Front Cover - 2 Sided - Copies the first and last pages of the document onto the cover stock. Add blank sheets to the set of documents if you want the inside front and back covers to remain blank.

Paper Supply

Displays the [Booklet Creation - Covers - Paper Supply] screen. Select one of the presets to specify [Main Body Tray] and [Cover Tray]. The paper loaded in the trays selected for [Main Body Tray] and [Cover Tray] should be the same size and in landscape orientation. For more information on Tray 5 (Bypass), refer to [Tray 5] Screen on page 51.

Depending on the trays installed on the machine, the name of this button may be different.

[Booklet Creation - Divide Output] Screen

Allows you to subdivide a large booklet into many booklets.

Off

Disables the feature.

On

Subdivides the booklet into subsets.

Enter the number of sheets in each subset using the scroll buttons. You can also enter the number by touching the text box and using the numeric keypad on the control panel.

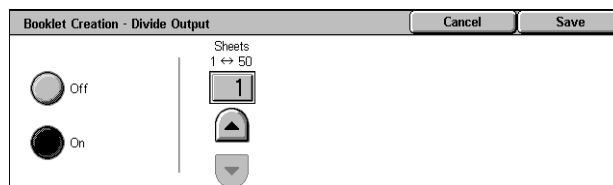
**[Booklet Creation - Fold & Staple] Screen**

Allows you to fold and staple the booklet.

No Fold & Staple

Disables the Fold and Staple features.

Fold Only

Makes a crease in each sheet of the booklet for easy folding.

Fold & Staple

Makes a crease in each sheet of the booklet for easy folding, and staples the sheets.

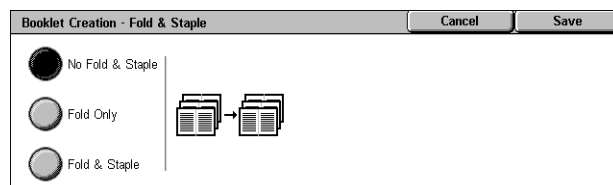

Covers

This feature allows you to add a front and/or back cover to a copy job.

NOTE: If the machine's memory becomes full while scanning a document with this feature enabled, follow the instructions on the screen to cancel the job. Delete the stored documents, or reduce the amount of pages to free some memory and try again.

NOTE: This feature is unavailable when [Uncollated] or [With Separators] is selected in [Copy Output].

1. Select [Covers] on the [Output Format] screen.
2. Select the required options.
3. Select [Save].

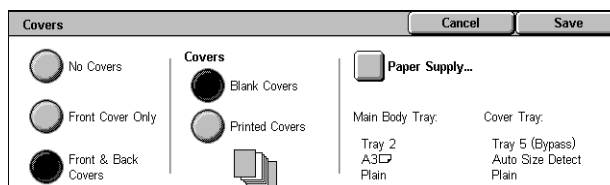

No Covers

Disables the feature.

Front Cover Only

Inserts a front cover page before the first page of the document. A different paper type than the main body pages can be used.

Front & Back Covers

Inserts cover pages before the first page and after the last page of the document. A different paper type than the main body pages can be used.

Covers

- Blank Covers - Adds a blank cover to the documents.
- Printed Covers - Copies the first and last pages of the documents onto the cover stock. Add blank sheets to the set of documents if you want the inside front cover and inside back cover to remain blank.

Paper Supply

Displays the [Covers - Paper Supply] Screen. Select one of the presets to specify the [Main Body Tray] and [Cover Tray]. The paper loaded in the trays selected for [Main Body Tray] and [Cover Tray] should be the same size and orientation. For more information on Tray 5 (Bypass), refer to *[Tray 5] Screen on page 51*.

Depending on the trays installed on the machine, the name of this button may be different.

Transparency Options

This feature allows you to place blank page separators between documents when copying onto transparency stock, and to make hard copy sets for handouts. Handouts can be 1 sided or 2 sided and stapled.

1. Select [Transparency Options] on the [Output Format] screen.
2. Select the required option.
3. Select [Save].

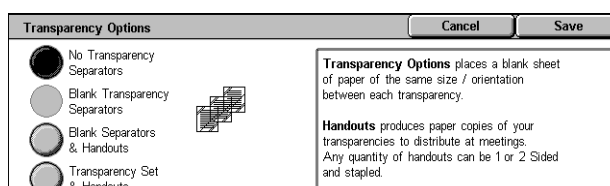

No Transparency Separators

Disables the feature.

Blank Transparency Separators

Places a blank page separator between each transparency sheet. Only one set of copies is made.

NOTE: This feature is not available when [1 → 2 Sided] or [2 → 2 Sided] is selected in [2 Sided Copying].

Blank Separators & Handouts

Copies one set of transparencies with blank page separators, and the required number of sets of paper copies for handouts.

Transparency Set & Handouts

Copies one set of transparencies with no page separators, and the required number of sets of paper copies for handouts.

Paper Supply

Displays the [Transparency Options - Paper Supply] screen. Select one of the presets to specify the [Transparency Tray] and the [Handout Tray]/[Separator & Handout Tray]. For more information on Tray 5 (Bypass), refer to *[Tray 5] Screen on page 51*.

Depending on the trays installed on the machine, the name of this button may be different.

Page Layout

This feature allows you to copy two, four or eight images onto one sheet of paper, or copy one image repeatedly onto one sheet of paper. The machine automatically reduces/enlarges the images as needed to print them on one page.

1. Select [Page Layout] on the [Output Format] screen.
2. Select the required option.
3. Select [Save].

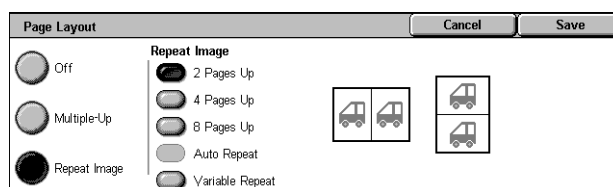

Off

Disables the feature.

Multiple-Up

- 2 Pages Up - Copies two pages of the document onto one sheet of paper.
- 4 Pages Up - Copies four pages of the document onto one sheet of paper.
- 8 Pages Up - Copies eight pages of the document onto one sheet of paper.
- Reading Order - Sets how to lay out the images on a page. For [4 Pages Up] or [8 Pages Up], you can select either horizontal rows from left to right or vertical columns from left to right.

Repeat Image

- 2 Pages Up - Copies an image two times vertically or horizontally onto one sheet of paper.

- 4 Pages Up - Copies an image four times vertically or horizontally onto one sheet of paper.
- 8 Pages Up - Copies an image eight times vertically or horizontally onto one sheet of paper.
- Auto Repeat - Automatically calculates the number of times to repeat vertically or horizontally from document size, stock size, and the enlarge/reduction ratio.

NOTE: This feature is not available when [Auto %] is selected in [Reduce/Enlarge].

- Variable Repeat - Allows you to specify the number of times to repeat the image vertically or horizontally using the scroll buttons on the screen or the numeric keypad on the control panel. You can repeat an image between 1 to 23 times vertically, and between 1 to 33 times horizontally.

Poster

This feature allows you to divide and enlarge an original document to copy the image onto multiple sheets of paper. You can then paste them all together to make one large poster.

NOTE: This feature is available only when [1 → 1 Sided] is selected in [2 Sided Copying].

NOTE: This feature is unavailable when [Collated] is selected.

1. Select [Poster] on the [Output Format] screen.
2. Select the required option.
3. Select [Save].

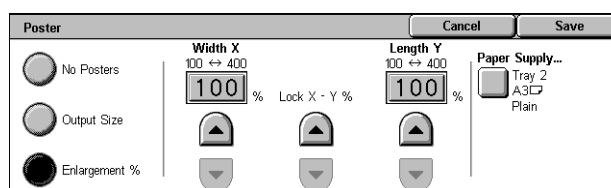

NOTE: The machine automatically overlaps partitioned images when copying to allow for cutting and pasting. The overlap width is set to 10 mm (0.4 inch).

No Posters

Disables the feature.

Output Size

Allows you to select the size of poster you want to make from the presets that are listed on the touch screen. The machine automatically calculates the magnification, and decides how many sheets are needed for the job.

Enlargement %

Use the scroll buttons on the screen or the numeric keypad on the control panel, to select the magnification rates for the length and width of a poster. The range can be set between 100-400% in 1% increments. The machine automatically decides how many sheets are needed for the job.

Paper Supply

Displays the [Poster - Paper Supply] screen. Select one of the presets on the screen to specify the tray for the job. For more information on Tray 5 (Bypass), refer to [Tray 5] Screen on page 51.

Annotations

This feature allows you to add the date, page numbers, and a predetermined phrase to the copy outputs.

1. Select [Annotations] on the [Output Format] screen.
2. Select the required option.
3. Select [Save].

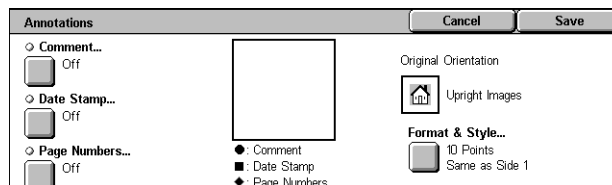

Comment

Displays the [Comment] screen. For more information, refer to *[Comment] Screen on page 68*.

Date Stamp

Displays the [Date Stamp] screen. For more information, refer to *[Date Stamp] Screen on page 68*.

Page Numbers

Displays the [Page Numbers] screen. For more information, refer to *[Page Numbers] Screen on page 69*.

Format & Style

Displays the [Format & Style] screen. For more information, refer to *[Format & Style] Screen on page 70*.

[Comment] Screen

Allows you to print a predetermined phrase, such as “Confidential” or “Draft”, on the output copies.

Off

Disables the feature.

Comment

Enables the feature.

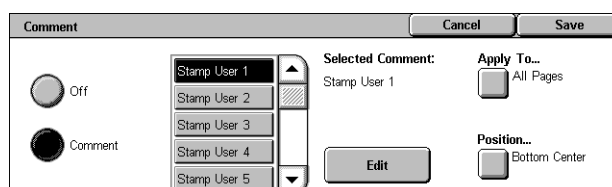

Selected Comment

Select the predetermined phrase you wish to print on the copies. To edit the phrase you selected, select the [Edit] button and use the screen keyboard.

Apply To

Displays the [Apply Comment To] screen. Select to print the comment on the [First Page Only], [All Pages], or [All Pages Except First].

Position

Displays the [Comment - Position] screen. Select the position to print the comment on each page.

[Date Stamp] Screen

Allows you to print the current date on the output copies.

Off

Disables the feature.

Date Stamp

Enables the feature.

Format

Select the date format from [dd/mm/20yy], [mm/dd/20yy], and [20yy/mm/dd].

Apply To

Displays the [Apply Date Stamp To] screen. Select to print the date on the [First Page Only], [All Pages], or [All Pages Except First].

Position

Displays the [Date Stamp - Position] screen. Select the position to print the date on each page.

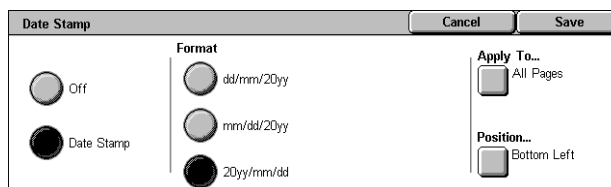
**[Page Numbers] Screen**

Allows you to print page numbers or page numbers with a prefix on the output copies.

Off

Disables the feature.

Page Numbers

Allows you to print page numbers on the output copies.

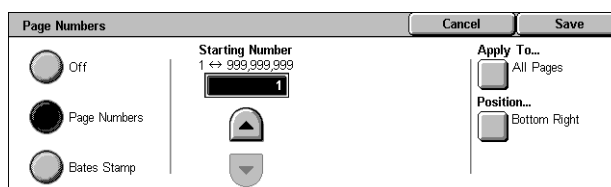

- Starting Number - Allows you to enter a start number using the scroll buttons or the numeric keypad.
- Apply To - Displays the [Apply Page Numbers To] screen. Select pages which require page numbers. The options available are [All Pages] and [All Pages Except First].
- Position - Displays the [Page Numbers - Position] screen. Select the position to print the page number on each page.

Bates Stamp

Allows you to print page numbers with a prefix on the output copies.

- Edit - Select this button and enter a prefix for page numbers using the displayed keypad. Or select the desired prefix from the list of registered prefixes.
- Apply To - Displays the [Apply Bates Stamp To] screen. Select pages which require page numbers and specify the start number. The options available are [All Pages] and [All Pages Except First].
- Position - Displays the [Page Numbers - Position] screen. Select the position to print a page number on each page.
- Number of Digits - Displays the [Bates Stamp - Number of Digits] screen. On this screen, you can specify the number of digits for page numbers. Leading zeros will be added to make up the number of digits if manually specified. You can specify up to 9 digits.

[Format & Style] Screen

Font Size

Allows you to specify the font size of the date, page numbers, and comments using the scroll buttons on the screen or the numeric keypad on the control panel, within the range of 6 to 18 points in 1 point increments.



Side 2 Options

Allows you to specify the position of the date, page numbers, and comments on Side 2 to [Same as Side 1] or [Mirror Side 1].

Watermark

This feature allows you to add a watermark beneath the original image of the copy output. Information such as a control number, predetermined text, date and time, and the machine serial number can be added.

1. Select [Watermark] on the [Output Format] screen.
2. Select the required option.
3. Select [Save].

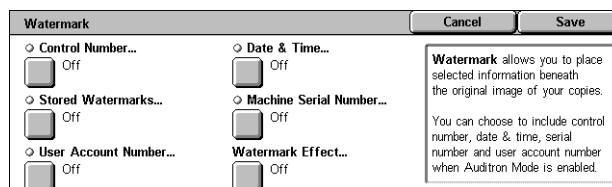

Control Number

Displays the [Watermark - Control Number] screen. This option prints sequential control numbers on each copy set. The following options are available:

- Off - Disables the feature.
- On - Enables the feature. Specify a start number between 1 and 999 using the scroll buttons. You can also enter the number by touching the text box and using the numeric keypad on the control panel.

Stored Watermarks

Displays the [Stored Watermarks] screen. This option prints a predetermined phrase on the output copies. The following options are available:

- Off - Disables the feature.
- On - Enables the feature. Select from the predetermined phrases set up by the System Administrator.

User Account Number

Prints your account number on the copies.

NOTE: This feature is displayed only when the Authentication feature is enabled.

- Off - Disables the feature.
- On - Enables the feature.

Date & Time

Displays the [Watermark - Date & Time] screen. This option prints the date and time on each of the output copies. Select [On] to enable the feature.

Machine Serial Number

Displays the [Watermark - Machine Serial Number] screen. This option prints the serial number of the machine on the output copies. Select [On] to enable the feature.

Watermark Effect

Displays the [Watermark Effect] screen. This option embeds the text strings specified in [Control Number], [Stored Watermarks], [User Account Number], [Date & Time], and [Machine Serial Number] on all copies. If you make copies of your output, the embedded text strings will be printed with the text effect you select here. The following options are available:

- Off- Disables the feature.
- Embossed - If you make copies of your output, the embedded text will appear embossed.
- Outline - If you make copies of your output, the embedded text will be visible in white.

ID Card Copying

This feature allows you to copy both the front and back side of an ID card or any document whose size cannot be detected automatically onto the same side of paper.

1. Select [ID Card Copying] on the [Output Format] screen.
2. Select the required option.
3. Select [Save].

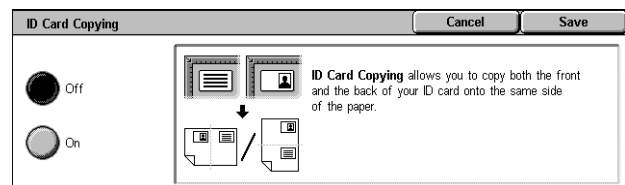

Off

Disables the feature.

On

Enables the feature. Copy the front side of an ID card as usual. Then, turn the card over without changing its position, and copy its back side.

NOTE: To capture the whole image of the ID card, make sure to place the card slightly away from the top left corner of the document glass.

Job Assembly

This section describes the job assembly features. For more information on the features, refer to the following:

Build Job – page 72

Sample Job – page 74

Combine Original Sets – page 74

Form Overlay – page 75

Delete Outside/Delete Inside – page 75

1. Press the <All Services> button on the control panel.
2. Select [Copy] on the touch screen.
3. Select the [Job Assembly] tab.
4. Set the required options.
5. Select [Save].

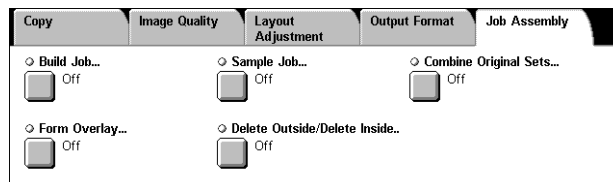

Build Job

This feature allows you to merge individual job sets with different features programmed. For example, if a job consists of some sections with text and some with photos, you can select the appropriate settings to be applied to each section, and then print them at one time.

NOTE: This feature is available only when [Collated] is selected in [Copy Output].

NOTE: Use the side bar to switch between screens.

1. Select [Build Job] on the [Job Assembly] screen.
2. Select the required options. Use the side tabs to switch between screens.
3. Select [Save].

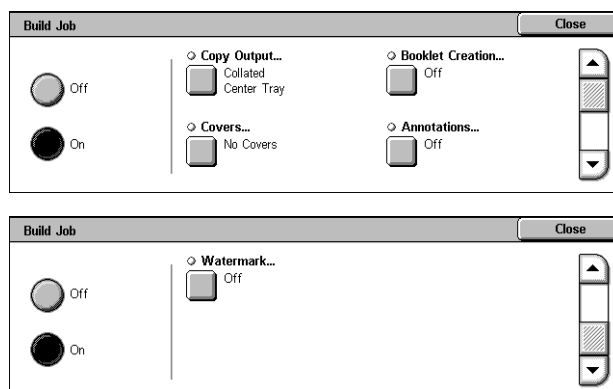

Off

Disables the feature.

On

Enables the feature. Allows you to select the output features that will be applied to the entire job.

Copy Output

Displays the [Copy Output] screen for the build job. For more information, refer to *[Copy Output] Screen on page 54*.

Booklet Creation

Displays the [Booklet Creation] screen for the build job. For more information, refer to *Booklet Creation on page 62*.

Covers

Displays the [Covers] screen for the build job. For more information, refer to *Covers on page 65*.

Annotations

Displays the [Annotations] screen for the build job. For more information, refer to *Annotations on page 68*.

Watermark

Displays the [Watermark] screen for the build job. For more information, refer to *Watermark on page 70*.

[Copy Job] Screen

The [Copy Job] screen appears after each job set while the Build Job is being executed.

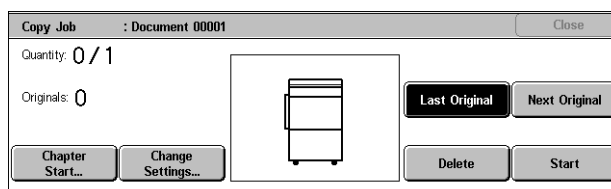

Stop

Stops the build job in progress. This button is displayed while the job is being built and printed.

Chapter Start

Displays the [Build Job - Chapter Start/Segment Separators] screen. The following options are available.

- Off - Disables the feature.
- Chapter Start - Automatically splits each batch of originals into chapters, starting on a new page. Using the [Multiple-Up - New Page] option sets whether to print the first page in each stack of originals on a new page or on the same page as the previous original when the Multiple-Up feature is selected.
- Segment Separators - Automatically splits each batch of originals into chapters with a separator page between each chapter. Select [Segment Separators], and specify the tray containing the blank page separators. For more information on Tray 5 (Bypass), refer to *[Tray 5] Screen on page 51*.

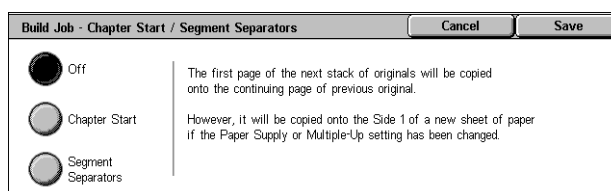

Change Settings

Allows you to change the settings on the [Copy] screen before scanning the next section. Press the <Start> button on the control panel to start scanning.

Last Original

Indicates the current scan batch is the last in a job to be scanned.

Next Original

Sequentially scans more sections in the same scan job.

Delete

Cancels the build job process.

Start

Starts scanning the next section.

Sample Job

This feature allows you to print one set of the job to check the output is correct, prior to printing the entire job. You can choose whether or not to print more sets after checking the print result.

1. Select [Sample Job] on the [Job Assembly] screen.
2. Select the required option.
3. Select [Save].

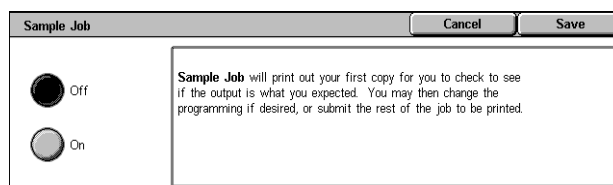
**Off**

Disables the feature.

On

Enables the feature. After copying one set, the job is suspended. Select [Start] to copy the remaining sets or [Stop] to stop the job.

NOTE: Copies produced by [Sample Job] are counted towards the total copy count.

Combine Original Sets

This feature allows you to divide lengthy originals into smaller groups that can be loaded into the document feeder in smaller quantities at a time.

NOTE: This feature is available only when [Collated] is selected in [Copy Output].

1. Select [Combine Original Sets] on the [Job Assembly] screen.
2. Select the required option.
3. Select [Save].

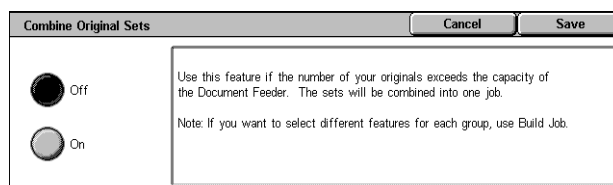
**Off**

Disables the feature.

On

Enables the feature. Select [Next Original] on the screen to process the next group. Select [Last Original] when all documents have been scanned.

NOTE: Use [Build Job] if you want to select different features for each group.

Form Overlay

This feature scans and stores an image on the first page of your document, and overlays the image onto the rest of the document.

For example, if the first page of your document contains a header and footer, the header and footer can be copied onto the subsequent pages.

1. Select [Form Overlay] on the [Output Format] screen.
2. Select the required option.
3. Select [Save].

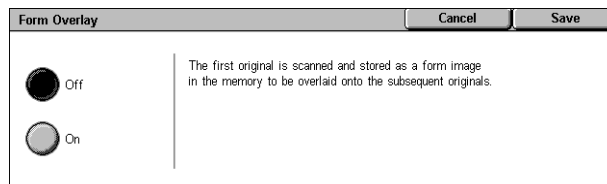

Off

Disables the feature.

On

Enables the feature.

Delete Outside/Delete Inside

This feature allows you to delete everything inside or outside a specified area.

1. Select [Delete Outside/Delete Inside] on the [Job Assembly] screen.
2. Select the required options.
3. Select [Save].

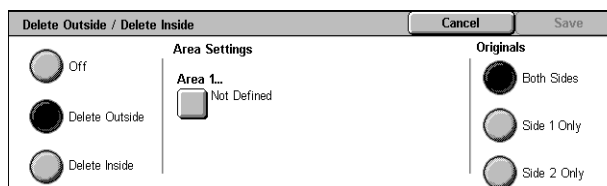

Off

Disables the feature.

Delete Outside

Deletes everything outside the specified areas when copying.

Delete Inside

Deletes everything inside the specified areas when copying.

Area 1

Displays the [Delete Outside/Delete Inside - Area 1] screen. For more information, refer to *[Delete Outside/Delete Inside - Area 1] screen on page 76*.

Originals

Select the side from which to delete for 2 Sided originals.

- Both Sides - Deletes on both sides.
- Side 1 Only - Deletes from Side 1 only.
- Side 2 Only - Deletes from Side 2 only.

[Delete Outside/Delete Inside - Area 1] screen

Allows you to specify the area for the [Delete Outside/Delete Inside] feature. The area is defined by the rectangle formed between the points X1,Y1 and X2,Y2.

1. Select [Area 1] on the [Delete Outside/Delete Inside] screen.
2. Touch a text box, and then enter a coordinate value using the numeric keypad.
3. Repeat step 2 for the other text boxes.
4. Select [Save].

0 ↔ 432 mm

X1 mm

Y1 mm

X2 mm

Y2 mm

Clear Area 1

Clear Area 1

Deletes the values entered in the text boxes.

4 Fax

This chapter contains information on the fax screens and the fax services available.

In addition to the conventional Fax service, the machine offers you the Direct Fax, Internet Fax, and Server Fax services.

Direct Fax allows you to transmit faxes directly from PC clients. Internet Fax allows you to send scanned images by e-mail over the Internet or intranet. Server Fax allows you to send and receive scanned data to and from a fax server over a network using the SMB, FTP, or SMTP protocol.

For more information on Fax, Internet Fax, and Server Fax, refer to the System Administration Guide.

For more information on Direct Fax, refer to the online help provided for the print driver.

NOTE: Some models do not support all or some of the fax services mentioned above.

NOTE: Some of the features described in this chapter are optional, and may not apply to your machine configuration.

NOTE: Internet Fax can be enabled when the Fax Kit and the Internet Fax Kit are installed on the machine.

NOTE: Server Fax can be enabled when the Server Fax Kit is installed on the machine. Some models require also the Network Scanning Kit to enable Server Fax.

NOTE: Before using Internet Fax or Server Fax, you must connect the machine to a network and set up the network environment. For details, refer to the Internet Fax and Server Fax chapters in the System Administration Guide.

Country Code for the Fax Service

When using the Fax service, users in the following countries may be required to set the country code for the fax line.

NOTE: Fax connection approval depends on the country.

Argentina	Austria	Belgium	Brazil	Bulgaria
Canada	Chile	Cyprus	Czech Republic	Denmark
Egypt	Finland	France	Germany	Greece
Hungary	Iceland	India	Ireland	Italy
Luxembourg	Mexico	Morocco	Netherlands	Norway
Peru	Poland	Portugal	Romania	Russia
Saudi Arabia	Slovakia	South Africa	Spain	Sweden
Switzerland	Turkey	UAE	UK	Ukraine
USA	former Yugoslavian republics			

1. Press the <Log In/Out> button on the control panel.
2. Enter the correct user ID using the numeric keypad on the control panel or the screen keyboard.

NOTE: The default System Administrator ID is “11111”. If the Authentication and Accounting feature is enabled, you may also be required to enter a passcode. The default passcode is “x-admin”. To change the default user ID or passcode, refer to the System Administration Guide.

3. Press the <Machine Status> button on the control panel.
4. Select the [Tools] tab on the Machine Status screen.
5. Under [System Settings], select [Common Service Settings].
6. Select [Other Settings].
7. Scroll down and select [Country].
8. Select the required country. After saving the settings, the machine reboots automatically.

NOTE: This setting is only available with the fax options for the countries stated above.

Fax Procedure

This section describes the basic procedure for sending faxes, Internet Faxes, and Server Faxes. Follow the steps below:

1. *Load the Documents – page 78*
2. *Select the Features – page 79*
3. *Specify a Destination – page 80*
4. *Enter an E-mail Subject and Message (for Internet Fax Only) – page 81*
5. *Start the Fax Job – page 81*
6. *Check the Status of the Fax Job – page 82*
Stopping a Fax Job – page 82

NOTE: If the Authentication and Accounting feature is enabled, you may be required to enter a user ID and passcode (if one is set up) before using the machine. For further information, contact the System Administrator.

1. Load the Documents

The following explains how to load documents using the document feeder or the document glass.

The maximum capacity of the document feeder is shown below:

Document Type (Weight)	Capacity
Lightweight (38-49 g/m ²)	75 sheets
Plain (50-80 g/m ²)	75 sheets
Heavyweight (81-128 g/m ²)	50 sheets

The documents can be any size from 139.7 to 297 mm (4.9 to 11.7 inches) for the width and 210 to 432 mm (4.5 to 17 inches) for the length, and the standard sizes of 5.5 x 8.5" SEF/LEF to 7.25 x 10.5" SEF/LEF. When sending a fax, you can scan up to 297 mm (11.7 inches) in width and 432 mm (17.3 inches) in length (or 600 mm/23.5 inches if 60-90 g/m² paper is used) in 1-sided mode. You can also use the document glass to scan documents if required.

This machine is capable of scanning mixed size originals using the document feeder. Align the documents against the inner corner of the document feeder and enable the [Mixed Size Originals] feature. For more information, refer to *Mixed Sized Originals on page 97*.

NOTE: A paper jam may occur if custom sized originals are loaded in the document feeder, and the [Original Size] feature on the [Layout Adjustment] tab is set to [Auto Detect]. In that case, entering a custom paper size is recommended. For more information, refer to *Original Size on page 97*.

Load documents face up in the document feeder or face down on the document glass.

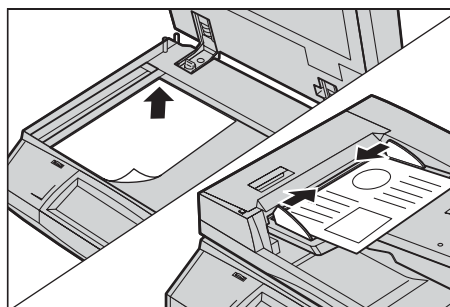

NOTE: The long fax document scan feature has the following limitations.

- Only available when using the document feeder.
- Not available in 2-sided mode.

NOTE: In both 1-sided and 2-sided modes, scanning a document at its original size or smaller is recommended. An enlarged image may be cut off during transmission.

NOTE: When using the document glass, make sure that the touch screen is ready before placing a document on the document glass. If you place the document on the document glass before the touch screen is ready, the paper size may not be detected correctly.

2. Select the Features

1. Make sure that the desired fax service is enabled in the System Administration mode.

NOTE: The Fax and Server Fax services cannot be enabled concurrently. When your machine has both Fax and Server Fax, Server Fax is automatically enabled by default. To enable Fax, switch the fax service mode to Fax in the System Administration mode. When your machine has Internet Fax, it is automatically enabled when Fax is enabled. For information on how to switch between Fax and Server Fax in the System Administration mode, refer to the Setups chapter in the System Administration Guide.

2. Press the <All Services> button on the control panel.

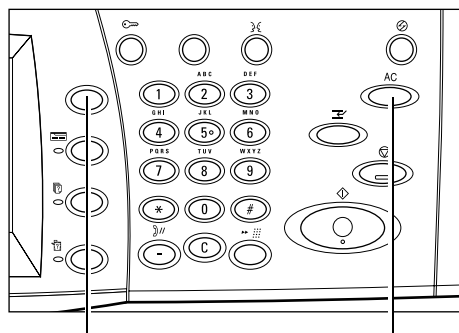

<All Services> button

<Clear All> button

3. Select [Fax] or [Internet Fax] on the touch screen to display the corresponding screen.

NOTE: The [Fax] icon on the All Services screen is for the Fax or Server Fax service depending on the fax service selected in the System Administration mode. For how to switch between Fax and Server Fax in the System Administration mode, refer to the Setups chapter in the System Administration Guide.



NOTE: If the Authentication and Accounting feature is enabled, you may be required to enter the user ID and passcode (if one is set up). If you need assistance, contact the System Administrator.

NOTE: Only those features relevant to the machine configuration will be available on the screen.

4. Press the <Clear All> button once on the control panel to cancel any previous selections.
5. Set the required features on each tab.

For information on the features on each tab, refer to the following:

Specifying Fax Destinations – page 83

Specifying Internet Fax Destinations – page 89

Specifying Server Fax Destinations – page 92

General Settings - Fax/Internet Fax/Server Fax – page 94

Layout Adjustment - Fax/Internet Fax/Server Fax – page 97

Fax Options - Fax – page 99

More Fax Options - Fax – page 105

Internet Fax Options - Internet Fax – page 108

Fax Options - Server Fax – page 112

3. Specify a Destination

The following explains how to specify a destination. The machine allows the following dialing methods (fax numbers or e-mail addresses):

For Fax:

- Using the numeric keypad on the control panel to enter a fax number directly
- Using the [New Recipients] feature (refer to *New Recipients on page 83*)
- Using the [Address Book] feature (refer to *on page 86*)

- Using the <Speed Dial> button on the control panel (refer to *Speed Dial on page 87*)

For Internet Fax:

- Using the [New Recipients] feature (refer to *New Recipients on page 89*)
- Using the [Address Book] feature (refer to *Address Book on page 90*)

For Server Fax:

- Using the numeric keypad on the control panel to enter a number directly
- Using the [New Recipients] feature (refer to *New Recipients on page 92*)
- Using the [Address Book] feature (refer to *Address Book on page 93*)

1. Enter the destination using any method from the above.

You can send a document to multiple destinations in a single operation.

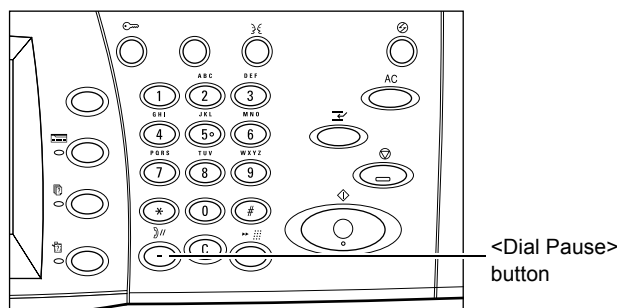

If you need to insert a pause in a fax number, for example when using a calling card, press the <Dial Pause> button. When dialing manually, <Dial Pause> is not required. You can simply wait for a voice prompt and proceed accordingly. For more information, refer to *Special Characters on page 84*.

4. Enter an E-mail Subject and Message (for Internet Fax Only)

You can enter an e-mail subject and message for Internet Fax transmission.

For details, refer to *Subject on page 91* and *Message on page 91*.

5. Start the Fax Job

1. Press the <Start> button to send the documents.

You can select [Next Original] displayed on the touch screen during scanning to indicate there are more original documents to scan. This allows you to scan several documents and transmit the data together as a single job.

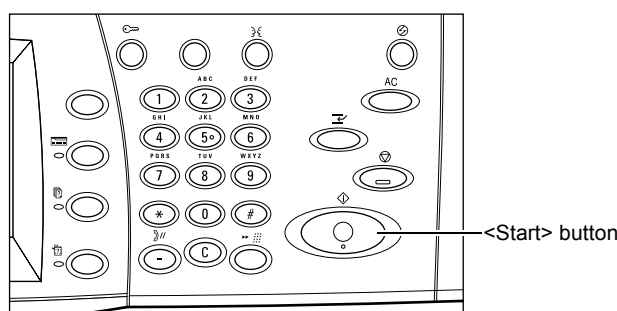

While your fax/Internet Fax is being processed, if the document feeder or document glass is ready, you can scan the next document or program the next job.

6. Check the Status of the Fax Job

1. Press the <Job Status> button on the control panel to display the Job Status screen.

The queued fax job will be displayed. If the job is not displayed on the screen, it may have already been processed.

Untransmitted jobs are displayed on the [Active Jobs] screen, and are printed in the [Transmission Report - Job Undelivered] report.

For more information, refer to the Job Status chapter in the System Administration Guide.

Active Jobs				Completed Jobs	Secure Print Jobs & More	Print Waiting Jobs	View by Job Type
#	Owner	Name	Status				
001	-	Copy	- Printing				
002	-	File 123	00002 Job in Progress				
003	-	FTP Transfer	00003 Transferring				
004	-	Fax Send	00005 Sending				

Stopping a Fax Job

Follow the steps below to manually cancel an active fax job.

1. Press the <Stop> button on the control panel to suspend the fax job while a document is being scanned.

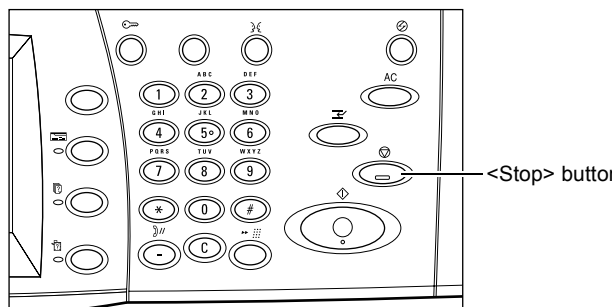

2. If required, press the <Job Status> button on the control panel to display the Job Status screen. To exit the Job Status screen, press the <Features> button.

Active Jobs				Completed Jobs	Secure Print Jobs & More	Print Waiting Jobs	View by Job Type
#	Owner	Name	Status				
001	-	Copy	- Printing				
002	-	File 123	00002 Job in Progress				
003	-	FTP Transfer	00003 Transferring				
004	-	Fax Send	00005 Sending				

3. On the [Stop/Pause] screen displayed, select [Cancel Scanning] to delete the suspended fax job.

NOTE: To resume the job, select [Resume Scanning] on the [Stop/Pause] screen.

Specifying Fax Destinations

This section describes how to specify destinations using the Fax service. For more information, refer to the following:

New Recipients – page 83

Address Book – page 86

Cover Page – page 87

1. Make sure that the Fax service is enabled.
2. Press the <All Services> button on the control panel.
3. Select [Fax] on the All Services screen. Select the [Fax] tab, if not displayed already.

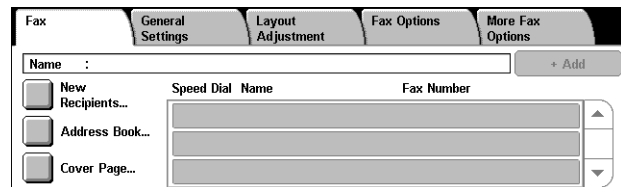

NOTE: You can specify destinations from any tab using the numeric keypad or the <Speed Dial> button on the control panel.

NOTE: To add another recipient after specifying a recipient, you can use the numeric keypad or the <Speed Dial> button on the control panel, or the [+ Add] or [Address Book] button on the [Fax] screen.

NOTE: To remove a recipient from the recipient list, or to view the details of a recipient in the list, select the recipient on the touch screen to display a pop-up menu, and then select the required option from the menu.

New Recipients

This feature allows you to enter one or more fax destinations using a screen keyboard.

1. Select [New Recipients] on the [Fax] screen.
2. Select keys on the screen to enter the required information.
3. Select [Close].

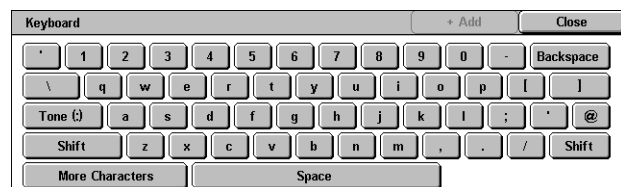

+ Add

Allows you to enter a new address. The maximum number of destinations that you can designate at one time is 200.

Tone (:)

Switches between pulse dialing and tone dialing.

Shift

Switches between uppercase and lowercase letters.

More Characters

Displays symbol keys on the screen. For information on using symbols in fax numbers, refer to *Special Characters on page 84*. Select the [Standard Characters] button on the displayed screen to return to the standard keyboard screen.

Backspace

Deletes the last character entered.

Relay Broadcast

You can use the machine's relay broadcasting feature to send a document to a remote machine, which then sends the document to multiple destinations registered in the remote machine for speed dialing. This can reduce transmission cost when the destinations are out of town or located in another country because you only need to send the document to the broadcasting machine.

The remote machine that broadcasts your document to multiple destinations is referred to as a relay station. You can specify multiple relay stations, or even ask the first station to relay your document to the secondary relay station, which then broadcasts the document to other destinations.

The following methods are available for relay broadcasting.

Fax Signals

The machine provides a unique method only for Xerox machines that have the relay broadcasting feature. Before sending a document, the remote machine that broadcasts your document needs to be registered as a relay station in a speed dial code on your machine. For more information on registering relay stations for speed dialing, refer to the Setups chapter in the System Administration Guide.

DTMF

You can manually enter DTMF codes as part of a fax number to specify a relay station and destinations that also understand DTMF codes. G3-compatible machines that allow manual sending can initiate relay broadcasting to the machine. For more information, refer to *Special Characters on page 84*.

F Code

Machines that support F Code and relay broadcasting features allow relay broadcasting operations using F Code. For more information, refer to *F Code on page 104*.

Special Characters

You can enter special characters as part of a fax number to perform many functions when dialing the number. Some characters are used only when auto dialing, such as “.”, “!”, “/”, “-”, and “=”. Depending on the setup of the telephone and communication lines, some or all of the following characters can be used.

Character	Function	Description
-	Dial pause (to pause while dialing)	Inserts a pause in a fax number, for example when you are using a calling card. Press the <Dial Pause> button more than once to enter a longer pause.
/	Mask data (to protect confidential information)	Select [/] before and after entering confidential information to display as asterisks (*). This character must be preceded with “!” to be effective.
\	Screen mask	Masks the mailbox passcodes on the screen with asterisks (*). Select [\] before and after entering a mailbox passcode.

Character	Function	Description
:	Pulse-to-tone switch	Switches pulse dialing to tone dialing, for example when using an automated message recording system that requires tone signals.
'	Speed dial or group code	Indicates a 3-digit speed dial or group code. Place this character before and after the code.
< >	Communication line switch	Switches communication lines that include parameter data, where the parameter data include characters "0" to "9" or " ". The parameter data must be placed between angle brackets ("<" and ">"). If G3-3CH is installed, entering either <1>, <2>, or <4> prior to specifying the fax destination switches the communication lines.
=	Dial tone detection	Suspends dialing until a dial tone is detected.
S	Password check (for remote machine identification)	Use this character to verify that the correct number has been entered. The machine checks if the password you entered after "S" matches the fax number of the remote machine. If the match is confirmed, the machine sends the document.
<i>space</i>	Readability improvement	Improves readability by inserting spaces in a fax number, for example "1 234 5678" instead of "12345678".
!	Start DTMF code signaling	Pauses regular fax dialing, and starts the DTMF (dual tone multi-frequency) method for sending documents to mailboxes on the remote machines.
\$	Wait for DTMF confirmation	Wait for a DTMF confirmation signal from the remote machine and proceed to the next step.

DTMF Method - Examples

The DTMF method uses combinations of special characters to send documents. See the following examples.

- Remote Mailbox - Sends a document to a mailbox on a remote machine.

Fax number of remote machine	!*\$	Mailbox number of remote machine	##\	Mailbox passcode	\###\$
------------------------------	------	----------------------------------	-----	------------------	--------

- Polling - Retrieves a document stored in a mailbox on a remote machine.

Fax number of remote machine	!*\$	Mailbox number of remote machine	**\	Mailbox passcode	\###\$
------------------------------	------	----------------------------------	-----	------------------	--------

- Relay Broadcast - Sends a document to a relay station which in turn sends it to multiple destinations.

Fax number of remote machine	!*\$#	Relay Send Number (RSN) of relay station	\#	Speed dial code for first destination	#	Speed dial code for second destination	##\$
------------------------------	-------	--	----	---------------------------------------	---	--	------

- Remote Relay Broadcast - Sends a document via multiple relay stations. The last station broadcasts the document to the specified destinations.

Fax number of remote machine	!*\$# \	Relay Send Number (RSN) of primary relay station	\#	Speed dial code for secondary relay station	#	Speed dial code for first destination	#	Speed dial code for second destination	##\$
------------------------------	---------	--	----	---	---	---------------------------------------	---	--	------

Address Book

This feature allows you to select the destinations registered in the Address Book for speed dialing. The destinations in the Address Book are listed by the speed dial codes they are assigned. For information on how to register destinations for speed dialing, refer to the System Administration Guide.

1. Select [Address Book] on the [Fax] screen.
2. Select the required destination, and then select [Add →] to add it to the [Recipient(s)] field. Repeat this step to select all the required destinations.
3. Select [Close].

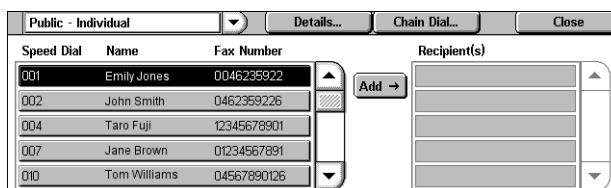

Pull-down menu

Switches between [Public - Individual] and [Public - Group]. [Public - Individual] lists individual fax recipients. [Public - Group] lists group numbers.

Details

Displays the screen that shows the details of a selected recipient. Selecting the [Fax Number In Full] button displays the details of the [Fax Number].

Chain Dial

Displays a screen that allows you to select recipients for chain dialing. Select a recipient, and then select [Add →] to add it to the [Recipient(s)] field. You can also enter a new recipient number using the numeric keypad on the control panel. After selecting or entering all the required recipients, select [Save].

Speed Dial/Name/Fax Number

Lists the fax recipient information registered in the Address Book. For information about the speed dialing feature and how to enter a speed dial code, refer to *Speed Dial on page 87*.

Add →

Adds a selected fax recipient to the [Recipient(s)] field.

Recipient(s)

Lists the selected fax recipients. Touching a selected fax recipient pops up a menu allowing you to remove the recipient or view its details.

Speed Dial

This feature allows you to select a destination quickly using the 3-digit code assigned to it. An asterisk (*) on the screen keyboard or the control panel can be used to specify multiple speed dial codes and a pound sign (#) to designate a group code.

Speed Dial Code	Result
123	Dials the destination assigned to the speed dial code 123.
12*	Dials the speed dial codes 120-129. The asterisk (*) represents all numbers from 0 to 9.
***	Dials all speed dial codes registered in the machine.
#01	Dials the group code 01. A group code is a speed dial code that can contain up to 20 destinations and begins with a pound sign (#). Up to 50 group codes can be registered.

For information on how to register speed dial codes, refer to the Setups chapter in the System Administration Guide.

1. Press the <Speed Dial> button.
2. Enter a 3-digit code.

NOTE: If the 3-digit code entered is correct, the destination is displayed. If it is incorrect, you are prompted to enter the correct 3-digit code.

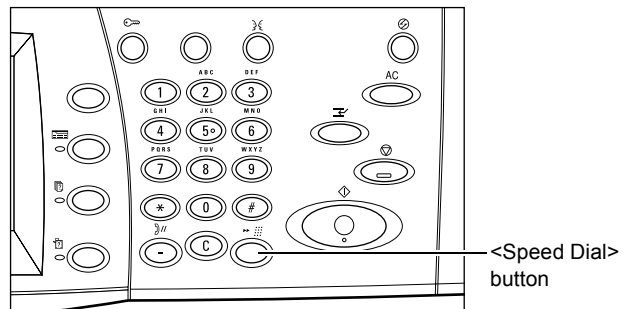

Cover Page

This feature allows you to add a cover page to the document. A cover page includes the following information: destination name, sender name, fax number, page quantity, time and date, and comments.

1. Select [Cover Page] on the [Fax] screen.
2. Select the required option.

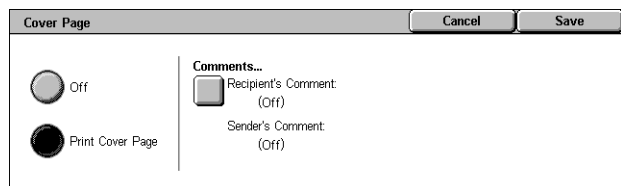

Off

Disables the feature.

Print Cover Page

Attaches a cover page. When you select this option, [Comments] is displayed at the right side of the screen.

Comments

Displays the [Cover Page - Comments] screen where you can add a comment to the recipient field and/or sender field on the fax cover sheet.

[Cover Page - Recipient's Comment] Screen

Allows you to add a comment to the recipient field on the fax cover sheet.

No Report

Does not add a comment to the recipient field on the fax cover sheet.

Comment

Adds a comment to the recipient field on the fax cover sheet.

Select Comment

Allows you to select a comment from the list of comments already registered. Use the scroll buttons to scroll through the list.

For information on how to register comments, refer to the Setups chapter in the System Administration Guide.

[Cover Page - Sender's Comment] Screen

Allows you to add a comment to the sender field on the fax cover sheet.

No Report

Does not add a comment to the sender field on the fax cover sheet.

Comment

Adds a comment to the sender field on the fax cover sheet.

Select Comment

Allows you to select a comment from the list of comments already registered. Use the scroll buttons to scroll through the list.

For information on how to register comments, refer to the Setups chapter in the System Administration Guide.

Specifying Internet Fax Destinations

This section describes how to specify destinations when using the Internet Fax service to send scanned images as e-mail attachments. For more information, refer to the following:

New Recipients – page 89

Address Book – page 90

From – page 91

Subject – page 91

Message – page 91

1. Make sure that Internet Fax is enabled.
2. Press the <All Services> button on the control panel.
3. Select [Internet Fax] on the All Services screen. Select the [Internet Fax] tab, if not displayed already.

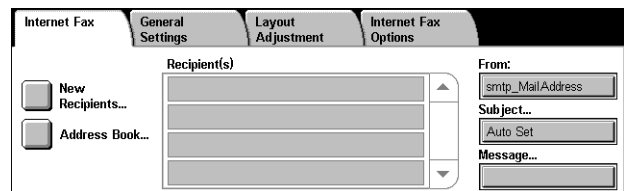

New Recipients

This feature allows you to specify one or more e-mail addresses using a keyboard.

1. Select [New Recipients] on the [Internet Fax] screen.
2. Select keys on the screen to enter the required information.
3. Select [Close].

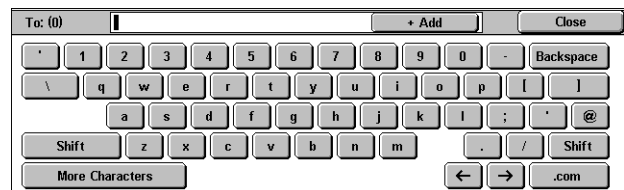

+ Add

Allows you to enter a new address. The maximum number of destinations that you can designate at one time is 200.

Backspace

Deletes the last character entered.

Shift

Switches between uppercase and lowercase letters.

More Characters

Displays symbol keys on the screen. For information on using symbols in fax numbers, refer to *Special Characters on page 84*. Select the [Standard Characters] button on the displayed screen to return to the standard keyboard screen.

Remote Mailbox

You can directly specify a mailbox on a remote machine as an Internet Fax destination.

To send an Internet Fax document to a remote mailbox, specify the destination e-mail address as follows.

BOX123@wcm128.xerox.com

Where:

BOX: The fixed string that represents “mailbox”

123: The mailbox number

wcm128: The host name of the remote machine that the mailbox resides in

xerox.com: The domain where the remote machine is hosted

Relay Broadcast

You can use the machine’s relay broadcasting feature to send a document to a remote machine, which then sends the document to multiple destinations registered in the remote machine. This can reduce transmission cost when the destinations are out of town or located in another country because you only need to send the document to the broadcasting machine.

The remote machine that broadcasts your document to multiple destinations is referred to as a relay station. You can specify multiple relay stations, or even ask the first station to relay your document to the secondary relay station, which then broadcasts the document to other destinations.

You can send an Internet Fax document to an Internet Fax-capable relay station in a network, which converts the document to a regular fax and broadcasts it to destinations without an Internet Fax capability.

To send an Internet Fax document for relay broadcasting, specify the relay station’s e-mail address as follows.

FAX=1234567890/T33S=777@wcm128.xerox.com

Where:

1234567890: The destination’s fax number

777: The destination’s F Code (if required)

wcm128: The host name of the relay station

xerox.com: The domain where the relay station is hosted

NOTE: To use this feature, the relay station must be configured to use an SMTP server to receive e-mail.

Address Book

This feature allows you to select the destinations registered in the Address Book. For information on how to register destinations, refer to the Setups chapter in the System Administration Guide.

1. Select [Address Book] on the [Internet Fax] screen.
2. Select the required destination, and then select [Add →] to add it to the [Recipient(s)] list. Repeat this step to select all the required destinations.
3. Select [Close].

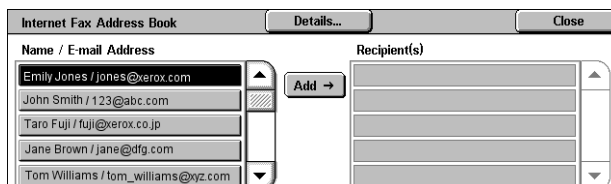

Details

Displays the details of a selected destination. Selecting the [E-mail Address In Full] button on the screen displays the details of the [Internet Fax Recipient].

Name/E-mail Address

Lists the e-mail destinations registered in the Address Book.

Add →

Adds a selected destination to the [Recipient(s)] list.

Recipient(s)

Lists the selected fax recipients. Touching a selected recipient pops up a menu allowing you to remove the selected recipient or view its details.

From

Displays the [From] screen, which displays the sender's e-mail address.

1. Select [From] on the [Internet Fax] screen.

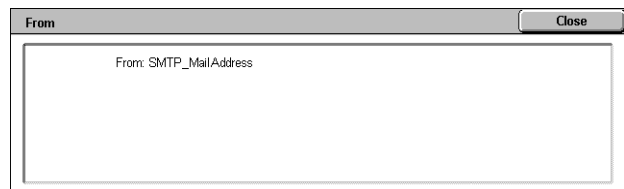
**Subject**

The [Subject] button allows you to enter an e-mail subject for your Internet Fax.

1. Select [Subject] on the [Internet Fax] screen.
2. Enter an e-mail subject.

NOTE: The default subject can be set by the System Administrator. For information on the setting, refer to the Setups chapter in the System Administration Guide.

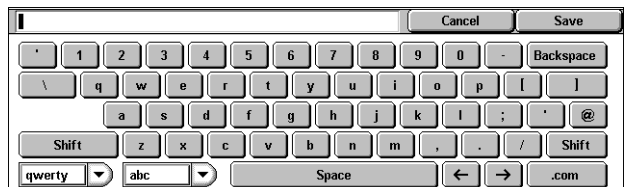
**Keyboard layout pull-down menu**

The pull-down menu at the bottom left corner of the screen board allows you to select a keyboard layout from [qwerty], [azerty], and [qwertz].

Character type pull-down menu

The pull-down menu at the left-hand side of the [Space] key allows you to select a character type from [abc], [áàä], and [¶ ± ©].

Message

The [Message] button allows you to add an e-mail message for Internet Fax. Information such as an authorized name and address, the number of scanned pages, the scanned size, and IP address and serial number of the machine is automatically added to the comment.

1. Select [Message] on the [Internet Fax] screen.
2. Enter the comment to be added to the e-mail.

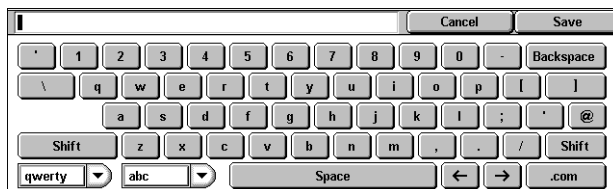

Specifying Server Fax Destinations

This section describes how to specify destinations when using the Server Fax service. For more information, refer to the following:

New Recipients – page 92

Address Book – page 93

NOTE: When the SMTP protocol is used for the Server Fax service, the e-mail settings configured in the System Administration mode apply to faxes sent via the Server Fax service. The following e-mail settings, however, do not apply to Server Fax: [Read Receipts], [Reply To], [Encryption], and [Digital Signature].

1. Make sure that the Server Fax service is enabled.
2. Press the <All Services> button on the control panel.
3. Select [Fax] on the All Services screen. Select the [Fax] tab, if not displayed already.

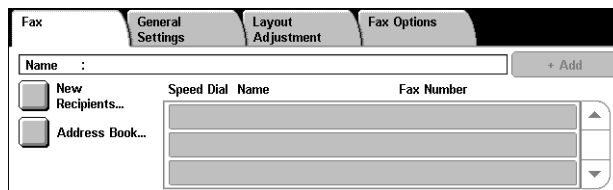

New Recipients

This feature allows you to enter one or more fax destinations using a screen keyboard.

1. Select [New Recipients] on the [Fax] screen.
2. Select keys on the screen to enter the required information.
3. Select [Close].

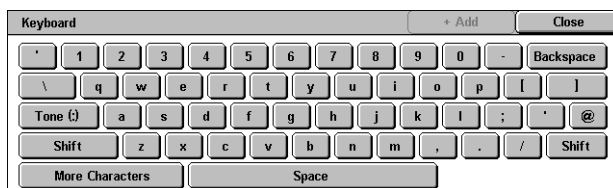

+ Add

Allows you to enter a new address. The maximum number of destinations that you can designate at one time is 50.

Tone (:)

Switches between pulse dialing and tone dialing.

Shift

Switches between uppercase and lowercase letters.

More Characters

Displays symbol keys on the screen. For information on using symbols in fax numbers, refer to *Special Characters on page 93*. Select the [Standard Characters] button on the displayed screen to return to the standard keyboard screen.

Backspace

Deletes the last character entered.

Relay Broadcast

You can use the machine's relay broadcasting feature to send a document to a remote machine, which then sends the document to multiple destinations registered in the remote machine for speed dialing. For more information, refer to *Relay Broadcast on page 84*.

Special Characters

You can enter special characters as part of a fax number to perform many functions when dialing the number. The following special characters are supported.

Character	Function	Description
-	Dial pause (to pause while dialing)	Inserts a pause in a fax number, for example when you are using a calling card. Press the <Dial Pause> button more than once to enter a longer pause.
\	Mask data (to protect confidential information)	Select [\] before and after entering confidential information.
#	Starting number	A starting number for a directory entry or a group code.
:	Pulse-to-tone switch	Switches pulse dialing to tone dialing, for example when using an automated message recording system that requires tone signals.
=	Dial tone detection	Suspends dialing until a dial tone is detected.
S	Password check (for remote machine identification)	Use this character to verify that the correct number has been entered. The machine checks if the password you entered after "S" matches the fax number of the remote machine. If the match is confirmed, the machine sends the document.
+	Readability improvement	Improves readability by inserting plus signs in a fax number, for example "1+234+5678" instead of "12345678".
space	Readability improvement	Improves readability by inserting spaces in a fax number, for example "1 234 5678" instead of "12345678".

Address Book

This feature allows you to select the destinations registered in the Address Book for speed dialing. The destinations in the Address Book are listed by the speed dial codes they are assigned. For information on how to register destinations for speed dialing, refer to the System Administration Guide.

1. Select [Address Book] on the [Fax] screen.
2. Select the required destination, and then select [Add →] to add it to the [Recipient(s)] field.
Repeat this step to select all the required destinations.
3. Select [Close].

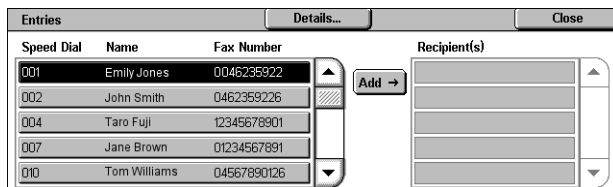

Details

Displays the screen that shows the details of a selected recipient.

Speed Dial/Name/Fax Number

Lists the fax recipient information registered in the Address Book.

NOTE: Server Fax supports group dialing. Server Fax, however, supports only group numbers registered on the Server Fax server, not those registered on the machine.

Add →

Adds a selected fax recipient to the [Recipient(s)] field.

Recipient(s)

Lists the selected fax recipients. Touching a selected fax recipient pops up a menu allowing you to remove the recipient or view its details.

General Settings - Fax/Internet Fax/Server Fax

This section describes the general image control features for a Fax/Internet Fax job. For information on the features available, refer to the following:

- Lighten/Darken – page 95*
- 2 Sided Scanning – page 95*
- Original Type – page 95*
- Resolution – page 96*

NOTE: The following default scan settings under [System Settings] > [Scan/Fax Service Settings] > [Scan Defaults] apply to faxes sent via the Server Fax service: [Lighten/Darken] and [Background Suppression].

1. Make sure that the desired fax service is enabled.
2. Press the <All Services> button on the control panel.
3. Select [Fax] or [Internet Fax] on the All Services screen.
4. Select the [General Settings] tab.
5. Select the required feature.

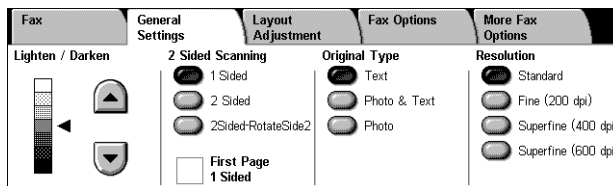

Lighten/Darken

This feature allows you to adjust the density of the scanned image using seven levels. Use the scroll buttons to increase or decrease the darkness.

1. Select a level for the [Lighten/Darken] feature on the [General Settings] screen.

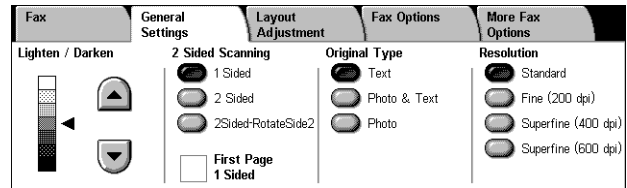

2 Sided Scanning

This feature allows you to specify whether your document is single-sided or double-sided, and how the document is to be positioned.

1. Select a preset button for the [2 Sided Scanning] feature on the [General Settings] screen.

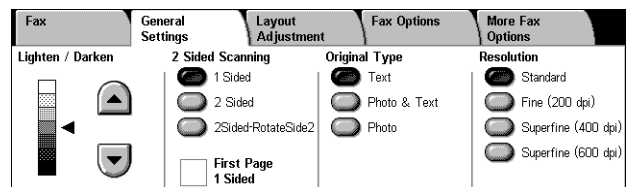

1 Sided

Scans one side of the document.

2 Sided

Scans both sides of the document. Select this option when the images of both sides of the document are in the same orientation.

2 Sided - Rotate Side 2

Scans both sides of the document. Select this option when the images of both sides of the document are in opposite orientations.

First Page 1 Sided

Skips scanning the back side of the first sheet of the document. This check box is selectable when [2 Sided] or [2 Sided - Rotate Side 2] is selected.

NOTE: The [First Page 1 Sided] option is not available for Server Fax.

Original Type

This feature allows you to select the type of your document.

1. Select a preset button for the [Original Type] feature on the [General Settings] screen.

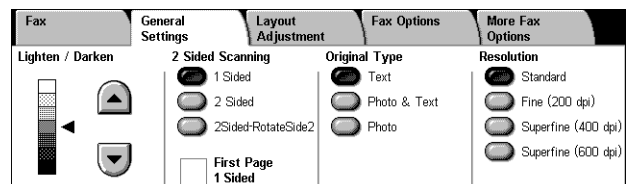

Text

Select this option for documents that contain text only.

Photo & Text

Select this option to scan documents that contain both text and photographs. Text and photographs are automatically distinguished, and an appropriate quality mode is selected for individual areas.

Photo

Select this option for documents that contain photographs only.

Resolution

This feature allows you to adjust the scan resolution of faxes the remote machine receives. A higher resolution yields better quality. A lower resolution reduces communication time.

NOTE: When the SMB or FTP protocol is used for the Server Fax service, the available options are [Standard] and [Fine (200 dpi)]. When the SMTP protocol is used, the available option is [Fine (200 dpi)] only. This [Resolution] setting applies to transmission from the machine to the Server Fax server. The resolution of data that is sent from the Server Fax server to a final destination depends on the resolution setting on the Server Fax server.

1. Select a preset button for the [Resolution] feature on the [General Settings] screen.

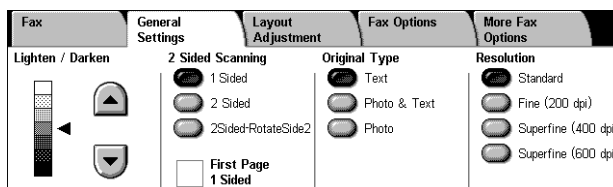

Standard

Scans documents at a resolution of 200 × 100 dpi. This option is recommended for text documents. It requires less communication time, but does not produce the best image quality for graphics and photographs.

Fine (200 dpi)

Scans documents at a resolution of 200 × 200 dpi. This option is recommended for line art and the best choice in most cases.

Superfine (400 dpi)

Scans documents at a resolution of 400 × 400 dpi. This option is recommended for photographs and halftone illustrations, or grayscale images. It requires more communication time, but produces higher image quality.

Superfine (600 dpi)

Scans documents at a resolution of 600 × 600 dpi. Use this option to produce the best image quality, but increased transmission time.

Layout Adjustment - Fax/Internet Fax/Server Fax

This section describes the layout adjustment features for a fax/Internet Fax job. For information on the features available, refer to the following:

Original Size – page 97

Book Faxing – page 98

Reduce/Enlarge – page 98

1. Make sure that the desired fax service is enabled.
2. Press the <All Services> button on the control panel.
3. Select [Fax] or [Internet Fax] on the touch screen.
4. Select the [Layout Adjustment] tab.
5. Select the required feature.

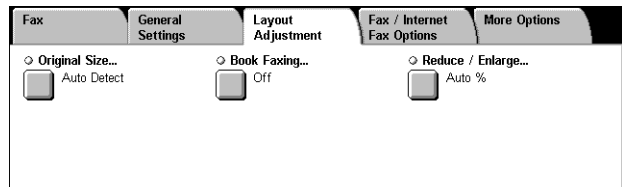

Original Size

This feature allows you to set the size of a document automatically, to select from a list of preset sizes, or to mix different sized documents. If you select a preset size, documents will be scanned according to that size regardless of their actual size.

1. Select [Original Size] on the [Layout Adjustment] screen.
2. Select the required option.
3. Select [Save].

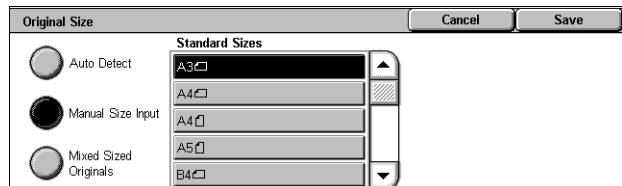

Auto Detect

Detects the size of documents automatically.

Manual Size Input

Allows you to select from 11 preset standard sizes in Portrait and Landscape orientations. The presets are set up by the System Administrator.

NOTE: Custom sizes cannot be set as presets.

Mixed Sized Originals

Allows you to scan more than one original size document into a single output set. The machine senses mixed sized originals automatically, and sends each document at the same size as the original. Load different size documents, with top left corners aligned, into the document feeder.

NOTE: 5.5 × 8.5" and A5 originals must be loaded in portrait orientation.

Book Faxing

This feature allows you to scan facing pages of a bound document in the correct page sequence using the document glass. The facing pages will be scanned as two separate pages.

1. Select [Book Faxing] on the [Layout Adjustment] screen.
2. Select the required options.
3. Select [Save].

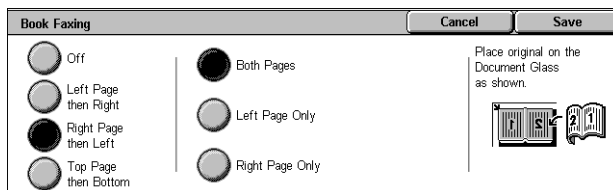

NOTE: The facing pages of a bound document must be placed in a horizontal orientation on the document glass.

Off

Disables the feature.

Left Page then Right

Scans pages of an open book in the direction from left to right.

- Both Pages - Scans both the left and right pages.
- Left Page Only - Scans the left pages only.
- Right Page Only - Scans the right pages only.

Right Page then Left

Scans pages of an open book in the direction from right to left.

- Both Pages - Scans both the left and right pages.
- Left Page Only - Scans the left pages only.
- Right Page Only - Scans the right pages only.

Top Page then Bottom

Scans pages of an open book in the direction from top to bottom.

- Both Pages - Scans both the top and bottom pages.
- Top Page Only - Scans the top pages only.
- Bottom Page Only - Scans the bottom pages only.

Reduce/Enlarge

This feature allows you to enlarge or reduce a scanned document by a specified ratio within the range of 25-400% before sending.

NOTE: The options displayed on this screen vary depending on the selected fax service. The following screen is that of the Server Fax service.

1. Select [Reduce/Enlarge] on the [Layout Adjustment] screen.
2. Specify a ratio using the arrow buttons, or select a preset button.
3. Select [Save].

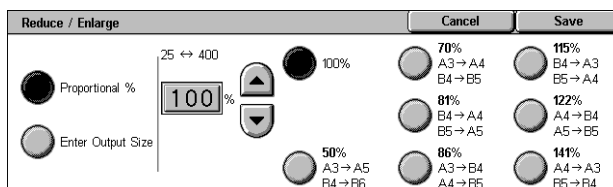

Proportional %

- Text box - Allows you to specify a desired reduction/enlargement ratio using the scroll buttons. You can also enter the value by touching the text box and using the numeric keypad on the control panel. The value can be specified within the range of 25-400% in 1% increments.
- 100% - Scans at the same size as the original document.
- Auto % - Automatically reduces/enlarges the image of the document to fit on the paper size selected on the remote machine, after scanning the document at its original size.

NOTE: The [Auto %] option is not available for Server Fax.

- Presets - Allows you to select a reduction/enlargement ratio from the seven preset ratios. The presets are set up by the System Administrator.

Enter Output Size

Allows you to select an output size from the standard paper sizes.

NOTE: The [Proportional %] and [Enter Output Size] buttons do not appear for Fax or Internet Fax. However, the options for [Proportional %] are available.

Fax Options - Fax

This section describes how to specify options for fax transmissions. For information on the features available, refer to the following:

Confirmation Options – page 100

Starting Rate – page 100

Priority Send/Delay Start – page 100

Transmission Header Text – page 102

Recipient Print Sets – page 102

Multiple-Up – page 103

Remote Mailbox – page 103

F Code – page 104

1. Make sure that the Fax service is enabled.
2. Press the <All Services> button on the control panel.
3. Select [Fax] on the touch screen.
4. Select the [Fax Options] tab. Use the side tabs to switch screens.
5. Select the required feature.

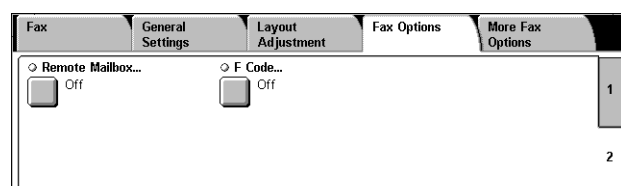
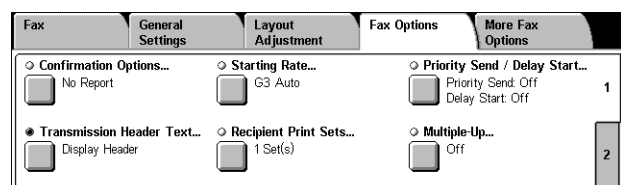

Confirmation Options

This feature automatically prints a report after each fax transmission indicating the transmission result.

1. Select [Confirmation Options] on the [Fax Options] screen.
2. Select the required option.
3. Select [Save].

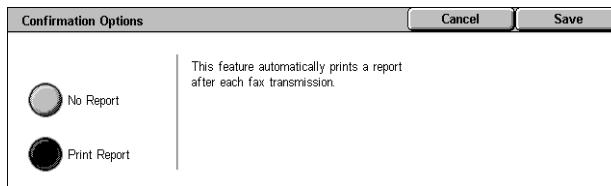

No Report

Disables the feature.

Print Report

Automatically prints a report after each fax transmission is completed.

Starting Rate

This feature allows you to select the communication mode for fax transmissions.

1. Select [Starting Rate] on the [Fax Options] screen.
2. Select the required option.
3. Select [Save].



G3 Auto

Select this mode if the remote machine is G3 compatible. This mode is the one usually selected. The machine automatically switches modes depending on the capabilities of the remote machine.

Forced 4800 bps

Select this mode when transmitting over noisy or bad telephone lines, for example when sending international faxes. Can also be useful for transmitting over poor telephone lines domestically.

Priority Send/Delay Start

This feature allows you to set the priority and start time for fax and polling jobs. Although you can set [Delay Start] in combination with [Priority Send], a fax will be sent at the time specified using the [Delay Start] option.

1. Select [Priority Send/Delay Start] on the [Fax Options] screen.
2. Select the required options.
3. Select [Save].

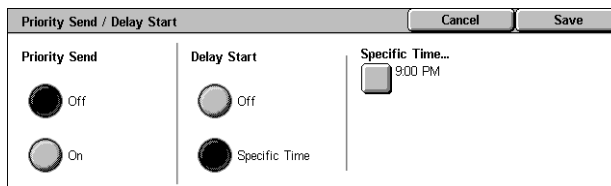

Priority Send

- Off - Disables the feature.
- On - Sends or polls a job prior to the already stored documents.

Delay Start

- Off - Disables the feature.
- Specific Time - Applies the delay start time. When you select this option, the [Specific Time] button is displayed at the right side of the screen.

Specific Time

Displays the [Delay Start - Specific Time] screen where you can specify the delay start time.

[Delay Start - Specific Time] Screen

Allows you to set the delay start time using a 12-hour or 24-hour format. You cannot specify a date for transmission.

NOTE: The format of the specific time can be set on the [Machine Clock/Timers] screen in the System Administration mode. [AM]/[PM] is displayed only when the 12-hour format is used. For more information, refer to the Setups chapter in the System Administration Guide.

1. Select [Specific Time] for [Delay Start] on the [Priority Send/Delay Start] screen.
2. Select [Specific Time].
3. Specify the Delay Start time using the scroll buttons.
4. Select [Save].

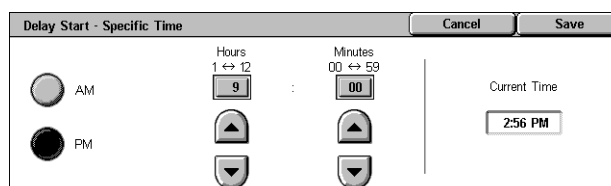

AM

The Delay Start time is before noon.

PM

The Delay Start time is after noon.

Hours

Sets the hour of the Delay Start time from 1 to 12.

Minutes

Sets the minutes of the Delay Start time from 00 to 59.

Current Time

Displays the current time.

Transmission Header Text

This feature allows you to add information such as the date and time of transmission, the sender's name, the destination name, the fax number, and the page quantity to the header at the top of each page of the document.

NOTE: A regular fax sent from the United States must show this information.

1. Select [Transmission Header Text] on the [Fax Options] screen.
2. Select the required option.
3. Select [Save].

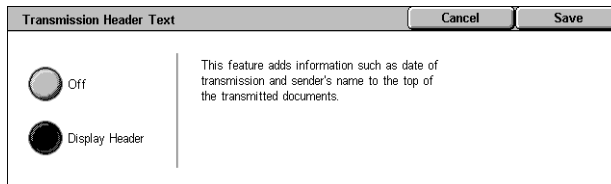

Off

Disables the feature.

Display Header

Sends header information with each fax transmission.

Recipient Print Sets

This feature allows you to specify the number of copies the remote machine will output. The number of copies can be between 1 and 99.

NOTE: This feature is supported only on Xerox machines.

1. Select [Recipient Print Sets] on the [Fax Options] screen.
2. Select the required option.
3. Select [Save].

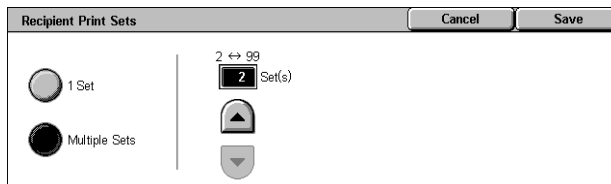

1 Set

Outputs one copy set only on the remote machine.

Multiple Sets

Specifies the number of copies, between 2 and 99, the remote machine will output.

When you select [Multiple Sets], you can specify the number of copies using the scroll buttons on the screen or the numeric keypad on the control panel.

Multiple-Up

This feature allows you to scan multiple pages of your original document, and have the scanned pages automatically merged for fax transmissions. The scanned data will be printed onto the paper specifically set for fax at the receiving end. Depending on the recipient's machine configuration, the scanned pages may be enlarged or reduced automatically to fit the paper size set to print fax, or the scanned pages may be divided into multiple pages if they are too long to be printed on a single piece of paper.

1. Select [Multiple-Up] on the [Fax Options] screen.
2. Select the required option.
3. Select [Save].

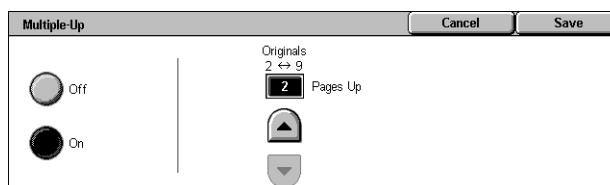

Off

Disables the feature.

On

Allows you to specify the number of pages, between 2 and 9, to fit onto one sheet.

Remote Mailbox

This feature allows you to access a mailbox on a remote machine to send and retrieve confidential documents. You must know the mailbox number and the passcode (if one is set up) to access the remote mailbox. For more information on how to retrieve confidential documents from a remote mailbox, refer to *Remote Polling on page 105*.

1. Select [Remote Mailbox] on the [Fax Options] screen.
2. Select the required option.
3. Select [Save].

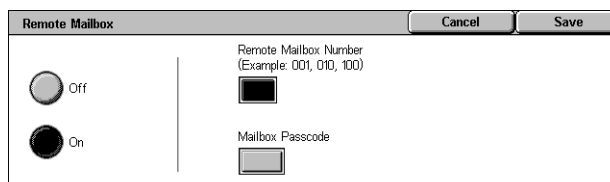

Off

Disables the feature.

On

Sets confidential transmissions. [Remote Mailbox Number] and [Mailbox Passcode] are displayed at the right side of the screen.

- Remote Mailbox Number - Enter a mailbox number for the remote machine using the numeric keypad on the control panel. The mailbox number is a 3-digit code from 001 to 999.
- Mailbox Passcode - Enter the passcode of the mailbox on the remote machine if required. The passcode is a 4-digit code.

F Code

This feature enables fax transmissions using the F Code standard defined by the Communications and Information network Association of Japan. The F Code standard is based on Recommendation T.30 defined by ITU Telecommunication Standardization Sector (ITU-T), and allows communication with remote machines that support the same standard regardless of their manufacturers.

You must know the F Code and the password (if one is set up) of the remote machine before sending or retrieving a document. If you are retrieving a document from a remote machine, the machine holding the document must know the F Code (preceded with "0" to indicate the confidential fax transmission) and the password of your machine as well.

- Confidential sending using F Code

You can send a confidential fax document using F Code, if a confidential mailbox is set up in the remote machine. You must know the remote machine's F Code and password (if set up) before sending the document.

Example:

F Code: 0 (to designate an F Code transmission) followed by the mailbox number

Password (if set up): the password for the mailbox

- Confidential polling using F Code

You can send a polling request to receive a document from a remote machine using F Code, if a confidential mailbox is set up in the remote machine to hold the document to be polled. When polling to receive a document from a remote machine, you must know the following information:

F Code: 0 (to designate an F Code transmission) followed by the remote machine's mailbox number in which the document to be polled to your machine is stored

Password (if set up): the password for the remote machine's mailbox

The confidential document received by the machine is stored in a confidential mailbox. The machine can be set up to automatically print out a Mailbox Documents Report to show the number and name of the mailbox in which the document is stored. To receive a confidential document using F Code, the other party must know the following information.

F Code: 0 (to designate an F Code transmission) followed by the mailbox number on your machine

Password (if set up): the password for the mailbox

NOTE: To retrieve a document from a remote machine, the polling feature must be enabled. For more information, refer to *Remote Polling on page 105*.

NOTE: This feature is not displayed for Internet Fax transmissions. However, you can use the same feature by specifying an F Code directly in the Internet Fax destination address.

1. Select [F Code] on the [Fax Options] screen.
2. Select the required option.
3. Select [Save].

The screenshot shows a dialog box titled "F Code". At the top right are "Cancel" and "Save" buttons. On the left side, there are two radio buttons: "Off" (which is unselected) and "On" (which is selected). To the right of the radio buttons, there are two text input fields. The first is labeled "F Code" and the second is labeled "Password".

Off

Disables the feature.

On

Sets the F Code transmission. [F Code] and [Password] are displayed at the right side of the screen.

- F Code - You can enter an F Code composed of spaces, numerals (0-9), and symbols (#, *) up to 20 characters. Enter the code using the numeric keypad on the control panel.
- Password - You can enter a password composed of spaces, numerals (0-9), and symbols (#, *) up to 20 characters. Enter the code using the numeric keypad on the control panel.

More Fax Options - Fax

This section describes the advanced features available for fax transmissions. For information, refer to the following:

Remote Polling – page 105

Store for Polling – page 106

On-hook (Manual Send/Receive) – page 108

1. Make sure that the Fax service is enabled.
2. Press the <All Services> button on the control panel.
3. Select [Fax] on the touch screen.
4. Select the [More Fax Options] tab.
5. Select the required feature.

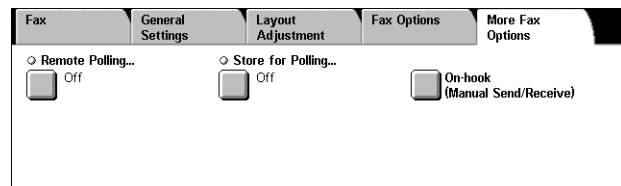

Remote Polling

This feature allows you to retrieve a document from a remote machine, referred to as “remote polling”. The remote machine information is entered using the same method for sending faxes, but the [Remote Polling] option is used to initiate retrieving the fax from the remote machine. You must know the mailbox number and the passcode (if set up) of the remote machine to retrieve the document.

NOTE: To poll a document from a remote machine, the remote mailbox feature must be enabled. For more information, refer to *Remote Mailbox on page 103*.

NOTE: The DTMF (dual tone multi-frequency) method and F Code (ITU-T subaddress) method can also be used to poll a document from a remote machine. For more information, refer to *Special Characters on page 84* or *F Code on page 104*.

1. Select [Remote Polling] on the [More Fax Options] screen.
2. Select the required option.
3. Select [Save].

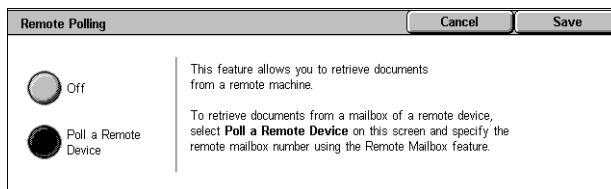

Off

Disables the feature.

Poll a Remote Device

Enables polling from a remote machine.

Store for Polling

This feature allows you to store documents in public and private mailboxes on the machine to make them available for polling from a remote machine.

1. Select [Store for Polling] on the [More Options] screen.
2. Select the required options.

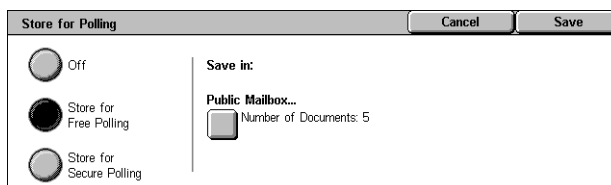

Off

Disables the feature.

Store for Free Polling

Stores documents which are ready to be polled in the public mailbox (polling box) on the machine. When you select this option, [Save in: Public Mailbox] is displayed at the right side of the screen.

Store for Secure Polling

Stores documents which are ready to be polled in a mailbox on the machine. By setting a passcode to the mailbox, this option prevents unauthorized access to the mailbox and thus adds security to your documents. When you select this option, [Save in: Private Mailbox] is displayed at the right side of the screen.

NOTE: To use this option, you must first create a mailbox on the machine. For how to create a mailbox, refer to the Setups chapter in the System Administration Guide.

Save in: Public Mailbox

Displays the [Public Mailbox] screen to confirm the status of stored documents or delete stored documents from the list.

Save in: Private Mailbox

Displays the [Mailbox] screen to specify the mailbox for storing documents.

[Public Mailbox] Screen

Displays the list of stored documents for polling. You can also delete or print the documents in the list.

NOTE: You can also display this screen by pressing the <Job Status> button on the control panel, and then selecting [Secure Print Jobs & More] > [Public Mailbox].

1. Select one or more documents from the list, or select [Select All] to select all documents in the list.

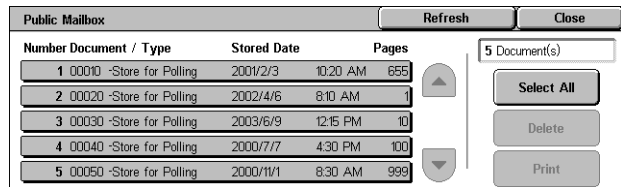

NOTE: To deselect a document selected individually, select the name of the document again. To deselect the documents selected by the [Select All] button, select the button again.

To deselect the documents selected by the [Select All] button, select the button again.

2. Select [Delete] or [Print].

Select All

Selects all of the fax documents stored for polling when you want to delete or print all documents.

Delete

Deletes the selected documents.

Print

Prints out the selected documents.

[Mailbox] Screen

Allows you to specify a mailbox to store documents or see the status of the documents stored in a mailbox.

1. Select a mailbox from the list, or directly enter a mailbox number into the [Go to] field, and then select [Document List].

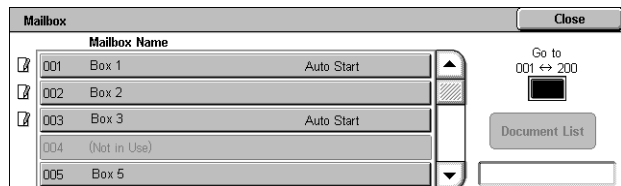

2. Select one or more documents from the list, or select [Select All] to select all the documents in the list.

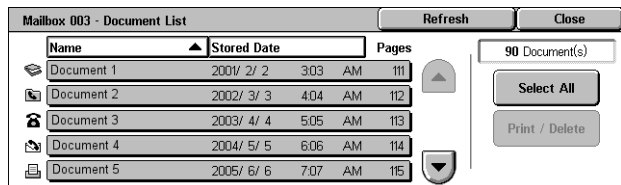

NOTE: To deselect a document selected individually, select the name of the document again. To deselect the documents selected by the [Select All] button, select the button again.

To deselect the documents selected by the [Select All] button, select the button again.

3. Select [Print/Delete].

4. Select the required option.

Change Document Name

Allows you to edit the document name. This option is available only when a single document is selected on the [Mailbox - Document List] screen.

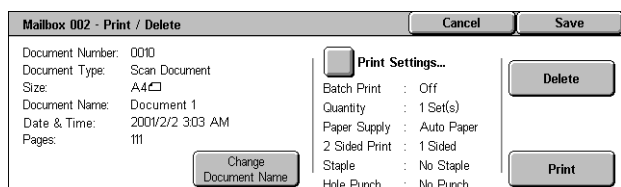

Delete

Deletes the selected documents.

Print

Prints the selected documents.

Print Settings

Displays the [Mailbox - Print Settings] screen. For details on the screen, refer to *[Mailbox - Print Settings] on page 149*.

On-hook (Manual Send/Receive)

This feature allows you to manually send or receive a fax when the fax line is on-hook, after confirming the response from the fax recipient.

1. Select [On-hook (Manual Send/Receive)] on the [More Options] screen.
2. Select the required option.
3. Select the <Start> button on the control panel.

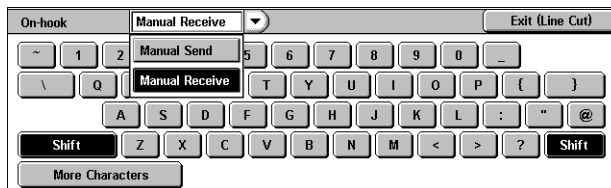
**Manual Send**

Allows you to send a fax manually after confirming the response from the fax recipient. To send a fax manually, select this option, enter the recipient's fax number, and then press <Start> after the recipient has responded to your call. Pressing the <Start> button switches from voice to fax transmission mode.

Manual Receive

To receive a fax manually, select this option, and then press <Start> to receive a fax job after you have communicated with a caller, and confirmed that the call is a fax job.

Exit (Line Cut)

Select this option to terminate the connection.

Internet Fax Options - Internet Fax

This section describes how to select the options for Internet Fax transmissions. For information on the features available, refer to the following:

Acknowledgement Report – page 109

Internet Fax Profile – page 109

Multiple-Up – page 110

Encryption – page 111

Digital Signature – page 111

Starting Rate – page 111

Transmission Header Text – page 112

1. Make sure that the Internet Fax service is enabled.
2. Press the <All Services> button on the control panel.
3. Select [Internet Fax] on the touch screen.
4. Select the [Internet Fax Options] tab.
5. Select the required feature.

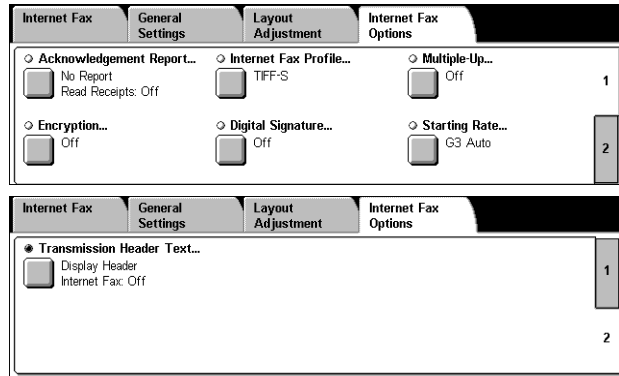

Acknowledgement Report

This feature allows you to print the transmission result report and receive a notification e-mail that the Internet Fax you sent has been opened by the recipient (MDN - Mail Delivery Notification). For more information, refer to the Setups chapter in the System Administration Guide. Transmission reports and read receipts are used for Internet Fax if the remote machine supports these features.

1. Select [Acknowledgement Report] on the [Internet Fax Options] screen.
2. Select the required options.
3. Select [Save].

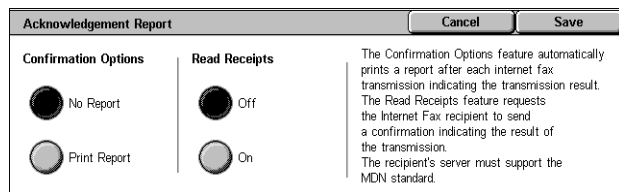

Confirmation Options

- No Report - Disables the feature.
- Print Report - Automatically prints a report after each fax transmission is completed.

Read Receipts

- Off - Disables the feature.
- On - Requests an e-mail delivery notification.

This feature automatically prints a report after each fax transmission indicating the transmission result.

Internet Fax Profile

This feature allows you to specify a profile to restrict the attribute information for transmissions between machines equipped with Internet Fax, such as image resolution and paper size.

1. Select [Internet Fax Profile] on the [Internet Fax Options] screen.
2. Select the required option.
3. Select [Save].

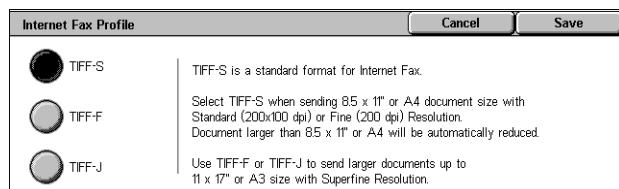

TIFF-S

Selects the standard specification for Internet Fax documents. Documents larger than A4 or 8.5 x 11" are automatically reduced to A4 or 8.5 x 11" depending on the default paper size series.

- Data compression: MH
- Stored Document Size: A4
- Resolution: Standard (200 x 100 dpi), Fine (200 dpi)

TIFF-F

Selects the profile for sending documents up to A3 or 11 x 17" with Superfine resolution.

- Data compression: MMR
- Stored Document Size: A4, B4, A3, letter, legal
- Resolution: Standard (200 x 100 dpi), Fine (200 dpi), Superfine (400 dpi), Superfine (600 dpi)

TIFF-J

Selects the profile for sending documents up to A3 or 11 x 17" in JBIG format.

- Data compression: JBIG
- Stored Document Size: A4, B4, A3, letter, legal
- Resolution: Standard (200 x 100 dpi), Fine (200 dpi), Superfine (400 dpi), Superfine (600 dpi)

Multiple-Up

This feature allows you to scan multiple pages of your original document, and have the scanned pages automatically merged for fax transmissions. The scanned data will be printed onto the paper specifically set for fax at the receiving end. Depending on the recipient's machine configuration, the scanned pages may be enlarged or reduced automatically to fit the paper size set to print fax, or the scanned pages may be divided into multiple pages if they are too long to be printed on a single piece of paper.

1. Select [Multiple-Up] on the [Internet Fax Options] screen.
2. Select the required option.
3. Select [Save].

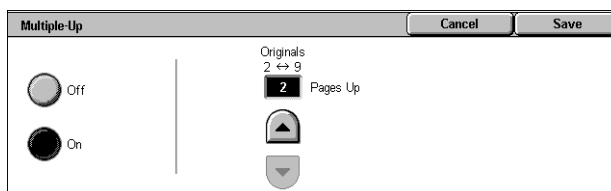
**Off**

Disables the feature.

On

Allows you to specify the number of pages, between 2 and 9, to fit onto one sheet.

Encryption

This feature allows you to send S/MIME-encrypted e-mail.

To use this feature, you need to specify an e-mail address associated with a certificate that supports encryption. For more information, refer to the Security chapter in the System Administration Guide.

1. Select [Encryption] on the [Internet Fax Options] screen.
2. Select the required option.
3. Select [Save].

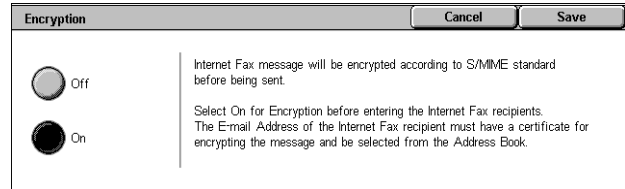

Off

Does not encrypt e-mail.

On

Encrypts e-mail.

Digital Signature

This feature allows you to attach a digital signature to e-mail.

To use this feature, the machine's e-mail address needs to be associated with an appropriate certificate. For more information, refer to the Security chapter in the System Administration Guide.

1. Select [Digital Signature] on the [Internet Fax Options] screen.
2. Select the required option.
3. Select [Save].

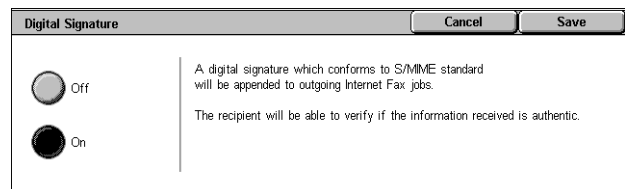

Off

Does not attach a digital signature to e-mail.

On

Attaches a digital signature to e-mail.

Starting Rate

This feature allows you to select the communication mode for Internet Fax transmissions.

1. Select [Starting Rate] on the [Internet Fax Options] screen.
2. Select the required option.
3. Select [Save].

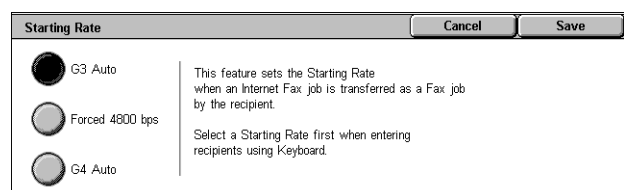

G3 Auto

Select this mode if the remote machine is G3 compatible. This mode is the one usually selected. The machine automatically switches modes depending on the capabilities of the remote machine.

Forced 4800 bps

Select this mode when transmitting over noisy or bad telephone lines, for example when sending international faxes. Can also be useful for transmitting over poor telephone lines domestically.

Transmission Header Text

This feature is identical to [Transmission Header Text] on the [Fax Options] screen of the Fax service. For information, refer to *Transmission Header Text on page 102*.

1. Select [Transmission Header Text] on the [Internet Fax Options] screen.
2. Select the required option.
3. Select [Save].

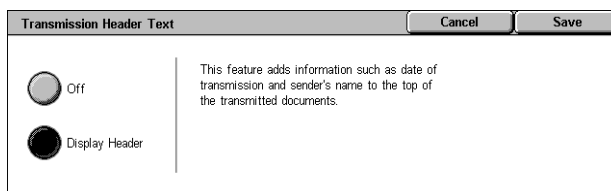

Fax Options - Server Fax

This section describes how to specify options for Server Fax transmissions. For information on the feature available, refer to the following:

Delay Start – page 113

1. Make sure that the Server Fax service is enabled.
2. Press the <All Services> button on the control panel.
3. Select [Fax] on the touch screen.
4. Select the [Fax Options] tab.
5. Select the required feature.

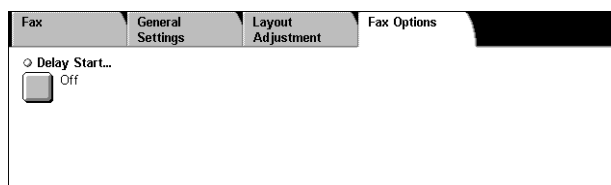

Delay Start

This feature allows you to set the delay start time for fax and polling jobs using the 12-hour or 24-hour format.

NOTE: The format of the specific time can be set on the [Machine Clock/Timers] screen in the System Administration mode. [AM]/[PM] is displayed only when the 12-hour format is used. For more information, refer to the Setups chapter in the System Administration Guide.

NOTE: You cannot specify a date for transmission.

1. Select [Delay Start] on the [Fax Options] screen.
2. Select the required options.
3. Select [Save].

Off

Disables the feature.

Specific Time

Applies the delay start time.

Hours

Sets the hour of the Delay Start time from 1 to 12.

Minutes

Sets the minutes of the Delay Start time from 00 to 59.

AM

The Delay Start time is before noon.

PM

The Delay Start time is after noon.

Current Time

Displays the current time.

5 Scan/E-mail

This chapter describes how to use the scan services. For more information on the specific types of scan, refer to the following:

To scan and e-mail documents – E-mail – page 120

After a document is scanned, the scanned data is automatically sent to specified destinations as an e-mail attachment.

To scan and save documents in the mailbox – Scan to Mailbox – page 124

Scanned documents are saved in a specified mailbox on the machine.

To scan and send documents using a job template – Network Scanning – page 124

According to the settings in a selected job template, documents are scanned, processed, and then uploaded to a specified server.

To scan and send documents using the FTP or SMB protocol – Scan to PC – page 125

After a document is scanned, the scanned data is automatically uploaded to a specified destination using the FTP or SMB protocol.

NOTE: To use the scan services, you must connect the machine to a network and set up the network environment. For more information, refer to the System Administration Guide.

NOTE: Some of the services and features described in this chapter may not apply to your machine configuration. For details, contact your System Administrator.

Scanning Procedure

This section describes the basic scanning procedures. Follow the steps below.

- 1. Load the Documents – page 116*
 - 2. Select the Features – page 116*
 - 3. Start the Scan Job – page 117*
 - 4. Check the Status of the Scan Job – page 118*
 - 5. Save the Scanned Data – page 118*
- Stopping a Scan Job – page 119*

1. Load the Documents

The following steps explain how to load documents using the document feeder or document glass.

The maximum capacity of the document feeder is shown below:

Document Type (Weight)	Capacity
Lightweight (38-49 g/m ²)	75 sheets
Plain (50-80 g/m ²)	75 sheets
Heavyweight (81-128 g/m ²)	50 sheets

Documents can be any size from 139.7 to 297 mm (4.9 to 11.7 inches) for the width and 210 to 432 mm (4.5 to 17 inches) for the length, and the standard sizes of 5.5 x 8.5" SEF/LEF to 7.25 x 10.5" SEF/LEF.

This machine is capable of scanning mixed size originals using the document feeder. Align the documents against the inner corner of the document feeder, and enable the *Mixed Sized Originals* feature. For more information, refer to *Mixed Sized Originals* on page 136.

NOTE: A paper jam may occur when custom sized originals are loaded in the document feeder, and the original size feature is set to [Auto Detect]. In this case, entering a custom paper size is recommended. For more information, refer to *Original Size* on page 136.

Load the document face up with the top edge entering the document feeder first, or face down on the document glass.

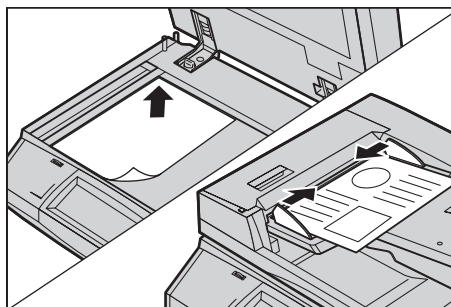

NOTE: When using the document glass, make sure that the touch screen is ready before you place the document on the document glass. If you place the document on the document glass before the touch screen is ready, the paper size may not be detected correctly.

2. Select the Features

Each scan service has its own screen. Select [E-mail], [Network Scanning], [Scan to Mailbox], or [Scan to PC] on the touch screen to display the appropriate screen.

- Select [E-mail] to scan and e-mail documents.
- Select [Network Scanning] to scan and send documents according to a job template.
- Select [Scan to Mailbox] to scan and save documents in a mailbox.
- Select [Scan to PC] to scan and send documents using the FTP or SMB protocol.

1. Press the <All Services> button on the control panel.

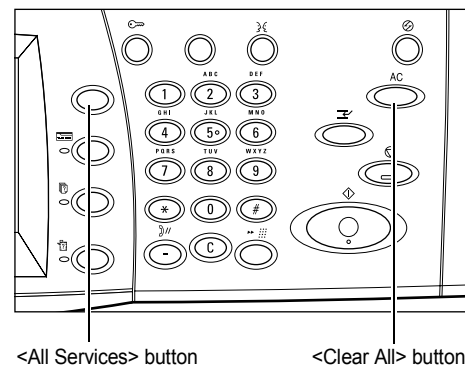

2. Select a scan service on the touch screen.

NOTE: If the Authentication and Accounting feature is enabled, you may be required to enter the user ID and passcode (if one is set up). If you need assistance, contact the System Administrator.

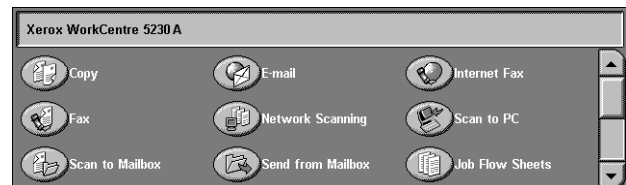

3. Press the <Clear All> button once on the control panel to cancel any previous selections.
4. Set the desired features on each tab.

For information on the features available on each tab, refer to the following:

E-mail – page 120

Scan to Mailbox – page 124

Network Scanning – page 124

Scan to PC – page 125

General Settings – page 128

Advanced Settings – page 131

Layout Adjustment – page 134

E-mail Options/Filing Options – page 139

3. Start the Scan Job

1. Press the <Start> button to scan the documents.

NOTE: If the Authentication and Accounting feature is enabled, you may be required to enter the user ID and passcode (if one is set up). If you need assistance, contact the System Administrator.

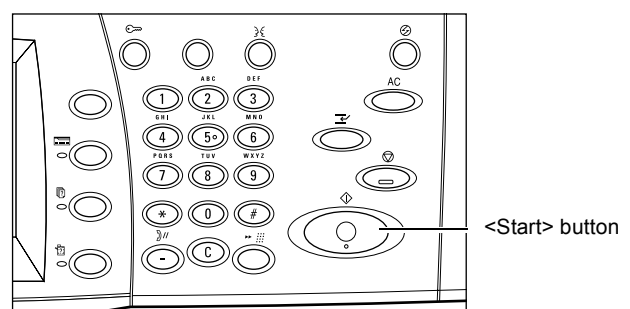

4. Check the Status of the Scan Job

1. Press the <Job Status> button on the control panel to display the Job Status screen.

The queued scan job is displayed. If the job is not displayed, it may have already been processed.

Active Jobs		Completed Jobs	Secure Print Jobs & More	Print Waiting Jobs	View by Job Type
#	Owner	Name	Status		
001	-	Copy	-	Printing	
002	-	File 123	00002	Job in Progress	
003	-	FTP Transfer	00003	Transferring	
004	-	Fax Send	00005	Sending	

For more information, refer to the Job Status chapter in the System Administration Guide.

5. Save the Scanned Data

The following describes how to import scanned documents to your computer. The methods available for importing documents include:

- importing using CentreWare Internet Services
- importing from TWAIN/WIA
- importing using Mailbox Viewer 3
- importing using WebDAV

Follow the steps below to import documents using CentreWare Internet Services.

NOTE: For more information on the other importing methods, refer to the documentations provided for the respective driver or utility.

1. Launch a web browser on your computer.
2. In the browser's URL field, enter the machine's IP address or Internet address and press the <Enter> key on your keyboard.
The home page of CentreWare Internet Services is displayed.

NOTE: For how to enter the machine's address in the browser's URL field, refer to *Accessing CentreWare Internet Services in the CentreWare Internet Services chapter on page 161*.

3. Click the [Scan] tab, and then select [Mailbox] from the tree menu at the left side of the screen.
4. Click the [Document List] button of the mailbox from which you want to retrieve a document.
The [Mailbox Document List] page is displayed.

NOTE: You can also display the [Mailbox Document List] page by selecting the mailbox icon, mailbox number, or the mailbox name.

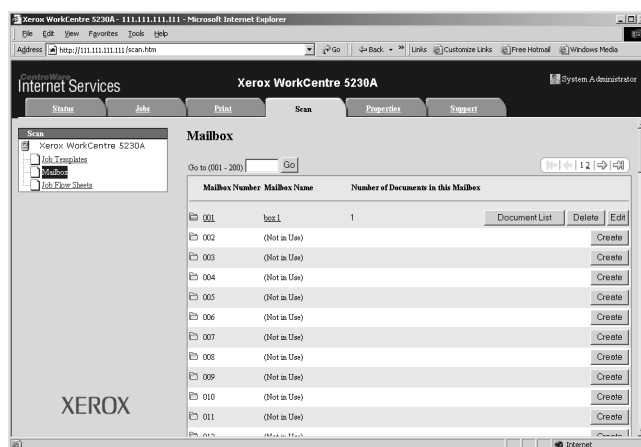

- From the list of documents, select the check box of the document to be imported, and then click the [Retrieve] button.

NOTE: You can import one document at a time.

- Click [Save this link] on the page displayed, and specify the directory to save the document.

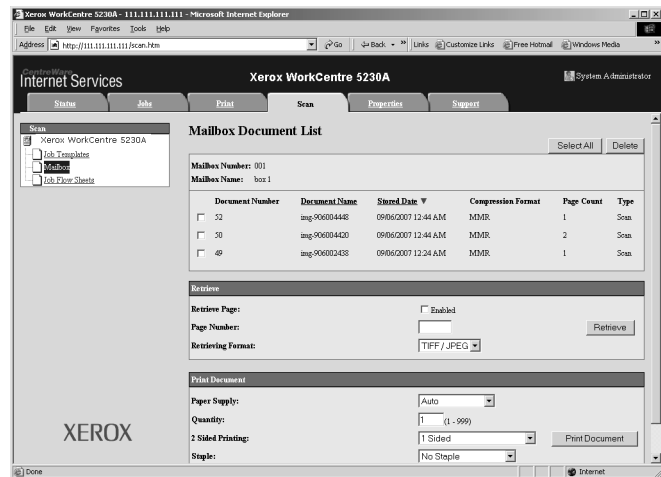

Stopping a Scan Job

Follow the steps below to manually cancel an activated scan job.

- Press the <Stop> button on the control panel to suspend the current scan job.

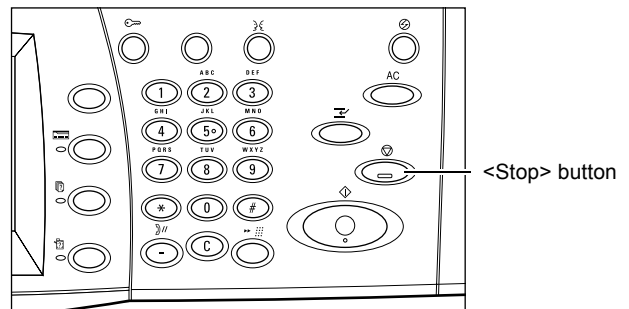

- If required, press the <Job Status> button to display the Job Status screen. To exit the Job Status screen, press the <Features> button.

Active Jobs		Completed Jobs	Secure Print Jobs & More	Print Waiting Jobs	View by Job Type
#	Owner	Name	Status		
001	-	Copy	-	Printing	
002	-	File 123	00002	Job in Progress	
003	-	FTP Transfer	00003	Transferring	
004	-	Fax Send	00005	Sending	

- On the [Stop/Pause] screen displayed, select [Cancel Scanning] to delete the suspended scan job.

NOTE: To resume the job, select [Resume Scanning] on the [Stop/Pause] screen.

E-mail

This section describes how to scan documents to send them as e-mail attachments. You can specify destination addresses by using the screen keyboard to enter the addresses, or by selecting from the Address Book. For more information on how to make entries using this screen, refer to the following:

New Recipients – page 120

Address Book – page 121

Add Me – page 122

1. Press the <All Services> button on the control panel.
2. Select [E-mail] on the touch screen.
3. Specify the required options.

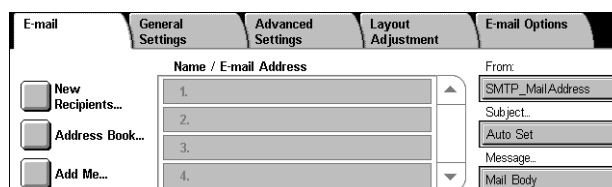

Remove/Edit/Close Menu

Selecting a recipient in the recipient list pops up a menu that allows you to remove or edit the recipient, or close the pop-up menu.

New Recipients

This feature allows you to enter recipients' e-mail addresses using the screen keyboard.

1. Select [New Recipients] on the [E-mail] screen.
2. Enter an address.
3. Select [Close].

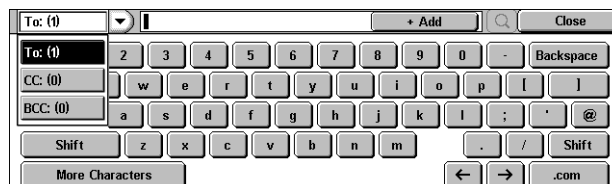

To:/CC:/BCC:

The pull-down menu at the left-hand side of the address entry field allows you to switch the recipient type between To, CC, and BCC.

More Characters

Displays the symbol keys on the screen.

+ Add

Select this button to enter another recipient's e-mail address.

Hand-glass icon

Allows you to search the Address Book for the entered search string. Any names that contain the search string will be found.

Address Book

This feature allows you to choose destinations from address books. The Local Address Book is held locally on the machine and stores public entries. The Remote Address Book is held remotely on a directory server.

NOTE: The address books displayed here contain only the e-mail addresses for the scan feature. The speed dial codes and group codes are not displayed.

1. Select [Address Book] on the [E-mail] screen.
2. Select an option from the pull-down menu located at the upper-left corner of the keyboard screen.

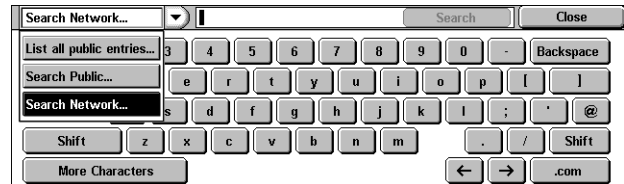

NOTE: To select or search for e-mail addresses stored in the Local Address Book, select [List all public entries] or [Search Public]. To search for e-mail addresses stored in the Remote Address Book, select [Search Network].

List all public entries

Allows you to select e-mail recipients from the Local Address Book.

Details

Displays the details of a recipient selected in the [Name] list.

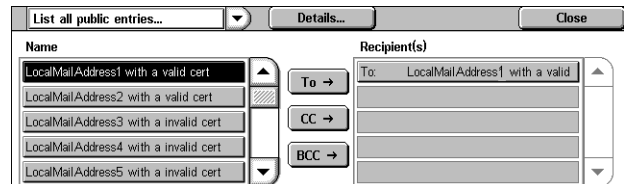

Name

Lists the e-mail recipients registered in the Local Address Book.

To

Adds a recipient selected in the [Name] list to the [Recipient(s)] list as a To recipient.

CC

Adds a recipient selected in the [Name] list to the [Recipient(s)] list as a CC recipient.

BCC

Adds a recipient selected in the [Name] list to the [Recipient(s)] list as a BCC recipient.

Recipient(s)

Lists the recipients selected from the [Name] list. Selecting a recipient in the list pops up a menu allowing you to remove or edit the recipient, remove all the recipients in the list, or close the pop-up menu.

Search Public/Search Network

Allows you to search for and select a recipient by entering part or all of its name. To search the Local Address Book, select [Search Public]. To search the Remote Address Book, select [Search Network].

1. Select [Search Public] or [Search Network] from the pull-down menu.
2. Enter part or all of a recipient name using the screen keyboard.
3. Select the [Search] button. A search result screen appears.
4. Select a recipient from the search result.

NOTE: For details on how to use this screen, refer to *List all public entries on page 121*.

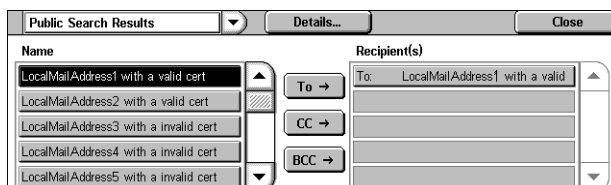
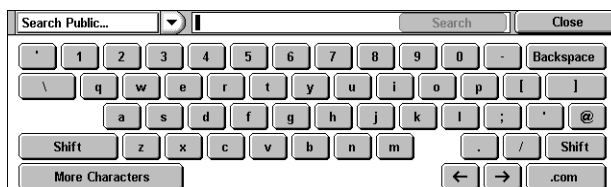

Add Me

This feature allows you to add your e-mail address (the sender's address) to an address entry field.

1. Select [Add Me] on the [E-mail] screen.
2. Select the required option.
3. Select [Save].



To

Adds the sender's address in the To field.

CC

Adds the sender's address in the CC field.

BCC

Adds the sender's address in the BCC field. The address entered in this field is not displayed on the message received by the recipient.

From

This feature allows you to view or change your e-mail address (the sender's address).

When the authentication feature is not used, the [From] field displays the machine name (if set up), or the machine's e-mail address.

When the authentication feature is used, the [From] field displays the e-mail address registered for the logged-in user.

By default, the e-mail address cannot be changed on this screen. For information on how to change the sender's e-mail address, refer to the E-mail/Internet Fax Service

Settings or Authentication/Security Settings section in the Setups chapter of the System Administration Guide.

The following describes how to change the sender's e-mail address when it is editable on this screen.

1. Select [From] on the [E-mail] screen.
2. From the pop-up menu displayed, select an option.

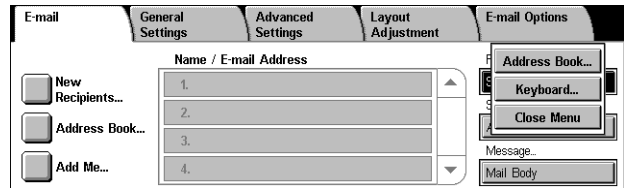

Address Book

Allows you to select an address from the Address Book.

Keyboard

Allows you to enter an address on the screen keyboard.

Close Menu

Closes the pop-up menu.

Subject

This feature allows you to enter an e-mail subject.

1. Select [Subject] on the [E-mail] screen.
2. Enter the subject using the screen keyboard.
3. Select [Save].

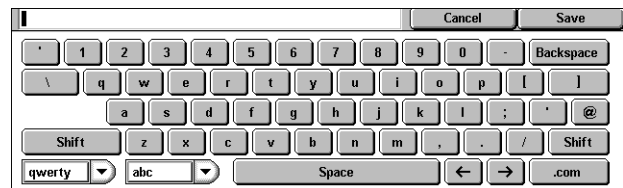

Message

This feature allows you to enter an e-mail message.

1. Select [Message] on the [E-mail] screen.
2. Enter the message using the screen keyboard.
3. Select [Save].

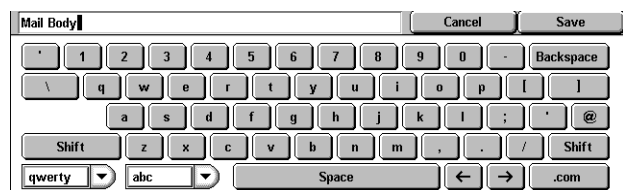

Scan to Mailbox

This section describes how to select a mailbox on the machine to save scanned documents.

1. Press the <All Services> button on the control panel.
2. Select [Scan to Mailbox] on the touch screen.
3. Select a mailbox for saving scanned data.

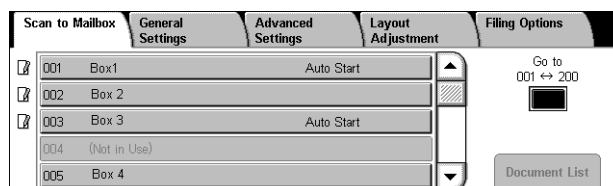

Mailbox list

Allows you to select a mailbox for saving scanned data. You can scroll through the list using the scroll bar.

Go to

Allows you to specify the number of a mailbox to be displayed, using the numeric keypad on the control panel. The specified mailbox is displayed at the top of the mailbox list.

Document List

Displays the [Mailbox - Document List] screen where you can sort, print, or delete documents in the selected mailbox.

For more information on mailbox features on the machine, refer to the *Send from Mailbox chapter on page 147*.

Network Scanning

This section describes how to scan and send documents to a specified server on a network using a job template. A job template can be created on the machine or remotely using CentreWare Internet Services or Network Scanning server applications sold separately. According to the settings in the template, documents are automatically scanned, saved in TIFF, JPEG*, XPS (XML Paper Specification), or PDF format, and then sent to a specified server. For information on how to create a job template, refer to the CentreWare Internet Services chapter in the System Administration Guide.

*: Supported by the WorkCentre 5225A/5230A only

The name of a template created on the machine begins with "@". A template created with CentreWare Internet Services or the Network Scanning server application carries the name you specified.

1. Press the <All Services> button on the control panel.
2. Select [Network Scanning] on the touch screen.
3. Select the job template to be used.
4. Press the <Start> button on the control panel.

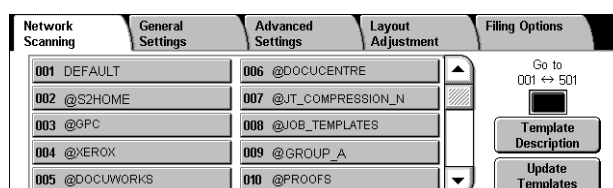

Job template list

Allows you to select a job template for the scan job.

- **DEFAULT** - This is the default job template. This template is used as a base template when a new template is to be created in CentreWare Internet Services. This template cannot be deleted. It can be edited and returned to the factory-default only by the System Administrator.
- **@S2HOME** - This is a template for the Scan-to-Home feature. Selecting this template verifies a user and sends scanned data to the user's private folder.

NOTE: The job template “@S2HOME” is displayed only when the remote authentication is enabled, and [Enabled] is selected for [Status], under [Properties] > [Services] > [Scan to Home] in CentreWare Internet Services. For more information, refer to the Scanner Environment Settings and CentreWare Internet Services chapters in the System Administration Guide.

NOTE: The job template “@S2HOME” cannot be edited using a remote application.

Go to

Allows you to specify the number of the job template to be displayed, using the numeric keypad on the control panel. The specified job template is displayed at the top of the template list.

Template Description

Displays the [Template Description] screen where you can view the template description, settings, and location.

Update Templates

Updates the list of available job templates.

Scan to PC

This section describes how to send scanned documents to specified destinations using the FTP or SMB protocol. For more information, refer to the following:

Transfer Protocol – page 126

Address Book – page 127

Browse – page 127

1. Press the <All Services> button on the control panel.
2. Select [Scan to PC] on the touch screen.
3. Set the following items.

The screenshot shows the 'Scan to PC' configuration screen with the following fields and options:

Scan to PC		General Settings	Advanced Settings	Layout Adjustment	Filing Options
Transfer Protocol...	Server	<input type="checkbox"/> SMB	<input type="text"/>		
<input type="checkbox"/> Address Book...	Shared Name		<input type="text"/>		
<input type="checkbox"/> Browse...	Save In		<input type="text"/>		
	User Name		<input type="text"/>		
	Password		<input type="text"/>		

Server

Allows you to specify the address of the destination server. Select a server name from the Address Book or select [Server] and enter a server name or IP address using the screen keyboard.

NOTE: If a server name is used instead of an IP address, the appropriate DNS information has to be entered via CentreWare Internet Services. Without DNS properly defined, the host name will not be translated into an IP address.

Shared Name

Allows you to specify the name of the shared folder. Select a server from the Address Book to display the preset name or select [Shared Name] and enter a shared folder name on the screen keyboard. Not required for FTP servers.

Save In

Allows you to specify the location (or path) of the directory for saving files. Select a server from the Address Book to display the preset location or select [Save in] and enter a location on the [Keyboard] screen.

NOTE: If data with the same file name is sent from multiple machines to one location at the same time, the data may be overwritten.

User Name

Allows you to specify the user name if required by the destination server. Select a server from the Address Book to display the preset user name or select [User Name] and enter a user name on the screen keyboard. Enter up to 97 characters if [FTP] is selected in the [Transfer Protocol] feature. Enter one of the following types if [SMB] is selected in the [Transfer Protocol] feature:

- user_name@domain_name (ex. fuji@xerox.com) where user_name is 32 characters (max) and domain_name is 64 characters (max)
- domain_name\user_name (ex. xerox\fuji) where user_name is 32 characters (max) and domain_name is 64 characters (max)
- local_user_name (ex. Fuji-Xerox) up to 32 characters (max)

Password

Allows you to specify the password if required by the destination server. Select a server from the Address Book to display the preset password or select [Password] and enter a password using the screen keyboard. Leave the password field blank if you do not want to assign a password.

Transfer Protocol

This feature allows you to select a transfer protocol. You must select the same protocol used by the destination.

1. Select [Transfer Protocol] on the [Scan to PC] screen.
2. Select the required option.
3. Select [Save].

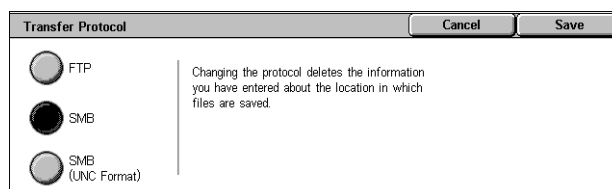

FTP

Specifies the FTP protocol.

SMB

Specifies the SMB protocol.

SMB (UNC Format)

Specifies the SMB protocol (using the UNC format).

NOTE: If Remote Authentication has been enabled, a popup message will prompt the user to enter a login ID and password before using the Scan to PC service. The login ID and password will be passed to the Kerberos server. Only when the user has been authenticated, the feature will be made available.

Address Book

This feature allows you to select a destination server from the Address Book. For information on how to register destinations, refer to the Setups chapter in the System Administration Guide.

1. Select [Address Book] on the [Scan to PC] screen.
2. From the Address Book list, select a destination server, and then select the [Add →] button.
3. Select [Close].

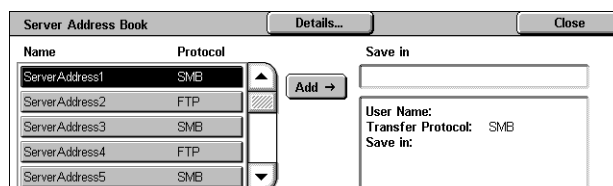

Name/Protocol

Displays the destination server information registered in the Address Book.

Details

Displays the detailed settings of a selected server.

Add →

Adds a selected destination server to the [Save in] field.

Save in

Displays a selected destination server and its details.

Browse

This feature allows you to select a location on the network to save a scanned document. Browsing starts at the workgroup level, proceeds to the server level, and then to multiple hierarchical levels of shared folders.

NOTE: The [Browse] button is grayed out and cannot be selected when [FTP] is selected for [Transfer Protocol]. This button does not appear when an IPv4 address is not assigned to the machine. For details on the protocol settings, refer to the Setups chapter in the System Administration Guide.

1. Select [Browse] on the [Scan to PC] screen.
2. Select the required options.
3. Select [Save].

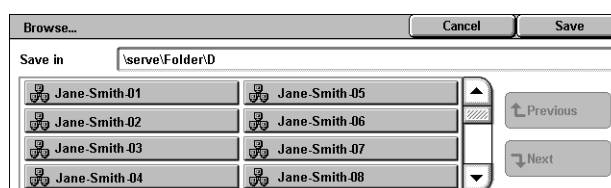

Previous

Retraces one step up in the hierarchy.

Next

Traces a path down in the hierarchy to the location selected.

General Settings

This section describes the general control features for scanning. For more information, refer to the following:

Color Scanning (WorkCentre 5225A/5230A) – page 128

Lighten/Darken (WorkCentre 5222/5225/5230) – page 129

2 Sided Scanning – page 129

Original Type – page 129

Scan Presets – page 130

1. Press the <All Services> button on the control panel.
2. Select a scan type on the touch screen.
3. Select the [General Settings] tab on the touch screen.
4. Select the required options.

WorkCentre 5225A/5230A

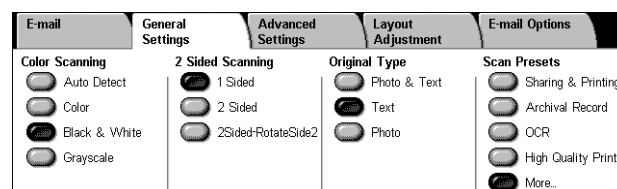

WorkCentre 5222/5225/5230

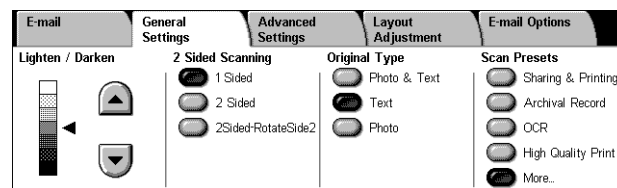

Color Scanning (WorkCentre 5225A/5230A)

This feature allows you to set the output color mode.

NOTE: The WorkCentre 5222/5225/5230 do not support this feature.

1. Select a color mode option for the [Color Scanning] feature on the [General Settings] screen.

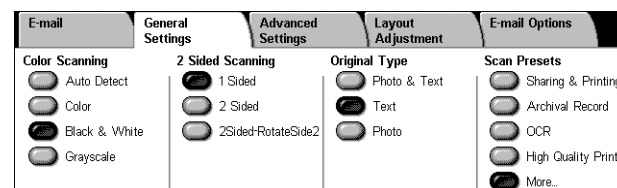

Auto Detect

Detects the color content in the document, and scans in full color if the content is color, or in black and white if the content is black and white.

NOTE: When [Auto Detect] is selected and [MRC High Compression] is set to [On] in [File Format], black and white pages are scanned in grayscale.

Color

Scans in full color.

Black & White

Scans in black and white, regardless of the color content of the original document.

Grayscale

Scans in grayscale, regardless of the color content of the original document.

Lighten/Darken (WorkCentre 5222/5225/5230)

This feature allows you to adjust the brightness level of scanned images.

NOTE: The Lighten/Darken feature for the WorkCentre 5225A/5230A is provided in [Image Options] on the [Advanced Settings] tab.

1. Adjust the brightness level using the scroll buttons.

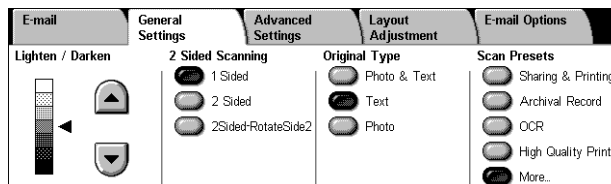

2 Sided Scanning

This feature allows you to specify whether your document is single-sided or double-sided, and how the document is to be positioned.

1. Select a preset button for the [2 Sided Scanning] feature on the [General Settings] screen.

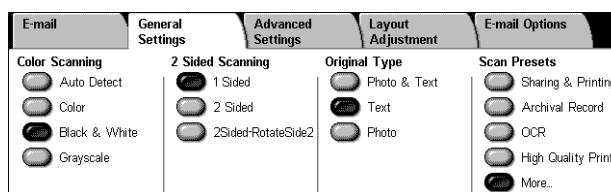

1 Sided

Scans one side of the document.

2 Sided

Scans both sides of the document. Select this option when the images of both sides of the document are in the same orientation.

2 Sided - Rotate Side 2

Scans both sides of the document. Select this option when the images of both sides of the document are in opposite orientations.

Original Type

This feature allows you to scan at optimum image quality by selecting the type of the original document.

NOTE: For the WorkCentre 5225A/5230A, the [Original Type] feature has no effect on the image quality in any of the following cases:

- when [Color Scanning] is set to [Color] or [Grayscale].
- when [Color Scanning] is set to [Auto Detect] and [MRC High Compression] in [File Format] is set to [On].

1. Select a preset button for the [Original Type] feature on the [General Settings] screen.

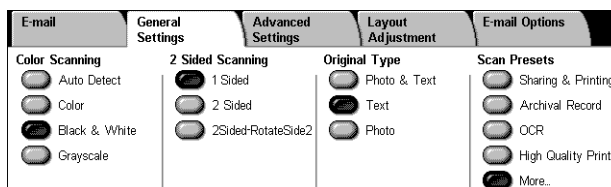

Photo & Text

Select this option to scan documents that contain both text and photographs. Text and photographs are automatically distinguished, and an appropriate quality mode is selected for individual areas.

Text

Select this option for documents that contain text only.

Photo

Select this option for documents that contain photographs only.

Scan Presets

This feature allows you to select a scan quality for image data.

1. Select a button under [Scan Presets] on the [General Settings] screen.

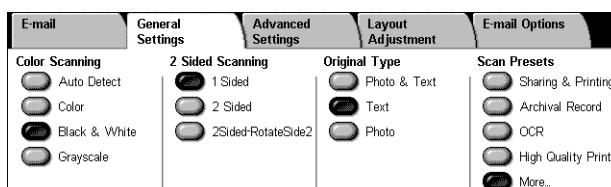

Sharing & Printing

Suitable for general office documents for onscreen viewing. Using this option will result in a small file size and normal image quality.

Archival Record

Suitable for general office documents that will be stored electronically for record keeping. Using this option will result in the smallest file size and normal image quality.

OCR

Suitable for documents that will be processed by the OCR feature. Using this option will result in a large file size and the highest image quality.

High Quality Print

Suitable for documents containing graphics and photographs. Using this option will result in a large file size and the maximum image quality.

More

Displays the [Scan Presets] screen where the following options are additionally selectable.

Simple Scan

Suitable for documents that require minimal image processing and compression. Using this option will result in fast processing and an excessively large file size.

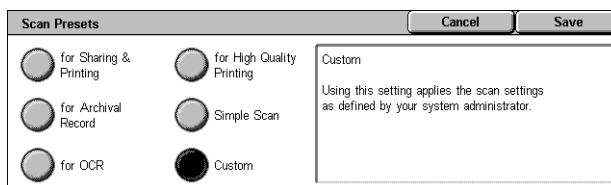

Custom

Allows you to use the scan quality defined by the System Administrator.

Advanced Settings

This section describes the features used to adjust the quality of the scanned image. For more information, refer to the following:

Photographs (WorkCentre 5225A/5230A) – page 131

Image Options – page 132

Background Suppression (WorkCentre 5222/5225/5230) – page 132

Image Enhancement (WorkCentre 5225A/5230A) – page 132

Shadow Suppression (WorkCentre 5225A/5230A) – page 133

Color Space (WorkCentre 5225A/5230A) – page 133

1. Press the <All Services> button on the control panel.
2. Select a scan type on the touch screen.
3. Select the [Advanced Settings] tab.
4. Set the required feature.
5. Select [Save].

WorkCentre 5225A/5230A

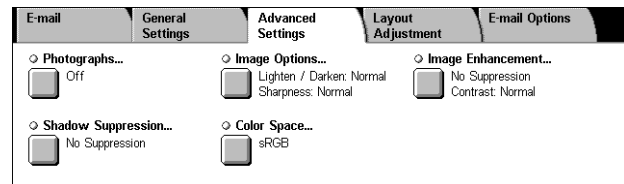

WorkCentre 5222/5225/5230

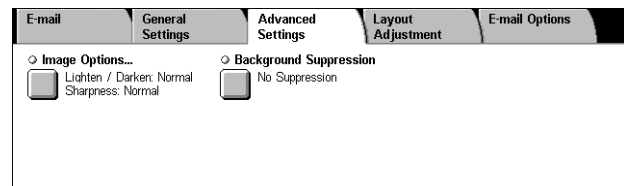

Photographs (WorkCentre 5225A/5230A)

This feature allows you to enhance images scanned from original color photographs.

NOTE: The WorkCentre 5222/5225/5230 does not support this feature.

NOTE: This feature is available when a photograph is placed on the document glass.

1. Select [Photographs] on the [Advanced Settings] screen.
2. Select the required option.
3. Select [Save].

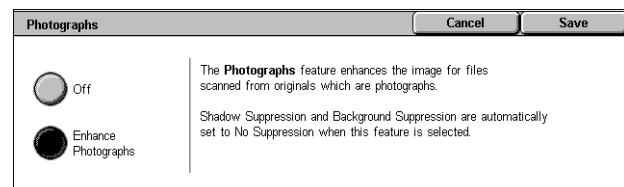

Off

Disables the feature.

Enhance Photographs

Enhances images scanned from color photographs with [Output Color] set to [Full Color].

NOTE: When [Enhance Photographs] is selected, [Shadow Suppression] and [Background Suppression] are not available.

Image Options

This feature allows you to adjust the brightness level and sharpness of scanned images.

1. Select [Image Options] on the [Advanced Settings] screen.
2. Select the required options.
3. Select [Save].

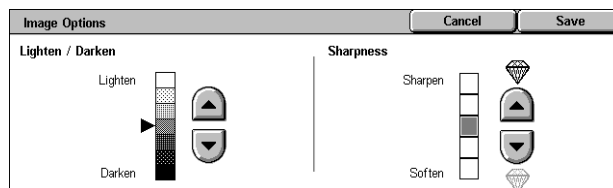

Lighten/Darken

Specifies the brightness level for scanned images.

Sharpness

Specifies the sharpness level of fine edges for scanned images.

Background Suppression (WorkCentre 5222/5225/5230)

This feature allows you to suppress background colors and image bleed-through when scanning.

NOTE: For the WorkCentre 5225A/5230A, this feature is provided in [Image Enhancement]. Refer to *Image Enhancement (WorkCentre 5225A/5230A)* on page 132.

1. Select [Background Suppression] on the [Advanced Settings] screen.
2. Select the required option.
3. Select [Save].



No Suppression

Disables the feature.

Auto Suppression

Automatically suppresses background colors.

NOTE: This feature is not available when [Photo] is selected on the [Original Type] screen.

Image Enhancement (WorkCentre 5225A/5230A)

This feature allows you to suppress background colors and adjust the contrast level when scanning.

NOTE: For the Background Suppression feature for the WorkCentre 5222/5225/5230, refer to *Background Suppression (WorkCentre 5222/5225/5230)* on page 132.

NOTE: [Contrast] is displayed if you select [Grayscale] or [Color] on the [Original Type] screen.

1. Select [Image Enhancement] on the [Advanced Settings] screen.
2. Select the required options.
3. Select [Save].

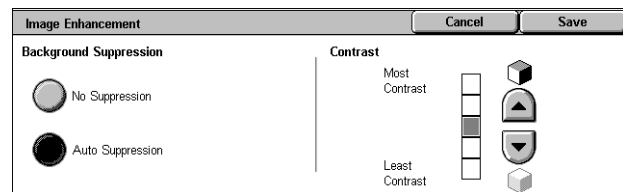

Background Suppression

- No Suppression - Scans with background suppression turned off.
- Auto Suppression - Automatically suppresses colored backgrounds when [Black] is selected on the [Color Scanning] screen, or suppresses white backgrounds on colored documents when [Color] is selected on the [Color Scanning] screen.

NOTE: This feature is not available when [Photo] is selected on the [Original Type] screen.

Contrast

Specifies the contrast level for scanned images.

Shadow Suppression (WorkCentre 5225A/5230A)

This feature allows you to suppress image bleed-through when scanning.

NOTE: The WorkCentre 5222/5225/5230 does not support this feature.

1. Select [Shadow Suppression] on the [Advanced Settings] screen.
2. Select the required option.
3. Select [Save].

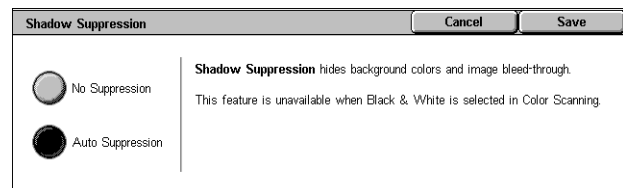

No Suppression

Disables the feature.

Auto Suppression

Automatically suppresses shadows from appearing on scanned images.

Color Space (WorkCentre 5225A/5230A)

This feature allows you to set the color space for scanned data.

NOTE: The WorkCentre 5222/5225/5230 does not support this feature.

NOTE: The [Color Space] button is displayed when [Enabled] is selected for [Color Space] in the System Administration mode. For details, refer to the Setups chapter in the System Administration Guide.

NOTE: The [Color Space] button is available when [Color Scanning] is set to [Color].

NOTE: The [Color Space] button is not available when [PDF/A] is selected in [File Format].

NOTE: To use the Searchable Text feature in [File Format], [sRGB] must be selected.

1. Select [Color Space] on the [Advanced Settings] screen.
2. Select either [sRGB] or [Device Color Space].
3. Select [Save].

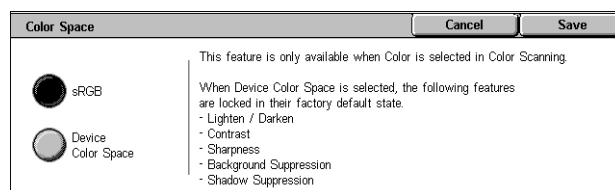

sRGB

Uses sRGB to process scanned data.

Device Color Space

Uses advanced color settings to process scanned data. When this option is selected, the factory-default values are used for the [Lighten/Darken], [Sharpness], [Shadow Suppression], [Contrast], and [Background Suppression] features.

Layout Adjustment

This section describes layout adjustment features for scanning. For information, refer to the following:

- Resolution – page 134*
- Book Scanning – page 135*
- Original Size – page 136*
- Edge Erase – page 136*
- Reduce/Enlarge – page 137*
- Original Orientation – page 137*

1. Press the <All Services> button on the control panel.
2. Select a scan type on the touch screen.
3. Select the [Layout Adjustment] tab.
4. Set the required feature.
5. Select [Save].

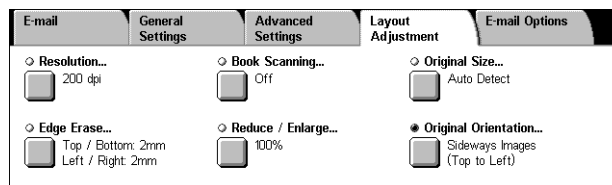

Resolution

This feature allows you to select the resolution for scanning the document. The greater the resolution selected, the larger the size of the stored image file. More time will also be required to complete the scan job.

1. Select [Resolution] on the [Layout Adjustment] screen.
2. Select the required option.
3. Select [Save].



Resolution

Scans at a resolution of 200 dpi, 300 dpi, 400 dpi or 600 dpi.

NOTE: For the WorkCentre 5225A/5230A, when [MRC High Compression] is set to [On] or [Searchable Text] is set to [Searchable] in [File Format], the available options are [200 dpi] and [300 dpi] only.

Book Scanning

This feature allows you to scan facing pages of a bound document in the correct page sequence using the document glass. The facing pages will be saved as two separate images.

1. Select [Book Scanning] on the [Layout Adjustment] screen.
2. Select the required options.
3. Select [Save].

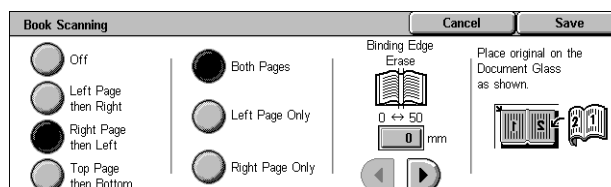

NOTE: The facing pages of a bound document must be placed in a horizontal orientation on the document glass.

Off

Disables the feature.

Left Page then Right

Scans pages of an open book in the direction from left to right.

- Both Pages - Scans both the left and right pages.
- Left Page Only - Scans the left pages only.
- Right Page Only - Scans the right pages only.

Right Page then Left

Scans pages of an open book in the direction from right to left.

- Both Pages - Scans both the left and right pages.
- Left Page Only - Scans the left pages only.
- Right Page Only - Scans the right pages only.

Top Page then Bottom

Scans pages of an open book in the direction from top to bottom.

- Both Pages - Scans both the top and bottom pages.
- Top Page Only - Scans the top pages only.
- Bottom Page Only - Scans the bottom pages only.

Binding Edge Erase

Erases the center binding area of the book that tends to be shadowed due to the fold in the pages. Use the scroll buttons to specify the area to be erased from the center of an open book within the range of 0-50 mm (0.0-2.0 inches) in 1 mm (0.04 inch) increments.

Original Size

This feature allows you to set the size of the document automatically, to select from a list of preset sizes, or to mix different size documents. If you select a preset size, documents will be scanned according to the specified size regardless of their actual size.

1. Select [Original Size] on the [Layout Adjustment] screen.
2. Select the required options.
3. Select [Save].

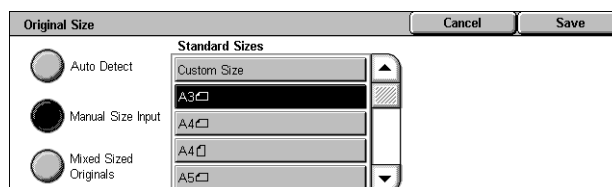

Auto Detect

Automatically detects the size of standard sized documents.

Manual Size Input

Allows you to select the input size from the 11 preset standard sizes in portrait and landscape orientations, or select a custom size within the ranges of 15-297 mm (0.6-11.7 inches) for the length and 15-432 mm (0.6-17.0 inches) for the width. The presets are set up by the System Administrator.

Mixed Sized Originals

Allows you to scan mixed sized originals at the same time. The machine senses the mixed sized originals automatically, and scans each document at the same size as the original. Load different size documents, with top left corners aligned, into the document feeder.

NOTE: 5.5 × 8.5" and A5 originals must be loaded in portrait orientation.

Edge Erase

This feature allows you to erase unwanted marks such as scan shadows and hole punch marks from each edge of the scanned images.

1. Select [Edge Erase] on the [Layout Adjustment] screen.
2. Select the required options.
3. Select [Save].

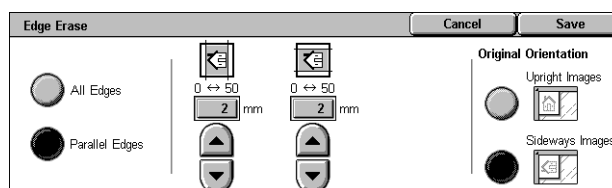

All Edges

Erases the same amount from all four edges of your document. The edge erase amount is specified by the System Administrator and cannot be changed on this screen. If you do not want to erase the edges, select [Parallel Edges] and specify 0 for both the top/bottom and left/right edges.

Parallel Edges

Allows you to specify the amount to be erased from the top and bottom, and left and right edges of your document. Up to 50 mm (2 inches) can be specified for each field.

Original Orientation

- Upright Images - Selects the vertical orientation, where the top of the document is orientated towards the back of the machine.
- Sideways Images - Selects the horizontal orientation, where the top of the document is orientated towards the left of the machine.

Reduce/Enlarge

This feature allows you to enlarge or reduce a scanned document by a specified ratio within the range of 25-400%.

1. Select [Reduce/Enlarge] on the [Layout Adjustment] screen.
2. Specify a ratio using the arrow buttons, or select a preset button.
3. Select [Save].

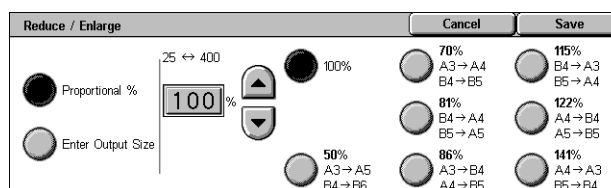

NOTE: For the WorkCentre 5225A/5230A, when [MRC High Compression] in [File Format] is set to [On], this feature is automatically set to 100%.

Proportional %

- Text box - Allows you to specify a desired reduction/enlargement ratio using the scroll buttons. You can also enter the value by touching the text box and using the numeric keypad on the control panel. The value can be specified within the range of 25-400% in 1% increments.
- 100% - Scans at the same size as the original document.
- Presets - Allows you to select a reduction/enlargement ratio from the seven preset ratios. The presets are set up by the System Administrator.

Enter Output Size

Allows you to select an output size from the standard paper sizes.

Original Orientation

This feature allows you to specify the orientation of your document.

1. Select [Original Orientation] on the [Layout Adjustment] screen.
2. Select the required option.
3. Select [Save].

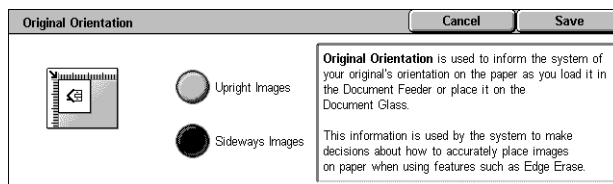

NOTE: For the WorkCentre 5225A/5230A, when the Searchable Text feature is enabled in [File Format], the [Searchable - Page Orientation] setting in the System Administration mode overrides this [Original Orientation] setting. For details on the [Searchable - Page Orientation] setting, refer to the Setups chapter in the System Administration Guide.

Upright Images

Selects the vertical orientation, where the top of the document is orientated towards the back of the machine.

Sideways Images

Selects the horizontal orientation, where the top of the document is orientated towards the left of the machine.

E-mail Options/Filing Options

This section describes the features available to configure the settings for outputting scanned data. For more information, refer to the following:

NOTE: For the [E-mail] scan service, the following features are available on the [E-mail Options] tab. For other scan services, the features are available on the [Filing Options] tab.

Quality / File Size (WorkCentre 5225A/5230A) – page 139

File Format – page 140

Read Receipts – page 142

Split Send – page 142

Document Name/File Name – page 143

File Name Conflict – page 143

Reply To – page 144

Encryption – page 144

Digital Signature – page 145

Login Name – page 145

Password – page 145

Meta Data – page 146

NOTE: The features available vary according to the model of your machine and the scan type selected on the All Services screen.

1. Press the <All Services> button on the control panel.
2. Select a scan type on the touch screen.
3. When you select [E-mail], select the [E-mail Options] tab. When you select [Scan to Mailbox], [Network Scanning], or [Scan to PC], select the [Filing Options] tab.
4. Select the required feature.

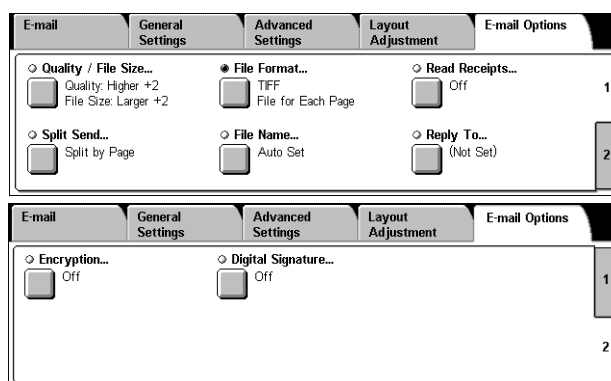

Quality / File Size (WorkCentre 5225A/5230A)

This feature allows you to select the ratio of data compression for color and grayscale scanned images.

NOTE: The WorkCentre 5222/5225/5230 does not support this feature.

NOTE: This feature is not available when [Color Scanning] is set to [Black & White].

NOTE: Only three compression levels are available when [MRC High Compression] is enabled for [PDF Multiple Pages per File], [PDF/A], or [XPS] in [File Format].

1. Select [Quality / File Size] on the [E-mail Options] or [Filing Options] screen.
2. Select a quality and file-size level.
3. Select [Save].

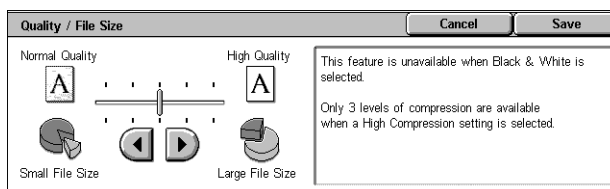

File Format

This feature allows you to select the file format to use when saving scanned data.

NOTE: The options available for this feature vary depending on the model of your machine and the scan type you select on the All Services screen. This feature is not available when you select [Scan to Mailbox].

1. Select [File Format] on the [E-mail Options] or [Filing Options] screen.
2. Select the required option.
3. Select [Save].

WorkCentre 5225A/5230A

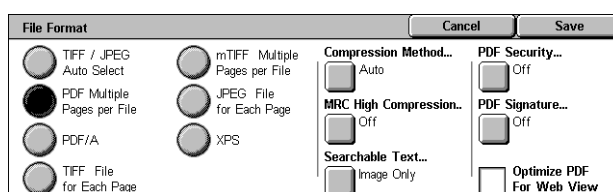

TIFF/JPEG Auto Select (WorkCentre 5225A/5230A)

Automatically saves scanned data in TIFF or JPEG format. Full color and grayscale images are saved in JPEG format, and monochrome images are saved in TIFF format.

WorkCentre 5222/5225/5230

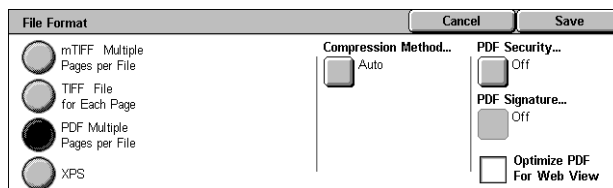

PDF Multiple Pages per File

Saves multiple pages into a single file in PDF format.

PDF/A (WorkCentre 5225A/5230A)

Saves multiple pages into a single file in PDF/A format, which is suitable for long-term archiving of electronic documents.

NOTE: The [PDF Security] and [PDF Signature] features are not available for this option.

TIFF File for Each Page

Saves each page into a different file in TIFF format.

mTIFF Multiple Pages per File

Saves multiple pages into a single file in TIFF format.

JPEG File for Each Page (WorkCentre 5225A/5230A)

Saves each page into a different file in JPEG format.

XPS

Saves multiple pages into a single file in XPS (XML Paper Specification) format.

- Compression Method - Compresses the file. This button is active when an option other than [JPEG File for Each Page] is selected. The selected compression method is applied to black and white pages.
- MRC High Compression (WorkCentre 5225A/5230A) - Displayed when [PDF Multiple Pages per File], [PDF/A], or [XPS] is selected. This feature saves files with the MRC compression method.

NOTE: [MRC High Compression] is not available when [Color Scanning] is set to [Black & White].

NOTE: When [MRC High Compression] is set to [On], the options available for [Resolution] are [200 dpi] and [300 dpi] only, and the [Reduce/Enlarge] feature is set to [100%].

- Searchable Text (WorkCentre 5225A/5230A) - Displayed when [PDF Multiple Pages per File], [PDF/A], or [XPS] is selected. Select the language of the document, and select whether to compress text.

NOTE: If [Original Type] is set to [Photo], the [Searchable Text] button is not selectable.

NOTE: If [Color Space] is set to [Device Color Space], the [Searchable Text] button is not selectable.

PDF Security

Displays the [File Format - PDF Security] screen where you can set security to prevent unauthorized access to your PDF file. Select [Password] to apply security measures.

- Encryption Algorithm - Sets either 128-bit RC4 (Acrobat 5.0 or later) or 128-bit AES (Acrobat 7.0 or later) file encryption algorithm.
- Supported Version - Displays the version of Adobe Acrobat compatible with the selected encryption algorithm.
- Doc. Open Password - Displays the [PDF Security - Document Open Password] screen where you can set a password that will be required to open your PDF file. The password can be up to 32 characters in length.
- Permissions - Displays the [PDF Security - Permissions] screen where you can set a security password to your PDF file. A security password adds restrictions that prevent others from printing or editing the file. The file's recipient can remove the restrictions if the recipient knows the password. The password can be up to 32 characters long.

NOTE: [PDF Security] is displayed when [PDF Multiple Pages per File] is selected.

PDF Signature

Allows you to add a signature to your PDF file so that the file's authenticity can be definitively proven, preventing false and fake documents being presented as authentic documents. If [On] is selected, select a position to place a visible PDF signature, or select [Invisible Signature] to add an invisible PDF signature.

NOTE: The following handlers are used by Adobe Reader to verify the PDF signature: Acrobat 6.x verifies the signature using Windows Certificate Security, and Acrobat 7.x verifies the signature using Adobe Default Security.

XPS Signature

Allows you to add a XPS (XML Paper Specification) signature to your file so that the file's authenticity can be definitively proven, preventing false and fake documents being presented as authentic documents.

Optimize PDF For Web View

Creates a PDF file that displays the first page in a user's web browser, before the entire file is downloaded from a web server. This feature alleviates user frustration in waiting for an entire file to download by displaying part of the file's contents at once.

Read Receipts

This feature allows you to request recipients notify you by e-mail that they have received your e-mail attachment.

NOTE: This feature is displayed only when you have selected [E-mail].

1. Select [Read Receipts] on the [E-mail Options] screen.
2. Select [On] to enable the feature.
3. Select [Save].

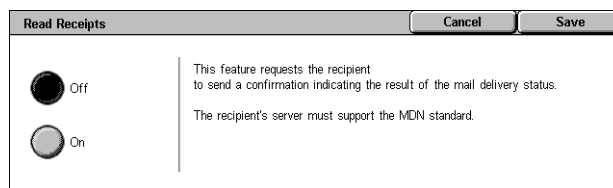

Split Send

This feature allows you to divide large scanned data files into multiple e-mail messages of a specific data size.

WorkCentre 5225A/5230A

NOTE: This feature is displayed when a split count value is specified in [Maximum Split Count] in the System Administration mode and the [E-mail] service is selected on the All Services screen. For details on the [Maximum Split Count] setting, refer to the Setups chapter in the System Administration Guide.

1. Select [Split Send] on the [E-mail Options] screen.
2. Select the required option.
3. Select [Save].

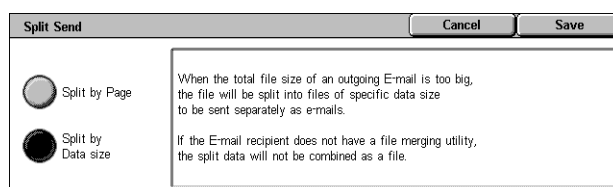

Split by Page

Splits scanned data into pages. Select this option when e-mail recipients use e-mail applications that do not support RFC2046, such as Outlook and LotusNotes.

Split by Data Size

Splits scanned data by data size if the e-mail size exceeds the value specified in [Maximum Data Size per E-mail] in the System Administration mode. Select this option when e-mail recipients use e-mail applications that support RFC2046, such as Outlook Express. For information on the [Maximum Data Size per E-mail] setting, refer to the Setups chapter in the System Administration Guide.

WorkCentre 5222/5225/5230

NOTE: This feature is displayed when the [E-mail] service is selected on the All Services screen.

1. Select [Split Send] on the [E-mail Options] screen.
2. Select the required option.
3. Select [Save].

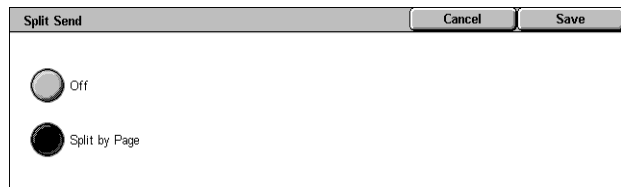

Off

Disables the feature.

Split by Page

Splits scanned data by data size if the e-mail size exceeds the value specified in [Maximum E-mail Size] in the System Administration mode. For information on the [Maximum E-mail Size] setting, refer to the Setups chapter in the System Administration Guide.

Document Name/File Name

This feature allows you to enter a name for the document/file name, if you do not want to use the name assigned by the machine. The file name extension is automatically attached to the file name depending on the type of file.

NOTE: The [Document Name] feature is displayed when you have selected [Scan to Mailbox]. The [File Name] feature is displayed when you have selected [E-mail], [Scan to PC], or [Network Scanning].

1. Select [Document Name] or [File Name] on the [E-mail Options] or [Filing Options] screen.
2. Enter a document/file name.
3. Select [Save].

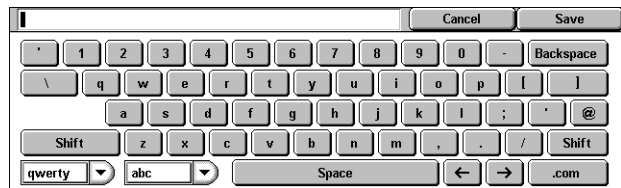

File Name Conflict

This feature allows you to deal automatically with file name conflicts if a duplicate file name is entered on the [File Name] screen.

NOTE: This feature is displayed only when [Scan to PC] or [Network Scanning] is selected on the All Services screen.

1. Select [File Name Conflict] on the [Filing Options] screen.
2. Select the required option
3. Select [Save].

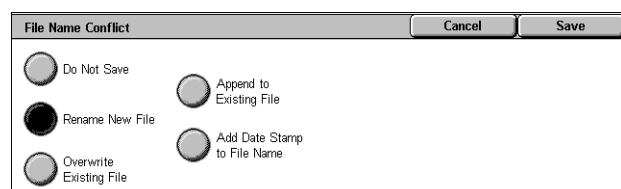

Do Not Save

Cancels the scan operation so that you may enter another file name.

Rename New File

Attaches a 4-digit number (0001-9999) to the end of the duplicate file name and saves the file in the same directory.

Overwrite Existing File

Deletes the existing file with the duplicate file name and saves the new file with the specified file name in the same directory.

Append to Existing File

Appends the scan data to the existing data.

NOTE: This button is displayed only when [Network Scanning] is selected, and is selectable when [TIFF File for Each Page] or [JPEG File for Each Page] is selected for [File Format] on the [Filing Options] tab.

Add Date Stamp to File Name

Adds a date to the new file.

NOTE: This button is displayed only when [Network Scanning] is selected.

Reply To

This feature allows you to specify the return e-mail address that the recipients can reply to when using the E-mail service.

NOTE: This feature is displayed only when [E-mail] is selected on the All Services screen.

1. Select [Reply To] on the [E-mail Options] screen.
2. Enter a return address.
Or, enter part of a target name, and then select the hand-glass icon at the right side of the entry field, to search Address Book. For details on the search result screen, refer to *Search Public/Search Network on page 121*.
3. Select [Save].

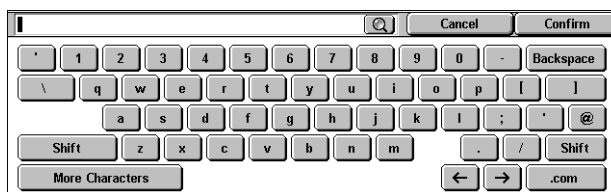

Encryption

This feature allows you to send S/MIME-encrypted e-mail.

To use this feature, you need to specify an e-mail address associated with a certificate that supports encryption. For more information, refer to the Security chapter in the System Administration Guide.

NOTE: This feature is displayed only when [E-mail] is selected on the All Services screen.

1. Select [Encryption] on the [E-mail Options] screen.
2. Select an option.
3. Select [Save].

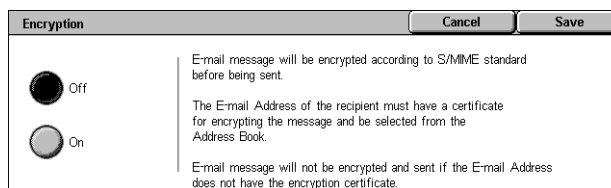

Off

Does not encrypt e-mail.

On

Encrypts e-mail.

Digital Signature

This feature allows you to attach a digital signature to e-mail.

To use this feature, the machine's e-mail address needs to be associated with an appropriate certificate. For more information, refer to the Security chapter in the System Administration Guide.

NOTE: This feature is displayed only when [E-mail] is selected on the All Services screen.

1. Select [Digital Signature] on the [E-mail Options] screen.
2. Select an option.
3. Select [Save].

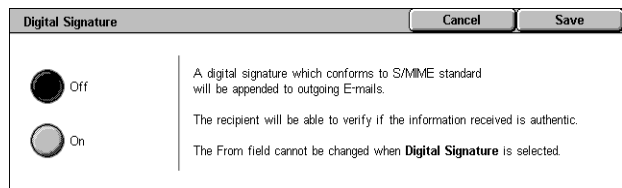
**Off**

Does not attach a digital signature to e-mail.

On

Attaches a digital signature to e-mail.

Login Name

When a server to which scanned documents will be transferred requires a login name, enter it here.

NOTE: This feature is displayed only when [Network Scanning] is selected on the All Services screen.

1. Select [Login Name] on the [Filing Options] screen.
2. Enter the login name.
3. Select [Save].

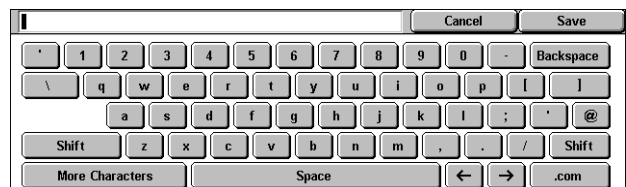

Password

This feature allows you to set the password for the login name when a server to which scanned documents will be transferred requires a password.

NOTE: This feature is displayed only when [Network Scanning] is selected on the All Services screen.

1. Select [Password] on the [Filing Options] screen.
2. Enter the password.
3. Select [Save].

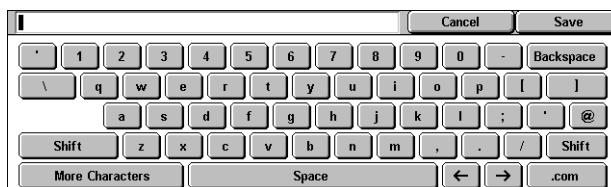

Meta Data

This feature allows you to change the meta data values specified in the selected job template.

NOTE: This feature is displayed only when [Network Scanning] is selected on the All Services screen.

NOTE: To register new meta data or to delete existing meta data, use CentreWare Internet Services. For more information, refer to *CentreWare Internet Services on page 161*.

1. Select [Meta Data] on the [Filing Options] screen.
2. Select the required meta data, and then change the value.
3. Select [Save].

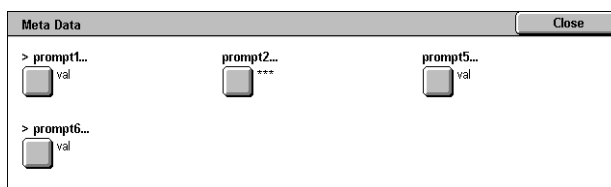

Meta Data Validation

If the validation feature is enabled for meta data, the validation server specified for the meta data automatically validates the meta data value when you press the <Start> button on the machine's control panel. If any meta data that received validation is invalid, the machine will not execute the job. For details on the validation settings, refer to the CentreWare Internet Services chapter in the System Administration Guide.

6 Send from Mailbox

This chapter describes the methods for checking, printing, or deleting documents in a mailbox. You can store the following types of documents (marked with matching icons in the Document List) in a mailbox.

Some models do not support this service. Some models require an optional kit to use this service.

- Incoming confidential fax documents (☎) - Refer to *Remote Mailbox in the Fax chapter on page 103*.
- Incoming confidential Internet Fax documents (☎) - Refer to *Remote Mailbox in the Fax chapter on page 89*.
- Fax documents for confidential polling (☎) - Refer to *Store for Polling in the Fax chapter on page 106*.
- Scanned documents (📄) - Refer to *Scan to Mailbox in the Scan/E-mail chapter on page 124*.
- Print documents (🖨) (📄)

You can also link a mailbox to a job flow sheet to process the stored documents manually and automatically. For more information, refer to *Send from Mailbox on page 147*.

Send from Mailbox

This section describes the mailbox features that allow you to check, print, or delete documents in the mailboxes displayed on the [Send from Mailbox] screen. Some mailboxes, however, may require you to enter a passcode, depending on the operation you attempt. Mailboxes created by other users are inactive and inaccessible to you. For information on how to create a mailbox, refer to the Setups chapter in the System Administration Guide.

1. Press the <All Services> button on the control panel.

NOTE: If the Authentication and Accounting feature is enabled, you may be required to enter a user ID and a passcode (if one is set up). If you need assistance, contact the System Administrator.

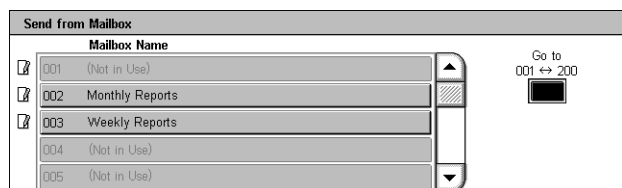

2. Select [Send from Mailbox] on the All Services screen.

Go to

Allows you to specify the first mailbox number to be displayed on the screen, using the numeric keypad on the control panel.

3. Select the mailbox to be opened. Then the documents stored in the mailbox appear.

Refresh

Updates the list of documents in the mailbox.

Name/Date & Time

Sorts the documents by their names or the dates they were stored. Selecting the same option again toggles the order in which they are listed, as indicated with an upward (ascending order) or downward (descending order) triangle shown to the right of the name of the option selected.

Select All

Selects all the documents in the mailbox, so that you can print or delete them all at once.

Print/Delete

Displays the [Print/Delete] screen.

- Print - Prints the selected document(s).
- Delete - Deletes the selected document(s).

Job Flow Settings

Displays the [Job Flow Settings] screen. For more information, refer to *Job Flow Settings on page 149*.

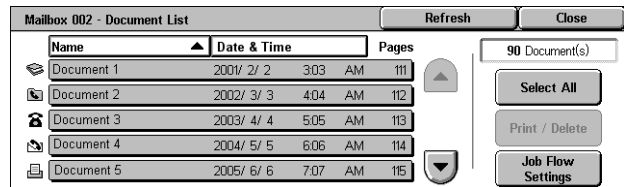

Printing/Deleting Mailbox Documents

1. Select one or more documents from the list, or select [Select All] to select all the documents in the list.

NOTE: To deselect a document selected individually, select the name of the document again. To deselect the documents selected by the [Select All] button, select the button again.

2. Select [Print/Delete].
3. Select the required option.

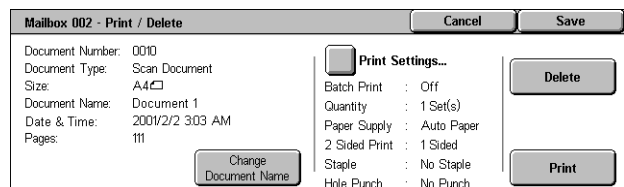
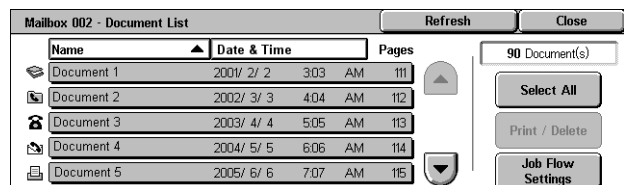

Change Document Name

Allows you to edit the name of a document. This option is available only when a single document is selected on the [Document List] screen.

Print Settings

Displays the [Mailbox - Print Settings] screen. For more information, refer to *[Mailbox - Print Settings] on page 149*.

Delete

Deletes the selected documents.

Print

Prints the selected documents.

[Mailbox - Print Settings]

This feature allows you to change the various document print settings.

1. Select [Print Settings] on the [Print/Delete] screen.

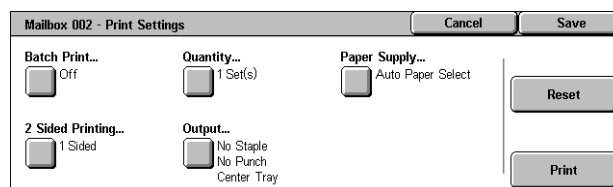
**Batch Print**

Prints multiple documents as a single job. The documents are printed in the order they were selected.

Quantity

Selects the number of copies to print.

Paper Supply

Selects the paper tray from which to print.

2 Sided Printing

Selects [Flip on Long Edge] or [Flip on Short Edge] for 2 sided documents.

Output

Selects a stapling and/or hole-punching option and the output paper tray. The Finisher tray is automatically selected if a stapling and/or hole-punching option is selected.

NOTE: The output options displayed depend on whether or not a finisher is installed, whether the installed finisher is the Integrated Office Finisher or Office Finisher LX, or what options are installed on your finisher.

Reset

Returns the print settings to their defaults.

Print

Prints the document.

Job Flow Settings

This feature allows you to set, modify, or release linkage with a job flow sheet. You can also execute the linked job flow sheet from this screen.

A job flow sheet allows you to process the documents stored in mailboxes. You can link a mailbox to a job flow sheet in advance to automatically execute the job flow sheet when a new document is saved in the mailbox, or you can manually start a job flow sheet as necessary.

NOTE: The job flow sheet that an unauthenticated user creates from this screen can be executed, modified, duplicated, or deleted only from the mailbox in which it was created.

NOTE: Some models require the Network Scanning Kit to enable the Job Flow Sheets service. Other optional kits may also be required depending on the service defined on the job flow sheet.

You can program the following types of document processing in a job flow sheet.

- Specifying destinations (FTP, SMB, E-mail, Fax, and Internet Fax)
- Specifying multiple destinations and batch processing
- Printing

The document processing types you can program in a job flow sheet depend on how documents are stored in a mailbox. See the following chart.

Input	Output						
	Printer	Fax	Internet Fax	E-mail	FTP	SMB	Server Fax
Fax for Polling	○	○	○	○	○	○	
Scan	○	○	○	○	○	○	
Received Fax	○*1	○	○	○	○	○	
Received Internet Fax	○	○	*2	*2	○	○	
Print Stored							

○ : Available

blank: Not available

*1 : If a job is terminated abnormally due to a problem such as a USB cable disconnection while the data is being printed, the document is not deleted after printing, even if the delete-after-printing option is enabled in the mailbox settings.

*2 : Can be processed depending on the settings in the System Administrator mode.

NOTE: Only the job flow sheets you are permitted to execute are displayed on the screen.

1. Select [Job Flow Settings] on the [Document List] screen.

NOTE: To link a document to a job flow sheet, select the required document on the screen.

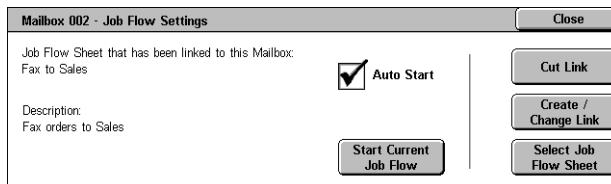

2. Select the required options.

3. Select [Close].

Auto Start

Sets the linked job flow sheet to be automatically executed when a new document is saved in the mailbox. This check box appears only when the mailbox has been linked with a job flow sheet.

NOTE: Mailboxes with this option enabled are marked with a paper and pencil icon next to their names in the mailbox list.

NOTE: The [Auto Start] check box is available only for the mailbox owner.

Start Current Job Flow

Executes the linked job flow sheet and returns to the [Document List] screen. This button appears only when the mailbox has been linked with a job flow sheet.

Cut Link

Releases linkage with a job flow sheet.

NOTE: The [Cut Link] button is available only for the mailbox owner.

Create/Change Link

Displays the [Link Job Flow Sheet to Mailbox] screen.

NOTE: The [Create/Check Link] button is available only for the mailbox owner.

Select Job Flow Sheet

Displays the [Select Job Flow Sheet] screen.

[Link Job Flow Sheet to Mailbox] Screen

This screen allows you to link a job flow sheet to a mailbox.

1. Select [Create/Change Link] on the [Job Flow Settings] screen. The [Link Job Flow Sheet to Mailbox] screen appears.
2. Select the required options.
3. Select [Save].

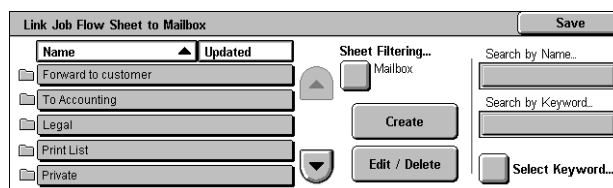

Name/Updated

Sorts the job flow sheets by their names or the dates they were last updated. Selecting the same option again toggles the order in which they are listed, as indicated with an upward (ascending order) triangle shown to the right of [Name] in the above illustration.

Sheet Filtering

Displays the [Sheet Filtering] screen. Refer to *Sheet Filtering on page 153*.

Create

Creates a new job flow sheet to be linked with the mailbox.

NOTE: The job flow sheets you create on this screen can only be executed, modified, or deleted from this mailbox.

Edit/Delete

Allows you to modify or delete an existing job flow sheet.

For more information on [Create] and [Edit/Delete], refer to the Setups chapter in the System Administration Guide.

Search by Name

Displays a screen keyboard. Enter the name of a job flow sheet to search.

Search by Keyword

Displays a screen keyboard. Enter the keyword assigned to a job flow sheet to search.

Select Keyword

Displays the [Select Keyword] screen. Select a preset keyword assigned to a job flow sheet to search.

[Select Job Flow Sheet] Screen

This feature allows you to select and execute a job flow sheet on the documents stored in the selected mailbox.

1. Select [Select Job Flow Sheet] on the [Job Flow Settings] screen.
2. Select the required options.
3. Select [Close].

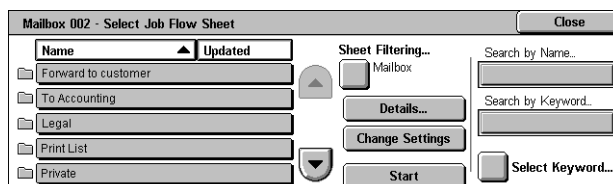

Name/Updated

Sorts the job flow sheets by their names or the dates they were last updated. Selecting the same option again toggles the order in which they are listed, as indicated with an upward (ascending order) triangle shown to the right of [Name] in the above illustration.

Sheet Filtering

Displays the [Sheet Filtering] screen. Refer to *Sheet Filtering on page 153*.

Details

This option becomes active and selectable when you select a job flow sheet. It allows you to view and/or modify the processes registered in the selected job flow sheet. For more information, refer to the Setups chapter in the System Administration Guide.

Change Settings

Allows you to temporarily change job flow sheet settings for the selected job flow sheet.

Start

Executes the selected job flow sheets.

Search by Name

Displays a screen keyboard. Enter the name of a job flow sheet to search.

Search by Keyword

Displays a screen keyboard. Enter the keyword assigned to a job flow sheet to search.

Select Keyword

Displays the [Select Keyword] screen. Select a preset keyword assigned to a job flow sheet to search.

Sheet Filtering

This feature allows you to filter job flow sheets displayed on the screen.

Owner

Allows you to filter job flow sheets by owner.

When the Authentication feature is enabled and logged into the machine with a user ID:

- Shared - Displays the job flow sheets owned by the System Administrator.
- Personal - Displays only the job flow sheets owned by the currently logged-in user.

NOTE: Job flow sheets owned by users other than the currently logged-in user are not displayed.

When the Authentication feature is not enabled:

- System Administrator - Displays only the job flow sheets owned by the System Administrator.
- Non-System Administrator - Displays only the job flow sheets owned by users other than the System Administrator.

NOTE: Job flow sheets owned by users with a user ID are not displayed.

Target

Allows you to filter job flow sheets by target.

- Mailbox - Displays only the job flow sheets whose processing starts with sending or printing a document stored in a mailbox.
- Scan Jobs - Displays only the job flow sheets whose processing starts with scanning a document.
- External Application - Displays only the job flow sheets whose processing starts with accessing an external application.

NOTE: [Scan Jobs] and [External Application] are not available for selection.

Job Flow Sheet Restrictions

Job flow sheets can be restricted to personal use or shared among users, and may be restricted to special mailboxes. For more information on the restrictions for job flow sheets when the Authentication feature is enabled, refer to the Authentication and Account Administration chapter in the System Administration Guide.

7 Job Flow Sheets

This chapter describes the Job Flow Sheets service and the features available on the [Job Flow Sheets] screen.

A job flow sheet can execute a series of programmed operations. To process scanned documents using a job flow sheet created on a networked computer, using a utility such as Job Flow Sheet Editor, use the [Job Flow Sheets] service on the All Services screen.

NOTE: Some models require the Network Scanning Kit to enable the Job Flow Sheets service.

NOTE: To communicate with a networked computer, enable the SOAP port on the machine. For instructions on how to enable the SOAP port, refer to the Setups chapter in the System Administration Guide.

Using the Job Flow Sheets Service

This section describes how to process a scanned document using a job flow sheet created on a networked computer.

1. Press the <All Services> button on the machine.

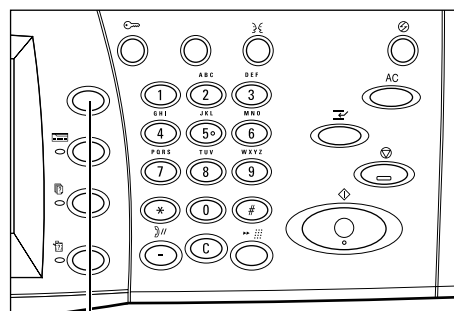

<All Services> button

2. Select [Job Flow Sheets] on the All Services screen.



3. Select a job flow sheet from the list on the [Job Flow Sheets] screen.

NOTE: Only the job flow sheets you are permitted to execute are displayed on the screen.

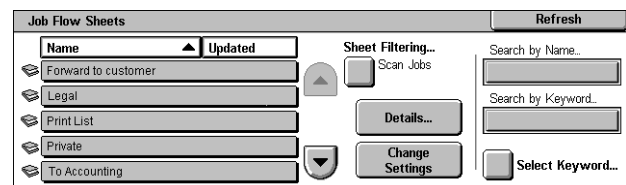

NOTE: The job flow sheets can be sorted by their names or the dates they were last updated by selecting [Name] or [Updated]. Selecting [Name] or [Updated] again toggles the list between ascending and descending order.

4. To view the details of the job flow sheet, select [Details] to display the [Details] screen.
5. Load your document in the document feeder or on the document glass.
6. Press the <Start> button to start scanning the document.

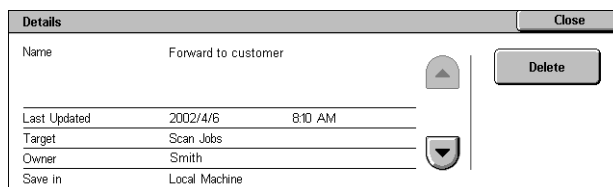

Job Flow Sheets

This section describes the features available on the [Job Flow Sheets] screen.

Sheet Filtering

This feature allows you to filter the job flow sheets listed on the [Job Flow Sheets] screen and display only those that meet the specified conditions.

1. Select [Sheet Filtering] on the [Job Flow Sheets] screen.

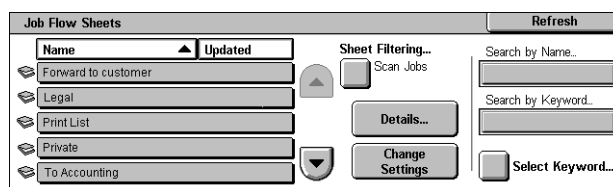

2. Select the required options.

NOTE: For more information on this feature, refer to *Sheet Filtering in the Send from Mailbox chapter on page 153*.

Details

This feature allows you to view the details of a job flow sheet selected on the [Job Flow Sheets] screen. It also allows you to copy, delete, or edit the selected job flow sheet depending on its owner and save location.

NOTE: Job flow sheets saved in a pool server cannot be deleted, copied, or edited.

NOTE: General users cannot delete or edit job flow sheets owned by the System Administrator.

1. Select a job flow sheet on the [Job Flow Sheets] screen.
2. Select the [Details] button. The details of the job flow sheet are displayed.

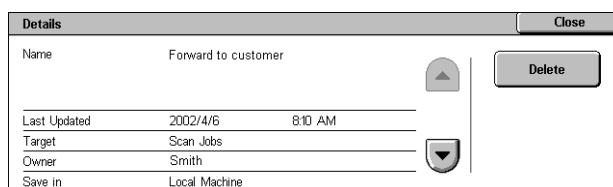

Name

Displays the name of the job flow sheet.

Last Updated

Displays the date on which the job flow sheet was last updated.

Target

Indicates whether the processing starts with scanning a document or accessing an external application.

Owner

Displays the owner of the job flow sheet.

Save In

Displays whether the job flow sheet is saved in the machine or in a pool server.

Description

Displays the description of the job flow sheet.

Delete

Allows you to delete the selected job flow sheet. This button is displayed for the owner of the job flow sheet. Selecting this button displays a screen confirming the deletion of the job flow sheet.

Change Settings

This feature allows you to temporarily change the settings of a job flow sheet selected on the [Job Flow Sheets] screen. The changes will be lost when you select a different job flow sheet.

1. Select a job flow sheet on the [Job Flow Sheets] screen.
2. Select the [Change Settings] button. The [Change Settings] screen is displayed.
3. Select a group you want to modify.

NOTE: Groups marked with an arrow indicate that they have not been configured.

NOTE: Use the scroll buttons to scroll through the list.

4. Set the required items.

NOTE: Items marked with an arrow indicate that they have not been configured.

Previous Group

Displays the setting items of the previous group.

Next Group

Displays the setting items of the next group.

Add E-mail Recipient

Displays a screen that allows you to enter a new recipient address.

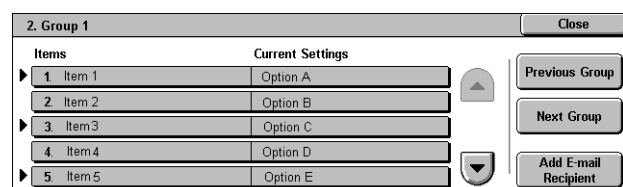
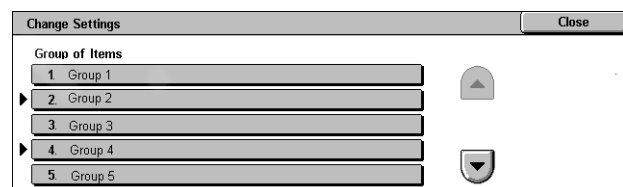
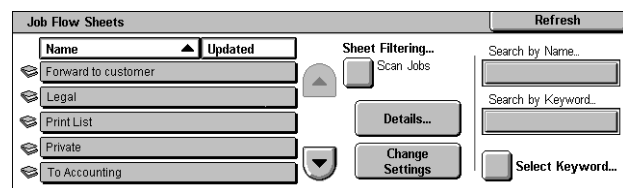

Search by Name/Search by Keyword/Select Keyword

These features allow you to search a job flow sheet by name or keyword.

Search by Name

Displays a screen keyboard. Enter the name of a job flow sheet to search.

Search by Keyword

Displays a screen keyboard. Enter the keyword assigned to a job flow sheet to search.

Select Keyword

Displays the [Select Keyword] screen. Select a preset keyword assigned to a job flow sheet to search. For information on how to preset keywords, refer to the Setups chapter in the System Administration Guide.

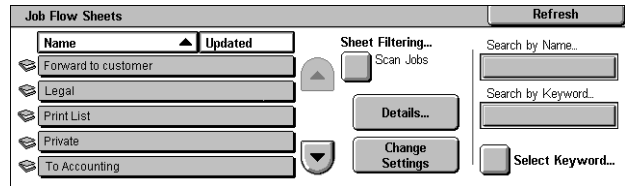

8 Stored Programming

This chapter describes how to use the Stored Programming service to simplify multiple operations into a simple procedure.

The Stored Programming service allows you to do the following:

- Store frequently-used settings as a program, and recall them with a button.
- Store a frequently-used screen as a program, and use the program as a short-cut button to the screen.
- Store a series of operations as a program, and recall it with a button.

NOTE: For information on how to store features, a screen, or a series of operations as a program, refer to the Setups chapter in the System Administration Guide.

Recalling a Stored Program

The following describes how to recall a stored program.

If you recall a stored program, the last screen that was displayed when you stored the program will be displayed.

NOTE: The [Stored Programming] icon is not available on the All Services screen by default. For instructions on how to display the icon on the All Services screen, refer to the Setups chapter in the System Administration Guide.

1. Press the <All Services> button.

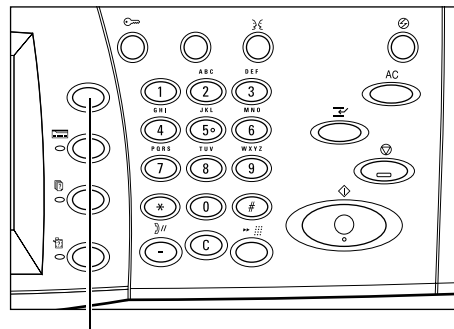

<All Services> button

2. Select [Stored Programming] on the All Services screen.



3. Select the number of the program you want to recall.

NOTE: Use the scroll buttons to switch between screens.

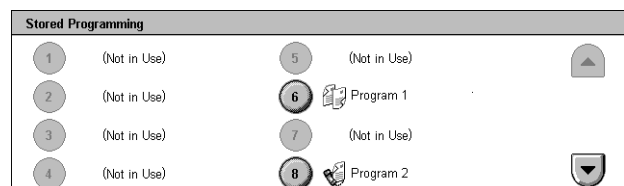

4. When the program is recalled, select other features as necessary.

9 CentreWare Internet Services

This chapter contains a brief overview of the CentreWare Internet Services program.

CentreWare Internet Services uses the embedded HTTP server that resides in the machine. This allows communication with the machine through a web browser with access to the Internet or an intranet. By entering the IP Address of the machine as the URL (Universal Resource Locator) in the browser, direct access to the machine is available.

CentreWare Internet Services allows you to make not only the same basic settings as from the control panel, but also more specialized settings for the machine.

For details on the features provided by CentreWare Internet Services, or for information on how to troubleshoot the program, refer to the CentreWare Internet Services chapter or Problem Solving chapter in the System Administration Guide.

NOTE: This program must be installed and set up by the System Administrator prior to use. For more information on the installation and setups of the CentreWare Internet Services features, refer to the System Administration Guide. Some of the CentreWare Internet Services features will have restricted access. Contact the System Administrator for further assistance.

Accessing CentreWare Internet Services

Follow the steps below to access CentreWare Internet Services.

1. On your computer, launch a web browser.
2. In the URL field, enter "http://" followed by the Internet address of the machine. Then press the <Enter> key on the keyboard.

If you use the domain name to specify the machine, use the following format.

http://myhost.example.com

If you use the IP address to specify the machine, use one of the following formats depending on your machine configuration. The IPv6 format is supported on Windows Vista only. An IPv6 address needs to be enclosed in square brackets.

IPv4: http://xxx.xxx.xxx.xxx

IPv6: http://[xxxx:xxxx:xxxx:xxxx:xxxx:xxxx:xxxx:xxxx]

NOTE: If you have changed the port number from the default port number "80", append the number to the Internet address as follows. In the following examples, the port number is 8080.

Domain name : http://myhost.example.com:8080

IPv4: http://xxx.xxx.xxx.xxx:8080

IPv6: http://[xxxx:xxxx:xxxx:xxxx:xxxx:xxxx:xxxx:xxxx]:8080

The home page of CentreWare Internet Services is displayed.

NOTE: If the Accounting feature is enabled, you may be required to enter the user ID and passcode (if one is set up). If you need assistance, contact the System Administrator.

User Interface

The CentreWare Internet Services home page contains four panels. You can change the left and right panel sizes by dragging the boundary between them.

Header Panel

Displays the header for all pages. The header includes the CentreWare Internet Services logo and the model of the machine. The header for the WorkCentre 5225A/5230A also includes a user mode icon, and the name or type of a logged-in user. Just under this panel on most pages is the tab bar which corresponds to the six functions or page buttons. These are [Status], [Jobs], [Print], [Scan], [Properties], and [Support]. You can navigate through the pages when you click the text on each tab.

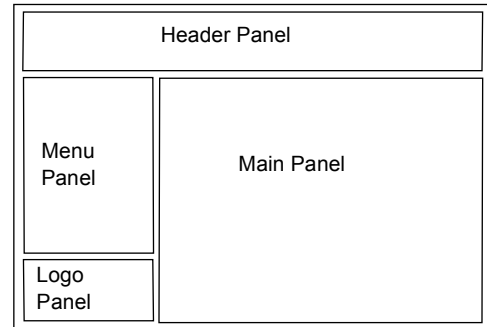

Logo Panel

Displays the company logo.

Menu Panel

Displays a navigation tree, listing the items available within each category, with the currently displayed item highlighted.

Main Panel

Displays information and settings for the selected item within the current category selected in the navigation tree in the menu panel.

Services

The services provided by CentreWare Internet Services are subdivided into the following categories. The category is selected on the tab bar in the header panel.

For details on the features on each tab, refer to the CentreWare Internet Services chapter in the System Administration Guide.

Tab	Feature	Description
Status	<ul style="list-style-type: none"> • General • Trays • Consumables 	Displays the machine information, IP address, and status. It also displays the status of the paper trays, output trays, and consumables.
Jobs	<ul style="list-style-type: none"> • Active Jobs • Job History List • Error History 	Lists active and completed jobs and their status.
Print	<ul style="list-style-type: none"> • Job Submission 	Allows you to specify printing and paper parameters, enter accounting information, and select the delivery method for your print job.
Scan	<ul style="list-style-type: none"> • Job Templates • Mailbox • Job Flow Sheets 	<p>Allows you to create, modify, or delete job templates for Network Scanning jobs. It also allows you to edit scan options and create or edit the filing destination for scanned data.</p> <p>NOTE: Some of the features on this tab are restricted only to the System Administrator. Ask the System Administrator for further assistance.</p>
Properties	<ul style="list-style-type: none"> • Configuration Overview • Descriptions • General Setup • Connectivity • Services • Accounting • Security 	<p>Allows you to view and set the machine properties, including the machine details and configuration, protocol settings, accounting and authentication settings, and security settings.</p> <p>NOTE: The System Administrator can only change the settings on this tab.</p>
Support	<ul style="list-style-type: none"> • Support 	Provides support information, including contacts for technical support and a link for software updates.

10 Glossary

This chapter contains a list of terms used in the User Guide and System Administration Guide. The definition provided for each term reflects the meaning of the term as it is used in the guides.

Terms Defined

Use the following definitions to learn more about the meanings of terms used in this guide.

1000Base-TX	<p>1000Base-T uses all four cable pairs for simultaneous transmission in both directions through the use of echo cancellation and a 5-level pulse amplitude modulation (PAM-5) technique.</p> <p>In 1999, the 802.3ab standard (1000Base-T) allows Gigabit Ethernet to run over Category 5 copper cable, enabling GigE devices to be readily installed in 100BaseT networks without cable changes. The maximum distance between nodes is based on the type of transceiver and cable used.</p>
100Base-TX	<p>100-Mbps baseband Fast Ethernet specification using two pairs of either UTP or STP wiring. The first pair of wires is used to receive data; the second is used to transmit. To guarantee proper signal timing, a 100Base-TX segment cannot exceed 100 meters in length. Based on the IEEE 802.3 standard. See also Ethernet, and IEEE.</p>
10Base-T	<p>10-Mbps baseband Ethernet specification using two pairs of twisted-pair cabling: one pair for transmitting data and the other for receiving data. 10Base-T, which is part of the IEEE 802.3 specification, has a distance limit of approximately 100 meters per segment. See also Ethernet and IEEE.</p>
16 K	<p>194 × 267 mm or 195 x 270 paper. Two slightly different sizes exist depending on the area of purchase.</p>
2 sided	<p>Refers to a document that contains images on both sides of the page. Synonymous with "double-sided".</p>
8 K	<p>267 × 388 mm or 270 x 390 mm paper. Two slightly different sizes exist depending on the area of purchase.</p>
A3	<p>420 × 297 mm paper.</p>
A4	<p>297 × 210 mm paper.</p>
A5	<p>210 × 148 mm paper.</p>
Activity Report	<p>A report that contains information about fax jobs sent and received.</p>
Address Book	<p>A list of fax numbers and e-mail addresses, and file transfer destinations stored in the machine for easy reference.</p>

Annotation	This feature adds the date, page numbers, and a comment to the document.
ASCII	An abbreviation of American Standard Code for Information Interchange. A coding scheme that assigns numeric values to letters, numbers, punctuation, and certain other characters.
Auditron	A tracking system, which is built into the machine. You can use Auditron to track overall machine usage, individual usage and usage of each feature separately.
Auto Center	An image control option used to move the image to the center of the output paper.
Auto Clear	The machine goes to the standby mode, if there is no activity for a specified time.
Auto Receive	A fax mode where the machine receives faxes automatically.
B4	364 × 257 mm paper.
B5	257 × 182 mm paper.
Background Suppression	This feature prevents the reproduction of unwanted background variations resulting from originals that have either a colored background or that are printed on very thin stock on which the images on the second side tend to bleed through.
Book Copying	A scanning option where facing pages of a bound document are copied onto two separate sheets of paper.
Booklet Creation	A copy feature that places images automatically on the paper in a sequence that, when folded, creates a booklet. The machine has the ability to create booklets on a variety of paper stock.
BOOTP	An abbreviation of Bootstrap Protocol. This is a protocol used by a network node to determine the IP address of its Ethernet interfaces, in order to boot a computer from a server via a network.
border limit	A threshold value for the length of a transmitted document before splitting the document onto separate output pages. One more sheet is used when the length of the transmitted document exceeds the length of paper installed on the receiving terminal. A margin at the bottom of a received document can be eliminated so that the data can be printed on one page. The amount of space that can be removed from the bottom of a document is the border limit. When the border limit value is small, the data is printed on the next page. But when it is large, a larger space can be cut so that data can be printed on one page.
bps	An abbreviation of Bits Per Second. This is a measure of how fast a modem can transmit or receive data.
Build Job	This feature allows the machine to accept multiple job segments and combine them into a single job. Each segment can have different characteristics such as paper size, 1-or 2-sided images, or scanned either from the document glass or through the document feeder.
chain dialing	A single dialing command that ties together keypad dialing and dial directory locations for a single dialing operation.

Client Server	A network environment in which the nodes communicate with a file server, and not directly with other nodes.
Collated	An output programming option where each copy set is delivered in the same order the documents were placed in the document feeder. Example: Two copies of a three-page document would output as page 1/copy 1, page 2/copy 1, page 3/copy 1, page 1/copy 2, page 2/copy 2, page 3/copy 2.
contrast	The intensity of the display of an image, or the degree of difference between the gray tones on a document page. See also "halftone" and "photo".
Copy Activity Report	A report that contains information about each copy job.
copy sets	Groups of copies of a multi-page set of documents. If you have a four-page document and you want to make 10 copies of the document, you will be making 10 copy sets.
covers	Paper or media used to add to the front or back of a copy set.
default screen	A screen displayed immediately after switching on the power or pressing the <Clear All> button. The screen is also displayed when the [Auto Clear] feature is used.
default settings	Settings which are incorporated into the machine at the factory and used by the machine when the user does not specify settings.
Delay Start	Programming that enables the machine to process a document at a later time.
DHCP	An abbreviation of Dynamic Host Configuration Protocol. A protocol allowing the principal parameters of network devices (including IP Addresses) to be configured by central DHCP servers.
dial	To use a telephone/fax number for document transmission. The methods of dialing provided by the machine include: manual dialing using the numeric keypad, speed dialing, and using the Address Book, etc.
dial tone	A tone sounds from the telephone line when a remote machine receives a call. You will then know that you are connected to the line.
Dial Type	The dial type of a connected line. The machine offers Tone and 10 pps options.
Direct Fax	Enables PC clients to send faxes via the machine.
DNS	An abbreviation of Domain Name System. A system used by the Internet for translating names of network nodes into addresses.
document feeder	An assembly that automatically separates and feeds single- or double-sided documents from the input tray into the scanner.
dpi	An abbreviation of Dots Per Inch, which is the number of dots that can be printed within a width of one inch. Used as the unit for resolution.
driver	Software that is loaded on the client workstation that prepares data to be sent to the machine.

drum cartridge	A customer replaceable cartridge which contains an internal drum. A printed image is formed on a drum before being transferred to paper.
Dual Tone Multi Frequency (DTMF)	The use of a keypad sequence (tones) to transmit to, or poll from, a remote mailbox.
ECM	An abbreviation of Error Correction Mode: An ITU-T approved feature for Group 3 facsimile machines. ECM transmission sends the document image data in segments and re-transmits segments that the remote machine receives incorrectly. "EC" described on the Activity Report shows that the communication was processed using ECM.
emulation	Printer mode where the printer imitates the functions of another printer language.
encryption	The process of converting data into an un-readable format for security purposes.
Energy Saver modes	Power saver modes that significantly reduce the power consumption during periods of inactivity.
error code	A code that is displayed on the control panel or in a report when a problem occurs.
Ethernet	Network transport technology commonly used to send data from one network node to another.
factory-default settings	See "default settings".
F Code Communication	Communication procedures approved by the Communications and Information network Association of Japan (CIAJ) for the use of T.30* standardized by ITU-T. Between machines with the F Code feature, various features making use of the F Code can be used. (*ITU-T Recommendation)
F4800	A Communication Mode selection that reduces transmission speed to enable reliable communications, even under poor line conditions, which forces the machine to communicate at a maximum of 4800 bits per second.
file server	A computer that has a hard disk drive large enough to hold and share files. It has the ability to allow multiple users to simultaneously access the same file.
frame type	A group of data sent through the network.
FTP	An abbreviation of File Transfer Protocol. An application protocol, part of the TCP/IP protocol stack, used for transferring files between network nodes.
G3	Facsimile communication systems standardized by the advisory committee for International Telecommunications (CCITT, now the ITU-T).
Gateway Address	The Gateway Address is the IP Address of the gateway, or router, that the machine will use to access devices on other subnets.
group dialing	A form of abbreviated dialing that enables the dialing of multiple locations by entering one three-character code. The machine stores the image in memory and then transmits it to each location.

gsm	The metric designation for paper weight in grams per square meter.
halftone	Gray patterns that are neither black nor white.
Head to Head	A double-sided document where the second side displays the image with the top of the document at the top of the page. You typically turn over the page from the side edge.
Head to Toe	A double-sided document where the second side displays the image with the top of the document at the bottom of the page. You typically turn over the page from the bottom edge.
header	The sender's information usually printed at the beginning of a transmitted document.
HTTP	An abbreviation of Hyper Text Transfer Protocol. This is the Internet standard that supports the exchange of information on the World Wide Web (WWW). HTTP lays the foundation for transparent access to the Internet.
IEEE	An abbreviation of Institute of Electrical and Electronics Engineers. This is an organization of engineering and electronics professionals notable for developing the IEEE 802 standards for the physical and data-link layers of local area networks, following the ISO Open Systems Interconnection (OSI) model.
Image Enhancement	An image control option which makes the border between black and white smooth, with rough edges reduced, giving the appearance of a higher resolution.
Image Rotation	An image control option that automatically rotates an image by 90 degrees to fit on the same size paper but with the opposite orientation.
Internet	A worldwide communications network that combines miscellaneous networks.
Internet Fax	Unlike a regular fax machine, Internet Fax uses corporate networks or the Internet to send or receive e-mail (TIFF attachments).
IP	An abbreviation for Internet Protocol. This is a communication protocol of the network layer and is supported by a variety of computer platforms. IP controls the routing of the data.
IPv4/IPv6	Abbreviations for "Internet Protocol Version 4" and "Internet Protocol Version 6". IPv4 addresses are 32-bit identifiers used to address hosts on the Internet. They are expressed in dotted quad format, a series of decimal numbers separated by decimal points. IPv6 is the next generation protocol designed to replace IPv4. IPv6 addresses are 128-bit identifiers expressed in 16-bit hexadecimal numbers separated by colons. IPv6 corrects a number of problems in IPv4, such as the limited number of available addresses.
IPX	Internetwork Packet Exchange. IPX is part of NetWare. It routes packets to the correct node and to the correct process within the node.
job	A group of copy, fax or print data. The cancelling and outputting of copying, faxing, and printing is done on a job basis.

keypad	The buttons on the control panel, or the buttons in a pop-up keypad screen on the touch screen.
LAN	An abbreviation of Local Area Network. This is a network that serves a relatively small area, such as one building, and does not require telecommunications services to reach all of the nodes.
landscape	The image orientation on a sheet of paper, where the short edge of the paper runs from top to bottom.
LDAP	An abbreviation of Lightweight Directory Access Protocol. A protocol that allows sharing of corporate phone book information.
Line Monitor	A function that allows audible monitoring of dial connections.
logical printer	A filter between the network and the physical printers accessible on the network.
Long Edge Feed (LEF)	The long edge of the paper is positioned to enter the machine first.
Long Page Scan	A feature which enables scanning a long document up to 600 mm (23.6 inches).
Low Power mode	An energy saver mode that reduces power consumption when the machine is not in use.
LPD	An abbreviation of Line Printer Daemon. This is a print management program that runs on a host.
mailbox	A storage area in the memory of the machine where fax and scan documents are stored.
Manual Receive	A fax mode that starts receiving a fax or polling after you have communicated with a caller and confirmed that the call is a fax job. Press <Start> to begin receiving.
mask data	Mask data is displayed as special characters in the place of the private data. Data is masked when the forward slash key (/) is selected.
Memory	A capacity for storing documents.
MIME	An abbreviation of Multipurpose Internet Mail Extension. The method used to determine the type of data received by e-mail.
NDS	An abbreviation of Novell Directory Services that was formerly known as NetWare Directory Services. This is a database used by Novell NetWare to organize resources for an entire network of NetWare servers. The database itself can be distributed across the network and accessed by all servers.
NetBEUI	An abbreviation of NetBIOS (Network Basic Input/Output System) Extended User Interface. It is an enhanced version of the NetBIOS protocol that is used by network operating systems, such as LAN Manager, LAN Server, Windows for Workgroups, and Windows NT. NetBEUI formalizes the transport frame and adds additional functions.
NetWare	A network operating system from Novell. Clients log onto one or more file servers, which provide services such as e-mail, printing, and filing.

node	A device on a network that has an address and can send and/or receive data to and from other devices on the network. Also refers to a number that identifies an access point on a network. It works like an address.
On-Hook	You can dial a telephone/fax number or hear the other party, but cannot talk to them. You can also send or receive a fax manually when [On-Hook] is selected.
paper jam	A paper or media misfeed or jam occurring in the machine during printing.
Pathway	The route or sequence a user is required to select buttons to display a service, such as Copy or Fax.
PCL	An abbreviation of Printer Control Language, which is used by Hewlett-Packard. This is a set of commands that tells a printer how to print a document.
PCONSOLE	A NetWare utility that can be used to create, configure, monitor, and manage queues on a NetWare server, and to attach print servers to the queues.
PDF	An abbreviation of Portable Document Format. It is a file format developed by Adobe Systems. A PDF file can describe documents containing text and images, retaining all the formatting and fonts of the original copy. The document can then be displayed or printed, using application software, hardware, or operating system, which may differ from that used to create the original document.
PDL	An abbreviation of Page-Description Language. This refers to a programming language, such as PostScript, that is used to describe output to a printer or a display device, which then uses the instructions from the PDL to construct text and graphics and create the required page image.
Peer-to-Peer	A network environment in which the nodes communicate directly with other nodes. Windows for Workgroups, NetWare Lite, and Macintosh System 7 are examples of peer-to-peer networking products.
photograph	An image, especially a positive print, recorded by a camera and reproduced on a photosensitive surface.
polling	A feature that allows you to retrieve a document from a remote machine.
POP3	An abbreviation of Post Office Protocol Version 3, a protocol used for receiving e-mail. It is a commonly used communications protocol (an agreement governing the way data is transmitted). It provides a private mailbox on the provider e-mail server that receives messages when a connection is made. POP3 is a receive-only function, while the corresponding function for sending e-mail is SMTP.
portrait	The image orientation on a sheet of paper, where the long edge of the paper runs from top to bottom.

PostScript	PostScript is a page description language (PDL) developed by Adobe Systems. It is an object-oriented language, meaning that it treats images, including fonts, as collections of geometrical objects rather than as bitmaps. PostScript is the standard for desktop publishing because it is widely supported by both hardware and software vendors.
print driver	See "driver".
print page buffer	A location where print data is actually processed and stored.
printable area	The actual area on paper which can be printed.
profile	A protocol controlling image resolution, paper size and other attributes when sending or receiving faxes using Internet Fax. The profiles that can be used vary with the Internet Fax of the remote terminal. Find out the type of profile the remote Internet Fax terminal can handle before specifying a profile.
protocol	The rules that control the transmitting and receiving of data.
pulse-to-tone	Switching between dialing types. This is useful when you need pulse mode to connect and tone mode to access a mailbox or another feature.
queue	A place where jobs are stored temporarily, while they are waiting to be processed. A print queue will hold several print jobs.
RAM	Stands for Random Access Memory, which is the memory device where information can be retrieved as well as stored.
RARP	An abbreviation of Reverse Address Resolution Protocol. This is a method for providing IP Addresses to nodes on a network. When a node powers up, it broadcasts a RARP packet containing its Ethernet Address. The RARP server receives the packet and sends the IP Address back to the node.
Receive Buffer	Buffer is the location to store data sent from the client temporarily. By increasing the memory capacity of the receive buffer, the client can be freed earlier.
recipient	A person or terminal you send a document to. In relation to Internet Fax it refers to the e-mail address of a remote terminal.
Remote Mailbox	A feature that allows you to retrieve a document from the mailbox of a remote machine.
remote terminal	This is a general term for terminals such as telephones, facsimile machines, and personal computers.
repository	A storage place for electronic documents.
resolution	The fineness of detail that can be distinguished on a scanned image. Select the standard setting for normal documents and fine and superfine settings for documents with more detail.
ROM	An abbreviation of Read Only Memory, which is a memory device specifically used for the storage and retrieval of information.

router	A device that directs network packets to the segment of the network for which the packet is intended, and excludes packets that are not intended for a segment. Routers reduce unnecessary network traffic and control access to segments of the network.
scan	Sensing or reading a paper document and converting the optical image of the document to an electronic image.
screen	The display on the control panel. It provides user information and instructions.
Server Fax	A fax service which uses a third party fax server.
sharpness	Sharpness adjusts the amount of edge definition on the output. If the image appears slightly out of focus, increasing the sharpness value may make the image clearer.
Short Edge Feed (SEF)	The short edge of the paper is positioned to enter the machine first.
Sleep mode	A condition of reduced power consumption while the machine is not performing a transaction.
SMB	An abbreviation of Server Message Block. A protocol used to share files or printers on Windows OS.
SMTP	Simple Mail Transfer Protocol: A communications protocol (an agreement governing the way data is transmitted) commonly used for sending and receiving e-mail.
SNMP	An abbreviation of Simple Network Management Protocol. A protocol used to help manage complex networks.
speed dialing	A form of abbreviated dialing of a telephone number by entering a 3-digit code.
SPX	An abbreviation of Sequenced Packet Exchange. SPX is part of NetWare. It makes sure that packets are received in the correct order and that there are no errors.
SSDP	An abbreviation of Simple Service Discovery Protocol.
Starting Rate	Selects the communication mode used for transmission to a remote fax machine from G3 or F4800.
stock	The material on which the copies or prints are printed. Synonymous with paper or media.
Store for Polling	To store a document in memory until it is retrieved by a remote fax machine.
Subnet Mask	A mask used to identify which part of an IP Address is the Subnet Address and which part is the host (or device) address.
TBCP Filter	An abbreviation of Tagged Binary Control Protocol. This filter is only available when PostScript is enabled.
TCP/IP	An abbreviation of Transmission Control Protocol/Internet Protocol. TCP/IP is a set of communications protocols that is supported by a variety of computer platforms. TCP controls the data transfer and IP controls the routing of the data. The IP Address is a unique address that identifies a device on a network. The IP Address has to be set in the machine by the System Administrator.

TIFF	An abbreviation of Tagged Image File Format. A standard file format commonly used for scanning. Images scanned with the machine are captured in a TIFF 6.0 file format.
toner cartridge	A customer replaceable cartridge which holds toner, an electrically-charged powder with pigment and plastic, for ease of loading into a printer.
transmission header	A heading printed on the first line of received documents.
transmission interval	The period between transmissions.
Transmission Report	A report that confirms the status of a fax document.
twisted pair	See "10Base-T".
Uncollated	An output programming where the specified number of copies for each page in a copy set is delivered in the order the documents were placed in the document feeder. Example: Two copies of a three-page document would output as page 1/copy 1, page 1/copy 2, page 2/copy 1, page 2/copy 2, page 3/copy 1, page 3/copy 2.
XPS	An abbreviation of XML Paper Specification. It is a file format developed by Microsoft which is similar to Adobe PDF. The XPS option is supported on Windows Vista.

11 Index

Numerics

100Base-TX connector	35
10Base-T connector	35
2 Sided Copying	52
2 Sided Scanning	
E-mail	129
Fax	95
Internet Fax	95
Network Scanning	129
Scan to Mailbox	129
Scan to PC	129
Server Fax	95

A

Acknowledgement Report - Internet Fax	109
Address Book	
E-mail	121
Fax	86, 93
Internet Fax	90
Scan to PC	127
Server Fax	93
adjusting layout	
Copy	57
E-mail	134
Fax	97
Internet Fax	97
Network Scanning	134
Scan to Mailbox	134
Scan to PC	134
Server Fax	97
Advanced Settings	
E-mail	131
Network Scanning	131
Scan to Mailbox	131
Scan to PC	131
AES	25
All Services button	37, 41
Annotations - Copy	68
assembling copy jobs	72
automatic duplex unit	32

B

Background Suppression	
Copy	57
E-mail	132
Network Scanning	132
Scan to Mailbox	132
Scan to PC	132
basic features	
Copy	49
E-mail	120
Fax	94
Internet Fax	94

Network Scanning	124
Scan to Mailbox	124
Scan to PC	125
Server Fax	94
before using the machine	9
Binding Edge Erase - Copy	58, 59
Binding Shift, Booklet Creation	63
blank sheets, inserting between transparencies	65
Book Faxing	
Fax	98
Internet Fax	98
Server Fax	98
Book Scanning	
E-mail	135
Network Scanning	135
Scan to Mailbox	135
Scan to PC	135
Booklet Creation - Copy	62, 63
booklets	62
brightness dial	36
Build Job - Copy	72
bypass tray	32

C

C button	36
Canada, illegal copies	27
cautions and limitations	12
CE, certification in Europe	17
center tray	32, 34
CentreWare Internet Services	161
accessing services	161
menus	163
user interface	162
certifications in Europe (CE)	17
cleaning the machine	14
Clear All button	36
Collation	
Copy	55
color	
scanning color originals	128
Color Scanning	
Scan/E-mail	128
Compression Method	141
confidential Internet Fax documents	147
Confirmation Options - Fax	100
control panel	32, 36
All Services button	37
brightness dial	36
C button	36
Clear All button	36
Dial Pause button	37
Energy Saver button	36
Features button	37

- Interrupt button 36
 - Job Status button 37
 - Language button 36
 - Log In/Out button 36
 - Machine Status button 37
 - numeric keypad 36
 - Speed Dial button 36
 - Start button 36
 - Stop button 36
 - touch screen 36
 - conventions 10
 - Copy 37, 45
 - copying
 - 2 sided copies of facing pages 58
 - 2 sided copies of single or
 - double-sided documents 52
 - assembling a job 72
 - basic features 49
 - booklets, creating 62
 - building jobs in a single operation 72
 - checking the job status 48
 - collating output 55
 - comment/date/page number 68
 - control number watermark 70
 - copy density, adjusting 56
 - covers, adding 65
 - date & time watermark 70
 - deleting unwanted areas on a page 75
 - documents 45
 - double sided 58
 - enlarging an image over multiple sheets 67
 - erasing edges 59
 - erasing the center binding 58, 59
 - facing pages onto separate sheets 57
 - features 47
 - hole-punch position 54
 - image options 56
 - image quality 55
 - inserting blank sheets between
 - transparencies 65
 - inverting images 61
 - layout, adjusting 57
 - loading documents 45
 - manual size originals 59
 - mirroring images 61
 - multiple documents on one sheet 66
 - negative (reversed) images 61
 - orientation 61
 - output format 62
 - page number annotation 68
 - paper tray 51
 - procedure 45
 - quality of the original 56
 - quantity, entering 48
 - reducing/enlarging copy size 49
 - rotating images 60
 - scan size 59
 - scanning different sized originals
 - simultaneously 59
 - serial number watermark 71
 - sharpness, adjusting 56
 - shifting images 60
 - shifting margins 60
 - sorting output 53
 - staple position 54
 - starting a job 48
 - stopping a job 49
 - suppressing backgrounds 57
 - text watermark 70
 - watermark 70
 - country code for Fax service 77
 - Cover Page - Fax 87
 - Covers - Copy 65
 - Covers, Booklet Creation 63
 - Create/Change Link - Send from Mailbox 151
 - cryptographic software 21
 - Custom Services 38
- D**
- Delay Start - Fax 100
 - Delete Outside/Delete Inside - Copy 75
 - deleting mailbox documents 148
 - density
 - adjusting for copy jobs 56
 - adjusting for fax jobs 95
 - adjusting for scan jobs 132
 - DES 25
 - destinations
 - Fax 83
 - Dial Pause button 37
 - Digital Signature
 - E-mail 145
 - Internet Fax 111
 - Direct Fax 77
 - disposing of product 28
 - Divide Output, Booklet Creation 64
 - document feeder 32, 46
 - Long Edge Feed (LEF) 10
 - Short Edge Feed (SEF) 10
 - document feeder glass 34
 - document glass 33, 47
 - documents
 - copying 45
 - cover page, adding 87
 - faxing 78
 - loading 45, 78, 116
 - multiple documents on one sheet 66, 103
 - naming 143
 - numbering 68
 - original type 56, 95
 - remote machines, sending to 84
 - scanning 115
 - sending to multiple recipients 83, 89, 92
 - sending to remote machines 90, 93
 - storing for retrieval from remote machine .. 106
 - double-sided 52, 95, 129
 - drum cartridge 34
 - DTMF, relay broadcasting 84
 - duplex automatic document feeder 32
 - duplex unit 32

E

Edge Erase	
Copy	59
E-mail	136
Network Scanning	136
Scan to Mailbox	136
Scan to PC	136
electrical supply	13
E-mail	37, 115, 120
adding a return address	144
adding sender's address	122, 123
basic features	120
E-mail Options - E-mail	139
Encryption	
E-mail	144
Internet Fax	111
Energy Saver button	36, 40
energy saver modes	
low power mode	40
product overview	40
sleep mode	40
Energy Star, compliance	20
enlarging an image over multiple sheets	67
enlarging copy size	49
enlarging scan size	98
environmental compliance	20
Energy Star	20

F

F Code - Fax	104
F Code, relay broadcasting	84
Fax	38, 77
fax destinations	
Fax	83
Internet Fax	89
Server Fax	92
Fax documents for confidential polling	147
Fax function	
Data Coupler information	18
Send Header requirements	18
fax signals, relay broadcasting	84
faxing	
2 sided documents	95
Address Book, using	86, 93
addresses	83
advanced features	105
basic features	94
communication mode	100
country code	77
cover page, adding comments	88
density level	95
destinations, specifying	80, 83
destinations, specifying using	
special characters	84, 93
fax options	99
header, adding name and phone number	102
job status, checking	82
layout	97
loading documents	78
long fax documents	79

manual size input	97
mixed sized originals	97
multiple documents on one sheet	103
original size	97
original type	95
reducing/enlarging scan size	98
remote machine output	102
remote machine response	
prior to transmission, confirming	108
remote mailbox, using	103
retrieving from remote machines	105
scanning resolution	96
send priority and time	100
sending documents to multiple recipients	83, 92
sending documents to remote machines	84, 93
speed dialing	87
starting a job	81
stopping a job	82
storing for retrieval from remote machine	106
subject and comment (Internet Fax)	81
transmission result mail, receiving	109
transmitting documents with cover page	87
transmitting facing pages on separate	
sheets	98
FDI	35
Features button	37, 41
File Format	
E-mail	140
Network Scanning	140
Scan to Mailbox	140
Scan to PC	140
File Name	
E-mail	143
Network Scanning	143
Scan to PC	143
File Name Conflict	
Network Scanning	143
Scan to PC	143
Filing Options	
Network Scanning	139
Scan to Mailbox	139
Scan to PC	139
Forced F4800 bps	
Fax starting rate	100
Internet Fax communication mode	112
Foreign Device Interface connector	35
Form Overlay - Copy	75
FreeBSD	22
From	
E-mail	122
Internet Fax	91
front cover	32

G

G3 Auto	
fax starting rate	100
Internet Fax communication mode	112
General Settings	
E-mail	128
Fax	94
Internet Fax	94

Network Scanning	128
Scan to Mailbox	128
Scan to PC	128
Server Fax	94
Ground Fault Interrupter (GFI)	35, 40

H

header, adding to fax documents	102
Heimdal	21
High Capacity Feeder	32
High Capacity Tandem Tray (Tray 3, 4)	34
hole-punch position	54

I

ID Card Copying - Copy	71
illegal copies	26
Image Enhancement	
Scan/E-mail	132
Image Options	
Copy	56
E-mail	132
Network Scanning	132
Scan to Mailbox	132
Scan to PC	132
Image Quality - Copy	55
Image Rotation - Copy	60
Image Shift - Copy	60
Integrated Office Finisher	34
front cover	35
staple cartridge	35
top cover	35
Internet Fax	38, 77
communication mode	111
destinations, specifying	89
destinations, specifying using keyboard	89
destinations, specifying using the Address Book	90
inserting comments in body text	91
multiple documents on one sheet	110
sending documents to multiple recipients	89
sending documents to remote machines	90
specifying profiles	109
transmission report, printing	109
Internet Fax Options - Internet Fax	108
Internet Fax Profile	109
TIFF-F	110
TIFF-J	110
TIFF-S	110
Interrupt button	36, 42
Invert Image - Copy	61

J

Job Assembly - Copy	72
Job Flow Settings - Send from Mailbox	149
job flow sheet restrictions	153
job flow sheet, executing documents stored in mailbox	152
Job Flow Sheets	38, 155
Job Interrupt, product overview	42
Job Status	

Copy	48
E-mail	118
Fax	82
Internet Fax	82
Network Scanning	118
Scan to Mailbox	118
Scan to PC	118
Server Fax	82
Job Status button	37, 42
job template	124
JPEG Code	21

K

Keyboard	
E-mail	120
Internet Fax	89
keyboard	
Fax	83

L

Language button	36
language displayed on the touch screen	10
laser safety	16
Layout Adjustment	
Copy	57
E-mail	134
Fax	97
Internet Fax	97
Network Scanning	134
Scan to Mailbox	134
Scan to PC	134
Server Fax	97
LEF	10
left side tray	32
Libcurl	22
license	21
Lighten/Darken	
Copy	56
E-mail	129, 132
Fax	95
Internet Fax	95
Network Scanning	129, 132
Scan to Mailbox	129, 132
Scan to PC	129, 132
Server Fax	95
limitations and cautions	12
Line 1 connector	35
loading documents	45, 78, 116
Log In/Out button	36
Login Name - Network Scanning	145
Long Edge Feed (LEF)	10
low power mode	40

M

machine	
before using	9
components, product overview	32
control panel	36
electrical supply	13
maintenance	14

- operator accessible areas13
 - safety notes12
 - serial number9
 - warning markings13
 - Machine Status button 37, 42
 - Mailbox
 - linking to a job flow sheet149
 - mailbox
 - documents, printing/deleting148
 - job flow sheet restrictions153
 - job flow sheet, selecting152
 - links, creating/changing151
 - sheet filtering153
 - maintenance14
 - Manual Receive - Fax108
 - Manual Send - Fax108
 - Manual Size Input
 - Copy59
 - E-mail136
 - Fax97
 - Internet Fax97
 - Network Scanning136
 - Scan to Mailbox136
 - Scan to PC136
 - Server Fax97
 - manuals, related12
 - Margin Shift - Copy60
 - Message
 - E-mail123
 - Internet Fax91
 - Meta Data - Network Scanning146
 - Mirror Image - Copy61
 - Mixed Sized Originals
 - Copy59
 - E-mail136
 - Fax97
 - Internet Fax97
 - Network Scanning136
 - Scan to Mailbox136
 - Scan to PC136
 - Server Fax97
 - modes
 - All Services41
 - Features41
 - Job Status42
 - Machine Status42
 - product overview41
 - More Fax Options - Fax105
 - MRC High Compression141
 - Multiple103
 - multiple documents on one sheet 66, 103
 - multiple recipients, sending documents to ... 83, 92
 - Multiple-Up
 - Copy66
 - Fax103
 - Internet Fax110
- N**
- Negative Image - Copy61
 - Network Scanning 38, 115, 124
 - basic features124
 - job templates 125
 - Original Orientation 137
 - Transfer Protocol 126
 - New Recipients
 - E-mail 120
 - Internet Fax 89
 - Server Fax 92
 - notes11
 - numeric keypad 36
- O**
- Office Finisher LX 34
 - Booklet Maker 33
 - Booklet Maker side cover 33
 - booklet staple cartridges 33
 - finisher tray 33
 - Folding Unit 33
 - front cover 34
 - front transport cover 34
 - hole punch waste container 34
 - Hole-Punch Unit 34
 - staple cartridge 34
 - top cover 33
 - top transport cover 34
 - tray attachment 33, 42
 - On/Off switch 39
 - On-hook (Manual Send/Receive) - Fax 108
 - OpenLDAP 23
 - operator accessible areas 13
 - orientation
 - for copy jobs 61
 - paper 10
 - Original Orientation
 - E-mail 137
 - Network Scanning 137
 - Scan to Mailbox 137
 - Scan to PC 137
 - Original Size
 - Copy 59
 - E-mail 136
 - Fax 97
 - Internet Fax 97
 - Network Scanning 136
 - Scan to Mailbox 136
 - Scan to PC 136
 - Server Fax 97
 - Original Type
 - Copy 56
 - E-mail 129
 - Fax 95
 - Internet Fax 95
 - Network Scanning 129
 - Scan to Mailbox 129
 - Scan to PC 129
 - Server Fax 95
 - other countries, illegal copies 27
 - Output Format - Copy 62
- P**
- Page Layout - Copy 66
 - paper orientation 10

Paper Supply	
Copy	51
Password - Network Scanning	145
PDF Security	141
PDF Signature	141
photographs, scanning	131
Poster - Copy	67
power switch	32
powering on/off	39
printing mailbox documents	148
Priority Send - Fax	100
product overview	31
energy saver modes	40
Job Interrupt	42
machine components	32
machine services	37
modes	41
powering on/off	39
recycled paper	43
system controls	36
product recycling and disposal	28
battery	28
EU	28
other countries	29
USA, Canada	28
profiles, specifying for Internet Fax	109
Q	
Quality / File Size	
Scan/E-mail	139
R	
Read Receipts - E-mail	142
Recipient Print Sets - Fax	102
recycled paper, product overview	43
recycling	28
Reduce/Enlarge	
Copy	49
E-mail	137
Fax	98
Internet Fax	98
Network Scanning	137
Scan to Mailbox	137
Scan to PC	137
Server Fax	98
reducing copy size	49
reducing scan size	98
regulatory information	17
CE	17
Fax function	18
fax function	18
RFID	20
related information sources	12
Relay Broadcast	
Fax	84
Internet Fax	90
Server Fax	93
remote machine	
output quantity	102
response prior to transmission	108
retrieving documents from	105
sending documents to	84, 93
Remote Mailbox - Fax	103
Remote Polling - Fax	105
Resolution	
E-mail	134
Fax	96
Internet Fax	96
Network Scanning	134
Scan to Mailbox	134
Scan to PC	134
Server Fax	96
resolution, scanning	134
retrieving fax from remote machines	105
RFID, regulatory information	20
RSA BSAFE	21
S	
safety notes	12
battery safety information	15
cleaning the product	14
consumables	16
electrical safety information	14
electrical supply	13
laser safety information	16
machine installation safety information	14
operational safety information	15
ozone information	16
product safety certification	17
radio frequency emissions	17
warning markings	13
Scan Presets	
E-mail	130
Network Scanning	130
Scan to Mailbox	130
Scan to PC	130
scan ratio for the original fax	98
scan size for copy documents	59
Scan to Mailbox	38, 115
Scan to Mailbox, basic features	124
Scan to PC	38, 115
Scan to PC, basic features	125
scanning	
both sides of the document	129
enhancing images	132
erasing edges and margin shadows	136
facing pages onto separate sheets	135
file format	140
file name conflicts	143
filename for saving, specifying	143
FTP/SMB transfer protocol, selecting	126
general settings	128
image quality	131
job status	118
layout	134
loading documents	116
manual size input	136
mixing different sized originals	136
original size	136
output format	139
photographs	131
procedure	115

- quality of original, selecting 129
 - resolution 96, 134
 - saving in a mailbox 124
 - saving on a network server 124
 - saving scanned data 118
 - scan contrast 132
 - scan density 132
 - scanning ratio 137
 - selecting the features 116
 - sending documents using FTP/SMB protocols 125
 - sending in sections 142
 - server, specifying using the Address Book 127
 - specifying image compression ratio 139
 - starting a job 117
 - stopping a job 119
 - suppressing backgrounds 132
 - suppressing shadows 133
 - Searchable Text 141
 - SEF 10
 - Select 152
 - Send from Mailbox 38, 147
 - sending to multiple recipients simultaneously ... 120
 - separators, inserting between
 - transparencies 55, 65
 - serial number 9
 - Server Fax 38, 77
 - services
 - Copy 37, 45
 - Custom Services 38
 - E-mail 37, 115, 120
 - Fax 38, 77
 - Internet Fax 38, 77
 - Job Flow Sheets 38, 155
 - Network Scanning 38, 115, 124
 - Scan to Mailbox 38, 115, 124
 - Scan to PC 38, 115, 125
 - Send from Mailbox 38, 147
 - Server Fax 38, 77
 - Stored Programming 39, 159
 - Shadow Suppression
 - Scan/E-mail 133
 - Sharpness
 - Copy 56
 - E-mail 132
 - Network Scanning 132
 - Scan to Mailbox 132
 - Scan to PC 132
 - sheet filtering, documents in mailbox 153
 - Short Edge Feed (SEF) 10
 - sleep mode 40
 - sorting copy output 53
 - special characters
 - Fax/Internet Fax 84
 - Server Fax 93
 - Speed Dial button 36
 - speed dialing fax numbers 87, 94
 - Split Send - E-mail 142
 - stand 35
 - staple position 54
 - Start button 36
 - Starting Rate
 - Fax 100
 - Internet Fax 111
 - Starting Rate - Internet Fax 111
 - Stop button 36
 - Store for Free Polling
 - storing for polling 106
 - Store for Polling - Fax 106
 - Stored Programming 39, 159
 - storing fax for retrieval from remote machine .. 106
 - Subject
 - E-mail 123
 - Internet Fax 91
 - suppressing backgrounds 57, 132
 - system controls, product overview 36
- ## T
- TEL connector 35
 - TIFF-F Internet Fax profile 110
 - TIFF-J Internet Fax profile 110
 - TIFF-S Internet Fax profile 110
 - toner cartridge 34
 - touch panel display
 - language displayed 10
 - touch screen 36
 - Transfer Protocol - Network Scanning 126
 - Transmission Header Text - Fax 102
 - Transparency Options - Copy 65
 - Tray 1, 2 32
 - Tray 3, 4
 - High Capacity Tandem Tray 34
 - Two Tray Module 32
 - Tray 5 32, 51
 - Tray 6 (High Capacity Feeder) 32
 - tray attachment, attaching 42
 - Two Tray Module (Tray 3, 4) 32
- ## U
- USA, illegal copies 26
 - USB connector 35
- ## W
- warning markings 13
 - warnings 11
 - Watermark - Copy 70
 - website, Xerox 9
 - welcome center, Xerox 9
- ## X
- Xerox website 9
 - Xerox Welcome Center 9
 - XPS Signature 141

