

**XEROX**

Phaser® 6110MFP/B

Colour laser MFP

# User Guide



© 2007 Xerox Corporation. All rights reserved.

This user's guide is provided for information purposes only. All information included herein is subject to change without notice. Xerox is not responsible for any direct or indirect damages, arising from or related to use of this user's guide.

- 6110 MFP/B is the model name Xerox corporation.
- Xerox and Xerox logo are trademarks of Xerox Corporation.
- PCL and PCL 6 are trademarks of Hewlett-Packard company.
- Microsoft, Windows 2000, Windows XP, Windows 2003 and Windows Vista are registered trademarks of Microsoft Corporation.
- TrueType, LaserWriter and Macintosh are trademarks of Apple Computer, Inc.
- All other brand or product names are trademarks of their respective companies or organizations.

# CONTENTS

- 1. Introduction**
  - Special features ..... 1.1
  - Machine overview ..... 1.2
    - Front view ..... 1.2
    - Rear view ..... 1.2
  - Control panel overview ..... 1.3
  - LCD display with the toner cartridge messages ..... 1.4
  - Finding more information ..... 1.4
  - Selecting a location ..... 1.5
  - Printing a demo page ..... 1.5
  - Altitude adjustment ..... 1.5
  
- 2. System setup**
  - Menu overview ..... 2.1
  - Changing the display language ..... 2.2
  - Using the power save mode ..... 2.2
  - Auto continue ..... 2.2
  
- 3. Software overview**
  - Supplied software ..... 3.1
  - Printer driver features ..... 3.1
  - System requirements ..... 3.2
  
- 4. Selecting and loading print media**
  - Loading originals ..... 4.1
  - Selecting print media ..... 4.1
    - Supported print media types and sizes ..... 4.2
    - Media sizes supported in each mode ..... 4.3
    - Guidelines for selecting and storing print media ..... 4.3
    - Guidelines for special print media ..... 4.3
  - Loading paper ..... 4.5
    - In the tray ..... 4.5
    - In the manual feeder ..... 4.7
  - Setting the paper size and type ..... 4.8

<b>5. Copying</b>	
Selecting the paper tray .....	5.1
Copying .....	5.1
Changing the settings for each copy .....	5.1
Reduced/Enlarged copy .....	5.1
Darkness .....	5.2
Original type .....	5.2
Changing the default copy settings .....	5.2
Setting copy timeout .....	5.3
Using special copy features .....	5.3
ID card copying .....	5.3
2-up or 4-up copying .....	5.4
Poster copying .....	5.4
Clone copying .....	5.5
Erasing background images .....	5.5
<b>6. Basic printing</b>	
Printing a document .....	6.1
Canceling a print job .....	6.1
<b>7. Scanning</b>	
Scanning basics .....	7.1
Scanning to an application using a local connection .....	7.1
Changing the settings for each scan job .....	7.2
Changing the default scan settings .....	7.2
<b>8. Using USB flash memory</b>	
About USB memory .....	8.1
Plugging in a USB memory device .....	8.1
Scanning to a USB memory device .....	8.2
Scanning .....	8.2
Customizing scan to USB .....	8.2
Printing from a USB memory device .....	8.3
Managing USB memory .....	8.3
Deleting an image file .....	8.3
Formatting a USB memory device .....	8.3
Viewing the USB memory status .....	8.4
Printing directly from a digital camera .....	8.4
<b>9. Maintenance</b>	
Printing reports .....	9.1
Printing a report .....	9.1
Clearing memory .....	9.1
Cleaning your machine .....	9.2
Cleaning the outside .....	9.2
Cleaning the inside .....	9.2
Cleaning the scan unit .....	9.3
Maintaining the toner cartridge .....	9.4
Toner cartridge storage .....	9.4
Expected cartridge life .....	9.4
Redistributing toner .....	9.4
Replacing the toner cartridge .....	9.5
Replacing the imaging unit .....	9.6

Replacing the waste toner container .....	9.8
Maintenance parts .....	9.9
Checking replaceables .....	9.9
Checking the machine's serial number .....	9.9

## 10. Troubleshooting

Tips for avoiding paper jams .....	10.1
Clearing paper jams .....	10.1
In the tray .....	10.1
In the manual feeder .....	10.2
In the paper exit area .....	10.2
Understanding display messages .....	10.3
Solving other problems .....	10.5
Paper feeding problems .....	10.5
Printing problems .....	10.6
Printing quality problems .....	10.7
Copying problems .....	10.10
Scanning problems .....	10.10
Common Windows problems .....	10.11
Common Macintosh problems .....	10.11
Common Linux problems .....	10.11

## 11. Ordering supplies

Supplies .....	11.1
How to purchase .....	11.1

## 12. Specifications

General specifications .....	12.1
Printer specifications .....	12.1
Scanner and copier specifications .....	12.2

## Index

---

## Safety Introduction

---

### Notices and Safety

Please read the following instructions carefully before operating the machine and refer to them as needed to ensure the continued safe operation of your machine.

Your Xerox product and supplies have been designed and tested to meet strict safety requirements. These include safety agency evaluation and certification, and compliance with electromagnetic regulations and established environmental standards.

The safety and environment testing and performance of this product have been verified using Xerox materials only.

**WARNING:** Unauthorized alterations, which may include the addition of new functions or connection of external devices, may impact the product certification. Please contact your Xerox representative for more information.

---

## Marks and Labels

---

### Symbols

All warnings and instructions marked on or supplied with the product should be followed.



**WARNING:** This symbol alerts users to areas of the equipment where there is the possibility of personal injury.



**WARNING:** This symbol alerts users to areas of the equipment where there are heated or hot surfaces, which should not be touched.



**CAUTION:** This symbol alerts users to areas of the equipment which require special attention to avoid the possibility of personal injury or damage to the equipment.



**WARNING:** This symbol indicates a Laser is being used in the equipment and alerts the user to refer to the appropriate safety information.



**TIP:** This symbol identifies information that is being emphasized and is important for you to remember.

---

## Radio Frequency Emissions

---

### FCC Notices For The USA

**NOTE:** This equipment has been tested and found to comply with the limits for a Class B digital device, pursuant to Part 15 of the FCC Rules. These limits are designed to provide reasonable protection against harmful interference in a residential installation. This equipment generates, uses and can radiate radio frequency energy and, if not installed and used in accordance with the instructions, may cause harmful interference to radio communications. However, there is no guarantee that interference will not occur in a particular installation. If this equipment does cause harmful interference to radio or television reception, which can be determined by

turning the equipment off and on, the user is encouraged to try to correct the interference by one or more of the following measures:

- Reorient or relocate the receiving antenna.
- Increase the separation between the equipment and receiver.
- Connect the equipment into an outlet on a circuit different from that to which the receiver is connected.
- Consult the dealer or an experienced radio/TV technician for help.

Changes or modifications to this equipment not specifically approved by the Xerox Corporation may void the user's authority to operate this equipment.

### EME Compliance for Canada

This Class "B" digital apparatus complies with Canadian ICES-003.

Cet appareil numérique de la classe "B" est conforme à la norme NMB-003 du Canada.

---

## Laser Safety Information

---

### Laser Safety



**CAUTION:** Use of controls, adjustments, or performance of procedures other than those specified in this guide may result in hazardous light exposure.

This equipment complies with international safety standards and is classified as a Class 1 Laser Product.

With specific reference to lasers, the equipment complies with laser product performance standards set by governmental, national, and international agencies as a Class 1 Laser Product. It does not emit hazardous light, as the beam is totally enclosed during all phases of customer operation and maintenance.

---

## Operational Safety Information

---

### Operational Safety Information

Your Xerox equipment and supplies have been designed and tested to meet strict safety requirements. These include safety agency examination, approval, and compliance with established environmental standards.

To ensure the continued safe operation of your Xerox equipment, follow these safety guidelines at all times:

#### **Do These**

- Always follow all warnings and instructions that are marked on or supplied with the equipment.
- Before cleaning this product, unplug the product from the electrical outlet. Always use materials specifically designated for this product, the use of other materials may result in poor performance and create a hazardous situation.

- Do not use aerosol cleaners, they may be explosive and flammable under certain conditions
- Always exercise care when moving or relocating equipment. Please contact your local Xerox Service Department to arrange relocation of the copier to a location outside of your building.
- Always locate the machine on a solid support surface (not on plush carpet) that has adequate strength to support the weight of the machine.
- Always locate the machine in an area that has adequate ventilation and room for servicing.
- Always unplug this equipment from the electrical outlet before cleaning.
- **NOTE:** *Your Xerox machine is equipped with an energy saving device to conserve power when the machine is not in use. The machine may be left on continuously.*
- **WARNING:** The metallic surfaces in the fuser area may be hot. Please use caution when removing paper jams from this area and avoid touching any metallic surfaces

### **Do Not Do These**

- Never use a ground adapter plug to connect the equipment to a power outlet that lacks a ground connection terminal.
- Never attempt any maintenance function that is not specifically described in this documentation.
- Never obstruct ventilation openings. They are provided to prevent overheating.
- Never remove covers or guards that are fastened with screws. There are no operator serviceable areas within these covers.
- Never locate the machine near a radiator or any other heat source.
- Never push objects of any kind into the ventilation openings.
- Never override or "cheat" any of the electrical or mechanical interlock devices.
- Never place this equipment where people might step on or trip on the power cord.
- This equipment should not be placed in a room unless proper ventilation is provided. Please contact your local Authorized dealer for further information.

### **Warning - Electrical Safety Information**

- 1 The power receptacle for the machine must meet the requirements stated on the data plate on the rear of the machine. If you are not sure that your electrical supply meets the requirements, please consult your local power company or an electrician for advice.
- 2 The socket outlet shall be installed near the equipment and shall be easily accessible.
- 3 Use the power cable that is supplied with your machine. Do not use an extension cord or remove or modify the power cord plug.
- 4 Plug the power cable directly into a correctly grounded electrical outlet. If you are not sure whether or not an outlet is correctly grounded, consult an electrician.

- 5 Do not use an adapter to connect any Xerox equipment to an electrical outlet that lacks a ground connection terminal.
- 6 Do not place this equipment where people might step or trip on the power cable.
- 7 Do not place objects on the power cable.
- 8 Do not override or disable electrical or mechanical interlock devices.
- 9 Do not push objects into slots or openings on the machine. Electrical shock or fire may result.
- 10 Do not obstruct ventilation openings. These openings are used to provide proper cooling to the Xerox machine.
- 11 **Disconnect Device:** The power cable is the disconnect device for this equipment. It is attached to the back of the machine as a plug-in device. To remove all electrical power from the machine, disconnect the power cable from the electrical outlet

### **Electrical Supply**

- 1 This product shall be operated from the type of electrical supply indicated on the product's data plate label. If you are not sure that your electrical supply meets the requirements, please consult your local power company for advice.



- 2 **WARNING:** This equipment must be connected to a protective earth circuit. This equipment is supplied with a plug that has a protective earth pin. This plug will only fit into an earthed electrical outlet. This is a safety feature. If you are unable to insert the plug into the outlet, contact your electrician to replace the outlet.
- 3 Always connect equipment to a correctly grounded power outlet. If in doubt, have the outlet checked by a qualified electrician.

### **Disconnect Device**

The power cable is the disconnect device for this equipment. It is attached to the back of the machine as a plug-in device. To remove all electrical power from the equipment, disconnect the power cable from the electrical outlet.

### **Emergency Power Off**

If any of the following conditions occur, turn off the machine immediately and **disconnect the power cable(s) from the electrical outlet(s)**. Contact an authorized Xerox Service Representative to correct the problem:

- The equipment emits unusual odors or makes unusual noises.
- The power cable is damaged or frayed.
- A wall panel circuit breaker, fuse, or other safety device has been tripped.
- Liquid is spilled into the machine.
- The machine is exposed to water.
- Any part of the machine is damaged

## Ozone Information

This product produces ozone during normal operation. The ozone produced is heavier than air and is dependent on copy volume. Install the system in a well-ventilated room with the minimum size requirements listed below. Providing the correct environmental parameters will ensure that the concentration levels meet safe limits.

The minimum room volume (in cubic meters) requirements are listed in the product [Installation Preparation Document](#).

To determine if the room has the required volume to meet the ozone requirement, the length of the room multiplied by its width and height should be equal to or greater than the cubic volume listed above.

If you need additional information about ozone, please request the Xerox publication *Facts About Ozone* (part number 610P64653) by calling 1-800-828-6571 in the United States and Canada. In other markets, please contact your local Xerox representative.

## Maintenance Information

- 1 .Any operator product maintenance procedures will be described in the customer documentation supplied with the product.
- 2 Do not carry out any maintenance on this product which is not described in the customer documentation
- 3 Do not use aerosol cleaners. The use of cleaners that are not approved may cause poor performance of the equipment, and could cause a dangerous condition.
- 4 Use supplies and cleaning materials only as directed in this manual.
- 5 Do not remove covers or guards that are fastened with screws. There are no parts behind these covers that you can maintain or service.
- 6 Do not perform any maintenance procedures unless you have been trained to do them by an authorized local dealer or unless a procedure is specifically described in the user manuals.

## Consumables Information

- 1 Store all consumables in accordance with the instructions given on the package or container.
- 2 Keep all consumables away from the reach of children.
- 3 Never throw toner, print cartridges or toner containers into an open flame.

## Product Safety Certification

This product is certified by the following Agency using the Safety standards listed

Agency	Standard
TBD	UL60950-1 1st (2003) First Edition (USA/ Canada)
TBD	IEC60950-1: 2001 First Edition

## Regulatory Information

### Certification in Europe

**CE** The CE mark applied to this product, symbolizes XEROX's declaration of conformity with the following applicable European Union Directives, as of the dates indicated:

**December 12, 2006:** Council Directive 2006/95/EC as amended. Approximation of the laws of the member states related to low voltage equipment.

**December 15, 2004:** Council Directive 2004/108/EC as amended. Approximation of the laws of the member states related to electromagnetic compatibility.

A full declaration of conformity, defining the relevant directives and referenced standards, can be obtained from your XEROX Limited representative or by contacting;

Environment, Health and Safety

The Document Company Xerox

Bessemer Road

Welwyn Garden City

Herts

AL7 1HE

England, Telephone +44 (0) 1707 353434

**WARNING:** *In order to allow this equipment to operate in proximity to Industrial, Scientific and Medical (ISM) equipment, the external radiation from the ISM equipment may have to be limited or special mitigation measures taken.*

**WARNING:** Shielded interface cables must be used with this product to maintain compliance with Council Directive 89/336/EEC

### Product Recycling & Disposal:

#### USA & Canada

Xerox operates a worldwide equipment take back and reuse/recycle program. Contact your Xerox sales representative (1-800-ASK-XEROX) to determine whether this Xerox product is part of the program. For more information about Xerox environmental programs, visit [www.xerox.com/environment.html](http://www.xerox.com/environment.html).

If your product is not part of the Xerox program and you are managing its disposal, please note that the product may contain lead and other materials whose disposal may be regulated due to environmental considerations. For recycling and disposal information, contact your local authorities. In the United States, you may also refer to the Electronic Industries Alliance web site: [www.eiae.org](http://www.eiae.org)

#### European Union

##### WEEE Directive 2002/96/EC

Some equipment may be used in both a domestic/household and a professional/business application





### Professional/Business Environment

Application of this symbol on your equipment is confirmation that you must

dispose of this equipment in compliance with agreed national procedures. In accordance with European legislation, end of life electrical and electronic equipment subject to disposal must be managed within agreed procedures.



### Domestic/Household Environment

Application of this symbol on your equipment is confirmation that you should

not dispose of the equipment in the normal household waste stream. In accordance with European legislation, end of life electrical and electronic equipment subject to disposal must be segregated from household waste.

Private households within EU member states may return used electrical and electronic equipment to designated collection facilities free of charge. Please In some member states, when you purchase new equipment, your local retailer may be required to take back your old equipment free of charge. Please ask your retailer for information.

Prior to disposal, please contact your local dealer or Xerox representative for end of life takeback information.

### **(USA, Canada)**

If you are managing the disposal of your Xerox product, please note that the product contains, **Lead\***, **lamp(s) with mercury\***, **Perchlorate\*** and other materials whose disposal may be regulated due to environmental considerations. The presence of these materials is fully consistent with global regulations applicable at the time that the product was placed on the market. For recycling and disposal information, contact your local authorities. In the United States, you may also refer to the Electronic Industries Alliance web site:

**Perchlorate Material - This product may contain one or more Perchlorate-containing devices, such as batteries. Special handling may apply, please see [www.dtsc.ca.gov/hazardouswaste/perchlorate](http://www.dtsc.ca.gov/hazardouswaste/perchlorate)\***.

### **Vermont Mercury**

In 2005, Vermont passed new legislation that posed labeling requirements to include nearly all mercury-added products sold into the state. The overall impact of this bill requires Xerox to label its owner's manual AND product as a means to inform the end user the presence of mercury. All mercury-added products sold after July 1, 2007 must be labeled under the provisions of the new law and in accordance with a labeling plan approved by the State of Vermont.

The scope of this legislation impacts all **products containing mercury lamps\*** (removable / non-removable); such as scanner lamps used for both backlighting and non-backlighting purposes. Based upon Xerox approved Certified Labeling Plan, the following language must be included in the owner's manual or addendum to the owner's manual:

"Xerox operates a worldwide equipment takeback and reuse/recycle program. Contact your Xerox sales representative (1-800-ASK-XEROX) to determine whether this Xerox product is part of the program. For more information about Xerox environmental programs, visit [www.xerox.com/environment](http://www.xerox.com/environment).

If you are managing the disposal of your Xerox product, please note that the product contains **lamp(s) with mercury**, and may contain lead, Perchlorate and other materials whose disposal may be regulated due to environmental considerations. The presence of these materials is fully consistent with global regulations applicable at the time that the product was placed on the market. For recycling and disposal information, contact your local authorities. In the United States, you may also refer to the Electronic Industries Alliance web site: [www.eiae.org](http://www.eiae.org)."

## Energy program compliance

### USA

#### ENERGY STAR

As an ENERGY STAR® partner, Xerox Corporation has determined that this product meets the ENERGY STAR guidelines for energy efficiency.



The ENERGY STAR and ENERGY STAR MARK are registered United States

trademarks. The ENERGY STAR Imaging Equipment Program is a team effort between U.S., European Union and Japanese governments and the office equipment industry to promote energy-efficient copiers, printers, fax, multifunction machine, personal computers, and monitors. Reducing product energy consumption helps combat smog, acid rain and long-term changes to the climate by decreasing the emissions that result from generating electricity.

Xerox ENERGY STAR equipment is preset at the factory. Your machine will be delivered with the timer for switching to Power Save Mode from the last copy/print out, set at 15 minutes. A more detailed description of this feature can be found in the Machine Setup Section of this guide.

### Canada

#### Environmental Choice

Terra Choice Environmental Serviced, Inc. of Canada has verified that this product conforms to all applicable Environmental Choice EcoLogo requirements for minimized impact to the environment.

As a participant in the Environmental Choice program, Xerox Corporation has determined that this product meets the Environmental Choice guidelines for energy efficiency.



Environment Canada established the Environmental Choice program in 1988 to help consumers identify environmentally responsible products and services. Copier, printer, digital press and fax products must meet energy efficiency and emissions criteria, and exhibit compatibility with recycled supplies. Currently, Environmental Choice has

more than 1600 approved products and 140 licensees. Xerox has been a leader in offering EcoLogo approved products.

---

## Section 16 Illegal Copies

---

### USA

Congress, by statute, has forbidden the reproduction of the following subjects under certain circumstances. Penalties of fine or imprisonment may be imposed on those guilty of making such reproductions.

- 1 Obligations or Securities of the United States Government, such as:  
Certificates of Indebtedness National Bank Currency  
Coupons from Bonds Federal Reserve Bank Notes  
Silver Certificates Gold Certificates  
United States Bonds Treasury Notes  
Federal Reserve Notes Fractional Notes  
Certificates of Deposit Paper Money  
Bonds and Obligations of certain agencies of the government, such as FHA, etc  
Bonds. (U.S. Savings Bonds may be photographed only for publicity purposes in connection with the campaign for the sale of such bonds.)  
Internal Revenue Stamps. (If it is necessary to reproduce a legal document on which there is a canceled revenue stamp, this may be done provided the reproduction of the document is performed for lawful purposes.)  
Postage Stamps, canceled or uncanceled. (For philatelic purposes, Postage Stamps may be photographed, provided the reproduction is in black and white and is less than 75% or more than 150% of the linear dimensions of the original.)  
Postal money Orders. Bills, Checks, or Draft of money drawn by or upon authorized officers of the United States.  
Stamps and other representatives of value, of whatever denomination, which have been or may be issued under any Act of Congress.
- 2 Adjusted Compensation Certificates for Veterans of the World Wars.
- 3 Obligations or Securities of any Foreign Government, Bank, or Corporation.
- 4 Copyrighted materials, unless permission of the copyright owner has been obtained or the reproduction falls within the "fair use" or library reproduction rights provisions of the copyright law. Further information of these provisions may be obtained from the Copyright Office, Library of Congress, Washington, D.C. 20559. Ask for Circular R21.
- 5 Certificates of Citizenship or Naturalization. (Foreign Naturalization Certificates may be photographed.)
- 6 Passports. (Foreign Passports may be photographed.)
- 7 Immigration Papers.
- 8 Draft Registration Cards.
- 9 Selective Service Induction Papers that bear any of the following Registrant's information: Earnings or Income Dependency Status Court Record Previous military service  
Physical or mental condition

Exception: United States military discharge certificates may be photographed.

- 10 Badges, Identification Cards, Passes, or Insignia carried by military personnel, or by members of the various Federal Departments, such as FBI, Treasury, etc. (unless photograph is ordered by the head or such department or bureau.)

Reproducing the following is also prohibited in certain states: Automobile Licenses - Drivers' Licenses - Automobile Certificates of Title.

**NOTE:** The above list is not all-inclusive, and no liability is assumed for its completeness or accuracy. In case of doubt, consult your attorney.

### Canada

Parliament, by statute, has forbidden the reproduction of the following subjects under certain circumstances. Penalties of fine or imprisonment may be imposed on those guilty of making such reproductions.

- 1 Current bank notes or current paper money.
- 2 Obligations or securities of a government or bank.
- 3 Exchequer bill paper or revenue paper.
- 4 The public seal of Canada or of a province, or the seal of a public body or authority in Canada, or of a court of law.
- 5 Proclamations, orders, regulations or appointments, or notices thereof (with intent to falsely cause same to purport to have been printed by the Queen's Printer for Canada, or the equivalent printer for a province).
- 6 Marks, brands, seals, wrappers or designs used by or on behalf of the Government of Canada or of a province, the government of a state other than Canada or a department, board, Commission or agency established by the Government of Canada or of a province or of a government of a state other than Canada.
- 7 Impressed or adhesive stamps used for the purpose of revenue by the Government of Canada or of a province or by the government of a state other than Canada.
- 8 Documents, registers or records kept by public officials charged with the duty of making or issuing certified copies thereof, where the copy falsely purports to be a certified copy thereof.
- 9 Copyrighted material or trademarks of any manner or kind without the consent of the copyright or trademark owner.

**NOTE:** The above list is provided for your convenience and assistance, but it is not all-inclusive, and no liability is assumed for its completeness or accuracy. In case of doubt, consult your solicitor.

### Other countries

Copying certain documents may be illegal in your country. Penalties of fine or imprisonment may be imposed on those found guilty of making such reproductions.

Currency notes

Bank notes and cheques

Bank and government bonds and securities  
Passports and identification cards  
Copyright material or trademarks without the consent of the owner  
Postage stamps and other negotiable instruments

**NOTE:** This list is not inclusive and no liability is assumed for either its completeness or accuracy. In case of doubt, contact your legal counsel.

---

## Section 17 EH&S Contact Information

---

### *Contact Information*

For more information on Environment, Health, and Safety in relation to this Xerox product and supplies, please contact the following customer help lines:

USA:1-800 828-6571

Canada:1-800 828-6571

Europe:+44 1707 353 434

---

## Section 18 EH&S Decisions on User Safety Notes

---

**Hard Copy Safety Notes:** If the hard copy safety notes are provided to the customer at the initial install, there is no requirement to provide additional hard copies when other documentation is printed out. However, the safety notes should still be provided on the CD-ROM for reference purposes. That way, if the customer loses the original hardcopy, the safety information will still be available to them.

# 1 Introduction

Thank you for purchasing this **Xerox** multifunctional product. Your machine provides printing, copying, scanning functions.

This chapter includes:

- **Special features**
- **Machine overview**
- **Control panel overview**
- **LCD display with the toner cartridge messages**
- **Finding more information**
- **Selecting a location**
- **Printing a demo page**
- **Altitude adjustment**

---

## Special features

---

Your new machine is equipped with special features.

### Print with excellent quality and speed



- You can print in full range of colors using cyan, magenta, yellow, and black.
- You can print up to 2400 x 600 dpi (effective output). For details, see the **Software section**.
- In Black and White mode, your machine prints A4-sized paper at up to 16 ppm<sup>a</sup> and letter-sized paper at up to 17 ppm. In Color mode, your machine prints A4-sized or letter sized paper at up to 4 ppm.

### Handle paper flexibly

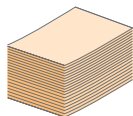

- The **manual feeder** supports letterhead, envelopes, labels, transparencies, custom-sized media, postcards, and heavy paper. The **manual feeder** supports 1 sheet of paper.
- The **150-sheet tray** support plain paper in various sizes.

### Create professional documents

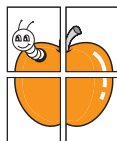

- Print **Watermarks**. You can customize your documents with words, such as "Confidential." See the **Software section**.
- Print **Posters**. The text and pictures of each page of your document are magnified and printed across the sheets of paper and can then be taped together to form a poster. See the **Software section**.

### Save time and money

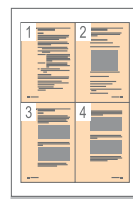

- You can print multiple pages on one single sheet of paper to save paper.
- You can use preprinted forms and letterhead with plain paper. See the **Software section**.
- This machine automatically **conserves electricity** by substantially reducing power consumption when not in use.

### Print in various environments



- You can print with **Windows 2000** and **Windows XP/2003/Vista** as well as **Linux** and **Macintosh** systems.
- Your machine is equipped with a **USB** interface.

### Copy originals in several formats

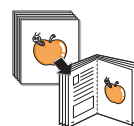

- Your machine can print multiple image copies from the original document on a single page.
- There are special functions to erase catalog and newspaper background.
- The print quality and image size may be adjusted and enhance at the same time.

### Scan the originals and send it right away

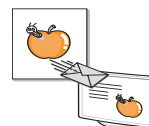

- Scan in color and use the precise compressions of JPEG, TIFF and PDF formats.

### Machine features

The table below lists a general overview of features supported by your machine.

(I: Installed)

Features	6110 MFP/B
USB 2.0	I
USB Memory	I
PictBridge	I

a. pages per minute

## Machine overview

These are the main components of your machine:

### Front view

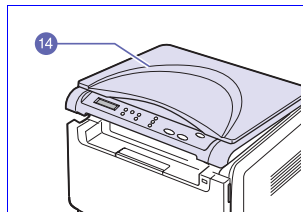
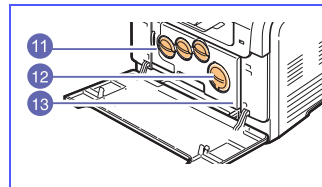
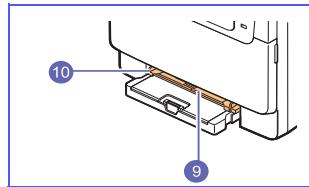
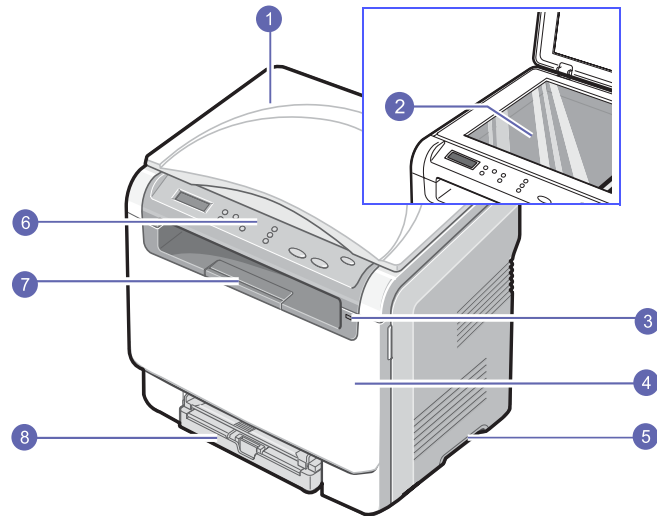

1	scanner cover	8	tray
2	scanner glass	9	manual feeder
3	USB memory port	10	manual feeder paper width guides
4	front cover	11	waste toner container
5	handle	12	toner cartridges
6	control panel	13	imaging unit
7	output support	14	scan unit



### Tip

The surface of the output tray may become hot if you print a large number of pages at once. Please make sure that you don't touch the surface, and prevent children from approaching it.

### Rear view

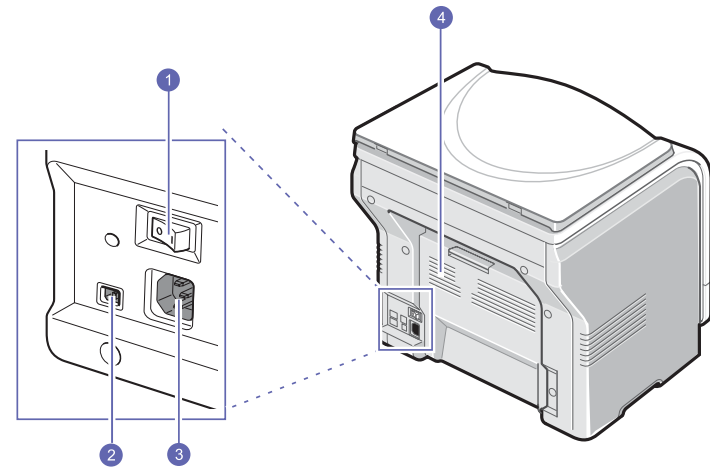

1	power switch	3	power receptacle
2	USB port	4	rear cover

## Control panel overview

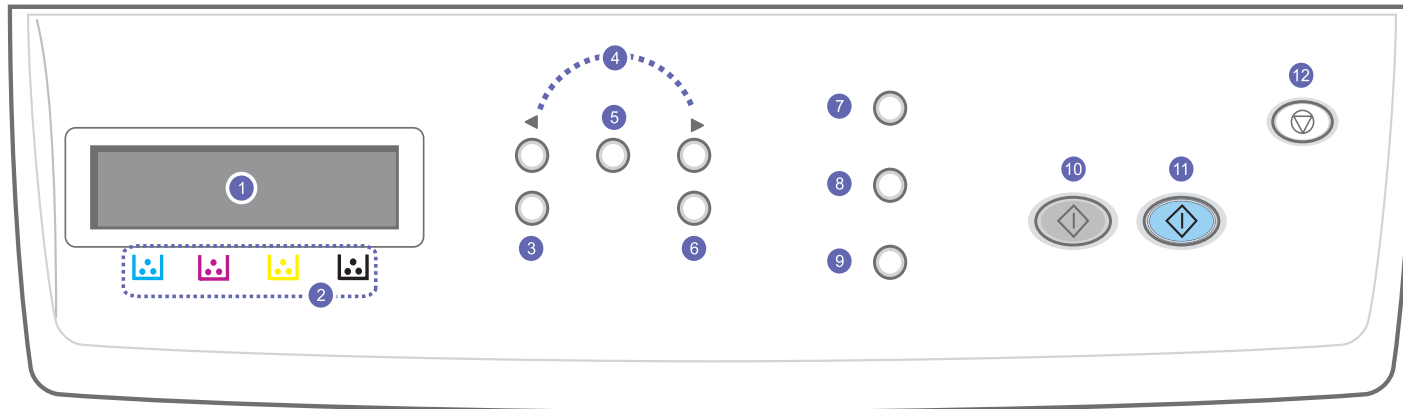

1	<b>Display:</b> Shows the current status and prompts during an operation.	7	<b>Original Type:</b> See the document type for the current copy job. See page 5.2.
2	<b>Toner colors:</b> The toner colors shown below the LCD display co-works with display messages.	8	<b>USB Print:</b> Allows you to directly print files stored on a USB flash drive when it is inserted into the USB port in the front of your machine. See page 8.1.
3	<b>Menu:</b> Enters Menu mode and scrolls through the available menus.	9	<b>Scan To:</b> Allows you to access a list of the PC software programs that an image can be scanned to. See page 7.1.
4	<b>Scroll buttons:</b> Scroll through the options available in the selected menu, and increase or decrease values.	10	<b>Black Start:</b> Starts a job in Black and White mode.
5	<b>Enter:</b> Confirms the selection on the screen.	11	<b>Color Start:</b> Starts a job in Color mode.
6	<b>Exit:</b> Sends you back to the upper menu level.	12	<b>Stop/Clear:</b> Stops an operation at any time. In Standby mode, clears/cancels the copy options, such as the darkness, the document type setting, the copy size, and the number of copies.

## LCD display with the toner cartridge messages

The status of toner cartridges is indicated by the LCD display. If the toner cartridge is low or needs to be changed, the display shows the message. The arrow mark (or marks) shows which color toner is of concern.

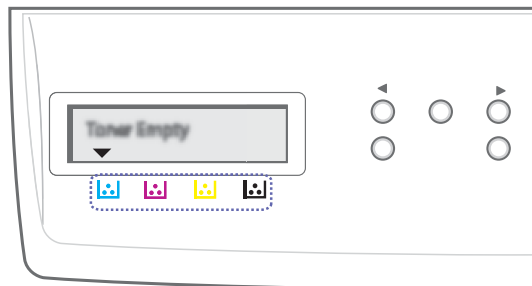

The above example shows the toner cartridges' status of the color shown by arrows. Check the message to find out what the problem is and how to solve it. See page 10.3 to browse the detailed information on error messages.

## Finding more information

You can find information for setting up and using your machine from the following resources, either printed or onscreen.

### Quick Install Guide



Provides information on setting up your machine.

### Online User's Guide



Provides you with step-by-step instructions for using your machine's full features, and contains information for maintaining your machine, troubleshooting, and installing accessories.

This user's guide also contains the **Software section** providing you with information on how to print documents with your machine on various operating systems, and how to use the supplied software utilities.



#### Tip

You can access the user's guides in other languages from the **Manual** folder on the Printer software CD.

### Printer Driver Help



Provides you with help information on printer driver properties and instructions for setting up the properties for printing. To access a printer driver help screen, click **Help** from the printer properties dialog box.

### Website

If you have Internet access, you can get help, support, printer drivers, manuals, and order information from the **Xerox** website, [www.xerox.com](http://www.xerox.com).



## Selecting a location

Select a level, stable place with adequate space for air circulation. Allow extra space for opening covers and trays.

The area should be well-ventilated and away from direct sunlight or sources of heat, cold, and humidity. Do not set the machine close to the edge of your desk or table.

### Clearance space

- **Front:** 482.6 mm (enough space so that the paper tray can be removed)
- **Back:** 100 mm (enough space for ventilation)
- **Right:** 100 mm (enough space for ventilation)
- **Left:** 100 mm (enough space for ventilation)

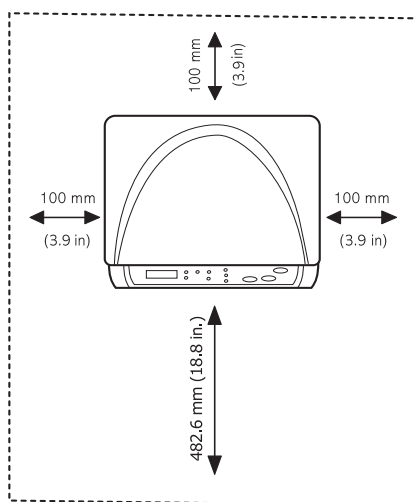

### Tip

When you move the printer, do not tilt or turn it upside down. Or the inside of the printer may be contaminated by toner, which can cause damage to the printer or bad printing quality.

Place the machine on a flat and stable surface not letting it lean more than 2 mm (0.08 inches). Otherwise, it may affect the printing quality.

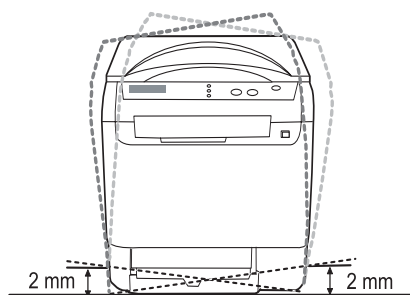

## Printing a demo page

Print a demo page to make sure that the machine is operating correctly.

To print a demo page:

In Ready mode, press and hold the **Enter** button for about 2 seconds.

## Altitude adjustment

The print quality is affected by atmospheric pressure, which is determined by the height of the machine above sea level. The following information will guide you on how to set your machine to the best print quality or best quality of print.

Before you set the altitude value, find the altitude where you are using the machine.

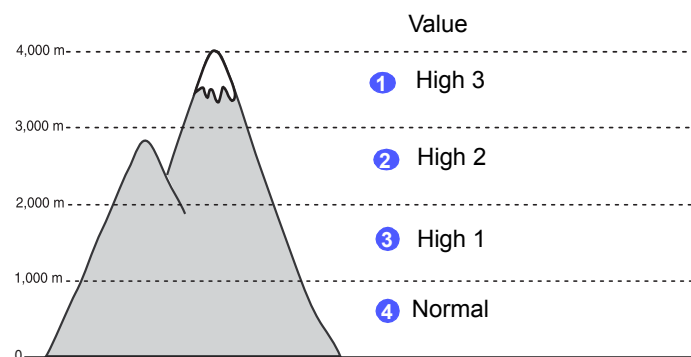

- 1 Ensure that you have installed the printer driver with the provided Printer Software CD.
- 2 Click the Windows **Start** menu.
- 3 Click **Printer Setting Utility**.
- 4 Click **Settings > Altitude Adjustment**. Select the appropriate value from the dropdown list, and then click **Apply**.



## 2 System setup

This chapter gives you an overview of menus available on your machine and step-by-step instructions for setting up the machine's systems.

This chapter includes:

- **Menu overview**
- **Changing the display language**
- **Using the power save mode**
- **Auto continue**

### Menu overview

The control panel provides access to various menus to set up the machine or use the machine's functions. These menus can be accessed by pressing **Menu**. Refer to the following diagram. Menus available in Copy or Scan mode vary.



#### Tip

Some menus may not appear in the display depending on your country. If so, it is not applicable to your machine.

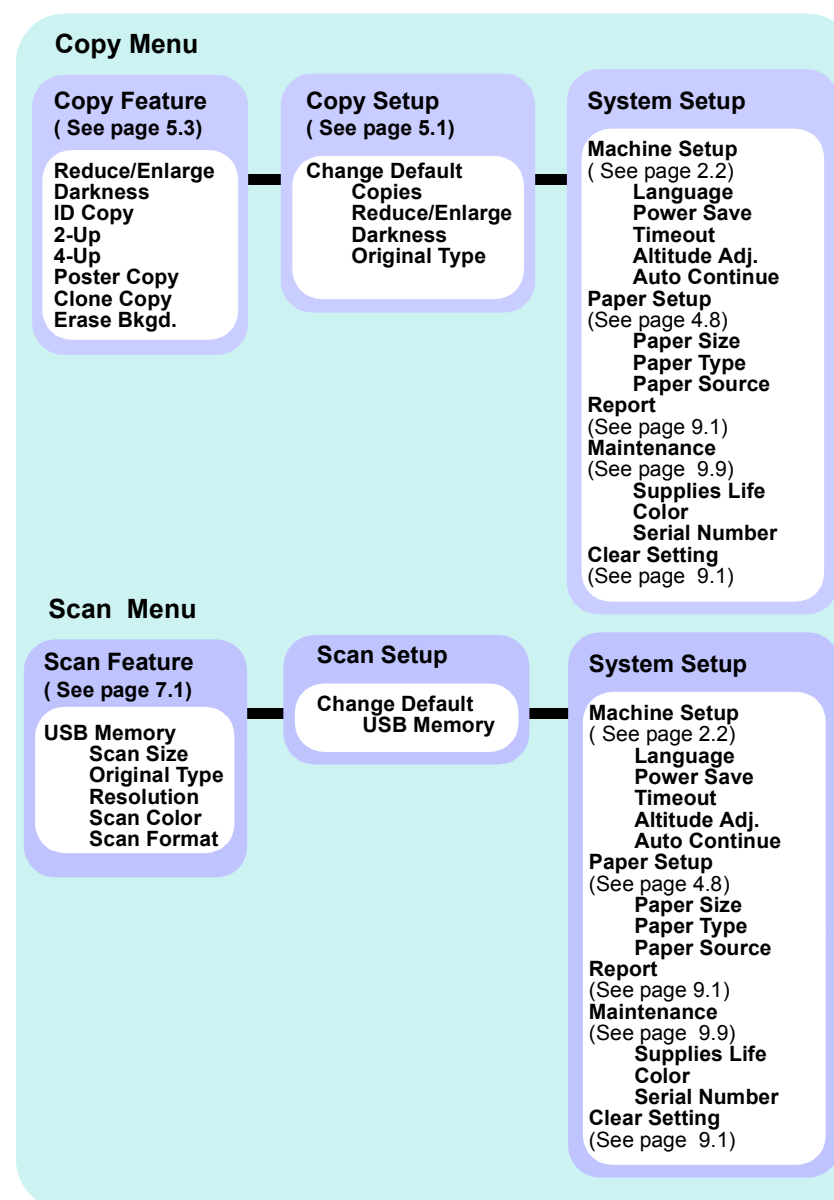

---

## Changing the display language

---

To change the language that appears on the control panel, follow these steps:

- 1 Press **Menu** until **Copy Menu** appears on the bottom line of the display and press **Enter**.
- 2 Press the **Scroll** buttons until **System Setup** appears and press **Enter**.
- 3 Press the **Scroll** buttons until **Machine Setup** appears and press **Enter**.
- 4 Press the **Scroll** buttons until **Language** appears and press **Enter**.
- 5 Press the **Scroll** buttons until the language you want appears and press **Enter**.
- 6 Press **Stop/Clear** to return to Standby mode.

---

## Using the power save mode

---

Power Save mode allows your machine to reduce power consumption when it is not in actual use. You can turn this mode on and select a length of time for which the machine waits after a job is printed before it switches to a reduced power state.

- 1 Press **Menu** until **Copy Menu** appears on the bottom line of the display and press **Enter**.
- 2 Press the **Scroll** buttons until **System Setup** appears and press **Enter**.
- 3 Press the **Scroll** buttons until **Machine Setup** appears and press **Enter**.
- 4 Press the **Scroll** buttons until **Power Save** appears and press **Enter**.
- 5 Press the **Scroll** buttons until the time setting you want appears and press **Enter**.
- 6 Press **Stop/Clear** to return to Standby mode.

---

## Auto continue

---

This is the option to set the machine to continue printing or not, in case the paper size you have set and the paper within the tray mismatches.

- 1 Press **Menu** until **Copy Menu** appears on the bottom line of the display and press **Enter**.
- 2 Press **Scroll** buttons until **System Setup** appears and press **Enter**.
- 3 Press **Scroll** buttons until **Machine Setup** appears and press **Enter**.
- 4 Press the **Scroll** buttons until **Auto Continue** appears and press **Enter**.
- 5 Press the **Scroll** buttons until the binding option you want appears.
  - **On:** Automatically prints after set time passes, when the paper size mismatches the tray paper size.
  - **Off:** Waits until you press **Black Start** or **Color Start** on the control panel, when the paper size mismatches the tray paper size.
- 6 Press **Enter** to save your selection.
- 7 Press **Stop/Clear** to return to Standby mode.

# 3 Software overview

This chapter gives you an overview of the software that comes with your machine. Further details about installing and using the software are explained in the **Software section**.

This chapter includes:

- **Supplied software**
- **Printer driver features**
- **System requirements**

## Supplied software

You must install the printer and scanner software using the supplied CD after you have set up your machine and connected it to your computer.

The CD provides you with the following software:

CD	Contents	
Printer software CD	Windows	<ul style="list-style-type: none"> <li>• <b>Printer driver:</b> Use this driver to take full advantage of your printer's features.</li> <li>• <b>Scanner driver:</b> TWAIN and Windows Image Acquisition (WIA) drivers are available for scanning documents on your machine.</li> <li>• <b>Status Monitor:</b> This program allows you to monitor the machine's status and alerts you when an error occurs during printing.</li> <li>• <b>Printer Setting Utility:</b> You can configure print settings.</li> <li>• <b>User's Guide</b> in PDF</li> </ul>
	Linux	<ul style="list-style-type: none"> <li>• <b>Printer driver:</b> Use this driver to run your machine from a Linux computer and print documents.</li> <li>• <b>SANE:</b> Use this driver to scan documents.</li> <li>• <b>Status Monitor:</b> This program allows you to monitor the machine's status and alerts you when an error occurs during printing.</li> </ul>
	Macintosh	<ul style="list-style-type: none"> <li>• <b>Printer driver:</b> Use this driver to run your machine from a Macintosh.</li> <li>• <b>Scanner driver:</b> TWAIN driver is available for scanning documents on your machine.</li> <li>• <b>Status Monitor:</b> This program allows you to monitor the machine's status and alerts you when an error occurs during printing.</li> </ul>

## Printer driver features

Your printer drivers support the following standard features:

- Paper orientation, size, source and media type selection
- Number of copies

In addition, you can use various special printing features. The following table shows a general overview of features supported by your printer drivers:

Feature	Printer Driver		
	Windows	Macintosh	Linux
Print quality option	O	O	O
Multiple pages per sheet (N-up)	O	O	O (2, 4)
Poster printing	O	X	X
Booklet Printing	O	X	X
Fit to page printing	O	O ( Mac 10.4 only)	X
Scale printing	O	O	X
Different source for first page	O	O	X
Watermark	O	X	X
Overlay	O	X	X

## System requirements

Before you begin, ensure that your system meets the following requirements:

### Windows

Item	Requirements	Recommended	
Operating system	Windows 2000/XP/2003/Vista		
CPU	Windows 2000	Pentium II 400 MHz or higher	Pentium III 933 MHz
	Windows XP/2003/ Vista	Pentium III 933 MHz or higher	Pentium IV 1 GHz
RAM	Windows 2000	64 MB or more	128 MB
	Windows XP/2003	128 MB or more	256 MB
	Windows Vista	512 MB or more	1 GB
Free disk space	Windows 2000	300 MB or more	1 GB
	Windows XP/2003	1 GB or more	5 GB
	Windows Vista	15 GB or more	15 GB
Internet Explorer	Windows 2000/XP/ 2003	5.0 or higher	
	Windows Vista	7.0 or higher	



#### Tip

For Windows 2000/2003/XP/Vista, users who have an administrator right can install the software.

### Linux

Item	Requirements
Operating system	<ul style="list-style-type: none"> <li>• RedHat 8.0 ~ 9.0</li> <li>• Fedora Core 1, 2, 3, 4</li> <li>• Mandrake 9.2 ~ 10.1</li> <li>• SuSE 8.2 ~ 9.2</li> </ul>
CPU	Pentium IV 1 GHz or higher
RAM	256 MB or higher
Free disk page	1 GB or higher
Software	<ul style="list-style-type: none"> <li>• Linux Kernel 2.4 or higher</li> <li>• Glibc 2.2 or higher</li> <li>• CUPS</li> <li>• SANE(for MFP device only)</li> </ul>



#### Tip

- It's necessary to claim swap partition of 300 MB or larger for working with large scanned images.
- The Linux scanner driver supports the optical resolution at maximum.

### Macintosh

Item	Requirements
Operating system	Macintosh 10.3 ~ 10.4
CPU	Intel processor PowerPC G4/G5
RAM	512 MB for an Intel-based Mac, 128 MB for a Power-PC based Mac
Free disk space	1 GB
Connection	USB interface

# 4 Selecting and loading print media

This chapter introduces you to how select and load print media for your machine.

This chapter includes:

- **Loading originals**
- **Selecting print media**
- **Loading paper**
- **Setting the paper size and type**

---

## Loading originals

---

You can use the scanner glass for copying, scanning.

- 1 Lift and open the scanner cover.

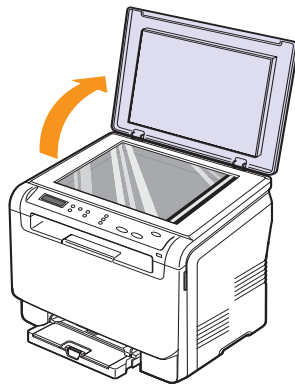

- 2 Place the original **face down** on the scanner glass and align it with the registration guide at the top left corner of the glass.

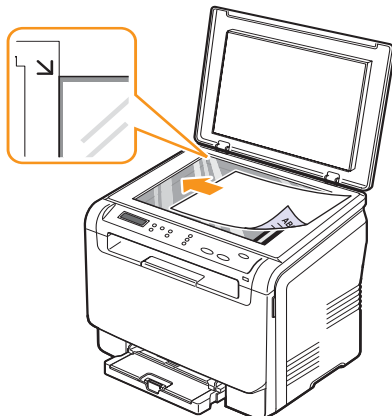

- 3 Close the scanner cover. Be careful not to move the document.

### Tip

- Do not leave the **scanner cover** open while copying. It may affect copy quality and toner consumption.
- Dust on the scanner glass may cause black spots on the printout. Always keep it clean.
- If you are copying a page from a book or magazine, lift the scanner cover until its hinges are caught by the stopper and then close the cover. If the book or magazine is thicker than 30 mm, start copying with the cover open.

---

## Selecting print media

---

You can print on a variety of print media, such as plain paper, envelopes, labels, and transparencies. Always use print media that meet the guidelines for use with your machine. Print media that does not meet the guidelines outlined in this user's guide may cause the following problems:

- Poor print quality
- Increased paper jams
- Premature wear on the machine.

Properties, such as weight, composition, grain, and moisture content, are important factors that affect the machine's performance and the output quality. When you choose print materials, consider the following:

- The type, size and weight of the print media for your machine are described later in this section.
- Desired outcome: The print media you choose should be appropriate for your project.
- Brightness: Some print media are whiter than others and produce sharper, more vibrant images.
- Surface smoothness: The smoothness of the print media affects how crisp the printing looks on the paper.

### Tip

- Some print media may meet all of the guidelines in this section and still not produce satisfactory results. This may be the result of improper handling, unacceptable temperature and humidity levels, or other variables over which Xerox has no control.
- Before purchasing large quantities of print media, ensure that it meets the requirements specified in this user's guide.

### Caution

Using print media that does not meet these specifications may cause problems, requiring repairs. Such repairs are not covered by Xerox's warranty or service agreements.

## Supported print media types and sizes

Type	Size	Dimensions	Weight	Capacity <sup>a</sup>
Plain paper	Letter	216 x 279 mm (8.50 x 11.00 inches)	<ul style="list-style-type: none"> <li>• 60 to 90 g/m<sup>2</sup> (16 to 24 lb bond) for the paper input tray.</li> <li>• 60 to 105 g/m<sup>2</sup> (16 to 28 lb bond) for the tray and manual feeder</li> </ul>	<ul style="list-style-type: none"> <li>• 1 sheet for the manual feeder</li> <li>• 150 sheets of 75 g/m<sup>2</sup> (20 lb bond) paper for the tray</li> </ul>
	Legal	216 x 356 mm (8.50 x 14.00 inches)		
	Folio	216 x 330 mm (8.50 x 13.00 inches)		
	Oficio	215 x 343 mm (8.50 x 13.50 inches)		
	A4	210 x 297 mm (8.26 x 11.69 inches)		
	JIS B5	182 x 257 mm (7.16 x 10.11 inches)		
	A5	148 x 210 mm (5.82 x 8.26 inches)		
	Executive	184 x 267 mm (7.25 x 10.50 inches)		
	ISO B5	176 x 250 mm (6.93 x 9.84 inches)		
	A6	105 x 148 mm (4.13 x 5.82 inches)		
Envelope	ISO/Envelope B5	176 x 250 mm (6.93 x 9.84 inches)	75 to 90 g/m <sup>2</sup> (20 to 24 lb bond)	1 sheet for the manual feeder or tray
	Envelope Monarch	98 x 191 mm (3.80 x 7.50 inches)		
	Envelope COM-10	105 x 241 mm (4.12 x 9.50 inches)		
	Envelope No.9	98 x 225 mm (3.87 x 8.87 inches)		
	Envelope DL	110 x 220 mm (4.33 x 8.66 inches)		
	Envelope C5	162 x 229 mm (6.37 x 9.01 inches)		
	Envelope C6	114 x 162 mm (4.48 x 6.38 inches)		
	Envelope size 6 3/4	92 x 165 mm (3.62 x 6.50 inches)		
Transparency <sup>b</sup>	Letter, A4	Refer to the Plain paper section	138 to 146 g/m <sup>2</sup> (37 to 39 lb bond)	1 sheet for the manual feeder or tray
Labels	Letter, Legal, Folio, Oficio, A4, JIS B5, Executive, A5, A6	Refer to the Plain paper section	120 to 150 g/m <sup>2</sup> (32 to 40 lb bond)	1 sheet for the manual feeder or tray
Card stock	Letter, Legal, Folio, Oficio, A4, JIS B5, Executive, A5, A6	Refer to the Plain paper section	105 to 163 g/m <sup>2</sup> (28 to 43 lb bond)	1 sheet for the manual feeder or tray
Minimum size (custom)		76 x 127 mm (3.00 x 5.00 inches)	60 to 163 g/m <sup>2</sup> (16 to 43 lb bond)	1 sheet for the manual feeder or tray
Maximum size (custom)		216 x 356 mm (8.50 x 14.00 inches)		

a. Maximum capacity may differ depending on media weight, thickness, and environmental conditions.

b. Recommended media: Transparency for a Color Laser Printers produced by Xerox.

It is not recommended to use paperbacked transparencies such as Xerox 3R91334, which can cause a jam or be scratched.

## Media sizes supported in each mode

Mode	Size	Source
Copy mode	Letter, A4, Legal, Oficio, Folio, Executive, JIS B5, A5, A6	<ul style="list-style-type: none"> <li>• Tray</li> <li>• Manual feeder</li> </ul>
Print mode	All sizes supported by the machine	<ul style="list-style-type: none"> <li>• Tray</li> <li>• Manual feeder</li> </ul>

## Guidelines for selecting and storing print media

When selecting or loading paper, envelopes, or other print materials, keep these guidelines in mind:

- Always use print media that conform with the specifications listed on page 4.5.
- Attempting to print on damp, curled, wrinkled, or torn paper can cause paper jams and poor print quality.
- For the best print quality, use only high quality copier grade paper specifically recommended for use in laser printers.
- Avoid using the following media types:
  - Paper with embossed lettering, perforations, or a texture that is too smooth or too rough
  - Erasable bond paper
  - Multi-paged paper
  - Synthetic paper and thermally reactive paper
  - Carbonless paper and Tracing paper.

Use of these types of paper could result in paper jams, chemical smells, and damage to your machine.

- Store print media in its ream wrapper until you are ready to use it. Place cartons on pallets or shelves, not on the floor. Do not place heavy objects on top of the paper, whether it is packaged or unpackaged. Keep it away from moisture or other conditions that can cause it to wrinkle or curl.
- Store unused print media at temperatures between 15° C and 30° C (59° F to 86° F). The relative humidity should be between 10% and 70%.
- Store unused print media in a moisture-proof wrap, such as a plastic container or bag, to prevent dust and moisture from contaminating your paper.
- Load special media types one sheet at a time through the manual feeder to avoid paper jams.

To prevent print media, such as transparencies and label sheets, from sticking together, remove them as they print out.

## Guidelines for special print media

Media type	Guidelines
Envelopes	<ul style="list-style-type: none"> <li>• Successful printing on envelopes depends upon the quality of the envelopes. When selecting envelopes, consider the following factors:           <ul style="list-style-type: none"> <li>- Weight: The weight of the envelope paper should not exceed 90 g/m<sup>2</sup> (24 lb) or jamming may occur.</li> <li>- Construction: Prior to printing, envelopes should lie flat with less than 6 mm (0.25 inches) curl, and should not contain air.</li> <li>- Condition: Envelopes should not be wrinkled, nicked, or otherwise damaged.</li> <li>- Temperature: You should use envelopes that are compatible with the heat and pressure of the machine during operation.</li> </ul> </li> <li>• Use only well-constructed envelopes with sharp and well creased folds.</li> <li>• Do not use stamped envelopes.</li> <li>• Do not use envelopes with clasps, snaps, windows, coated lining, self-adhesive seals, or other synthetic materials.</li> <li>• Do not use damaged or poorly made envelopes.</li> <li>• Be sure the seam at both ends of the envelope extends all the way to the corner of the envelope.</li> </ul> <div style="text-align: center;"> </div> <ul style="list-style-type: none"> <li>• Envelopes with a peel-off adhesive strip or with more than one flap that folds over to seal must use adhesives compatible with the printer's fusing temperature for 0.1 second. Check your machine's specification to view the fusing temperature, see page 13.1. The extra flaps and strips might cause wrinkling, creasing, or jams, and may even damage the fuser.</li> <li>• For the best print quality, position margins no closer than 15 mm (0.6 inches) from the edges of the envelope.</li> <li>• Avoid printing over the area where the envelope's seams meet.</li> </ul>

Media type	Guidelines
Transparencies	<ul style="list-style-type: none"> <li>To avoid damaging the machine, use only transparencies designed for use in laser printers.</li> <li>Transparencies used in the printer must be able to withstand the machine's fusing temperature. Check your machine's specification to view the fusing temperature, see page 13.1.</li> <li>Place them on a flat surface after removing them from the machine.</li> <li>Do not leave them in the paper tray for long periods of time. Dust and dirt may accumulate on them, resulting in spotty printing.</li> <li>To avoid smudging caused by fingerprints, handle them carefully.</li> <li>To avoid fading, do not expose printed transparencies to prolonged sunlight.</li> <li>Ensure that transparencies are not wrinkled, curled, or have any torn edges.</li> </ul> <p><b>Caution</b>   Recommended media: Transparency for a Color Laser Printers produced by Xerox. It is not recommended to use paperbacked transparencies such as Xerox 3R91334, which can cause a jam or be scratched.</p>

Media type	Guidelines
Labels	<ul style="list-style-type: none"> <li>To avoid damaging the machine, use only labels designed for use in laser printers.</li> <li>When selecting labels, consider the following factors: <ul style="list-style-type: none"> <li>Adhesives: The adhesive material should be stable at your machine's fusing temperature. Check your machine's specification to view the fusing temperature, see page 13.1.</li> <li>Arrangement: Only use labels with no exposed backing between them. Labels can peel off sheets that have spaces between the labels, causing serious jams.</li> <li>Curl: Prior to printing, labels must lie flat with no more than 13 mm (5 inches) of curl in any direction.</li> <li>Condition: Do not use labels with wrinkles, bubbles, or other indications of separation.</li> </ul> </li> <li>Make sure that there is no exposed adhesive material between labels. Exposed areas can cause labels to peel off during printing, which can cause paper jams. Exposed adhesive can also cause damage to machine components.</li> <li>Do not run a sheet of labels through the machine more than once. The adhesive backing is designed for only a single pass through the machine.</li> <li>Do not use labels that are separating from the backing sheet or are wrinkled, bubbled, or otherwise damaged.</li> </ul>
Card stock or custom-sized materials	<ul style="list-style-type: none"> <li>Do not print on media smaller than 76 mm (3.00 inches) wide or 127 mm (5.00 inches) long.</li> <li>In the software application, set margins at least 6.4 mm (0.25 inches) away from the edges of the material.</li> </ul>
Preprinted paper	<ul style="list-style-type: none"> <li>Letterhead must be printed with heat-resistant ink that will not melt, vaporize, or release hazardous emissions when subjected to the printer's fusing temperature for 0.1 second. Check your machine's specification to view the fusing temperature, see page 13.1.</li> <li>Letterhead ink must be non-flammable and should not adversely affect printer rollers.</li> <li>Forms and letterhead should be sealed in a moisture-proof wrapping to prevent changes during storage.</li> <li>Before you load preprinted paper, such as forms and letterhead, verify that the ink on the paper is dry. During the fusing process, wet ink can come off preprinted paper, reducing print quality.</li> </ul>



## Loading paper

### In the tray

Load the print media you use for the majority of your print jobs in the tray. The tray can hold a maximum of 150 sheets of 75 g/m<sup>2</sup> (20 lb bond) plain paper.

#### Loading paper in the tray

- 1 Pull the tray out of the machine.
- 2 Open the paper cover.

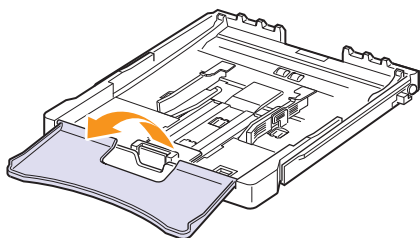

- 3 Adjust the size of tray until it clicks into place.

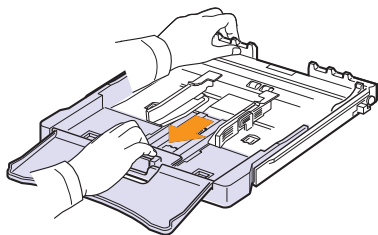

- 4 Enlarge the tray by adjusting the paper width guide.

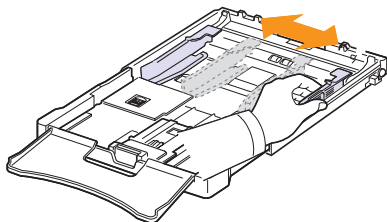

- 5 Flex the paper sheets back and forth to separate pages and then fan them while holding one edge. Tap the edges of the stack on a flat surface to even it up.

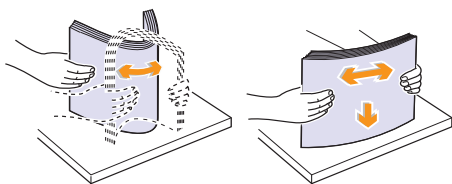

- 6 Load paper with the print side up.

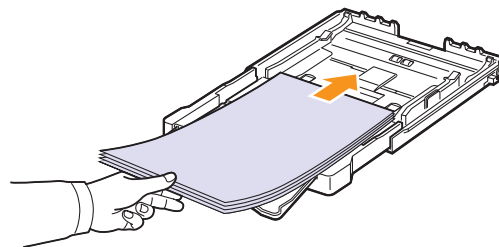

Make sure not to overfill the tray and that all four corners are flat in the tray and under the brackets, as shown below. Overfilling the tray may cause a paper jam.

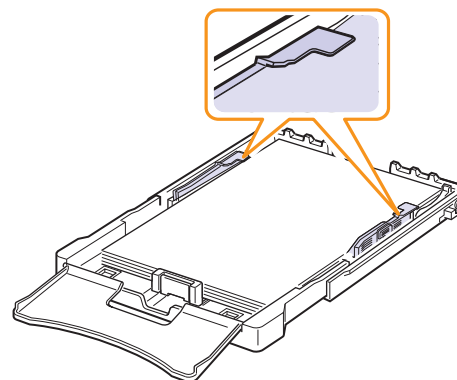

- 7 Squeeze the paper length guide and slide in it until it lightly touches the end of the paper stack.

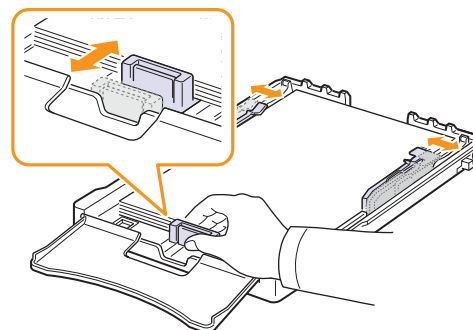

- 8 Close the paper cover.

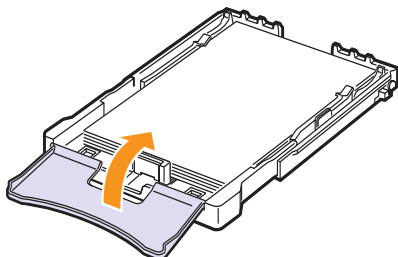

- 9 Slide the tray back into the machine.

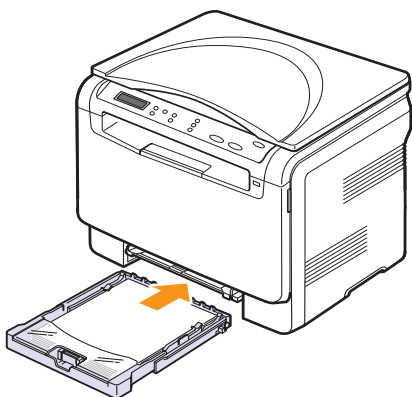

You can load letterhead with the design side face up. The top edge of the sheet with the logo should go into the machine first.

After loading paper, set the paper type and size for the tray. See the **Software** section for PC-printing details.



**Tip**

- If there is not enough paper in the tray, load more paper.
- If you experience problems with paper feed, place one sheet at a time in the manual feeder.
- You can load previously printed paper. The printed side should be facing down with an uncurled edge into the machine. If you experience problems with paper feed, turn the paper around. Note that print quality is not guaranteed.

### Changing the size of the paper in the tray

To load longer sizes of paper, such as Legal-sized paper, you need to adjust the paper guides to extend the paper tray.

To change the tray size to other size, you must adjust the paper length guide properly.

- 1 Pull the tray out of the machine. Open the paper cover and remove paper from the tray if necessary.
- 2 Pressing and unlatching the guide lock in the top of the tray, pull the tray out manually.

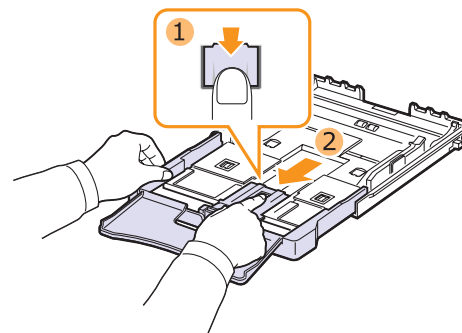

- 3 Load paper into the tray.

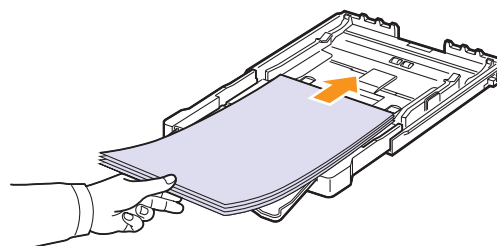

- 4 Slide the paper length guide until it lightly touches the end of the paper stack. Squeeze the paper width guide and slide it to the edge of the paper stack without causing it to bend.

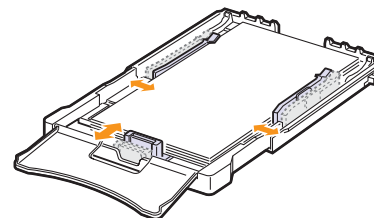

For paper smaller than Letter-sized, return the paper guides to their original positions and adjust the paper length guide and paper width guide.

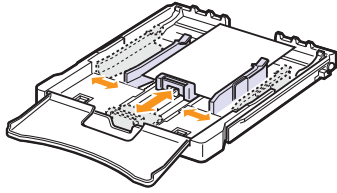

#### Tip

- Do not push the paper width guides far enough to cause the material to warp.
- If you do not correctly adjust the paper width guides, it may cause a paper jams.

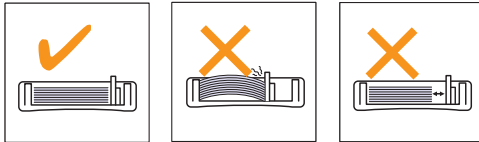

- 5 Close the paper cover.

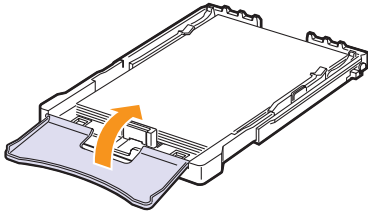

- 6 Slide the tray back into the machine.

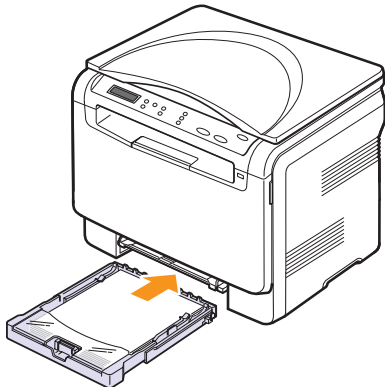

## In the manual feeder

The manual feeder can hold special sizes and types of print material, such as transparencies, postcards, note cards, labels, and envelopes. It is useful for single page printing on letterhead or colored paper.

### Tips on using the manual feeder

- Load only one size of print media at a time in the manual feeder. When you print out many pieces of paper at once, tray use is recommended.
- To prevent paper jams, do not add paper when there is still paper in the manual feeder. This also applies to other types of print media.
- Print media should be loaded face up with the top edge going into the manual feeder first and be placed in the center of the tray.
- Always load only the print media specified in page 4.2 to avoid paper jams and print quality problems.
- Flatten any curl on postcards, envelopes, and labels before loading them into the manual feeder.

To load paper in the manual feeder:



#### Caution

When you do the printing job from the manual feeder, clear the paper in the tray away.

- 1 Load the paper **with the side to be printed on facing up**.

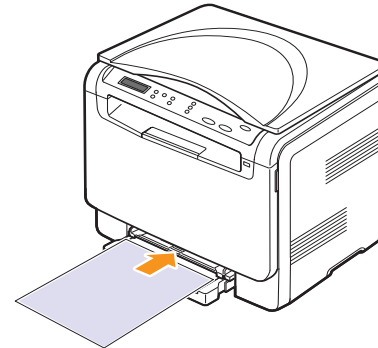

Depending on the media type you are using, keep the following loading guidelines:

- **Envelopes:** Flap side down and with the stamp area on the top left side.
- **Transparencies:** Print side up and the top with the adhesive strip entering the machine first.
- **Labels:** Print side up and top short edge entering the machine first.
- **Preprinted paper:** Design side up with the top edge toward the machine.
- **Card stock:** Print side up and the short edge entering the machine first.
- **Previously printed paper:** Previously printed side down with an uncurled edge toward the machine.

- 2 Squeeze the manual feeder paper width guides and adjust them to the width of the paper. Do not force too much, or the paper will be bent, which will result in a paper jam or skew.

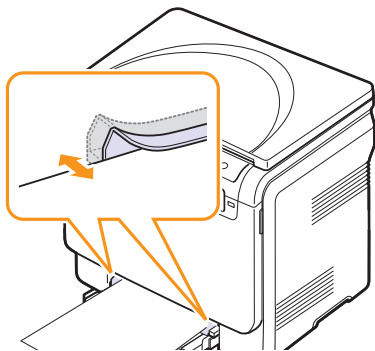

- 3 After loading paper, set the paper type and size for the manual feeder. See the **Software section** for PC-printing details.



#### Tip

The settings made from the printer driver override the settings on the control panel.



#### Caution

If you want to print several pages with the manual feeder, wait the machine complete the printing one page, then place a paper on the manual feeder. Otherwise it may cause a paper jam.

---

## Setting the paper size and type

---

After loading paper in the paper tray, you need to set the paper size and type using the control panel buttons. These settings will apply to Copy. For PC-printing, you need to select the paper size and type in the application program you use on your PC.

- 1 Press **Menu** until **Copy Menu** appears on the bottom line of the display and press **Enter**.
- 2 Press the **Scroll** buttons until **System Setup** appears and press **Enter**.
- 3 Press the **Scroll** buttons until **Paper Setup** appears and press **Enter**.
- 4 Press **Enter** when **Paper Size** appears.
- 5 Press the **Scroll** buttons until the paper tray you want appears and press **Enter**.
- 6 Press the **Scroll** buttons until the paper size you are using appears and press **Enter**.
- 7 Press **Back** to return to the upper level.
- 8 Press the **Scroll** buttons until **Paper Type** appears and press **Enter**.
- 9 Press the **Scroll** buttons until the paper type you are using appears and press **Enter**.
- 10 Press **Stop/Clear** to return to Standby mode.

# 5 Copying

This chapter gives you step-by-step instructions for copying documents.

This chapter includes:

- **Selecting the paper tray**
- **Copying**
- **Changing the settings for each copy**
- **Changing the default copy settings**
- **Setting copy timeout**
- **Using special copy features**

---

## Selecting the paper tray

---

After loading the print media for copy output, you must select the paper tray you will use for copy jobs.

- 1 Press **Menu** until **Copy Menu** appears on the bottom line of the display and press **Enter**.
- 2 Press **Scroll** buttons until **System Setup** appears and press **Enter**.
- 3 Press the **Scroll** buttons until **Paper Setup** appears and press **Enter**.
- 4 Press the **Scroll** buttons until **Paper Source** appears and press **Enter**.
- 5 Press the **Scroll** buttons until the paper tray you want appears and press **Enter**.
- 6 Press **Stop/Clear** to return to Standby mode.

---

## Copying

---

- 1 Place an original document on the scanner glass.

Customize the copy settings including copy size, darkness, and original type, by using the control panel **Menu** buttons.

If necessary, you can use special copy features, such as Poster copying or 2 Up copying. See 5.3. and 5.5.

- 2 Press **Color Start** to begin color copying.

Or, press **Black Start** to begin black and white copying.



### Tip

You can cancel the copy job during an operation. Press **Stop/Clear**, and the copying will stop.

---

## Changing the settings for each copy

---

The buttons on the control panel let you select all basic copy options: darkness, document type and copy size. Set the following options for the current copy job before pressing **Black Start** or **Color Start** to make copies.



### Tip

If you press **Stop/Clear** while setting the copy options, all of the options you have set for the current copy job will be canceled and returned to their default status.

## Reduced/Enlarged copy

You can reduce or enlarge the size of a copied image from 50% to 200%.

To select from the predefined copy sizes:

- 1 Press **Menu** until **Copy Menu** appears on the bottom line of the display and press **Enter**.
- 2 Press **Scroll** buttons until **Copy Feature** appears and press **Enter**.
- 3 Press **Scroll** buttons until **Reduce/Enlarge** appears and press **Enter**.
- 4 Press the **Scroll** buttons to select the size setting you want and press **Enter**.

To fine-tune the size of copies:

- 1 Press **Menu** until **Copy Menu** appears on the bottom line of the display and press **Enter**.
- 2 Press **Scroll** buttons until **Copy Feature** appears and press **Enter**.
- 3 Press **Scroll** buttons until **Reduce/Enlarge** appears and press **Enter**.
- 4 Press the **Scroll** buttons until **Custom** appears and press **Enter**.
- 5 Press the **Scroll** buttons to enter the copy size you want. Pressing and holding the button allows you to quickly scroll to the number you want.
- 6 Press **Enter** to save the selection.



### Tip

When you make a reduced copy, black lines may appear at the bottom of your copy.

## Darkness

If you have an original document containing faint markings and dark images, you can adjust the brightness to make a copy that is easier to read.

- 1 Press **Menu** until **Copy Menu** appears on the bottom line of the display and press **Enter**.
- 2 Press **Scroll** buttons until **Copy Feature** appears and press **Enter**.
- 3 Press **Scroll** buttons until **Darkness** appears and press **Enter**.
- 4 Press the **Scroll** buttons to select the contrast mode you want.
  - Light**: works well with dark print.
  - Normal**: works well with standard typed or printed documents.
  - Dark**: works well with light print or faint pencil markings.
- 5 Press **Enter** to save the selection.

## Original type

The original type setting is used to improve the copy quality by selecting the document type for the current copy job.

- 1 Press **Original Type**.
- 2 Press the **Scroll** buttons to select the image mode you want.
  - Text**: Use for documents containing mostly text.
  - Text/Photo**: Use for documents with mixed text and photographs.
  - Photo**: Use when the originals are photographs.
- 3 Press **Enter** to save the selection.

---

## Changing the default copy settings

---

The copy options, including darkness, original type, copy size, and number of copies, can be set to those most frequently used. When you copy a document, the default settings are used unless they have been changed by using the corresponding buttons on the control panel.

- 1 Press **Menu** until **Copy Menu** appears on the bottom line of the display and press **Enter**.
- 2 Press **Scroll** buttons until **Copy Setup** appears and press **Enter**.
- 3 Press **Enter** when **Change Default** appears.
- 4 Press the **Scroll** buttons until the setup option you want appears and press **Enter**.
- 5 Press the **Scroll** buttons until the setting you want appears and press **Enter**.
- 6 Repeat steps 4 through 5, as needed.
- 7 Press **Stop/Clear** to return to Standby mode.



### Tip

While you are setting copy options, pressing **Stop/Clear** cancels the changed settings and restores the defaults.

---

## Setting copy timeout

---

You can set the time the machine waits before it restores the default copy settings, if you do not start copying after changing them on the control panel.

- 1 Press **Menu** until **Copy Menu** appears on the bottom line of the display and press **Enter**.
- 2 Press **Scroll** buttons until **System Setup** appears and press **Enter**.
- 3 Press **Scroll** buttons until **Machine Setup** appears and press **Enter**.
- 4 Press the **Scroll** buttons until **Timeout** appears and press **Enter**.
- 5 Press the **Scroll** buttons until the time setting you want appears.

Selecting **Off** means that the machine does not restore the default settings until you press **Black Start** or **Color Start** to begin copying, or **Stop/Clear** to cancel.

- 6 Press **Enter** to save your selection.
- 7 Press **Stop/Clear** to return to Standby mode.

---

## Using special copy features

---

### ID card copying

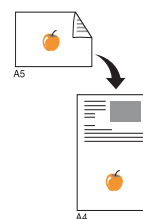

Your machine can print 2-sided originals on one sheet of A4-, Letter-, Legal-, Folio-, Oficio-, Executive-, B5-, A5-, or A6-sized paper.

When you copy using this feature, the machine prints one side of the original on the upper half of the paper and the other side on the lower half without reducing the size of the original. This feature is helpful for copying a small-sized items, such as a name card.

This copy feature is available only when you place originals on the scanner glass.

- 1 Press **Menu** until **Copy Menu** appears.
- 2 Press **Scroll** buttons until **Copy Feature** appears and press **Enter**.
- 3 Press **Scroll** buttons until **ID Copy** appears and press **Enter**.

- 4 Place a single original face down on the scanner glass.

For details about loading an original, see page 4.1.

- 5 **Place Front Side and Press[Start]** appears on the display.

- 6 Press **Color Start** or **Black Start**.

Your machine begins scanning the front side and shows **Place Back Side and Press[Start]**.

- 7 Open the scanner cover and turn the original over.



#### Tip

If you press **Stop/Clear** or if no buttons are pressed for approximately 30 seconds, the machine cancels the copy job and returns to Standby mode.

- 8 Press **Color Start** to begin color copying.

Or, press **Black Start** to begin black and white copying.



#### Tip

If the original is larger than the printable area, some portions may not be printed.

## 2-up or 4-up copying

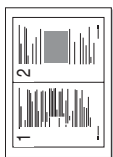

▲ 2-up copying



▲ 4-up copying

Your machine can print 2 or 4 original images reduced to fit onto one sheet of paper.

- 1 Place the document to be copied on the scanner glass, and close the scanner cover.

For details about loading an original, see page 4.1.

- 2 Press **Menu** until **Copy Menu** appears on the bottom line of the display and press **Enter**.
- 3 Press **Scroll** buttons until **Copy Feature** appears and press **Enter**.
- 4 Press the **Scroll** buttons until **2-Up** or **4-Up** appears and press **Enter**.
- 5 Press the **Scroll** buttons to select the color mode you want.  
There are two types of mode as following:
  - Yes-Color**: Color copy
  - Yes-Mono**: Black and White copy
- 6 Press **Enter** to begin copying.
- 7 Your machine begins scanning the front side and will then display **Another Page?**.

If an original is placed on the scanner glass, select **Yes** to add another pages.

- 8 Place the second document to be copied on the scanner glass.
- 9 Press **Enter** to begin copying.



### Tip

2- or 4-up copying reduces your original document by 50%.

## Poster copying



Your machine can print an image onto 9 sheets of paper (3x3). You can paste the printed pages together to make one poster-sized document.

This copy feature is available only when you place originals on the scanner glass.

- 1 Place the document to be copied on the scanner glass, and close the scanner cover.

For details about loading an original, see page 4.1.

- 2 Press **Menu** until **Copy Menu** appears on the bottom line of the display and press **Enter**.
- 3 Press **Scroll** buttons until **Copy Feature** appears and press **Enter**.
- 4 Press the **Scroll** buttons until **Poster Copy** appears and press **Enter**.
- 5 Press the **Scroll** buttons to select the color mode you want.  
There are two types of mode as following:
  - Yes-Color**: Color copy
  - Yes-Mono**: Black and White copy
- 6 Press **Enter** to begin copying.

Your original is divided into 9 portions. Each portion is scanned and printed one by one in the following order:

1	2	3
4	5	6
7	8	9



## Clone copying

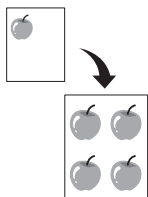

Your machine can print multiple image copies from the original document on a single page. The number of images is automatically determined by the original image and paper size.

This copy feature is available only when you place originals on the scanner glass.

- 1 Place the document to be copied on the scanner glass, and close the scanner cover.  
For details about loading an original, see page 4.1.
- 2 Press **Menu** until **Copy Menu** appears on the bottom line of the display and press **Enter**.
- 3 Press **Scroll** buttons until **Copy Feature** appears and press **Enter**.
- 4 Press the **Scroll** buttons until **Clone Copy** appears and press **Enter**.
- 5 Press the **Scroll** buttons to select the color mode you want.  
There are two types of mode as following:
  - Yes-Color**: Color copy
  - Yes-Mono**: Black and White copy
- 6 Press **Enter** to begin copying.

## Erasing background images

You can set the machine to print an image without its background. This copy feature removes the background color and can be helpful when copying an original containing color in the background, such as a newspaper or a catalog. This copy feature is only for mono copying.

- 1 Place the document to be copied on the scanner glass, and close the scanner cover.  
For details about loading an original, see page 4.1.
- 2 Press **Menu** until **Copy Menu** appears on the bottom line of the display and press **Enter**.
- 3 Press **Scroll** buttons until **Copy Feature** appears and press **Enter**.
- 4 Press the **Scroll** buttons until **Erase Bkgd.** appears and press **Enter**.
- 5 Press the **Scroll** buttons to select **On** and press **Enter**.
- 6 Press **Stop/Clear** to return to Standby mode.
- 7 Press **Black Start** to begin mono copying.

# 6 Basic printing

This chapter explains common printing tasks.

---

## Printing a document

---

Your machine allows you to print from various Windows, Macintosh, or Linux applications. The exact steps for printing a document may vary depending on the application you use.

For details about printing, see the **Software section**.

---

## Canceling a print job

---

If the print job is waiting in a print queue or print spooler, such as the printer group in Windows, delete the job as follows:

- 1 Click the Windows **Start** menu.
- 2 For Windows2000 select **Settings** and then **Printers**.  
For Windows XP/2003, select **Printers and Faxes**.  
For Windows Vista, select **Control Panel > Hardware and Sound > Printers**.
- 3 Double-click the **Xerox Phaser 6110 MFP** icon.
- 4 From the **Document** menu, select **Cancel**.



### Tip

You can also access this window by simply double-clicking the printer icon at the bottom right corner of the Windows desktop.

You can also cancel the current job by pressing **Stop/Clear** on the control panel.

# 7 Scanning

Scanning with your machine lets you turn pictures and text into digital files that can be stored on your computer. Then you can email the files, upload them to your website, or use them to create projects that you can print.

This chapter includes:

- **Scanning basics**
- **Scanning to an application using a local connection**
- **Changing the settings for each scan job**
- **Changing the default scan settings**



## Tip

The maximum resolution that can be achieved depends upon various factors, including computer speed, available disk space, memory, the size of the image being scanned, and bit depth settings. Thus, depending on your system and what you are scanning, you may not be able to scan at certain resolutions, especially using enhanced resolution.

---

## Scanning basics

---

Your machine offers the following ways to scan an image using a local connection:

- Via one of the preset imaging applications. Scanning an image launches the selected application, enabling you to control the scanning process. See the next section.
- Via the Windows Images Acquisition (WIA) driver. See the **Software section**.
- To a portable USB memory device, if inserted into the USB memory port on your machine. See page 8.2.

---

## Scanning to an application using a local connection

---



## Tip

You can add more TWAIN-compliant software for scanning, such as Adobe Photoshop Deluxe, Microsoft Paint, Email, My Documnet, OCR or Adobe Photoshop, from the **Printer Settings Utility**. See the **Software section**.

- 1 Make sure that your machine and computer are turned on and properly connected to each other.
- 2 Place a single original face down on the scanner glass.  
For details about loading an original, see page 4.1.
- 3 Press **Scan To**.  
**Ready to Scan** appears on the top line of the display.
- 4 Press the **Scroll** buttons until **Scan to Appl.** appears on the bottom line of the display and press **Enter**.
- 5 Press the **Scroll** buttons until the application you want to use appears and press **Enter**.
- 6 On the selected application, adjust the scan settings and begin scanning.  
For details, please refer to the application user's guide.

---

## Changing the settings for each scan job

---

Your machine provides you with the following setting options.

- **Scan Size:** Sets the image size.
- **Original Type:** Sets the original document's type.
- **Resolution:** Sets the image resolution.
- **Scan Color:** Sets the color mode.
- **Scan Format:** Sets the file format in which the image is to be saved. If you select TIFF or PDF, you can select to scan multiple pages.

To customize the settings before starting a scan job:

- 1 Press **Menu** until **Scan Menu** appears on the bottom line of the display and press **Enter**.
- 2 Press the **Scroll** buttons until **Scan Feature** appears and press **Enter**.
- 3 Press **Enter** when **USB Memory** appears.
- 4 Press the **Scroll** buttons until the scan setting option you want appears and press **Enter**.
- 5 Press the **Scroll** buttons until the desired status appears and press **Enter**.
- 6 Repeat steps 4 and 5 to set other setting options.
- 7 When you have finished, press **Stop/Clear** to return to Standby mode.

---

## Changing the default scan settings

---

To avoid having to customize the scan settings for each job, you can set up default scan settings.

- 1 Press **Menu** until **Scan Menu** appears on the bottom line of the display and press **Enter**.
- 2 Press the **Scroll** buttons until **Scan Setup** appears and press **Enter**.
- 3 Press **Enter** when **Change Default** appears.
- 4 Press **Enter** when **USB Memory** appears.
- 5 Press the **Scroll** buttons until the scan setting option you want appears and press **Enter**.
- 6 Press the **Scroll** buttons until the desired status appears and press **Enter**.
- 7 Repeat steps 5 and 6 to change other settings.
- 8 Press **Stop/Clear** to return to Standby mode.

## 8 Using USB flash memory

This chapter explains how to use a USB memory device with your machine.

This chapter includes:

- **About USB memory**
- **Plugging in a USB memory device**
- **Scanning to a USB memory device**
- **Printing from a USB memory device**
- **Managing USB memory**
- **Printing directly from a digital camera**

### About USB memory

USB memory devices are available with a variety of memory capacities to give you more room for storing documents, presentations, downloaded music and videos, high resolution photographs, or whatever other files you want to store or move.

You can do the following on your machine using a USB memory device:

- Scan documents and save them on a USB memory device.
- Print data stored on a USB memory device.
- Restore backup files to the machine's memory.
- Format the USB memory device.
- Check the available memory space.

### Plugging in a USB memory device

The USB memory port on the front of your machine is designed for USB V1.1 and USB V2.0 memory devices. Your machine supports USB memory devices with FAT16/ FAT32 and sector size 512 Byte. Check your USB memory devices' file system from your dealer.

You must use only an authorized USB memory device with an A plug type connector.

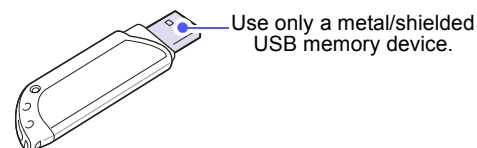

#### Tip

There are two USB plug types.



Insert a USB memory device into the USB memory port on the front of your machine.

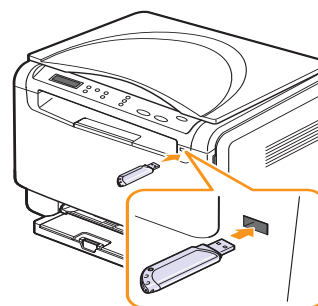

#### Caution

- Do not remove the USB memory device while the machine is in operation, or writing to or reading from USB memory. This may damage your machine.
- If your USB memory device has certain features, such as security settings and password settings, your machine may not automatically detect it. For details about these features, see the device's User's Guide.

---

## Scanning to a USB memory device

---

You can scan a document and save the scanned image onto a USB memory device. There are two ways of doing this: you can scan to the device using the default settings, or you can customize your own scan settings.

### Scanning

- 1 Insert a USB memory device into the USB memory port on your machine.
- 2 Place a single original face down on the scanner glass.  
For details about loading an original, see page 4.1.
- 3 Press **Scan To**.
- 4 Press **Enter**. The USB available space appears.
- 5 Press **Enter**. The machine begins scanning and stores the file in folder [D] SCANFILE SCAN0000.pdf .
- 6 Press **Enter** when **Yes** appears to scan more pages. Load an original and press **Color Start** or **Black Start**.  
Regardless of the button you press, the color mode is decided as customized. See “Customizing scan to USB” on page 8.2.  
Otherwise, press the **Scroll** buttons to select **No** and press **Enter**.

After scanning is complete, you can remove the USB memory device from the machine.



#### Tip

Your machine creates the SCANFILE folder on the USB drive, and stores scanned data.

### Customizing scan to USB

You can specify image size, file format, or color mode for each scanning to USB job.

- 1 Press **Menu** until **Scan Menu** appears on the bottom line of the display and press **Enter**.
- 2 Press the **Scroll** buttons until **Scan Feature** appears and press **Enter**.
- 3 Press **Enter** when **USB Memory** appears.
- 4 Press the **Scroll** buttons until the setting option you want appears and press **Enter**.  
You can set the following options:
  - **Scan Size**: Sets the image size.
  - **Original Type**: Sets the original document's type.
  - **Resolution**: Sets the image resolution.
  - **Scan Color**: Sets the color mode. If you select **Mono** in this option, you can not select **JPEG** in **Scan Format**.
  - **Scan Format**: Sets the file format in which the image is to be saved. When you select TIFF or PDF, you can select to scan multiple pages. If you select **JPEG** in this option, you can not select **Mono** in **Scan Color**.
- 5 Press the **Scroll** buttons until the desired status appears and press **Enter**.
- 6 Repeat steps 4 and 5 to set other setting options.
- 7 When you have finished, press **Stop/Clear** to return to Standby mode.

You can change the default scan settings. For details, see page 7.2.

---

## Printing from a USB memory device

---

You can directly print files stored on a USB memory device. You can print TIFF, BMP, JPEG.

Direct Print option supported file types:

- BMP: BMP Uncompressed
- TIFF: TIFF 6.0 Baseline
- JPEG: JPEG Baseline

To print a document from a USB memory device:

- 1 Insert a USB memory device into the USB memory port on your machine. If one has already been inserted, press **USB Print**.  
Your machine automatically detects the device and reads data stored on it.
- 2 Press the **Scroll** buttons until the folder or file you want appears and press **Enter**.  
If you see **D** in the front of a folder name, there are one or more files or folders in the selected folder.
- 3 Select a folder and press **Enter**.  
If you selected a folder, press the **Scroll** buttons until the file you want appears.
- 4 Press the **Scroll** buttons to select the number of copies to be printed or enter the number.
- 5 Press **Enter**, **Color Start** or **Black Start** to start printing the selected file.  
There are two types of mode as following:
  - **Enter** or **Color Start**: Color print
  - **Black Start**: Black and White printAfter printing the file, the display asks if you want to print another job.
- 6 Press **Enter** when **No** appears to stop printing.  
Otherwise, press the **Scroll** buttons to select **Yes** and press **Enter** to print another job.
- 7 Press **Stop/Clear** to return to Standby mode.

---

## Managing USB memory

---

You can delete image files stored on a USB memory device one by one or all at once by reformatting the device.



### Caution

After deleting files or reformatting a USB memory device, files cannot be restored. Therefore, confirm that you no longer need the data before deleting it.

## Deleting an image file

- 1 Insert the USB memory device into the USB memory port on your machine.
- 2 Press **Scan To**.
- 3 Press **Enter** when **Scan to USB** appears on the bottom line of the display.
- 4 Press the **Scroll** buttons until **File Manage** appears and press **Enter**.
- 5 Press **Enter** when **Delete** appears.
- 6 Press the **Scroll** buttons until the folder or file you want appears and press **Enter**.



### Tip

If you see **D** in the front of a folder name, there are one or more files or folders in the selected folder.

If you selected a file, the display shows the size of the file for about 2 seconds. Go to the next step.

If you selected a folder, press the **Scroll** buttons until the file you want to delete appears and press **Enter**.

- 7 Press **Enter** when **Yes** appears to confirm your selection.
- 8 Press **Stop/Clear** to return to Standby mode.

## Formatting a USB memory device

- 1 Insert the USB memory device into the USB memory port on your machine.
- 2 Press **Scan To**.
- 3 Press **Enter** when **Scan to USB** appears on the bottom line of the display.
- 4 Press the **Scroll** buttons until **File Manage** appears and press **Enter**.
- 5 Press the **Scroll** buttons until **Format** appears and press **Enter**.
- 6 Press **Enter** when **Yes** appears to confirm your selection.
- 7 Press **Stop/Clear** to return to Standby mode.

## Viewing the USB memory status

You can check the amount of memory space available for scanning and saving documents.

- 1 Insert the USB memory device into the USB memory port on your machine.
- 2 Press **Scan To**.
- 3 Press **Enter** when **Scan to USB** appears on the bottom line of the display.
- 4 Press the **Scroll** buttons until **Check Space** appears and press **Enter**.

The available memory space appears on the display.

- 5 Press **Stop/Clear** to return to the Standby mode.

---

## Printing directly from a digital camera

---

This machine supports the PictBridge feature. You can print images directly from any PictBridge-compatible device, such as a digital camera, camera phone, and camcorder. You do not need to connect it to a computer.

- 1 Turn on the machine.
- 2 Connect your PictBridge-compatible device to the memory port on the front of the machine using the USB cable supplied with the device.
- 3 Send an order to print images from the PictBridge-compatible device.



### Tip

- Detailed information on how to print an image from a camera with PictBridge feature, refer to the manual provided with your camera.
- Index print not support.
- Not support date or file name print.



# 9 Maintenance

This chapter provides information for maintaining your machine and the toner cartridge.

This chapter includes:

- **Printing reports**
- **Clearing memory**
- **Cleaning your machine**
- **Maintaining the toner cartridge**
- **Redistributing toner**
- **Replacing the toner cartridge**
- **Replacing the imaging unit**
- **Replacing the waste toner container**
- **Maintenance parts**
- **Checking the machine's serial number**

## Printing reports

Your machine can provide various reports with useful information you will need. The following reports are available:

Report/List	Description
<b>Configuration</b>	This list shows the status of the user-selectable options. You may print this list to confirm your changes after changing settings.
<b>Supplies Info</b>	This list shows the current status of consumables in your machine.

## Printing a report

- 1 Press **Menu** until **Copy Menu** appears on the bottom line of the display and press **Enter**.
- 2 Press the **Scroll** buttons until **System Setup** appears and press **Enter**.
- 3 Press the **Scroll** buttons until **Report** appears and press **Enter**.
- 4 Press the **Scroll** buttons until the report or list you want to print appears and press **Enter**.

To print all reports and lists, select **All Report**.

- 5 Press **Enter** when **Yes** appears to confirm printing.

The selected information prints out.

## Clearing memory

You can selectively clear information stored in your machine's memory.

- 1 Press **Menu** until **Copy Menu** appears on the bottom line of the display and press **Enter**.
- 2 Press the **Scroll** buttons until **System Setup** appears and press **Enter**.
- 3 Press the **Scroll** buttons until **Clear Setting** appears and press **Enter**.
- 4 Press the **Scroll** buttons until the item you want to clear appears.

Options	Description
<b>All Settings</b>	Clears all of the data stored in memory and resets all of your settings to the factory default.
<b>Copy Setup</b>	Restores all of the copy options to the factory default.
<b>Scan Setup</b>	Restores all of the scan options to the factory default.
<b>System Setup</b>	Restores all of the system options to the factory default.

- 5 Press **Enter** when **Yes** appears.
- 6 Press **Enter** again to confirm clearing.
- 7 Repeat steps 5 through 7 to clear another item.
- 8 Press **Stop/Clear** to return to Standby mode.

## Cleaning your machine

To maintain print and scan quality, follow the cleaning procedures below each time the toner cartridge is replaced or if print and scan quality problems occur.



### Caution

- Always use materials specifically designed for this product, the use of other materials may result in damage, poor performance and create a hazardous situation.
- If your machine or its surroundings are contaminated with toner, we recommend you to use cloth or tissue dampened with water to clean it. Do not use aerosol cleaners, they may be explosive and flammable under certain conditions.

### Cleaning the outside

Clean the covers of the machine with a soft lint-free cloth. You can dampen the cloth slightly with water, but be careful not to let any water drip onto or into the machine.

### Cleaning the inside

During the printing process, paper, toner, and dust particles can accumulate inside the machine. This buildup can cause print quality problems, such as toner specks or smearing. Cleaning the inside of the machine clears or reduces these problems.

- 1 Turn the machine off and unplug the power cord. Wait for the machine to cool down.
- 2 Open the front cover and pull the imaging unit out of the machine using the handle on its bottom.

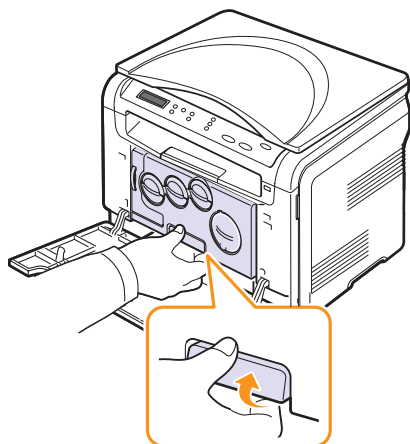

- 3 Extend the top handle on the imaging unit and then use it to pull the imaging unit out of the machine completely.

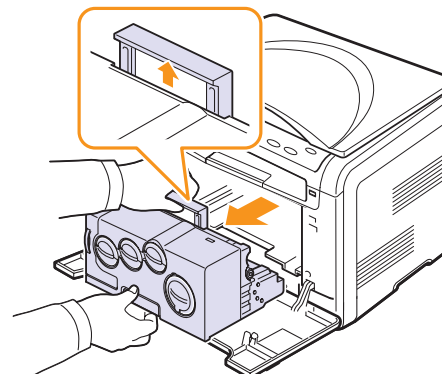

### Caution

- To prevent damage to the imaging unit, do not expose it to light for more than a few minutes. Cover it with a piece of paper, if necessary.
- Do not touch the green surface on the imaging unit with your hands or any other material. Use the handle on it to avoid touching this area.
- Be careful not to scratch the surface of the imaging unit.

- 4 With a dry lint-free cloth, wipe away any dust and spilled toner.

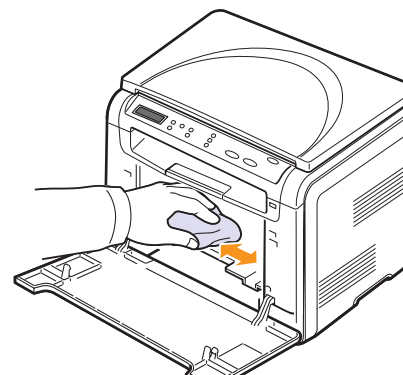

### Tip

After cleaning, let the printer dry completely.

- 5 To install the imaging unit pull the imaging unit about halfway and push it until it sounds 'click'. Repeat this action two or three times.

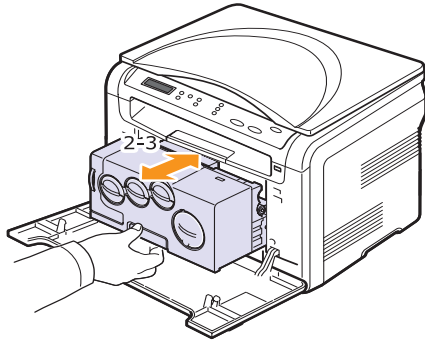

- 6 Push the imaging unit until it sounds 'click' in to the machine.

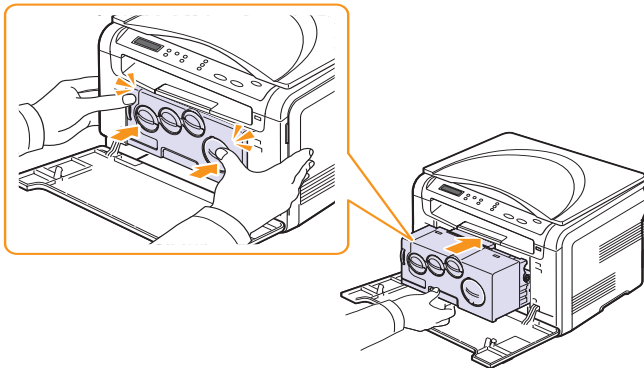

- 7 Close the front cover firmly.



**Caution**

If the front cover is not completely closed, the machine will not operate.

- 8 Plug in the power cord and turn the machine on.



**Caution**

If there is a grinding sound, re-install the imaging unit. The imaging unit is not properly installed.

## Cleaning the scan unit

Keeping the scan unit clean helps ensure the best possible copies. We suggest that you clean the scan unit at the start of each day and during the day, as needed.

- 1 Slightly dampen a soft lint-free cloth or paper towel with water.
- 2 Open the scanner cover.
- 3 Wipe the surface of the scanner glass until it is clean and dry.

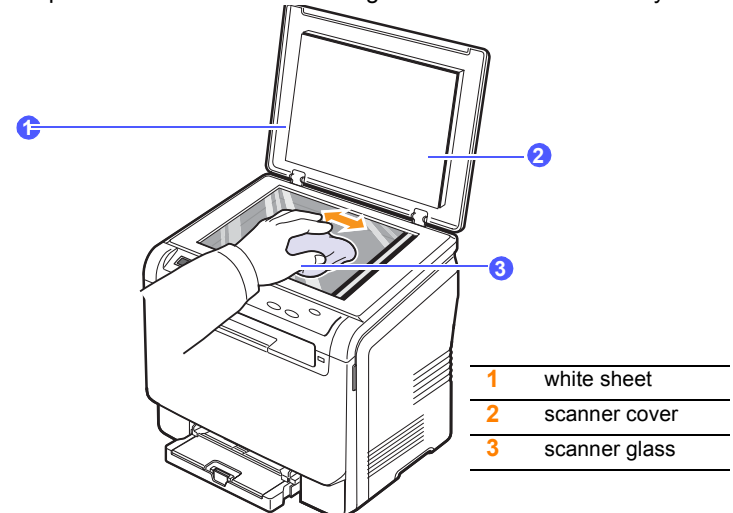

- 4 Wipe the underside of the scanner cover and white sheet until it is clean and dry.
- 5 Close the scanner cover.

---

## Maintaining the toner cartridge

---

### Toner cartridge storage

To get the most from the toner cartridge, keep the following guidelines in mind:

- Do not remove the toner cartridge from its package until ready for use.
- Store toner cartridges in the same environment as your machine.
- To prevent damage to the toner cartridge, do not expose it to light for more than a few minutes.

### Expected cartridge life

The life of the toner cartridge depends on the amount of toner that print jobs require. The actual number may also be different depending on the print density and area coverage of the pages you print on, and the number of pages may be affected by operating environment, printing interval, media type, and media size. If you print a lot of graphics, you may need to change the cartridge more often.

---

## Redistributing toner

---

When the toner cartridge is near the end of its life:

- White streaks or light printing occurs.
- The toner related message telling that the toner is low.

If this happens, you can temporarily reestablish print quality by redistributing the remaining toner in the cartridge. In some cases, white streaks or light printing will still occur even after you have redistributed the toner.

- 1 Open the front cover.
- 2 Pull the corresponding toner cartridge out.

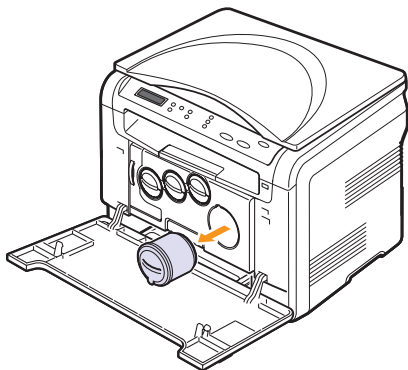

- 3 Holding the toner cartridge, thoroughly roll it 5 or 6 times to distribute the toner evenly inside the cartridge.

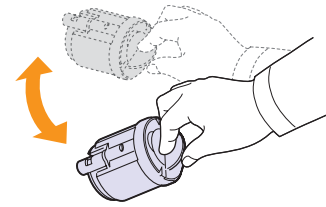

#### Tip

If toner gets on your clothing, wash clothing in cold water. Hot water sets toner into fabric.

- 4 Grasp the toner cartridge and align it with the corresponding slot inside the machine. Insert it back into its slot until it clicks into place.

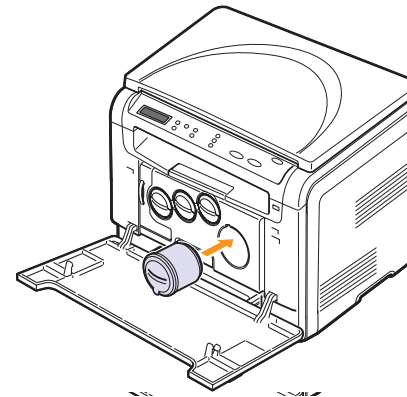

- 5 Close the front cover. Make sure that the cover is securely closed.

## Replacing the toner cartridge

The machine uses four colors and has a different toner cartridge for each one: yellow (Y), magenta (M), cyan (C), and black (K).

When the toner cartridge is completely empty:

- The toner-related message on the display indicate when each individual toner cartridge should be replaced.
- The machine stops printing.

At this stage, the toner cartridge needs to be replaced. For order information for toner cartridges, see page 11.1.

- 1 Turn the machine off, then wait a few minutes for the machine to cool.
- 2 Open the front cover.
- 3 Pull the corresponding toner cartridge out.

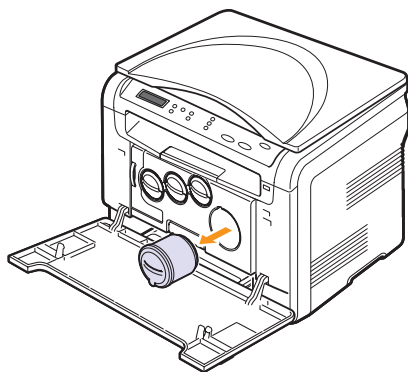

- 4 Take a new toner cartridge out of its package.
- 5 Holding the toner cartridge, thoroughly roll it 5 or 6 times to distribute the toner evenly inside the cartridge.

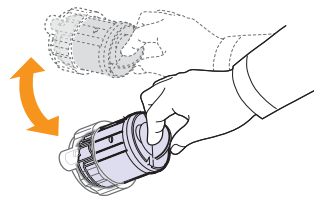

- 6 Remove the cartridge cap.

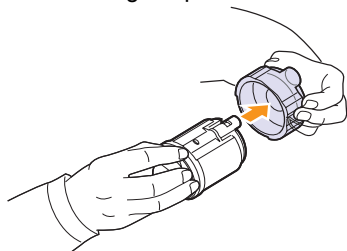

### Tip

If toner gets on your clothing, wash clothing in cold water. Hot water sets toner into fabric.

- 7 Grasp the toner cartridge and align it with the corresponding slot inside the machine. Insert it into its slot until it clicks into place.

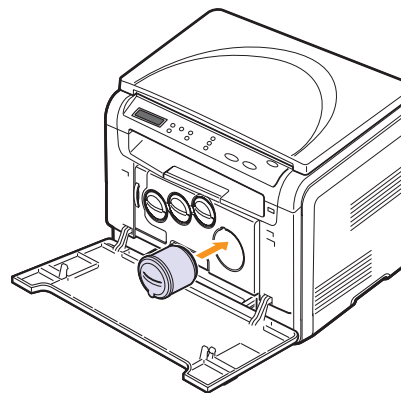

- 8 Close the front cover. Make sure that the cover is securely latched and then turn the machine on.



### Caution

If the front cover is not completely closed, the machine will not operate.



### Tip

If the installation is completed properly, a guide report is printed out automatically. Wait for about 1.5 minutes for the machine to get ready.

## Replacing the imaging unit

The life of the imaging unit is approximately 20,000 pages for black or 50,000 image printing whichever comes first. When the life span of the imaging unit has expired, **Replace Imaging Unit** appears on the display of the control panel, indicating the imaging unit needs to be replaced. Otherwise your printer stops printing.

To replace the imaging unit:

- 1 Turn the machine off, then wait a few minutes for the machine to cool.
- 2 Open the front cover.
- 3 Remove all of the toner cartridges and waste toner container from the machine.

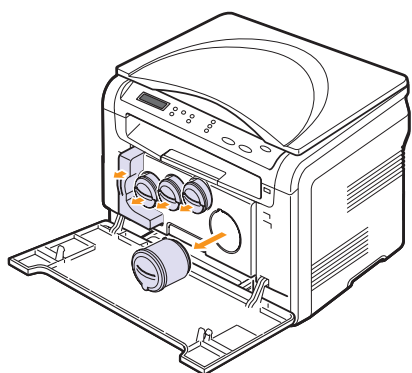

- 4 Pull the imaging unit out of the machine using the handle on its bottom.

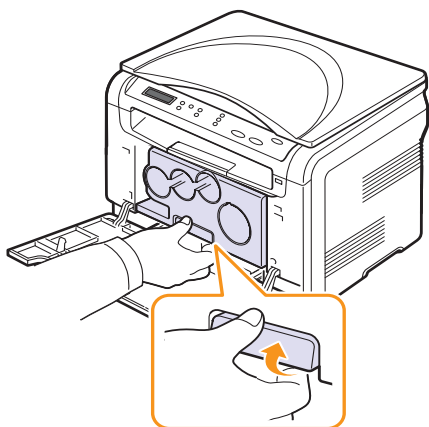

- 5 Extend the top handle on the imaging unit and then use it to pull the imaging unit out of the machine completely.

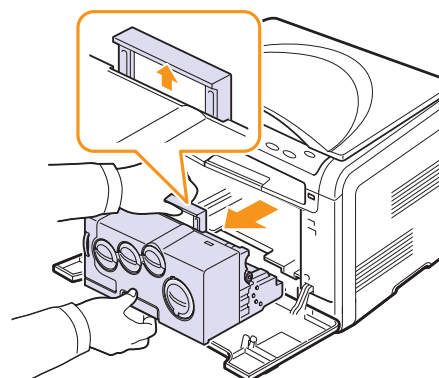

- 6 Take a new imaging unit out of its package. Remove the protective devices on both sides of the imaging unit and the paper protecting the surface of the imaging unit.

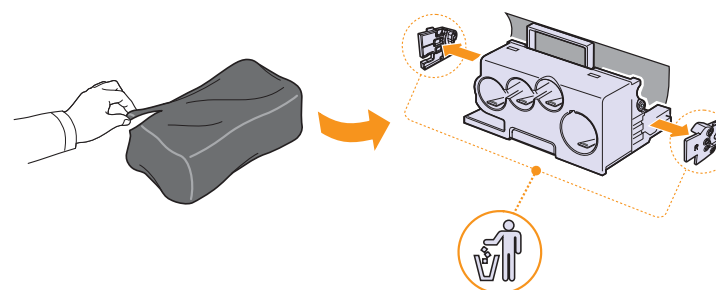

### Caution

- Don't use sharp objects, such as a knife or scissors, to open the imaging unit package. You could damage the surface of the imaging unit.
- Be careful not to scratch the surface of the imaging unit.
- To prevent damage, do not expose the imaging unit to light for more than a few minutes. Cover it with a piece of paper to protect it if necessary.

- 7 Holding the handles on the new imaging unit, push the imaging unit until it sounds 'click' into the machine.

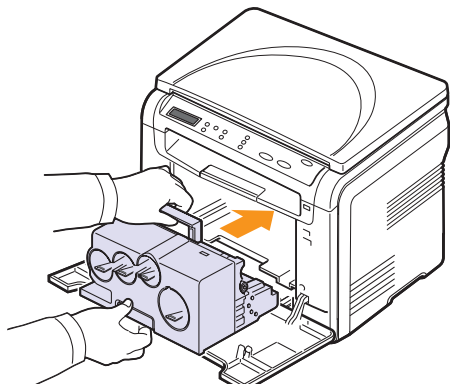

- 8 Remove four dummy caps which are on the toner cartridge entrances of the imaging unit. When you remove the dummy cap from the cartridge, lift the handle up and pull it out.

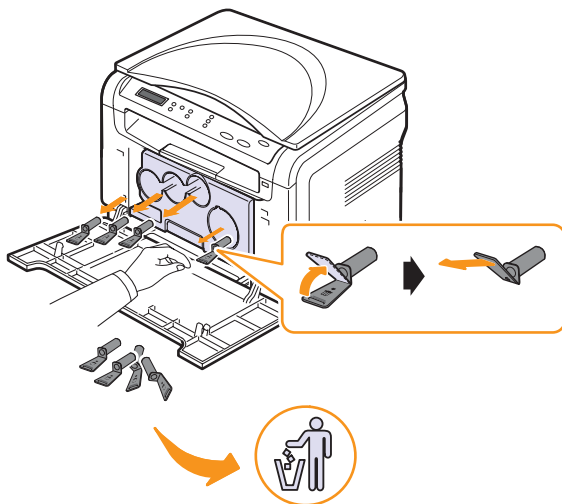

- Caution**  
If you force the dummy caps too much, it may cause a problem.

- 9 Insert the toner cartridges and waste toner container into their corresponding slots until they click into place.

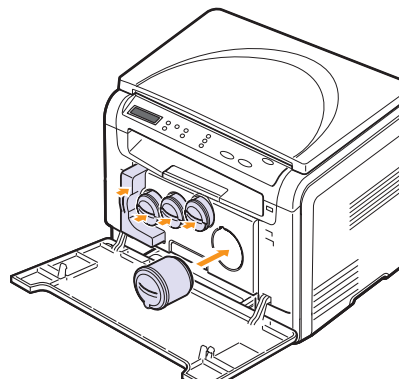

- 10 Close the front cover firmly.

- Caution**  
If the front cover is not completely closed, the machine will not operate.

- 11 Turn the machine on.

- Tip**
- After rebooting, your machine will automatically reset the counter for the imaging unit.
  - If the installation is completed properly, a guide report is printed out automatically. Wait for about 1.5 minutes for the machine to get ready.

- Caution**  
If there is a grinding sound, re-install the imaging unit. The imaging unit is not properly installed.



## Replacing the waste toner container

The life of the waste toner container unit is approximately 1,250 pages for full color 5% image printing or 5,000 images for black printing. When the life span of the waste toner container has expired, **Replace/Install Waste Toner Tank** appears on the display of the control panel, indicating the waste toner container needs to be replaced. Otherwise your printer stops printing.

To replace the waste toner container:

- 1 Turn the machine off, then wait a few minutes for the machine to cool.
- 2 Open the front cover.
- 3 Pull the waste toner container out of the machine using its handle.

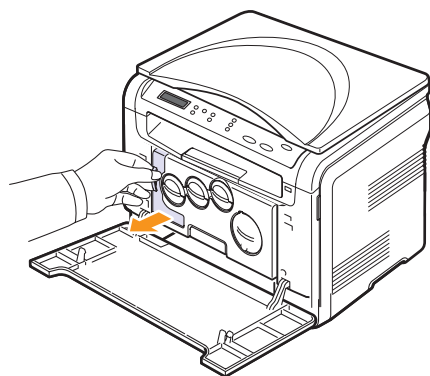

### Tip

Make sure that you lay the waste toner container on a flat surface so that the toner does not spill.

- 4 Remove the container's cap from the container as shown below, and use it to close the waste toner container opening.

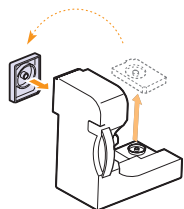

### Caution

Do not tilt or turn the tank over.

- 5 Take a new waste toner container out of its package.

- 6 Insert the new container into position and then push it to make sure that it is firmly seated in place.

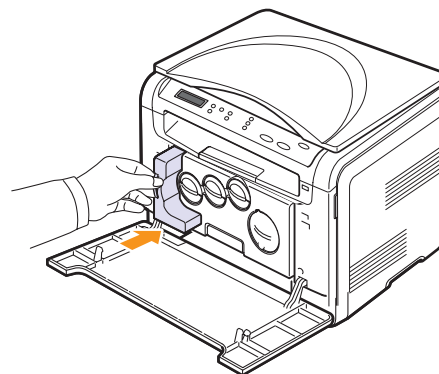

- 7 Close the front cover firmly.



### Caution

If the front cover is not completely closed, the machine will not operate.

- 8 Turn the machine on.



### Tip

After rebooting, your machine will automatically reset the counter for the waste toner container.



---

## Maintenance parts

---

To avoid print quality and paper feed problems resulting from worn parts and to maintain your machine in top working condition the following items will need to be replaced at the specified number of pages or when the life span of each item has expired.

Items	Yield (Average)
Transfer belt	Approx. 60,000 images
Transfer roller	Approx. 100,000 pages
Fuser unit	Approx. 100,000 black pages or 50,000 color pages
Tray rubber pad	Approx. 250,000 pages
Pickup roller	Approx. 50,000 pages

Xerox highly recommends that an authorized service provider, dealer or the retailer where you bought printer performs this maintenance activity.

## Checking replaceables

If you experience frequent paper jams or printing problems, check the number of pages the machine has printed or scanned. Replace the corresponding parts, if necessary.

The following information are available for checking the replaceable elements of your machine:

- **Supplies Info:** prints the supply information page.
- **Total:** displays the total number of pages printed.
- **Platen Scan:** displays the number of pages scanned using the scanner glass.
- **Imaging Unit, Transfer Belt, Fuser, TransferRoller, Tray Roller:** displays the number of pages printed each item.

To check the replaceables:

- 1 Press **Menu** until **Copy Menu** appears on the bottom line of the display and press **Enter**.
- 2 Press the **Scroll** buttons until **System Setup** appears and press **Enter**.
- 3 Press the **Scroll** buttons until **Maintenance** appears and press **Enter**.
- 4 Press the **Scroll** buttons until **Supplies Life** appears and press **Enter**.
- 5 Press the **Scroll** buttons until the item you want appears and press **Enter**.
- 6 If you selected to print a supply information page, press **Enter** to confirm.
- 7 Press **Stop/Clear** to return to Standby mode.

---

## Checking the machine's serial number

---

When you call for service or register as a user on the Xerox website, the machine's serial number may be required.

You can check the serial number by taking the following steps:

- 1 Press **Menu** until **Copy Menu** appears on the bottom line of the display and press **Enter**.
- 2 Press the **Scroll** buttons until **System Setup** appears and press **Enter**.
- 3 Press the **Scroll** buttons until **Maintenance** appears and press **Enter**.
- 4 Press the **Scroll** buttons until **Serial Number** appears and press **Enter**.
- 5 Check your machine's serial number.
- 6 Press **Stop/Clear** to return to Standby mode.

# 10 Troubleshooting

This chapter gives helpful information for what to do if you encounter an error.

This chapter includes:

- **Tips for avoiding paper jams**
- **Clearing paper jams**
- **Understanding display messages**
- **Solving other problems**

## Tips for avoiding paper jams

By selecting the correct media types, most paper jams can be avoided. Follow the procedures on page 4.5. Ensure that the adjustable guides are positioned correctly.

- Do not overload the tray. Ensure that the paper level is under the brackets of the tray.
- Do not remove paper from the tray while your machine is printing.
- Flex, fan, and straighten paper before loading.
- Do not use creased, damp, or highly curled paper.
- Do not mix paper types in a tray.
- Use only recommended print media. See page 4.2.

Ensure that the recommended print side of print media is facing up in the manual tray and tray.

## Clearing paper jams

When a paper jam occurs, paper jam messages appear on the display. Refer to the table below to locate and clear the paper jam.

Message	Location of jam	Go to
<b>Paper Jam 0 Open/Close Door</b>	In the paper feed area	page 10.1
<b>Paper Jam 1 Open/Close Door</b>	In the fuser area or around the rear cover	page 10.3
<b>Scan Unit Open or Paper Jam2</b>	In the paper exit area	page 10.2
<b>Manual Feeder Paper Jam 0</b>	In the paper feed area	page 10.2



### Caution

To avoid tearing the paper, pull out the jammed paper gently and slowly. Follow the instructions in the following sections to clear the jam.

## In the tray

- 1 Open and close the front cover. The jammed paper is automatically ejected from the machine.  
If the paper does not exit, go to the next step.
- 2 Pull the tray out of the machine.

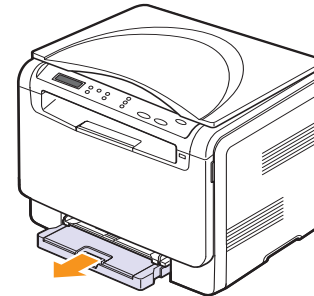

- 3 Remove the jammed paper by gently pulling it straight out.

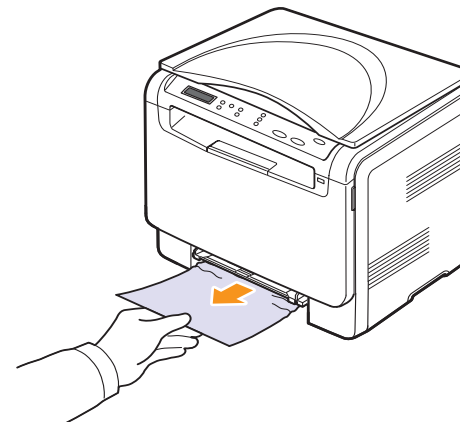

If the paper does not move when you pull, or if you do not see the paper in this area, check the paper exit area. See page 10.2.

- 4 Insert the tray into the machine until it snaps into place.
- 5 Open and close the front cover. Printing automatically resumes.

## In the manual feeder

- 1 Pull the tray out.
- 2 Push the manual feeder tab down.

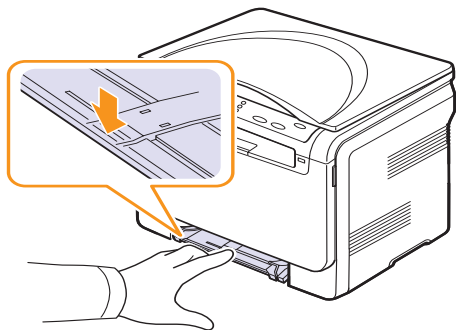

- 3 Pull the jammed paper out of the manual feeder.

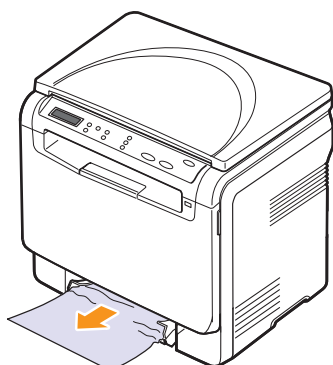

- 4 Insert the tray into the machine until it snaps into place.
- 5 Open and close the front cover. Printing automatically resumes.

## In the paper exit area

- 1 Open and close the front cover. The jammed paper is automatically ejected from the machine.
- 2 Gently pull the paper out of the output tray.

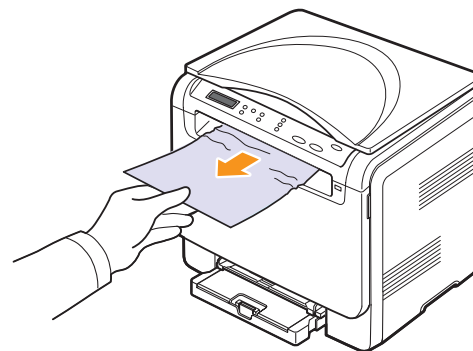

If you do not see the jammed paper or if there is any resistance when you pull, stop and go to the next step.

- 3 Lift the scan unit.

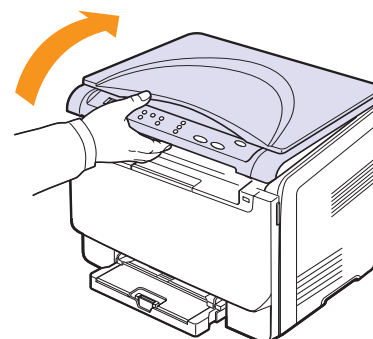

- 4 Holding the inner cover open, carefully take the jammed paper out of the machine.

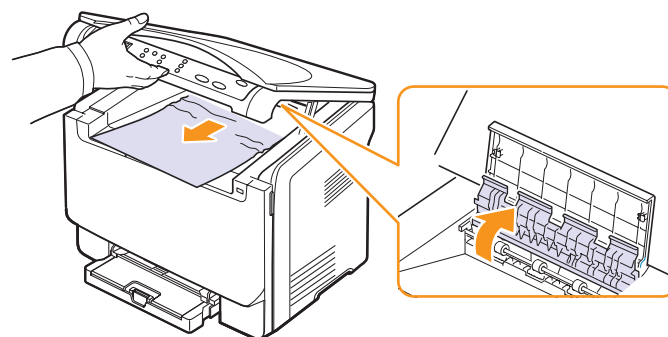

- 5 Lowering down the scan unit gently and slowly until it is completely closed. The inner cover will be closed automatically by the scan unit closing.

Be careful not to pinch your fingers!

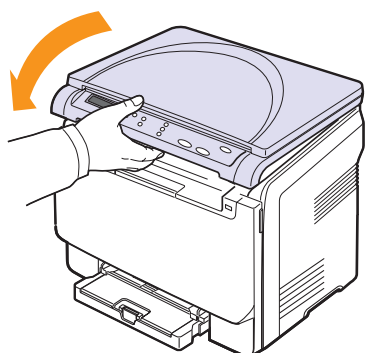

If there is any resistance and the paper does not move when you pull or if you cannot see the paper under the scan unit, continue to the next step.

- 6 Open the rear cover.  
7 If you see the jammed paper, pull it straight up.

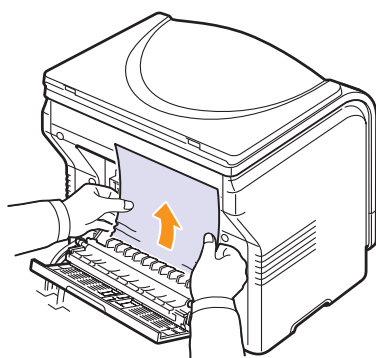

- 8 Close the rear cover. Printing automatically resumes.

## Understanding display messages

Messages appear on the control panel display to indicate the machine's status or errors. Refer to the tables below to understand the messages' meaning and correct the problem if necessary. Messages and their meanings are listed in alphabetical order.



### Tip

When you call for service, it is very convenient to tell the service representative the display message.

Message	Meaning	Suggested solutions
<b>Toner Empty</b> ▼	The color toner cartridge has run out. The machine stops printing. The arrow indicates which color toner cartridge.	Replace the color toner cartridge with a new one. See page 9.5
<b>Toner Low</b> ▼	The corresponding color toner cartridge is almost empty. The arrow indicates which color toner cartridge.	Take out the toner cartridge and thoroughly shake it. By doing this, you can temporarily reestablish printing operations.
<b>TonerSupply Err.</b> ▼	The machine received several papers with many images, and it can not supply the toner properly. The arrow indicates which color toner cartridge.	Unplug the power cord and plug it back in. If the problem persists, please call for service.
<b>Data Read Fail</b> <b>Check USB Mem.</b>	Time expired while reading data.	Try again.
<b>Data Write Fail</b> <b>Check USB Mem.</b>	Storing to the USB memory failed.	Check the available USB memory space.
<b>Door Open</b>	The front cover or rear cover is not securely latched.	Close the cover until it locks into place.
<b>File Format Not Supported</b>	The selected file format is not supported.	Use the correct file format.
<b>Fuser Fan Locked</b>	There is a problem in the cooling fan of the machine.	Open and then close the front cover.

Message	Meaning	Suggested solutions
<b>Install Toner</b> ▼	The color toner cartridge is not installed. The arrow indicates which color toner cartridge.	Install the color toner cartridge.
<b>Install Imaging Unit</b>	The corresponding Imaging Unit of the machine is not installed.	Install Imaging Unit into your machine.
<b>Invalid Toner</b> ▼	The color toner cartridge you have installed is not for your machine. The arrow indicates which color toner cartridge.	Install the a Xerox-genuine color toner cartridge designed for your machine.
<b>Invalid Imaging Unit</b>	The Imaging Unit of the machine is not for your machine.	Install the a Xerox-genuine part designed for your machine.
<b>Low Heat Error Cycle Power</b>	There is a problem in the fuser unit.	Unplug the power cord and plug it back in. If the problem persists, please call for service.
<b>LSU Hsync Error Cycle Power</b>	A problem has occurred in the LSU (Laser Scanning Unit).	Unplug the power cord and plug it back in. If the problem persists, please call for service.
<b>LSU Motor Error Cycle Power</b>	A problem has occurred in the LSU (Laser Scanning Unit).	Unplug the power cord and plug it back in. If the problem persists, please call for service.
<b>Main Motor Locked</b>	There is a problem in the main motor.	Open and then close the front cover.
<b>Manual Feeder Paper Empty</b>	There is no paper in the manual feeder.	Load paper in the manual feeder.
<b>Manual Feeder Paper Jam 0</b>	Paper has jammed in the feeding area of the manual feeder.	Clear the jam. See page 10.2.
<b>Not Enough Space In USB Memory</b>	The space for USB memory device is not enough, which is for scanning and saving.	Check the available USB memory space. See page 8.4.

Message	Meaning	Suggested solutions
<b>Open Heat Error Cycle Power</b>	There is a problem in the fuser unit.	Unplug the power cord and plug it back in. If the problem persists, please call for service.
<b>Out-Bin Full</b>	The output tray of the machine is full of paper.	Remove paper.
<b>Over Heat Error Cycle Power</b>	There is a problem in the fuser unit.	Unplug the power cord and plug it back in. If the problem persists, please call for service.
<b>Paper Jam 0 Open/Close Door</b>	Paper has jammed in the feeding area of the tray.	Clear the jam. See page 10.1, 10.2.
<b>Scan Unit Open or Paper Jam2</b>	The scan unit is not securely latched. Paper has jammed in the paper exit area.	Close the scan until it locks into place. Clear the jam. See page 10.2.
<b>Paper Jam 1 Open/Close Door</b>	Paper has jammed In the fuser area or rear cover.	Clear the jam. See page 10.2.
<b>Tray Paper Mismatch</b>	The paper size specified in the printer properties does not match the paper you are loading.	Load the correct paper in the tray 1.
<b>Refilled Toner</b> ▼	The toner cartridge you have installed is not genuine or refilled. The arrow indicates which color toner cartridge.	The print quality may get poor if the refilled toner cartridge is installed, since its characteristics may significantly differ from the genuine. We recommend Xerox-genuine color toner cartridge.
<b>Replace Toner</b> ▼	This message appears between <b>Toner Empty</b> and <b>Toner Low</b> status. The arrow indicates which color toner cartridge.	Replace the toner cartridge with a new one. See page 9.5.

Message	Meaning	Suggested solutions
<b>Replace [zzz]</b> * zzz indicates the part of the machine.	The life of the part expires totally.	Replace the part with a new one. Call for service.
<b>Replace [zzz] Soon</b> * xxx indicates the part of the machine.	The life of the part expires soon.	See page 9.9 and call for service.
<b>Replace/Install Waste Toner Tank</b>	The life span of the waste toner tank has expired and the printer will stop printing until a new waste toner tank is placed into the printer.	See page 9.8.
<b>Scanner locked</b>	The scanner module is locked.	Unplug the power cord and plug it back in. If the problem persists, please call for service.
<b>Transfer Belt Error</b>	A problem has occurred in the transfer belt in the machine.	Unplug the power cord and plug it back in. If the problem persists, please call for service.
<b>Tray Paper Empty</b>	There is no paper in the tray 1.	Load paper in the tray 1. See page 4.5.

## Solving other problems

The following chart lists some conditions that may occur and the recommended solutions. Follow the suggested solutions until the problem is corrected. If the problem persists, please call for service.

### Paper feeding problems

Condition	Suggested solutions
Paper is jammed during printing.	Clear the paper jam. See page 10.1.
Paper sticks together.	<ul style="list-style-type: none"> <li>• Ensure that there is not too much paper in the tray. The tray can hold up to 150 sheets of paper, depending on the thickness of your paper.</li> <li>• Make sure that you are using the correct type of paper. See page 4.3.</li> <li>• Remove paper from the tray and flex or fan the paper.</li> <li>• Humid conditions may cause some paper to stick together.</li> </ul>
Multiple sheets of paper do not feed.	<ul style="list-style-type: none"> <li>• Different types of paper may be stacked in the tray. Load paper of only one type, size, and weight.</li> <li>• If multiple sheets have caused a paper jam, clear the paper jam. See page 10.1.</li> </ul>
Paper does not feed into the machine.	<ul style="list-style-type: none"> <li>• Remove any obstructions from inside the machine.</li> <li>• Paper has not been loaded correctly. Remove paper from the tray and reload it correctly.</li> <li>• There is too much paper in the tray. Remove excess paper from the tray.</li> <li>• The paper is too thick. Use only paper that meets the specifications required by the machine. See page 4.2.</li> </ul>
The paper keeps jamming.	<ul style="list-style-type: none"> <li>• There is too much paper in the tray. Remove excess paper from the tray. If you are printing on special materials, use the manual tray.</li> <li>• An incorrect type of paper is being used. Use only paper that meets the specifications required by the machine. See page 4.2.</li> <li>• There may be debris inside the machine. Open the front cover and remove the debris.</li> </ul>
Transparencies stick together in the paper exit.	Use only transparencies specifically designed for laser printers. Remove each transparency as it exits from the machine.
Envelopes skew or fail to feed correctly.	Ensure that the paper guides are against both sides of the envelopes.

## Printing problems

Condition	Possible cause	Suggested solutions
The machine does not print.	The machine is not receiving power.	Check the power cord connections. Check the power switch and the power source.
	The machine is not selected as the default printer.	Select <b>Xerox Phaser 6110 MFP</b> as your default printer in your Windows.
	Check the machine for the following: <ul style="list-style-type: none"> <li>• The front cover is not closed. Close the cover.</li> <li>• Paper is jammed. Clear the paper jam. See 10.1.</li> <li>• No paper is loaded. Load paper. See 4.5.</li> <li>• The toner cartridge is not installed. Install the toner cartridge.</li> </ul> If a system error occurs, contact your service representative.	
	The connection cable between the computer and the machine is not connected properly.	Disconnect the printer cable and reconnect it.
	The connection cable between the computer and the machine is defective.	If possible, attach the cable to another computer that is working properly and print a job. You can also try using a different printer cable.
	The port setting is incorrect.	Check the Windows printer setting to make sure that the print job is sent to the correct port. If the computer has more than one port, make sure that the machine is attached to the correct one.
	The machine may be configured incorrectly.	Check the printer properties to ensure that all of the print settings are correct.
	The printer driver may be incorrectly installed.	Repair the printer software. See the <b>Software section</b> .
	The machine is malfunctioning.	Check the display message on the control panel to see if the machine is indicating a system error.
	The document size is so big that the hard disk space of the computer is not enough to access the print job.	Get more hard disk space and print the document again.

Condition	Possible cause	Suggested solutions
The machine selects print materials from the wrong paper source.	The paper source selection in the printer properties may be incorrect.	For many software applications, the paper source selection is found under the <b>Paper</b> tab within the printer properties. Select the correct paper source. See the printer driver help screen.
A print job is extremely slow.	The job may be very complex.	Reduce the complexity of the page or try adjusting the print quality settings.
Half the page is blank.	The page orientation setting may be incorrect.	Change the page orientation in your application. See the printer driver help screen.
	The paper size and the paper size settings do not match.	Ensure that the paper size in the printer driver settings matches the paper in the tray. Or, ensure that the paper size in the printer driver settings matches the paper selection in the software application settings you use.
The machine prints, but the text is wrong, garbled, or incomplete.	The printer cable is loose or defective.	Disconnect the printer cable and reconnect. Try a print job that you have already printed successfully. If possible, attach the cable and the machine to another computer and try a print job that you know works. Finally, try a new printer cable.
	The wrong printer driver was selected.	Check the application's printer selection menu to ensure that your machine is selected.
	The software application is malfunctioning.	Try printing a job from another application.
	The operating system is malfunctioning.	Exit Windows and reboot the computer. Turn the machine off and then back on again.



Condition	Possible cause	Suggested solutions
Pages print, but are blank.	The toner cartridge is defective or out of toner.	Redistribute the toner, if necessary. See page 9.4. If necessary, replace the toner cartridge.
	The file may have blank pages.	Check the file to ensure that it does not contain blank pages.
	Some parts, such as the controller or the board, may be defective.	Contact a service representative.
The printer does not print PDF file correctly. Some parts of graphics, text, or illustrations are missing.	Incompatibility between the PDF file and the Acrobat products	Printing the PDF file as an image may solve this problem. Turn on <b>Print As Image</b> from the Acrobat printing options. <b>Tip:</b> It will take longer to print when you print a PDF file as an image.

## Printing quality problems

If the inside of the machine is dirty or paper has been loaded improperly, you may notice a reduction in print quality. See the table below to clear the problem.

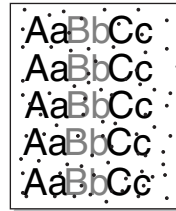
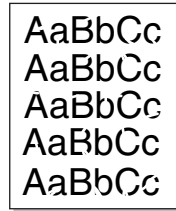
Condition	Suggested solutions
<b>Light or faded print</b> 	<p>If a vertical white streak or faded area appears on the page:</p> <ul style="list-style-type: none"> <li>The toner supply is low. You may be able to temporarily extend the toner cartridge life. See page 9.4. If this does not improve the print quality, install a new toner cartridge.</li> <li>The paper may not meet paper specifications; for example, the paper is too moist or too rough. See page 4.1.</li> <li>If the entire page is light, the print resolution setting is too low. Adjust the print resolution. See the help screen of the printer driver.</li> <li>A combination of faded or smeared defects may indicate that the toner cartridge needs cleaning.</li> <li>The surface of the LSU part inside the machine may be dirty. Clean the LSU. See page 9.2.</li> </ul>
<b>Toner specks</b> 	<ul style="list-style-type: none"> <li>The paper may not meet specifications; for example, the paper is too moist or too rough. See page 4.1.</li> <li>The transfer roller may be dirty. Clean the inside of your machine. See page 9.2.</li> <li>The paper path may need cleaning. See page 9.2.</li> </ul>
<b>Dropouts</b> 	<p>If faded areas, generally rounded, occur randomly on the page:</p> <ul style="list-style-type: none"> <li>A single sheet of paper may be defective. Try reprinting the job.</li> <li>The moisture content of the paper is uneven or the paper has moist spots on its surface. Try a different brand of paper. See page 4.1.</li> <li>The paper lot is bad. The manufacturing processes can cause some areas to reject toner. Try a different kind or brand of paper.</li> <li>Change the printer option and try again. Go to printer properties, click <b>Paper</b> tab, and set type to <b>Thick</b>. Refer to the <b>Software section</b> for details.</li> <li>If these steps do not correct the problem, contact a service representative.</li> </ul>

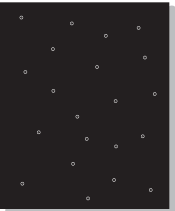
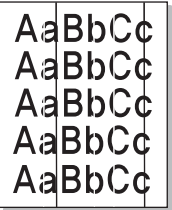
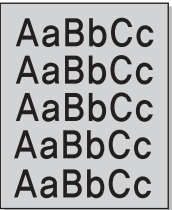
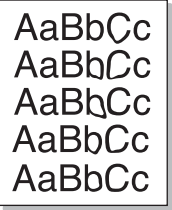

Condition	Suggested solutions
<b>White Spots</b> 	<p>White spots appears on the page:</p> <ul style="list-style-type: none"> <li>The paper is too rough and a lot of dirt from a paper falls to the inner devices within the machine, so the transfer roller may be dirty. Clean the inside of your machine. See page 9.2. Contact a service representative.</li> <li>The paper path may need cleaning. Contact a service representative.</li> </ul>
<b>Vertical lines</b> 	<p>If black vertical streaks appear on the page:</p> <ul style="list-style-type: none"> <li>The drum inside the toner cartridge has probably been scratched. Remove the toner cartridge and install a new one. See page 9.5.</li> </ul> <p>If white vertical streaks appear on the page:</p> <ul style="list-style-type: none"> <li>The surface of the LSU part inside the machine may be dirty. Clean the LSU. See page 9.2.</li> </ul>
<b>Color or Black background</b> 	<p>If the amount of background shading becomes unacceptable:</p> <ul style="list-style-type: none"> <li>Change to a lighter weight paper. See page 4.1.</li> <li>Check the machine's environment: very dry (low humidity) or high humidity (higher than 80% RH) conditions can increase the amount of background shading.</li> <li>Remove the old toner cartridge and install a new one. See page 9.5.</li> </ul>
<b>Toner smear</b> 	<ul style="list-style-type: none"> <li>Clean the inside of the machine. See page 9.2.</li> <li>Check the paper type and quality. See page 4.1.</li> <li>Remove the toner cartridge and install a new one. See page 9.5.</li> </ul>

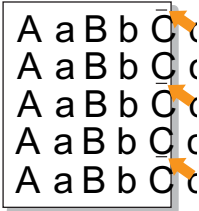
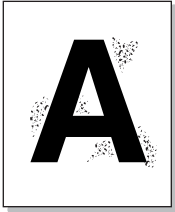
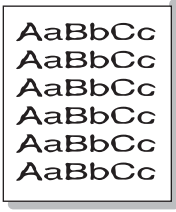
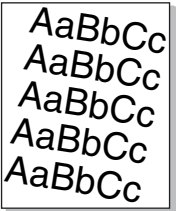
Condition	Suggested solutions
<b>Vertical repetitive defects</b> 	<p>If marks repeatedly appear on the printed side of the page at even intervals:</p> <ul style="list-style-type: none"> <li>The toner cartridge may be damaged. If a repetitive mark occurs on the page, print a cleaning sheet several times to clean the cartridge; see page 9.4. After the printout, if you still have the same problems, remove the toner cartridge and install a new one. See page 9.5.</li> <li>Parts of the machine may have toner on them. If the defects occur on the back of the page, the problem will likely correct itself after a few more pages.</li> <li>The fusing assembly may be damaged. Contact a service representative.</li> </ul>
<b>Background scatter</b> 	<p>Background scatter results from bits of toner randomly distributed on the printed page.</p> <ul style="list-style-type: none"> <li>The paper may be too damp. Try printing with a different batch of paper. Do not open packages of paper until necessary so that the paper does not absorb too much moisture.</li> <li>If background scatter occurs on an envelope, change the printing layout to avoid printing over areas that have overlapping seams on the reverse side. Printing on seams can cause problems.</li> <li>If background scatter covers the entire surface area of a printed page, adjust the print resolution through your software application or the printer properties.</li> </ul>
<b>Misformed characters</b> 	<ul style="list-style-type: none"> <li>If characters are improperly formed and producing hollow images, the paper stock may be too slick. Try a different paper. See page 4.1.</li> <li>If characters are improperly formed and producing a wavy effect, the scanner unit may need service. For service, contact a service representative.</li> </ul>
<b>Page skew</b> 	<ul style="list-style-type: none"> <li>Ensure that the paper is loaded properly.</li> <li>Check the paper type and quality. See page 4.1.</li> <li>Ensure that the paper or other material is loaded correctly and the guides are not too tight or too loose against the paper stack.</li> </ul>

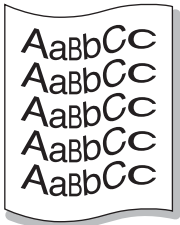
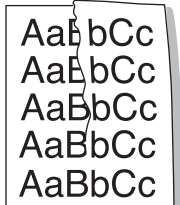
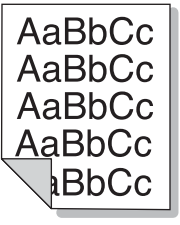
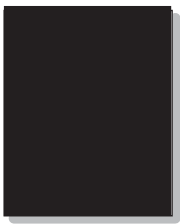
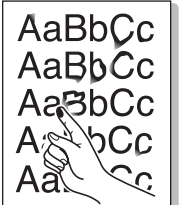
Condition	Suggested solutions
<b>Curl or wave</b> 	<ul style="list-style-type: none"> <li>• Ensure that the paper is loaded properly.</li> <li>• Check the paper type and quality. Both high temperature and humidity can cause paper curl. See page 4.1.</li> <li>• Turn over the stack of paper in the tray. Also try rotating the paper 180° in the tray.</li> </ul>
<b>Wrinkles or creases</b> 	<ul style="list-style-type: none"> <li>• Ensure that the paper is loaded properly.</li> <li>• Check the paper type and quality. See page 4.1.</li> <li>• Turn over the stack of paper in the tray. Also try rotating the paper 180° in the tray.</li> </ul>
<b>Back of printouts are dirty</b> 	<p>Check for leaking toner. Clean the inside of the machine. See page 9.2.</p>
<b>Solid Color or Black pages</b> 	<ul style="list-style-type: none"> <li>• The toner cartridge may not be installed properly. Remove the cartridge and reinsert it.</li> <li>• The toner cartridge may be defective and need replacing. Remove the toner cartridge and install a new one. See page 9.5.</li> <li>• The machine may require repair. Contact a service representative.</li> </ul>
<b>Loose toner</b> 	<ul style="list-style-type: none"> <li>• Clean the inside of the machine. See page 9.2.</li> <li>• Check the paper type and quality. See page 4.1.</li> <li>• Remove the toner cartridge and install a new one. See page 9.5.</li> <li>• If the problem persists, the machine may require repair. Contact a service representative.</li> </ul>

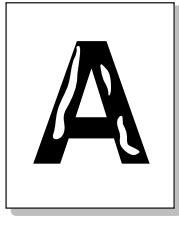
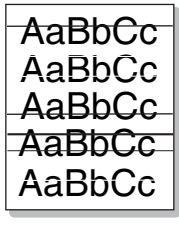
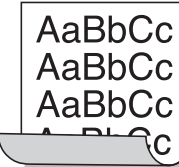
Condition	Suggested solutions
<b>Character Voids</b> 	<p>Character voids are white areas within parts of characters that should be solid black:</p> <ul style="list-style-type: none"> <li>• If you are using transparencies, try another type of transparency. Because of the composition of transparencies, some character voids are normal.</li> <li>• You may be printing on the wrong surface of the paper. Remove the paper and turn it around.</li> <li>• The paper may not meet paper specifications. See page 4.1.</li> </ul>
<b>Horizontal stripes</b> 	<p>If horizontally aligned black streaks or smears appear:</p> <ul style="list-style-type: none"> <li>• The toner cartridge may be installed improperly. Remove the cartridge and reinsert it.</li> <li>• The toner cartridge may be defective. Remove the toner cartridge and install a new one. See page 9.5.</li> <li>• If the problem persists, the machine may require repair. Contact a service representative.</li> </ul>
<b>Curl</b> 	<p>If the printed paper is curled or paper does not feed into the machine:</p> <ul style="list-style-type: none"> <li>• Turn over the stack of paper in the tray. Also try rotating the paper 180° in the tray.</li> <li>• Change the printer option and try again. Go to printer properties, click <b>Paper</b> tab, and set type to <b>Thin</b>. Refer to the <b>Software section</b> for details.</li> </ul>
<p>An unknown image repetitively appears on a next few sheets or loose toner, light print, or contamination occurs.</p>	<p>Your printer is probably being used at an altitude of 2,500 m (8,200 ft) or above. The high altitude may affect the print quality such as loose toner or light imaging. You can set this option through <b>Printer Settings Utility</b> or <b>Printer</b> tab in printer driver's properties. See <b>Software section</b> .</p>

## Copying problems

Condition	Suggested solutions
Copies are too light or too dark.	Use <b>Darkness</b> to darken or lighten the background of the copies.
Smears, lines, marks, or spots appears on copies.	<ul style="list-style-type: none"> <li>If defects are on the original, use <b>Darkness</b> to lighten the background of your copies.</li> <li>If no defects are on the original, clean the scan unit. See page 9.3.</li> </ul>
Copy image is skewed.	<ul style="list-style-type: none"> <li>Ensure that the original is face down on the scanner glass.</li> <li>Check that the copy paper is loaded correctly.</li> </ul>
Blank copies print out.	Ensure that the original is face down on the scanner glass.
Image rubs off the copy easily.	<ul style="list-style-type: none"> <li>Replace the paper in the tray with paper from a new package.</li> <li>In high humidity areas, do not leave paper in the machine for extended periods of time.</li> </ul>
Frequent copy paper jams occur.	<ul style="list-style-type: none"> <li>Fan the stack of paper, then turn it over in the tray. Replace the paper in the tray with a fresh supply. Check/adjust the paper guides, if necessary.</li> <li>Ensure that the paper is the proper paper weight. 75 g/m2 (20 lb bond) paper is recommended.</li> <li>Check for copy paper or pieces of copy paper remaining in the machine after a paper jam has been cleared.</li> </ul>
Toner cartridge produces fewer copies than expected before running out of toner.	<ul style="list-style-type: none"> <li>Your originals may contain pictures, solids, or heavy lines. For example, your originals may be forms, newsletters, books, or other documents that use more toner.</li> <li>The machine may be turned on and off frequently.</li> <li>The scanner cover may be left open while copies are being made.</li> </ul>

## Scanning problems

Condition	Suggested solutions
The scanner does not work.	<ul style="list-style-type: none"> <li>Make sure that you place the original to be scanned face down on the scanner glass.</li> <li>There may not be enough available memory to hold the document you want to scan. Try the prescan function to see if that works. Try lowering the scan resolution rate.</li> <li>Check that the USB cable is connected properly.</li> <li>Make sure that the USB cable is not defective. Switch the cable with a known good cable. If necessary, replace the cable.</li> </ul>
The unit scans very slowly.	<ul style="list-style-type: none"> <li>Check if the machine is printing received data. If so, scan the document after the received data has been printed.</li> <li>Graphics are scanned more slowly than text.</li> <li>Communication speed slows in scan mode because of the large amount of memory required to analyze and reproduce the scanned image. Set your computer to the ECP printer mode through BIOS setting. It will help to increase the speed. For details about how to set BIOS, refer to your computer user's guide.</li> </ul>
Message appears on your computer screen: <ul style="list-style-type: none"> <li>“Device can't be set to the H/W mode you want.”</li> <li>“Port is being used by another program.”</li> <li>“Port is Disabled.”</li> <li>“Scanner is busy receiving or printing data. When the current job is completed, try again.”</li> <li>“Invalid handle.”</li> <li>“Scanning has failed.”</li> </ul>	<ul style="list-style-type: none"> <li>There may be a copying or printing job in progress. When that job is complete, try your job again.</li> <li>The Selected port is currently being used. Restart your computer and try again.</li> <li>The printer cable may be improperly connected or the power may be off.</li> <li>The scanner driver is not installed or the operating environment is not set up properly.</li> <li>Ensure that the machine is properly connected and the power is on, Then restart your computer.</li> <li>The USB cable may be improperly connected or the power may be off.</li> </ul>

## Common Windows problems

Condition	Suggested solutions
“File in Use” message appears during installation.	Exit all software applications. Remove all software from the StartUp Group, then restart Windows. Reinstall the printer driver.
“General Protection Fault”, “Exception OE”, “Spool32”, or “Illegal Operation” messages appear.	Close all other applications, reboot Windows and try printing again.
“Fail To Print”, “A printer timeout error occurred.” messages appear.	These messages may appear during printing. Just keep waiting until the machine finishes printing. If the message appears in standby mode or after printing has been completed, check the connection and/or whether an error has occurred.



### Tip

Refer to Microsoft Windows 2000/XP/2003/Vista User's Guide that came with your PC for further information on Windows error messages.

## Common Macintosh problems

Condition	Suggested solutions
The printer does not print PDF file correctly. Some parts of graphics, text, or illustrations are missing.	Incompatibility between the PDF file and the Acrobat products: Printing the PDF file as an image may solve this problem. Turn on <b>Print As Image</b> from the Acrobat printing options. <b>Tip:</b> It will take longer to print when you print a PDF file as an image.
The document has printed, but the print job has not disappeared from the spooler in Mac OS 10.3.2.	Update your Mac OS to OS 10.3.3. or higher.
Some letters are not displayed normally during the cover sheet printing.	This problem is caused because Mac OS cannot find the font during the cover page printing. Alphanumeric characters, in the Billing Info field, are only allowed for printing on the cover page. Other characters will be broken on the printout.

## Common Linux problems

Problem	Possible cause and solutions
The machine does not print.	<ul style="list-style-type: none"> <li>• Check if the printer driver is installed in your system. Open Unified Driver configurator and switch to the Printers tab in Printers configuration window to look at the list of available printers. Make sure that your machine is displayed on the list. If not, please, invoke Add new printer wizard to set up your device.</li> <li>• Check if the printer has started. Open Printers configuration and select your machine on the printers list. Look at the description in the Selected printer pane. If its status contains “(stopped)” string, please, press the <b>Start</b> button. After that normal operation of the printer should be restored. The “stopped” status might be activated when some problems in printing occurred. For instance, this could be an attempt to print a document when a port is claimed by a scanning application.</li> <li>• Check if the port is not busy. Since functional components of MFP (printer and scanner) share the same I/O interface (port), the situation of simultaneous access of different “consumer” applications to the same port are possible. To avoid possible conflicts, only one of them at a time is allowed to gain control over the device. The other “consumer” will encounter “device busy” response. You should open ports configuration and select the port assigned to your printer. In the Selected port pane you can see if the port is occupied by some other application. If this is the case, you should wait for completion of the current job or should press Release port button, if you are sure that the present owner is not functioning properly.</li> <li>• Check if your application has special print option such as “-oraw”. If “-oraw” is specified in the command line parameter then remove it to print properly. For Gimp front-end, select “print” -&gt; “Setup printer” and edit command line parameter in the command item.</li> </ul>

Problem	Possible cause and solutions
Some color images come out all black.	This is a known bug in Ghostscript (until GNU Ghostscript version 7.05) when the base color space of the document is indexed color space and it is converted through CIE color space. Because Postscript uses CIE color space for Color Matching System, you should upgrade Ghostscript on your system to at least GNU Ghostscript version 7.06 or later. You can find recent Ghostscript versions at <a href="http://www.ghostscript.com">www.ghostscript.com</a> .
The machine does not print whole pages and its output is half page printed.	It is a known problem that occurs when a color printer is used on version 8.51 or earlier of Ghostscript, 64-bit Linux OS, and reported to <a href="http://bugs.ghostscript.com">bugs.ghostscript.com</a> as Ghostscript Bug 688252.  The problem is solved in AFPL Ghostscript v. 8.52 or above. Download the latest version of AFPL Ghostscript from <a href="http://sourceforge.net/projects/ghostscript/">http://sourceforge.net/projects/ghostscript/</a> and install it to solve this problem.
Some color images come out in unexpected color.	This is a known bug in Ghostscript (until GNU Ghostscript version 7.xx) when the base color space of the document is indexed RGB color space and it is converted through CIE color space. Because Postscript uses CIE color space for Color Matching System, you should upgrade Ghostscript on your system to at least GNU Ghostscript version 8.xx or later. You can find recent Ghostscript versions at <a href="http://www.ghostscript.com">www.ghostscript.com</a> .

Problem	Possible cause and solutions
The machine does not appear on the scanners list.	<ul style="list-style-type: none"> <li>• Check if your machine is attached to your computer. Make sure that it is connected properly via the USB port and is turned on.</li> <li>• Check if the scanner driver for your machine is installed in your system. Open Unified Driver configurator, switch to Scanners configuration, then press <b>Drivers</b>. Make sure that driver with a name corresponding to your machine's name is listed in the window. Check if the port is not busy. Since functional components of MFP (printer and scanner) share the same I/O interface (port), the situation of simultaneous access of different "consumer" application to the same port is possible. To avoid possible conflicts, only one of them at a time is allowed to gain control over the device. The other "consumer" will encounter "device busy" response. This can usually happen while starting scan procedure, and appropriate message box appears.</li> <li>• To identify the source of the problem, you should open ports configuration and select the port assigned to your scanner. port's symbol /dev/mfp0 corresponds to LP:0 designation displayed in the scanners' options, /dev/mfp1 relates to LP:1 and so on. USB ports start at /dev/mfp4, so scanner on USB:0 relates to /dev/mfp4 respectively and so forth sequentially. In the Selected port pane you can see if the port is occupied by some other application. If this is the case, you should wait for completion of the current job or you should press Release port button, if you are sure that the present port's owner is not functioning properly.</li> </ul>

Problem	Possible cause and solutions
The machine does not scan.	<ul style="list-style-type: none"> <li>• Check if a document is loaded into the machine.</li> <li>• Check if your machine is connected to the computer. Make sure if it is connected properly if an I/O error is reported while scanning.</li> <li>• Check if the port is not busy. Since functional components of MFP (printer and scanner) share the same I/O interface (port), the situation of simultaneous access of different “consumer” application to the same port is possible. To avoid possible conflicts, only one of them at a time is allowed to gain control over the device. The other “consumer” will encounter “device busy” response. This can usually happen while starting scan procedure, and appropriate message box will be displayed.</li> </ul> <p>To identify the source of the problem, you should open ports configuration and select the port assigned to your scanner. port’s symbol /dev/mfp0 corresponds to LP:0 designation displayed in the scanners’ options, /dev/mfp1 relates to LP:1 and so on. USB ports start at /dev/mfp4, so scanner on USB:0 relates to /dev/mfp4 respectively and so forth sequentially. In the Selected port pane you can see if the port is occupied by some other application. If this is the case, you should wait for completion of the current job or should press the Release port button, if you are sure that the present port’s owner is not functioning properly.</p>
I cannot scan via Gimp Front-end.	<ul style="list-style-type: none"> <li>• Check if Gimp Front-end has “Xsane: Device dialog.” on the “Acquire” menu. If not, you should install Xsane plug-in for Gimp on the your computer. You can find Xsane plug-in package for Gimp on Linux distribution CD or Gimp home page. For the detail information, refer to the Help for Linux distribution CD or Gimp Front-end application.</li> </ul> <p>If you wish to use other kind of scan application, refer to the Help for application.</p>

Problem	Possible cause and solutions
I encounter error “Cannot open port device file” when printing a document.	Please avoid changing the print job parameters (via LPR GUI, for example) while a print job is in progress. Known versions of CUPS server break the print job whenever print options are changed and then try to restart the job from the beginning. Since Unified Linux Driver locks port while printing, the abrupt termination of the driver keeps the port locked and therefore unavailable for subsequent print jobs. If this situation occurred, please, try to release the port.
When printing a document over the network in SuSE 9.2, the machine does not print.	The CUPS (Common Unix Printing System) version distributed with SuSE Linux 9.2 (cups-1.1.21) has a problem with ipp (Internet Printing Protocol) printing. Use the socket printing instead of ipp or install later version of CUPS (cups-1.1.22 or higher).

# 11 Ordering supplies

This chapter provides information on purchasing supplies for your machine.

- **Supplies**
- **How to purchase**

---

## Supplies

---

When the toner runs out or, the life span of the supplies expires you can order the following types of toner cartridges and supplies for your machine:

Type	Yield	Part number
Black toner cartridge	Approx. 2,000 pages <sup>a</sup>	<b>Region List A:</b> 106R01203 <b>Region List B:</b> 106R01274
Colour toner cartridges	Approx. 1,000 pages <sup>a</sup>	<b>Region List A:</b> 106R01206: Cyan 106R01205: Magenta 106R01204: Yellow <b>Region List B:</b> 106R01271: Cyan 106R01272: Magenta 106R01273: Yellow
Imaging unit	Approx. 20,000 black pages or 50,000 images	<b>Region List A:</b> 108R00721 <b>Region List B:</b> 108R00744
Waste toner container	Approx. 5,000 images <sup>b</sup> or approx. 1,250 pages (full colour 5% image)	108R00722

a. Average A4-/letter-sized page count based on 5% coverage of individual colours on each page. Usage conditions and print patterns may cause results to vary.

b. Image counts based on one colour on each page. If you print documents in full colour (Cyan, Magenta, Yellow, Black), the life of this item will be reduced by 25%.

### Region List A:

Algeria, Argentina, Bulgaria, Bermuda, Brazil, Caribbean (excluding Puerto Rico and the US Virgin Islands), Central America, Chile, Colombia, Czech Republic, Croatia, Cyprus, Ecuador, Egypt, Estonia, Gibraltar, Hungary, India, Latvia, Lithuania, Malta, Mexico, Middle East, Morocco, Nigeria, Oman, Pakistan, Paraguay, Peru, Poland, rest of Africa, rest of South America, Romania, Russia/CIS, Slovakia, Slovenia, South Africa, Sri Lanka, Tunisia, Turkey, Ukraine, Uruguay, Venezuela

### Region List B:

Austria, Belgium, Canada, Denmark, Finland, France, Germany, Greece, Ireland, Italy, Netherlands, Norway, Portugal, Puerto Rico, Spain, Sweden, Switzerland, UK, USA, rest of Benelex region

To purchase replacement parts, contact your Xerox dealer or the retailer where you bought your printer. We strongly recommend that items be installed by a trained service professional, except for the toner cartridges (see page 9.5), the imaging unit (see page 9.6), and the waste toner container (see page 9.8).

If you use refilled toner cartridges, print quality may be reduced.

---

## How to purchase

---

To order **Xerox**-authorized supplies or accessories, contact your local **Xerox** dealer or the retailer where you purchased your machine, or visit [www.xerox.com/office/support](http://www.xerox.com/office/support) and select your country/region for information on calling for technical support.



# 12 Specifications

This chapter includes:

- **General specifications**
- **Printer specifications**
- **Scanner and copier specifications**

## General specifications

Item	Description
Paper input capacity	<ul style="list-style-type: none"> <li>• Tray 150 multi-pages for plain paper 75 g/m<sup>2</sup> (20 lb bond)</li> <li>• Manual feeder 1 page for plain paper 75 g/m<sup>2</sup> (20 lb bond)</li> </ul> For details about paper input capacity, see 4.5 page
Paper output capacity	Face down: 100 sheets 75 g/m <sup>2</sup> (20 lb bond)
Power rating	AC 110 - 127 V or AC 220 - 240 V See the Rating label on the machine for the correct voltage, frequency (hertz) and type of current for your machine.
Power consumption	Average: 350 W Power save mode: Less than 30 W
Noise level <sup>a</sup>	Standby mode: Less than 35 dBA Printing: Less than 49 dBA Copying mode: Less than 52 dBA
Warm-up time	Less than 35 seconds (from sleep mode)
Operating environment	Temperature: 10° C to 32.5° C (59° F to 90.5° F) Humidity: 30% to 80% RH
Display	16 characters x 2 lines
Toner cartridge life <sup>b</sup>	Black Approx. 2,000 pages at 5% Coverage (Shipped with 1,500 pages Starter toner cartridge)
	Color Approx. 1,000 pages at 5% coverage (Shipped with 700 pages Starter toner cartridge)
Memory	128 MB (Non extendable)
External dimension (W x D x H)	413 x 353 x 344 mm (16.3 x 13.9 x 13.5 inches)
Weight	21.93 Kg (48.35 lbs) (including consumables)

Item	Description
Package weight	Paper: 2.68 Kg (5.91 lbs), Plastic: 0.52 Kg (1.15 lbs)
Duty cycle	Monthly print: Up to 24,200 images <sup>c</sup>
Fusing temperature	180° C (356° F)

a. Sound Pressure Level, ISO 7779

b. The number of pages may be affected by operating environment, printing interval, media type, and media size.

c. Image counts based on one color on each page. If you print documents in full color (Cyan, Magenta, Yellow, Black), the life of this item will be reduced by 25%.

## Printer specifications

Item	Description	
Printing method	Laser Beam Printing	
Printing speed <sup>a</sup>	Black & White	Up to 16 ppm in A4 (17 ppm in Letter)
	Color	Up to 4 ppm in A4 or Letter
First print out time	Black & White	From ready: Less than 14 seconds From coldboot: Less than 45 seconds
	Color	From ready: Less than 26 seconds From coldboot: Less than 57 seconds
Print resolution	Up to 2,400 x 600 dpi effective output	
Printer language	GDI	
OS Compatibility <sup>b</sup>	Windows2000/XP/2003/Vista Various Linux OS (USB only) Macintosh 10.3 ~ 10.4	
Interface	High Speed USB 2.0	

a. Print speed will be affected by operating system used, computing performance, application software, connecting method, media type, media size, and job complexity.

b. Please visit [www.xerox.com](http://www.xerox.com) to download the latest software version.



## Scanner and copier specifications

Item	Description	
Compatibility	TWAIN standard / WIA standard	
Scanning method	Color CIS	
Resolution	Optical: Up to 600 x 1200 dpi (mono and color) Enhanced: 4,800 x 4,800 dpi	
Effective scanning length	Max. 289 mm (11.4 inches)	
Effective scanning width	Max. 208 mm (8.2 inches)	
Color bit depth	24 bits	
Mono bit depth	1 bit for Black & White mode 8 bits for Gray mode	
Copy speed <sup>a</sup>	Black & white	Up to 16 cpm in A4 (17 cpm in Letter)
	Color	Up to 4 cpm in A4 or Letter
Copy resolution	<ul style="list-style-type: none"> <li>• Text: Up to 600 x 300 dpi</li> <li>• Text/photo: Up to 600 x 300 dpi</li> <li>• Photo: Up to 600 x 600 dpi for platen</li> </ul>	
Zoom rate	50 to 200% for platen	
Multiple copies	1 to 99 pages	
Grayscale	256 levels	

a. Copy Speed is based on Single Document Multiple Copy.

# INDEX

## Numerics

2/4-up, special copy 5.4

## B

Back 1.3  
background image, erase 5.5  
Black Start 1.3

## C

cleaning  
    inside 9.2  
    outside 9.2  
    scan unit 9.3  
clone, special copy 5.5  
contrast, copy 5.2  
copying  
    2/4-up 5.4  
    darkness 5.2  
    default setting, change 5.2  
    erasing background 5.5  
    ID card copy 5.3  
    original type 5.2  
    poster 5.4  
    reduce/enlarge 5.1  
    time out, set 5.3

## D

demo page, print 1.5  
Display 1.3  
display language, change 2.2

## E

Erasing background, special copy 5.5  
error messages 10.3

## I

ID card, special copy 5.3

## J

jam, clear  
    paper 10.1

## L

Linux problems 10.11  
loading paper  
    manual feeder 4.7  
    tray 1 4.5

## M

Macintosh problems 10.11  
manual feeder 4.7  
memory, clear 9.1  
Menu 1.3

## N

Network Scan program  
    problems 10.11  
n-up (multiple pages per sheet)  
    copying 5.4

## O

Original Type 1.3

## P

paper guidelines 4.3  
paper jam, clear  
    manual feeder 10.2  
    paper exit area 10.2  
    tray 1 10.1  
paper load  
    manual feeder 4.7  
    tray 1/optional tray 2 4.5  
paper size  
    setting 4.8  
    specifications 4.2

paper tray, set  
    copy 5.1  
paper type  
    setting 4.8  
    specifications 4.2  
poster, special copy 5.4  
print quality problems, solve 10.7  
printing  
    demo page 1.5  
    reports 9.1  
    USB memory 8.3  
problem, solve  
    copying 10.10  
    error messages 10.3  
    Linux 10.11  
    Macintosh 10.11  
    paper feeding 10.5  
    printing 10.6  
    printing quality 10.7  
    scanning 10.10  
    Windows 10.11

## R

replacement parts 9.9  
replacing  
    imaging unit 9.6  
    toner cartridge 9.5  
    waste toner container 9.8  
reports, print 9.1

## S

scan power save mode 2.2  
Scan To 1.3  
scanner glass  
    cleaning 9.3  
scanning  
    default setting, change 7.2  
    scan settings 7.2  
    to application 7.1  
    USB flash memory 8.2  
special copy features 5.3  
special print media, guidelines 4.3

- specifications
  - general 12.1
  - printer 12.1
  - scanner and copier 12.2
- Status 1.3
- Stop/Clear 1.3
- supplies
  - checking life 9.9
  - order information 11.1
- system requirements
  - Macintosh 3.2

## T

- toner cartridge
  - maintaining 9.4
  - redistributing 9.4
  - replacing 9.5
- toner cartridge messages
  - Status LED 1.4
- Toner colors 1.3

## U

- USB flash memory
  - managing 8.3
  - printing 8.3
  - scanning 8.2
- USB Print 1.3

## W

- waste toner container
  - replace 9.8
- Windows problems 10.11

# Software section

# SOFTWARE SECTION

# CONTENTS

## **Chapter 1: INSTALLING PRINTER SOFTWARE IN WINDOWS**

Installing Printer Software .....	4
Installing Software for Local Printing .....	4
Removing Printer Software .....	6

## **Chapter 2: BASIC PRINTING**

Printing a Document .....	7
Printing to a file (PRN) .....	7
Printer Settings .....	8
Layout Tab .....	8
Paper Tab .....	9
Graphics Tab .....	10
Other Features Tab .....	11
About Tab .....	11
Printer Tab .....	11
Using a Favorite Setting .....	12
Using Help .....	12

## **Chapter 3: ADVANCED PRINTING**

Printing Multiple Pages on One Sheet of Paper (N-Up Printing) .....	13
Printing Posters .....	14
Printing Booklets .....	14
Printing on Both Sides of Paper .....	15
Printing a Reduced or Enlarged Document .....	15
Fitting Your Document to a Selected Paper Size .....	15
Using Watermarks .....	16
Using an Existing Watermark .....	16
Creating a Watermark .....	16

Editing a Watermark .....	16
Deleting a Watermark .....	16
Using Overlays .....	17
What is an Overlay? .....	17
Creating a New Page Overlay .....	17
Using a Page Overlay .....	17
Deleting a Page Overlay .....	17

#### **Chapter 4: SHARING THE PRINTER LOCALLY**

Setting Up a Host Computer .....	18
Setting Up a Client Computer .....	18

#### **Chapter 5: USING UTILITY APPLICATIONS**

Opening the Troubleshooting Guide .....	19
Using Printer Settings Utility .....	19
Using Onscreen Help File .....	19
Changing the Status Monitor Program Settings .....	19

#### **Chapter 6: SCANNING**

Scanning Process with TWAIN-enabled Software .....	20
Scanning Using the WIA Driver .....	20
Windows XP .....	20
Windows Vista .....	20

#### **Chapter 7: USING YOUR PRINTER IN LINUX**

Getting Started .....	21
Installing the Unified Linux Driver .....	21
Installing the Unified Linux Driver .....	21
Uninstalling the Unified Linux Driver .....	22
Using the Unified Driver Configurator .....	23

Opening the Unified Driver Configurator .....	23
Printers Configuration .....	23
Scanners Configuration .....	24
Ports Configuration .....	24
Configuring Printer Properties .....	25
Printing a Document .....	25
Printing from Applications .....	25
Printing Files .....	26
Scanning a Document .....	26
Using the Image Manager .....	27

## **Chapter 8: USING YOUR PRINTER WITH A MACINTOSH**

Installing Software for Macintosh .....	29
Setting Up the Printer .....	30
For a USB-connected Macintosh .....	30
Printing .....	31
Printing a Document .....	31
Changing Printer Settings .....	31
Printing Multiple Pages on One Sheet of Paper .....	32
Scanning .....	33

# 1 Installing Printer Software in Windows

This chapter includes:

- **Installing Printer Software**
- **Removing Printer Software**

## Installing Printer Software

You can install the printer software for local printing. To install the printer software on the computer, perform the appropriate installation procedure depending on the printer in use.

A printer driver is software that lets your computer communicate with your printer. The procedure to install drivers may differ depending on the operating system you are using.

All applications should be closed on your PC before beginning installation.

## Installing Software for Local Printing

A local printer is a printer directly attached to your computer using the printer cable supplied with your printer, such as a USB cable. You can install the printer software using the typical or custom method.

**NOTE:** If the “New Hardware Wizard” window appears during the installation procedure, click  in the upper right corner of the box to close the window, or click **Cancel**.

## Typical Installation

This is recommended for most users. All components necessary for printer operations will be installed.

- 1 Make sure that the printer is connected to your computer and powered on.
- 2 Insert the supplied CD-ROM into your CD-ROM drive. The CD-ROM should automatically run, and an installation window appears. If the installation window does not appear, click **Start** and then **Run**. Type **X:\Setup.exe**, replacing “X” with the letter which represents your drive and click **OK**. If you use Windows Vista, click **Start** → **All programs** → **Accessories** → **Run**, and type **RunX:\Setup.exe**. If the **AutoPlay** window appears in Windows Vista, Click **Run Setup.exe** in **Install or run program** field, and click **Continue** in the **User Account Control** window.
- 3 Click **Install Software**.

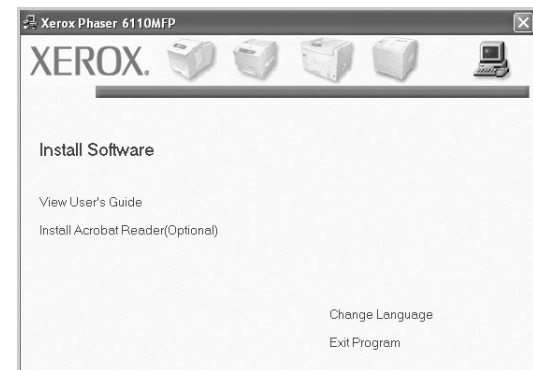

- 4 Select **Typical**. Click **Next**.





**NOTE:** If your printer is not already connected to the computer, the following window will appear.

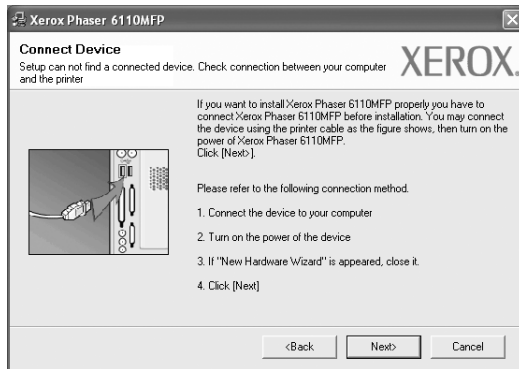

- After connecting the printer, click **Next**.
- If you don't want to connect the printer at this time, click **Next**, and **No** on the following screen. Then the installation will start and a test page will not be printed at the end of the installation.
- *The installation window that appears in this User's Guide may differ depending on the printer and interface in use.*

- 5 After the installation is finished, a window asking you to print a test page appears. If you choose to print a test page, select the checkbox and click **Next**. Otherwise, just click **Next** and skip to step 7.
- 6 If the test page prints out correctly, click **Yes**. If not, click **No** to reprint it.
- 7 Click **Finish**.

## Custom Installation

You can choose individual components to install.

- 1 Make sure that the printer is connected to your computer and powered on.
- 2 Insert the supplied CD-ROM into your CD-ROM drive. The CD-ROM should automatically run, and an installation window appears. If the installation window does not appear, click **Start** and then **Run**. Type **X:\Setup.exe**, replacing "X" with the letter which represents your drive and click **OK**.

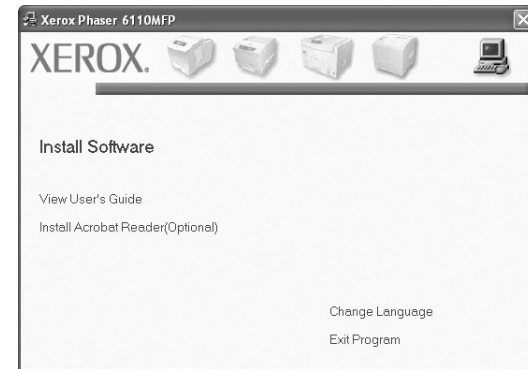

- 3 Click **Install Software**.
- 4 Select **Custom**. Click **Next**.



**NOTE:** If your printer is not already connected to the computer, the following window will appear.

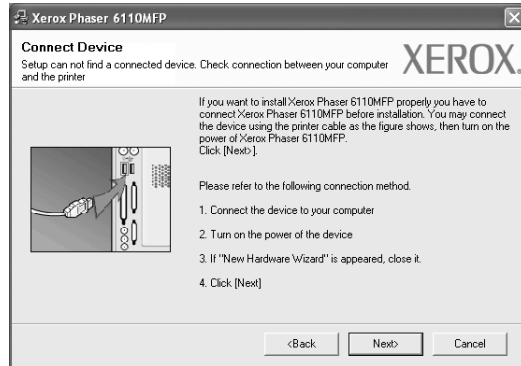

- After connecting the printer, click **Next**.
- If you don't want to connect the printer at this time, click **Next**, and **No** on the following screen. Then the installation will start and a test page will not be printed at the end of the installation.
- *The installation window that appears in this User's Guide may differ depending on the printer and interface in use.*

- 5 Select the components to be installed and click **Next**.

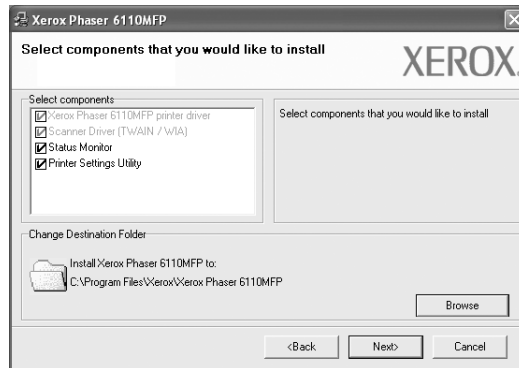

**NOTE:** You can change the desired installation folder by clicking [**Browse**].

- 6 After the installation is finished, a window asking you to print a test page appears. If you choose to print a test page, select the checkbox and click **Next**.  
Otherwise, just click **Next** and skip to step 9.
- 7 If the test page prints out correctly, click **Yes**.  
If not, click **No** to reprint it.
- 8 Click **Finish**.

## Removing Printer Software

- 1 Start Windows.
- 2 From the **Start** menu select **Programs** or **All Programs** → **your printer driver name** → **Maintenance**.
- 3 Select **Remove** and click **Next**.  
You will see a component list so that you can remove any item individually.
- 4 Select the components you want to remove and then click **Next**.
- 5 When your computer asks you to confirm your selection, click **Yes**.  
The selected driver and all of its components are removed from your computer.
- 6 After the software is removed, click **Finish**.

## 2 Basic Printing

This chapter explains the printing options and common printing tasks in Windows.

This chapter includes:

- **Printing a Document**
- **Printing to a file (PRN)**
- **Printer Settings**
  - **Layout Tab**
  - **Paper Tab**
  - **Graphics Tab**
  - **Other Features Tab**
  - **About Tab**
  - **Printer Tab**
  - **Using a Favorite Setting**
  - **Using Help**

---

### Printing a Document

#### NOTES:

- Your printer driver **Properties** window that appears in this User's Guide may differ depending on the printer in use. However the composition of the printer properties window is similar.
- **Check the Operating System(s) that are compatible with your printer. Please refer to the OS Compatibility section of Printer Specifications in your Printer User's Guide.**
- If you need to know the exact name of your printer, you can check the supplied CD-ROM.

The following procedure describes the general steps required for printing from various Windows applications. The exact steps for printing a document may vary depending on the application program you are using. Refer to the User's Guide of your software application for the exact printing procedure.

- 1 Open the document you want to print.
- 2 Select **Print** from the **File** menu. The Print window is displayed. It may look slightly different depending on your application.

The basic print settings are selected within the Print window. These settings include the number of copies and print range.

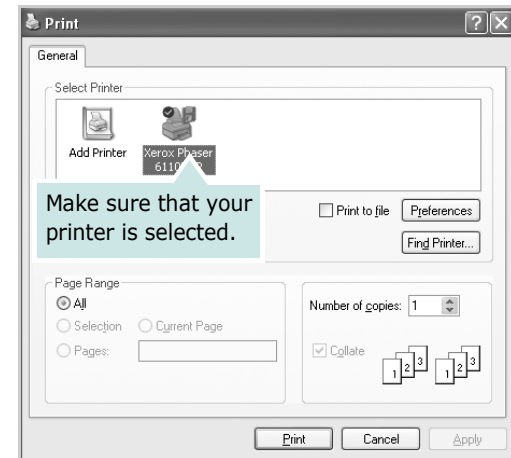

- 3 Select **your printer driver** from the **Name** drop-down list.

To take advantage of the printer features provided by your printer driver, click **Properties** or **Preferences** in the application's Print window. For details, see "Printer Settings" on page 8.

If you see **Setup**, **Printer**, or **Options** in your Print window, click it instead. Then click **Properties** on the next screen.

Click **OK** to close the printer properties window.

- 4 To start the print job, click **OK** or **Print** in the Print window.

---

### Printing to a file (PRN)

You will sometimes need to save the print data as a file.

To create a file:

- 1 Check the **Print to file** box at the **Print** window.
- 2 Select the folder and assign a name of the file and then click **OK**.

## Printer Settings

You can use the printer properties window, which allows you to access all of the printer options you need when using your printer. When the printer properties are displayed, you can review and change the settings needed for your print job.

Your printer properties window may differ, depending on your operating system. This Software User's Guide shows the Properties window for Windows XP.

Your printer driver **Properties** window that appears in this User's Guide may differ depending on the printer in use.

If you access printer properties through the Printers folder, you can view additional Windows-based tabs (refer to your Windows User's Guide) and the Printer tab (see "Printer Tab" on page 11).

### NOTES:

- Most Windows applications will override settings you specify in the printer driver. Change all print settings available in the software application first, and change any remaining settings using the printer driver.
- The settings you change remain in effect only while you are using the current program. **To make your changes permanent**, make them in the Printers folder.
- The following procedure is for Windows XP. For other Windows OS, refer to the corresponding Windows User's Guide or online help.
  1. Click the Windows **Start** button.
  2. Select **Printers and Faxes**.
  3. Select **your printer driver icon**.
  4. Right-click on the printer driver icon and select **Printing Preferences**.
  5. Change the settings on each tab, click OK.

## Layout Tab

The **Layout** tab provides options to adjust how the document appears on the printed page. The **Layout Options** includes **Multiple Pages per Side, Poster Printing** and **Booklet Printing**. See "Printing a Document" on page 7 for more information on accessing printer properties.

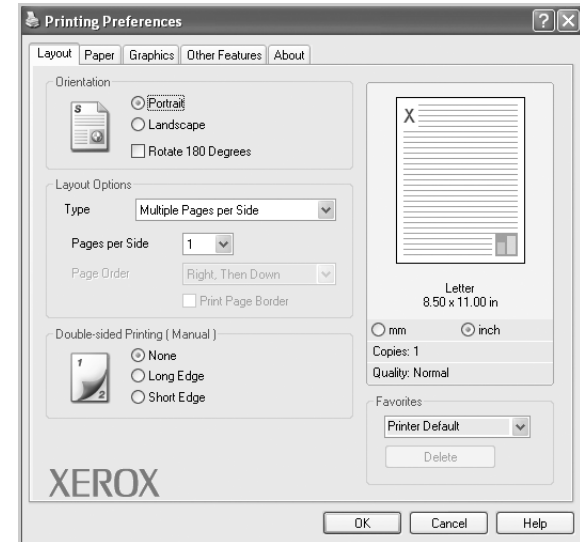

### Orientation

**Orientation** allows you to select the direction in which information is printed on a page.

- **Portrait** prints across the width of the page, letter style.
- **Landscape** prints across the length of the page, spreadsheet style.
- **Rotate 180 Degrees** allows you to rotate the page, 180 degrees.



▲ Portrait



▲ Landscape

### Layout Options

**Layout Options** allows you to select advanced printing options. You can choose **Multiple Pages per Side, Poster Printing** and **Booklet Printing**.

- For details, see "Printing Multiple Pages on One Sheet of Paper (N-Up Printing)" on page 13.
- For details, see "Printing Posters" on page 14.
- For details, see "Printing Booklets" on page 14.

### Double-sided Printing

**Double-sided Printing** allows you to print on both sides of paper. **If this option does not appear, your printer does not have this feature.**

- For details, see "Printing on Both Sides of Paper" on page 15.

## Paper Tab

Use the following options to set the basic paper handling specifications when you access the printer properties. See "Printing a Document" on page 7 for more information on accessing printer properties.

Click the **Paper** tab to access various paper properties.

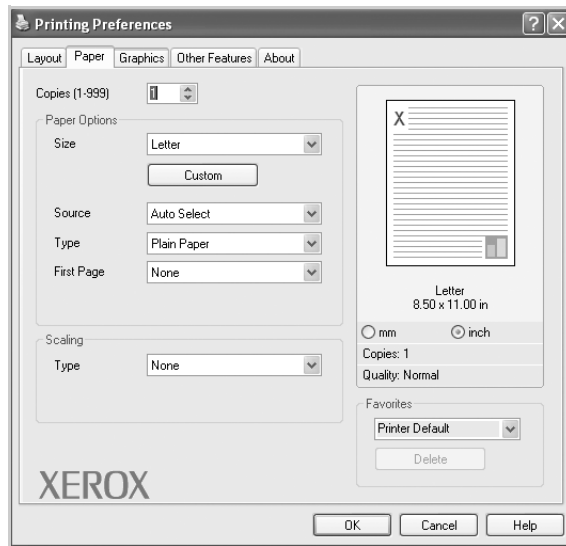

### Copies

**Copies** allows you to choose the number of copies to be printed. You can select 1 to 999 copies.

### Size

**Size** allows you to set the size of paper you loaded in the tray. If the required size is not listed in the **Size** box, click **Custom**. When the **Custom Paper Setting** window appears, set the paper size and click **OK**. The setting appears in the list so that you can select it.

## Source

Make sure that **Source** is set to the corresponding paper tray. Use **Manual Feeder** when printing on special materials like envelopes and transparencies. You have to load one sheet at a time into the Manual Tray or Multi-Purpose Tray. If the paper source is set to **Auto Selection**, the printer automatically picks up print material in the following tray order: Manual Tray or Multi-Purpose Tray, Tray n.

## Type

Set **Type** to correspond to the paper loaded in the tray from which you want to print. This will let you get the best quality printout. If not, print quality may not be achieved as you want.

**Thin:** Less than 19 lb (70 g/m<sup>2</sup>) thin paper.

**Thick:** 24 lb to 32 lb (90~120 g/m<sup>2</sup>) thick paper.

**Cotton:** 20 lb to 24 lb (75~90 g/m<sup>2</sup>) cotton paper such as Gilbert 25 % and Gilbert 100 %.

**Plain Paper:** Normal plain paper. Select this type if your printer is monochrome and printing on the 16 lb (60 g/m<sup>2</sup>) cotton paper.

**Recycled Paper:** 20 lb to 24 lb (75~90 g/m<sup>2</sup>) recycled paper.

**Color Paper:** 20 lb to 24 lb (75~90 g/m<sup>2</sup>) color-backgrounded paper.

## Scaling Printing

**Scaling Printing** allows you to automatically or manually scale your print job on a page. You can choose from **None**, **Reduce/Enlarge**, and **Fit to Page**.

- For details, see "Printing a Reduced or Enlarged Document" on page 15.
- For details, see "Fitting Your Document to a Selected Paper Size" on page 15.

## Graphics Tab

Use the following Graphic options to adjust the print quality for your specific printing needs. See “Printing a Document” on page 7 for more information on accessing printer properties.

Click the **Graphic** tab to display the properties shown below..



### Quality

*The Resolution options you can select may vary depending on your printer model.* The higher the setting, the sharper the clarity of printed characters and graphics. The higher setting also may increase the time it takes to print a document.

### Color Mode

You can choose color options. Setting to **Colour** typically produces the best possible print quality for color documents. If you want to print a color document in grayscale, select **Black&White**. If you want to adjust the color options manually, select **Manual** and click the **Colour Adjust** or **Colour Matching** button.

- **Colour Adjust** : You can adjust the appearance of images by changing the settings in the **Levels** option.
- **Colour Matching** : You can adjust the appearance of images by changing the settings in the **Settings** option.

### Advanced Options

You can set advanced settings by clicking the **Advanced Options** button.

- **Print All Text To Black**: When the **Print All Text To Black** option is checked, all text in your document prints solid black, regardless of the color it appears on the screen.
- **Darken Text**: When the **Darken Text** option is checked, all text in your document is allowed to print darker than on a normal document.

## Other Features Tab

You can select output options for your document. See “Printing a Document” on page 7 for more information about accessing the printer properties.

Click the **Other Features** tab to access the following feature:

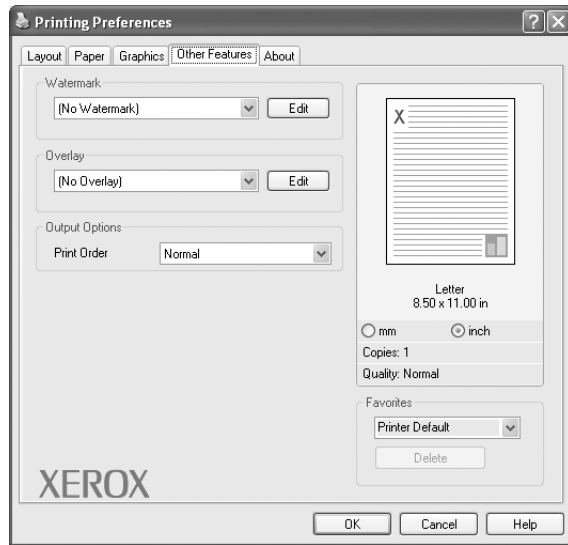

### Watermark

You can create a background text image to be printed on each page of your document. For details, see “Using Watermarks” on page 16.

### Overlay

Overlays are often used to take the place of preprinted forms and letterhead paper. For details, see “Using Overlays” on page 17.

### Output Options

- **Print Subset:** You can set the sequence in which the pages print. Select the print order from the drop-down list.
  - **Normal:** Your printer prints all pages from the first page to the last page.
  - **Reverse All Pages :** Your printer prints all pages from the last page to the first page.
  - **Print Odd Pages:** Your printer prints only the odd numbered pages of the document.
  - **Print Even Pages:** Your printer prints only the even numbered pages of the document.

## About Tab

Use the **About** tab to display the copyright notice and the version number of the driver. If you have an Internet browser, you can connect to the Internet by clicking on the web site icon. See “Printing a Document” on page 7 for more information about accessing printer properties.

## Printer Tab

If you access printer properties through the **Printers** folder, you can view the **Printer** tab. You can set the printer configuration.

The following procedure is for Windows XP. For other Windows OS, refer to the corresponding Windows User's Guide or online help.

- 1 Click the Windows **Start** menu.
- 2 Select **Printers and Faxes**.
- 3 Select **your printer driver** icon.
- 4 Right-click on the printer driver icon and select **Properties**.
- 5 Click the **Printer** tab and set the options.

## Using a Favorite Setting

The **Favorites** option, which is visible on each properties tab, allows you to save the current properties settings for future use.

To save a **Favorites** item:

- 1 Change the settings as needed on each tab.
- 2 Enter a name for the item in the **Favorites** input box.

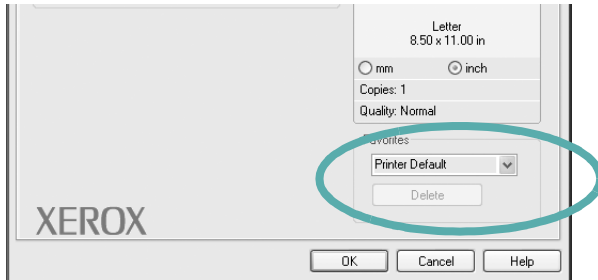

- 3 Click **Save**.

When you save **Favorites**, all current driver settings are saved.

To use a saved setting, select the item from the **Favorites** drop down list. The printer is now set to print according to the Favorites setting you selected.

To delete a Favorites item, select it from the list and click **Delete**.

You can also restore the printer driver's default settings by selecting **Printer Default** from the list.

## Using Help

Your printer has a help screen that can be activated by clicking the **Help** button in the printer properties window. These help screens give detailed information about the printer features provided by the printer driver.

You can also click **?** from the upper right corner of the window, and then click on any setting.



# 3 Advanced Printing

This chapter explains printing options and advanced printing tasks.

---

**NOTE:**

- Your printer driver **Properties** window that appears in this User's Guide may differ depending on the printer in use. However the composition of the printer properties window is similar.
  - If you need to know the exact name of your printer, you can check the supplied CD-ROM.
- 

This chapter includes:

- **Printing Multiple Pages on One Sheet of Paper (N-Up Printing)**
- **Printing Posters**
- **Printing Booklets**
- **Printing on Both Sides of Paper**
- **Printing a Reduced or Enlarged Document**
- **Fitting Your Document to a Selected Paper Size**
- **Using Watermarks**
- **Using Overlays**

---

## Printing Multiple Pages on One Sheet of Paper (N-Up Printing)



You can select the number of pages to print on a single sheet of paper. To print more than one page per sheet, the pages will be reduced in size and arranged in the order you specify. You can print up to 16 pages on one sheet.

- 1** To change the print settings from your software application, access printer properties. See "Printing a Document" on page 7.
- 2** From the **Layout** tab, choose **Multiple Pages per Side** in the **Layout Type** drop-down list.
- 3** Select the number of pages you want to print per sheet (1, 2, 4, 6, 9, or 16) in the **Pages per Side** drop-down list.
- 4** Select the page order from the **Page Order** drop-down list, if necessary.  
Check **Print Page Border** to print a border around each page on the sheet.
- 5** Click the **Paper** tab, select the paper source, size, and type.
- 6** Click **OK** and print the document.

## Printing Posters

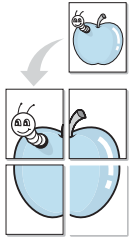

This feature allows you to print a single-page document onto 4, 9, or 16 sheets of paper, for the purpose of pasting the sheets together to form one poster-size document.

- 1 To change the print settings from your software application, access printer properties. See “Printing a Document” on page 7.
- 2 Click the **Layout** tab, select **Poster Printing** in the **Layout Type** drop-down list.
- 3 Configure the poster option:

You can select the page layout from **Poster<2x2>**, **Poster<3x3>**, or **Poster<4x4>**. If you select **Poster<2x2>**, the output will be automatically stretched to cover 4 physical pages.

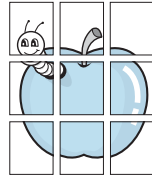
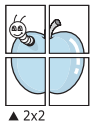

Specify an overlap in millimeters or inches to make it easier to pasting the sheets together.

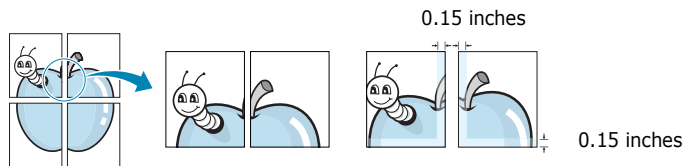

- 4 Click the **Paper** tab, select the paper source, size, and type.
- 5 Click **OK** and print the document. You can complete the poster by pasting the sheets together.

## Printing Booklets



This printer feature allows you to print your document on both sides of the paper and arranges the pages so that the paper can be folded in half after printing to produce a booklet.

- 1 To change the print settings from your software application, access the printer properties. See “Printing a Document” on page 7.
- 2 From the **Layout** tab, choose **Booklet Printing** from the **Type** drop-down list.

**NOTE:** The **Booklet Printing** option is not available for all the paper size. In order to find out the available paper size for this feature, select the paper size in the **Size** option on the **Paper** tab, then check if the **Booklet Printing** in a **Layout Type** drop-down list on the **Layout** tab is activated.

- 3 Click the **Paper** tab, and select the paper source, size, and type.
- 4 Click **OK** and print the document.
- 5 After printing, fold and staple the pages.

## Printing on Both Sides of Paper

You can print on both sides of a sheet of paper. Before printing, decide how you want your document oriented.

The options are:

- **None**
- **Long Edge**, which is the conventional layout used in book binding.
- **Short Edge**, which is the type often used with calendars.

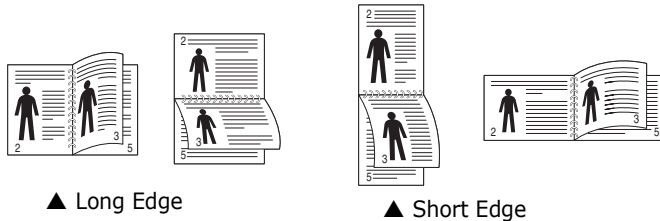

### NOTE:

- Do not print on both sides of labels, transparencies, envelopes, or thick paper. Paper jamming and damage to the printer may result.
- To use double-sided printing, you can use only the following paper sizes: A4, Letter, Legal, and Folio, with a weight of 20~24 lbs (75~90 g/m<sup>2</sup>).

- 1 To change the print settings from your software application, access printer properties. "Printing a Document" on page 7.
- 2 From the **Layout** tab, select the paper orientation.
- 3 From the **Double-sided Printing** section, select the binding option you want.
- 4 Click the **Paper** tab and select the paper source, size, and type.
- 5 Click **OK** and print the document.

**NOTE:** If your printer does not have a duplex unit, you should complete the printing job manually. The printer prints every other page of the document first. After printing the first side of your job, the Printing Tip window appears. Follow the on-screen instructions to complete the printing job.

## Printing a Reduced or Enlarged Document

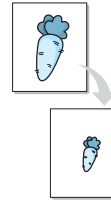

You can change the size of a page's content to appear larger or smaller on the printed page.

- 1 To change the print settings from your software application, access printer properties. See "Printing a Document" on page 7.
- 2 From the **Paper** tab, select **Reduce/Enlarge** in the **Printing Type** drop-down list.
- 3 Enter the scaling rate in the **Percentage** input box. You can also click the ▼ or ▲ button.
- 4 Select the paper source, size, and type in **Paper Options**.
- 5 Click **OK** and print the document.

## Fitting Your Document to a Selected Paper Size

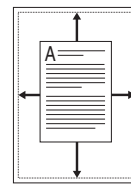

This printer feature allows you to scale your print job to any selected paper size regardless of the digital document size. This can be useful when you want to check fine details on a small document.

- 1 To change the print settings from your software application, access printer properties. See "Printing a Document" on page 7.
- 2 From the **Paper** tab, select **Fit to Page** in the **Printing Type** drop-down list.
- 3 Select the correct size from the **Output size** drop-down list.
- 4 Select the paper source, size, and type in **Paper Options**.
- 5 Click **OK** and print the document.

---

## Using Watermarks

The Watermark option allows you to print text over an existing document. For example, you may want to have large gray letters reading "DRAFT" or "CONFIDENTIAL" printed diagonally across the first page or all pages of a document.

There are several predefined watermarks that come with the printer, and they can be modified, or you can add new ones to the list.

### Using an Existing Watermark

- 1 To change the print settings from your software application, access printer properties. See "Printing a Document" on page 7.
- 2 Click the **Extras** tab, and select the desired watermark from the **Watermark** drop-down list. You will see the selected watermark in the preview image.
- 3 Click **OK** and start printing.

---

**NOTE:** The preview image shows how the page will look when it is printed.

---

### Creating a Watermark

- 1 To change the print settings from your software application, access printer properties. See "Printing a Document" on page 7.
- 2 Click the **Extras** tab, and click the **Edit** button in the **Watermark** section. The **Edit Watermarks** window appears.
- 3 Enter a text message in the **Watermark Message** box. You can enter up to 40 characters. The message displays in the preview window.  
When the **First Page Only** box is checked, the watermark prints on the first page only.
- 4 Select watermark options.  
You can select the font name, style, size, or grayscale level from the **Font Attributes** section and set the angle of the watermark from the **Message Angle** section.
- 5 Click **Add** to add a new watermark to the list.
- 6 When you have finished editing, click **OK** and start printing.

To stop printing the watermark, select **(No Watermark)** from the **Watermark** drop-down list.

## Editing a Watermark

- 1 To change the print settings from your software application, access printer properties. See "Printing a Document" on page 7.
- 2 Click the **Extras** tab and click the **Edit** button in the **Watermark** section. The **Edit Watermarks** window appears.
- 3 Select the watermark you want to edit from the **Current Watermarks** list and change the watermark message and options.
- 4 Click **Update** to save the changes.
- 5 Click **OK** until you exit the Print window.

## Deleting a Watermark

- 1 To change the print settings from your software application, access printer properties. See "Printing a Document" on page 7.
- 2 From the **Extras** tab, click the **Edit** button in the Watermark section. The **Edit Watermarks** window appears.
- 3 Select the watermark you want to delete from the **Current Watermarks** list and click **Delete**.
- 4 Click **OK** until you exit the Print window.

---

## Using Overlays

### What is an Overlay?



An overlay is text and/or images stored in the computer hard disk drive (HDD) as a special file format that can be printed on any document. Overlays are often used to take the place of preprinted forms and letterhead paper. Rather than using preprinted letterhead, you can create an overlay containing the exact same information that is currently on your letterhead. To print a letter with your company's letterhead, you do not need to load preprinted letterhead paper in the printer. You need only tell the printer to print the letterhead overlay on your document.

### Creating a New Page Overlay

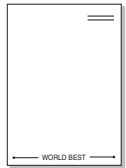

To use a page overlay, you must create a new page overlay containing your logo or image.

- 1 Create or open a document containing text or an image for use in a new page overlay. Position the items exactly as you wish them to appear when printed as an overlay.
- 2 To save the document as an overlay, access printer properties. See "Printing a Document" on page 7.
- 3 Click the **Extras** tab, and click **Edit** button in the **Overlay** section.
- 4 In the Edit Overlay window, click **Create Overlay**.
- 5 In the Create Overlay window, type a name of up to eight characters in the **File name** box. Select the destination path, if necessary. (The default is C:\Formover).
- 6 Click **Save**. The name appears on the **Overlay List** box.
- 7 Click **OK** or **Yes** to finish creating.  
The file is not printed. Instead it is stored on your computer hard disk drive.

---

**NOTE:** The overlay document size must be the same as the documents you print with the overlay. Do not create an overlay with a watermark.

---

## Using a Page Overlay

After an overlay has been created, it is ready to be printed with your document. To print an overlay with a document:

- 1 Create or open the document you want to print.
- 2 To change the print settings from your software application, access printer properties. See "Printing a Document" on page 7.
- 3 Click the **Extras** tab.
- 4 Select the desired overlay from the **Overlay** drop-down list box.
- 5 If the overlay file you want does not appear in the **Overlay** list, click **Edit** button and **Load Overlay**, and select the overlay file.

If you have stored the overlay file you want to use in an external source, you can also load the file when you access the **Load Overlay** window.

After you select the file, click **Open**. The file appears in the **Overlay List** box and is available for printing. Select the overlay from the **Overlay List** box.

- 6 If necessary, click **Confirm Page Overlay When Printing**. If this box is checked, a message window appears each time you submit a document for printing, asking you to confirm your wish to print an overlay on your document.  
If this box is not checked and an overlay has been selected, the overlay automatically prints with your document.
- 7 Click **OK** or **Yes** until printing begins.  
The selected overlay downloads with your print job and prints on your document.

---

**NOTE:** The resolution of the overlay document must be the same as that of the document you will print with the overlay.

---

## Deleting a Page Overlay

You can delete page overlays that you no longer use.

- 1 In the printer properties window, click the **Extras** tab.
- 2 Click the **Edit** button in the **Overlay** section.
- 3 Select the overlay you want to delete from the **Overlay List** box.
- 4 Click **Delete Overlay**.
- 5 When a confirming message window appears, click **Yes**.
- 6 Click **OK** until you exit the Print window.

# 4 Sharing the Printer Locally

You can connect the printer directly to a selected computer, which is called “host computer,” on the network.

The following procedure is for Windows XP. For other Windows OS, refer to the corresponding Windows User's Guide or online help.

---

## NOTES:

- Check the Operating System(s) that are compatible with your printer. Please refer to the OS Compatibility section of Printer Specifications in your Printer User's Guide.
  - If you need to know the exact name of your printer, you can check the supplied CD-ROM.
- 

---

## Setting Up a Host Computer

- 1** Start Windows.
- 2** From the **Start** menu select **Printers and Faxes**.
- 3** Double-click **your printer driver icon**.
- 4** From the **Printer** menu, select **Sharing**.
- 5** Check the **Share this printer** box.
- 6** Fill in the **Shared Name** field, and then click **OK**.

---

## Setting Up a Client Computer

- 1** Right-click the Windows **Start** button and select **Explorer**.
- 2** Open your network folder in the left column.
- 3** Click the shared name.
- 4** From the **Start** menu select **Printers and Faxes**.
- 5** Double-click **your printer driver icon**.
- 6** From the **Printer** menu, select **Properties**.
- 7** From the **Ports** tab, click **Add Port**.
- 8** Select **Local Port** and click **New Port**.
- 9** Fill in the **Enter a port name** field with the shared name.
- 10** Click **OK** and click **Close**.
- 11** Click **Apply** and click **OK**.

# 5 Using Utility Applications

If an error occurs while printing, the Status Monitor window appears, showing the error.

## NOTES:

- To use this program, you need:
  - Windows 2000 or higher. To check for Operating System(s) that are compatible with your printer, refer to Printer Specifications in your Printer User's Guide.
  - Internet Explorer version 5.0 or higher for flash animation in HTML Help.
- If you need to know the exact name of your printer, you can check the supplied CD-ROM.

## Opening the Troubleshooting Guide

Double click the Status Monitor icon on the Windows task bar.

Double click this icon.



Or, from the **Start** menu, select **Programs** or **All Programs** → **Xerox Phaser 6110MFP** → **Troubleshooting Guide**.

## Using Printer Settings Utility

Using the Printer Settings Utility, you can configure and check print settings.

- 1 from the **Start** menu, select **Programs** or **All Programs** → **Xerox Phaser 6110MFP** → **Printer Settings Utility**.
- 2 Change the settings.
- 3 To send the changes to the printer, click the **Apply** button.

## Using Onscreen Help File

For more information about **Printer Settings Utility**, click  .

## Changing the Status Monitor Program Settings

Select the Status Monitor icon on the Windows task bar and right-click on the Status Monitor icon. Select **Option**.

The following window opens.

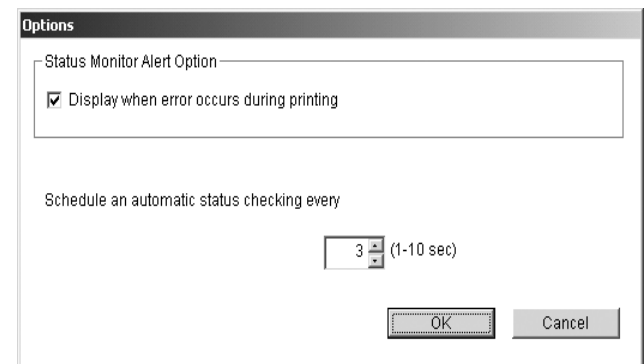

- **Display when error occurs during printing** shows the Status Monitor balloon when an error occurs during printing.
- **Schedule an automatic status checking every** allows the computer to update the printer status regularly. Setting the value close to 1 second causes the computer to check the printer status more frequently, thereby allowing a faster response to any printer error.

# 6 Scanning

Scanning with your machine lets you turn pictures and text into digital files on your computer. Then you can fax or e-mail the files, display them on your web site or use them to create projects that you can print using the WIA driver.

This chapter includes:

- **Scanning Process with TWAIN-enabled Software**
- **Scanning Using the WIA Driver**

## NOTES:

- *Check the Operating System(s) that are compatible with your printer. Please refer to the OS Compatibility section of Printer Specifications in your Printer User's Guide.*
- *You can check your printer name in the supplied CD-ROM.*
- *The maximum resolution that can be achieved depends upon various factors, including computer speed, available disk space, memory, the size of the image being scanned, and bit depth settings. Thus, depending on your system and what you are scanning, you may not be able to scan at certain resolutions, especially using enhanced dpi.*

## Scanning Process with TWAIN-enabled Software

If you want to scan documents using other software, you will need to use TWAIN-compliant software, such as Adobe PhotoDeluxe or Adobe Photoshop. The first time you scan with your machine, select it as your TWAIN source in the application you use.

The basic scanning process involves a number of steps:

- 1 Make sure that your machine and computer are turned on and properly connected to each other.
- 2 Place a single document face down on the document glass.
- 3 Open an application, such as PhotoDeluxe or Photoshop.
- 4 Open the TWAIN window and set the scan options.
- 5 Scan and save your scanned image.

**NOTE:** You need to follow the program's instructions for acquiring an image. Please refer to the user's guide of the application.

## Scanning Using the WIA Driver

Your machine also supports the Windows Image Acquisition (WIA) driver for scanning images. WIA is one of the standard components provided by Microsoft® Windows® XP/Vista and works with digital cameras and scanners. Unlike the TWAIN driver, the WIA driver allows you to scan and easily manipulate images without using additional software.

**NOTE:** The WIA driver works only on Windows XP/Vista with USB port.

## Windows XP

- 1 Place a single document face down on the document glass.
- 2 From the **Start** menu on your desktop window, select **Control Panel**, and then **Scanners and Cameras**.
- 3 Double click **your scanner driver** icon. The Scanner and Camera Wizard launches.
- 4 Choose your scanning preferences and click **Preview** to see how your preferences affect the picture.
- 5 Click **Next**.
- 6 Enter a picture name, and select a file format and destination to save the picture.
- 7 Follow the on-screen instructions to edit the picture after it is copied to your computer.

**NOTE:** If you want to cancel the scan job, press the Cancel button on the Scanner and Camera Wizard.

## Windows Vista

- 1 Place a single document face down on the document glass.
- 2 Click **Start** → **Control Panel** → **Hardware and Sound** → **Scanners and Cameras**.
- 3 Click on **Scan a document or picture**. Then **Windows Fax and Scan** application is opened automatically.

## NOTE:

- To view scanners, user can click on **View Scanners and Cameras**.
- If there is not **Scan a document or picture**, open the MS paint program and click **From Scanner or Camera...** on **File** menu.

- 4 Click **New Scan** and then scan driver is opened.
- 5 Choose your scanning preferences and click **Preview** to see your preferences affect the picture.
- 6 Click **Scan**.

**NOTE:** If you want to cancel the scan job, press the Cancel button on the Scanner and Camera Wizard.



# 7 Using Your Printer in Linux

You can use your machine in a Linux environment.

This chapter includes:

- **Getting Started**
- **Installing the Unified Linux Driver**
- **Using the Unified Driver Configurator**
- **Configuring Printer Properties**
- **Printing a Document**
- **Scanning a Document**

## Getting Started

The supplied CD-ROM provides you with Xerox's Unified Linux Driver package for using your machine with a Linux computer. Xerox's Unified Linux Driver package contains printer and scanner drivers, providing the ability to print documents and scan images. The package also delivers powerful applications for configuring your machine and further processing of the scanned documents.

After the driver is installed on your Linux system, the driver package allows you to monitor a number of machine devices via fast ECP parallel ports and USB simultaneously.

The acquired documents can then be edited, printed on the same local or network machine devices, sent by e-mail, uploaded to an FTP site, or transferred to an external OCR system.

The Unified Linux Driver package is supplied with a smart and flexible installation program. You don't need to search for additional components that might be necessary for the Unified Linux Driver software: all required packages will be carried onto your system and installed automatically; this is possible on a wide set of the most popular Linux clones.

## Installing the Unified Linux Driver

### Installing the Unified Linux Driver

- 1 Make sure that you connect your machine to your computer. Turn both the computer and the machine on.
- 2 When the Administrator Login window appears, type in *root* in the Login field and enter the system password.

**NOTE:** You must log in as a super user (*root*) to install the printer software. If you are not a super user, ask your system administrator.

- 3 Insert the printer software CD-ROM. The CD-ROM will automatically run.

If the CD-ROM does not automatically run, click the  icon at the bottom of the desktop. When the Terminal screen appears, type in:

If the CD-ROM is secondary master and the location to mount is `/mnt/cdrom`,

```
[root@localhost root]#mount -t iso9660 /dev/hdc /mnt/cdrom
```

```
[root@localhost root]#cd /mnt/cdrom/Linux
```

```
[root@localhost root]#./install.sh
```

**NOTE:** The installation program runs automatically if you have an autorun software package installed and configured.

- 4 When the welcome screen appears, click **Next**.



- 5 When the installation is complete, click **Finish**.



The installation program has added the Unified Driver Configurator desktop icon and Xerox Unified Driver group to the system menu for your convenience. If you have any difficulties, consult the onscreen help that is available through your system menu or can otherwise be called from the driver package windows applications, such as **Unified Driver Configurator** or **Image Manager**.

## Uninstalling the Unified Linux Driver

- 1 When the Administrator Login window appears, type in *root* in the Login field and enter the system password.

---

**NOTE:** You must log in as a super user (*root*) to install the printer software. If you are not a super user, ask your system administrator.

---

- 2 Insert the printer software CD-ROM. The CD-ROM will automatically run.

If the CD-ROM does not automatically run, click the  icon at the bottom of the desktop. When the Terminal screen appears, type in:

If the CD-ROM is secondary master and the location to mount is `/mnt/cdrom`,

```
[root@localhost root]# mount -t iso9660 /dev/hdc /mnt/cdrom
```

```
[root@localhost root]# cd /mnt/cdrom/Linux
```

```
[root@localhost root]# ./uninstall.sh
```

---

**NOTE:** The installation program runs automatically if you have an autorun software package installed and configured.

---

- 3 Click **Uninstall**.

- 4 Click **Next**.

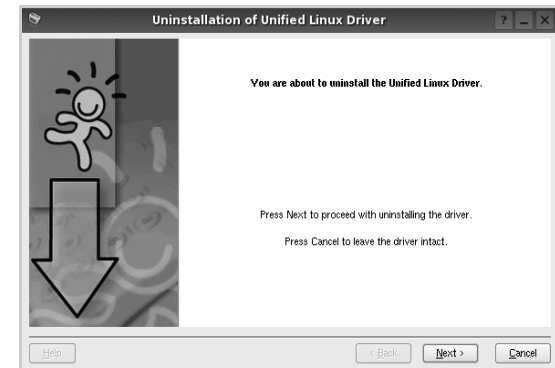

- 5 Click **Finish**.

## Using the Unified Driver Configurator

Unified Linux Driver Configurator is a tool primarily intended for configuring Printer or MFP devices. Since an MFP device combines the printer and scanner, the Unified Linux Driver Configurator provides options logically grouped for printer and scanner functions. There is also a special MFP port option responsible for the regulation of access to an MFP printer and scanner via a single I/O channel.

After installing the Unified Linux driver, the Unified Linux Driver Configurator icon will automatically be created on your desktop.

### Opening the Unified Driver Configurator

- 1 Double-click **Unified Driver Configurator** on the desktop.  
You can also click the Startup Menu icon and select **Xerox Unified Driver** and then **Xerox Unified Driver Configurator**.
- 2 Press each button on the Modules pane to switch to the corresponding configuration window.

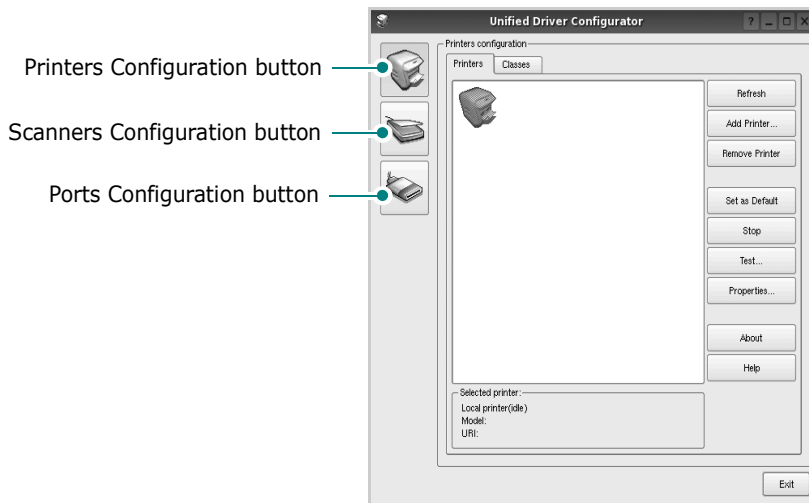

- 3 You can use the onscreen help by clicking **Help**.  
After changing the configurations, click **Exit** to close the Unified Driver Configurator.

## Printers Configuration

Printers configuration has the two tabs: **Printers** and **Classes**.

### Printers Tab

You can see the current system's printer configuration by clicking on the printer icon button on the left side of the Unified Driver Configurator window.

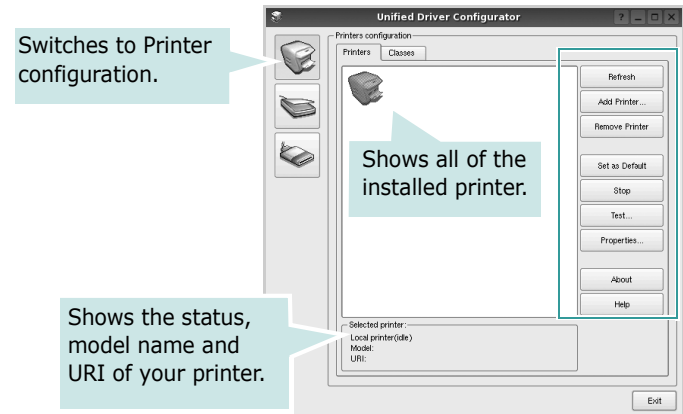

You can use the following printer control buttons:

- **Refresh:** renews the available printers list.
- **Add Printer:** allows you to add a new printer.
- **Remove Printer:** removes the selected printer.
- **Set as Default:** sets the current printer as a default printer.
- **Stop/Start:** stops/starts the printer.
- **Test:** allows you to print a test page to check if the machine is working properly.
- **Properties:** allows you to view and change the printer properties. For details, see page 25.

## Classes Tab

The Classes tab shows a list of available printer classes.

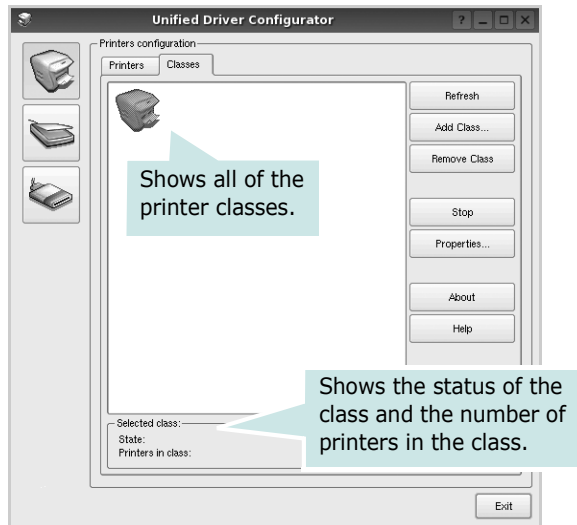

- **Refresh** : Renews the classes list.
- **Add Class...** : Allows you to add a new printer class.
- **Remove Class** : Removes the selected printer class.

## Scanners Configuration

In this window, you can monitor the activity of scanner devices, view a list of installed Xerox devices, change device properties, and scan images.

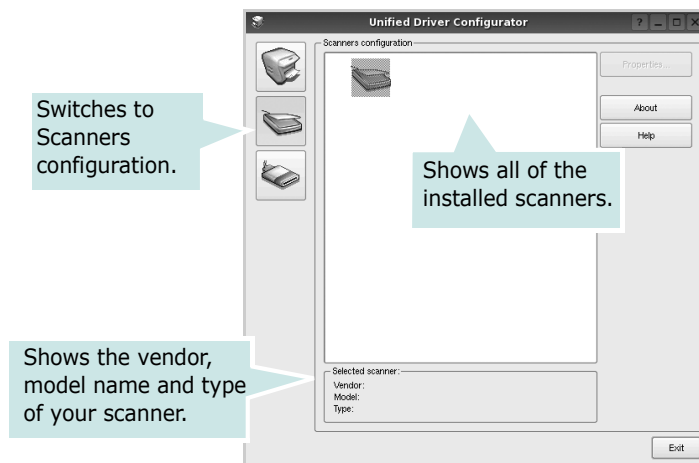

- **Properties...** : Allows you to change the scan properties and scan a document. See page 26.

## Ports Configuration

In this window, you can view the list of available ports, check the status of each port and release a port that is stalled in busy state when its owner is terminated for any reason.

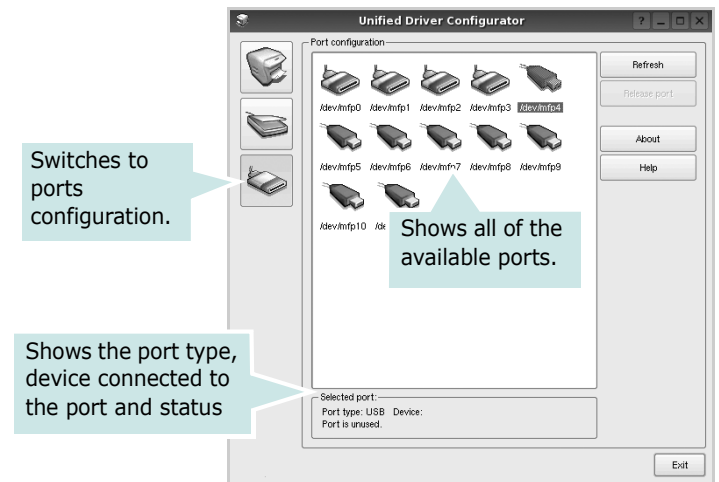

- **Refresh** : Renews the available ports list.
- **Release port** : Releases the selected port.

## Sharing Ports Between Printers and Scanners

Your machine may be connected to a host computer via the parallel port or USB port. Since the MFP device contains more than one device (printer and scanner), it is necessary to organize proper access of "consumer" applications to these devices via the single I/O port.

The Xerox Unified Linux Driver package provides an appropriate port sharing mechanism that is used by Xerox printer and scanner drivers. The drivers address their devices via so-called MFP ports. The current status of any MFP port can be viewed via the Ports Configuration. The port sharing prevents you from accessing one functional block of the MFP device, while another block is in use.

When you install a new MFP device onto your system, it is strongly recommended you do this with the assistance of an Unified Driver Configurator. In this case you will be asked to choose I/O port for the new device. This choice will provide the most suitable configuration for MFP's functionality. For MFP scanners I/O ports are being chosen by scanner drivers automatically, so proper settings are applied by default.

## Configuring Printer Properties

Using the properties window provided by the Printers configuration, you can change the various properties for your machine as a printer.

- 1 Open the Unified Driver Configurator.  
If necessary, switch to Printers configuration.
- 2 Select your machine on the available printers list and click **Properties**.
- 3 The Printer Properties window opens.

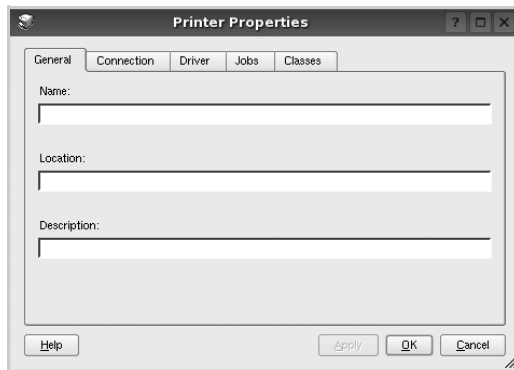

The following five tabs display at the top of the window:

- **General:** allows you to change the printer name, location and description. The name entered in this tab displays on the printer list in Printers configuration.
  - **Connection:** allows you to view or select another port. If you change the printer port from USB to parallel or vice versa while in use, you must re-configure the printer port in this tab.
  - **Driver:** allows you to view or select another printer driver. By clicking **Options**, you can set the default device options.
  - **Jobs:** shows the list of print jobs. Click **Cancel job** to cancel the selected job and select the **Show completed jobs** check box to see previous jobs on the job list.
  - **Classes:** shows the class that your printer is in. Click **Add to Class** to add your printer to a specific class or click **Remove from Class** to remove the printer from the selected class.
- 4 Click **OK** to apply the changes and close the Printer Properties Window.

## Printing a Document

### Printing from Applications

There are a lot of Linux applications that you are allowed to print from using Common UNIX Printing System (CUPS). You can print on your machine from any such application.

- 1 From the application you are using, select **Print** from the **File** menu.
- 2 Select **Print** directly using **lpr**.
- 3 In the LPR GUI window, select the model name of your machine from the Printer list and click **Properties**.

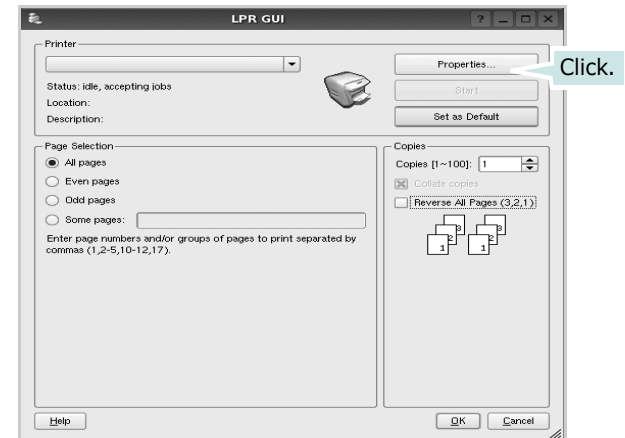

- 4 Change the printer and print job properties.

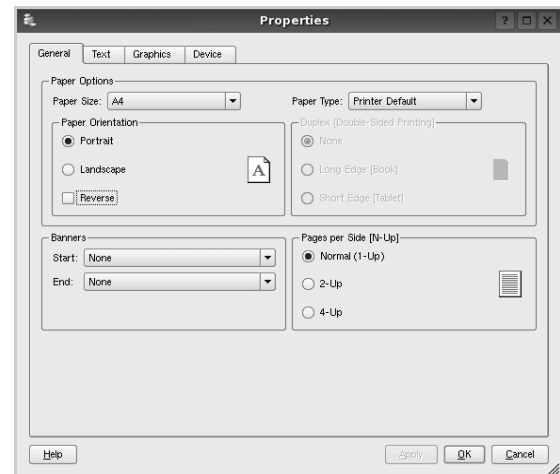

The following four tabs display at the top of the window.

- General** - allows you to change the paper size, the paper type, and the orientation of the documents, enables the duplex feature, adds start and end banners, and changes the number of pages per sheet.
- Text** - allows you to specify the page margins and set the text options, such as spacing or columns.
- Graphics** - allows you to set image options that are used when printing images/files, such as color options, image size, or image position.
- Device**: allows you to set the print resolution, paper source, and destination.

- 5 Click **Apply** to apply the changes and close the Properties window.
- 6 Click **OK** in the LPR GUI window to start printing.
- 7 The Printing window appears, allowing you to monitor the status of your print job.

To abort the current job, click **Cancel**.

## Printing Files

You can print many different types of files on the Xerox machine device using the standard CUPS way - directly from the command line interface. The CUPS `lpr` utility allows you do that. But the drivers package replaces the standard `lpr` tool by a much more user-friendly LPR GUI program.

To print any document file:

- 1 Type `lpr <file_name>` from the Linux shell command line and press **Enter**. The LPR GUI window appears.  
When you type only `lpr` and press **Enter**, the Select file(s) to print window appears first. Just select any files you want to print and click **Open**.
- 2 In the LPR GUI window, select your printer from the list, and change the printer and print job properties.  
For details about the properties window, see page 25.
- 3 Click **OK** to start printing.

## Scanning a Document

You can scan a document using the Unified Driver Configurator window.

- 1 Double-click the Unified Driver Configurator on your desktop.
- 2 Click the  button to switch to Scanners Configuration.
- 3 Select the scanner on the list.

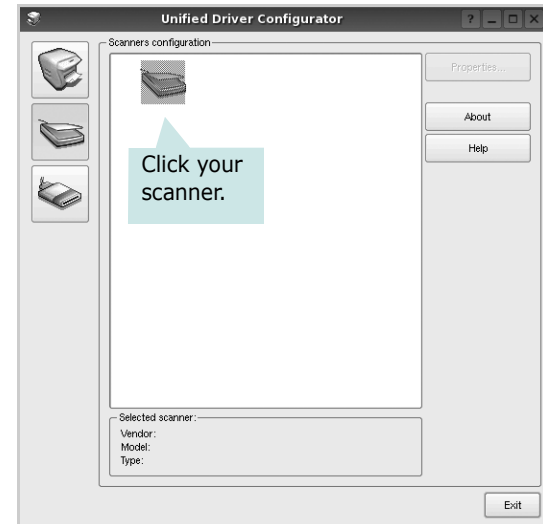

When you have only one MFP device and it is connected to the computer and turned on, your scanner appears on the list and is automatically selected.

If you have two or more scanners attached to your computer, you can select any scanner to work at any time. For example, while acquisition is in progress on the first scanner, you may select the second scanner, set the device options and start the image acquisition simultaneously.

- 4 Click **Properties**.
- 5 Load the document to be scanned face down on the document glass.
- 6 Click **Preview** in the Scanner Properties window.

The document is scanned and the image preview appears in the Preview Pane.

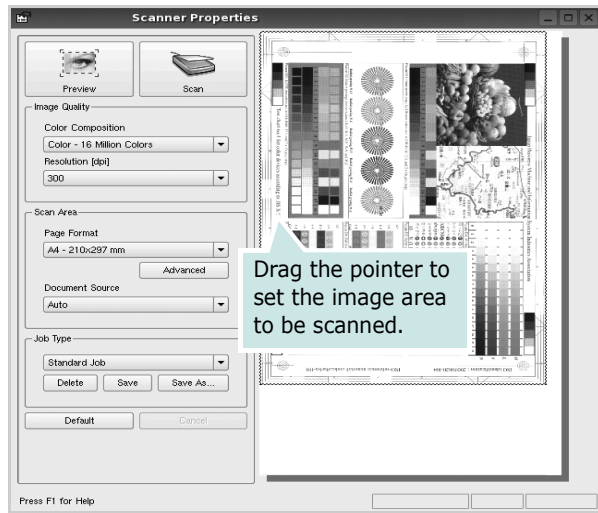

- 7 Change the scan options in the Image Quality and Scan Area sections.

- Image Quality:** allows you to select the color composition and the scan resolution for the image.

- Scan Area:** allows you to select the page size. The **Advanced** button enables you to set the page size manually.

If you want to use one of the preset scan option settings, select from the Job Type drop-down list. For details about the preset Job Type settings, see page 27.

You can restore the default setting for the scan options by clicking **Default**.

- 8 When you have finished, click **Scan** to start scanning.

The status bar appears on the bottom left of the window to show you the progress of the scan. To cancel scanning, click **Cancel**.

- 9 The scanned image appears in the new Image Manager tab.

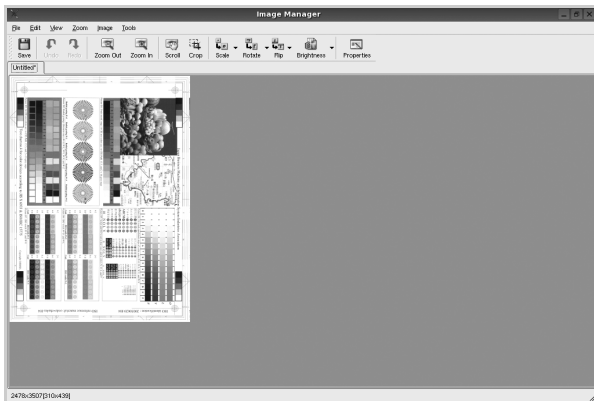

If you want to edit the scanned image, use the toolbar. For further details about editing an image, see page 27.

- 10 When you are finished, click **Save** on the toolbar.
- 11 Select the file directory where you want to save the image and enter the file name.
- 12 Click **Save**.

## Adding Job Type Settings

You can save your scan option settings to retrieve for a later scanning.

To save a new Job Type setting:

- 1 Change the options from the Scanner Properties window.
- 2 Click **Save As**.
- 3 Enter the name for your setting.
- 4 Click **OK**.

Your setting is added to the Saved Settings drop-down list.

To save a Job Type setting for the next scan job:

- 1 Select the setting you want to use from the Job Type drop-down list.
- 2 The next time you open the Scanner Properties window, the saved setting is automatically selected for the scan job.

To delete a Job Type setting:

- 1 Select the setting you want to delete from the Job Type drop-down list.
- 2 Click **Delete**.

The setting is deleted from the list





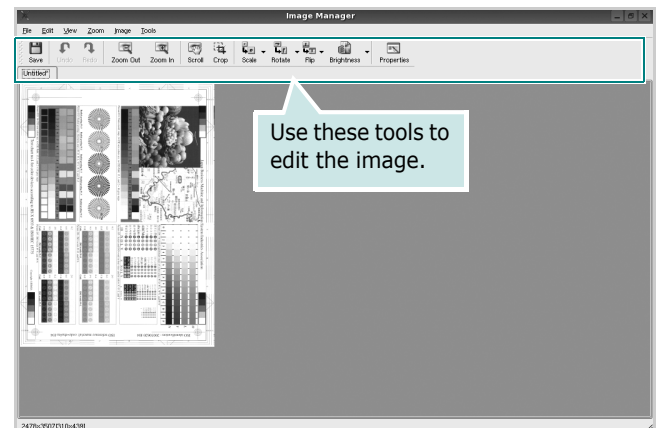







## Using the Image Manager

The Image Manager application provides you with menu commands and tools to edit your scanned image.





You can use the following tools to edit the image:

Tools	Function
 Save	Saves the image.
 Undo	Cancels your last action.
 Redo	Restores the action you canceled.
 Scroll	Allows you to scroll through the image.
 Crop	Crops the selected image area.
 Zoom Out	Zooms the image out.
 Zoom In	Zooms the image in.
 Scale	Allows you to scale the image size; you can enter the size manually, or set the rate to scale proportionally, vertically, or horizontally.
 Rotate	Allows you to rotate the image; you can select the number of degrees from the drop-down list.
 Flip	Allows you to flip the image vertically or horizontally.
 Effect	Allows you to adjust the brightness or contrast of the image, or to invert the image.
 Properties	Shows the properties of the image.

For further details about the Image Manager application, refer to the onscreen help.



# 8 Using Your Printer with a Macintosh

Your printer supports Macintosh systems with a built-in USB interface. When you print a file from a Macintosh computer, you can use the CUPS driver by installing the PPD file.

This chapter includes:

- **Installing Software for Macintosh**
- **Setting Up the Printer**
- **Printing**
- **Scanning**

## Installing Software for Macintosh

The CD-ROM that came with your printer provides you with the PPD file that allows you to use the CUPS driver or Apple LaserWriter driver (*only available when you use a printer which supports the PostScript driver*), for printing on a Macintosh computer.

Also, it provides you with the Twain driver for scanning on a Macintosh computer.

### Install the Printer driver

- 1** Make sure that you connect your printer to the computer. Turn on your computer and printer.
- 2** Insert the CD-ROM which came with your printer into the CD-ROM drive.
- 3** Double-click **CD-ROM icon** that appears on your Macintosh desktop.
- 4** Double-click the **MAC\_Installer** folder.
- 5** Double-click the **MAC\_Printer** folder.
- 6** Double-click the **Xerox SPLC Installer** icon.
- 7** Enter the password and click **OK**.
- 8** The Xerox SPL Installer window opens. Click **Continue** and then click **Continue**.
- 9** Select **Easy Install** and click **Install**.
- 10** After the installation is finished, click **Quit**.

### Uninstalling the Printer driver

Uninstall is required if you are upgrading the software, or if installation fails.

- 1** Insert the CD-ROM which came with your printer into the CD-ROM drive.
- 2** Double-click **CD-ROM icon** that appears on your Macintosh desktop.
- 3** Double-click the **MAC\_Installer** folder.
- 4** Double-click the **MAC\_Printer** folder.
- 5** Double-click the **Xerox SPLC Installer** icon.
- 6** Enter the password and click **OK**.
- 7** The Xerox SPL Installer window opens. Click **Continue** and then click **Continue**.
- 8** Select **Uninstall** and then click **Uninstall**.
- 9** When the uninstallation is done, click **Quit**.

## Install the Scan driver

- 1 Make sure that you connect your printer to the computer. Turn on your computer and printer.
- 2 Insert the CD-ROM which came with your printer into the CD-ROM drive.
- 3 Double-click **CD-ROM icon** that appears on your Macintosh desktop.
- 4 Double-click the **MAC\_Installer** folder.
- 5 Double-click the **MAC\_Twain** folder.
- 6 Double-click the **Xerox Scan Installer** icon.
- 7 Enter the password and click **OK**.
- 8 Click **Continue**.
- 9 Click **Install**.
- 10 Click **Continue**.
- 11 After the installation is finished, click **Quit**.

## Uninstalling the Scan driver

- 1 Insert the CD-ROM which came with your printer into the CD-ROM drive.
- 2 Double-click **CD-ROM icon** that appears on your Macintosh desktop.
- 3 Double-click the **MAC\_Installer** folder.
- 4 Double-click the **MAC\_Twain** folder.
- 5 Double-click the **Xerox Scan Installer** icon.
- 6 Enter the password and click **OK**.
- 7 Click **Continue**.
- 8 Select **Uninstall** from the Installation Type and then Click **Uninstall**.
- 9 Click **Continue**.
- 10 When the uninstallation is done, click **Quit**.

---

## Setting Up the Printer

### For a USB-connected Macintosh

- 1 Follow the instructions on “Installing Software for Macintosh” on page 29 to install the PPD and Filter files on your computer.
- 2 Open **Print Setup Utility** from the **Utilities** folder.
- 3 Click **Add** on the **Printer List**.
- 4 Select the **USB** tab.
- 5 Select **Xerox** in **Printer Model** and your printer in **Model Name**.
- 6 Click **Add**.

Your printer appears on the **Printer List**, and is set as the default printer.

# Printing

## NOTES:

- The Macintosh printer's properties window that appears in this User's Guide may differ depending on the printer in use. However the composition of the printer properties window is similar.
- *You can check your printer name in the supplied CD-ROM.*

## Printing a Document

When you print with a Macintosh, you need to check the printer software setting in each application you use. Follow these steps to print from a Macintosh.

- 1 Open a Macintosh application and select the file you want to print.
- 2 Open the **File** menu and click **Page Setup (Document Setup)** in some applications).
- 3 Choose your paper size, orientation, scaling, and other options and click **OK**.

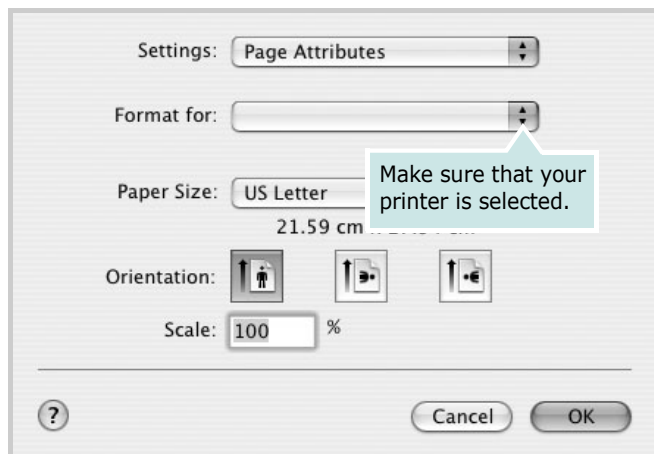

▲ Mac OS 10.3

- 4 Open the **File** menu and click **Print**.
- 5 Choose the number of copies you want and indicate which pages you want to print.
- 6 Click **Print** when you finish setting the options.

## Changing Printer Settings

You can use advanced printing features when using your printer.

From your Macintosh application, select **Print** from the **File** menu. The printer name which appears in the printer properties window may differ depending on the printer in use. Except for the name, the composition of the printer properties window is similar.

## Layout Setting

The **Layout** tab provides options to adjust how the document appears on the printed page. You can print multiple pages on one sheet of paper.

Select **Layout** from the **Presets** drop-down list to access the following features. For details, see "Printing Multiple Pages on One Sheet of Paper" on the next column.

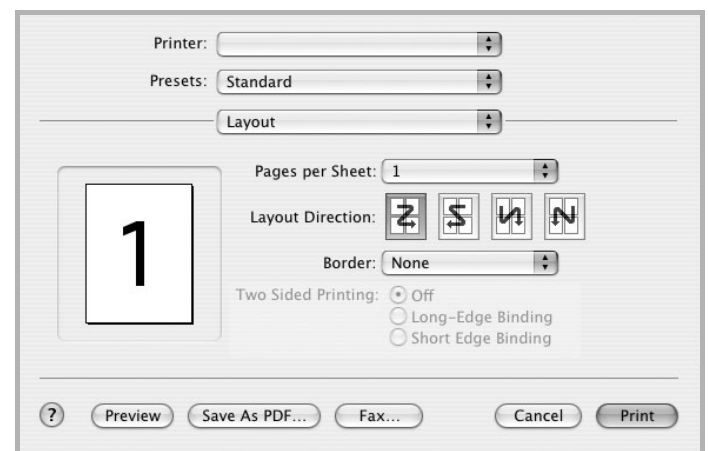

▲ Mac OS 10.3

## Printer Features Setting

The **Printer Features** tab provides options for selecting the paper type and adjusting print quality.

Select **Printer Features** from the **Presets** drop-down list to access the following features:



▲ Mac OS 10.3

## Paper Type

Set **Type** to correspond to the paper loaded in the tray from which you want to print. This will let you get the best quality printout. If you load a different type of print material, select the corresponding paper type.

## Resolution(Quality)

*The Resolution options you can select may vary depending on your printer model.* You can select the printing resolution. The higher the setting, the sharper the clarity of printed characters and graphics. The higher setting also may increase the time it takes to print a document.

## Color Mode

You can set the color options. Setting to **Color** typically produces the best possible print quality for color documents. If you want to print a color document in grayscale, select **Grayscale**.

## Printing Multiple Pages on One Sheet of Paper

You can print more than one page on a single sheet of paper. This feature provides a cost-effective way to print draft pages.

- 1 From your Macintosh application, select **Print** from the **File** menu.
- 2 Select **Layout**.

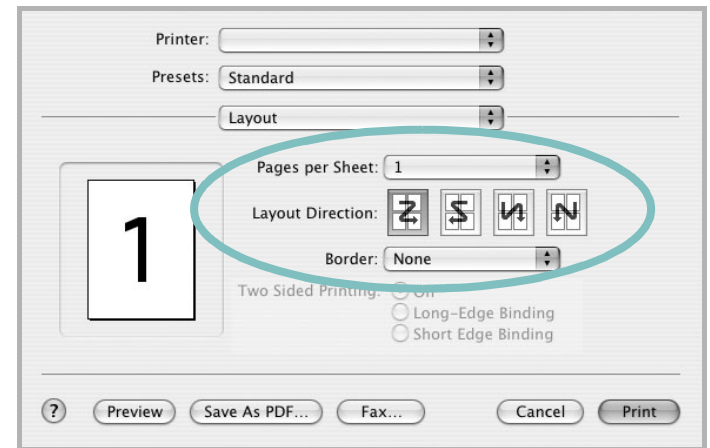

▲ Mac OS 10.3

- 3 Select the number of pages you want to print on one sheet of paper on the **Pages per Sheet** drop-down list.
- 4 Select the page order from the **Layout Direction** option. To print a border around each page on the sheet, select the option you want from the **Border** drop-down list.
- 5 Click **Print**, and the printer prints the selected number of pages on one side of each page.

---

## Scanning

If you want to scan documents using other software, you will need to use TWAIN-compliant software, such as Adobe PhotoDeluxe or Adobe Photoshop. The first time you scan with your machine, select it as your TWAIN source in the application you use.

The basic scanning process involves a number of steps:

1. Place a single document face down on the document glass.
2. Open an application, such as PhotoDeluxe or Photoshop.
3. Open the TWAIN window and set the scan options.
4. Scan and save your scanned image.

---

**NOTE:** You need to follow the program's instructions for acquiring an image. Please refer to the User's Guide of the application.

---

# SOFTWARE SECTION

# INDEX

## A

advanced printing, use 13

## B

booklet printing 14

## C

canceling  
    scan 20  
Color 10

## D

document, print  
    Macintosh 31  
    Windows 7  
double-sided printing 15

## F

favorites settings, use 12

## G

Graphics 10  
Graphics properties, set 10

## H

help, use 12

## I

install  
    printer driver  
        Macintosh 29  
        Windows 4  
installing  
    Linux software 21

## L

Layout properties, set  
    Macintosh 31  
    Windows 8  
Linux  
    driver, install 21  
    paper size, set  
        print 26  
    paper source, set 26  
    paper type, set  
        print 26  
    print resolution 26  
    printer properties 25  
    printing 25  
    scanning 26

## M

Macintosh  
    driver  
        install 29  
        uninstall 29  
    printing 31  
    scanning 33  
    setting up the printer 30  
MFP driver, install  
    Linux 21

## N

n-up printing  
    Macintosh 32  
    Windows 13

## O

orientation, print  
    Windows 8  
overlay  
    create 17  
    delete 17  
    print 17

## P

Paper properties, set 9  
paper size, set 9  
paper source, set  
    Windows 9  
paper type, set  
    Macintosh 32  
poster, print 14  
print  
    document 7  
    fit to page 15  
    from Macintosh 31  
    from Windows 7  
    N-up  
        Macintosh 32  
        Windows 13  
    overlay 17  
    PRN 7  
    scaling 15  
    watermark 16  
printer driver, install  
    Linux 21  
printer properties  
    Linux 25  
printer properties, set  
    Macintosh 31  
    Windows 8  
printer resolution, set  
    Macintosh 32  
    Windows 10  
printer software  
    install  
        Macintosh 29  
        Windows 4  
    uninstall  
        Macintosh 29  
        Windows 6  
printing  
    booklets 14  
    double-sided 15  
    from Linux 25

## R

resolution

printing 26

## S

- scanning
  - Linux 26
  - TWAIN 20
- scanning from Macintosh 33
- setting
  - darkness 10
  - favorites 12
  - image mode 10
  - resolution
    - Macintosh 32
    - Windows 10
  - true-type option 10
- software
  - install
    - Macintosh 29
    - Windows 4
  - system requirements
    - Macintosh 29
  - uninstall
    - Macintosh 29
    - Windows 6
- status monitor, use 19

## T

- TWAIN, scan 20

## U

- uninstall, software
  - Macintosh 29
  - Windows 6
- uninstalling
  - MFP driver
    - Linux 22
- Using 16

## W

- watermark
  - create 16
  - delete 16
  - edit 16
  - print 16

