



User's Manual

3D Video Controller Nova3D HD

Rev 1.0.0 NO: NS160100010

Statement

Dear users:

Welcome to use nova's products. We are pleased to offer this manual to help you understand and use the product. In the preparation of the manual, we try to make it accurate and reliable. Nova may revise and alter the contents of the manual at any time without notice. If you have any problems in the use, or you have any suggestions, please inform us in accordance with the contact provided in this manual. For the problems you encounter in the use, we will do our best to provide support. For your suggestions, we would like to express our thanks and make assessment as soon as possible for adoption.

Copyright

Copyright of this manual is reserved to Xi'an NovaStar Tech Co., Ltd. Any individual or organization is not allowed to copy or extract all or any part of the contents in any form without written approval.

Trademark

 is the registered trademark of Nova.

FCC Caution:

Any Changes or modifications not expressly approved by the party responsible for compliance could void the user's authority to operate the equipment.

This device complies with part 15 of the FCC Rules. Operation is subject to the following two conditions: (1) This device may not cause harmful interference, and (2) this device must accept any interference received, including interference that may cause undesired operation.

This equipment complies with FCC radiation exposure limits set forth for an uncontrolled environment .This equipment should be installed and operated with minimum distance 20cm between the radiator& your body. This transmitter must not be co-located or operating in conjunction with any other antenna or transmitter.

Content

FCC CAUTION: 3

1. SAFETY STATEMENT 6

2. ACCESSORIES 6

3. OVERVIEW 6

4. APPEARANCE 7

 4.1 FRONT PANEL 7

 4.2 REAR PANEL 8

5. SIGNAL CONNECTION 9

6. OPERATIONAL MOTION INSTRUCTION 10

7. MAIN INTERFACE 10

8. OPERATION 11

 8.1 STEP 1: EDID SETTING 11

 8.2 STEP 2: SCREEN SETTING 12

 8.3 STEP 3: BRIGHTNESS 14

 8.4 ADVANCED SETTING 14

 8.4.1 *Offset Position* 14

 8.4.2 *Image Quality* 14

 8.4.3 *Master/Redundancy* 15

 8.4.4 *Loading the configuration file of cabinet* 15

 8.4.5 *3D Setting* 17

 8.4.6 *Fn Setting* 17

 8.4.7 *Return to home screen* 18

 8.4.8 *Hardware version* 18

 8.4.9 *Save RV Card Parameters* 18

 8.4.10 *Factory default* 18

- 8.5 DISPLAY CONTROL19
- 8.6 COMMUNICATION SETTING19
- 8.7 LANGUAGE SETTING20

- 9. FIRMWARE UPDATE20

- 10. FREQUENTLY ASKED QUESTIONS AND CONSIDERATIONS22







- 11. TECHNOLOGY SPECIFICATION23

- 12. INSTALLATION DIMENSION24

KI'AN NOVASTAR TECH CO., L.

1. Safety statement

To avoid potential hazards, please use this equipment according to the regulations. In case of damages, non-professionals should not open for maintenance without permission; please contact the after-sales department of the company.

	High risk: The operating voltage of this product is 100-240V AC.
	Grounding: This production is connected to ground via the ground wire of power supply; please ensure the good grounding of grounding conductor.
	Electromagnetic interference: The device should be far away from magnets, motors and transformers.
	Moisture proof: Keep the equipment in a dry and clean environment. In case of liquid immersion, please pull the plug immediately.
	Away from flammable and dangerous goods.
	Prevent liquids or metal fragments from being immersed in the machine to avoid safety accidents.

2. Accessories

1	One power wire	3	One User's Manual
2	One DVI wire	4	One certificate

3. Overview

Nova 3D HD, developed by Nova, is an independent master supporting 3D video source. It can be used without computer and is equipped with screen at any time; the display brightness can be manually adjusted for convenience; 3D video can be output when 3D HD is connected to ordinary receiving card, which can generate an amazing visual effect. A single 3D HD controller supports the output of 1080P FHD 3D signal and cascade multiple 3D HD controllers can load 4K * 2K giant screen, which can bring a very stunning visual experience.

Product feature:

- 1) It adopts the output of standard 3D video;
- 2) It adopts an innovative architecture to implement smart configuration; the screen debugging can be completed within 30 seconds;
- 3) It adopts the Nova G4 engine; the screen is stable and flicker free without scanning lines; the images are exquisite and have a good sense of depth;
- 4) Support Single/Dual-link DVI , HDMI 1.4 specification;
- 5) HDMI audio input/external audio input;
- 6) The looping out of Dual-link DVI LOOP can realize synchronized monitoring;
- 7) Loading capacity: 2560x1600@60Hz, 3840x1080p@60Hz, 1080p@120Hz, 4Kx2K@30Hz;
- 8) The switch between 3D and 2D can be realized with one button;
- 9) It can be used without computer and is equipped with screen at any time;
- 10) The display brightness can be manually adjusted for convenience;
- 11) It supports new point by point correction technology of Nova; therefore, the correction is quick and efficient;
- 12) Deep color; multi-resolution; 16bit image processing; 1 billion kinds of color performance; all resolution within 4K*2K@30HZ is supported;
- 13) Formats all single-link DVI digital formats up to 165Mhz, Dual-link DVI formats up to 330Mhz;
- 14) It supports serial interface, USB and standard Ethernet communication; uniform control can be conducted for multi-computer cascade.

4. Appearance

4.1 Front panel

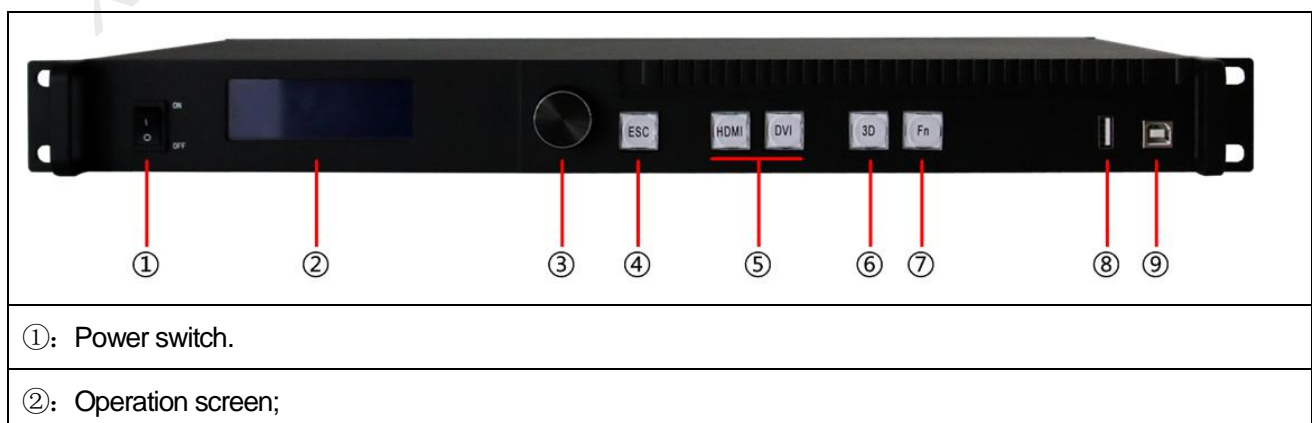

③: Knob: press knob for entry; rotate knob for selection or adjustment;
④: Return key: exit current operation or option;
⑤: Video Source switch; the key is bright after press when the video source has signal; the key flashes when the input of video source has no signal.
⑥: 3D/2D switch: if the key is bright, it indicates that 3D model has been enabled; otherwise, 2 D model has been enabled;
⑦: Custom shortcut key.
⑧~⑨: USB control interface: the square mouth (B-type USB main interface) is used for cascade input; the flat mouth (A-type USB main interface) is used for cascade output.

4.2 Rear panel



Tips: In order to improve the user' s experience, the layout of interface may be adjusted a little, The picture is only for reference.

Input source	
AUDIO	Audio input interface
HDMI	HDMI input interface
DVI IN	DVI input interface
Output interface	
DVI LOOP	DVI loop output
LED OUT1~8	8-channel LED outputs
Control interface	
RS232 IN、OUT	Serial Control (Cascade IN, OUT)
Ethernet	Network Control (Communication with PC, or Access Network)
USB IN、OUT	USB Control (Cascade IN, OUT)
Power	
AC-100-240V-50/60HZ	AC power interface

5. Signal connection

Connect the required hardware equipment reference with the interface descriptions of the previous chapters.

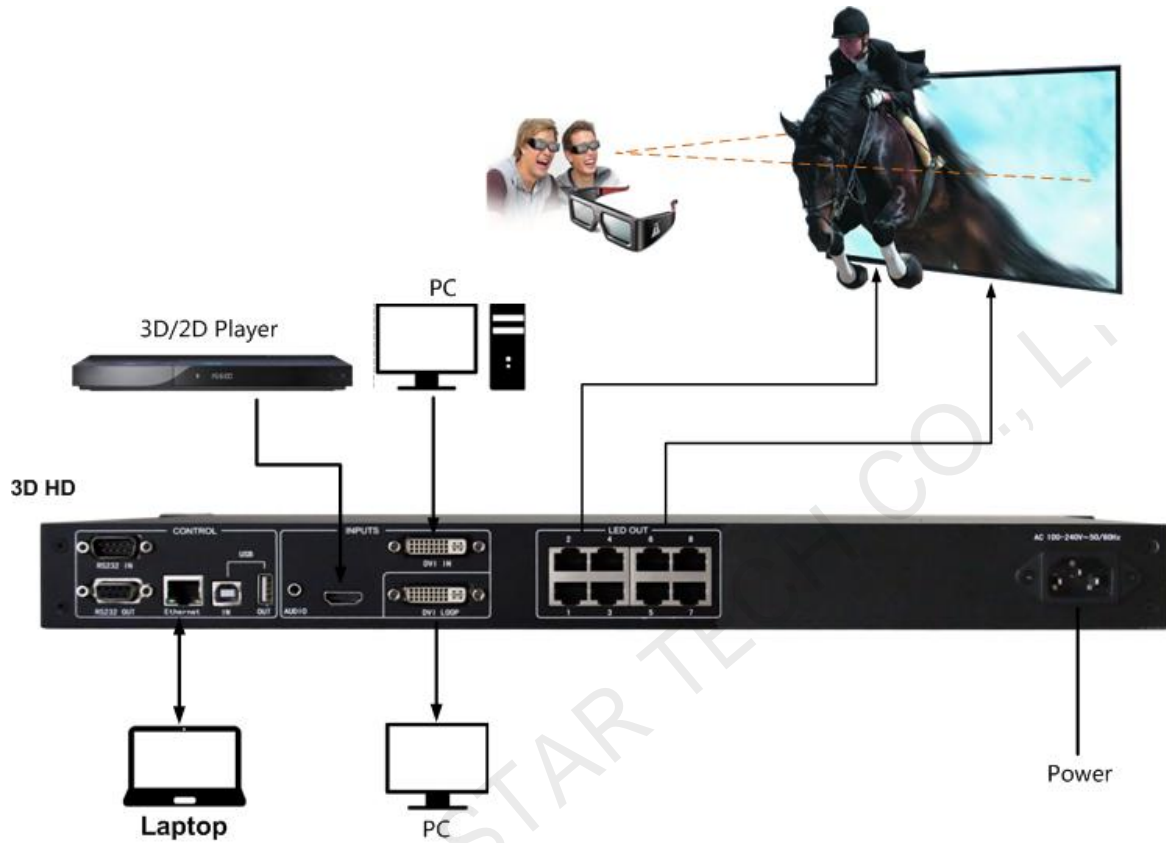

Fig. 5-1 3D HD Signal connection

Tips: It's must to turn-off Power before signal connection.

If it is required to control more than one sets of 3D HD, please connect them according to the following figure.

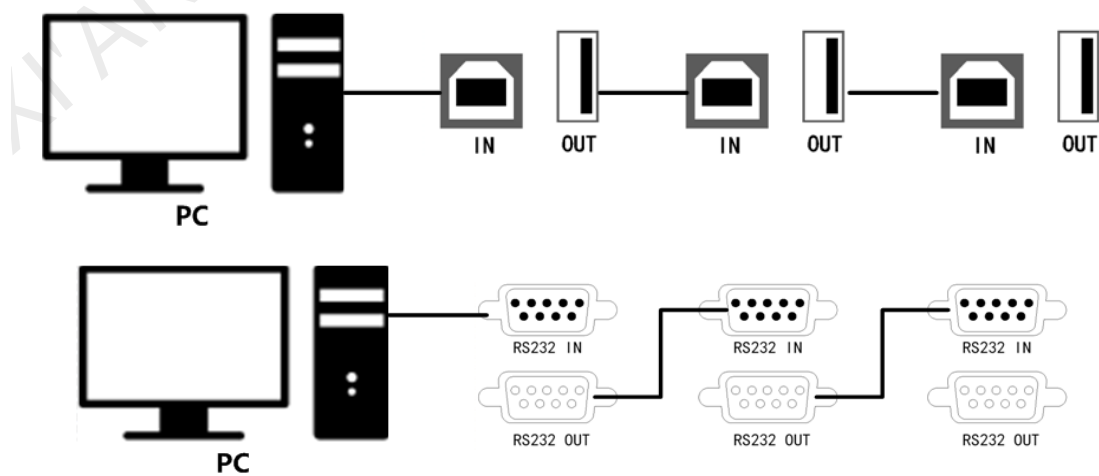

Fig. 3-2 Multiple 3D HD cascade

6. Operational motion instruction

Knob:

- ✧ Press the knob under main interface to enter the operation interface of menu;
- ✧ Rotate the knob to select menu or press the knob under the operation interface of menu to select current menu or enter submenu;
- ✧ Rotate the knob to adjust the parameter after selecting the menu with parameter; press the knob again for confirmation after adjustment.

ESC: Return key, exit current menu or operation.

DVI,HDMI: Video Source switch; the key is bright after press when the video source has signal; the key flashes when the input of video source has no signal.



3D: Mode switch of 3D/2D video source;

Fn: Custom shortcut key. Fn key is bright after entering into shortcut menu or function and will become off after exiting or closing the function;

Key lock/unlock: long press **knob** and **ESC** key simultaneously.

7. Main Interface



- A. It indicates that the selected input video source, Flashes when there is no signal and is highlighted when there is signal;
- B. It indicates current signal state of each video, highlight indicates that the video source has signal; otherwise, there is no signal;
- C. It indicates the size of LED display: 128×128;
- D. It indicates the mode of video source:  indicates that 3D function has been enabled;  It indicates that 3D function has not been enabled;
- E. It indicates that the right eye takes priority in 3D and can only be displayed after 3D function has been enabled;
- F. It indicates that current communication mode is serial control. As the priority of default serial control is the lowest, it is

unable to preempt network or USB communication;

- G. It indicates that the current brightness of display is 60%;
- H. It indicates that the controller is Master mode ;
- I. It indicates that port2 and port 3 are provided load.

8. Operation

Tips:

The functions of 3D HD are powerful with very simple operation, and multiple operations can be completed with a knob and a return key. The design of more than one shortcut keys makes operations more efficient.

Generally, the LED display can be used normally, and the brightness is moderate after conducting the following three steps: **EDID Settings** → **Screen setting** → **Brightness**. Other menus such as screen control and senior setting can help users better control LED display.

See the following section for details of operations.

8.1 Step 1: EDID Setting

The function can be used to set the output resolution of video card. In general, the image shown in screen cannot exceed the output resolution of video card.

Enter the menu **Advanced Setting** to set the EDID resolution of video source. It can be achieved in two ways: **Preset** and **Custom**.



Method 1: Preset

Selection is made in preset resolution of the controller. If there is no preset resolution, you can select the second method and customize resolution.

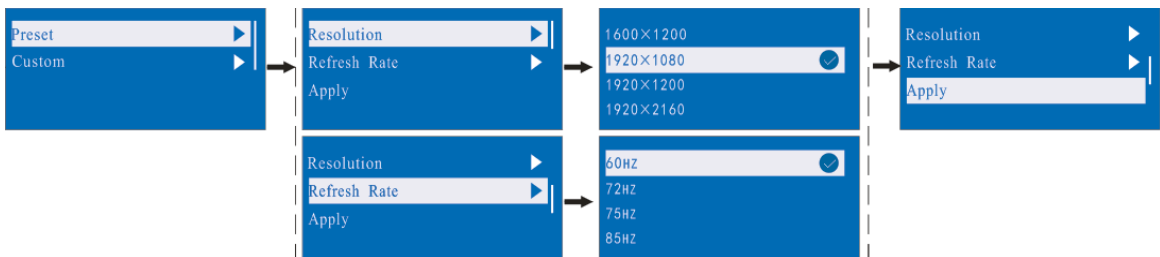

Method 2: Custom

Set Horizontal Res, Vertical Res and Custom refresh rate and then select "apply" and press the knob for application. If the application is not confirmed, custom resolution is invalid.

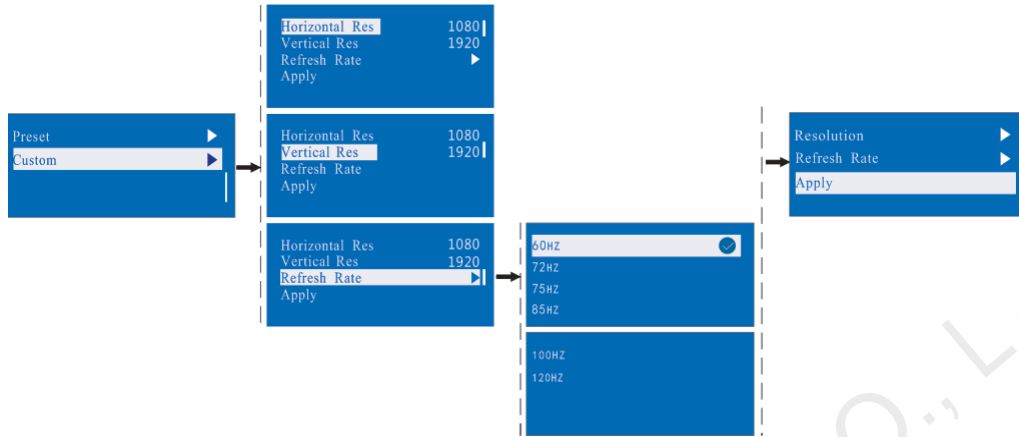

8.2 Step 2: Screen setting

The precondition of Screen setting in shortcut is that the screen must be regular rectangle (not special-shaped), cabinet must be regular rectangle and the size of each cabinet are identical.

Step 1 The screen being power-on, if the cabinet is in normal display, enter into step 2); if the cabinet is in abnormal display, first load the cabinet file, and save it to the receiving card; see detailed operation in [8.4 Advanced Setting](#).

Step 2 Return to the “**Screen Setting**” submenu. Rotate the button to switch to submenus of other options respectively to perform configurations, as shown in the following figures:

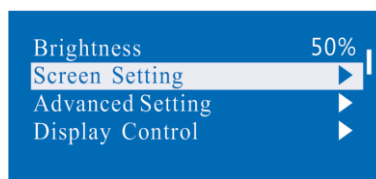

Step 3 Set **Cabinet Row QTY** and **Cabinet Col QTY** according to the actual situation of the screen.

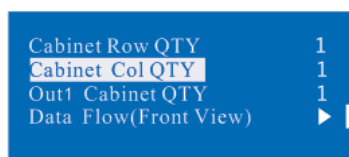
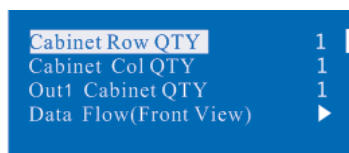

Step 4 Set Cabinet **Out1 QTY**. The device has some limitations on the cabinet quantity of ports. For details, see precautions for screen setting a).

Step 5 Set the Data Flow(Front View). Pay attention to precautions for screen setting c), d) and e) below.

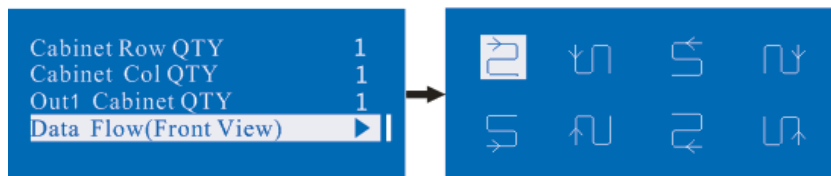

Precautions for screen setting:	
<p>a) If the number of network interfaces with loads is n ($n \leq 8$), the first $n-1$ network interfaces must have the same number of cabinets, which must also be an integral multiple of the number of cabinet rows or columns and be greater than or equal to the number of cabinets for the nth network interface.</p>	<p>Example: For example, if network interface 1~7 have loads, network interface 1~7 must have the same number of cabinets, which must also be an integral multiple of the number of cabinet rows or columns. Therefore, you need only to set cabinet out1 num according to the actual situation when setting the screen. The number of receiving cards for network interface 8 must be smaller than or equal to cabinet out1 num</p>
<p>b) In the case of special-shaped cabinets, different cabinet sizes and special-shaped screen, the NovaLCT-Mars software is required to be connected to configure the screen.</p>	
<p>c) During connection setting, you can rotate the button to see the effects of different connections on the screen in real time. If you are satisfied with the connection, you must press the button to save the setting. You can press the return key to exit from the current operation.</p>	
<p>d) During connection setting, you must ensure that the connection of each network interface is downward in the same direction.</p>	
<p>e) During connection setting, you must ensure that network interface 1 is the start position of the whole connection.</p>	
<p>f) 3D HD can load 5.2 million (60Hz) pixels in maximum. The width of lateral load can reach to 3840 pixels in maximum; the longitudinal load can reach to 3840 pixels in maximum.</p>	

8.3 Step 3: Brightness

Return to the main menu interface. Press the Knob to select the corresponding value of Brightness. You can rotate the Knob to adjust the value at this time.



8.4 Advanced setting

Several setting options of main functions are included in advanced setting, as shown in the figure below, Operation of each function will be detailed for users in the following text.

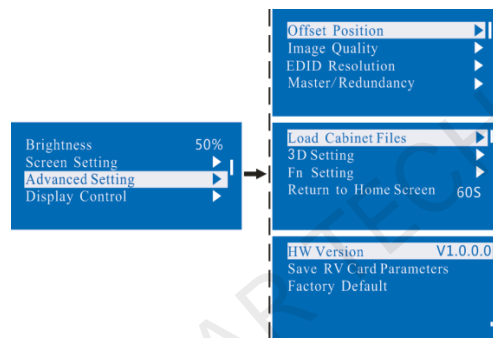

8.4.1 Offset Position

Adjust the starting point coordinate. Here the upper limit of offset is regulated, that is, the total of offset and screen size cannot exceed the output resolution of video card.

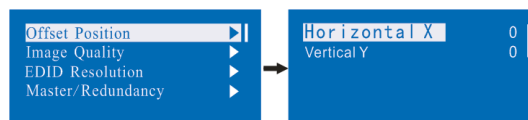

8.4.2 Image Quality

Set Gamma, color temperature, red brightness, green brightness, blue brightness value of image as required. Save these parameters to receiving card by applying **Save RV Card Parameters** after proper adjustment.

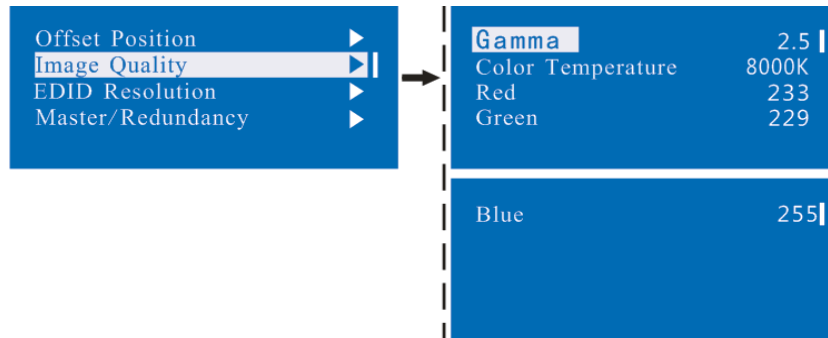

8.4.3 Master/Redundancy

Set the controller as master control mode or backup mode when there are multiple controllers in the system.

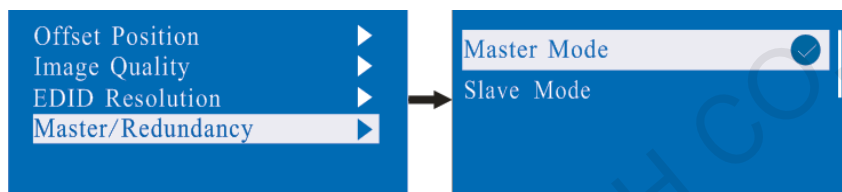

8.4.4 Loading the configuration file of cabinet

3D HD is connected with PC, NovaLCT-Mars runs on PC and cabinet setting file saved previously is imported into controller.

1) Save cabinet configuration file

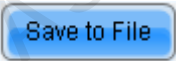
After receiving card is configured, click  and save cabinet configuration file (.rcfg) to local file on PC.

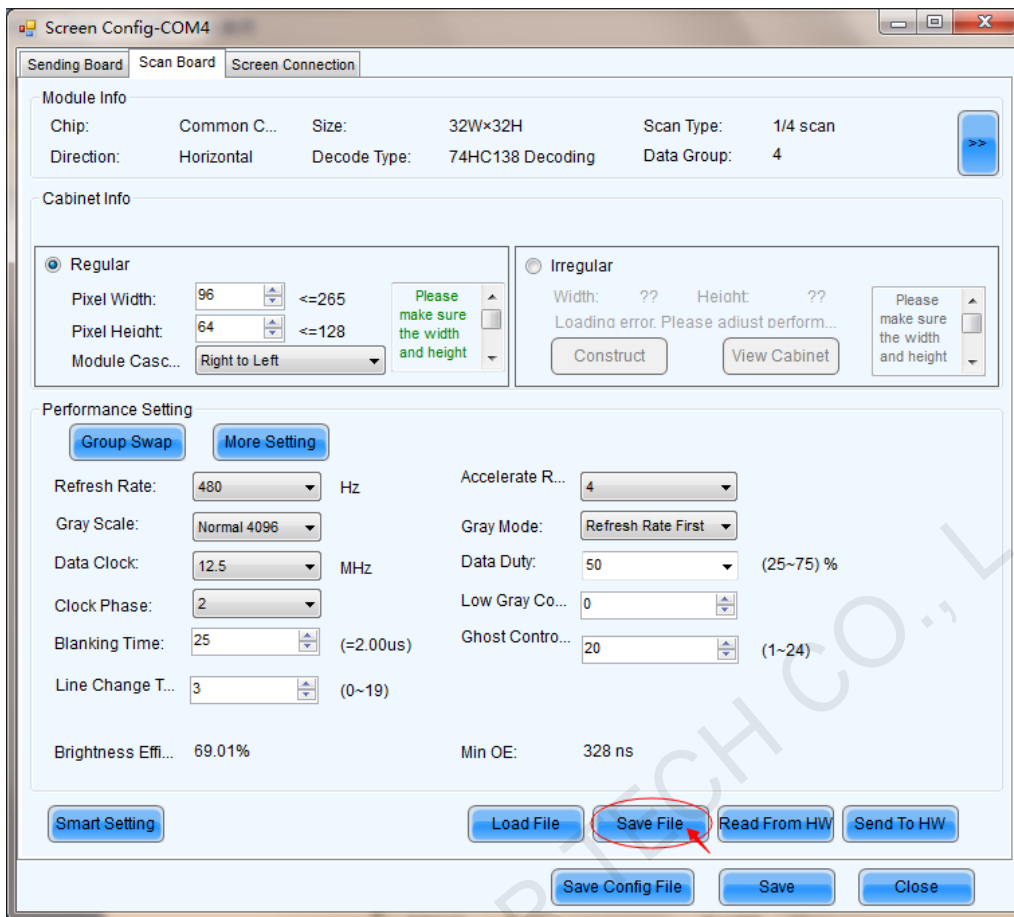

2) Import the configuration file of cabinet into 3D HD.

The operation steps are as follows:

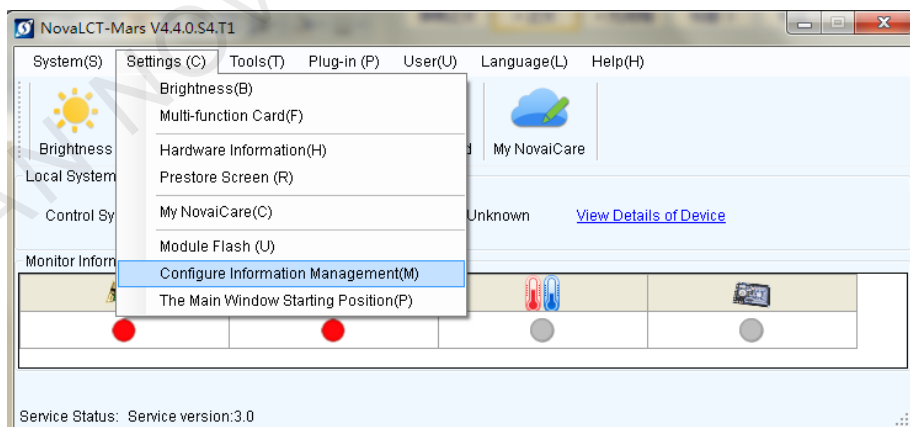

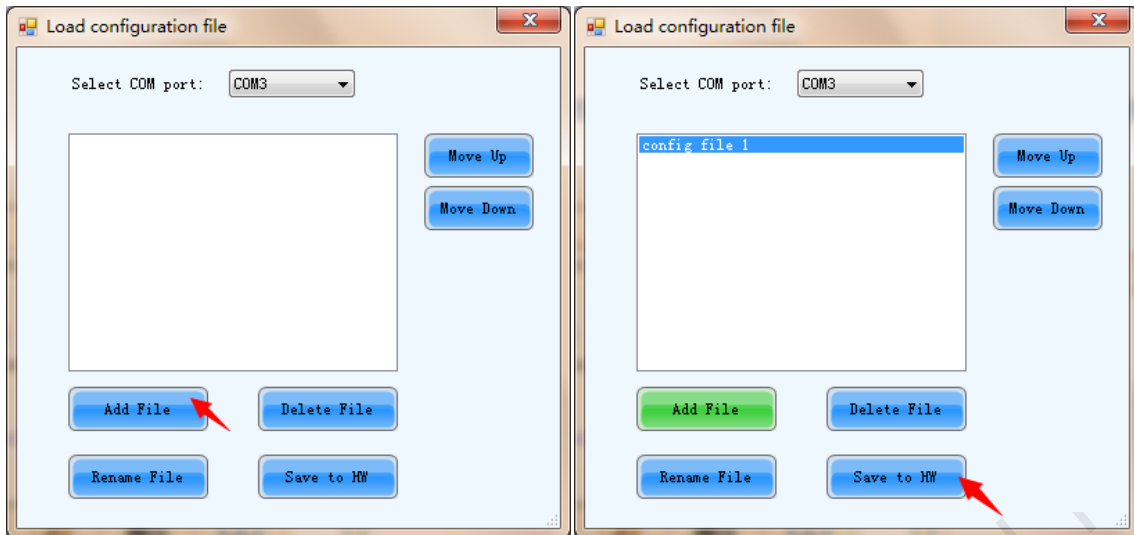

Tips: NovaLCT-Mars automatically reads the existing configuration files in the controller. The NovaLCT-Mars can perform operations such as modification of file name, adjustment order of file and delete these files.

3) Load the configuration file of cabinet

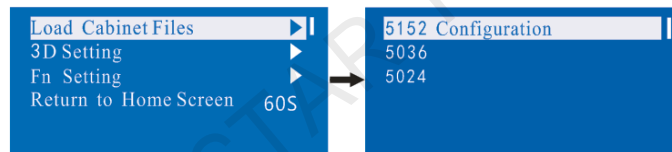

4) Save the configuration file of cabinet into receiving card. See detailed operation in [8.4.9 Save RV Card Parameters](#).

8.4.5 3D Setting

The menu includes 3D mode on/off and 3D left/right eye setting. 3D video source is disabled when the mode is switched to 2D video source. The setting status will be displayed in the home screen of LCD.

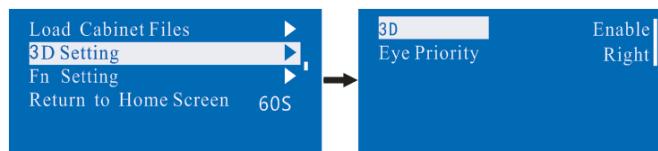

8.4.6 Fn Setting

The functions of custom button include **Black Out, Freeze and Test Pattern**. Press Fn key to directly conduct function switch.

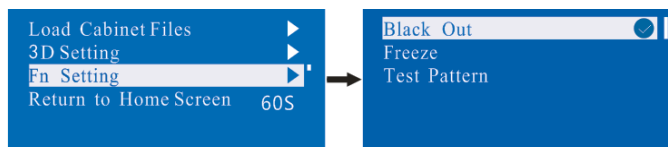

8.4.7 Return to home screen

The time period during which the system stops at current interface and then automatically returns to home screen when there is no operation. The system default value is 60s.

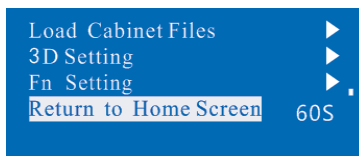

8.4.8 Hardware version

View the hardware version of 3D HD. If new version has been published, LCT-Mars can be connected via PC and the hardware program of 3D HD can be upgraded. View [9 Firmware Update](#) for detailed operations.

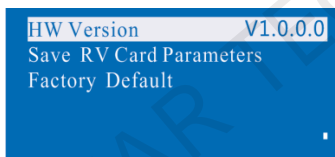

8.4.9 Save RV Card Parameters

All current configurations of 3D HD are saved into receiving card and will not be lost after power fault.



8.4.10 Factory default

3D HD is reset to factory default setting.



8.5 Display Control

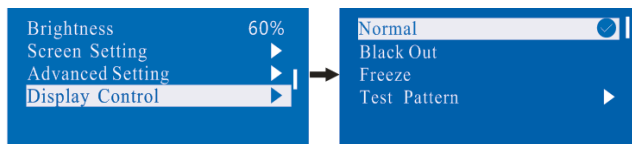

- **Normal** : Normally display.
- **Blank Out**: The display is blank
- **Freeze**: The current play lists are frozen. The blank screen occurs when the current source signal is lost.
- **Testing Pattern**: There are eight kinds of testing screens in total, including pure color and lines.

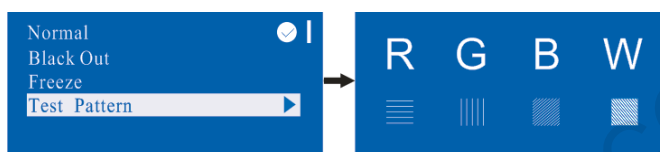

8.6 Communication setting

Set the communication mode and network parameter of 3D HD.

The communication modes include USB priority and interconnected LAN (local area network) priority. When 3D HD is connected to USB control and LAN control simultaneously, USB takes priority in the setting, that is, the system adopts USB control; otherwise, LAN takes priority in the setting, that is, the system adopts LAN control; as the priority of serial interface is fixed as minimum, it can only be normally used when USB and LAN are not connected at the same time.

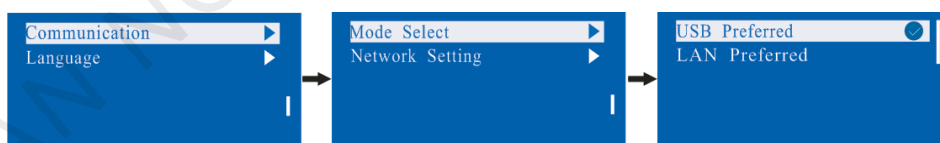

The network parameter can be set both manually and automatically. Ensure that IP address not conflict with other equipment when setting parameter manually.

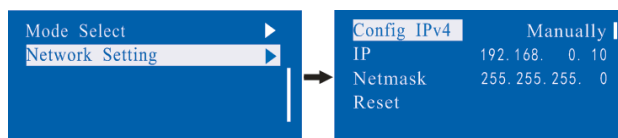

8.7 Language setting

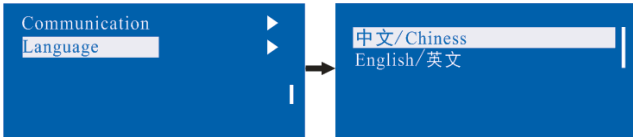

9. Firmware update

3D HD connect to a computer , and run NovaLCT-Mars on this computer, Login as an advanced user , the password is **admin**, then type in **admin** on keyboard to open the page for updating the hardware program.

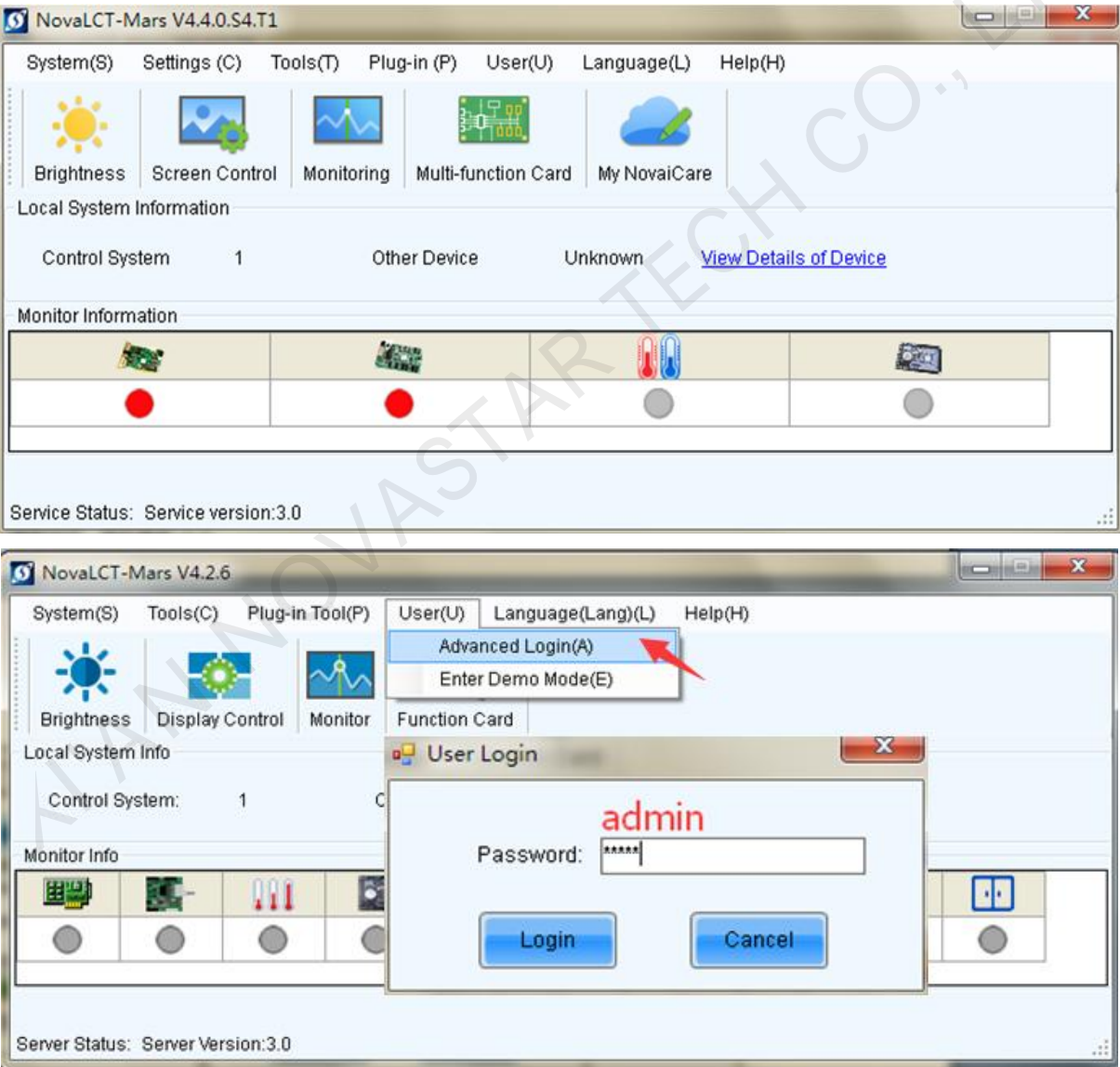

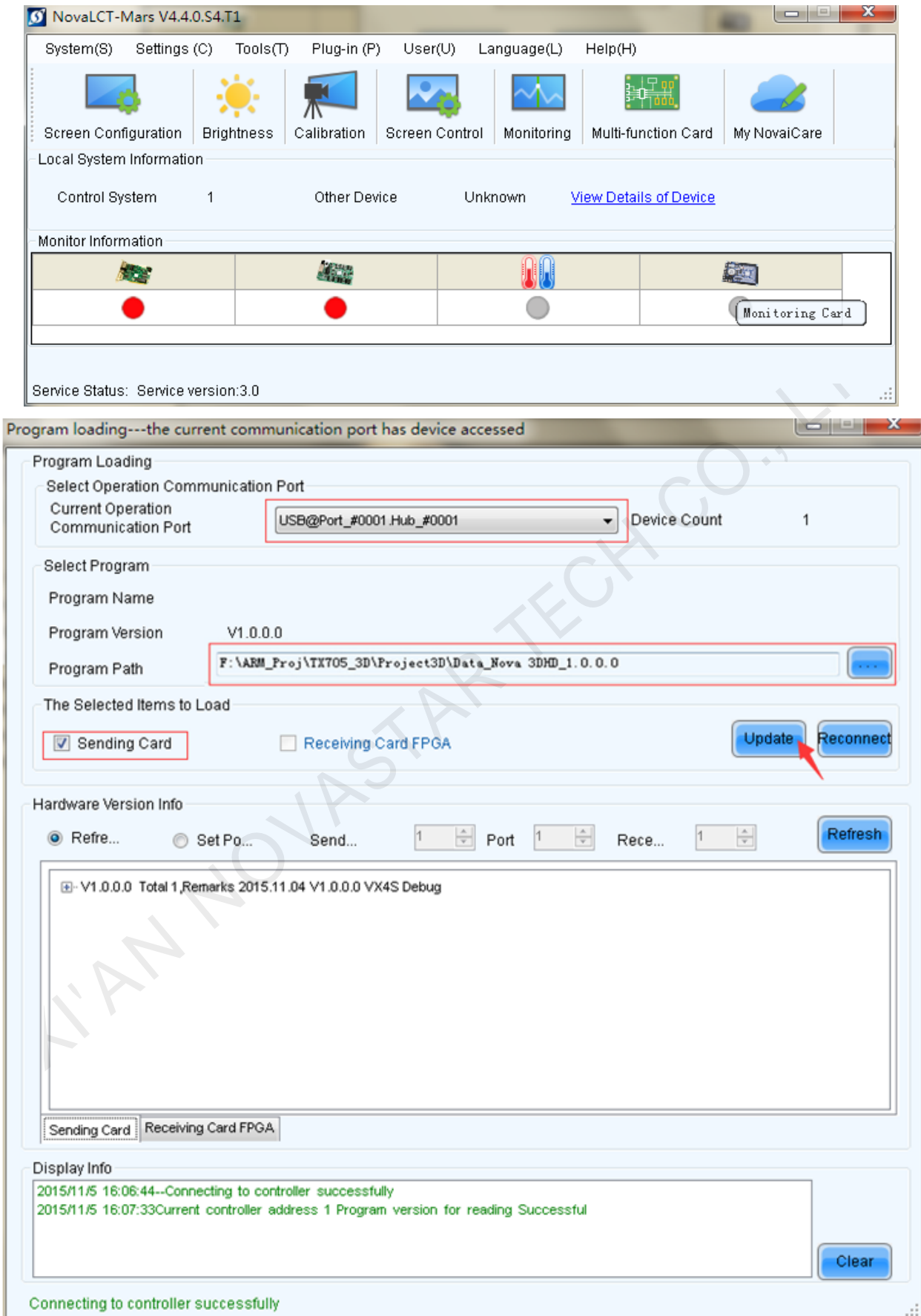

Current operation communication port: The serial port under which the hardware program needs update.

Program Path: Select the hardware program needs to be updated currently.

Sending Card: Check to update the MCU program of sending card.

Receiving Card FPGA: Check to update the FPGA program of sending card.

Update: Update the hardware program into hardware equipment.

Refresh All: Select the option and click refresh button to refresh the software, thus displaying all the programs of sending cards and receiving cards under current serial interface.

Set Refresh: Click the refresh button to display the version information of a specified receiving card.

Refresh: Refresh the display to show the version information of hardware so as to confirm whether the hardware program has been correctly updated.

10. Frequently asked questions and considerations

Questions	Processing mode
LED display is off	<p>Inspect whether the power connection is correct and the switch has been turned on;</p> <p>Type to test the image and confirm whether the connection of LED is correct and works normally;</p> <p>Inspect whether 3D HD output has signal and shows blank screen;</p> <p>Inspect whether the mode and parameter of screen configuration are correct;</p>
3D function is not normal	<p>Inspect whether 3D mode and 3D glasses have been opened</p> <p>Inspect whether the priority of left or right eye is correct</p> <p>The shift clock frequency of receiving card is too low, thus video cannot be loaded when 3D is enabled (turn up the shift clock frequency)</p>
Considerations	<p>1) The product can only support configuration without computer for rectangular screen composed of cabinets of same size and specification; special-shaped cabinet and screen need online configuration.</p> <p>2) Non-computer operation and online operation cannot be conducted for the same screen.</p>

11. Technology specification

Input index		
Interface	Number	Resolution specification
DVI	1	VESA standard (support 1080i input); support HDCP 1920x1080@60Hz, 2560x1600@60Hz, 3840x1080@60Hz, 1920x1080@120Hz
HDMI	1	EIA/CEA-861 standard; meet HDMI-1.3 standard; support HDCP 1920x1080@60Hz, 1920x1200@60Hz, 2560x1600@60Hz, 3840x1080@60Hz, 3840x2160@30Hz

Output index		
Interface	Number	Resolution specification
DVI input loop (DVILOOP)	1	Correspond with DVI input

Specification for complete machine	
Input Power	AC 100-240V, 50/60Hz
Overall Power Consumption	16W
Operating Temperature	-20~60°C
Size	482.5×271.3×44.7 (mm)
Weight	2.55 Kg

12. Installation dimension

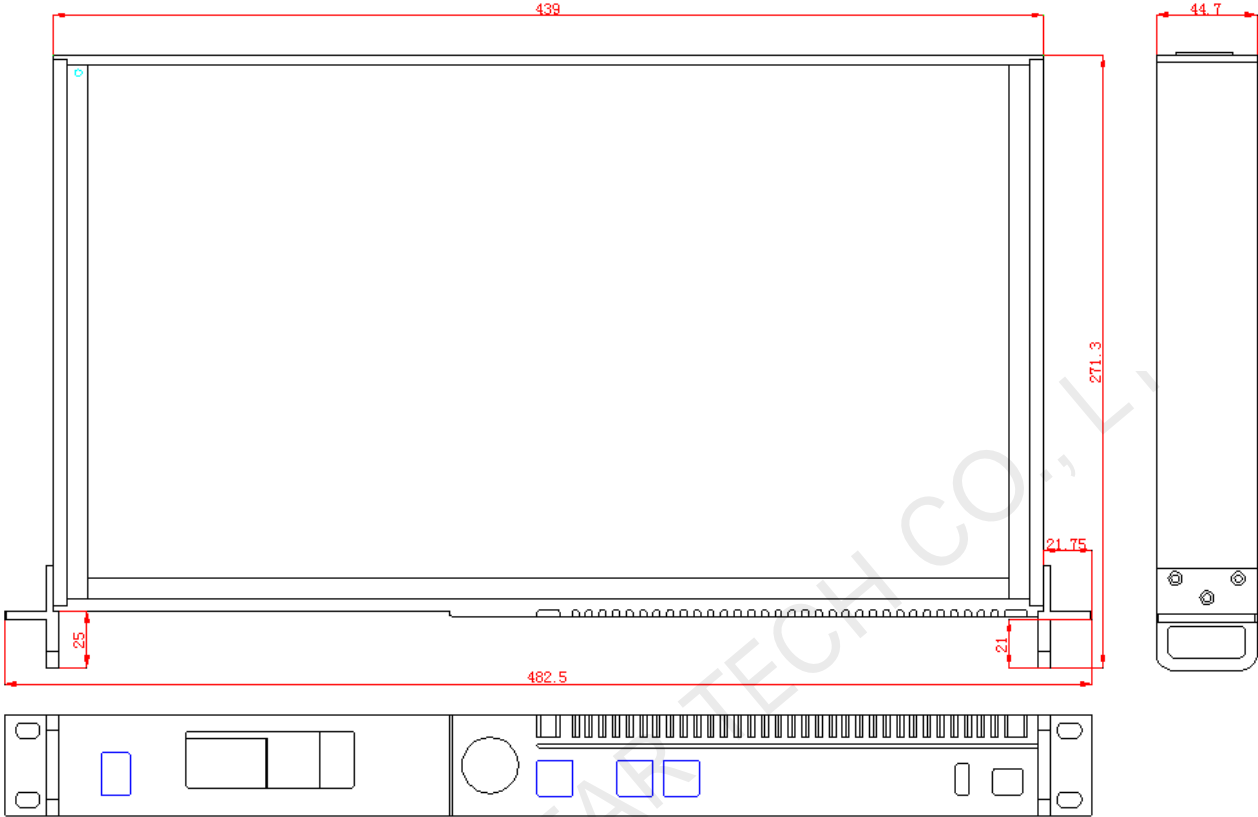

Fig. 12-1 3DHD dimension (unit: mm)